

FCC TEST REPORT

REPORT NO.: RF950904L04

MODEL NO.: WLG-2008 (refer to page 6 for other models)

RECEIVED: Sep. 04, 2006

TESTED: Sep. 07 ~ Sep. 15, 2006

ISSUED: Sep. 19, 2006

APPLICANT: CAMEO COMMUNICATIONS, INC.

ADDRESS: 5F, No.42, Sec. 6, Mincyuan E. Rd., Neihu District, Taipei City 114, Taiwan

ISSUED BY: Advance Data Technology Corporation

LAB ADDRESS: 47 14th Lin, Chiapau Tsun, Linko, Taipei, Taiwan, R.O.C.

TEST LOCATION: No. 19, Hwa Ya 2nd Rd., Kueishan, Taoyuan, Taiwan, R.O.C.

This test report consists of 70 pages in total. It may be duplicated completely for legal use with the approval of the applicant. It should not be reproduced except in full, without the written approval of our laboratory. The client should not use it to claim product endorsement by CNLA, A2LA or any government agencies. The test results in the report only apply to the tested sample.





Table of Contents

1	CERTIFICATION	4
2	SUMMARY OF TEST RESULTS	5
2.1	MEASUREMENT UNCERTAINTY	5
3	GENERAL INFORMATION	6
3.1	GENERAL DESCRIPTION OF EUT	6
3.2	DESCRIPTION OF TEST MODES.....	7
3.2.1	CONFIGURATION OF SYSTEM UNDER TEST	7
3.2.2	TEST MODE APPLICABILITY AND TESTED CHANNEL DETAIL	9
3.3	GENERAL DESCRIPTION OF APPLIED STANDARDS.....	11
3.4	DESCRIPTION OF SUPPORT UNITS	11
4	TEST TYPES AND RESULTS.....	12
4.1	CONDUCTED EMISSION MEASUREMENT.....	12
4.1.1	LIMITS OF CONDUCTED EMISSION MEASUREMENT.....	12
4.1.2	TEST INSTRUMENTS.....	12
4.1.3	TEST PROCEDURES	13
4.1.4	DEVIATION FROM TEST STANDARD	13
4.1.5	TEST SETUP	14
4.1.6	EUT OPERATING CONDITIONS.....	15
4.1.7	TEST RESULTS	16
4.2	RADIATED EMISSION MEASUREMENT	28
4.2.1	LIMITS OF RADIATED EMISSION MEASUREMENT	28
4.2.2	TEST INSTRUMENTS.....	29
4.2.3	TEST PROCEDURES	30
4.2.4	DEVIATION FROM TEST STANDARD	30
4.2.5	TEST SETUP	31
4.2.6	EUT OPERATING CONDITIONS.....	31
4.2.7	TEST RESULTS	32
4.3	6dB BANDWIDTH MEASUREMENT	40
4.3.1	LIMITS OF 6dB BANDWIDTH MEASUREMENT.....	40
4.3.2	TEST INSTRUMENTS.....	40
4.3.3	TEST PROCEDURE.....	41
4.3.4	DEVIATION FROM TEST STANDARD	41
4.3.5	TEST SETUP	41
4.3.6	EUT OPERATING CONDITIONS.....	41
4.3.7	TEST RESULTS	42
4.4	MAXIMUM PEAK OUTPUT POWER	48
4.4.1	LIMITS OF MAXIMUM PEAK OUTPUT POWER MEASUREMENT	48
4.4.2	TEST INSTRUMENTS.....	48
4.4.3	TEST PROCEDURES	49



4.4.4	DEVIATION FROM TEST STANDARD	49
4.4.5	TEST SETUP	49
4.4.6	EUT OPERATING CONDITIONS.....	49
4.4.7	TEST RESULTS	50
4.5	POWER SPECTRAL DENSITY MEASUREMENT	51
4.5.1	LIMITS OF POWER SPECTRAL DENSITY MEASUREMENT	51
4.5.2	TEST INSTRUMENTS.....	51
4.5.3	TEST PROCEDURE.....	52
4.5.4	DEVIATION FROM TEST STANDARD	52
4.5.5	TEST SETUP	52
4.5.6	EUT OPERATING CONDITIONS.....	52
4.5.7	TEST RESULTS.....	53
4.6	BAND EDGES MEASUREMENT.....	59
4.6.1	LIMITS OF BAND EDGES MEASUREMENT	59
4.6.2	TEST INSTRUMENTS.....	59
4.6.3	TEST PROCEDURE.....	59
4.6.4	DEVIATION FROM TEST STANDARD	59
4.6.5	EUT OPERATING CONDITION	59
4.6.6	TEST RESULTS	60
4.7	ANTENNA REQUIREMENT	68
4.7.1	STANDARD APPLICABLE.....	68
4.7.2	ANTENNA CONNECTED CONSTRUCTION	68
5	INFORMATION ON THE TESTING LABORATORIES	69
	APPENDIX-A.....	A-1



1 CERTIFICATION

PRODUCT : 54Mbps Wireless LAN Pocket Access Point
MODEL NO.: WLG-2008 (refer to page 6 for other models)
BRAND: CAMEO (refer to page 6 for other brand names)
APPLICANT : CAMEO COMMUNICATIONS, INC.
TESTED: Sep. 07 ~ Sep. 15, 2006
TEST SAMPLE: ENGINEERING SAMPLE
STANDARDS : **FCC Part 15, Subpart C (Section 15.247),**
ANSI C63.4-2003

The above equipment have been tested by **Advance Data Technology Corporation**, and found compliance with the requirement of the above standards. The test record, data evaluation & Equipment Under Test (EUT) configurations represented herein are true and accurate accounts of the measurements of the sample's EMC characteristics under the conditions specified in this report.

PREPARED BY Wendy Liao , **DATE :** Sep. 19, 2006
Wendy Liao

TECHNICAL
ACCEPTANCE : Stanley Hsu , **DATE :** Sep. 19, 2006
Responsible for RF Stanley Hsu

APPROVED BY : Gary Chang , **DATE :** Sep. 19, 2006
Gary Chang / Supervisor

2 SUMMARY OF TEST RESULTS

The EUT has been tested according to the following specifications:

APPLIED STANDARD: FCC Part 15, Subpart C			
Standard Section	Test Type and Limit	Result	REMARK
15.207	AC Power Conducted Emission	PASS	Meet the requirement of limit. Minimum passing margin is -5.90dB at 0.345MHz.
15.247(a)(2)	Spectrum Bandwidth of a Direct Sequence Spread Spectrum System Limit : min. 500kHz	PASS	Meet the requirement of limit.
15.247(b)	Maximum Peak Output Power Limit: max. 30dBm	PASS	Meet the requirement of limit.
15.247(d)	Transmitter Radiated Emissions Limit: Table 15.209	PASS	Meet the requirement of limit. Minimum passing margin is -1.27dB at 4924.00MHz.
15.247(e)	Power Spectral Density Limit: max. 8dBm	PASS	Meet the requirement of limit.
15.247(d)	Band Edge Measurement Limit: 20 dB less than the peak value of fundamental frequency	PASS	Meet the requirement of limit.

2.1 MEASUREMENT UNCERTAINTY

Where relevant, the following measurement uncertainty levels have been estimated for tests performed on the EUT as specified in CISPR 16-4:

Measurement	Frequency	Uncertainty
Conducted emissions	9kHz~30MHz	2.44 dB
	30MHz ~ 200MHz	3.64 dB
Radiated emissions	200MHz ~1000MHz	3.65 dB
	1GHz ~ 18GHz	2.26 dB
	18GHz ~ 40GHz	1.94 dB

This uncertainty represents an expanded uncertainty expressed at approximately the 95% confidence level using a coverage factor of k=2.

3 GENERAL INFORMATION

3.1 GENERAL DESCRIPTION OF EUT

PRODUCT	54Mbps Wireless LAN Pocket Access Point
MODEL NO.	WLG-2008 (refer to Note 1 as below for other models)
FCC ID	NHPWLG2008B
POWER SUPPLY	5Vdc from AC adapter or host equipment
MODULATION TYPE	CCK, DQPSK, DBPSK for DSSS 64QAM, 16QAM, QPSK, BPSK for OFDM
MODULATION TECHNOLOGY	DSSS, OFDM
TRANSFER RATE	802.11b: 11/5.5/2/1Mbps 802.11g: 54/48/36/24/18/12/9/6Mbps
FREQUENCY RANGE	2412MHz ~ 2462MHz
NUMBER OF CHANNEL	11
MAXIMUM OUTPUT POWER	45.082mW
ANTENNA TYPE	PIFA antenna with 2.56dBi gain Chip antenna (For receiver only)
I/O PORTS	RJ45
DATA CABLE	0.4m shielded USB cable without core

NOTE:

1. The models as below are identical to each other except for the model and brand names due to marketing requirement.

Brand Name	Model Name
CAMEO	WLG-2008
Vunex	WA-5000G
Sofim	SWLG-001
Air Live	WL-5480PAP
Encore	ENTRWI-G

2. The EUT was powered by the following adapter:

BRAND:	JENTEC TECHNOLOGY CO., LTD.
MODEL:	JTA0402D-A
INPUT:	100-240Vac, 50-60Hz, 0.25A
OUTPUT:	5Vdc, 1.2A
POWER LINE:	1.8m non-shielded cable without core

3. The EUT complies with IEEE 802.11g standards and backwards compatible with IEEE 802.11b products.
4. The above EUT information was declared by manufacturer and for more detailed features description, please refer to the manufacturer's specifications or User's Manual.

3.2 DESCRIPTION OF TEST MODES

Eleven channels are provided to this EUT.

Channel	Frequency	Channel	Frequency
1	2412 MHz	7	2442 MHz
2	2417 MHz	8	2447 MHz
3	2422 MHz	9	2452 MHz
4	2427 MHz	10	2457 MHz
5	2432 MHz	11	2462 MHz
6	2437 MHz		

3.2.1 CONFIGURATION OF SYSTEM UNDER TEST

Test Mode A

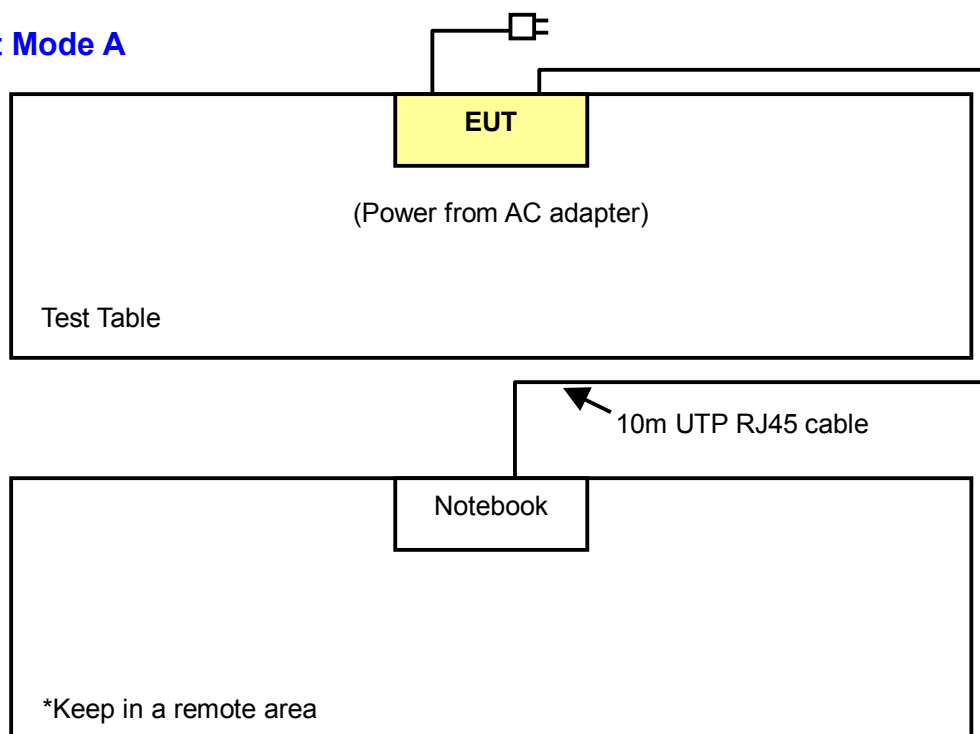

Test Mode B

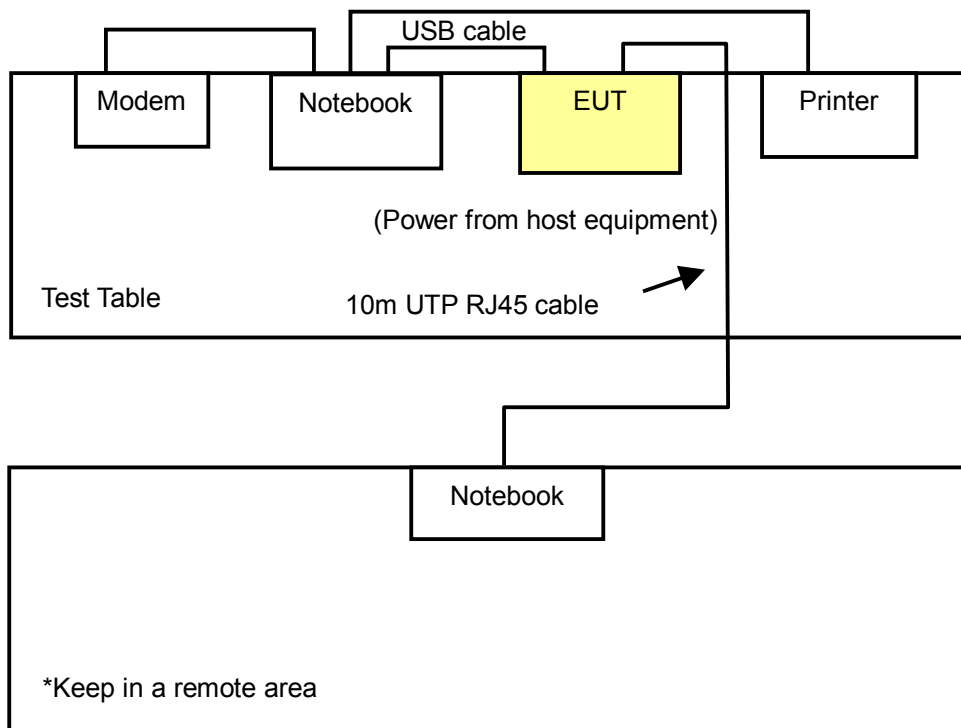

3.2.2 TEST MODE APPLICABILITY AND TESTED CHANNEL DETAIL

EUT configure mode	Applicable to				Description
	PLC	RE<1G	RE≥1G	APCM	
A	√	√	√	√	Power from AC adapter
B	√	√	-	-	Power from host equipment

Where **PLC**: Power Line Conducted Emission **RE<1G**: Radiated Emission below 1GHz
RE≥1G: Radiated Emission above 1GHz **APCM**: Antenna Port Conducted Measurement

Note: “_” means no effect.

Power Line Conducted Emission Test:

- Pre-Scan has been conducted to determine the worst-case mode from all possible combinations between available modulations, data rates and antenna ports (if EUT with antenna diversity architecture).
- Following channel(s) was (were) selected for the final test as listed below.

EUT configure mode	Mode	Available Channel	Tested Channel	Modulation Technology	Modulation Type	Data Rate (Mbps)
A	802.11g	1 to 11	1, 6, 11	OFDM	BPSK	6
B	802.11g	1 to 11	1, 6, 11	OFDM	BPSK	6

Radiated Emission Test (Below 1 GHz):

- Pre-Scan has been conducted to determine the worst-case mode from all possible combinations between available modulations, data rates and antenna ports (if EUT with antenna diversity architecture).
- Following channel(s) was (were) selected for the final test as listed below.

EUT configure mode	Mode	Available Channel	Tested Channel	Modulation Technology	Modulation Type	Data Rate (Mbps)
A	802.11g	1 to 11	11	OFDM	BPSK	6
B	802.11g	1 to 11	11	OFDM	BPSK	6

Radiated Emission Test (Above 1 GHz):

- Pre-Scan has been conducted to determine the worst-case mode from all possible combinations between available modulations, data rates and antenna ports (if EUT with antenna diversity architecture).
- Following channel(s) was (were) selected for the final test as listed below.

Mode	Available Channel	Tested Channel	Modulation Technology	Modulation Type	Data Rate (Mbps)
802.11b	1 to 11	1, 6, 11	DSSS	DBPSK	1
802.11g	1 to 11	1, 6, 11	OFDM	BPSK	6

Bandedge Measurement:

- Pre-Scan has been conducted to determine the worst-case mode from all possible combinations between available modulations, data rates and antenna ports (if EUT with antenna diversity architecture).
- Following channel(s) was (were) selected for the final test as listed below.

Mode	Available Channel	Tested Channel	Modulation Technology	Modulation Type	Data Rate (Mbps)
802.11b	1 to 11	1, 11	DSSS	DBPSK	1
802.11g	1 to 11	1, 11	OFDM	BPSK	6

Antenna Port Conducted Measurement:

- Pre-Scan has been conducted to determine the worst-case mode from all possible combinations between available modulations, data rates and antenna ports (if EUT with antenna diversity architecture).
- Following channel(s) was (were) selected for the final test as listed below.

Mode	Available Channel	Tested Channel	Modulation Technology	Modulation Type	Data Rate (Mbps)
802.11b	1 to 11	1, 6, 11	DSSS	DBPSK	1
802.11g	1 to 11	1, 6, 11	OFDM	BPSK	6

3.3 GENERAL DESCRIPTION OF APPLIED STANDARDS

The EUT is a RF product. According to the specifications of the manufacturer, it must comply with the requirements of the following standards:

FCC Part 15, Subpart C. (15.247)
ANSI C63.4-2003

All test items have been performed and recorded as per the above standards.

NOTE: The EUT is also considered as a kind of computer peripheral, because the connection to computer is necessary for typical use. It has been verified to comply with the requirements of FCC Part 15, Subpart B, Class B (DoC). The test report has been issued separately.

3.4 DESCRIPTION OF SUPPORT UNITS

The EUT has been tested as an independent unit together with other necessary accessories or support units. The following support units or accessories were used to form a representative test configuration during the tests.

NO.	PRODUCT	BRAND	MODEL NO.	SERIAL NO.	FCC ID
1	NOTEBOOK COMPUTER	DELL	PP05L	16484462992	E2K24CLNS
2	MODEM	ACEEX	1414V/3	0401008269	IFAXDM1414
3	PRINTER	EPSON	LQ-300+	DCGY054147	FCC DoC Approved
4	NOTEBOOK COMPUTER	DELL	PP05L	12130898320	E2K24CLNS

NO.	SIGNAL CABLE DESCRIPTION OF THE ABOVE SUPPORT UNITS
1	NA
2	1.2m shielded cable.
3	1.2m shielded cable.
4	NA

NOTE:

1. All power cords of the above support units are non shielded (1.8m).
2. Item 4 acted as communication partners to transfer data.

4 TEST TYPES AND RESULTS

4.1 CONDUCTED EMISSION MEASUREMENT

4.1.1 LIMITS OF CONDUCTED EMISSION MEASUREMENT

FREQUENCY OF EMISSION (MHz)	CONDUCTED LIMIT (dB μ V)	
	Quasi-peak	Average
0.15-0.5	66 to 56	56 to 46
0.5-5	56	46
5-30	60	50

- NOTE:**
1. The lower limit shall apply at the transition frequencies.
 2. The limit decreases in line with the logarithm of the frequency in the range of 0.15 to 0.50 MHz.
 3. All emanations from a class A/B digital device or system, including any network of conductors and apparatus connected thereto, shall not exceed the level of field strengths specified above.

4.1.2 TEST INSTRUMENTS

DESCRIPTION & MANUFACTURER	MODEL NO.	SERIAL NO.	CALIBRATED UNTIL
Test Receiver ROHDE & SCHWARZ	ESCS30	100288	Nov. 02, 2006
RF signal cable Woken	5D-FB	Cable-HYCO3-01	Jan. 06, 2007
LISN ROHDE & SCHWARZ	ESH2-Z5	100100	Jan. 09, 2007
LISN ROHDE & SCHWARZ	ESH3-Z5	100311	Jan. 22, 2007
Software ADT	ADT_Cond_V3	NA	NA

- NOTE:**
1. The calibration interval of the above test instruments is 12 months and the calibrations are traceable to NML/ROC and NIST/USA.
 2. The test was performed in HwaYa Shielded Room 2.
 3. The VCCI Site Registration No. is C-2047.

4.1.3 TEST PROCEDURES

- a. The EUT was placed 0.4 meters from the conducting wall of the shielded room with EUT being connected to the power mains through a line impedance stabilization network (LISN). Other support units were connected to the power mains through another LISN. The two LISNs provide 50 ohm/ 50uH of coupling impedance for the measuring instrument.
- b. Both lines of the power mains connected to the EUT were checked for maximum conducted interference.
- c. The frequency range from 150kHz to 30MHz was searched. Emission levels under Limit - 20dB was not recorded.

4.1.4 DEVIATION FROM TEST STANDARD

No deviation

4.1.5 TEST SETUP

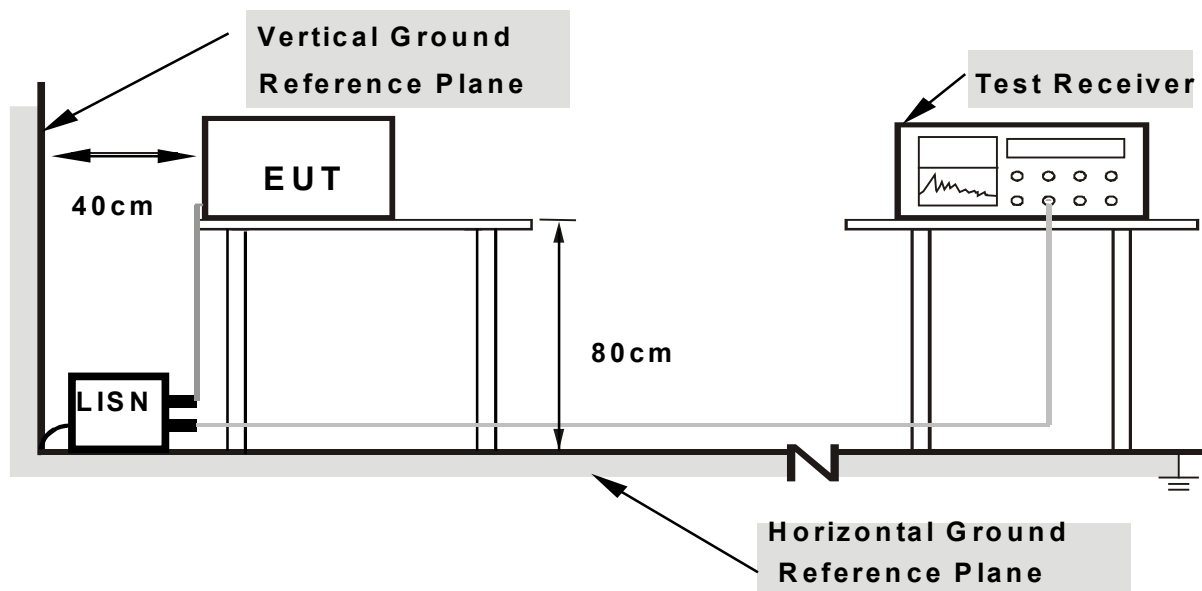

- Note: 1.Support units were connected to second LISN.**
2.Both of LISNs (AMN) are 80 cm from EUT and at least 80 from other units and other metal planes

For the actual test configuration, please refer to the related item – Photographs of the Test Configuration.

4.1.6 EUT OPERATING CONDITIONS

Test Mode A

- a. The EUT connected with notebook system via a RJ45 cable.
- b. The notebook system ran a test program (provided by manufacturer) to enable EUT under transmission condition continuously at specific channel frequency.

Test Mode B

- a. Connected EUT with notebook system via USB cable and placed on a testing table.
- b. Prepared other notebooks to act as communication partners and placed it outside of testing area.
- c. The notebook system ran a test program (provided by manufacturer) to enable EUT under transmission condition continuously at specific channel frequency.
- d. The notebook system sent "H" messages to its screen.
- e. The notebook system sent "H" messages to modem.
- f. The notebook system sent "H" messages to printer and the printer prints them on paper.
- g. Repeated item d ~f.

4.1.7 TEST RESULTS

CONDUCTED WORST-CASE DATA POWER FROM ADPATER

EUT TEST CONDITION		MEASUREMENT DETAIL	
CHANNEL	Channel 1	PHASE	Line 1
MODULATION TYPE	BPSK	6dB BANDWIDTH	9 kHz
TRANSFER RATE	6Mbps	INPUT POWER (SYSTEM)	120Vac, 60 Hz
ENVIRONMENTAL CONDITIONS	20deg. C, 60%RH, 991hPa	TEST MODE	A
TESTED BY	Match Tsui		

No	Freq. [MHz]	Corr. Factor (dB)	Reading Value [dB (uV)]		Emission Level [dB (uV)]		Limit [dB (uV)]		Margin (dB)	
			Q.P.	AV.	Q.P.	AV.	Q.P.	AV.	Q.P.	AV.
			1	0.288	0.10	48.08	-	48.18	-	60.58
2	0.345	0.10	49.19	43.07	49.29	43.17	59.07	49.07	-9.78	-5.90
3	0.459	0.10	43.44	-	43.54	-	56.72	46.72	-13.18	-
4	0.689	0.10	39.52	-	39.62	-	56.00	46.00	-16.38	-
5	1.668	0.17	40.46	-	40.63	-	56.00	46.00	-15.37	-
6	25.770	0.99	31.15	-	32.14	-	60.00	50.00	-27.86	-

- REMARKS:**
1. Q.P. and AV. are abbreviations of quasi-peak and average individually.
 2. "-": The Quasi-peak reading value also meets average limit and measurement with the average detector is unnecessary.
 3. The emission levels of other frequencies were very low against the limit.
 4. Margin value = Emission level - Limit value
 5. Correction factor = Insertion loss + Cable loss
 6. Emission Level = Correction Factor + Reading Value.

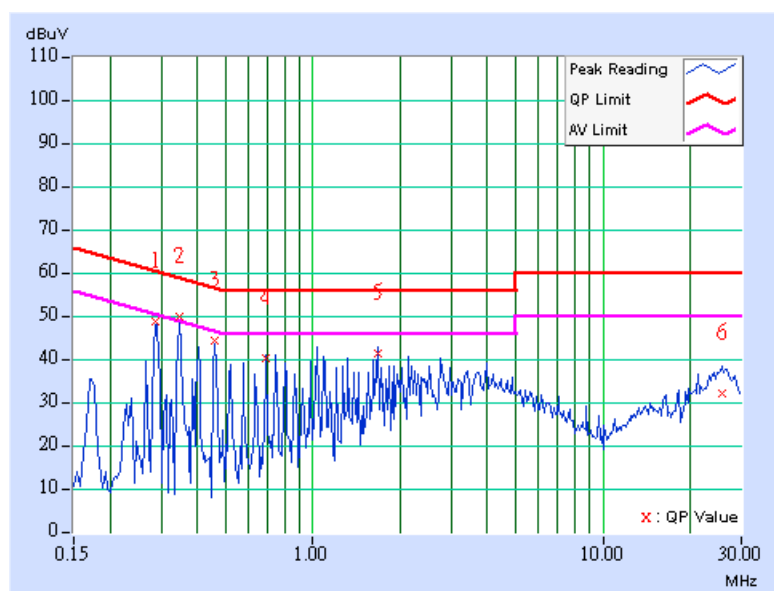

EUT TEST CONDITION		MEASUREMENT DETAIL	
CHANNEL	Channel 1	PHASE	Line 2
MODULATION TYPE	BPSK	6dB BANDWIDTH	9 kHz
TRANSFER RATE	6Mbps	INPUT POWER (SYSTEM)	120Vac, 60 Hz
ENVIRONMENTAL CONDITIONS	20deg. C, 60%RH, 991hPa	TEST MODE	A
TESTED BY	Match Tsui		

No	Freq. [MHz]	Corr. Factor [dB]	Reading Value [dB (uV)]		Emission Level [dB (uV)]		Limit [dB (uV)]		Margin (dB)	
			Q.P.	AV.	Q.P.	AV.	Q.P.	AV.	Q.P.	AV.
			1	0.287	0.10	43.31	-	43.41	-	60.62
2	0.345	0.10	44.12	-	44.22	-	59.07	49.07	-14.85	-
3	0.459	0.11	39.44	-	39.55	-	56.72	46.72	-17.17	-
4	0.748	0.16	36.30	-	36.46	-	56.00	46.00	-19.54	-
5	1.672	0.20	38.02	-	38.22	-	56.00	46.00	-17.78	-
6	24.754	0.82	27.72	-	28.54	-	60.00	50.00	-31.46	-

- REMARKS:**
1. Q.P. and AV. are abbreviations of quasi-peak and average individually.
 2. "-": The Quasi-peak reading value also meets average limit and measurement with the average detector is unnecessary.
 3. The emission levels of other frequencies were very low against the limit.
 4. Margin value = Emission level - Limit value
 5. Correction factor = Insertion loss + Cable loss
 6. Emission Level = Correction Factor + Reading Value.

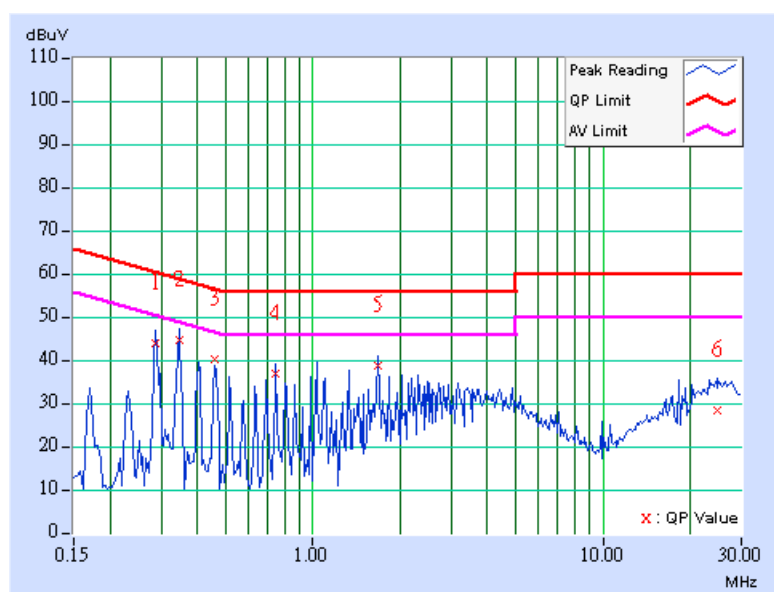

EUT TEST CONDITION		MEASUREMENT DETAIL	
CHANNEL	Channel 6	PHASE	Line 1
MODULATION TYPE	BPSK	6dB BANDWIDTH	9 kHz
TRANSFER RATE	6Mbps	INPUT POWER (SYSTEM)	120Vac, 60 Hz
ENVIRONMENTAL CONDITIONS	20deg. C, 60%RH, 991hPa	TEST MODE	A
TESTED BY	Match Tsui		

No	Freq. [MHz]	Corr. Factor (dB)	Reading Value [dB (uV)]		Emission Level [dB (uV)]		Limit [dB (uV)]		Margin (dB)	
			Q.P.	AV.	Q.P.	AV.	Q.P.	AV.	Q.P.	AV.
1	0.291	0.10	46.81	-	46.91	-	60.51	50.51	-13.60	-
2	0.345	0.10	49.23	43.07	49.33	43.17	59.07	49.07	-9.74	-5.90
3	0.463	0.10	43.57	-	43.67	-	56.65	46.65	-12.98	-
4	0.693	0.10	39.37	-	39.47	-	56.00	46.00	-16.53	-
5	2.188	0.22	39.50	-	39.72	-	56.00	46.00	-16.28	-
6	25.164	0.94	31.62	-	32.56	-	60.00	50.00	-27.44	-

- REMARKS:**
1. Q.P. and AV. are abbreviations of quasi-peak and average individually.
 2. "-": The Quasi-peak reading value also meets average limit and measurement with the average detector is unnecessary.
 3. The emission levels of other frequencies were very low against the limit.
 4. Margin value = Emission level - Limit value
 5. Correction factor = Insertion loss + Cable loss
 6. Emission Level = Correction Factor + Reading Value.

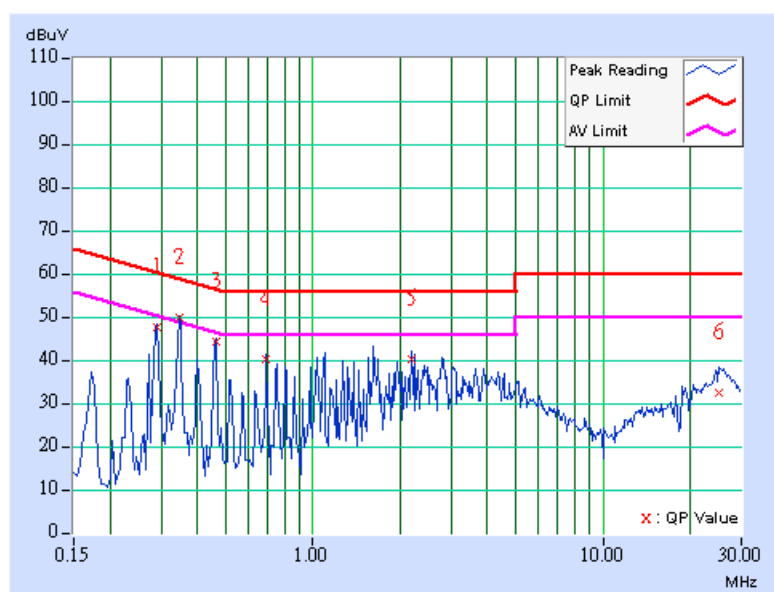

EUT TEST CONDITION		MEASUREMENT DETAIL	
CHANNEL	Channel 6	PHASE	Line 2
MODULATION TYPE	BPSK	6dB BANDWIDTH	9 kHz
TRANSFER RATE	6Mbps	INPUT POWER (SYSTEM)	120Vac, 60 Hz
ENVIRONMENTAL CONDITIONS	20deg. C, 60%RH, 991hPa	TEST MODE	A
TESTED BY	Match Tsui		

No	Freq. [MHz]	Corr. Factor [dB]	Reading Value [dB (uV)]		Emission Level [dB (uV)]		Limit [dB (uV)]		Margin (dB)	
			Q.P.	AV.	Q.P.	AV.	Q.P.	AV.	Q.P.	AV.
1	0.291	0.10	42.37	-	42.47	-	60.51	50.51	-18.04	-
2	0.347	0.10	43.77	-	43.87	-	59.04	49.04	-15.17	-
3	0.463	0.11	39.87	-	39.98	-	56.65	46.65	-16.67	-
4	1.039	0.20	36.45	-	36.65	-	56.00	46.00	-19.35	-
5	2.305	0.23	34.70	-	34.93	-	56.00	46.00	-21.07	-
6	25.184	0.84	27.59	-	28.43	-	60.00	50.00	-31.57	-

- REMARKS:**
1. Q.P. and AV. are abbreviations of quasi-peak and average individually.
 2. "-": The Quasi-peak reading value also meets average limit and measurement with the average detector is unnecessary.
 3. The emission levels of other frequencies were very low against the limit.
 4. Margin value = Emission level - Limit value
 5. Correction factor = Insertion loss + Cable loss
 6. Emission Level = Correction Factor + Reading Value.

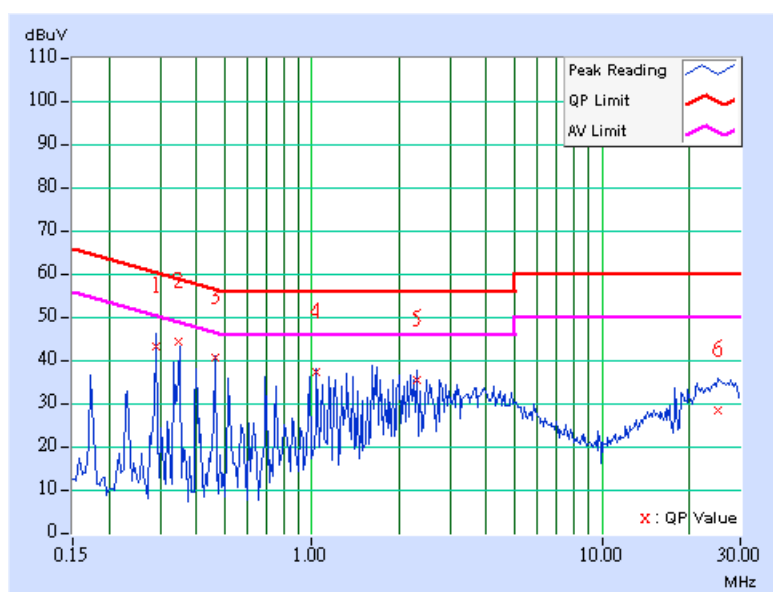

EUT TEST CONDITION		MEASUREMENT DETAIL	
CHANNEL	Channel 11	PHASE	Line 1
MODULATION TYPE	BPSK	6dB BANDWIDTH	9 kHz
TRANSFER RATE	6Mbps	INPUT POWER (SYSTEM)	120Vac, 60 Hz
ENVIRONMENTAL CONDITIONS	20deg. C, 60%RH, 991hPa	TEST MODE	A
TESTED BY	Match Tsui		

No	Freq. [MHz]	Corr. Factor [dB]	Reading Value [dB (uV)]		Emission Level [dB (uV)]		Limit [dB (uV)]		Margin (dB)	
			Q.P.	AV.	Q.P.	AV.	Q.P.	AV.	Q.P.	AV.
1	0.287	0.10	48.04	-	48.14	-	60.62	50.62	-12.48	-
2	0.345	0.10	49.25	43.07	49.35	43.17	59.07	49.07	-9.72	-5.90
3	0.459	0.10	43.60	-	43.70	-	56.72	46.72	-13.02	-
4	0.748	0.10	40.44	-	40.54	-	56.00	46.00	-15.46	-
5	2.820	0.27	37.49	-	37.76	-	56.00	46.00	-18.24	-
6	25.160	0.94	31.86	-	32.80	-	60.00	50.00	-27.20	-

- REMARKS:**
1. Q.P. and AV. are abbreviations of quasi-peak and average individually.
 2. "-": The Quasi-peak reading value also meets average limit and measurement with the average detector is unnecessary.
 3. The emission levels of other frequencies were very low against the limit.
 4. Margin value = Emission level - Limit value
 5. Correction factor = Insertion loss + Cable loss
 6. Emission Level = Correction Factor + Reading Value.

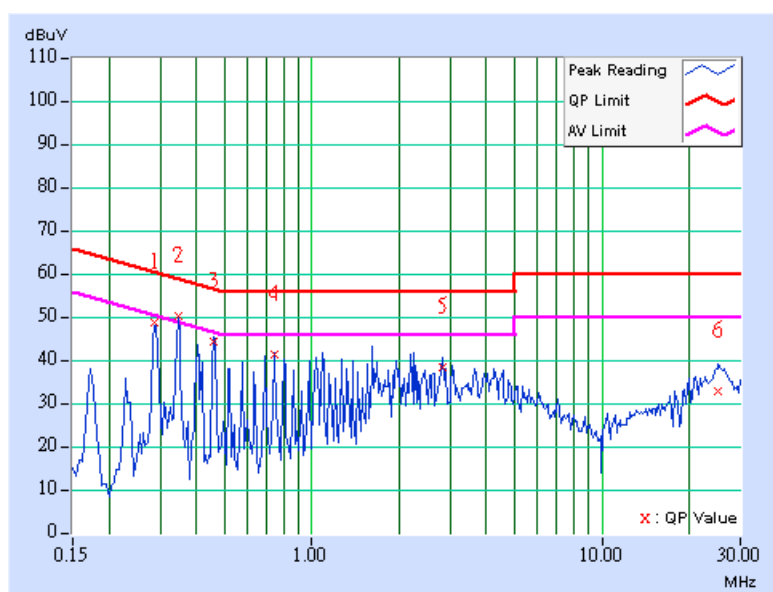

EUT TEST CONDITION		MEASUREMENT DETAIL	
CHANNEL	Channel 11	PHASE	Line 2
MODULATION TYPE	BPSK	6dB BANDWIDTH	9 kHz
TRANSFER RATE	6Mbps	INPUT POWER (SYSTEM)	120Vac, 60 Hz
ENVIRONMENTAL CONDITIONS	20deg. C, 60%RH, 991hPa	TEST MODE	A
TESTED BY	Match Tsui		

No	Freq. [MHz]	Corr. Factor [dB]	Reading Value [dB (uV)]		Emission Level [dB (uV)]		Limit [dB (uV)]		Margin (dB)	
			Q.P.	AV.	Q.P.	AV.	Q.P.	AV.	Q.P.	AV.
1	0.287	0.10	43.44	-	43.54	-	60.62	50.62	-17.08	-
2	0.345	0.10	44.12	-	44.22	-	59.07	49.07	-14.85	-
3	0.463	0.11	39.93	-	40.04	-	56.65	46.65	-16.61	-
4	1.094	0.20	37.48	-	37.68	-	56.00	46.00	-18.32	-
5	2.824	0.27	33.02	-	33.29	-	56.00	46.00	-22.71	-
6	26.059	0.87	27.77	-	28.64	-	60.00	50.00	-31.36	-

- REMARKS:**
1. Q.P. and AV. are abbreviations of quasi-peak and average individually.
 2. "-": The Quasi-peak reading value also meets average limit and measurement with the average detector is unnecessary.
 3. The emission levels of other frequencies were very low against the limit.
 4. Margin value = Emission level - Limit value
 5. Correction factor = Insertion loss + Cable loss
 6. Emission Level = Correction Factor + Reading Value.

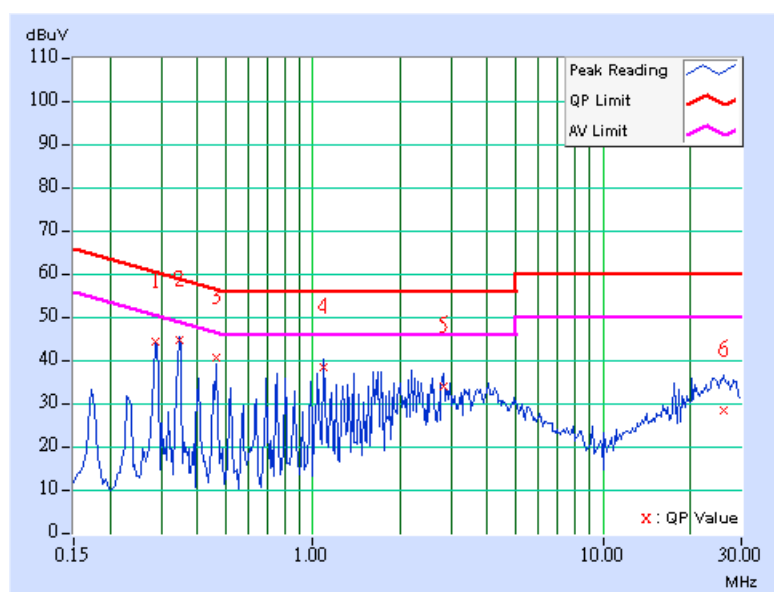

POWER FROM HOST EQUIPMENT

EUT TEST CONDITION		MEASUREMENT DETAIL	
CHANNEL	Channel 1	PHASE	Line 1
MODULATION TYPE	BPSK	6dB BANDWIDTH	9 kHz
TRANSFER RATE	6Mbps	INPUT POWER (SYSTEM)	120Vac, 60 Hz
ENVIRONMENTAL CONDITIONS	20deg. C, 60%RH, 991hPa	TEST MODE	B
TESTED BY	Match Tsui		

No	Freq. [MHz]	Corr. Factor [dB]	Reading Value [dB (uV)]		Emission Level [dB (uV)]		Limit [dB (uV)]		Margin (dB)	
			Q.P.	AV.	Q.P.	AV.	Q.P.	AV.	Q.P.	AV.
1	0.220	0.10	42.02	-	42.12	-	62.81	52.81	-20.69	-
2	0.275	0.10	29.99	-	30.09	-	60.97	50.97	-30.88	-
3	0.380	0.10	21.57	-	21.67	-	58.27	48.27	-36.60	-
4	2.031	0.20	30.75	-	30.95	-	56.00	46.00	-25.05	-
5	3.637	0.34	26.79	-	27.13	-	56.00	46.00	-28.87	-
6	13.363	0.54	27.75	-	28.29	-	60.00	50.00	-31.71	-

- REMARKS:**
1. Q.P. and AV. are abbreviations of quasi-peak and average individually.
 2. "-": The Quasi-peak reading value also meets average limit and measurement with the average detector is unnecessary.
 3. The emission levels of other frequencies were very low against the limit.
 4. Margin value = Emission level - Limit value
 5. Correction factor = Insertion loss + Cable loss
 6. Emission Level = Correction Factor + Reading Value.

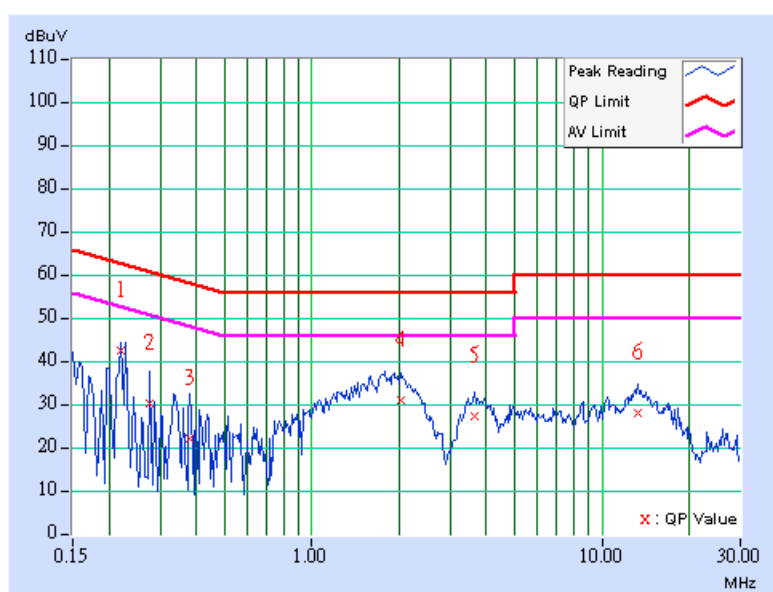

EUT TEST CONDITION		MEASUREMENT DETAIL	
CHANNEL	Channel 1	PHASE	Line 2
MODULATION TYPE	BPSK	6dB BANDWIDTH	9 kHz
TRANSFER RATE	6Mbps	INPUT POWER (SYSTEM)	120Vac, 60 Hz
ENVIRONMENTAL CONDITIONS	20deg. C, 60%RH, 991hPa	TEST MODE	B
TESTED BY	Match Tsui		

No	Freq. [MHz]	Corr. Factor [dB]	Reading Value [dB (uV)]		Emission Level [dB (uV)]		Limit [dB (uV)]		Margin (dB)	
			Q.P.	AV.	Q.P.	AV.	Q.P.	AV.	Q.P.	AV.
1	0.220	0.10	42.04	-	42.14	-	62.81	52.81	-20.67	-
2	0.255	0.10	34.90	-	35.00	-	61.58	51.58	-26.58	-
3	0.447	0.11	25.02	-	25.13	-	56.93	46.93	-31.81	-
4	1.801	0.20	31.69	-	31.89	-	56.00	46.00	-24.11	-
5	3.664	0.34	24.76	-	25.10	-	56.00	46.00	-30.90	-
6	13.555	0.58	27.08	-	27.66	-	60.00	50.00	-32.34	-

- REMARKS:**
1. Q.P. and AV. are abbreviations of quasi-peak and average individually.
 2. "-": The Quasi-peak reading value also meets average limit and measurement with the average detector is unnecessary.
 3. The emission levels of other frequencies were very low against the limit.
 4. Margin value = Emission level - Limit value
 5. Correction factor = Insertion loss + Cable loss
 6. Emission Level = Correction Factor + Reading Value.

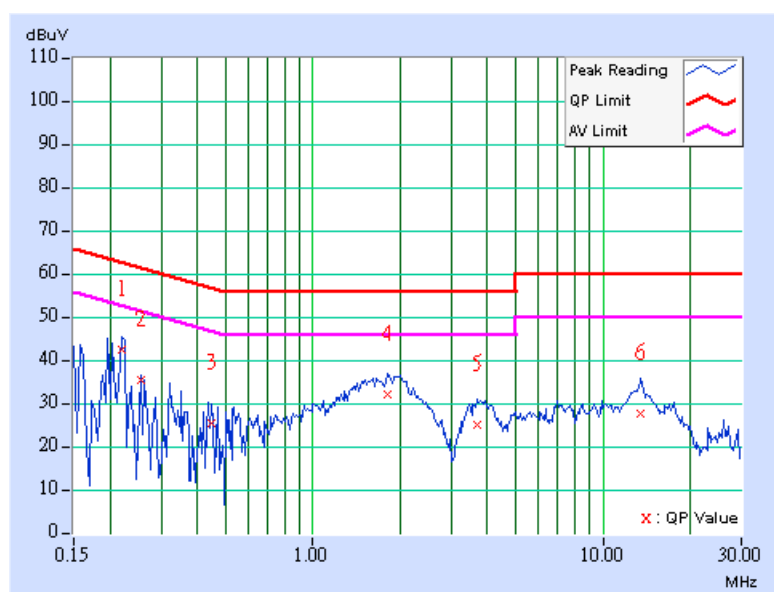

EUT TEST CONDITION		MEASUREMENT DETAIL	
CHANNEL	Channel 6	PHASE	Line 1
MODULATION TYPE	BPSK	6dB BANDWIDTH	9 kHz
TRANSFER RATE	6Mbps	INPUT POWER (SYSTEM)	120Vac, 60 Hz
ENVIRONMENTAL CONDITIONS	20deg. C, 60%RH, 991hPa	TEST MODE	B
TESTED BY	Match Tsui		

No	Freq. [MHz]	Corr. Factor [dB]	Reading Value [dB (uV)]		Emission Level [dB (uV)]		Limit [dB (uV)]		Margin (dB)	
			Q.P.	AV.	Q.P.	AV.	Q.P.	AV.	Q.P.	AV.
1	0.170	0.10	40.55	-	40.65	-	64.98	54.98	-24.33	-
2	0.216	0.10	43.30	-	43.40	-	62.96	52.96	-19.56	-
3	0.334	0.10	28.24	-	28.34	-	59.36	49.36	-31.02	-
4	1.809	0.18	31.79	-	31.97	-	56.00	46.00	-24.03	-
5	3.586	0.33	26.61	-	26.94	-	56.00	46.00	-29.06	-
6	13.047	0.52	27.10	-	27.62	-	60.00	50.00	-32.38	-

- REMARKS:**
1. Q.P. and AV. are abbreviations of quasi-peak and average individually.
 2. "-": The Quasi-peak reading value also meets average limit and measurement with the average detector is unnecessary.
 3. The emission levels of other frequencies were very low against the limit.
 4. Margin value = Emission level - Limit value
 5. Correction factor = Insertion loss + Cable loss
 6. Emission Level = Correction Factor + Reading Value.

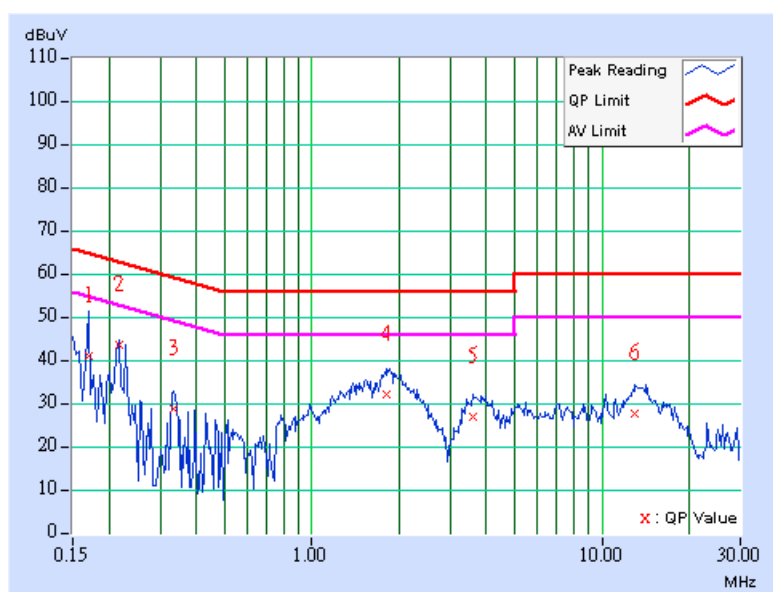

EUT TEST CONDITION		MEASUREMENT DETAIL	
CHANNEL	Channel 6	PHASE	Line 2
MODULATION TYPE	BPSK	6dB BANDWIDTH	9 kHz
TRANSFER RATE	6Mbps	INPUT POWER (SYSTEM)	120Vac, 60 Hz
ENVIRONMENTAL CONDITIONS	20deg. C, 60%RH, 991hPa	TEST MODE	B
TESTED BY	Match Tsui		

No	Freq. [MHz]	Corr. Factor [dB]	Reading Value [dB (uV)]		Emission Level [dB (uV)]		Limit [dB (uV)]		Margin (dB)	
			Q.P.	AV.	Q.P.	AV.	Q.P.	AV.	Q.P.	AV.
1	0.230	0.10	40.76	-	40.86	-	62.46	52.46	-21.60	-
2	0.331	0.10	30.37	-	30.47	-	59.43	49.43	-28.96	-
3	0.459	0.11	24.64	-	24.75	-	56.72	46.72	-31.97	-
4	1.836	0.20	31.16	-	31.36	-	56.00	46.00	-24.64	-
5	3.617	0.34	25.40	-	25.74	-	56.00	46.00	-30.26	-
6	12.914	0.56	28.11	-	28.67	-	60.00	50.00	-31.33	-

- REMARKS:**
1. Q.P. and AV. are abbreviations of quasi-peak and average individually.
 2. "-": The Quasi-peak reading value also meets average limit and measurement with the average detector is unnecessary.
 3. The emission levels of other frequencies were very low against the limit.
 4. Margin value = Emission level - Limit value
 5. Correction factor = Insertion loss + Cable loss
 6. Emission Level = Correction Factor + Reading Value.

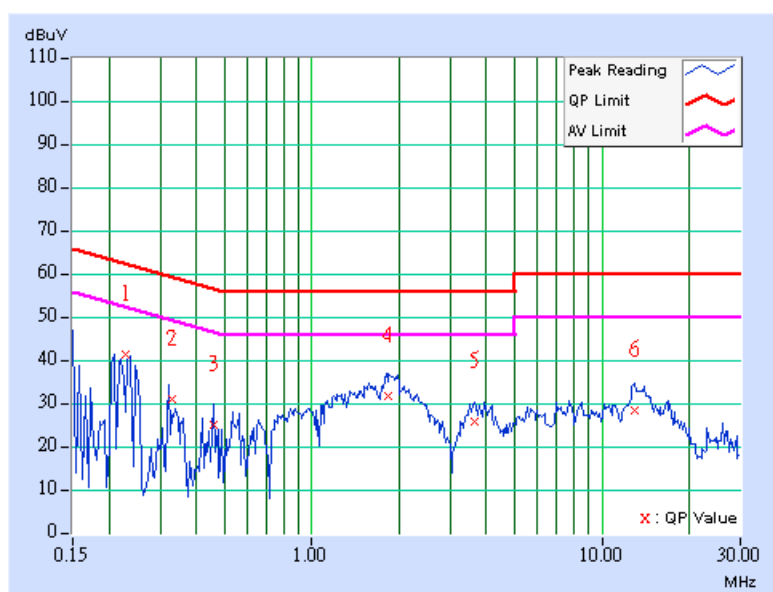

EUT TEST CONDITION		MEASUREMENT DETAIL	
CHANNEL	Channel 11	PHASE	Line 1
MODULATION TYPE	BPSK	6dB BANDWIDTH	9 kHz
TRANSFER RATE	6Mbps	INPUT POWER (SYSTEM)	120Vac, 60 Hz
ENVIRONMENTAL CONDITIONS	20deg. C, 60%RH, 991hPa	TEST MODE	B
TESTED BY	Match Tsui		

No	Freq. [MHz]	Corr. Factor [dB]	Reading Value [dB (uV)]		Emission Level [dB (uV)]		Limit [dB (uV)]		Margin (dB)	
			Q.P.	AV.	Q.P.	AV.	Q.P.	AV.	Q.P.	AV.
1	0.193	0.10	38.46	-	38.56	-	63.91	53.91	-25.35	-
2	0.216	0.10	42.57	-	42.67	-	62.96	52.96	-20.29	-
3	0.357	0.10	26.67	-	26.77	-	58.80	48.80	-32.03	-
4	1.727	0.17	30.75	-	30.92	-	56.00	46.00	-25.08	-
5	3.629	0.34	26.89	-	27.23	-	56.00	46.00	-28.77	-
6	13.270	0.54	28.19	-	28.73	-	60.00	50.00	-31.27	-

- REMARKS:**
1. Q.P. and AV. are abbreviations of quasi-peak and average individually.
 2. "-": The Quasi-peak reading value also meets average limit and measurement with the average detector is unnecessary.
 3. The emission levels of other frequencies were very low against the limit.
 4. Margin value = Emission level - Limit value
 5. Correction factor = Insertion loss + Cable loss
 6. Emission Level = Correction Factor + Reading Value.

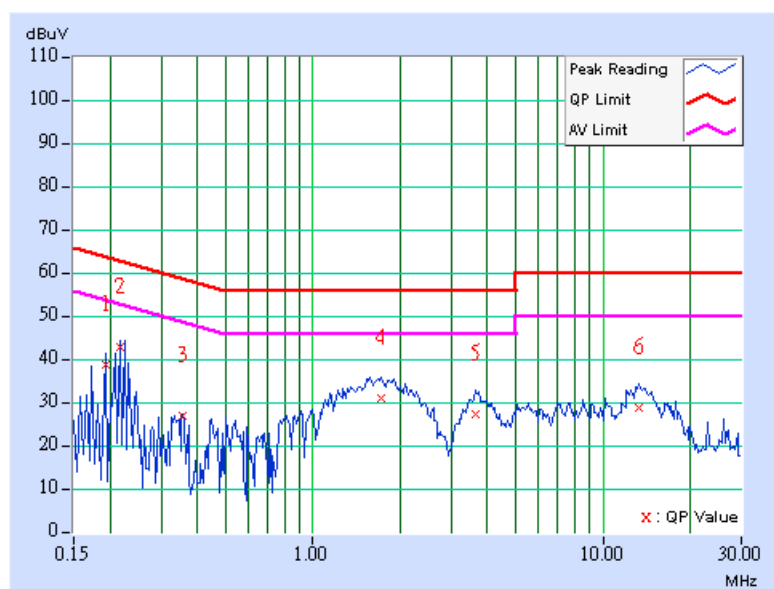

EUT TEST CONDITION		MEASUREMENT DETAIL	
CHANNEL	Channel 11	PHASE	Line 2
MODULATION TYPE	BPSK	6dB BANDWIDTH	9 kHz
TRANSFER RATE	6Mbps	INPUT POWER (SYSTEM)	120Vac, 60 Hz
ENVIRONMENTAL CONDITIONS	20deg. C, 60%RH, 991hPa	TEST MODE	B
TESTED BY	Match Tsui		

No	Freq. [MHz]	Corr. Factor [dB]	Reading Value [dB (uV)]		Emission Level [dB (uV)]		Limit [dB (uV)]		Margin (dB)	
			Q.P.	AV.	Q.P.	AV.	Q.P.	AV.	Q.P.	AV.
1	0.158	0.10	45.33	-	45.43	-	65.58	55.58	-20.15	-
2	0.213	0.10	39.39	-	39.49	-	63.11	53.11	-23.62	-
3	0.409	0.10	18.47	-	18.57	-	57.67	47.67	-39.10	-
4	1.785	0.20	31.17	-	31.37	-	56.00	46.00	-24.63	-
5	3.582	0.33	24.94	-	25.27	-	56.00	46.00	-30.73	-
6	13.738	0.59	28.05	-	28.64	-	60.00	50.00	-31.36	-

- REMARKS:**
1. Q.P. and AV. are abbreviations of quasi-peak and average individually.
 2. "-": The Quasi-peak reading value also meets average limit and measurement with the average detector is unnecessary.
 3. The emission levels of other frequencies were very low against the limit.
 4. Margin value = Emission level - Limit value
 5. Correction factor = Insertion loss + Cable loss
 6. Emission Level = Correction Factor + Reading Value.

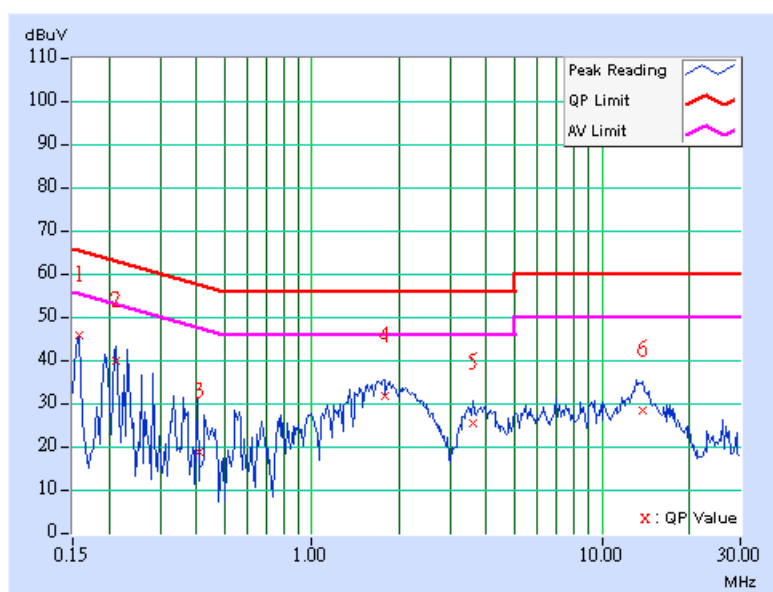

4.2 RADIATED EMISSION MEASUREMENT

4.2.1 LIMITS OF RADIATED EMISSION MEASUREMENT

Emissions radiated outside of the specified bands, shall be according to the general radiated limits in 15.209 as following:

Frequencies (MHz)	Field strength (microvolts/meter)	Measurement distance (meters)
0.009-0.490	2400/F(kHz)	300
0.490-1.705	24000/F(kHz)	30
1.705-30.0	30	30
30-88	100	3
88-216	150	3
216-960	200	3
Above 960	500	3

NOTE:

1. The lower limit shall apply at the transition frequencies.
2. Emission level (dBuV/m) = 20 log Emission level (uV/m).
3. As shown in 15.35(b), for frequencies above 1000MHz, the field strength limits are based on average detector, however, the peak field strength of any emission shall not exceed the maximum permitted average limits, specified above by more than 20dB under any condition of modulation.



4.2.2 TEST INSTRUMENTS

DESCRIPTION & MANUFACTURER	MODEL NO.	SERIAL NO.	CALIBRATED UNTIL
Test Receiver ROHDE & SCHWARZ	ESIB7	100188	Dec. 20, 2006
Spectrum Analyzer ROHDE & SCHWARZ	FSP40	100039	Nov. 27, 2006
BILOG Antenna SCHWARZBECK	VULB9168	9168-157	Jan. 15, 2007
HORN Antenna SCHWARZBECK	BBHA 9120 D	9120D-407	Jan. 22, 2007
HORN Antenna SCHWARZBECK	BBHA 9170	BBHA9170147	Jan. 26, 2007
Preamplifier Agilent	8449B	3008A01961	Oct. 23, 2006
Preamplifier Agilent	8447D	2944A10629	Oct. 27, 2006
RF signal cable HUBER+SUHNER	SUCOFLEX 104	214380/4	Jan. 16, 2007
RF signal cable HUBER+SUHNER	SUCOFLEX 104	219266/4	Jan. 16, 2007
Software ADT.	ADT_Radiated_V5.14	NA	NA
Antenna Tower ADT.	AT100	AT93021702	NA
Turn Table ADT.	TT100.	TT93021702	NA
Controller ADT.	SC100.	SC93021702	NA

- NOTE:**
1. The calibration interval of the above test instruments is 12 months and the calibrations are traceable to NML/ROC and NIST/USA.
 2. The test was performed in HwaYa Chamber 2.
 3. The horn antenna and HP preamplifier (model: 8449B) are used only for the measurement of emission frequency above 1GHz if tested.
 4. The IC Site Registration No. is IC4924-2.

4.2.3 TEST PROCEDURES

- a. The EUT was placed on the top of a rotating table 0.8 meters above the ground at a 3 meters semi-anechoic chamber. The table was rotated 360 degrees to determine the position of the highest radiation.
- b. The EUT was set 3 meters away from the interference-receiving antenna, which was mounted on the top of a variable-height antenna tower.
- c. The antenna is a broadband antenna, and its height is varied from one meter to four meters above the ground to determine the maximum value of the field strength. Both horizontal and vertical polarizations of the antenna are set to make the measurement.
- d. For each suspected emission, the EUT was arranged to its worst case and then the antenna was tuned to heights from 1 meter to 4 meters and the rotatable table was turned from 0 degrees to 360 degrees to find the maximum reading.
- e. The test-receiver system was set to Peak Detect Function and Specified Bandwidth with Maximum Hold Mode.
- f. If the emission level of the EUT in peak mode was lower than the limit specified, then testing could be stopped and the peak values of the EUT would be reported. Otherwise the emissions would be re-tested one by one using peak, quasi-peak or average method as specified and then reported in a data sheet.

NOTE:

1. The resolution bandwidth and video bandwidth of test receiver/spectrum analyzer is 120kHz for Peak detection (PK) and Quasi-peak detection (QP) at frequency below 1GHz.
2. The resolution bandwidth of test receiver/spectrum analyzer is 1 MHz and video bandwidth is 3MHz for Peak detection at frequency above 1GHz.
3. The resolution bandwidth of test receiver/spectrum analyzer is 1MHz and the video bandwidth is 10Hz for Average detection (AV) at frequency above 1GHz.

4.2.4 DEVIATION FROM TEST STANDARD

No deviation

4.2.5 TEST SETUP

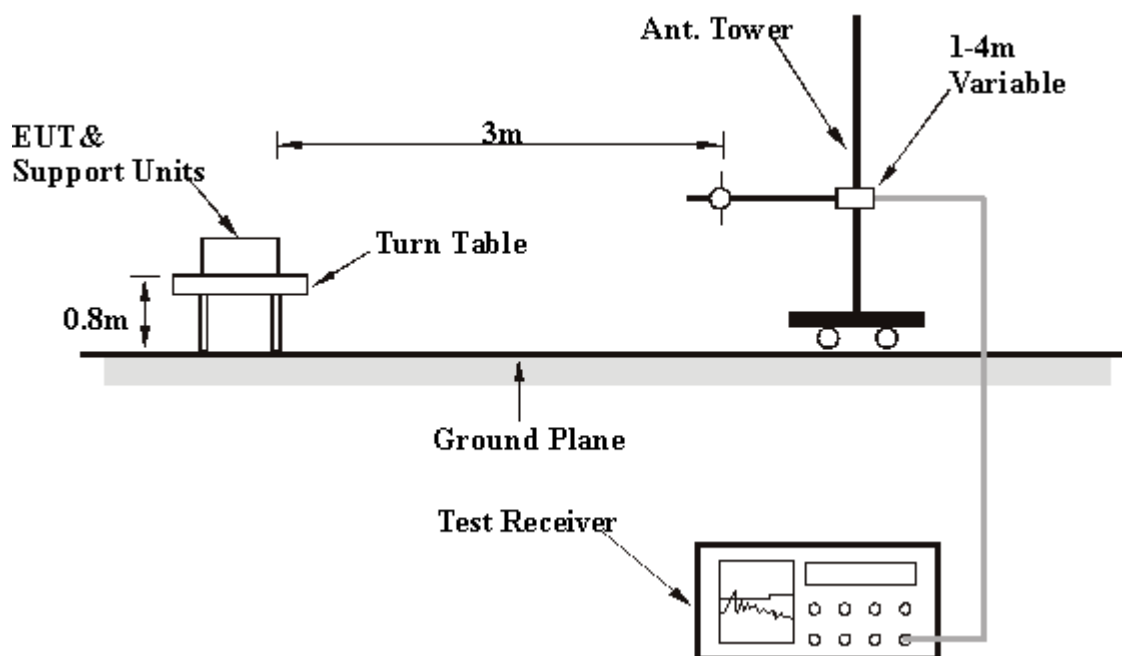

For the actual test configuration, please refer to the related item – Photographs of the Test Configuration.

4.2.6 EUT OPERATING CONDITIONS

Same as 4.1.6

4.2.7 TEST RESULTS

RADIATED WORST-CASE DATA: BELOW 1GHz

FOR AC ADAPTER

EUT TEST CONDITION		MEASUREMENT DETAIL	
CHANNEL	Channel 11	FREQUENCY RANGE	Below 1000MHz
MODULATION TYPE	BPSK	DETECTOR FUNCTION	Quasi-Peak
TRANSFER RATE	6Mbps	INPUT POWER (SYSTEM)	120Vac, 60 Hz
ENVIRONMENTAL CONDITIONS	27deg. C, 66%RH, 991hPa	TEST MODE	A
TESTED BY	Lori Chiu		

ANTENNA POLARITY & TEST DISTANCE: HORIZONTAL AT 3 M

No.	Freq. (MHz)	Emission Level (dBuV/m)	Limit (dBuV/m)	Margin (dB)	Antenna Height (m)	Table Angle (Degree)	Raw Value (dBuV)	Correction Factor (dB/m)
1	160.24	34.95 QP	43.50	-8.55	1.50 H	199	21.56	13.39
2	249.66	37.51 QP	46.00	-8.49	1.50 H	73	25.05	12.45
3	360.46	39.78 QP	46.00	-6.22	1.50 H	49	23.15	16.63
4	440.16	39.01 QP	46.00	-6.99	1.00 H	79	20.26	18.75
5	479.04	40.11 QP	46.00	-5.89	1.50 H	76	20.51	19.60
6	519.86	38.26 QP	46.00	-7.74	2.00 H	37	17.76	20.50
7	739.52	36.15 QP	46.00	-9.85	1.00 H	40	10.72	25.44
8	799.78	36.44 QP	46.00	-9.56	1.50 H	64	10.45	26.00

ANTENNA POLARITY & TEST DISTANCE: VERTICAL AT 3 M

No.	Freq. (MHz)	Emission Level (dBuV/m)	Limit (dBuV/m)	Margin (dB)	Antenna Height (m)	Table Angle (Degree)	Raw Value (dBuV)	Correction Factor (dB/m)
1	31.94	36.80 QP	40.00	-3.20	1.00 V	259	24.26	12.54
2	72.77	37.05 QP	40.00	-2.95	1.00 V	265	25.59	11.46
3	113.59	36.77 QP	43.50	-6.73	1.00 V	67	26.54	10.23
4	160.24	33.68 QP	43.50	-9.82	1.00 V	268	20.29	13.39
5	360.46	37.73 QP	46.00	-8.27	1.00 V	163	21.10	16.63
6	479.04	38.35 QP	46.00	-7.65	1.00 V	76	18.75	19.60
7	519.86	36.31 QP	46.00	-9.69	1.00 V	58	15.81	20.50
8	799.78	37.72 QP	46.00	-8.28	1.00 V	49	11.73	26.00

- REMARKS:**
1. Emission level(dBuV/m)=Raw Value(dBuV) + Correction Factor(dB/m)
 2. Correction Factor(dB/m) = Antenna Factor (dB/m) + Cable Factor (dB)
 3. The other emission levels were very low against the limit.
 4. Margin value = Emission level – Limit value.

FOR HOST EQUIPMENT

EUT TEST CONDITION		MEASUREMENT DETAIL	
CHANNEL	Channel 11	FREQUENCY RANGE	Below 1000MHz
MODULATION TYPE	BPSK	DETECTOR FUNCTION	Quasi-Peak
TRANSFER RATE	6Mbps	INPUT POWER (SYSTEM)	120Vac, 60 Hz
ENVIRONMENTAL CONDITIONS	27deg. C, 66%RH, 991hPa	TEST MODE	B
TESTED BY	Lori Chiu		

ANTENNA POLARITY & TEST DISTANCE: HORIZONTAL AT 3 M								
No.	Freq. (MHz)	Emission Level (dBuV/m)	Limit (dBuV/m)	Margin (dB)	Antenna Height (m)	Table Angle (Degree)	Raw Value (dBuV)	Correction Factor (dB/m)
1	160.32	35.18 QP	43.50	-8.32	1.00 H	268	21.79	13.39
2	360.38	39.65 QP	46.00	-6.35	1.00 H	115	23.02	16.63
3	440.25	39.27 QP	46.00	-6.73	1.00 H	207	20.52	18.75
4	479.10	40.35 QP	46.00	-5.65	1.00 H	34	20.75	19.60
5	519.92	38.52 QP	46.00	-7.48	1.50 H	352	18.02	20.50
6	799.82	36.65 QP	46.00	-9.35	2.00 H	228	10.65	26.00

ANTENNA POLARITY & TEST DISTANCE: VERTICAL AT 3 M								
No.	Freq. (MHz)	Emission Level (dBuV/m)	Limit (dBuV/m)	Margin (dB)	Antenna Height (m)	Table Angle (Degree)	Raw Value (dBuV)	Correction Factor (dB/m)
1	31.87	36.65 QP	40.00	-3.35	1.50 V	243	24.12	12.53
2	72.68	37.11 QP	40.00	-2.89	1.00 V	125	25.64	11.47
3	113.62	36.58 QP	43.50	-6.92	1.00 V	342	26.35	10.23
4	360.38	37.81 QP	46.00	-8.19	1.00 V	278	21.18	16.63
5	479.14	38.28 QP	46.00	-7.72	1.50 V	167	18.68	19.60
6	799.80	37.69 QP	46.00	-8.31	1.00 V	27	11.69	26.00

- REMARKS:**
1. Emission level(dBuV/m)=Raw Value(dBuV) + Correction Factor(dB/m)
 2. Correction Factor(dB/m) = Antenna Factor (dB/m) + Cable Factor (dB)
 3. The other emission levels were very low against the limit.
 4. Margin value = Emission level – Limit value.

802.11b DSSS MODULATION

EUT TEST CONDITION		MEASUREMENT DETAIL	
CHANNEL	Channel 1	FREQUENCY RANGE	1 ~ 25GHz
MODULATION TYPE	DBPSK	DETECTOR FUNCTION	Peak(PK) Average (AV)
TRANSFER RATE	1Mbps	ENVIRONMENTAL CONDITIONS	27deg. C, 66%RH, 991hPa
INPUT POWER (SYSTEM)	120Vac, 60 Hz	TESTED BY	Lori Chiu

ANTENNA POLARITY & TEST DISTANCE: HORIZONTAL AT 3 M								
No.	Freq. (MHz)	Emission Level (dBuV/m)	Limit (dBuV/m)	Margin (dB)	Antenna Height (m)	Table Angle (Degree)	Raw Value (dBuV)	Correction Factor (dB/m)
1	1600.00	46.84 PK	74.00	-27.16	1.37 H	98	18.13	28.71
1	1600.00	43.61 AV	54.00	-10.39	1.37 H	98	14.90	28.71
2	2390.00	55.99 PK	74.00	-18.01	1.10 H	176	24.60	31.39
2	2390.00	46.18 AV	54.00	-7.82	1.10 H	176	14.79	31.39
3	*2412.00	104.23 PK			1.13 H	184	72.77	31.46
3	*2412.00	100.48 AV			1.13 H	184	69.02	31.46
4	3378.00	49.47 PK	74.00	-24.53	1.10 H	223	15.93	33.54
4	3378.00	42.18 AV	54.00	-11.82	1.10 H	223	8.64	33.54
5	4824.00	55.20 PK	74.00	-18.80	1.18 H	275	18.07	37.13
5	4824.00	52.10 AV	54.00	-1.90	1.18 H	275	14.97	37.13

ANTENNA POLARITY & TEST DISTANCE: VERTICAL AT 3 M								
No.	Freq. (MHz)	Emission Level (dBuV/m)	Limit (dBuV/m)	Margin (dB)	Antenna Height (m)	Table Angle (Degree)	Raw Value (dBuV)	Correction Factor (dB/m)
1	1600.00	44.42 PK	74.00	-29.58	1.34 V	127	15.71	28.71
1	1600.00	41.28 AV	54.00	-12.72	1.34 V	127	12.57	28.71
2	2390.00	56.38 PK	74.00	-17.62	1.37 V	169	24.99	31.39
2	2390.00	44.59 AV	54.00	-9.41	1.37 V	169	13.20	31.39
3	*2412.00	97.80 PK			1.37 V	169	66.34	31.46
3	*2412.00	94.10 AV			1.37 V	169	62.64	31.46
4	4824.00	51.44 PK	74.00	-22.56	1.48 V	197	14.31	37.13
4	4824.00	45.78 AV	54.00	-8.22	1.48 V	197	8.65	37.13

- REMARKS:**
1. Emission level(dBuV/m)=Raw Value(dBuV) + Correction Factor(dB/m)
 2. Correction Factor(dB/m) = Antenna Factor (dB/m) + Cable Factor (dB)
 3. The other emission levels were very low against the limit.
 4. Margin value = Emission level – Limit value.
 5. “ * “ : Fundamental frequency.

EUT TEST CONDITION		MEASUREMENT DETAIL	
CHANNEL	Channel 6	FREQUENCY RANGE	1 ~ 25GHz
MODULATION TYPE	DBPSK	DETECTOR FUNCTION	Peak(PK) Average (AV)
TRANSFER RATE	1Mbps	ENVIRONMENTAL CONDITIONS	27deg. C, 66%RH, 991hPa
INPUT POWER (SYSTEM)	120Vac, 60 Hz	TESTED BY	Lori Chiu

ANTENNA POLARITY & TEST DISTANCE: HORIZONTAL AT 3 M								
No.	Freq. (MHz)	Emission Level (dBuV/m)	Limit (dBuV/m)	Margin (dB)	Antenna Height (m)	Table Angle (Degree)	Raw Value (dBuV)	Correction Factor (dB/m)
1	1600.00	46.32 PK	74.00	-27.68	1.57 H	232	17.61	28.71
1	1600.00	43.40 AV	54.00	-10.60	1.57 H	232	14.69	28.71
2	*2437.00	103.62 PK			1.32 H	238	72.08	31.54
2	*2437.00	99.66 AV			1.32 H	238	68.12	31.54
3	3413.00	48.45 PK	74.00	-25.55	1.23 H	55	14.81	33.64
3	3413.00	41.62 AV	54.00	-12.38	1.23 H	55	7.98	33.64
4	4874.00	54.43 PK	74.00	-19.57	1.03 H	322	17.14	37.29
4	4874.00	52.04 AV	54.00	-1.96	1.03 H	322	14.75	37.29

ANTENNA POLARITY & TEST DISTANCE: VERTICAL AT 3 M								
No.	Freq. (MHz)	Emission Level (dBuV/m)	Limit (dBuV/m)	Margin (dB)	Antenna Height (m)	Table Angle (Degree)	Raw Value (dBuV)	Correction Factor (dB/m)
1	1600.00	44.59 PK	74.00	-29.41	1.55 V	167	15.88	28.71
1	1600.00	41.36 AV	54.00	-12.64	1.55 V	167	12.65	28.71
2	*2437.00	96.82 PK			1.38 V	22	65.28	31.54
2	*2437.00	93.65 AV			1.38 V	22	62.11	31.54
3	4874.00	51.15 PK	74.00	-22.85	1.02 V	111	13.86	37.29
3	4874.00	46.37 AV	54.00	-7.63	1.02 V	111	9.08	37.29

- REMARKS:**
1. Emission level(dBuV/m)=Raw Value(dBuV) + Correction Factor(dB/m)
 2. Correction Factor(dB/m) = Antenna Factor (dB/m) + Cable Factor (dB)
 3. The other emission levels were very low against the limit.
 4. Margin value = Emission level – Limit value.
 5. “ * ” : Fundamental frequency.

EUT TEST CONDITION		MEASUREMENT DETAIL	
CHANNEL	Channel 11	FREQUENCY RANGE	1 ~ 25GHz
MODULATION TYPE	DBPSK	DETECTOR FUNCTION	Peak(PK) Average (AV)
TRANSFER RATE	1Mbps	ENVIRONMENTAL CONDITIONS	27deg. C, 66%RH, 991hPa
INPUT POWER (SYSTEM)	120Vac, 60 Hz	TESTED BY	Lori Chiu

ANTENNA POLARITY & TEST DISTANCE: HORIZONTAL AT 3 M								
No.	Freq. (MHz)	Emission Level (dBuV/m)	Limit (dBuV/m)	Margin (dB)	Antenna Height (m)	Table Angle (Degree)	Raw Value (dBuV)	Correction Factor (dB/m)
1	1600.00	46.75 PK	74.00	-27.25	1.33 H	100	18.04	28.71
1	1600.00	43.52 AV	54.00	-10.48	1.33 H	100	14.81	28.71
2	*2462.00	103.76 PK			1.36 H	185	72.14	31.62
2	*2462.00	99.95 AV			1.36 H	185	68.33	31.62
3	2483.50	56.52 PK	74.00	-17.48	1.36 H	183	24.82	31.70
3	2483.50	46.33 AV	54.00	-7.67	1.36 H	183	14.63	31.70
4	3444.00	48.89 PK	74.00	-25.11	1.53 H	326	15.17	33.72
4	3444.00	41.93 AV	54.00	-12.07	1.53 H	326	8.21	33.72
5	4924.00	54.42 PK	74.00	-19.58	1.13 H	305	16.98	37.44
5	4924.00	52.73 AV	54.00	-1.27	1.13 H	305	15.29	37.44

ANTENNA POLARITY & TEST DISTANCE: VERTICAL AT 3 M								
No.	Freq. (MHz)	Emission Level (dBuV/m)	Limit (dBuV/m)	Margin (dB)	Antenna Height (m)	Table Angle (Degree)	Raw Value (dBuV)	Correction Factor (dB/m)
1	1600.00	44.18 PK	74.00	-29.82	1.27 V	322	15.47	28.71
1	1600.00	41.37 AV	54.00	-12.63	1.27 V	322	12.66	28.71
2	*2462.00	96.89 PK			1.45 V	282	65.27	31.62
2	*2462.00	93.72 AV			1.45 V	282	62.10	31.62
3	2483.50	55.47 PK	74.00	-18.53	1.45 V	282	23.77	31.70
3	2483.50	44.95 AV	54.00	-9.05	1.45 V	282	13.25	31.70
4	4924.00	52.35 PK	74.00	-21.65	1.11 V	219	14.91	37.44
4	4924.00	47.52 AV	54.00	-6.48	1.11 V	219	10.08	37.44

- REMARKS:**
1. Emission level(dBuV/m)=Raw Value(dBuV) + Correction Factor(dB/m)
 2. Correction Factor(dB/m) = Antenna Factor (dB/m) + Cable Factor (dB)
 3. The other emission levels were very low against the limit.
 4. Margin value = Emission level – Limit value.
 5. “ * “ : Fundamental frequency.

802.11g OFDM MODULATION

EUT TEST CONDITION		MEASUREMENT DETAIL	
CHANNEL	Channel 1	FREQUENCY RANGE	1 ~ 25GHz
MODULATION TYPE	BPSK	DETECTOR FUNCTION	Peak(PK) Average (AV)
TRANSFER RATE	6Mbps	ENVIRONMENTAL CONDITIONS	27deg. C, 66%RH, 991hPa
INPUT POWER (SYSTEM)	120Vac, 60 Hz	TESTED BY	Lori Chiu

ANTENNA POLARITY & TEST DISTANCE: HORIZONTAL AT 3 M

No.	Freq. (MHz)	Emission Level (dBuV/m)	Limit (dBuV/m)	Margin (dB)	Antenna Height (m)	Table Angle (Degree)	Raw Value (dBuV)	Correction Factor (dB/m)
1	1600.00	47.19 PK	74.00	-26.81	1.38 H	198	18.48	28.71
1	1600.00	43.85 AV	54.00	-10.15	1.38 H	198	15.14	28.71
2	2390.00	64.84 PK	74.00	-9.16	1.13 H	155	33.45	31.39
2	2390.00	52.15 AV	54.00	-1.85	1.13 H	155	20.76	31.39
3	*2412.00	104.85 PK			1.12 H	185	73.39	31.46
3	*2412.00	95.85 AV			1.12 H	185	64.39	31.46
4	3378.00	47.57 PK	74.00	-26.43	1.24 H	246	14.03	33.54
4	3378.00	40.76 AV	54.00	-13.24	1.24 H	246	7.22	33.54
5	4824.00	49.22 PK	74.00	-24.78	1.56 H	272	12.09	37.13
5	4824.00	36.84 AV	54.00	-17.16	1.56 H	272	-0.29	37.13

ANTENNA POLARITY & TEST DISTANCE: VERTICAL AT 3 M

No.	Freq. (MHz)	Emission Level (dBuV/m)	Limit (dBuV/m)	Margin (dB)	Antenna Height (m)	Table Angle (Degree)	Raw Value (dBuV)	Correction Factor (dB/m)
1	1600.00	44.80 PK	74.00	-29.20	1.42 V	226	16.09	28.71
1	1600.00	41.39 AV	54.00	-12.61	1.42 V	226	12.68	28.71
2	2390.00	58.96 PK	74.00	-15.04	1.05 V	138	27.57	31.39
2	2390.00	46.22 AV	54.00	-7.78	1.05 V	138	14.83	31.39
3	*2412.00	99.36 PK			1.06 V	136	67.90	31.46
3	*2412.00	90.43 AV			1.06 V	136	58.97	31.46
4	4824.00	47.39 PK	74.00	-26.61	1.10 V	248	10.26	37.13
4	4824.00	34.49 AV	54.00	-19.51	1.10 V	248	-2.64	37.13

- REMARKS:**
1. Emission level(dBuV/m)=Raw Value(dBuV) + Correction Factor(dB/m)
 2. Correction Factor(dB/m) = Antenna Factor (dB/m) + Cable Factor (dB)
 3. The other emission levels were very low against the limit.
 4. Margin value = Emission level – Limit value.
 5. “ * ” : Fundamental frequency.

EUT TEST CONDITION		MEASUREMENT DETAIL	
CHANNEL	Channel 6	FREQUENCY RANGE	1 ~ 25GHz
MODULATION TYPE	BPSK	DETECTOR FUNCTION	Peak(PK) Average (AV)
TRANSFER RATE	6Mbps	ENVIRONMENTAL CONDITIONS	27deg. C, 66%RH, 991hPa
INPUT POWER (SYSTEM)	120Vac, 60 Hz	TESTED BY	Lori Chiu

ANTENNA POLARITY & TEST DISTANCE: HORIZONTAL AT 3 M								
No.	Freq. (MHz)	Emission Level (dBuV/m)	Limit (dBuV/m)	Margin (dB)	Antenna Height (m)	Table Angle (Degree)	Raw Value (dBuV)	Correction Factor (dB/m)
1	1600.00	47.79 PK	74.00	-26.21	1.06 H	159	19.08	28.71
1	1600.00	44.01 AV	54.00	-9.99	1.06 H	159	15.30	28.71
2	*2437.00	105.35 PK			1.37 H	193	73.81	31.54
2	*2437.00	96.44 AV			1.37 H	193	64.90	31.54
3	3413.00	49.58 PK	74.00	-24.42	1.37 H	263	15.94	33.64
3	3413.00	42.23 AV	54.00	-11.77	1.37 H	263	8.59	33.64
4	4874.00	56.02 PK	74.00	-17.98	1.03 H	327	18.73	37.29
4	4874.00	41.65 AV	54.00	-12.35	1.03 H	327	4.36	37.29

ANTENNA POLARITY & TEST DISTANCE: VERTICAL AT 3 M								
No.	Freq. (MHz)	Emission Level (dBuV/m)	Limit (dBuV/m)	Margin (dB)	Antenna Height (m)	Table Angle (Degree)	Raw Value (dBuV)	Correction Factor (dB/m)
1	1600.00	44.95 PK	74.00	-29.05	1.13 V	268	16.24	28.71
1	1600.00	41.50 AV	54.00	-12.50	1.13 V	268	12.79	28.71
2	*2437.00	100.17 PK			1.35 V	162	68.63	31.54
2	*2437.00	91.26 AV			1.35 V	162	59.72	31.54
3	4874.00	49.63 PK	74.00	-24.37	1.13 V	233	12.34	37.29
3	4874.00	36.26 AV	54.00	-17.74	1.13 V	233	-1.03	37.29

- REMARKS:**
1. Emission level(dBuV/m)=Raw Value(dBuV) + Correction Factor(dB/m)
 2. Correction Factor(dB/m) = Antenna Factor (dB/m) + Cable Factor (dB)
 3. The other emission levels were very low against the limit.
 4. Margin value = Emission level – Limit value.
 5. “ * ” : Fundamental frequency.

EUT TEST CONDITION		MEASUREMENT DETAIL	
CHANNEL	Channel 11	FREQUENCY RANGE	1 ~ 25GHz
MODULATION TYPE	BPSK	DETECTOR FUNCTION	Peak(PK) Average (AV)
TRANSFER RATE	6Mbps	ENVIRONMENTAL CONDITIONS	27deg. C, 66%RH, 991hPa
INPUT POWER (SYSTEM)	120Vac, 60 Hz	TESTED BY	Lori Chiu

ANTENNA POLARITY & TEST DISTANCE: HORIZONTAL AT 3 M								
No.	Freq. (MHz)	Emission Level (dBuV/m)	Limit (dBuV/m)	Margin (dB)	Antenna Height (m)	Table Angle (Degree)	Raw Value (dBuV)	Correction Factor (dB/m)
1	1600.00	47.02 PK	74.00	-26.98	1.34 H	208	18.31	28.71
1	1600.00	43.40 AV	54.00	-10.60	1.34 H	208	14.69	28.71
2	*2462.00	104.53 PK			1.35 H	186	72.91	31.62
2	*2462.00	95.24 AV			1.35 H	186	63.62	31.62
3	2483.50	69.82 PK	74.00	-4.18	1.32 H	189	38.12	31.70
3	2483.50	52.52 AV	54.00	-1.48	1.32 H	189	20.82	31.70
4	3444.00	46.58 PK	74.00	-27.42	1.35 H	21	12.86	33.72
4	3444.00	40.27 AV	54.00	-13.73	1.35 H	21	6.55	33.72
5	4924.00	49.56 PK	74.00	-24.44	1.60 H	213	12.12	37.44
5	4924.00	36.76 AV	54.00	-17.24	1.60 H	213	-0.68	37.44

ANTENNA POLARITY & TEST DISTANCE: VERTICAL AT 3 M								
No.	Freq. (MHz)	Emission Level (dBuV/m)	Limit (dBuV/m)	Margin (dB)	Antenna Height (m)	Table Angle (Degree)	Raw Value (dBuV)	Correction Factor (dB/m)
1	1600.00	44.62 PK	74.00	-29.38	1.32 V	185	15.91	28.71
1	1600.00	41.13 AV	54.00	-12.87	1.32 V	185	12.42	28.71
2	*2462.00	99.28 PK			1.13 V	316	67.66	31.62
2	*2462.00	90.12 AV			1.13 V	316	58.50	31.62
3	2483.50	59.18 PK	74.00	-14.82	1.13 V	319	27.48	31.70
3	2483.50	46.45 AV	54.00	-7.55	1.13 V	319	14.75	31.70
4	4924.00	47.21 PK	74.00	-26.79	1.52 V	98	9.77	37.44
4	4924.00	34.86 AV	54.00	-19.14	1.52 V	98	-2.58	37.44

- REMARKS:**
1. Emission level(dBuV/m)=Raw Value(dBuV) + Correction Factor(dB/m)
 2. Correction Factor(dB/m) = Antenna Factor (dB/m) + Cable Factor (dB)
 3. The other emission levels were very low against the limit.
 4. Margin value = Emission level – Limit value.
 5. “ * “ : Fundamental frequency.



4.3 6dB BANDWIDTH MEASUREMENT

4.3.1 LIMITS OF 6dB BANDWIDTH MEASUREMENT

The minimum of 6dB Bandwidth Measurement is 0.5 MHz.

4.3.2 TEST INSTRUMENTS

DESCRIPTION & MANUFACTURER	MODEL NO.	SERIAL NO.	CALIBRATED UNTIL
SPECTRUM ANALYZER	FSP40	100040	Jun. 07, 2007

NOTE: The calibration interval of the above test instruments is 12 months and the calibrations are traceable to NML/ROC and NIST/USA.

4.3.3 TEST PROCEDURE

The transmitter output was connected to the spectrum analyzer through an attenuator. The bandwidth of the fundamental frequency was measured by spectrum analyzer with 100 kHz RBW and 100kHz VBW. The 6dB bandwidth is defined as the total spectrum the power of which is higher than peak power minus 6dB.

4.3.4 DEVIATION FROM TEST STANDARD

No deviation

4.3.5 TEST SETUP

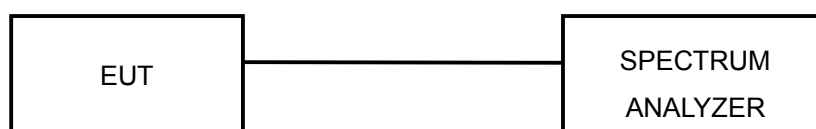

For the actual test configuration, please refer to the related Item – Photographs of the Test Configuration.

4.3.6 EUT OPERATING CONDITIONS

The software provided by client to enable the EUT under transmission condition continuously at lowest, middle and highest channel frequencies individually.

4.3.7 TEST RESULTS

802.11b DSSS MODULATION

MODULATION TYPE	DBPSK	TRANSFER RATE	1Mbps
INPUT POWER (SYSTEM)	120Vac, 60 Hz	ENVIRONMENTAL CONDITIONS	26deg.C, 66%RH, 991hPa
TESTED BY	Long Chen		

CHANNEL	CHANNEL FREQUENCY (MHz)	6dB BANDWIDTH (MHz)	MINIMUM LIMIT (MHz)	PASS/FAIL
1	2412	10.00	0.5	PASS
6	2437	10.08	0.5	PASS
11	2462	10.00	0.5	PASS

CH1

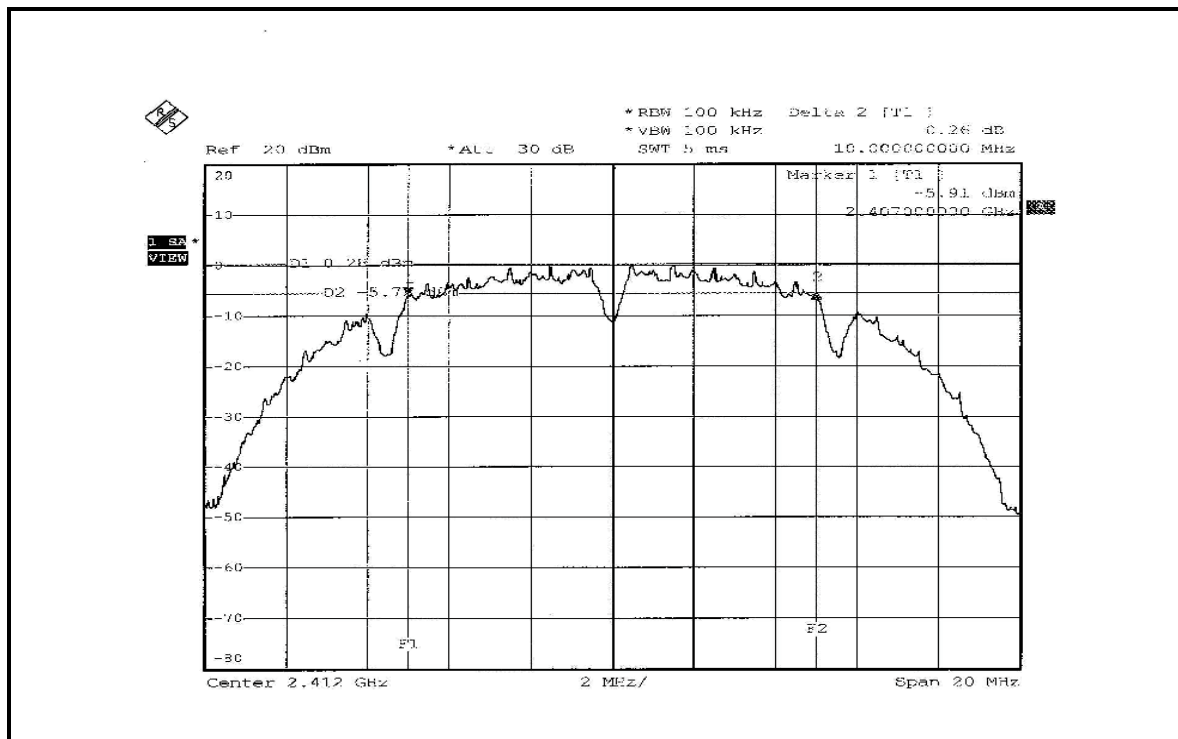

CH6

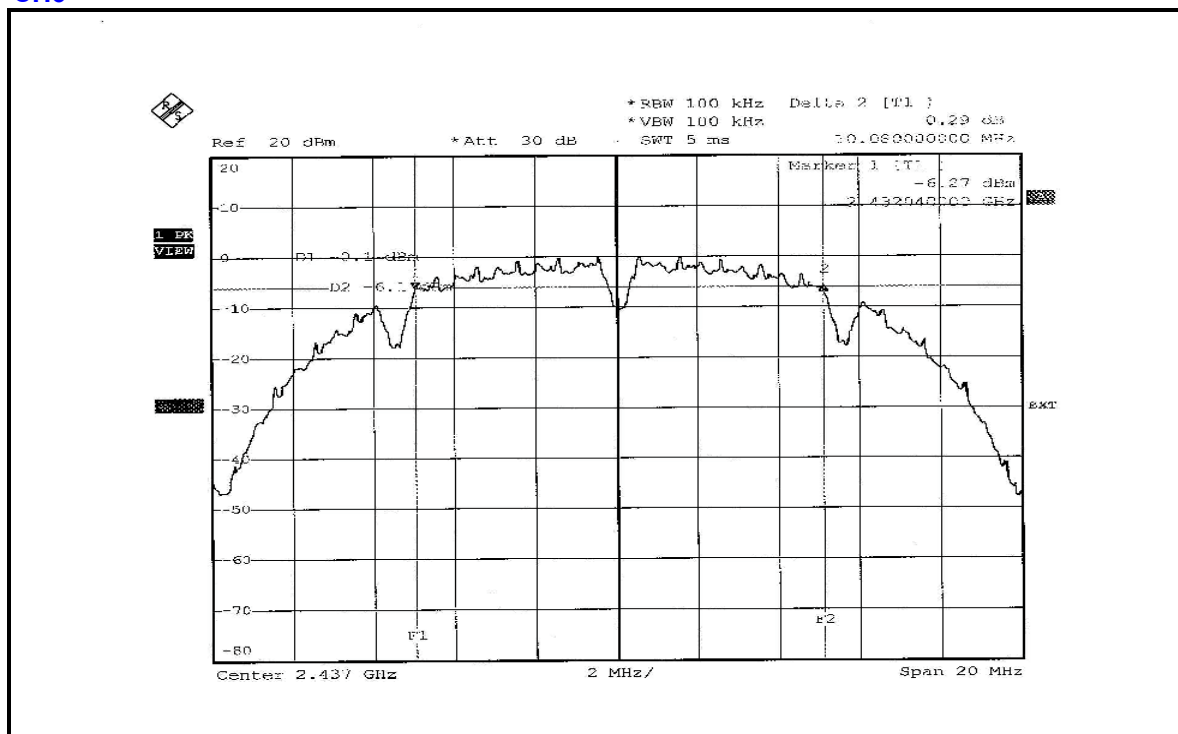

CH11

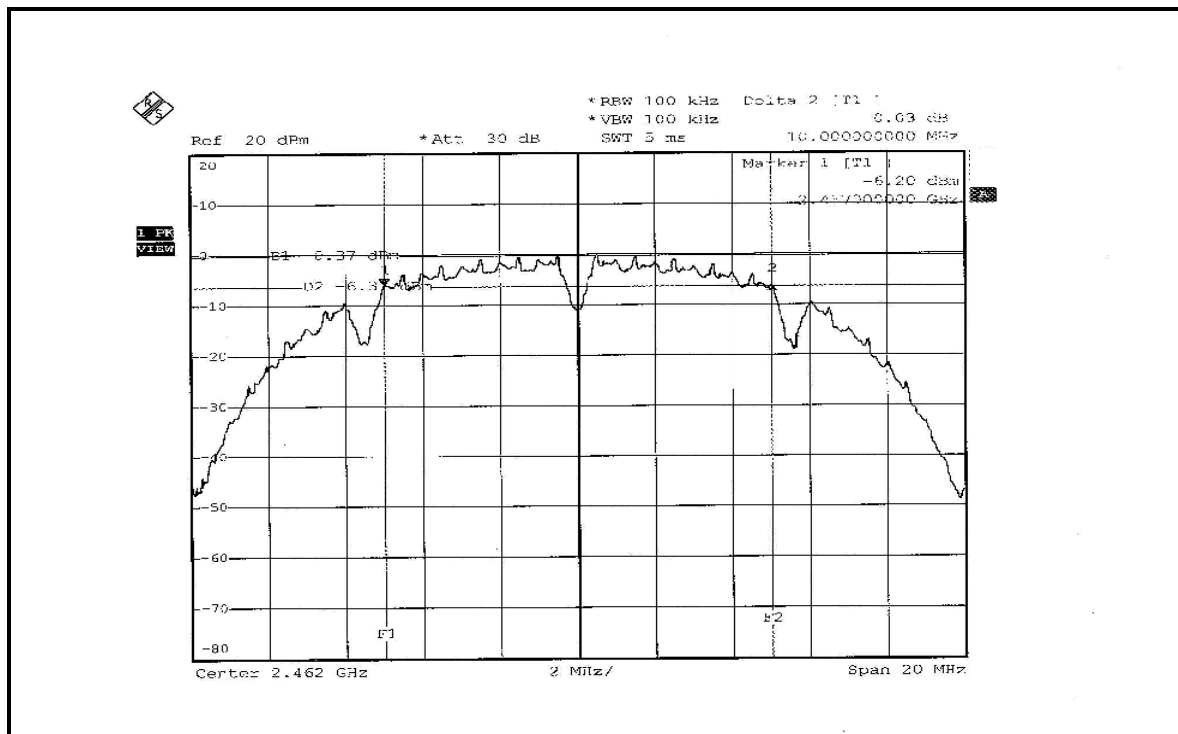



802.11g OFDM MODULATION

MODULATION TYPE	BPSK	TRANSFER RATE	6Mbps
INPUT POWER (SYSTEM)	120Vac, 60 Hz	ENVIRONMENTAL CONDITIONS	26deg.C, 66%RH, 991hPa
TESTED BY	Long Chen		

CHANNEL	CHANNEL FREQUENCY (MHz)	6dB BANDWIDTH (MHz)	MINIMUM LIMIT (MHz)	PASS/FAIL
1	2412	16.56	0.5	PASS
6	2437	16.52	0.5	PASS
11	2462	16.56	0.5	PASS

CH1

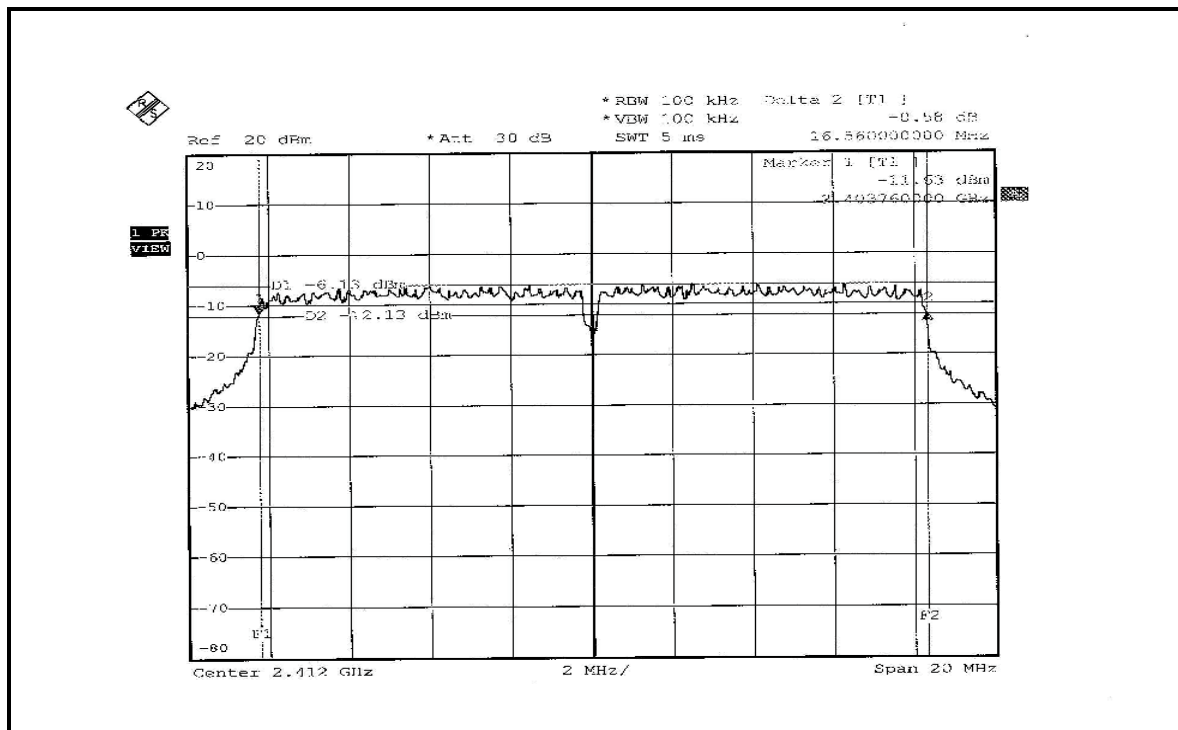

CH6

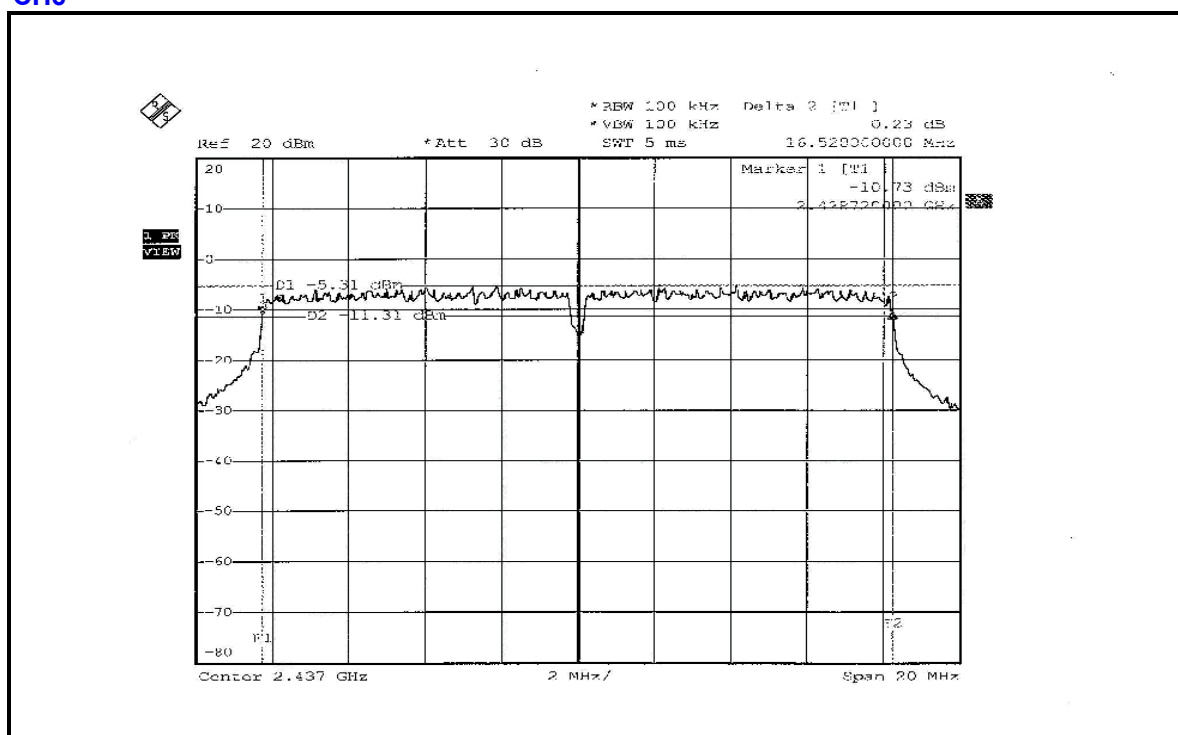

CH11

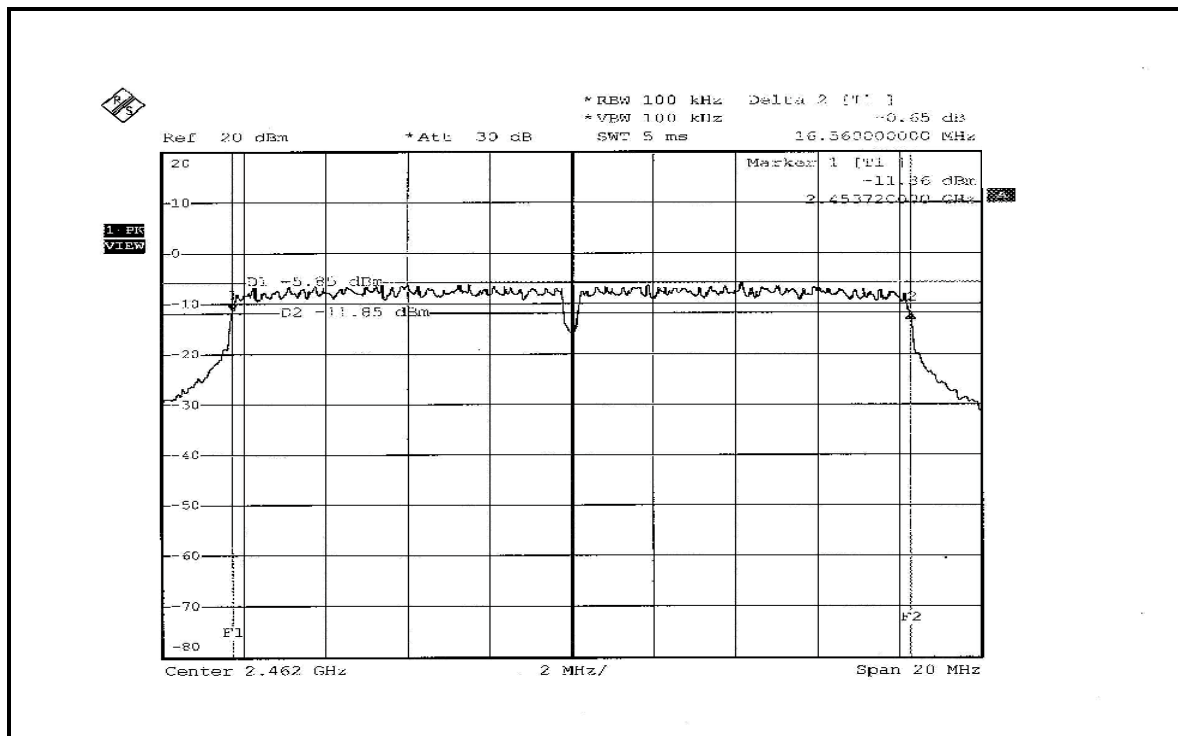



4.4 MAXIMUM PEAK OUTPUT POWER

4.4.1 LIMITS OF MAXIMUM PEAK OUTPUT POWER MEASUREMENT

The Maximum Peak Output Power Measurement is 30dBm.

4.4.2 TEST INSTRUMENTS

DESCRIPTION & MANUFACTURER	MODEL NO.	SERIAL NO.	CALIBRATED UNTIL
SPECTRUM ANALYZER	FSP40	100040	Jun. 07, 2007
AGILENT SIGNAL GENERATOR	E8257C	MY43320668	Dec. 07, 2006
DIGITAL RT OSCILLOSCOPE	TDS1012	C037299	Nov. 28, 2006
NARDA DETECTOR	4503A	FSCM99899	NA

NOTE: The calibration interval of the above test instruments is 12 months and the calibrations are traceable to NML/ROC and NIST/USA.

4.4.3 TEST PROCEDURES

1. A detector was used on the output port of the EUT. An oscilloscope was used to peak the response of the detector.
2. Replaced the EUT by the signal generator. The center frequency of the S.G was adjusted to the center frequency of the measured channel.
3. Adjusted the power to have the same peak reading on oscilloscope. Record the power level.

4.4.4 DEVIATION FROM TEST STANDARD

No deviation

4.4.5 TEST SETUP



4.4.6 EUT OPERATING CONDITIONS

Same as Item 4.3.6



4.4.7 TEST RESULTS

802.11b DSSS MODULATION

MODULATION TYPE	DBPSK	TRANSFER RATE	1Mbps
INPUT POWER (SYSTEM)	120Vac, 60 Hz	ENVIRONMENTAL CONDITIONS	26deg.C, 66%RH, 991hPa
TESTED BY	Long Chen		

CHANNEL	CHANNEL FREQUENCY (MHz)	PEAK POWER OUTPUT (mW)	PEAK POWER OUTPUT (dBm)	PEAK POWER LIMIT (dBm)	PASS/FAIL
1	2412	22.439	13.51	30	PASS
6	2437	19.953	13.00	30	PASS
11	2462	20.370	13.09	30	PASS

802.11g OFDM MODULATION

MODULATION TYPE	BPSK	TRANSFER RATE	6Mbps
INPUT POWER (SYSTEM)	120Vac, 60 Hz	ENVIRONMENTAL CONDITIONS	26deg.C, 66%RH, 991hPa
TESTED BY	Long Chen		

CHANNEL	CHANNEL FREQUENCY (MHz)	PEAK POWER OUTPUT (mW)	PEAK POWER OUTPUT (dBm)	PEAK POWER LIMIT (dBm)	PASS/FAIL
1	2412	40.179	16.04	30	PASS
6	2437	45.082	16.54	30	PASS
11	2462	40.087	16.03	30	PASS



4.5 POWER SPECTRAL DENSITY MEASUREMENT

4.5.1 LIMITS OF POWER SPECTRAL DENSITY MEASUREMENT

The Maximum of Power Spectral Density Measurement is 8dBm.

4.5.2 TEST INSTRUMENTS

DESCRIPTION & MANUFACTURER	MODEL NO.	SERIAL NO.	CALIBRATED UNTIL
SPECTRUM ANALYZER	FSP40	100040	Jun. 07, 2007

NOTE: The calibration interval of the above test instruments is 12 months and the calibrations are traceable to NML/ROC and NIST/USA.

4.5.3 TEST PROCEDURE

The transmitter output was connected to the spectrum analyzer through an attenuator, the bandwidth of the fundamental frequency was measured with the spectrum analyzer using 3kHz RBW and 30kHz VBW, set sweep time=span/3kHz. The power spectral density was measured and recorded. The sweep time is allowed to be longer than span/3kHz for a full response of the mixer in the spectrum analyzer.

4.5.4 DEVIATION FROM TEST STANDARD

No deviation

4.5.5 TEST SETUP

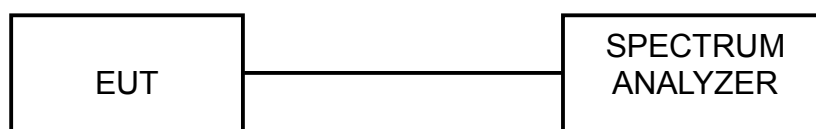

4.5.6 EUT OPERATING CONDITIONS

Same as 4.3.6



4.5.7 TEST RESULTS

802.11b DSSS MODULATION

MODULATION TYPE	DBPSK	TRANSFER RATE	1Mbps
INPUT POWER (SYSTEM)	120Vac, 60 Hz	ENVIRONMENTAL CONDITIONS	26deg.C, 66%RH, 991hPa
TESTED BY	Long Chen		

CHANNEL	CHANNEL FREQUENCY (MHz)	RF POWER LEVEL IN 3 kHz BW (dBm)	MAXIMUM LIMIT (dBm)	PASS/FAIL
1	2412	-16.72	8	PASS
6	2437	-17.28	8	PASS
11	2462	-17.46	8	PASS

CH11

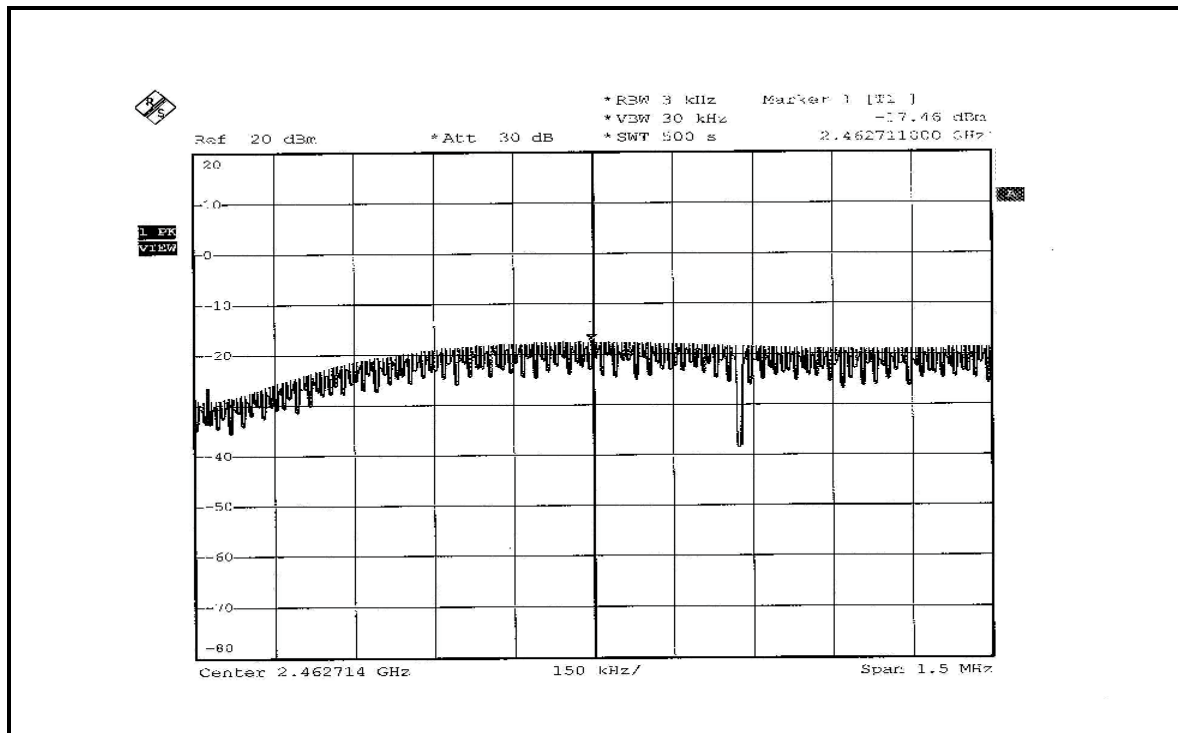

802.11g OFDM MODULATION

MODULATION TYPE	BPSK	TRANSFER RATE	6Mbps
INPUT POWER (SYSTEM)	120Vac, 60 Hz	ENVIRONMENTAL CONDITIONS	26deg.C, 66%RH, 991hPa
TESTED BY	Long Chen		

CHANNEL	CHANNEL FREQUENCY (MHz)	RF POWER LEVEL IN 3 kHz BW (dBm)	MAXIMUM LIMIT (dBm)	PASS/FAIL
1	2412	-19.75	8	PASS
6	2437	-19.15	8	PASS
11	2462	-19.77	8	PASS

CH1

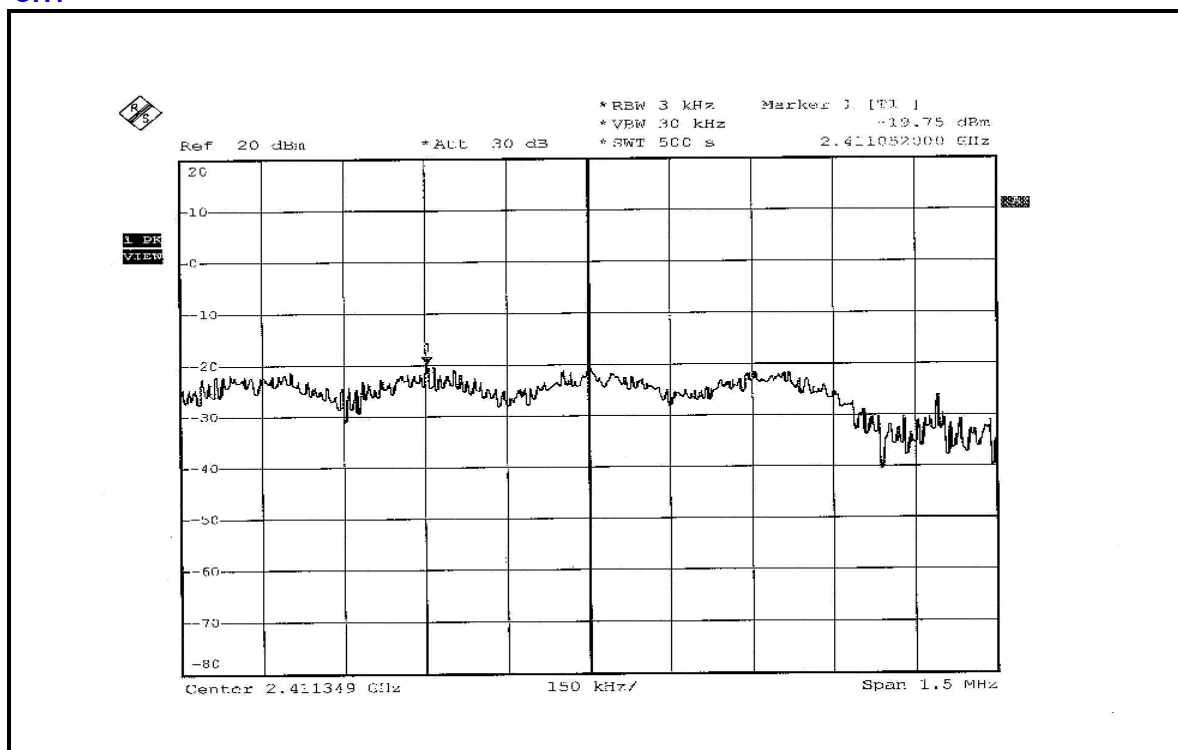

CH6

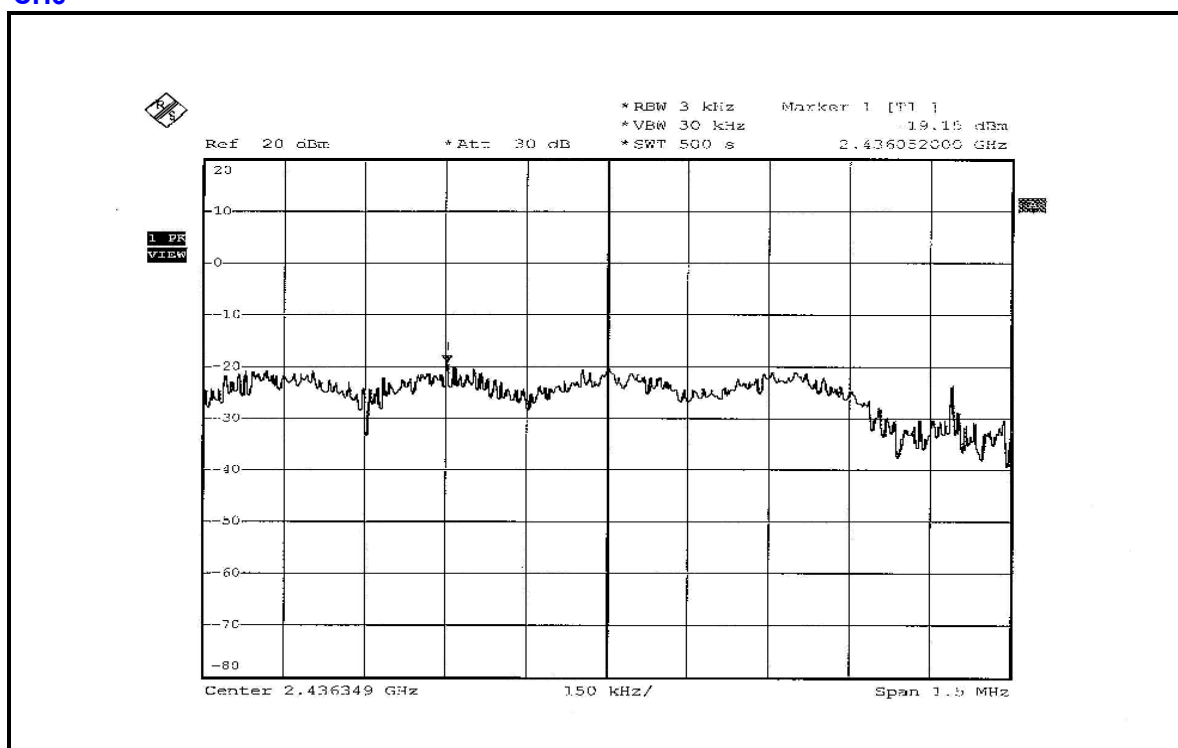

4.6 BAND EDGES MEASUREMENT

4.6.1 LIMITS OF BAND EDGES MEASUREMENT

Below -20dB of the highest emission level of operating band (in 100kHz Resolution Bandwidth).

4.6.2 TEST INSTRUMENTS

DESCRIPTION & MANUFACTURER	MODEL NO.	SERIAL NO.	CALIBRATED UNTIL
SPECTRUM ANALYZER	FSP40	100040	Jun. 07, 2007

NOTE: The calibration interval of the above test instruments is 12 months and the calibrations are traceable to NML/ROC and NIST/USA.

4.6.3 TEST PROCEDURE

The transmitter output was connected to the spectrum analyzer via a low lose cable. Set both RBW and VBW of spectrum analyzer to 100kHz with suitable frequency span including 100MHz bandwidth from band edge. The band edges was measured and recorded. The spectrum plots (Peak RBW=VBW=100kHz; Average RBW=1MHz, VBW=10Hz) are attached on the following pages.

4.6.4 DEVIATION FROM TEST STANDARD

No deviation

4.6.5 EUT OPERATING CONDITION

Same as Item 4.3.6

4.6.6 TEST RESULTS

The spectrum plots are attached on the following 12 images. D1 line indicates the highest level, and D2 line indicates the 20dB offset below D1. It shows compliance with the requirement in part 15.247(d).

802.11b DSSS MODULATION

NOTE 1: The band edge emission plot of DSSS technique on the next page shows 48.50dBc between carrier maximum power and local maximum emission in restrict band (2.37320GHz). The emission of carrier strength list in the test result of channel 1 at the item 4.2.7 is 104.23dBuV/m (Peak), so the maximum field strength in restrict band is $104.23 - 48.50 = 55.73$ dBuV/m which is under 74dBuV/m limit.

The band edge emission plot of DSSS technique on the next page shows 59.32dBc between carrier maximum power and local maximum emission in restrict band (2.35992GHz). The emission of carrier strength list in the test result of channel 1 at the item 4.2.7 is 100.48dBuV/m (Average), so the maximum field strength in restrict band is $100.48 - 59.32 = 41.16$ dBuV/m which is under 54dBuV/m limit.

NOTE 2: The band edge emission plot of DSSS technique on the next second page shows 49.48dBc between carrier maximum power and local maximum emission in restrict band (2.48710GHz). The emission of carrier strength list in the test result of channel 11 at the item 4.2.7 is 103.76dBuV/m (Peak), so the maximum field strength in restrict band is $103.76 - 49.48 = 54.28$ dBuV/m which is under 74dBuV/m limit.

The band edge emission plot of DSSS technique on the next third page shows 59.48dBc between carrier maximum power and local maximum emission in restrict band (2.48350GHz). The emission of carrier strength list in the test result of channel 11 at the item 4.2.7 is 99.95dBuV/m (Average), so the maximum field strength in restrict band is $99.95 - 59.48 = 40.47$ dBuV/m which is under 54dBuV/m limit.

802.11b DSSS MODULATION

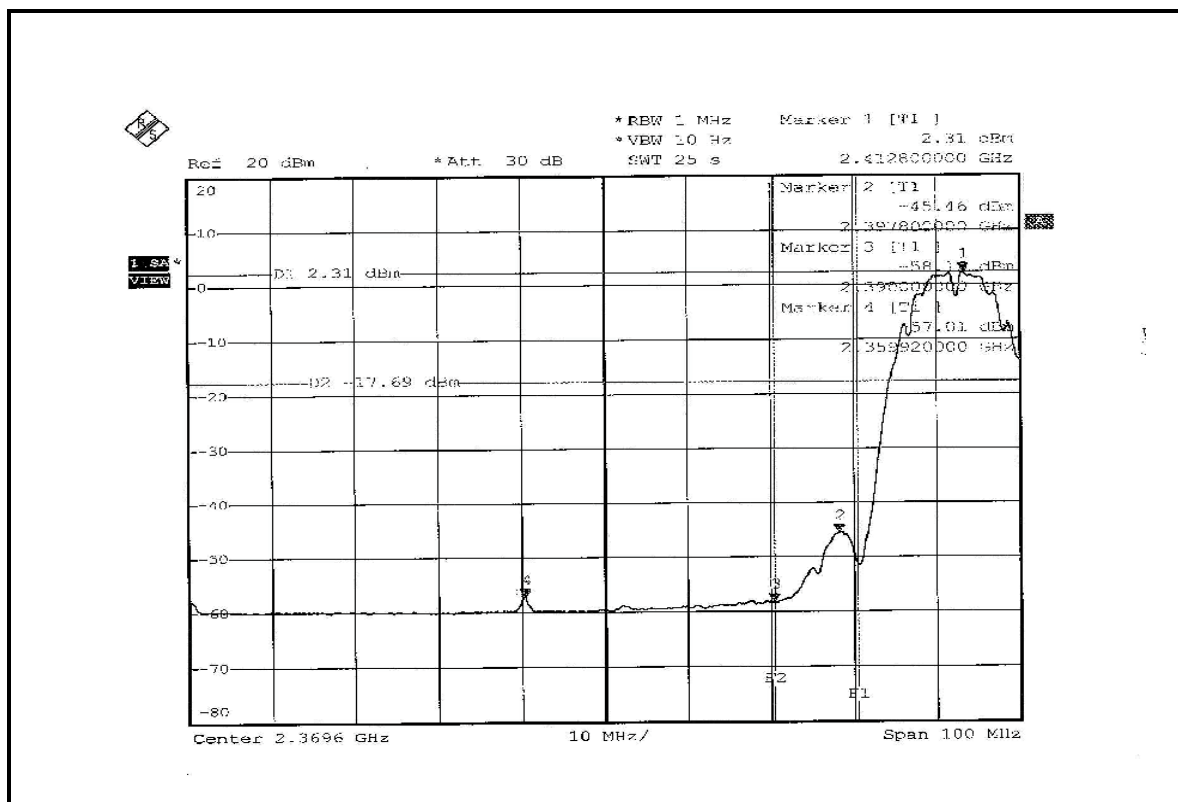
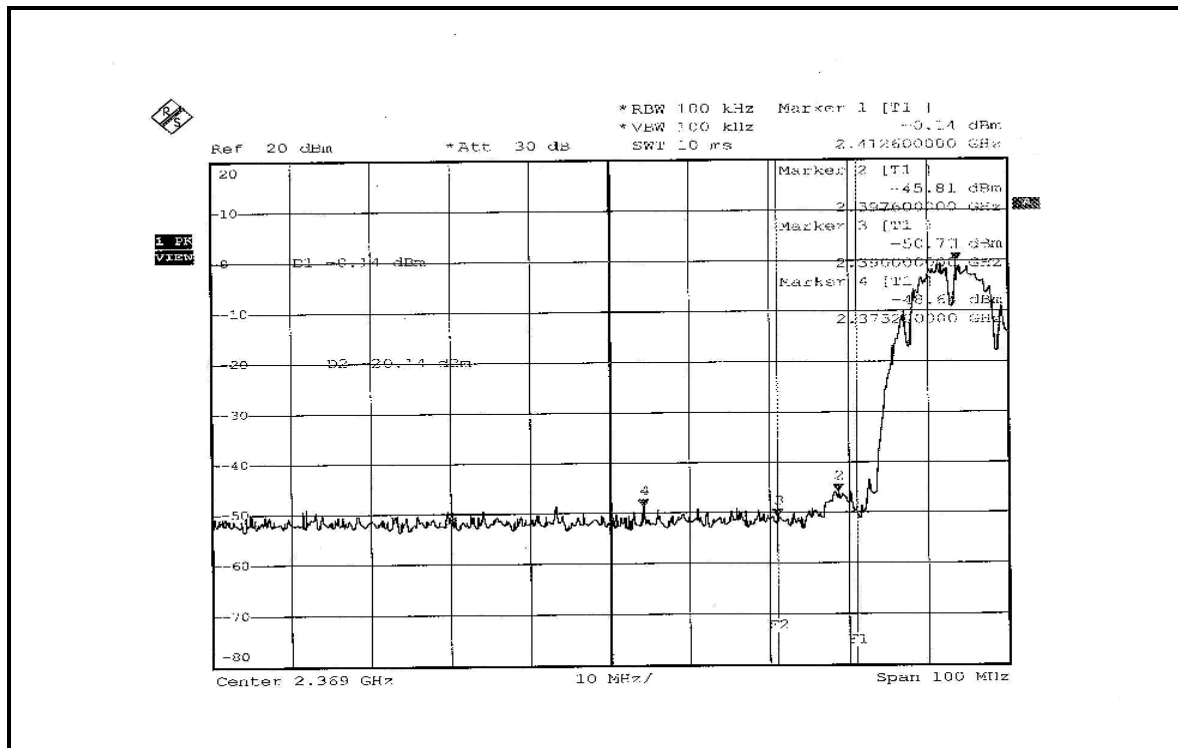

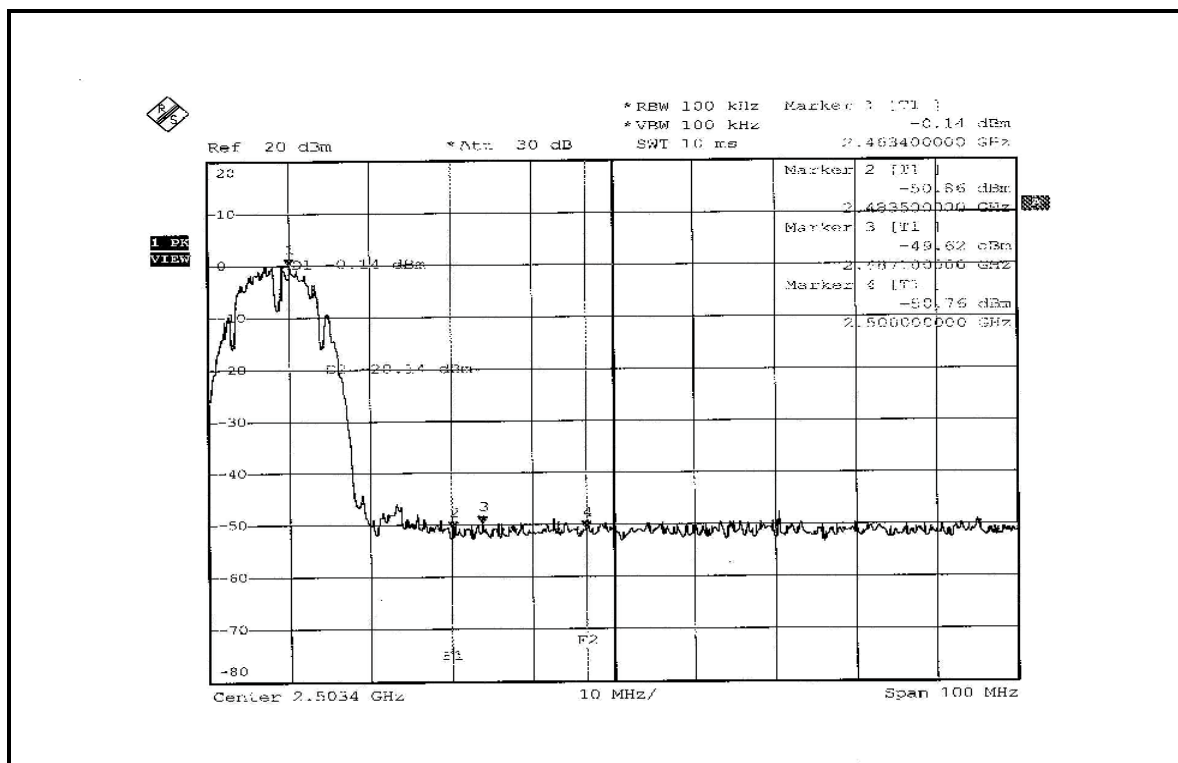
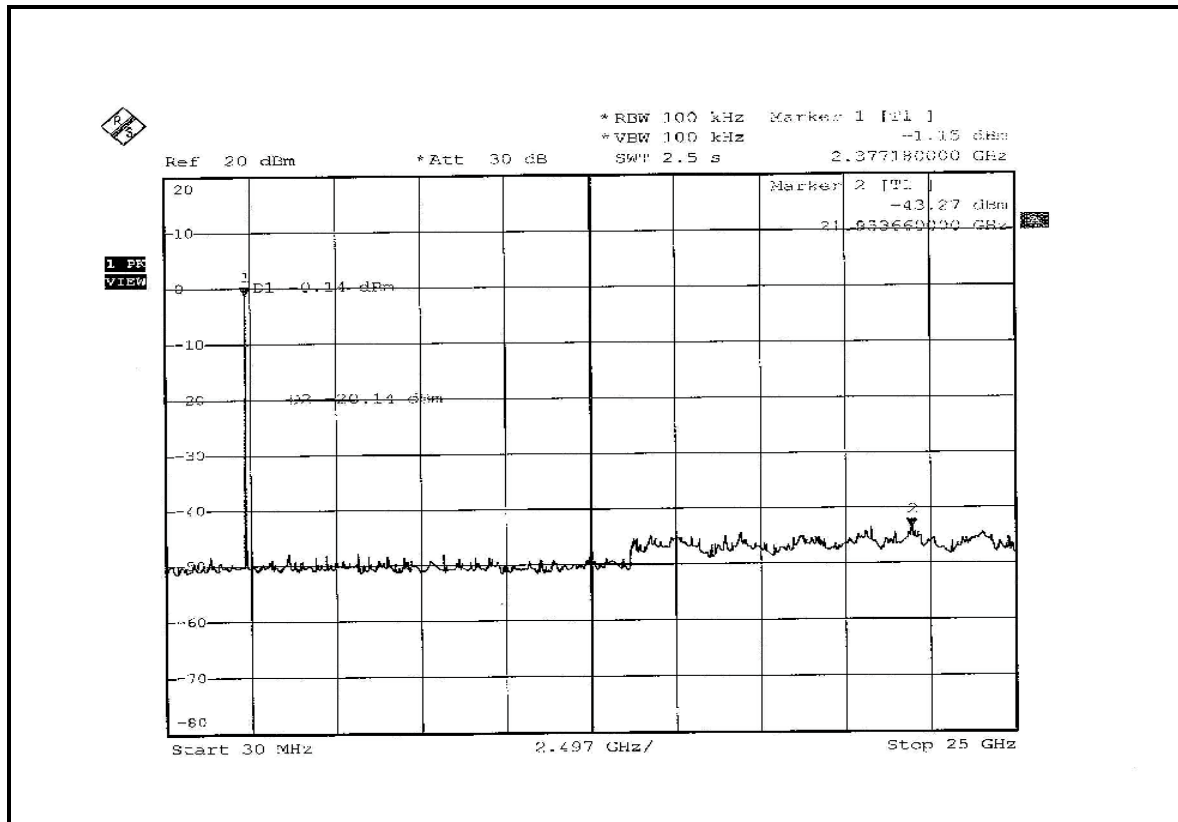

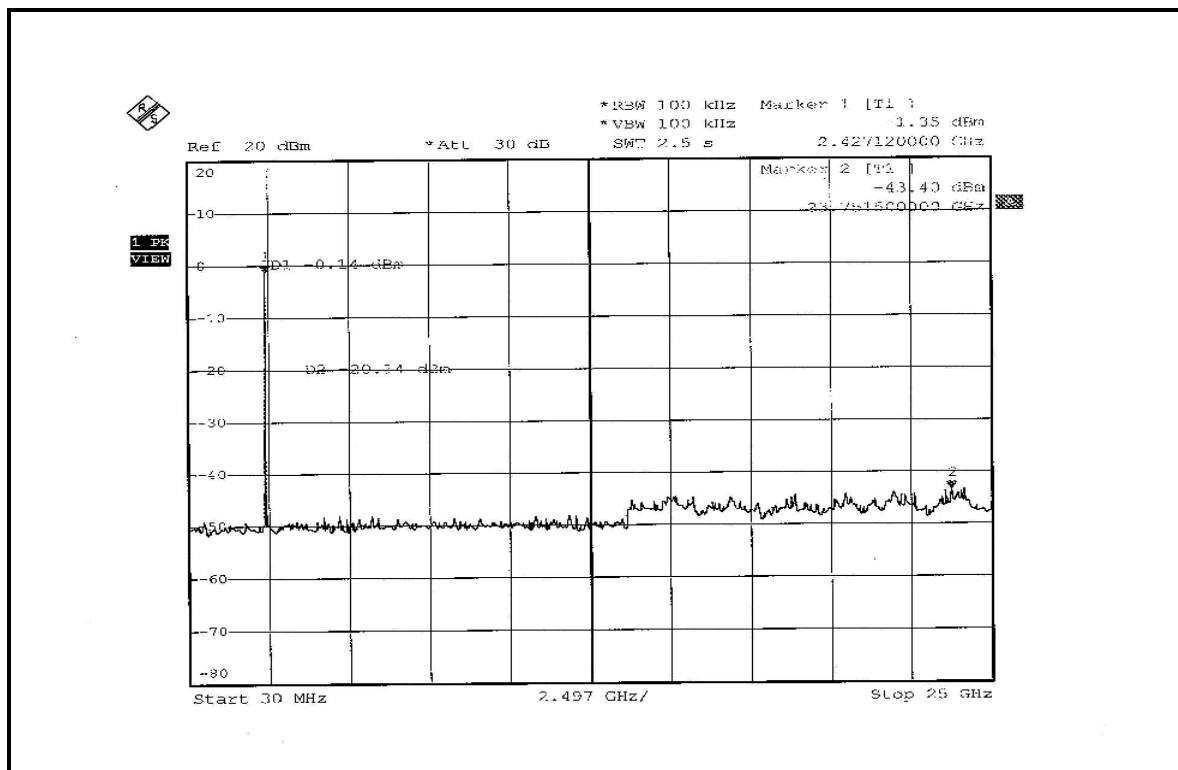
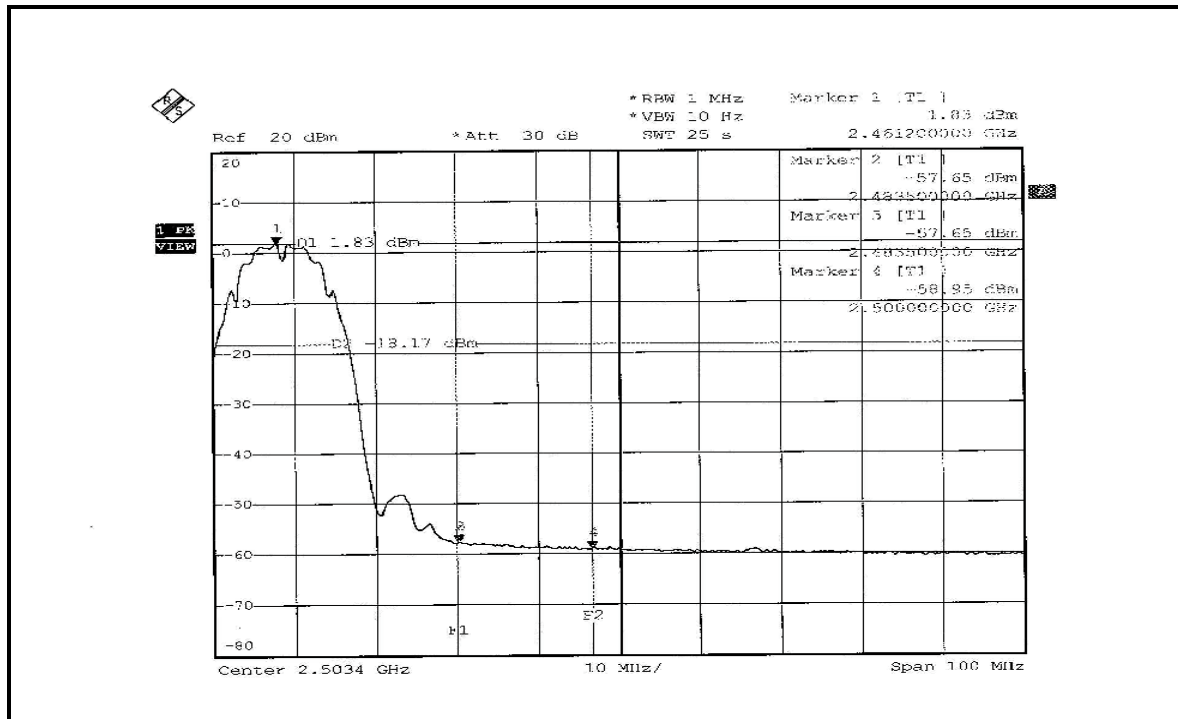

802.11g OFDM MODULATION

NOTE 1: The band edge emission plot of OFDM technique on the next page shows 42.81dBc between carrier maximum power and local maximum emission in restrict band (2.35340GHz). The emission of carrier strength list in the test result of channel 1 at the item 4.2.7 is 104.85dBuV/m (Peak), so the maximum field strength in restrict band is $104.85 - 42.81 = 62.04$ dBuV/m which is under 74dBuV/m limit.

The band edge emission plot of OFDM technique on the next page shows 51.87dBc between carrier maximum power and local maximum emission in restrict band (2.36000GHz). The emission of carrier strength list in the test result of channel 1 at the item 4.2.7 is 95.85dBuV/m (Average), so the maximum field strength in restrict band is $95.85 - 51.87 = 43.98$ dBuV/m which is under 54dBuV/m limit.

NOTE 2: The band edge emission plot of OFDM technique on the next second page shows 43.66dBc between carrier maximum power and local maximum emission in restrict band (2.48350GHz). The emission of carrier strength list in the test result of channel 11 at the item 4.2.7 is 104.53dBuV/m (Peak), so the maximum field strength in restrict band is $104.53 - 43.66 = 60.87$ dBuV/m which is under 74dBuV/m limit.

The band edge emission plot of OFDM technique on the next third page shows 52.15dBc between carrier maximum power and local maximum emission in restrict band (2.48350GHz). The emission of carrier strength list in the test result of channel 11 at the item 4.2.7 is 95.24dBuV/m (Average), so the maximum field strength in restrict band is $95.24 - 52.15 = 43.09$ dBuV/m which is under 54dBuV/m limit.

802.11g OFDM MODULATION

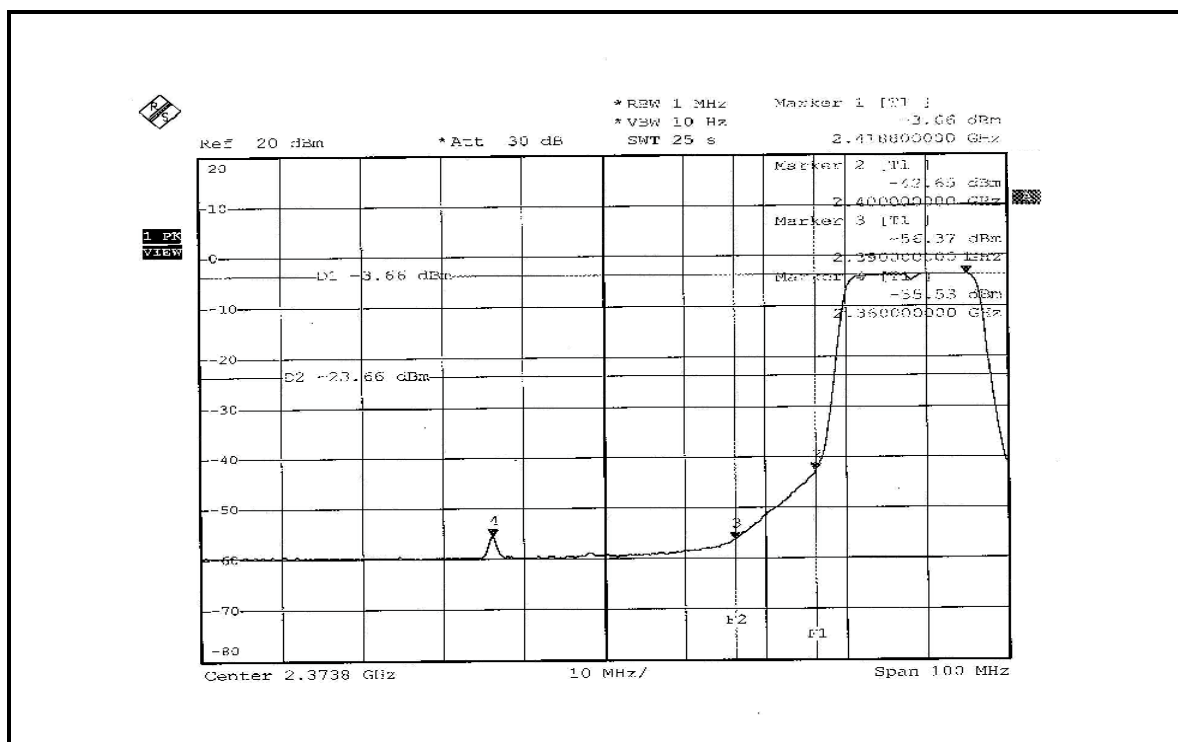
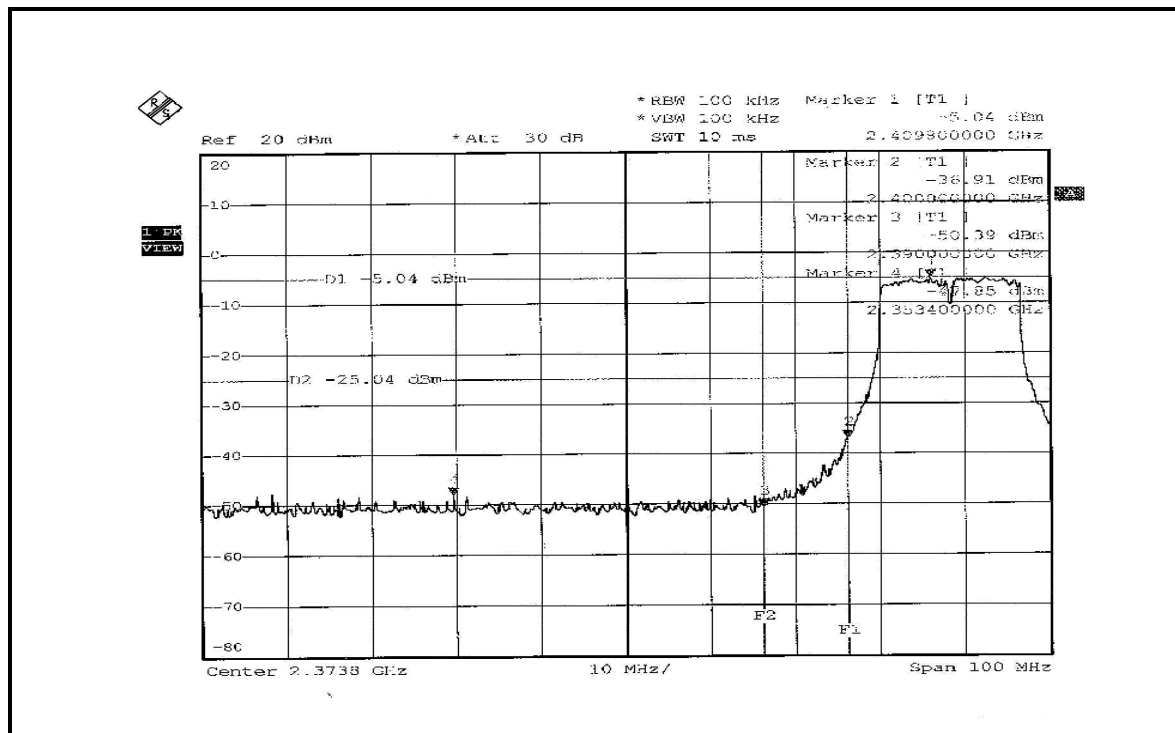

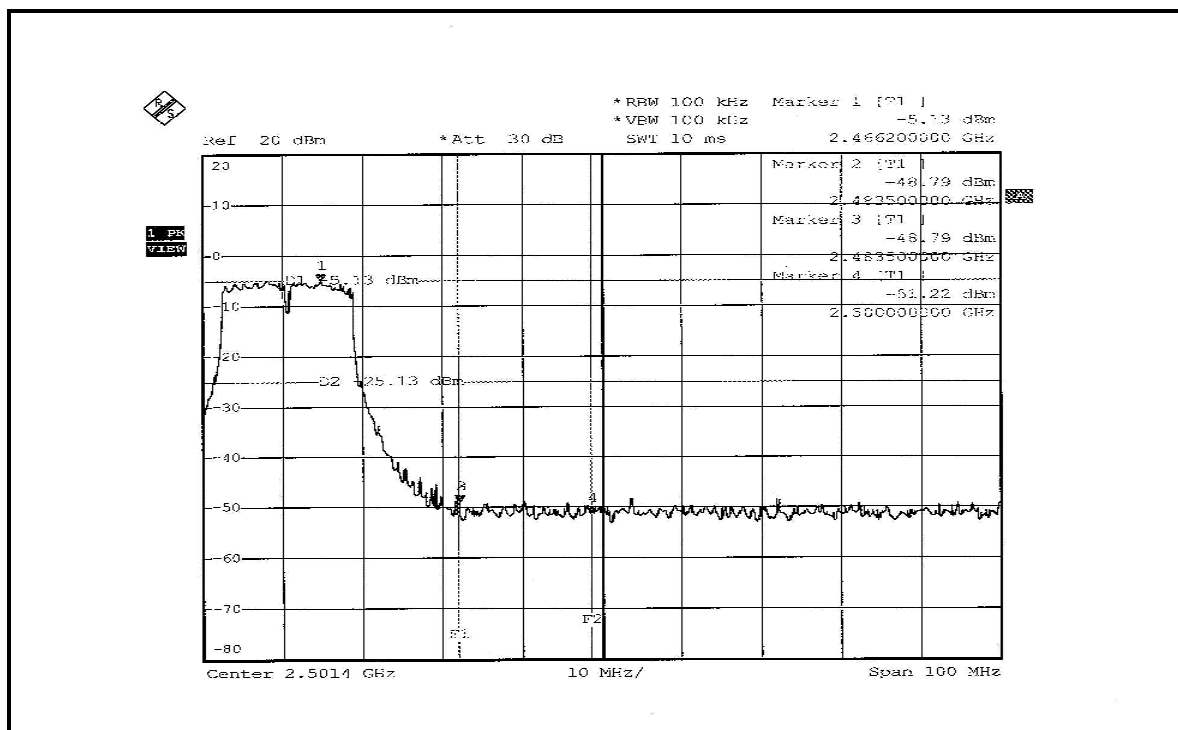
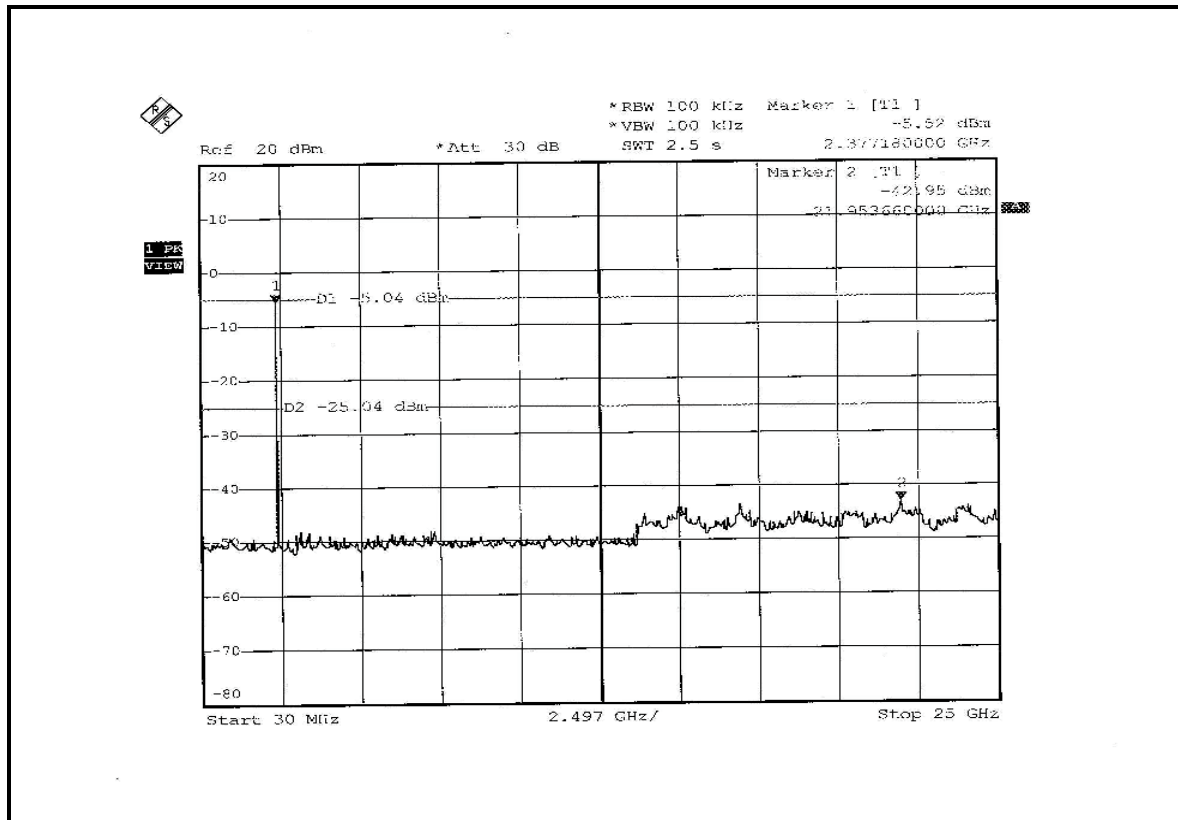

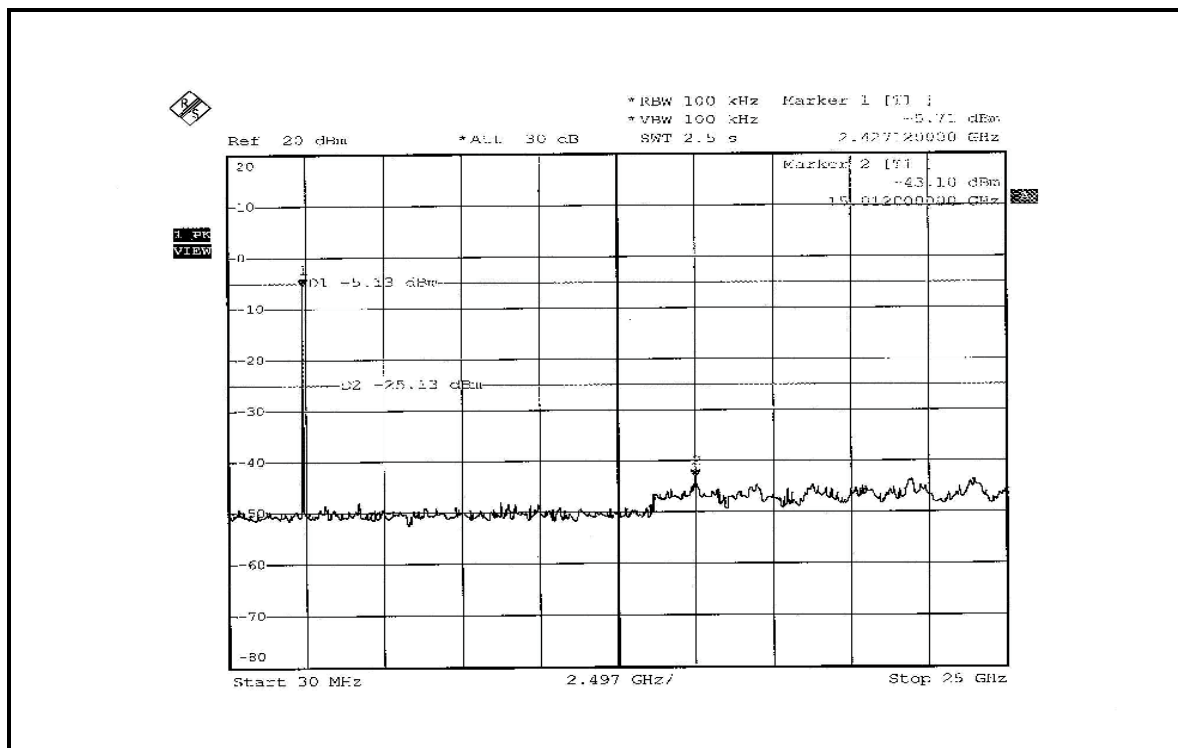
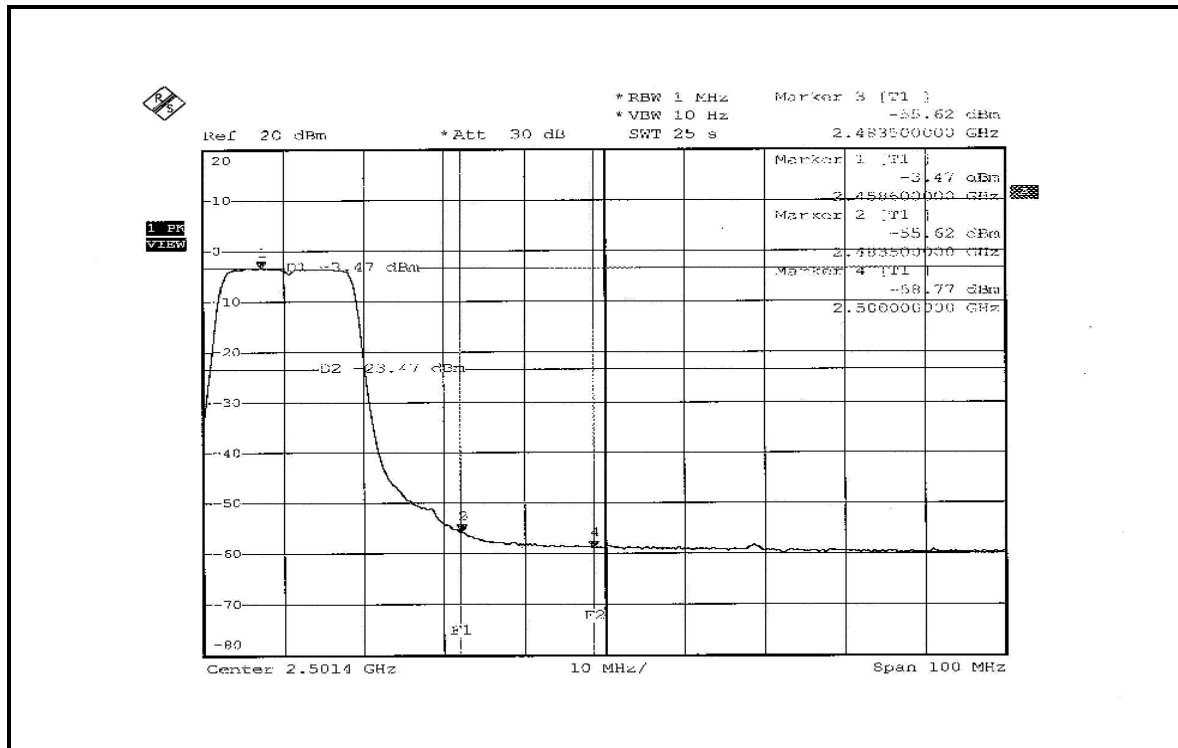



4.7 ANTENNA REQUIREMENT

4.7.1 STANDARD APPLICABLE

For intentional device, according to FCC 47 CFR Section 15.203, an intentional radiator shall be designed to ensure that no antenna other than that furnished by the responsible party shall be used with the device.

And according to FCC 47 CFR Section 15.247 (b), if transmitting antennas of directional gain greater than 6dBi are used, the power shall be reduced by the amount in dB that the directional gain of the antenna exceeds 6dBi.

4.7.2 ANTENNA CONNECTED CONSTRUCTION

The antenna used in this product is PIFA antenna without antenna connector. The maximum Gain of the antenna is 2.56dBi.



5 INFORMATION ON THE TESTING LABORATORIES

We, ADT Corp., were founded in 1988 to provide our best service in EMC, Radio, Telecom and Safety consultation. Our laboratories are accredited and approved by the following approval agencies according to ISO/IEC 17025

USA	FCC, UL, A2LA
Germany	TUV Rheinland
Japan	VCCI
Norway	NEMKO
Canada	INDUSTRY CANADA , CSA
R.O.C.	CNLA, BSMI, DGT
Netherlands	Telefication
Singapore	PSB , GOST-ASIA(MOU)
Russia	CERTIS(MOU)

Copies of accreditation certificates of our laboratories obtained from approval agencies can be downloaded from our web site:

www.adt.com.tw/index.5/phtml. If you have any comments, please feel free to contact us at the following:

Linko EMC/RF Lab:

Tel: 886-2-26052180

Fax: 886-2-26051924

Hsin Chu EMC/RF Lab:

Tel: 886-3-5935343

Fax: 886-3-5935342

Hwa Ya EMC/RF/Safety/Telecom Lab:

Tel: 886-3-3183232

Fax: 886-3-3185050

Web Site: www.adt.com.tw

The address and road map of all our labs can be found in our web site also.



APPENDIX-A

MODIFICATIONS RECORDERS FOR ENGINEERING CHANGES TO THE EUT BY THE LAB

No any modifications are made to the EUT by the lab during the test.