

# MEASUREMENT REPORT of *Wireless USB Adapter*

**Applicant** : CAMEO COMMUNICATIONS, INC.  
**EUT** : 802.11g Wireless USB Adapter  
**Model** : as Appendix A  
**FCC ID** : NHPWLG1500  
**Report No.** : C5115221

Tested by :

***Training Research Co., Ltd.***

**TEL : 886-2-26935155**

**FAX : 886-2-26934440**

No. 255, Nanyang Street, Shijr, Taipei Hsien 221, Taiwan, R.O.C.

# CERTIFICATION

**We here by verify that:**

The test data, data evaluation, test procedures and equipment configurations shown in this report were made mainly in accordance with the procedures given in ANSI C63.4 (2003) as a reference. All test were conducted by *Training Research Co., Ltd.*, 255 Nanyang Street, Shijr, Taipei Hsien 221, Taiwan, R.O.C. Also, we attest to the accuracy of each.

We further submit that the energy emitted by the sample EUT tested as described in the report is **in compliance with** the technical requirements set forth in the FCC Rules Part 15 Subpart B (Declaration of Conformity) and C Section 15.247.

**Applicant** : CAMEO COMMUNICATIONS, INC.  
**Applicant address** : 6F, No.22, Chung Shin Rd., Hsi-Chih, Taipei 221, Taiwan  
**Product Name** : 802.11g Wireless USB Adapter  
**Model Name** : as Appendix A  
**FCC ID** : NHPWLG1500  
**Report No.** : C5115221  
**Test Date** : November 1, 2004

Prepared by:

  
Jack Tsai

Approved by:

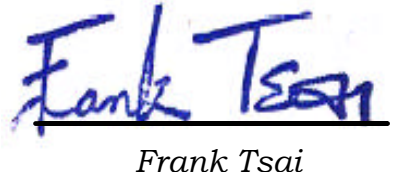
  
Frank Tsai**Conditions of issue :**

- (1) **This test report shall not be reproduced except in full, without written approval of TRC. And the test result contained within this report only relate to the sample submitted for testing.**
- (2) **This report must not be used by the client to claim product endorsement by NVLAP or any agency of U.S. Government.**
- (3) **This test report, measurements made by TRC are traceable to the NIST only Conducted and Radiated Method.**

★ NVLAP LAB CODE: 200174-0

## *Federal Communications Commission* **Declaration of Conformity** **(DoC)**

*For the Following Equipment:*

**Product name** : 802.11g Wireless USB Adapter  
**Model name** : as Appendix A  
**Trade name** : as Appendix A

Is herewith confirmed and found to comply with the requirements of CFR 47 part15 Subpart B - Unintentional Radiators regulation. The results of electromagnetic mission evaluation are shown in the report number : C5115221

This device complies with Part 15 of the FCC Rules. Operation is subject to the following two conditions:

- (1) This device may not cause harmful interference, and
- (2) This device must accept any interference received, including interference that may cause undesired operation

<i>Manufacturer</i>	<i>USA local representative</i>
Company name: CAMEO Communications, Inc.	To be determined
Computer address: 6F, No.22, Chung Shin Rd., Hsi-Chih, Taipei 221, Taiwan	
ZIP / Postal code 221	
Contact person: Jason Chang	
Title: Wireless Communications R&D Department Manager	
Internet e-mail address: jason_chang@mail.cameo.com.tw	
Tel / Fax: 886-2-26499800 / 886-2-26499984	

## ***Tables of Contents***

<b>I. GENERAL</b> .....	6
1.1 Introduction .....	6
1.2 Description of EUT .....	6
1.3 Test method .....	6
1.4 Description of Support Equipment .....	7
1.5 Configuration of System Under Test .....	9
1.6 Verify the Frequency and Channel .....	11
1.7 Test Procedure .....	12
1.8 Location of the Test Site .....	12
1.9 General Test Condition .....	12
<b>II. Section 15.101(a) : Equipment Authorization of Unintentional Radiators</b> .....	13
<b>III. Section 15.203 : Antenna Requirement</b> .....	14
<b>IV. Section 15.207 : Power Line Conducted Emissions for AC Powered Units</b> .....	15
4.1 Test Condition & Setup .....	15
4.2 List of Test Instruments .....	16
4.3 Test Result of Conducted Emissions .....	17
Standby mode .....	17
IEEE 802.11b .....	18
IEEE 802.11g .....	19
<b>V. Section 15.247(a) : Technical Description of the EUT</b> .....	21
<b>VI. Section 15.247(a)(2) : Bandwidth for Direct Sequence System</b> .....	22
6.1 Test Condition & Setup .....	22
6.2 Test Instruments Configuration .....	22
6.3 List of Test Instruments .....	22
6.4 Test Result of Bandwidth .....	23
Channel 01 .....	24
Channel 06 .....	25
Channel 11 .....	26

**VII. Section 15.247(b) : Power Output** ..... 27

    7.1 Test Condition & Setup ..... 27

    7.2 List of Test Instruments ..... 27

    7.3 Test Result ..... 27

**VIII. Section 15.247(c) : Spurious Emissions (Radiated)** ..... 28

    8.1 Test Condition & Setup ..... 28

    8.2 List of Test Instruments ..... 30

    8.3 Test Result of Spurious Radiated Emissions ..... 31

        Standby mode ..... 31

        IEEE 802.11b, CH01 ..... 33

        IEEE 802.11b, CH06 ..... 35

        IEEE 802.11b, CH11 ..... 37

        IEEE 802.11g, CH01 ..... 39

        IEEE 802.11g, CH06 ..... 41

        IEEE 802.11g, CH11 ..... 43

    8.4 Test Result of Bandedge ..... 45

        IEEE 802.11b ..... 46

        IEEE 802.11g ..... 48

**IX. Section 15.247(d) : Power Spectral Density** ..... 50

    9.1 Test Condition & Setup ..... 50

    9.2 Test Instruments Configuration ..... 50

    9.3 List of Test Instruments ..... 50

    9.4 Test Result of Power Spectral Density ..... 51

        Channel 01 ..... 52

        Channel 06 ..... 53

        Channel 11 ..... 54

**Appendix A: Brand name and Model name List**..... 55

## **I . GENERAL**

### **1.1 Introduction**

The following measurement report is submitted on behalf of applicant in support that the certification in accordance with Part 2 Subpart J and Part 15 Subpart A, B and C of the Commission's Rules and Regulations.

### **1.2 Description of EUT**

<b>Product Name</b>	:	802.11g Wireless USB Adapter
<b>Model Name</b>	:	as Appendix A
<b>FCC ID</b>	:	NHPWLG1500
<b>Frequency Range</b>	:	2.412 GHz ~ 2.462GHz
<b>Support Channel</b>	:	11 Channels
<b>Modulation Skill</b>	:	DBPSK, DQPSK, CCK, OFDM
<b>Power Type</b>	:	Power by USB interface of client' s device

### **1.3 Test method**

1. Insert the EUT into the USB port of the notebook computer.
2. Using the notebook computer and software provided by the manufacturer to control EUT. The software is operated under the Windows to control the EUT in the mode of continuous transmission; the test is performed under the specific conditions.
3. Set different channel and data rate being tested and repeat the procedures above.
  - (a) Radiated for Intentional test:  
making EUT to the mode of continuous transmission
  - (b) Conducted and Radiated for Unintentional test:  
making EUT to the linking (RX/TX) mode with far support equipments

#### 1.4 Description of Support Equipment

In order to construct the minimum testing, following equipment were used as the support units.

- Notebook** : **IBM Think Pad X20**  
 Model No. : 2662-11T  
 Serial No. : FX-1192200/09  
 FCC ID : N/A, DoC Approved  
 檢磁 : 3892B565
- Adaptor** : **IBM**  
 Model No. : PA2450U  
 Serial No. : 02K6654  
 FCC ID : N/A, DoC Approved  
 Power type : I/P: 100 ~ 240vac, 50 ~ 60 Hz, 0.5A ~ 1.2A; O/P: 16Vdc, 4.5A  
 Power cord : Non-shielded, 1.80m long, Plastic, with ferrite core
- Fax/Modem** : **Aceex**  
 Model No. : DM-1414  
 Serial No. : 9010582  
 FCC ID : IFAXDM1414  
 Power type : Switching  
 Power Cord : Non-shielded, 1.90m long, Plastic hoods, and no ferrite bead  
 Data Cable : RS-232→Shielded, 1.30m long, Metal hoods , No bead  
 RJ-11Cx2→Non-shielded, 7' long, Plastic hoods, No bead
- Printer** : **HP**  
 Model No. : C6464A  
 Serial No. : TH16LEB5PK  
 FCC ID : N/A, DoC Approved  
 檢磁 : 3892H381  
 Power type : Switching adaptor  
 Power cord : Non-shielded, 173cm long, No ferrite core  
 (between adaptor and AC source)  
 Non-shielded, 180cm long, with ferrite core  
 (between printer and adaptor)  
 Data cable : Shielded, 1.70m long, No ferrite core

**USB Gamepad : Rockfire**  
Model No. : QF-337uv  
Serial No. : 10600545, KR91379759  
FCC ID : None (CE approval)  
檢磁 : 3862A574  
Power type : By computer  
Data Cable : Shielded, 1.81m long, Plastic, with ferrite core

**Mouse : HP**  
Model No. : M-S34  
Serial No. : LZB90910462  
FCC ID : DZL211029  
檢磁 : 4862A011  
Power type : By PC  
Power cord : Non-shielded, 1.88m long, No ferrite core

**Notebook : TWINHEAD**  
Model No. : N222S8  
Serial No. : SY3261000988  
FCC ID : N/A, DoC Approved  
檢磁 : 71001018

**Adaptor : LISHIN INTERNATIONAL ENTERPRISE CORP.**  
Model No. : LSE9802A2060  
Serial No. : A20231065818  
檢磁 : 3882B381  
Power type : I/P: 100 ~ 240Vac, 50/ 60 Hz, 1.5A ; O/P: 20Vdc, 3A 60W Max.  
Power cord : Non-shielded, 180cm length, No ferrite core  
(between adaptor and AC source)  
Non-shielded, 150cm length, with ferrite core  
(between NB and adaptor)

**WLAN Card : Gemtek Technology Co., Ltd.**  
Model No. : C911003  
FCC ID : MXF-C911003



## 1.5 Configuration of System Under Test

### 1.5.1 Conducted Test

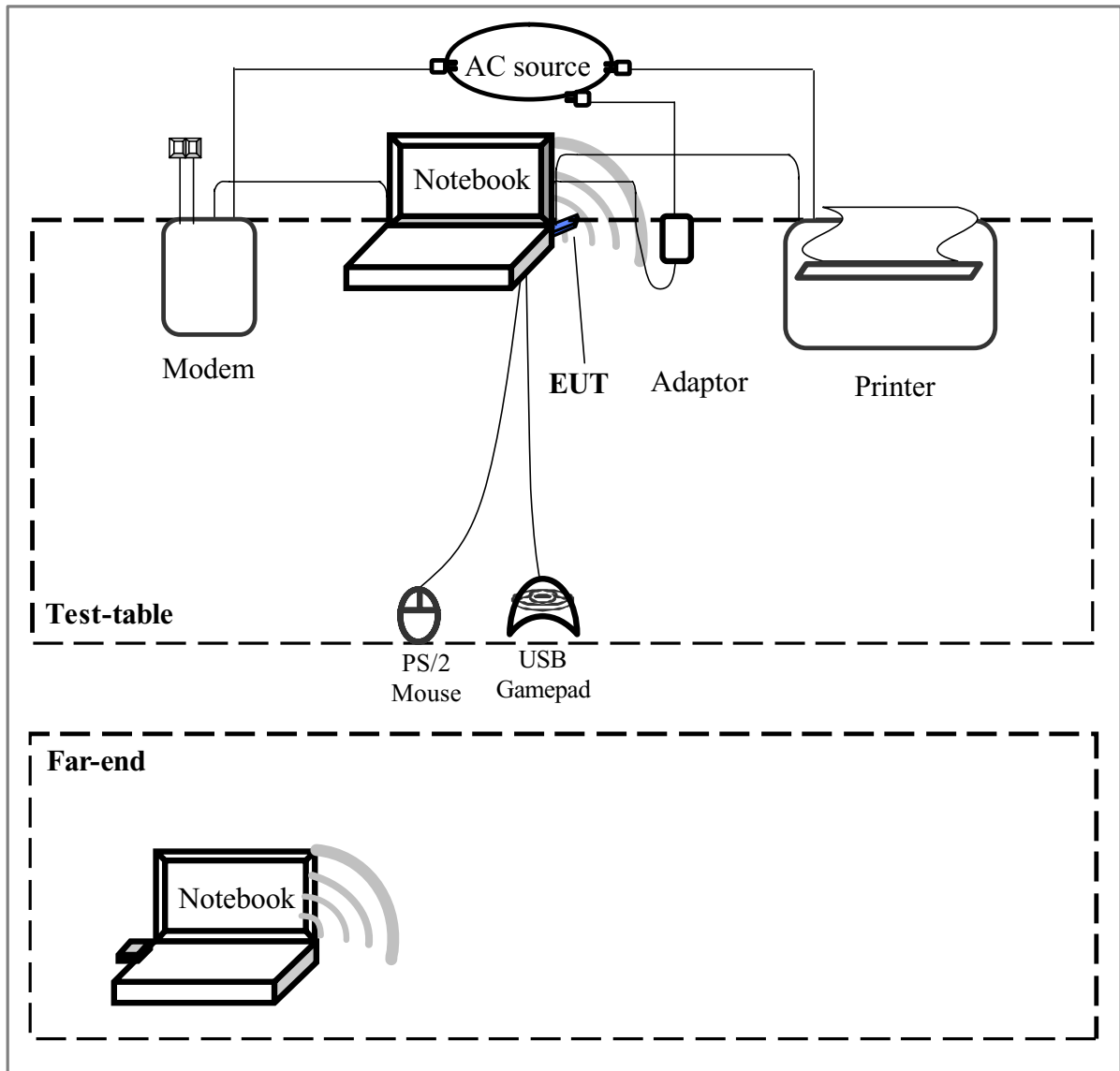

#### Connections of Computer:

- \*Parallel Port --- a printer
- \*Serial Port --- an external modem
- \*PS/2 Port --- a P/2 mouse
- \*USB Port --- a USB gamepad
- \*USB Port --- **EUT**

1.5.2 Radiated Test

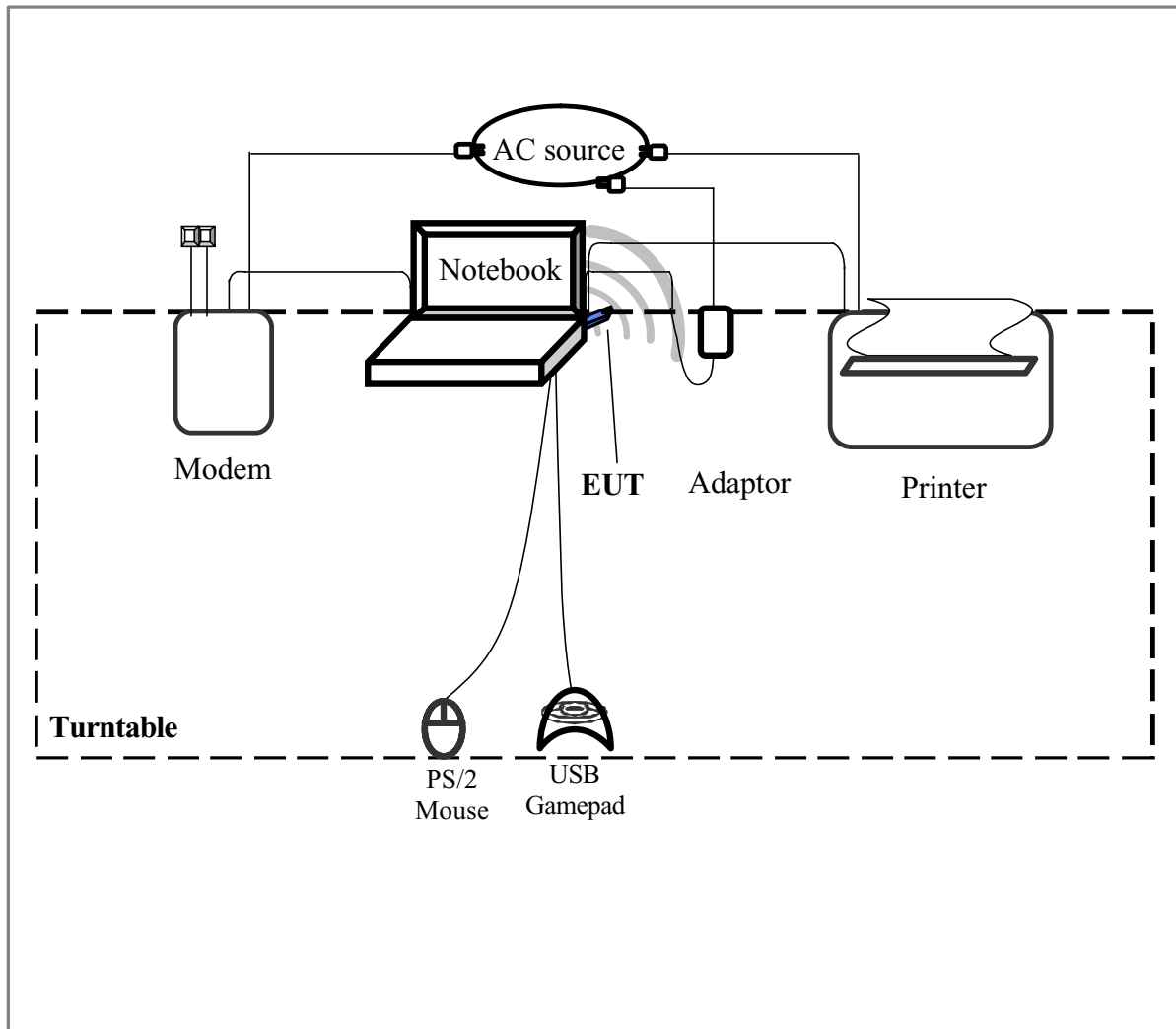

The tests below are carried with the EUT transmitter set at high power in TDD mode. The EUT is forced to select of output power level and channel number by notebook computer.

The setting up procedure was recorded in 1.3 test method.

## 1.6 Verify the Frequency and Channel

Channel	Frequency (GHz)
1	2.412
2	2.417
3	2.422
4	2.427
5	2.432
6	2.437
7	2.442
8	2.447
9	2.452
10	2.457
11	2.462

Note:

1. This is for confirming that all frequencies are in 2.412GHz to 2.462GHz.
2. Section 15.31(m): Measurements on intentional radiators or receivers shall be performed at three frequencies for operating frequency range over 10 MHz.  
(The locations of these frequencies one near the top, one near the middle and one near the bottom.)
3. After test, the EUT operating frequencies are in 2.412GHz to 2.462GHz. So all the items as followed in testing report are need to test these three frequencies:  
Top: Channel – 1; Middle: Channel – 6; Bottom: Channel – 11.

### **1.7 Test Procedure**

All measurements contained in this report were performed mainly according to the techniques described in ANSI C63.4 (2003) and the pre-setup was written on 1.3 test method, the detail setup was written on each test item.

### **1.8 Location of the Test Site**

The radiated emissions measurements required by the rules were performed on the **three-meter, Anechoic Chamber (FCC Registration Number: 93906)** maintained by *Training Research Co., Ltd.* 1F, No. 255 Nanyang Street, Shijr, Taipei Hsien 221, Taiwan, R.O.C. Complete description and measurement data have been placed on file with the commission. The conducted power line emissions tests and other test items were performed in a anechoic chamber also located at Training Research Co., Ltd.

No. 255 Nanyang Street, Shijr, Taipei Hsien 221, Taiwan, R.O.C. *Training Research Co., Ltd.* is listed by the FCC as a facility available to do measurement work for others on a contract basis.

### **1.9 General Test Condition**

The conditions under which the EUT operates were varied to determine their effect on the equipment's emission characteristics. The final configuration of the test system and the mode of operation used during these tests were chosen as that which produced the highest emission levels. However, only those conditions, which the EUT was considered likely to encounter in normal use were investigated.

In test, they were set in high power and continuously transmitting mode that controlled by computer. The ch01, ch06 and ch11 of EUT were all tested. The setting up procedure is recorded on 1.3 test method.

## **II. Section 15.101(a): Equipment authorization of unintentional radiators**

The EUT equipped with a USB interface and should be operated with the computer. It was categorized to *Class B personal computers and peripherals* as cannot be operated stand-alone. The authorization requires **Declaration of Conformity (DoC)** and the items required such as Sect.15.107 (Conducted limits) and Sect.15.109 (Radiated emission limits) is same as Sect.15.207 and 15.247(C).

### **III. Section 15.203: Antenna requirement**

The EUT has an integrated antenna permanently attached on the PCB, which inside the housing. In addition, there is no external antenna or connector employed. The antenna requirement stated in Sect.15.203 is inapplicable to this EUT.

The antenna specification of list as below:

Antenna Type : Patch Antenna  
Antenna Gain : 2.03dBi (Max.)

## **IV. Section 15.207: Power Line Conducted Emissions for AC Powered Units**

### **4.1 Test Condition & Setup**

The power line conducted emission measurements were performed in an anechoic chamber. The EUT was assembled on a wooden table, which is 80 centimeters high, was placed 40 centimeters from the backwall and at least 1 meter from the sidewall.

Power was fed to the EUT from the public utility power grid through a line filter and Line Impedance Stabilization Networks (LISNs). The LISN housing, measuring instrumentation case, ground plane, etc., were electrically bonded together at the same RF potential. The Spectrum analyzer (or EMI receiver) was connected to the AC line through an isolation transformer. The 50-ohm output of the LISN was connected to the spectrum analyzer directly. Conducted emission levels were in the CISPR quasi-peak and average detection mode. The analyzer's 6 dB bandwidth was set to 9KHz. No post-detector video filter was used.

The spectrum was scanned from 150KHz to 30MHz. The physical arrangement of the test system and associated cabling was varied (within the scope of arrangements likely to be encountered in actual use) to determine the effect on the unit's emanations in amplitude and frequency. All spurious emission frequencies were observed. The highest emission amplitudes relative to the appropriate limit were measured and have been recorded in paragraph <4.3>.

There is a test condition apply in this test item, the test procedure description as <1.3>. Three channels were tested, one in the top (CH01), one in the middle (CH06) and the other in bottom (CH11).

**4.2 List of Test Instruments**

<b>Instrument Name</b>	<b>Model</b>	<b>Brand</b>	<b>Serial No.</b>	<b>Calibration Date</b>
				<b>Next time</b>
EMI Receiver	8546A	HP	3520A00242	08/05/05
RF Filter Section	85460A	HP	3448A00217	08/05/05
LISN (EUT)	LISN-01	TRC	99-05	10/07/05
LISN (Support E.)	LISN-01	TRC	9912-03, 04	11/04/05
Pre-amplifier	15542 ZFL-500	Mini – Circuits	0 0117	05/20/05
6dB Attenuator	MCL BW-S6W2	Mini – Circuits	9915 – Conducted	05/20/05
10dB Attenuator	A5542 VAT010	Mini – Circuits	0215 – Conducted	05/20/05
Coaxial Cable (2 meter)	A30A30-0058-50FS-2M	Jyebao	SMA-08	05/20/05
Coaxial Cable (1.1 meter)	A30A30-0058-50FS-1M	Jyebao	SMA-09	05/20/05
Coaxial Cable (20 meter)	RG-214/U	Jyebao	NP-01	05/20/05
Coaxial Cable (20 meter)	RG-214/U	Jyebao	NP-02	05/20/05
Auto Switch Box (< 30MHz)	ASB-01	TRC	9904-01	05/20/05



**4.3 Test Result of Power Line Conducted Emissions**

**EUT station transmit only**

The following table shows a summary of the highest emissions of power line conducted emissions on the LIVE and NETURAL conductors of the EUT power cord. Show as follows.

Test Conditions: Temperature : 25 °C Humidity : 73 % RH

*Test mode: Standby mode*

<i>Power Connected Emissions</i>					<i>Class B</i>		
<i>Conductor</i>	<i>Frequency (KHz)</i>	<i>Peak (dBµV)</i>	<i>QP (dBµV)</i>	<i>Average (dBµV)</i>	<i>QP-limit (dBµV)</i>	<i>AVG-limit (dBµV)</i>	<i>Margin (dB)</i>
Line 1	274.000	42.76	---	---	62.46	52.46	-9.70
	370.000	42.51	---	---	59.71	49.71	-7.20
	485.000	38.58	---	---	56.43	46.43	-7.85
	604.000	38.30	---	---	56.00	46.00	-7.70
	724.000	39.01	---	---	56.00	46.00	-6.99
	850.000	39.33	---	---	56.00	46.00	-6.67
	1208.000	40.42	---	---	56.00	46.00	-5.58
	1801.000	39.66	---	---	56.00	46.00	-6.34
	3477.000	36.60	---	---	56.00	46.00	-9.40
	4014.000	34.59	---	---	56.00	46.00	-11.41
Line 2	243.000	43.33	---	---	63.34	53.34	-10.01
	370.000	41.54	---	---	59.71	49.71	-8.17
	485.000	38.76	---	---	56.43	46.43	-7.67
	598.000	39.50	---	---	56.00	46.00	-6.50
	867.000	40.49	---	---	56.00	46.00	-5.51
	1243.000	40.14	---	---	56.00	46.00	-5.86
	1598.000	39.94	---	---	56.00	46.00	-6.06
	2179.000	39.22	---	---	56.00	46.00	-6.78
	2506.000	38.23	---	---	56.00	46.00	-7.77
	4809.000	33.33	---	---	56.00	46.00	-12.67

NOTE:

- (1)Margin = Peak Amplitude – Limit, *The reading amplitudes are all under limit.*
- (2)A "+" sign in the margin column means the emission is OVER the Class B Limit, and  
 "-" sign of means UNDER the Class B limit

*Test mode: IEEE 802.11b, Channel 1*

<i>Power Connected Emissions</i>					<i>Class B</i>		
<i>Conductor</i>	<i>Frequency (KHz)</i>	<i>Peak (dBμV)</i>	<i>QP (dBμV)</i>	<i>Average (dBμV)</i>	<i>QP-limit (dBμV)</i>	<i>AVG-limit (dBμV)</i>	<i>Margin (dB)</i>
Line 1	377.000	42.76	---	---	59.51	49.51	-6.75
	610.000	38.30	---	---	56.00	46.00	-7.70
	867.000	39.62	---	---	56.00	46.00	-6.38
	1243.000	38.60	---	---	56.00	46.00	-7.40
	1801.000	37.90	---	---	56.00	46.00	-8.10
	2201.000	37.67	---	---	56.00	46.00	-8.33
Line 2	166.000	49.87	---	---	65.54	55.54	-5.67
	384.000	42.46	---	---	59.31	49.31	-6.85
	598.000	38.44	---	---	56.00	46.00	-7.56
	867.000	40.21	---	---	56.00	46.00	-5.79
	1269.000	40.16	---	---	56.00	46.00	-5.84
	1645.000	39.15	---	---	56.00	46.00	-6.85

*Test mode: IEEE 802.11b, Channel 6*

<i>Power Connected Emissions</i>					<i>Class B</i>		
<i>Conductor</i>	<i>Frequency (KHz)</i>	<i>Peak (dBμV)</i>	<i>QP (dBμV)</i>	<i>Average (dBμV)</i>	<i>QP-limit (dBμV)</i>	<i>AVG-limit (dBμV)</i>	<i>Margin (dB)</i>
Line 1	161.000	48.41	---	---	65.69	55.69	-7.28
	384.000	43.42	---	---	59.31	49.31	-5.89
	598.000	37.76	---	---	56.00	46.00	-8.24
	876.000	39.12	---	---	56.00	46.00	-6.88
	1243.000	39.50	---	---	56.00	46.00	-6.50
	1645.000	39.38	---	---	56.00	46.00	-6.62
Line 2	163.000	50.65	---	---	65.63	55.63	-4.98
	380.000	43.18	---	---	59.43	49.43	-6.25
	598.000	38.76	---	---	56.00	46.00	-7.24
	867.000	40.28	---	---	56.00	46.00	-5.72
	1256.000	40.21	---	---	56.00	46.00	-5.79
	1645.000	38.41	---	---	56.00	46.00	-7.59

*Test mode: IEEE 802.11b, Channel 11*

<i>Power Connected Emissions</i>					<i>Class B</i>		
<i>Conductor</i>	<i>Frequency (KHz)</i>	<i>Peak (dBμV)</i>	<i>QP (dBμV)</i>	<i>Average (dBμV)</i>	<i>QP-limit (dBμV)</i>	<i>AVG-limit (dBμV)</i>	<i>Margin (dB)</i>
Line 1	163.000	48.16	---	---	65.63	55.63	-7.47
	218.000	43.49	---	---	64.06	54.06	-10.57
	384.000	42.46	---	---	59.31	49.31	-6.85
	876.000	39.50	---	---	56.00	46.00	-6.50
	1243.000	39.24	---	---	56.00	46.00	-6.76
	1613.000	38.60	---	---	56.00	46.00	-7.40
Line 2	169.000	48.52	---	---	65.46	55.46	-6.94
	384.000	42.53	---	---	59.31	49.31	-6.78
	604.000	38.76	---	---	56.00	46.00	-7.24
	876.000	39.97	---	---	56.00	46.00	-6.03
	1256.000	39.85	---	---	56.00	46.00	-6.15
	1645.000	39.62	---	---	56.00	46.00	-6.38

*Test mode: IEEE 802.11g, Channel 1*

<i>Power Connected Emissions</i>					<i>Class B</i>		
<i>Conductor</i>	<i>Frequency (KHz)</i>	<i>Peak (dBμV)</i>	<i>QP (dBμV)</i>	<i>Average (dBμV)</i>	<i>QP-limit (dBμV)</i>	<i>AVG-limit (dBμV)</i>	<i>Margin (dB)</i>
Line 1	373.000	42.67	---	---	59.63	49.63	-6.96
	485.000	38.16	---	---	56.43	46.43	-8.27
	610.000	38.92	---	---	56.00	46.00	-7.08
	832.000	39.76	---	---	56.00	46.00	-6.24
	1219.000	40.14	---	---	56.00	46.00	-5.86
	1582.000	38.55	---	---	56.00	46.00	-7.45
Line 2	377.000	42.37	---	---	59.51	49.51	-7.14
	598.000	39.55	---	---	56.00	46.00	-6.45
	841.000	40.21	---	---	56.00	46.00	-5.79
	1219.000	40.91	---	---	56.00	46.00	-5.09
	1582.000	39.66	---	---	56.00	46.00	-6.34
	2158.000	38.51	---	---	56.00	46.00	-7.49

*Test mode: IEEE 802.11g, Channel 6*

<i>Power Connected Emissions</i>					<i>Class B</i>		
<i>Conductor</i>	<i>Frequency (KHz)</i>	<i>Peak (dBμV)</i>	<i>QP (dBμV)</i>	<i>Average (dBμV)</i>	<i>QP-limit (dBμV)</i>	<i>AVG-limit (dBμV)</i>	<i>Margin (dB)</i>
Line 1	180.000	49.49	---	---	65.14	55.14	-5.65
	598.000	38.48	---	---	56.00	46.00	-7.52
	858.000	39.40	---	---	56.00	46.00	-6.60
	1219.000	39.64	---	---	56.00	46.00	-6.36
	1801.000	40.08	---	---	56.00	46.00	-5.92
	2136.000	38.72	---	---	56.00	46.00	-7.28
Line 2	195.000	49.91	---	---	64.71	54.71	-4.80
	616.000	38.67	---	---	56.00	46.00	-7.33
	850.000	39.47	---	---	56.00	46.00	-6.53
	980.000	39.94	---	---	56.00	46.00	-6.06
	1424.000	40.19	---	---	56.00	46.00	-5.81
	1977.000	39.55	---	---	56.00	46.00	-6.45

*Test mode: IEEE 802.11g, Channel 11*

<i>Power Connected Emissions</i>					<i>FCC Class B</i>		
<i>Conductor</i>	<i>Frequency (KHz)</i>	<i>Peak (dBμV)</i>	<i>QP (dBμV)</i>	<i>Average (dBμV)</i>	<i>QP-limit (dBμV)</i>	<i>AVG-limit (dBμV)</i>	<i>Margin (dB)</i>
Line 1	373.000	42.01	---	---	59.63	49.63	-7.62
	604.000	39.29	---	---	56.00	46.00	-6.71
	858.000	39.66	---	---	56.00	46.00	-6.34
	1176.000	40.08	---	---	56.00	46.00	-5.92
	1582.000	39.24	---	---	56.00	46.00	-6.76
	1818.000	38.58	---	---	56.00	46.00	-7.42
Line 2	858.000	40.10	---	---	56.00	46.00	-5.90
	972.000	39.92	---	---	56.00	46.00	-6.08
	1187.000	39.64	---	---	56.00	46.00	-6.36
	1424.000	39.52	---	---	56.00	46.00	-6.48
	1959.000	39.43	---	---	56.00	46.00	-6.57
	2158.000	38.87	---	---	56.00	46.00	-7.13

## **V. Section 15.247 (a): Technical description of the EUT**

*Direct Sequence System* is a spread spectrum system in which the carrier has been modulated by a high speed spreading code and an information data stream. The high speed code sequence dominates the “modulating function” and is the direct cause of the wide spreading of the transmitted signal. In the operational description demonstrates the operation principles of the Baseband processor employed by the EUT, shows that which is a complete DSSS baseband processor and meets the definition of the direct sequence spread spectrum system.

## VI. Section 15.247(a)(2): Bandwidth for Direct Sequence System

### 6.1 Test Condition & Setup

The transmitter bandwidth measurements were performed by the contact manner. The EUT was set to transmit continuously, also various channels were investigated to find the maximum occupied bandwidth. The output of the EUT was connected to the spectrum analyzer. The bandwidth of the fundamental frequency is observed by the spectrum analyzer with 100kHz RBW and 100kHz VBW.

### 6.2 Test Instruments Configuration

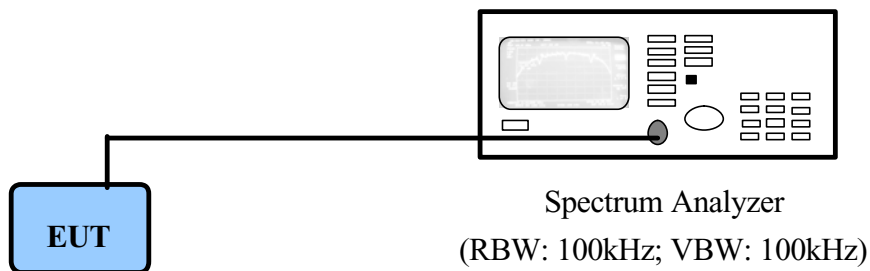

*PC to control the EUT at maximal power output and channel number and set antenna kit*

### 6.3 List of Test Instruments

Instrument Name	Model No.	Brand	Serial No.	Next time
Spectrum Analyzer	MS2665C	ANRITSU	6200175476	12/30/04

**6.4 Test Result of Bandwidth**

<b>Channel</b>	<b>802.11b</b>	<b>802.11g</b>
01	10.92 MHz	16.80 MHz
06	10.88 MHz	16.76 MHz
11	10.88 MHz	16.76 MHz

Note:

1. The data in the above table are summarizing the following attachment spectrum analyzer hard copy. According to the guidance, we'd made the measurement with the spectrum analyzer's resolution bandwidth ( $RBW$ )=100kHz and set the  $span \gg RBW$ .  
The results show the measured 6dB bandwidth comply with the minimum 500kHz requirement.
2. The attachments show these on the following pages.

**6dB Bandwidth of Channel 1 (The minimum 6dB BW at least 500kHz)**

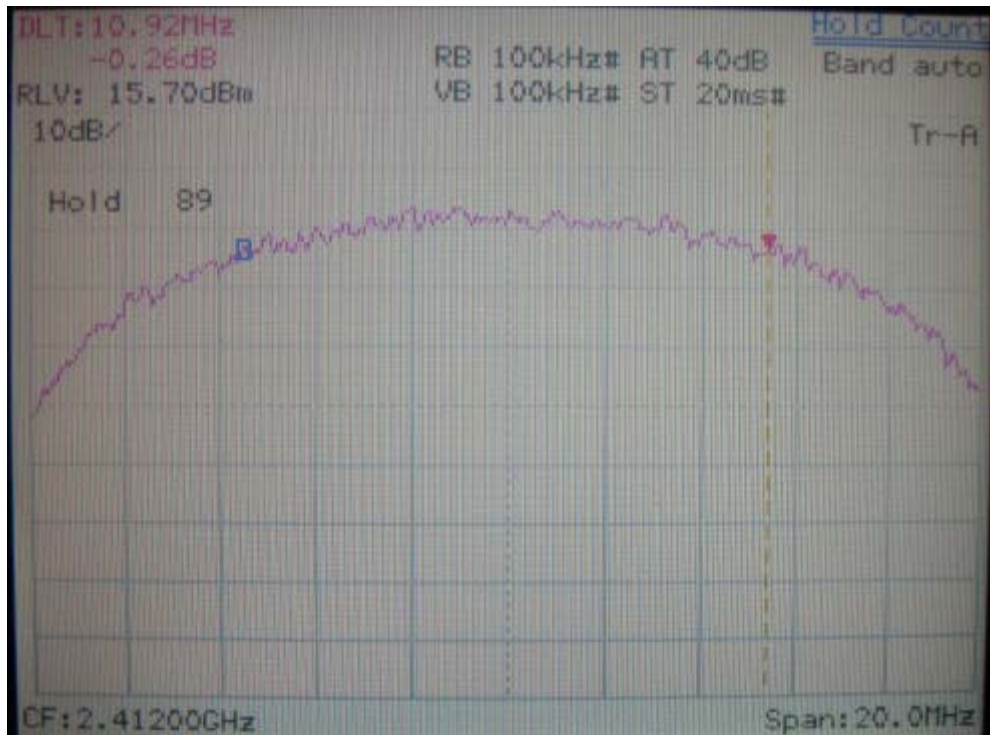

IEEE 802.11b

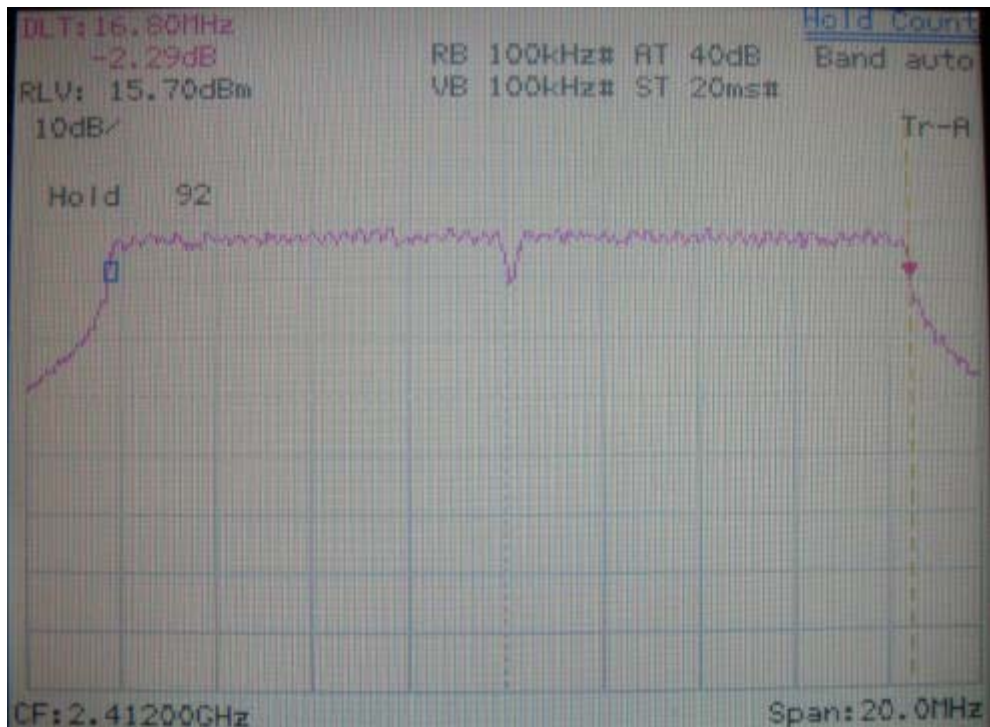

IEEE 802.11g



**6dB Bandwidth of Channel 6 (The minimum 6dB BW at least 500kHz)**

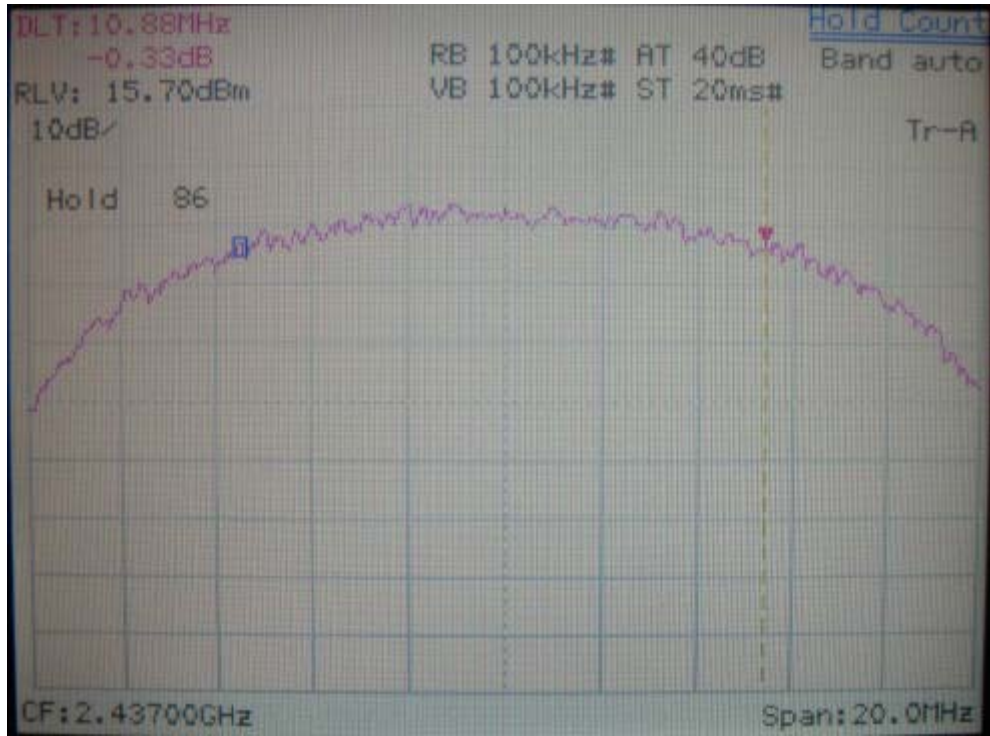

IEEE 802.11b

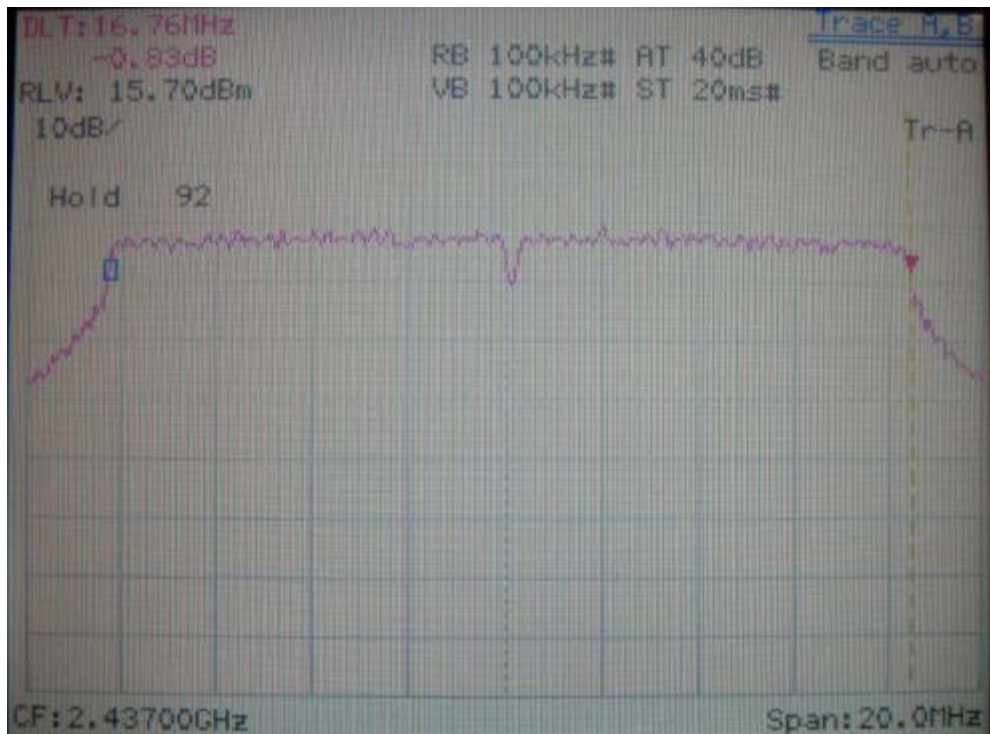

IEEE 802.11g

**6dB Bandwidth of Channel 11 (The minimum 6dB BW at least 500kHz)**

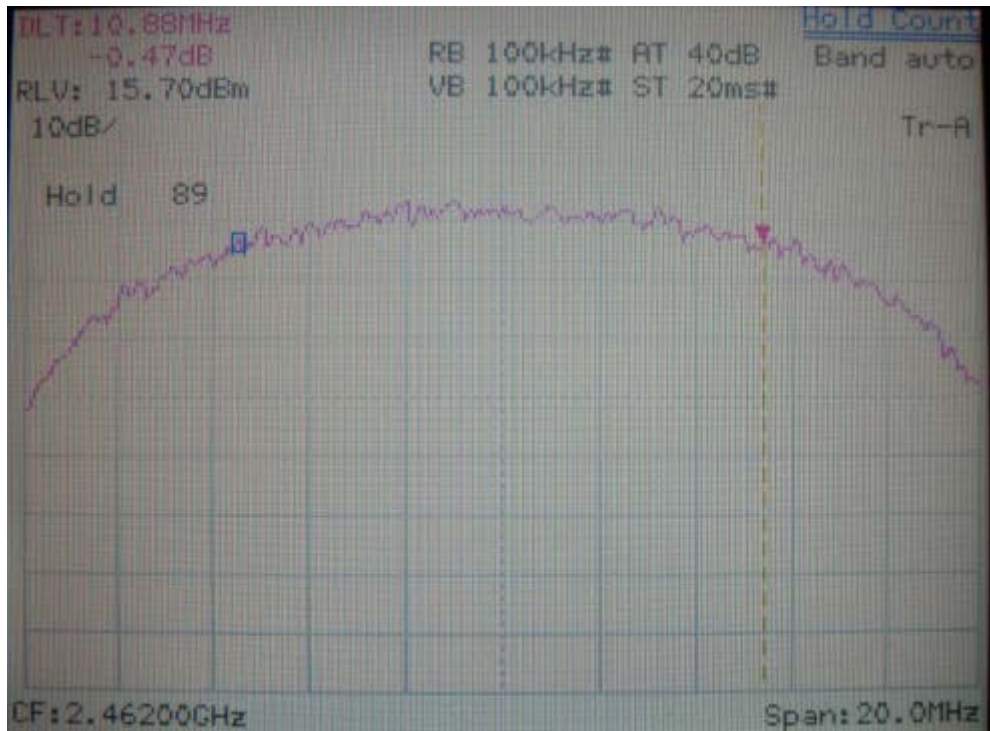

IEEE 802.11b

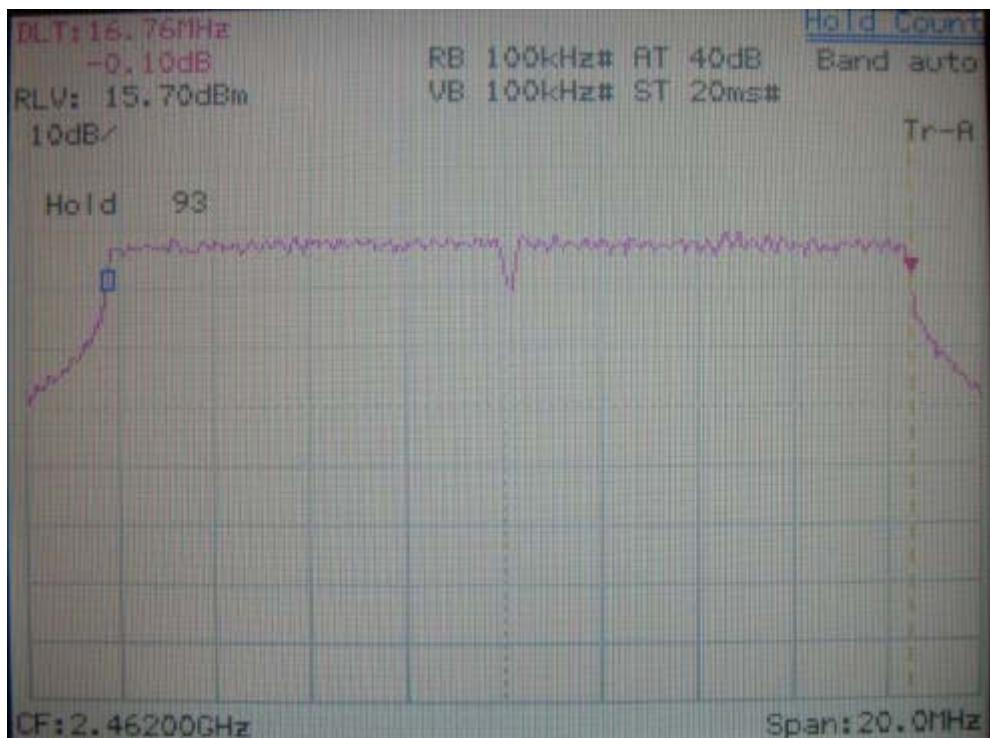

IEEE 802.11g

## VII. Section 15.247(b): Power Output

### 7.1 Test Condition & Setup

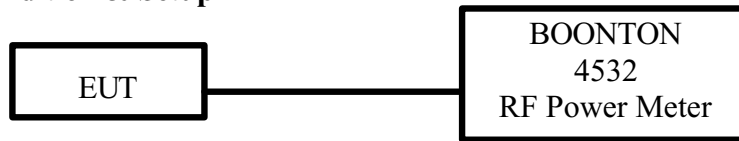

1. The output of the transmitter is connected to the BOONTON RF Power Meter.
2. The calibration is performed before every test. The values of the output power of the EUT will shown in the dBm directly are the transmitter output peak power. Recording as follows.

### 7.2 List of Test Instruments

Instrument Name	Model	Brand	Serial No.	Next time
RF Power Meter	4532	BOONTON	117501	04/16/05
Peak Power Sensor	57340	BOONTON	2696	04/16/05

### 7.3 Test Result

**Formula:**

$$\text{RF Output of EUT} + |\text{Cable Loss}| = \text{Output Peak Power}$$

#### IEEE 802.11b

Channel	RF Output	Cable Loss	Output Peak Power	
	dBm	dBm	dBm	mW
CH 01	10.61	1.00	11.61	14.49
CH 06	10.66	1.00	11.66	14.66
CH 11	10.61	1.00	11.61	14.49

#### IEEE 802.11g

Channel	RF Output	Cable Loss	Output Peak Power	
	dBm	dBm	dBm	mW
CH 01	10.75	1.00	11.75	14.96
CH 06	10.71	1.00	11.71	14.83
CH 11	10.70	1.00	11.70	14.79

## VIII. Section 15.247 (C): Spurious Emissions (Radiated)

### 8.1 Test Condition & Setup

We'd performed the test by the *radiated emission* skill: The EUT was placed in an anechoic chamber, and set the EUT transmitting continuously and scanned at 3-meter distance to determine its emission characteristics. The physical arrangement of the EUT was varied (within the scope of arrangements likely to be encountered in actual use) to determine the effect on the unit's emanations in amplitude, directivity, and frequency. The exact system configuration, which produced the highest emissions was noted so it could be reproduced later during the final tests. For the measurement above 1GHz, according to the guidance we'd set the spectrum analyzer's 6dB bandwidth RBW to 1MHz.

This was done to ensure that the final measurements would demonstrate the worst-case interference potential of the EUT.

Final radiation measurements were made on a three-meter, anechoic chamber. The EUT system was placed on a nonconductive turntable, which is 0.8 meters height, top surface 1.0 x 1.5 meter.

The spectrum was examined from 30 MHz to 1000 MHz using an Hewlett Packard 85460A EMI Receiver, SCHWARZECK whole range Small Biconical Antenna (Model No.: UBAA9114 & BBVU9135) is used to measure frequency from 30 MHz to 1GHz. The final test is used the HP 85460A spectrum and 8564E spectrum was examined from 1GHz to 25GHz using an Hewlett Packard Spectrum Analyzer, EMCO/HP Horn Antenna (Model 3115 / 84125-80008) for 1G - 25GHz.

At each frequency, the EUT was rotated 360 degrees, and the antenna was raised and lowered from one to four meters to find the maximum emission levels. Measurements were taken using both horizontal and vertical antenna polarization.

Appropriate preamplifiers were used for improving sensitivity and precautions were taken to avoid overloading or desensitizing the spectrum analyzer. There are two spectrum analyzers use on this testing, HP 85460A for frequency 30MHz to 1000MHz, and 8564E for frequency 1GHz to 25GHz. No post-detector video filters were used in the test. The spectrum analyzer's 6dB bandwidth was set to 120KHz (spectrum was examined from 30 MHz to 1000 MHz), the spectrum analyzer's 6 dB bandwidth was set to 1 MHz (spectrum was examined from 1GHz to 25GHz) and the analyzer was operated in the maximum hold mode. There is a test condition applies in this test item, the test procedure description as the following:

Three channels were tested, one in the top (CH01), one in the middle (CH06) and the other in bottom (CH11). The setting up procedure is recorded on <1.3>

With the transmitter operating from a AC source and using the internal of EUT, radiates spurious emissions falling within the restricted bands of 15.209 were measured at operating frequencies corresponding to upper, middle and bottom channels in the 2400 ~ 2483.5 MHz band.

The actual field intensity in decibels referenced to 1 microvolt per meter (dB $\mu$ V/m) is determined by algebraically adding the measured reading in dB $\mu$ V, the antenna factor (dB), and cable loss (dB) at the appropriate frequency. Since the EUT was set to transmit continuously, no *duty cycle* is present.

**For frequency between 30MHz to 1000MHz**

$$F_{Ia} \text{ (dB}\mu\text{V/m)} = F_{Ir} \text{ (dB}\mu\text{V)} + \text{Correction Factors}$$

F<sub>Ia</sub> : Actual Field Intensity

F<sub>Ir</sub> : Reading of the Field Intensity

$$\text{Correction Factors} = \text{Antenna Factor} + (\text{Cable Loss} - \text{Amplitude Gain}) + \text{Switching Box Loss}$$

**For frequency between 1GHz to 25GHz**

$$F_{Ia} \text{ (dB}\mu\text{V/m)} = F_{Ir} \text{ (dB}\mu\text{V)} + \text{Correction Factor}$$

F<sub>Ia</sub> : Actual Field Intensity

F<sub>Ir</sub> : Reading of the Field Intensity

$$\text{Correction Factors} = \text{Antenna Factor} + (\text{Cable Loss} - \text{Amplitude Gain}) + \text{Switching Box Loss}$$

## 8.2 List of Test Instruments

Instrument Name	Model	Brand	Serial No.	Calibration Date
				Next time
EMI Receiver	8546A	HP	3520A00242	08/05/05
RF Filter Section	85460A	HP	3448A00217	08/05/05
Small Biconical Antenna	UBAA9114 & BBVU9135	SCHWARZECK	127	10/11/05
Pre-amplifier	PA1F	TRC	1FAC	05/20/05
Auto Switch Box (>30MHz)	ASB-01	TRC	9904-01	05/20/05
Coaxial Cable (Double shielded, 15 meter)	A30A30-0058-50FS-15M	JYEBAO	SMA-01	05/20/05
Coaxial Cable (1.1 meter)	A30A30-0058-50FS-1M	JYEBAO	SMA-02	05/20/05
Spectrum Analyzer	8564E	HP	3720A00840	08/13/05
Microwave Pre-amplifier	84125C	HP	US36433002	08/13/05
Horn Antenna	3115	EMCO	9104-3668	12/18/04
Standard Guide Horn Antenna	84125-80008	HP	18-26.5GHz	12/18/04
Standard Guide Horn Antenna	84125-80001	HP	26.5-40GHz	12/18/04
Horn Antenna	1196E (3115)	HP (EMCO)	9704-5178	12/12/04
Pre-amplifier	PA2F	TRC	2F1GZ	03/20/05
Coaxial Cable (3 miter)	A30A30-0058-50FST118	JYEBAO	MSA-05	03/20/05
Coaxial Cable (1 meter)	A30A30-0058-50FST118	JYEBAO	MSA-04	03/20/05

### 8.3 Test Result of Spurious Radiated Emissions

The highest peak values of radiated emissions from the EUT at various antenna heights, antenna polarizations, EUT orientation, etc. are recorded on the following.

Test Conditions: Temperature : 25 ° C Humidity : 73 % RH

*Test mode: Standby mode for 30MHz to 1GHz [Antenna polarity Horizontal]*

Radiated Emission				Correction Factors (dB)	Corrected Amplitude (dBμV/m)	Class B (3 m)	
Frequency (MHz)	Amplitude (dBμV)	Ant. H. (m)	Table ( ° )			Limit (dBμV/m)	Margin (dB)
39.09	25.49	1.00	50	5.91	31.40	40.00	-8.60
213.69	36.61	1.00	132	-3.92	32.69	43.50	-10.81
253.71	37.34	1.00	70	-4.09	33.25	46.00	-12.75
292.51	35.68	1.00	259	-3.75	31.93	46.00	-14.07
374.35	34.77	1.00	288	-1.89	32.88	46.00	-13.12
433.16	31.74	1.00	52	0.33	32.07	46.00	-13.93

*Test mode: Standby mode for 30MHz to 1GHz [Antenna polarity Vertical]*

Radiated Emission				Correction Factors (dB)	Corrected Amplitude (dBμV/m)	Class B (3 m)	
Frequency (MHz)	Amplitude (dBμV)	Ant. H. (m)	Table ( ° )			Limit (dBμV/m)	Margin (dB)
39.09	26.31	1.00	210	5.91	32.22	40.00	-7.78
213.69	32.87	1.00	301	-3.92	28.95	43.50	-14.55
399.81	30.53	1.00	357	-1.01	29.52	46.00	-16.48
433.16	28.65	1.00	75	0.33	28.98	46.00	-17.02
543.49	27.94	1.00	9	4.74	32.68	46.00	-13.32
638.67	23.31	1.00	30	8.05	31.36	46.00	-14.64

Note:

1. Margin = Amplitude – limit, if margin is minus means under limit.
2. Corrected Amplitude = Reading Amplitude + Correction Factors
3. Correction factor = Antenna factor + ( Cable Loss – Amplitude gain) + Switching Box Loss

**Test mode: Standby mode for 1GHz to 25GHz [Horizontal]**

<b>Frequency</b>	<b>Ant. H.</b>	<b>Table</b>	<b>Amplitude</b>		<b>Correction Factor</b>	<b>Corrected Amplitude</b>		<b>Limit</b>		<b>Margin</b>
			<b>Peak / Ave.</b>			<b>Peak / Ave.</b>		<b>Peak / Ave.</b>		
<b>MHz</b>	<b>m</b>	<b>degree</b>	<b>dBμV</b>		<b>dB/m</b>	<b>dBμV/m</b>		<b>dBμV/m</b>		<b>dB</b>
2466.25	1.00	228	42.24	---	6.71	48.95	---	73.96	53.96	-5.01
4839.17	1.00	122	32.90	---	14.83	47.73	---	73.96	53.96	-6.23
8770.42	1.00	235	24.58	---	23.13	47.71	---	73.96	53.96	-6.25
13757.08	1.00	49	31.24	---	19.75	50.99	---	73.96	53.96	-2.97
19586.67	1.00	116	49.16	---	1.70	50.86	---	73.96	53.96	-3.10
21392.92	1.00	24	47.99	---	2.70	50.69	---	73.96	53.96	-3.27

**Test mode: Standby mode for 1GHz to 25GHz [Vertical]**

<b>Frequency</b>	<b>Ant. H.</b>	<b>Table</b>	<b>Amplitude</b>		<b>Correction Factor</b>	<b>Corrected Amplitude</b>		<b>Limit</b>		<b>Margin</b>
			<b>Peak / Ave.</b>			<b>Peak / Ave.</b>		<b>Peak / Ave.</b>		
<b>MHz</b>	<b>m</b>	<b>degree</b>	<b>dBμV</b>		<b>dB/m</b>	<b>dBμV/m</b>		<b>dBμV/m</b>		<b>dB</b>
2629.17	1.00	148	32.24	---	7.82	40.06	---	73.96	53.96	-13.90
4173.33	1.00	154	29.74	---	12.78	42.52	---	73.96	53.96	-11.44
7219.17	1.00	254	24.74	---	21.40	46.14	---	73.96	53.96	-7.82
8919.17	1.00	221	24.74	---	23.12	47.86	---	73.96	53.96	-6.10
23833.12	1.00	226	47.33	---	3.53	50.86	---	73.96	53.96	-3.10

Note:

1. Margin = Corrected - Limit.
2. The EUT utilizes a *permanently attached antenna*. In addition the spurious RF radiated emissions levels do comply with the *20dBc limit* both at its bandedges and other spurious emissions.
3. As stated in Section 15.35(b), for any frequencies above 1000MHz, radiated limits shown are based upon the use of measurement instrumentation employing an average detector function. As the results of our test, the peak amplitudes are already below the FCC limit. Thus the average amplitudes of the rest are omitted.



*Test mode: IEEE 802.11b CH01 for 30MHz to 1GHz [Horizontal]*

<i>Radiated Emission</i>				<i>Correction Factors</i>	<i>Corrected Amplitude</i>	<i>Class B (3 m)</i>	
<i>Frequency (MHz)</i>	<i>Amplitude (dBμV)</i>	<i>Ant. H. (m)</i>	<i>Table (°)</i>			<i>Limit (dBμV/m)</i>	<i>Margin (dB)</i>
202.17	34.91	1.00	105	-3.83	31.08	43.50	-12.42
255.52	36.07	1.00	105	-4.13	31.94	46.00	-14.06
301.60	38.04	1.00	285	-3.68	34.36	46.00	-11.64
375.56	33.90	1.00	174	-1.85	32.05	46.00	-13.95
401.02	32.08	1.00	287	-0.96	31.12	46.00	-14.88
544.10	26.09	1.00	27	4.76	30.85	46.00	-15.15

*Test mode: IEEE 802.11b CH01 for 30MHz to 1GHz [Vertical]*

<i>Radiated Emission</i>				<i>Correction Factors</i>	<i>Corrected Amplitude</i>	<i>Class B (3 m)</i>	
<i>Frequency (MHz)</i>	<i>Amplitude (dBμV)</i>	<i>Ant. H. (m)</i>	<i>Table (°)</i>			<i>Limit (dBμV/m)</i>	<i>Margin (dB)</i>
39.70	28.00	1.00	214	5.83	33.83	40.00	-6.17
150.04	31.17	1.00	205	-3.14	28.03	43.50	-15.47
200.96	33.41	1.00	50	-3.82	29.59	43.50	-13.91
399.81	30.81	1.00	93	-1.01	29.80	46.00	-16.20
433.16	28.74	1.00	64	0.33	29.07	46.00	-16.93
543.49	27.73	1.00	30	4.74	32.47	46.00	-13.53

*Test mode: IEEE 802.11b CH01 for 1GHz to 25GHz [Horizontal]*

<i>Frequency</i>	<i>Ant. H.</i>	<i>Table</i>	<i>Amplitude</i>		<i>Correction Factor</i>	<i>Corrected Amplitude</i>		<i>Limit</i>		<i>Margin</i>
			<i>Peak / Ave.</i>			<i>Peak / Ave.</i>		<i>Peak / Ave.</i>		
<i>MHz</i>	<i>m</i>	<i>degree</i>	<i>dBμV</i>		<i>dB/m</i>	<i>dBμV/m</i>		<i>dBμV/m</i>		<i>dB</i>
4823.12	1.00	24	39.44	---	3.76	43.20	---	73.96	53.96	-10.76
7233.75	1.00	103	35.94	---	10.07	46.01	---	73.96	53.96	-7.95
9650.42	1.00	16	35.44	---	11.47	46.91	---	73.96	53.96	-7.05
12061.04	1.00	356	38.27	---	9.81	48.08	---	73.96	53.96	-5.88
19296.25	1.00	296	46.49	---	1.60	48.09	---	73.96	53.96	-5.87
21708.12	1.00	5	45.32	---	2.87	48.19	---	73.96	53.96	-5.77

*Test mode: IEEE 802.11b CH01 for 1GHz to 25GHz [Vertical]*

<i>Frequency</i>	<i>Ant. H.</i>	<i>Table</i>	<i>Amplitude</i>		<i>Correction Factor</i>	<i>Corrected Amplitude</i>		<i>Limit</i>		<i>Margin</i>
			<i>Peak / Ave.</i>			<i>Peak / Ave.</i>		<i>Peak / Ave.</i>		
<i>MHz</i>	<i>m</i>	<i>degree</i>	<i>dBμV</i>		<i>dB/m</i>	<i>dBμV/m</i>		<i>dBμV/m</i>		<i>dB</i>
4823.12	1.00	242	39.44	---	3.76	43.20	---	73.96	53.96	-10.76
7233.75	1.00	4	34.94	---	10.07	45.01	---	73.96	53.96	-8.95
9650.42	1.00	171	36.27	---	11.47	47.74	---	73.96	53.96	-6.22
12061.04	1.00	203	37.44	---	9.81	47.25	---	73.96	53.96	-6.71
19296.25	1.00	33	46.82	---	1.60	48.42	---	73.96	53.96	-5.54
24120.00	1.00	125	44.49	---	3.40	47.89	---	73.96	53.96	-6.07

*Test mode: IEEE 802.11b CH06 for 30MHz to 1GHz [Horizontal]*

<i>Radiated Emission</i>				<i>Correction Factors</i>	<i>Corrected Amplitude</i>	<i>Class B (3 m)</i>	
<i>Frequency (MHz)</i>	<i>Amplitude (dBμV)</i>	<i>Ant. H. (m)</i>	<i>Table (°)</i>			<i>Limit (dBμV/m)</i>	<i>Margin (dB)</i>
39.09	25.31	1.00	30	5.91	31.22	40.00	-8.78
200.36	34.95	1.00	138	-3.81	31.14	43.50	-12.36
213.69	37.49	1.00	141	-3.92	33.57	43.50	-9.93
254.31	37.32	1.00	63	-4.10	33.22	46.00	-12.78
299.18	36.77	1.00	89	-3.71	33.06	46.00	-12.94
433.16	30.97	1.00	325	0.33	31.30	46.00	-14.70

*Test mode: IEEE 802.11b CH06 for 30MHz to 1GHz [Vertical]*

<i>Radiated Emission</i>				<i>Correction Factors</i>	<i>Corrected Amplitude</i>	<i>Class B (3 m)</i>	
<i>Frequency (MHz)</i>	<i>Amplitude (dBμV)</i>	<i>Ant. H. (m)</i>	<i>Table (°)</i>			<i>Limit (dBμV/m)</i>	<i>Margin (dB)</i>
39.70	26.53	1.00	50	5.83	32.36	40.00	-7.64
145.19	30.73	1.00	28	-3.00	27.73	43.50	-15.77
200.96	33.78	1.00	34	-3.82	29.96	43.50	-13.54
213.69	32.57	1.00	289	-3.92	28.65	43.50	-14.85
433.16	28.41	1.00	58	0.33	28.74	46.00	-17.26
544.10	28.08	1.00	354	4.76	32.84	46.00	-13.16

*Test mode: IEEE 802.11b CH06 for 1GHz to 25GHz [Horizontal]*

<i>Frequency</i>	<i>Ant. H.</i>	<i>Table</i>	<i>Amplitude</i>		<i>Correction Factor</i>	<i>Corrected Amplitude</i>		<i>Limit</i>		<i>Margin</i>
			<i>Peak / Ave.</i>			<i>Peak / Ave.</i>		<i>Peak / Ave.</i>		
<i>MHz</i>	<i>m</i>	<i>degree</i>	<i>dBμV</i>		<i>dB/m</i>	<i>dBμV/m</i>		<i>dBμV/m</i>		<i>dB</i>
7312.29	1.00	60	36.94	---	10.30	47.24	---	73.96	53.96	-6.72
9747.08	1.00	7	35.10	---	11.89	46.99	---	73.96	53.96	-6.97
12187.92	1.00	51	39.44	---	9.74	49.18	---	73.96	53.96	-4.78
19494.58	1.00	317	46.49	---	1.69	48.18	---	73.96	53.96	-5.78
21934.79	1.00	187	45.82	---	3.09	48.91	---	73.96	53.96	-5.05
24371.46	1.00	104	44.99	---	3.26	48.25	---	73.96	53.96	-5.71

*Test mode: IEEE 802.11b CH06 for 1GHz to 25GHz [Vertical]*

<i>Frequency</i>	<i>Ant. H.</i>	<i>Table</i>	<i>Amplitude</i>		<i>Correction Factor</i>	<i>Corrected Amplitude</i>		<i>Limit</i>		<i>Margin</i>
			<i>Peak / Ave.</i>			<i>Peak / Ave.</i>		<i>Peak / Ave.</i>		
<i>MHz</i>	<i>m</i>	<i>degree</i>	<i>dBμV</i>		<i>dB/m</i>	<i>dBμV/m</i>		<i>dBμV/m</i>		<i>dB</i>
4871.46	1.00	244	39.27	---	3.95	43.22	---	73.96	53.96	-10.74
7312.29	1.00	48	35.77	---	10.30	46.07	---	73.96	53.96	-7.89
9747.08	1.00	81	35.77	---	11.89	47.66	---	73.96	53.96	-6.30
12187.92	1.00	104	38.94	---	9.74	48.68	---	73.96	53.96	-5.28
21934.79	1.00	166	44.82	---	3.09	47.91	---	73.96	53.96	-6.05
24371.46	1.00	205	45.16	---	3.26	48.42	---	73.96	53.96	-5.54

*Test mode: IEEE 802.11b CH11 for 30MHz to 1GHz [Horizontal]*

<i>Radiated Emission</i>				<i>Correction Factors</i>	<i>Corrected Amplitude</i>	<i>Class B (3 m)</i>	
<i>Frequency (MHz)</i>	<i>Amplitude (dBμV)</i>	<i>Ant. H. (m)</i>	<i>Table (°)</i>			<i>Limit (dBμV/m)</i>	<i>Margin (dB)</i>
39.09	25.65	1.00	339	5.91	31.56	40.00	-8.44
200.36	34.11	1.00	122	-3.81	30.30	43.50	-13.20
213.69	38.20	1.00	110	-3.92	34.28	43.50	-9.22
253.71	35.68	1.00	101	-4.09	31.59	46.00	-14.41
279.17	37.32	1.00	100	-3.98	33.34	46.00	-12.66
374.35	34.58	1.00	299	-1.89	32.69	46.00	-13.31

*Test mode: IEEE 802.11b CH11 for 30MHz to 1GHz [Vertical]*

<i>Radiated Emission</i>				<i>Correction Factors</i>	<i>Corrected Amplitude</i>	<i>Class B (3 m)</i>	
<i>Frequency (MHz)</i>	<i>Amplitude (dBμV)</i>	<i>Ant. H. (m)</i>	<i>Table (°)</i>			<i>Limit (dBμV/m)</i>	<i>Margin (dB)</i>
39.09	25.70	1.00	232	5.91	31.61	40.00	-8.39
144.58	29.42	1.00	265	-2.98	26.44	43.50	-17.06
199.75	31.76	1.00	300	-3.81	27.95	43.50	-15.55
213.09	31.92	1.00	318	-3.91	28.01	43.50	-15.49
433.16	28.18	1.00	71	0.33	28.51	46.00	-17.49
543.49	27.66	1.00	351	4.74	32.40	46.00	-13.60

*Test mode: IEEE 802.11b CH11 for 1GHz to 25GHz [Horizontal]*

<i>Frequency</i>	<i>Ant. H.</i>	<i>Table</i>	<i>Amplitude</i>		<i>Correction Factor</i>	<i>Corrected Amplitude</i>		<i>Limit</i>		<i>Margin</i>
			<i>Peak / Ave.</i>			<i>Peak / Ave.</i>		<i>Peak / Ave.</i>		
<i>MHz</i>	<i>m</i>	<i>degree</i>	<i>dBμV</i>		<i>dB/m</i>	<i>dBμV/m</i>		<i>dBμV/m</i>		<i>dB</i>
4925.83	1.00	100	37.44	---	4.13	41.57	---	73.96	53.96	-12.39
7384.79	1.00	237	36.11	---	10.42	46.53	---	73.96	53.96	-7.43
9849.79	1.00	18	35.61	---	11.93	47.54	---	73.96	53.96	-6.42
12308.75	1.00	144	37.11	---	9.56	46.67	---	73.96	53.96	-7.29
22157.92	1.00	19	44.15	---	3.25	47.40	---	73.96	53.96	-6.56
24619.37	1.00	38	45.66	---	3.01	48.67	---	73.96	53.96	-5.29

*Test mode: IEEE 802.11b CH11 for 1GHz to 25GHz [Vertical]*

<i>Frequency</i>	<i>Ant. H.</i>	<i>Table</i>	<i>Amplitude</i>		<i>Correction Factor</i>	<i>Corrected Amplitude</i>		<i>Limit</i>		<i>Margin</i>
			<i>Peak / Ave.</i>			<i>Peak / Ave.</i>		<i>Peak / Ave.</i>		
<i>MHz</i>	<i>m</i>	<i>degree</i>	<i>dBμV</i>		<i>dB/m</i>	<i>dBμV/m</i>		<i>dBμV/m</i>		<i>dB</i>
4925.83	1.00	0	38.94	---	4.13	43.07	---	73.96	53.96	-10.89
7384.79	1.00	211	36.44	---	10.42	46.86	---	73.96	53.96	-7.10
9849.79	1.00	78	35.11	---	11.93	47.04	---	73.96	53.96	-6.92
12308.75	1.00	281	37.27	---	9.56	46.83	---	73.96	53.96	-7.13
19696.46	1.00	212	46.49	---	1.81	48.30	---	73.96	53.96	-5.66
24619.37	1.00	290	45.66	---	3.01	48.67	---	73.96	53.96	-5.29

*Test mode: IEEE 802.11g CH01 for 30MHz to 1GHz [Horizontal]*

<b>Radiated Emission</b>				<b>Correction Factors</b>	<b>Corrected Amplitude</b>	<b>Class B (3 m)</b>	
<b>Frequency (MHz)</b>	<b>Amplitude (dBμV)</b>	<b>Ant. H. (m)</b>	<b>Table (°)</b>			<b>Limit (dBμV/m)</b>	<b>Margin (dB)</b>
39.70	24.62	1.00	329	5.83	30.45	40.00	-9.55
200.36	33.67	1.00	90	-3.81	29.86	43.50	-13.64
213.69	35.63	1.00	137	-3.92	31.71	43.50	-11.79
253.71	37.44	1.00	71	-4.09	33.35	46.00	-12.65
279.17	35.93	1.00	104	-3.98	31.95	46.00	-14.05
374.35	34.84	1.00	291	-1.89	32.95	46.00	-13.05

*Test mode: IEEE 802.11g CH01 for 30MHz to 1GHz [Vertical]*

<b>Radiated Emission</b>				<b>Correction Factors</b>	<b>Corrected Amplitude</b>	<b>Class B (3 m)</b>	
<b>Frequency (MHz)</b>	<b>Amplitude (dBμV)</b>	<b>Ant. H. (m)</b>	<b>Table (°)</b>			<b>Limit (dBμV/m)</b>	<b>Margin (dB)</b>
39.70	27.07	1.00	50	5.83	32.90	40.00	-7.10
144.58	29.00	1.00	307	-2.98	26.02	43.50	-17.48
213.69	32.40	1.00	15	-3.92	28.48	43.50	-15.02
399.21	30.30	1.00	15	-1.03	29.27	46.00	-16.73
433.16	28.88	1.00	61	0.33	29.21	46.00	-16.79
543.49	27.40	1.00	331	4.74	32.14	46.00	-13.86

*Test mode: IEEE 802.11g CH01 for 1GHz to 25GHz [Horizontal]*

<i>Frequency</i>	<i>Ant. H.</i>	<i>Table</i>	<i>Amplitude</i>		<i>Correction Factor</i>	<i>Corrected Amplitude</i>		<i>Limit</i>		<i>Margin</i>
			<i>Peak / Ave.</i>			<i>Peak / Ave.</i>		<i>Peak / Ave.</i>		
<i>MHz</i>	<i>m</i>	<i>degree</i>	<i>dBμV</i>		<i>dB/m</i>	<i>dBμV/m</i>		<i>dBμV/m</i>		<i>dB</i>
4823.12	1.00	260	38.94	---	3.76	42.70	---	73.96	53.96	-11.26
7233.75	1.00	260	35.74	---	10.11	45.85	---	73.96	53.96	-8.11
9650.42	1.00	205	34.44	---	11.47	45.91	---	73.96	53.96	-8.05
12061.04	1.00	174	37.77	---	9.81	47.58	---	73.96	53.96	-6.38
19296.25	1.00	216	47.66	---	1.60	49.26	---	73.96	53.96	-4.70
21708.12	1.00	42	46.16	---	2.87	49.03	---	73.96	53.96	-4.93

*Test mode: IEEE 802.11g CH01 for 1GHz to 25GHz [Vertical]*

<i>Frequency</i>	<i>Ant. H.</i>	<i>Table</i>	<i>Amplitude</i>		<i>Correction Factor</i>	<i>Corrected Amplitude</i>		<i>Limit</i>		<i>Margin</i>
			<i>Peak / Ave.</i>			<i>Peak / Ave.</i>		<i>Peak / Ave.</i>		
<i>MHz</i>	<i>m</i>	<i>degree</i>	<i>dBμV</i>		<i>dB/m</i>	<i>dBμV/m</i>		<i>dBμV/m</i>		<i>dB</i>
4823.12	1.00	183	39.44	---	3.76	43.20	---	73.96	53.96	-10.76
7233.75	1.00	208	35.94	---	10.07	46.01	---	73.96	53.96	-7.95
9650.42	1.00	110	35.27	---	11.47	46.74	---	73.96	53.96	-7.22
12061.04	1.00	231	37.94	---	9.81	47.75	---	73.96	53.96	-6.21
19296.25	1.00	96	47.66	---	1.60	49.26	---	73.96	53.96	-4.70
21708.12	1.00	114	46.82	---	2.87	49.69	---	73.96	53.96	-4.27



*Test mode: IEEE 802.11g CH06 for 30MHz to 1GHz [Horizontal]*

<i>Radiated Emission</i>				<i>Correction Factors</i>	<i>Corrected Amplitude</i>	<i>Class B (3 m)</i>	
<i>Frequency (MHz)</i>	<i>Amplitude (dBμV)</i>	<i>Ant. H. (m)</i>	<i>Table (°)</i>			<i>Limit (dBμV/m)</i>	<i>Margin (dB)</i>
39.70	25.17	1.00	97	5.83	31.00	40.00	-9.00
214.30	35.77	1.00	86	-3.92	31.85	43.50	-11.65
227.03	38.55	1.00	97	-4.05	34.50	46.00	-11.50
279.77	36.16	1.00	116	-3.97	32.19	46.00	-13.81
299.78	36.24	1.00	81	-3.71	32.53	46.00	-13.47
374.35	34.21	1.00	293	-1.89	32.32	46.00	-13.68

*Test mode: IEEE 802.11g CH06 for 30MHz to 1GHz [Vertical]*

<i>Radiated Emission</i>				<i>Correction Factors</i>	<i>Corrected Amplitude</i>	<i>Class B (3 m)</i>	
<i>Frequency (MHz)</i>	<i>Amplitude (dBμV)</i>	<i>Ant. H. (m)</i>	<i>Table (°)</i>			<i>Limit (dBμV/m)</i>	<i>Margin (dB)</i>
39.70	26.62	1.00	148	5.83	32.45	40.00	-7.55
145.19	28.40	1.00	12	-3.00	25.40	43.50	-18.10
213.69	33.71	1.00	339	-3.92	29.79	43.50	-13.71
399.81	28.87	1.00	44	-1.01	27.86	46.00	-18.14
432.55	28.67	1.00	71	0.31	28.98	46.00	-17.02
543.49	27.64	1.00	342	4.74	32.38	46.00	-13.62

**Test mode: IEEE 802.11g CH06 for 1GHz to 25GHz [Horizontal]**

Frequency	Ant. H.	Table	Amplitude		Correction Factor	Corrected Amplitude		Limit		Margin
			Peak / Ave.			Peak / Ave.		Peak / Ave.		
MHz	m	degree	dBμV		dB/m	dBμV/m		dBμV/m		dB
7312.29	1.00	155	36.11	---	10.30	46.41	---	73.96	53.96	-7.55
9747.08	1.00	71	35.27	---	11.89	47.16	---	73.96	53.96	-6.80
12187.92	1.00	192	39.10	---	9.74	48.84	---	73.96	53.96	-5.12
19498.12	1.00	318	47.65	---	1.70	49.35	---	73.96	53.96	-4.61
21934.79	1.00	275	46.32	---	3.09	49.41	---	73.96	53.96	-4.55
24371.46	1.00	157	46.33	---	3.26	49.59	---	73.96	53.96	-4.37

**Test mode: IEEE 802.11g CH06 for 1GHz to 25GHz [Vertical]**

Frequency	Ant. H.	Table	Amplitude		Correction Factor	Corrected Amplitude		Limit		Margin
			Peak / Ave.			Peak / Ave.		Peak / Ave.		
MHz	m	degree	dBμV		dB/m	dBμV/m		dBμV/m		dB
4871.46	1.00	154	36.44	---	10.30	46.74	---	73.96	53.96	-7.22
7312.29	1.00	38	35.10	---	11.89	46.99	---	73.96	53.96	-6.97
9747.08	1.00	156	38.94	---	9.74	48.68	---	73.96	53.96	-5.28
12187.92	1.00	127	47.15	---	1.70	48.85	---	73.96	53.96	-5.11
21934.79	1.00	172	46.32	---	3.09	49.41	---	73.96	53.96	-4.55
24371.46	1.00	158	45.83	---	3.26	49.09	---	73.96	53.96	-4.87

*Test mode: IEEE 802.11g CH11 for 30MHz to 1GHz [Horizontal]*

<i>Radiated Emission</i>				<i>Correction Factors</i>	<i>Corrected Amplitude</i>	<i>Class B (3 m)</i>	
<i>Frequency (MHz)</i>	<i>Amplitude (dBμV)</i>	<i>Ant. H. (m)</i>	<i>Table (°)</i>			<i>Limit (dBμV/m)</i>	<i>Margin (dB)</i>
39.09	25.77	1.00	16	5.91	31.68	40.00	-8.32
213.69	36.40	1.00	79	-3.92	32.48	43.50	-11.02
227.03	38.34	1.00	111	-4.05	34.29	46.00	-11.71
253.71	37.74	1.00	151	-4.09	33.65	46.00	-12.35
279.77	37.53	1.00	99	-3.97	33.56	46.00	-12.44
374.35	35.07	1.00	288	-1.89	33.18	46.00	-12.82

*Test mode: IEEE 802.11g CH11 for 30MHz to 1GHz [Vertical]*

<i>Radiated Emission</i>				<i>Correction Factors</i>	<i>Corrected Amplitude</i>	<i>Class B (3 m)</i>	
<i>Frequency (MHz)</i>	<i>Amplitude (dBμV)</i>	<i>Ant. H. (m)</i>	<i>Table (°)</i>			<i>Limit (dBμV/m)</i>	<i>Margin (dB)</i>
39.09	26.55	1.00	0	5.91	32.46	40.00	-7.54
144.58	28.86	1.00	47	-2.98	25.88	43.50	-17.62
200.36	32.52	1.00	348	-3.81	28.71	43.50	-14.79
213.69	35.00	1.00	266	-3.92	31.08	43.50	-12.42
433.16	28.48	1.00	75	0.33	28.81	46.00	-17.19
543.49	27.73	1.00	3	4.74	32.47	46.00	-13.53

*Test mode: IEEE 802.11g CH11 for 1GHz to 25GHz [Horizontal]*

<i>Frequency</i>	<i>Ant. H.</i>	<i>Table</i>	<i>Amplitude</i>		<i>Correction Factor</i>	<i>Corrected Amplitude</i>		<i>Limit</i>		<i>Margin</i>
			<i>Peak / Ave.</i>			<i>Peak / Ave.</i>		<i>Peak / Ave.</i>		
<i>MHz</i>	<i>m</i>	<i>degree</i>	<i>dBμV</i>		<i>dB/m</i>	<i>dBμV/m</i>		<i>dBμV/m</i>		<i>dB</i>
7384.79	1.00	114	36.11	---	10.42	46.53	---	73.96	53.96	-7.43
9849.79	1.00	34	35.11	---	11.93	47.04	---	73.96	53.96	-6.92
12308.75	1.00	285	37.27	---	9.56	46.83	---	73.96	53.96	-7.13
19696.46	1.00	310	47.32	---	1.81	49.13	---	73.96	53.96	-4.83
22157.92	1.00	211	45.99	---	3.25	49.24	---	73.96	53.96	-4.72
24622.92	1.00	279	45.99	---	3.04	49.03	---	73.96	53.96	-4.93

*Test mode: IEEE 802.11g CH11 for 1GHz to 25GHz [Vertical]*

<i>Frequency</i>	<i>Ant. H.</i>	<i>Table</i>	<i>Amplitude</i>		<i>Correction Factor</i>	<i>Corrected Amplitude</i>		<i>Limit</i>		<i>Margin</i>
			<i>Peak / Ave.</i>			<i>Peak / Ave.</i>		<i>Peak / Ave.</i>		
<i>MHz</i>	<i>m</i>	<i>degree</i>	<i>dBμV</i>		<i>dB/m</i>	<i>dBμV/m</i>		<i>dBμV/m</i>		<i>dB</i>
4925.83	1.00	311	38.61	---	4.13	42.74	---	73.96	53.96	-11.22
7384.79	1.00	50	35.78	---	10.42	46.20	---	73.96	53.96	-7.76
9849.79	1.00	230	35.44	---	11.93	47.37	---	73.96	53.96	-6.59
12308.75	1.00	336	36.61	---	9.56	46.17	---	73.96	53.96	-7.79
19696.46	1.00	311	47.99	---	1.81	49.80	---	73.96	53.96	-4.16
24622.92	1.00	201	46.16	---	3.04	49.20	---	73.96	53.96	-4.76

#### **8.4 Test Result of the Bandedge**

If any 100 kHz bandwidth outside these frequency bands, the radio frequency power that is produced by the modulation products of the spreading sequence, the information sequence and the carrier frequency shall be either *at least 20 dB below that in any 100 kHz bandwidth within the band that contains the highest level of the desired power or shall not exceed the general levels specified in § 15.209(a)*,

We perform this section by the *radiated manner*, the RBW is set to 100kHz and VBW>RBW. We'd made the observation *up to 10<sup>th</sup> harmonics and the criterion is all the harmonic/spurious emissions must be 20dB below the highest emission level measured*. If the emissions fall in the restricted bands stated in the Part 15.205(a) must also *comply with the radiated emission limits specified in Part 15.209(a)*. (Peak mode: RBW=VBW=1MHz, Average mode: RBW=1MHz; VBW=10Hz)

The following pages show our observations referring to the channel 1 and 11 respectively.

Test Condition & Setup: same as < 8.1 >

**IEEE 802.11b, Channel 1**

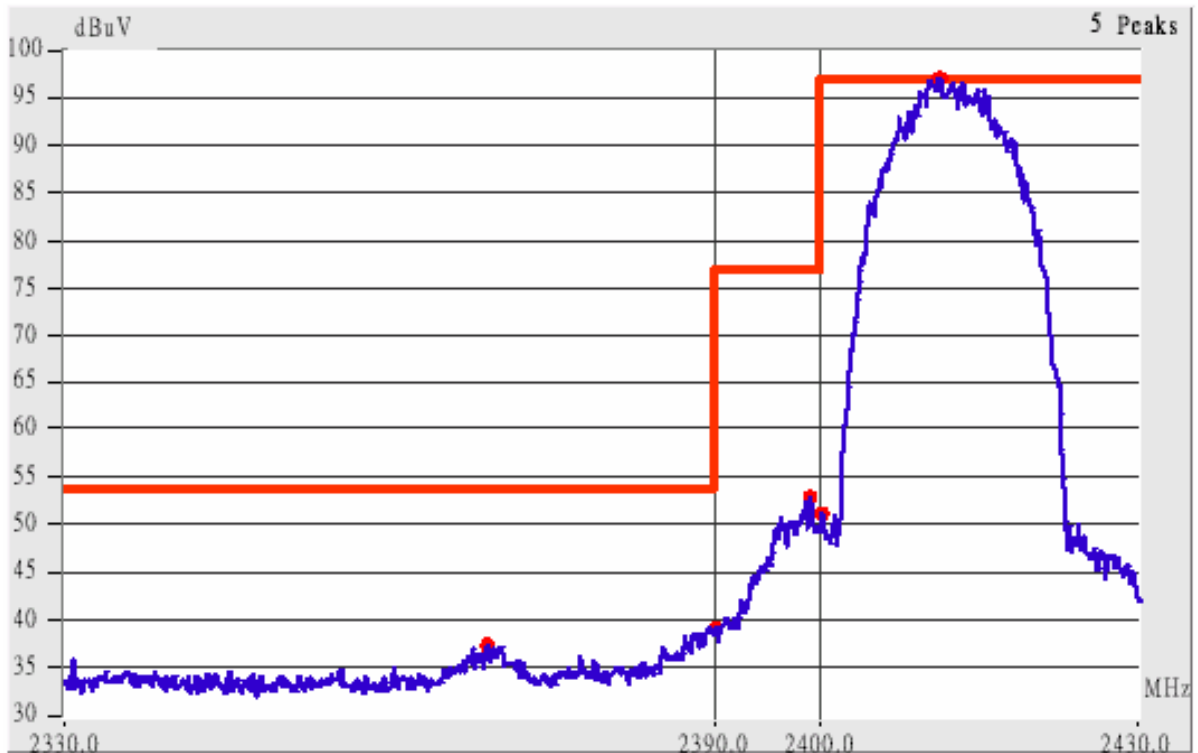

This is the hard copy of our bandedge measurement generated by our bandedge testing program. The plot shown above is the bandedge of channel 1.

1. The lobe left by the fundamental side is already 20dB below the highest emission level.
2. The emissions recorded in the restricted band is do comply with the Part 15.209(a) – as below.

<i>Radiated Emission</i>					<i>Corrected Amplitude</i>		<i>Class B ( 3m )</i>		
<i>Frequency (MHz)</i>	<i>Ant. P.</i>	<i>Ant. H. (m)</i>	<i>Angle ( ° )</i>	<i>Factors (dB)</i>	<i>(dBµV/m)</i>		<i>Limit (dBµV/m)</i>		<i>Margin (dB)</i>
					<i>Peak</i>	<i>Average</i>	<i>Peak</i>	<i>Ave.</i>	
2389.37	Hor	1.00	159	9.18	49.18	---	73.96	53.96	-4.78
2390.02	Hor	1.00	162	9.18	46.68	---	73.96	53.96	-7.28
2387.85	Ver	1.00	122	9.18	47.68	---	73.96	53.96	-6.28
2390.02	Ver	1.00	127	9.18	47.35	---	73.96	53.96	-6.61

IEEE 802.11b, Channel 11

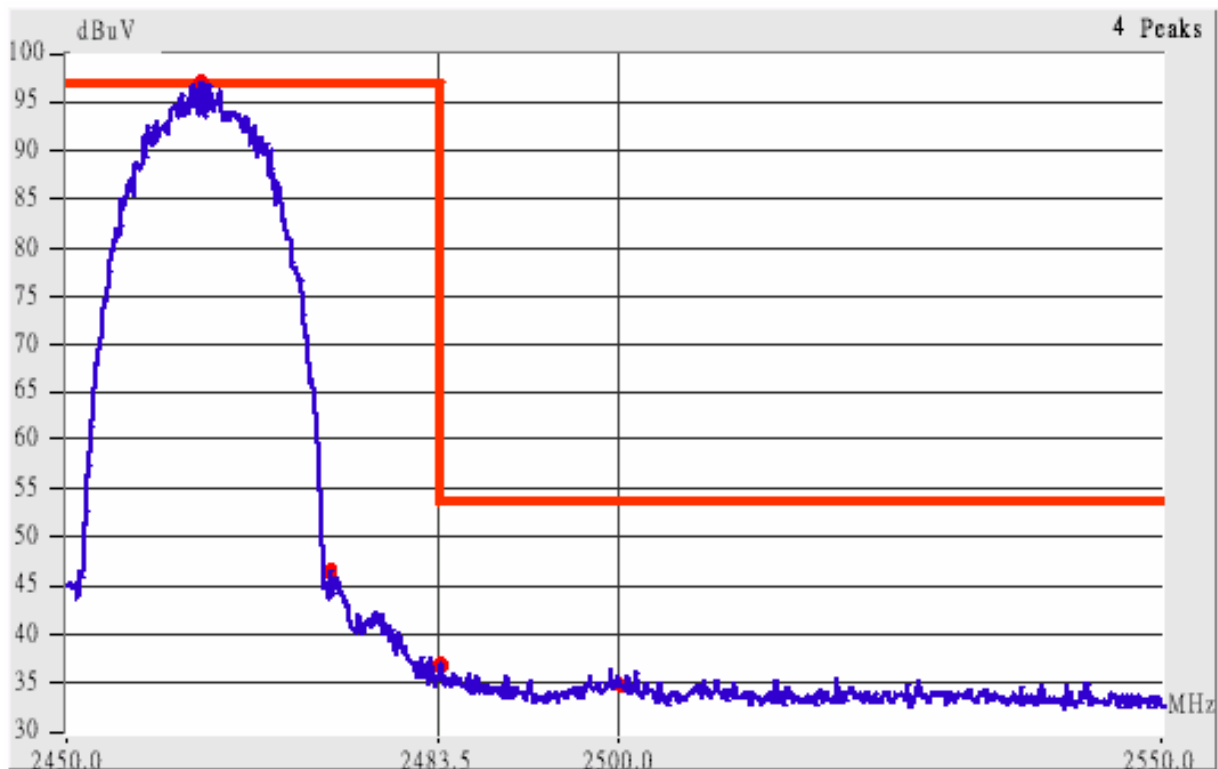

This is the hard copy of our bandedge measurement generated by our bandedge testing program. The plot shown above is the bandedge of channel 11.

- 3. The lobe right by the fundamental side is already 20dB below the highest emission level.
- 4. The emissions recorded in the restricted band is do comply with the Part 15.209(a) – as below

<i>Radiated Emission</i>					<i>Corrected Amplitude</i>		<i>Class B ( 3m )</i>		
<i>Frequency (MHz)</i>	<i>Ant. P.</i>	<i>Ant. H. (m)</i>	<i>Angle ( ° )</i>	<i>Factors (dB)</i>	<i>(dBµV/m)</i>		<i>Limit (dBµV/m)</i>		<i>Margin (dB)</i>
					<i>Peak</i>	<i>Average</i>	<i>Peak</i>	<i>Ave.</i>	
2484.43	Hor	1.00	170	9.45	47.28	---	73.96	53.96	-6.68
2508.35	Hor	1.00	170	9.51	45.84	---	73.96	53.96	-8.12
2483.50	Ver	1.00	221	9.44	45.94	---	73.96	53.96	-8.02
2485.43	Ver	1.00	221	9.45	46.62	---	73.96	53.96	-7.34
2500.01	Ver	1.00	233	9.49	43.32	---	73.96	53.96	-10.64
2501.35	Ver	1.00	222	9.49	45.66	---	73.96	53.96	-8.30

IEEE 802.11g, Channel 1

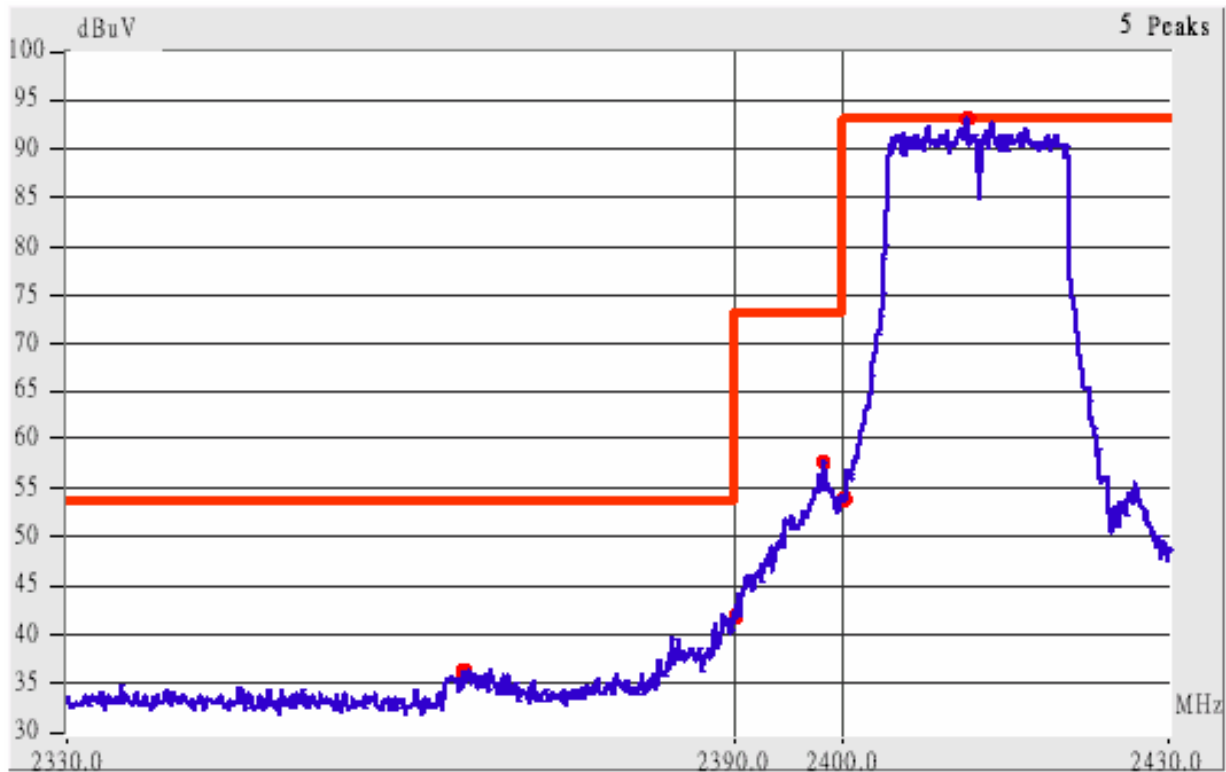

This is the hard copy of our bandedge measurement generated by our bandedge testing program. The plot shown above is the bandedge of channel 1.

1. The lobe left by the fundamental side is already 20dB below the highest emission level.
2. The emissions recorded in the restricted band is do comply with the Part 15.209(a) – as below.

<i>Radiated Emission</i>					<i>Corrected Amplitude</i>		<i>Class B ( 3m )</i>		
<i>Frequency (MHz)</i>	<i>Ant. P.</i>	<i>Ant. H. (m)</i>	<i>Angle ( ° )</i>	<i>Factors (dB)</i>	<i>(dBµV/m)</i>		<i>Limit (dBµV/m)</i>		<i>Margin (dB)</i>
					<i>Peak</i>	<i>Average</i>	<i>Peak</i>	<i>Ave.</i>	
2386.03	Hor	1.00	78	9.17	52.84	36.17	73.96	53.96	-17.79
2390.42	Hor	1.00	71	9.18	56.85	41.18	73.96	53.96	-12.78
2388.66	Ver	1.00	149	9.18	55.85	37.68	73.96	53.96	-16.28
2389.75	Ver	1.00	151	9.18	54.85	39.68	73.96	53.96	-14.28



IEEE 802.11g, Channel 11

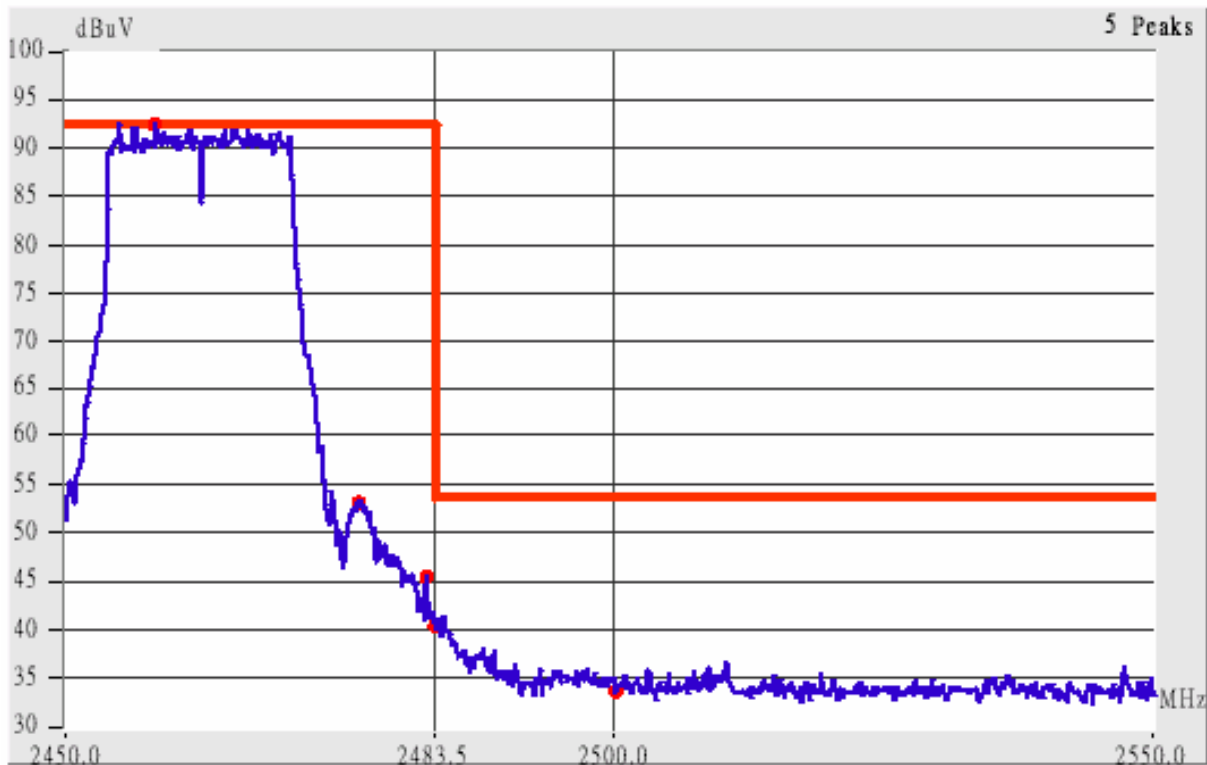

This is the hard copy of our bandedge measurement generated by our bandedge testing program. The plot shown above is the bandedge of channel 11.

- 3. The lobe right by the fundamental side is already 20dB below the highest emission level.
- 4. The emissions recorded in the restricted band is do comply with the Part 15.209(a) – as below

Radiated Emission					Corrected Amplitude		Class B ( 3m )		
Frequency (MHz)	Ant. P.	Ant. H. (m)	Angle ( ° )	Factors (dB)	(dBµV/m)		Limit (dBµV/m)		Margin (dB)
					Peak	Average	Peak	Ave.	
2483.26	Hor	1.00	132	9.44	54.94	39.11	73.96	53.96	-14.85
2483.87	Hor	1.00	126	9.44	54.11	38.11	73.96	53.96	-15.85
2500.01	Hor	1.00	137	9.49	44.32	---	73.96	53.96	-9.64
2483.27	Ver	1.00	175	9.44	54.28	38.94	73.96	53.96	-15.02
2485.25	Ver	1.00	181	9.45	51.62	36.61	73.96	53.96	-17.35
2500.01	Ver	1.00	141	9.49	43.32	---	73.96	53.96	-10.64

## IX. Section 15.247(d): Power Spectral Density

### 9.1 Test Condition & Setup

The tests below are running with the EUT transmitter set at high power in TDD mode. The EUT is needed to force selection of output power level and channel number. While testing, the EUT was set to transmit continuously and to be tested by the contact manner with the spectrum analyzer.

### 9.2 Test Instruments Configuration

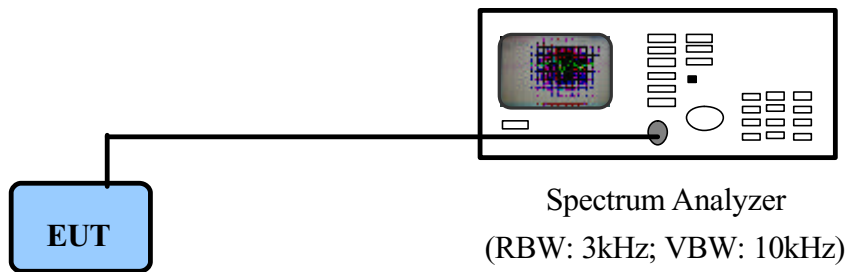

*PC to control the EUT at maximal power output and channel number and set antenna kit*

### 9.3 List of Test Instruments

Instrument Name	Model No.	Brand	Serial No.	Next time
Spectrum Analyzer	MS2665C	ANRITSU	6200175476	12/30/04

**9.4 Test Result of Power spectral density**

The following table shows a summary of the test results of the Power Spectral Density.

**IEEE 802.11b**

<i>Channel</i>	<i>Ppr (dBm)</i>	<i>Cable Loss (dB)</i>	<i>Ppq (dBm)</i>	<i>Limit (dB)</i>	<i>Margin (dB)</i>
CH 01	-15.57	1.00	-14.57	8.00	-22.57
CH 06	-15.26	1.00	-14.26	8.00	-22.26
CH 11	-15.19	1.00	-14.19	8.00	-22.19

**IEEE 802.11g**

<i>Channel</i>	<i>Ppr (dBm)</i>	<i>Cable Loss (dB)</i>	<i>Ppq (dBm)</i>	<i>Limit (dB)</i>	<i>Margin (dB)</i>
CH 01	-17.07	1.00	-16.07	8.00	-24.07
CH 06	-19.50	1.00	-18.50	8.00	-26.50
CH 11	-18.76	1.00	-17.76	8.00	-25.76

Note:

1. The following pages show the results of spectrum reading.
2. Ppr: spectrum read power density (using peak search mode),  
Ppq: actual peak power density in the spread spectrum band.
3.  $Ppq = Ppr + |Cable Loss|$

Power Spectral Density Channel 01



IEEE 802.11b



IEEE 802.11g

Power Spectral Density Channel 06

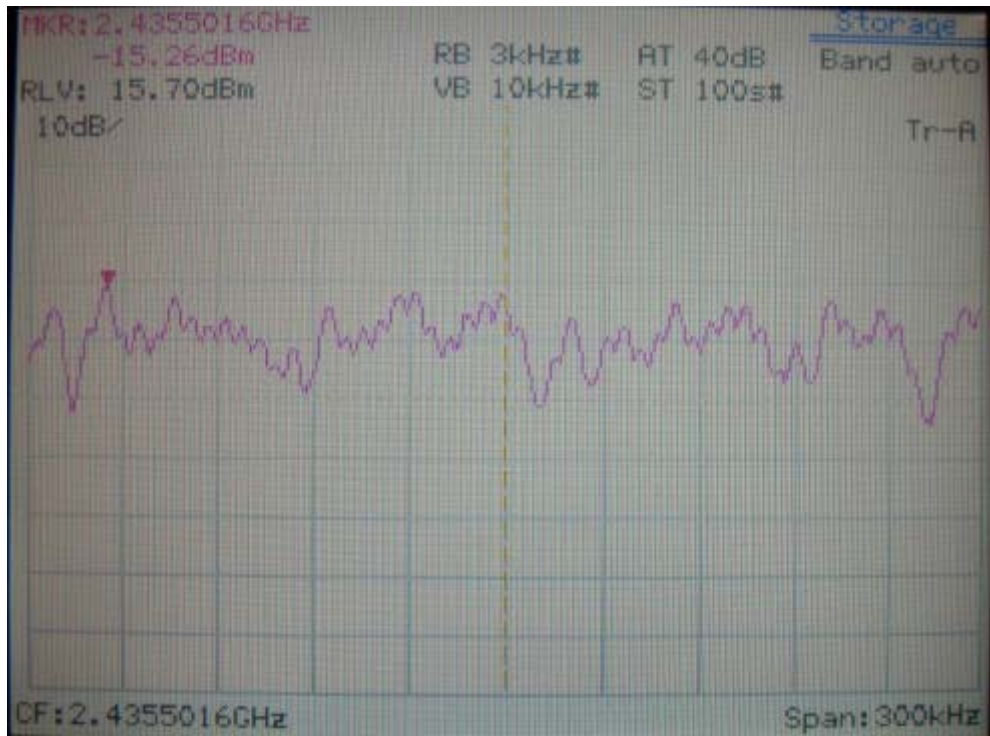

IEEE 802.11b

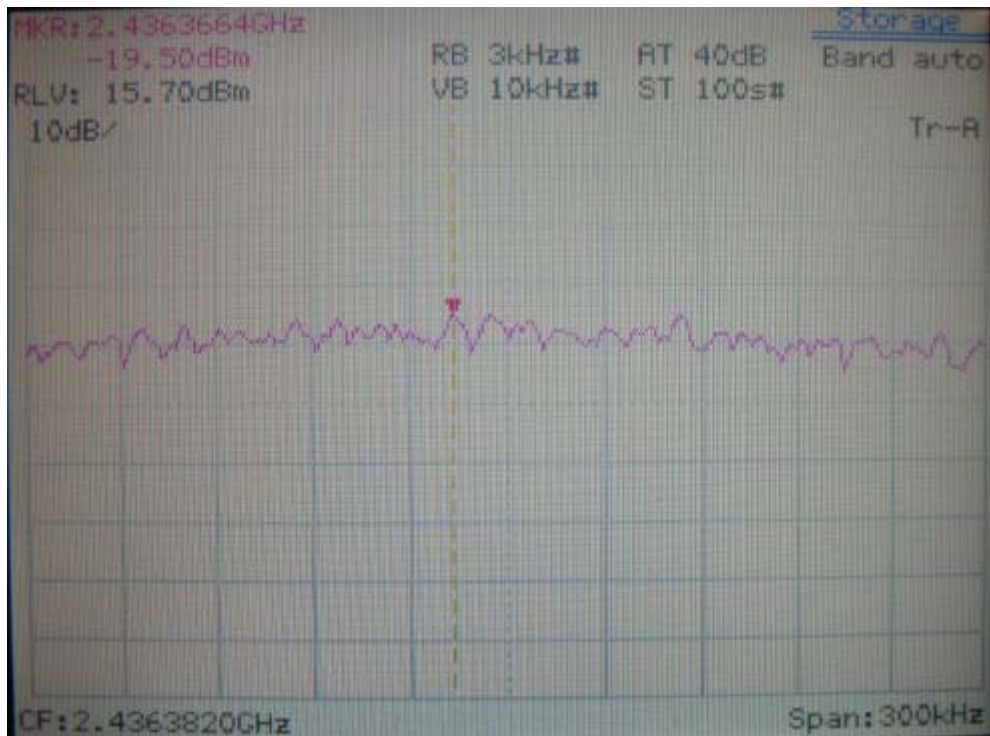

IEEE 802.11g

Power Spectral Density Channel 11

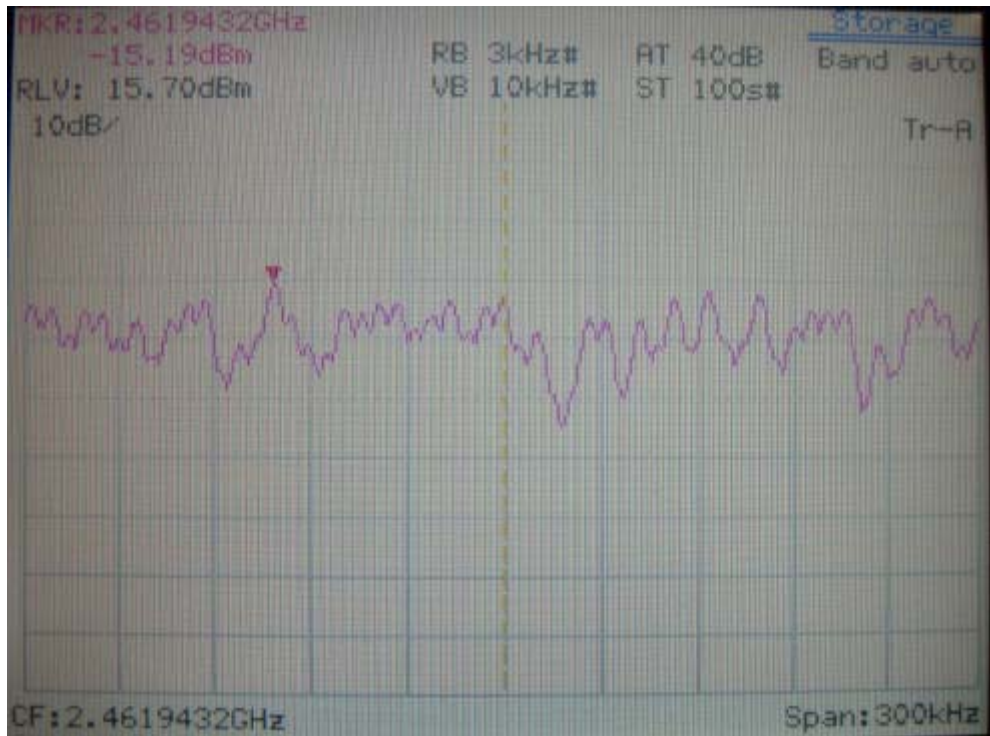

IEEE 802.11b

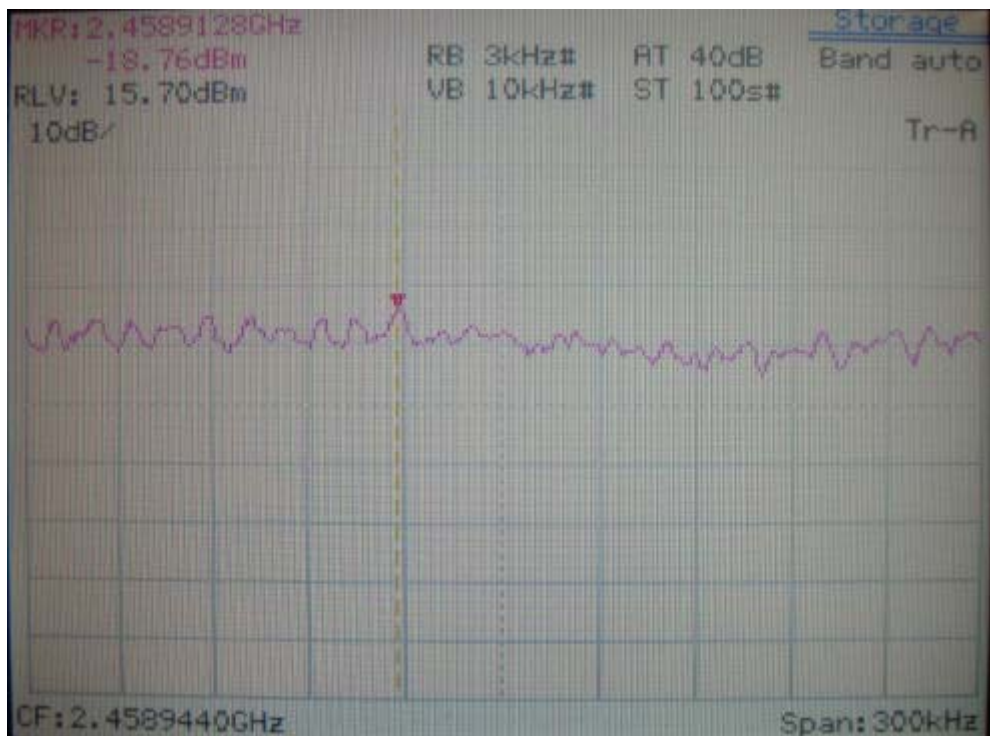

IEEE 802.11g

## Appendix A

### Brand name and Model name List

<i>Brand Name</i>	<i>Model Name</i>
CAMEO	WLG-1500
ALLNET GmbH	ALL0263P
Aopen	AOI-821
Amertek	WLUG
Ovislink	WL-5460USB
KTI	KWG-3000
PheeNet	WLU-703G
Assmann	DN-7003G
LG CNS	LWG5400U
Bona	WLG-USBII
Target	24224
KOBIAN	KOB WL550
GREEN PACKET	WGU100W
Connectland	WIRE-CNL-G-USB
PEABIRD	PEAB-WLG-USB/STICK
NetComm	NP544
KYE	GW-7200U
LEMEL	LM-WLG600U MINI
X-net	WGLDUC
Lantech	WL54G-USB