



FCC TEST REPORT

REPORT NO.: RF960904L04
MODEL NO.: WLG-1308
RECEIVED: Sep. 05, 2007
TESTED: Sep. 05 ~ Sep. 21, 2007
ISSUED: Sep. 27, 2007

APPLICANT : CAMEO COMMUNICATIONS, INC.

ADDRESS : 5F, No.42, Sec. 6, Mincyuan E. Rd., Neihu District,
Taipei City 114, Taiwan

ISSUED BY : Advance Data Technology Corporation

LAB ADDRESS : No. 47, 14th Ling, Chia Pau Tsuen, Lin Kou Hsiang
244, Taipei Hsien, Taiwan, R.O.C.

TEST LOCATION : No. 19, Hwa Ya 2nd Rd., Wen Hwa Tsuen, Kwei
Shan Hsiang, Taoyuan Hsien 333, Taiwan, R.O.C.

This test report consists of 69 pages in total. It may be duplicated completely for legal use with the approval of the applicant. It should not be reproduced except in full, without the written approval of our laboratory. The client should not use it to claim product endorsement by TAF, A2LA or any government agencies. The test results in the report only apply to the tested sample.





Table of Contents

1	CERTIFICATION.....	4
2	SUMMARY OF TEST RESULTS	5
2.1	MEASUREMENT UNCERTAINTY	5
3	GENERAL INFORMATION.....	6
3.1	GENERAL DESCRIPTION OF EUT.....	6
3.2	DESCRIPTION OF TEST MODES.....	7
3.2.1	CONFIGURATION OF SYSTEM UNDER TEST	7
3.2.2	TEST MODE APPLICABILITY AND TESTED CHANNEL DETAIL.....	8
3.3	GENERAL DESCRIPTION OF APPLIED STANDARDS	10
3.4	DESCRIPTION OF SUPPORT UNITS.....	10
4	TEST TYPES AND RESULTS	11
4.1	CONDUCTED EMISSION MEASUREMENT	11
4.1.1	LIMITS OF CONDUCTED EMISSION MEASUREMENT.....	11
4.1.2	TEST INSTRUMENTS	11
4.1.3	TEST PROCEDURES	12
4.1.4	DEVIATION FROM TEST STANDARD	12
4.1.5	TEST SETUP	13
4.1.6	EUT OPERATING CONDITIONS	13
4.1.7	TEST RESULTS	14
4.2	RADIATED EMISSION MEASUREMENT	20
4.2.1	LIMITS OF RADIATED EMISSION MEASUREMENT.....	20
4.2.2	TEST INSTRUMENTS	21
4.2.3	TEST PROCEDURES	22
4.2.4	DEVIATION FROM TEST STANDARD	22
4.2.5	TEST SETUP	23
4.2.6	EUT OPERATING CONDITIONS	23
4.2.7	TEST RESULTS	24
4.3	6dB BANDWIDTH MEASUREMENT	41
4.3.1	LIMITS OF 6dB BANDWIDTH MEASUREMENT	41
4.3.2	TEST INSTRUMENTS	41
4.3.3	TEST PROCEDURE	41
4.3.4	DEVIATION FROM TEST STANDARD	41
4.3.5	TEST SETUP	42
4.3.6	EUT OPERATING CONDITIONS	42
4.3.7	TEST RESULTS	43
4.4	MAXIMUM PEAK OUTPUT POWER	47
4.4.1	LIMITS OF MAXIMUM PEAK OUTPUT POWER MEASUREMENT.....	47
4.4.2	TEST INSTRUMENTS	47
4.4.3	TEST PROCEDURES	48
4.4.4	DEVIATION FROM TEST STANDARD	48
4.4.5	TEST SETUP	48
4.4.6	EUT OPERATING CONDITIONS	48



4.4.7	TEST RESULTS	49
4.5	POWER SPECTRAL DENSITY MEASUREMENT	50
4.5.1	LIMITS OF POWER SPECTRAL DENSITY MEASUREMENT	50
4.5.2	TEST INSTRUMENTS	50
4.5.3	TEST PROCEDURE	50
4.5.4	DEVIATION FROM TEST STANDARD	50
4.5.5	TEST SETUP	50
4.5.6	EUT OPERATING CONDITIONS	50
4.5.7	TEST RESULTS	51
4.6	BAND EDGES MEASUREMENT	55
4.6.1	LIMITS OF BAND EDGES MEASUREMENT	55
4.6.2	TEST INSTRUMENTS	55
4.6.3	TEST PROCEDURE	55
4.6.4	DEVIATION FROM TEST STANDARD	55
4.6.5	EUT OPERATING CONDITION	55
4.6.6	TEST RESULTS	56
4.7	ANTENNA REQUIREMENT	66
4.7.1	STANDARD APPLICABLE	66
4.7.2	ANTENNA CONNECTED CONSTRUCTION	66
5	PHOTOGRAPHS OF THE TEST CONFIGURATION	67
6	INFORMATION ON THE TESTING LABORATORIES	68
7	APPENDIX A – MODIFICATIONS RECORDERS FOR ENGINEERING CHANGES TO THE EUT BY THE LAB	69



1 CERTIFICATION

PRODUCT: 802.11g WLAN mini-PCI Adapter
MODEL NO.: WLG-1308
BRAND: CAMEO
APPLICANT: CAMEO COMMUNICATIONS, INC.
TESTED: Sep. 05 ~ Sep. 21, 2007
TEST SAMPLE: ENGINEERING SAMPLE
STANDARDS: **FCC Part 15, Subpart C (Section 15.247)**
ANSI C63.4-2003

The above equipment (model: WLG-1308) has been tested by **Advance Data Technology Corporation**, and found compliance with the requirement of the above standards. The test record, data evaluation & Equipment Under Test (EUT) configurations represented herein are true and accurate accounts of the measurements of the sample's EMC characteristics under the conditions specified in this report.

PREPARED BY : Rennie Wang , **DATE:** Sep. 27, 2007
Rennie Wang / Senior Specialist

TECHNICAL ACCEPTANCE : Long Chen , **DATE:** Sep. 27, 2007
Responsible for RF Long Chen / Senior Engineer

APPROVED BY : Gary Chang , **DATE:** Sep. 27, 2007
Gary Chang / Assistant Manager

2 SUMMARY OF TEST RESULTS

The EUT has been tested according to the following specifications:

APPLIED STANDARD: FCC Part 15, Subpart C			
Standard Section	Test Type and Limit	Result	Remark
15.207	AC Power Conducted Emission	PASS	Meet the requirement of limit. Minimum passing margin is -11.05dB at 0.176MHz
15.247(a)(2)	Spectrum Bandwidth of a Direct Sequence Spread Spectrum System Limit: min. 500kHz	PASS	Meet the requirement of limit.
15.247(b)	Maximum Peak Output Power Limit: max. 30dBm	PASS	Meet the requirement of limit.
15.247(d)	Radiated Emissions Limit: Table 15.209	PASS	Meet the requirement of limit. Minimum passing margin is -1.34dB at 3216.00MHz
15.247(e)	Power Spectral Density Limit: max. 8dBm	PASS	Meet the requirement of limit.
15.247(d)	Band Edge Measurement Limit: 20dB less than the peak value of fundamental frequency	PASS	Meet the requirement of limit.

2.1 MEASUREMENT UNCERTAINTY

Where relevant, the following measurement uncertainty levels have been estimated for tests performed on the EUT as specified in CISPR 16-4-2:

MEASUREMENT	FREQUENCY	UNCERTAINTY
Conducted emissions	9kHz ~ 30MHz	2.44 dB
Radiated emissions	30MHz ~ 200MHz	2.93 dB
	200MHz ~ 1000MHz	2.95 dB
	1GHz ~ 18GHz	2.26 dB
	18GHz ~ 40GHz	1.94 dB

This uncertainty represents an expanded uncertainty expressed at approximately the 95% confidence level using a coverage factor of k=2.

3 GENERAL INFORMATION

3.1 GENERAL DESCRIPTION OF EUT

PRODUCT	802.11g WLAN mini-PCI Adapter
MODEL NO.	WLG-1308
FCC ID	NHPWLG1308
POWER SUPPLY	3.3Vdc from host equipment
MODULATION TYPE	CCK, DQPSK, DBPSK for DSSS 64QAM, 16QAM, QPSK, BPSK for OFDM
MODULATION TECHNOLOGY	DSSS, OFDM
TRANSFER RATE	802.11b: 11/5.5/2/1Mbps 802.11g: 54/48/36/24/18/12/9/6Mbps
FREQUENCY RANGE	2412MHz ~ 2462MHz
NUMBER OF CHANNEL	11
MAXIMUM OUTPUT POWER	71.614mW
ANTENNA TYPE	Dipole antenna with 2dBi gain PIFA antenna with 0dBi gain
DATA CABLE	NA
I/O PORTS	NA
ACCESSORY DEVICES	NA

NOTE:

1. The EUT, operates in the 2.4GHz frequency range, lets you connect IEEE 802.11g or IEEE 802.11b devices to the network. With its high-speed data transmissions of up to 54Mbps.
2. The above EUT information was declared by manufacturer and for more detailed features description, please refer to the manufacturer's specifications or User's Manual.

3.2 DESCRIPTION OF TEST MODES

Eleven channels are provided to this EUT.

CHANNEL	FREQUENCY	CHANNEL	FREQUENCY
1	2412 MHz	7	2442 MHz
2	2417 MHz	8	2447 MHz
3	2422 MHz	9	2452 MHz
4	2427 MHz	10	2457 MHz
5	2432 MHz	11	2462 MHz
6	2437 MHz		

3.2.1 CONFIGURATION OF SYSTEM UNDER TEST

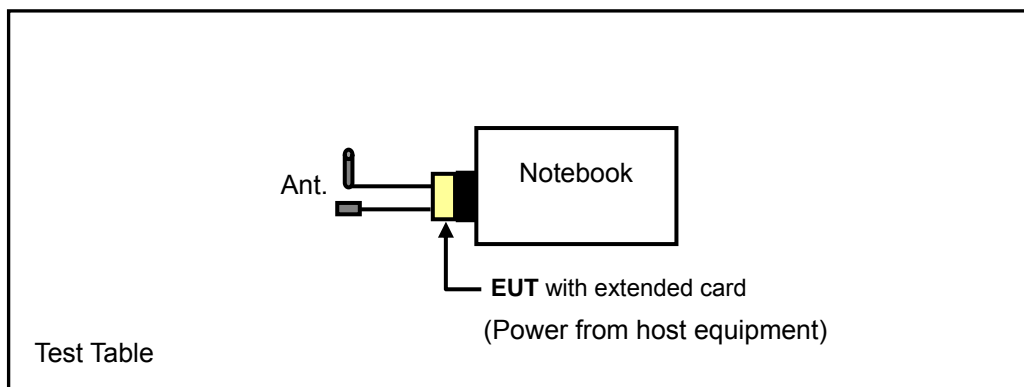

3.2.2 TEST MODE APPLICABILITY AND TESTED CHANNEL DETAIL

EUT Configure Mode	Applicable to				Description
	PLC	RE<1G	RE≥1G	APCM	
A	√	√	√	√	Dipole antenna
B	-	√	√	-	PIFA antenna

Where **PLC**: Power Line Conducted Emission **RE<1G**: Radiated Emission below 1GHz
RE≥1G: Radiated Emission above 1GHz **APCM**: Antenna Port Conducted Measurement

NOTE: "-" means no effect.

POWER LINE CONDUCTED EMISSION TEST:

- Pre-Scan has been conducted to determine the worst-case mode from all possible combinations between available modulations, data rates and antenna ports (if EUT with antenna diversity architecture).
- Following channel(s) was (were) selected for the final test as listed below.

EUT Configure Mode	Mode	Available Channel	Tested Channel	Modulation Technology	Modulation Type	Data Rate (Mbps)
A	802.11g	1 to 11	1, 6, 11	OFDM	BPSK	6

RADIATED EMISSION TEST (BELOW 1 GHz):

- Pre-Scan has been conducted to determine the worst-case mode from all possible combinations between available modulations, data rates, XYZ Axis and antenna ports (if EUT with antenna diversity architecture).
- Following channel(s) was (were) selected for the final test as listed below.

EUT Configure Mode	Mode	Available Channel	Tested Channel	Modulation Technology	Modulation Type	Data Rate (Mbps)
A ; B	802.11g	1 to 11	11	OFDM	BPSK	6

RADIATED EMISSION TEST (ABOVE 1 GHz):

- Pre-Scan has been conducted to determine the worst-case mode from all possible combinations between available modulations, data rates, XYZ Axis and antenna ports (if EUT with antenna diversity architecture).
- Following channel(s) was (were) selected for the final test as listed below.

EUT Configure Mode	Mode	Available Channel	Tested Channel	Modulation Technology	Modulation Type	Data Rate (Mbps)
A ; B	802.11b	1 to 11	1, 6, 11	DSSS	DBPSK	1
A ; B	802.11g	1 to 11	1, 6, 11	OFDM	BPSK	6



BANDEDGE MEASUREMENT:

- Pre-Scan has been conducted to determine the worst-case mode from all possible combinations between available modulations, data rates and antenna ports (if EUT with antenna diversity architecture).
- Following channel(s) was (were) selected for the final test as listed below.

EUT Configure Mode	Mode	Available Channel	Tested Channel	Modulation Technology	Modulation Type	Data Rate (Mbps)
A	802.11b	1 to 11	1, 11	DSSS	DBPSK	1
A	802.11g	1 to 11	1, 11	OFDM	BPSK	6

ANTENNA PORT CONDUCTED MEASUREMENT:

- Pre-Scan has been conducted to determine the worst-case mode from all possible combinations between available modulations, data rates and antenna ports (if EUT with antenna diversity architecture).
- Following channel(s) was (were) selected for the final test as listed below.

EUT Configure Mode	Mode	Available Channel	Tested Channel	Modulation Technology	Modulation Type	Data Rate (Mbps)
A	802.11b	1 to 11	1, 6, 11	DSSS	DBPSK	1
A	802.11g	1 to 11	1, 6, 11	OFDM	BPSK	6



3.3 GENERAL DESCRIPTION OF APPLIED STANDARDS

The EUT is a RF product. According to the specifications of the manufacturer, it must comply with the requirements of the following standards:

FCC Part 15, Subpart C. (15.247)

ANSI C63.4- 2003

All test items have been performed and recorded as per the above standards.

NOTE: The EUT is also considered as a kind of computer peripheral, because the connection to computer is necessary for typical use. It has been verified to comply with the requirements of FCC Part 15, Subpart B, Class B (DoC). The test report has been issued separately.

3.4 DESCRIPTION OF SUPPORT UNITS

The EUT has been tested as an independent unit together with other necessary accessories or support units. The following support units or accessories were used to form a representative test configuration during the tests.

NO.	PRODUCT	BRAND	MODEL NO.	SERIAL NO.	FCC ID
1	NOTEBOOK COMPUTER	DELL	PP05L	16484462992	E2K24CLNS

NO.	SIGNAL CABLE DESCRIPTION OF THE ABOVE SUPPORT UNITS
1	NA

NOTE: All power cords of the above support units are non shielded (1.8m).

4 TEST TYPES AND RESULTS

4.1 CONDUCTED EMISSION MEASUREMENT

4.1.1 LIMITS OF CONDUCTED EMISSION MEASUREMENT

FREQUENCY OF EMISSION (MHz)	CONDUCTED LIMIT (dB μ V)	
	Quasi-peak	Average
0.15 ~ 0.5	66 to 56	56 to 46
0.5 ~ 5	56	46
5 ~ 30	60	50

- NOTE:**
1. The lower limit shall apply at the transition frequencies.
 2. The limit decreases in line with the logarithm of the frequency in the range of 0.15 to 0.50 MHz.
 3. All emanations from a class A/B digital device or system, including any network of conductors and apparatus connected thereto, shall not exceed the level of field strengths specified above.

4.1.2 TEST INSTRUMENTS

DESCRIPTION & MANUFACTURER	MODEL NO.	SERIAL NO.	CALIBRATED UNTIL
Test Receiver ROHDE & SCHWARZ	ESCS30	100289	Dec. 08, 2007
RF signal cable Woken	5D-FB	Cable-HYCO3-01	Jan. 06, 2008
LISN ROHDE & SCHWARZ	ESH2-Z5	100100	Jan. 08, 2008
LISN ROHDE & SCHWARZ	ESH3-Z5	100311	Jan. 16, 2008
Software ADT	ADT_Cond_V3	NA	NA

- NOTE:**
1. The calibration interval of the above test instruments is 12 months and the calibrations are traceable to NML/ROC and NIST/USA.
 2. The test was performed in HwaYa Shielded Room 2.
 3. The VCCI Site Registration No. is C-2047.

4.1.3 TEST PROCEDURES

- a. The EUT was placed 0.4 meters from the conducting wall of the shielded room with EUT being connected to the power mains through a line impedance stabilization network (LISN). Other support units were connected to the power mains through another LISN. The two LISNs provide 50 ohm/ 50uH of coupling impedance for the measuring instrument.
- b. Both lines of the power mains connected to the EUT were checked for maximum conducted interference.
- c. The frequency range from 150kHz to 30MHz was searched. Emission levels under (Limit - 20dB) was not recorded.

4.1.4 DEVIATION FROM TEST STANDARD

No deviation.

4.1.5 TEST SETUP

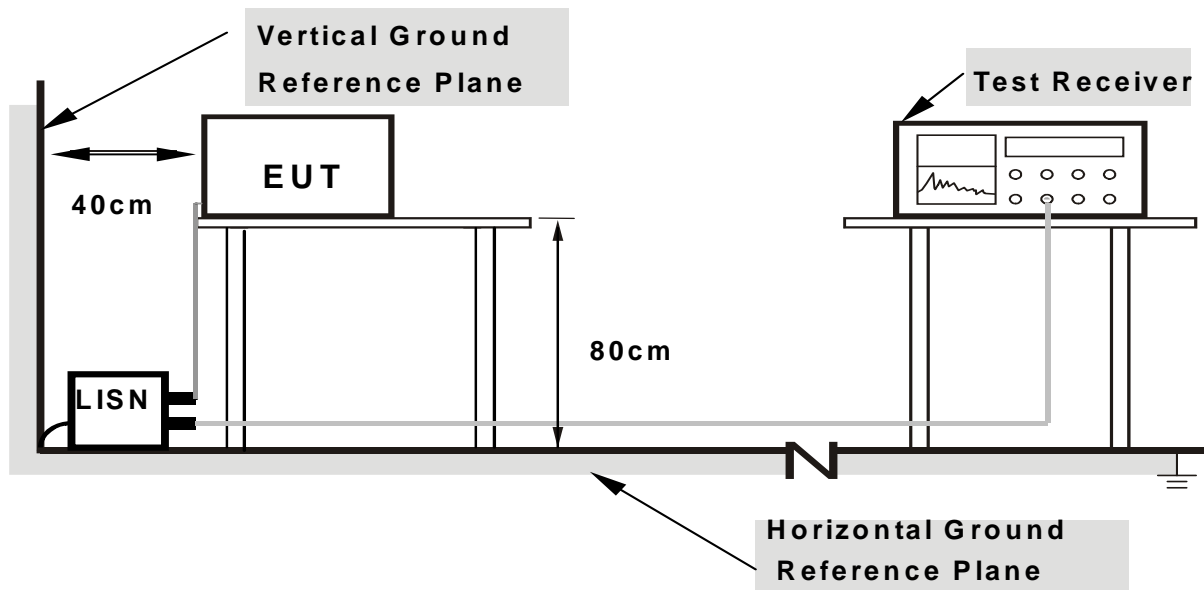

Note: 1.Support units were connected to second LISN.

2.Both of LISNs (AMN) are 80 cm from EUT and at least 80 from other units and other metal planes

For the actual test configuration, please refer to the attached file (Test Setup Photo).

4.1.6 EUT OPERATING CONDITIONS

- a. Connected the EUT via extended card to notebook and placed on a testing table.
- b. The notebook ran a test program (provided by manufacturer) to enable EUT under transmission condition continuously at specific channel frequency.

4.1.7 TEST RESULTS

CONDUCTED WORST-CASE DATA

EUT TEST CONDITION		MEASUREMENT DETAIL	
CHANNEL	Channel 1	PHASE	Line 1
MODULATION TYPE	BPSK	6dB BANDWIDTH	9 kHz
TRANSFER RATE	6Mbps	ENVIRONMENTAL CONDITIONS	27deg. C, 68%RH, 998hPa
INPUT POWER (SYSTEM)	120Vac, 60 Hz	TESTED BY	Dean Wang

No	Freq. [MHz]	Corr. Factor (dB)	Reading Value		Emission Level		Limit		Margin	
			[dB (uV)]		[dB (uV)]		[dB (uV)]		(dB)	
			Q.P.	AV.	Q.P.	AV.	Q.P.	AV.	Q.P.	AV.
1	0.176	0.10	52.49	-	52.59	-	64.67	54.67	-12.08	-
2	0.233	0.10	44.09	-	44.19	-	62.33	52.33	-18.14	-
3	0.351	0.10	34.51	-	34.61	-	58.95	48.95	-24.34	-
4	0.410	0.10	31.88	-	31.98	-	57.65	47.65	-25.67	-
5	3.867	0.28	33.58	-	33.86	-	56.00	46.00	-22.14	-
6	4.395	0.28	30.85	-	31.13	-	56.00	46.00	-24.87	-

- REMARKS:**
1. Q.P. and AV. are abbreviations of quasi-peak and average individually.
 2. "-": The Quasi-peak reading value also meets average limit and measurement with the average detector is unnecessary.
 3. The emission levels of other frequencies were very low against the limit.
 4. Margin value = Emission level - Limit value
 5. Correction factor = Insertion loss + Cable loss
 6. Emission Level = Correction Factor + Reading Value.

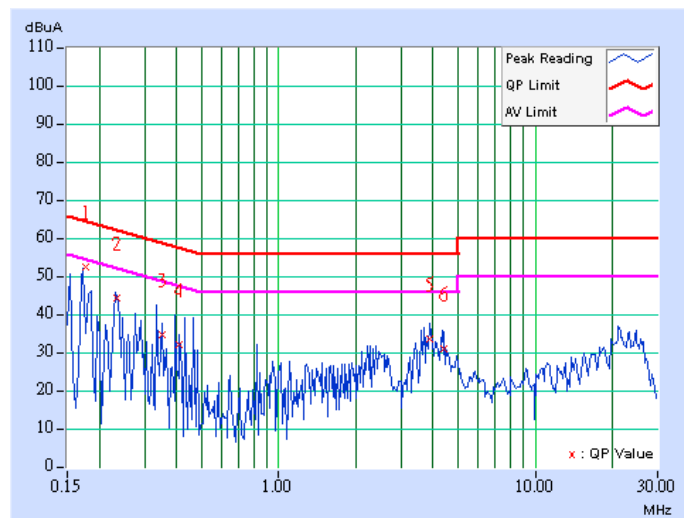

EUT TEST CONDITION		MEASUREMENT DETAIL	
CHANNEL	Channel 1	PHASE	Line 2
MODULATION TYPE	BPSK	6dB BANDWIDTH	9 kHz
TRANSFER RATE	6Mbps	ENVIRONMENTAL CONDITIONS	27deg. C, 68%RH, 998hPa
INPUT POWER (SYSTEM)	120Vac, 60 Hz	TESTED BY	Dean Wang

No	Freq. [MHz]	Corr.	Reading Value		Emission Level		Limit		Margin	
		Factor	[dB (uV)]		[dB (uV)]		[dB (uV)]		(dB)	
		(dB)	Q.P.	AV.	Q.P.	AV.	Q.P.	AV.	Q.P.	AV.
1	0.176	0.10	53.52	-	53.62	-	64.67	54.67	-11.05	-
2	0.295	0.10	41.47	-	41.57	-	60.40	50.40	-18.83	-
3	0.350	0.10	36.27	-	36.37	-	58.96	48.96	-22.59	-
4	0.411	0.10	35.17	-	35.27	-	57.63	47.63	-22.35	-
5	2.113	0.22	30.81	-	31.03	-	56.00	46.00	-24.97	-
6	3.988	0.28	37.16	-	37.44	-	56.00	46.00	-18.56	-

- REMARKS:**
1. Q.P. and AV. are abbreviations of quasi-peak and average individually.
 2. "-": The Quasi-peak reading value also meets average limit and measurement with the average detector is unnecessary.
 3. The emission levels of other frequencies were very low against the limit.
 4. Margin value = Emission level - Limit value
 5. Correction factor = Insertion loss + Cable loss
 6. Emission Level = Correction Factor + Reading Value.

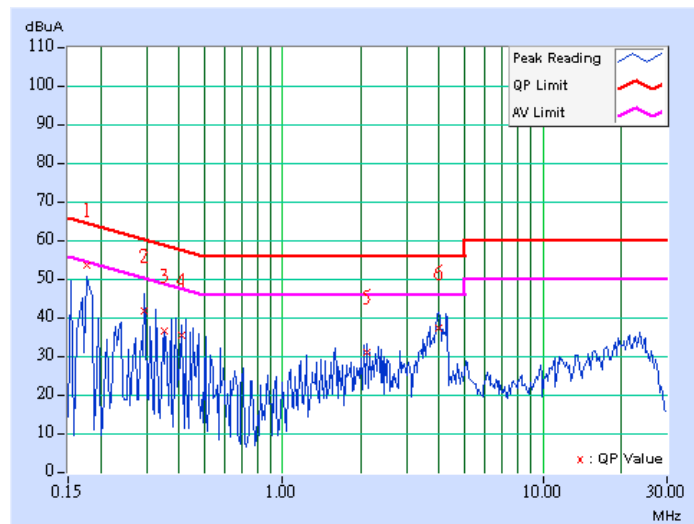

EUT TEST CONDITION		MEASUREMENT DETAIL	
CHANNEL	Channel 6	PHASE	Line 1
MODULATION TYPE	BPSK	6dB BANDWIDTH	9 kHz
TRANSFER RATE	6Mbps	ENVIRONMENTAL CONDITIONS	27deg. C, 68%RH, 998hPa
INPUT POWER (SYSTEM)	120Vac, 60 Hz	TESTED BY	Dean Wang

No	Freq. [MHz]	Corr.	Reading Value		Emission Level		Limit		Margin	
		Factor	[dB (uV)]		[dB (uV)]		[dB (uV)]		(dB)	
		(dB)	Q.P.	AV.	Q.P.	AV.	Q.P.	AV.	Q.P.	AV.
1	0.176	0.10	51.43	-	51.53	-	64.67	54.67	-13.14	-
2	0.235	0.10	43.34	-	43.44	-	62.29	52.29	-18.85	-
3	0.352	0.10	34.14	-	34.24	-	58.92	48.92	-24.68	-
4	0.410	0.10	31.67	-	31.77	-	57.66	47.66	-25.89	-
5	4.098	0.28	34.92	-	35.20	-	56.00	46.00	-20.80	-
6	23.520	0.75	27.65	-	28.40	-	60.00	50.00	-31.60	-

- REMARKS:**
1. Q.P. and AV. are abbreviations of quasi-peak and average individually.
 2. "-": The Quasi-peak reading value also meets average limit and measurement with the average detector is unnecessary.
 3. The emission levels of other frequencies were very low against the limit.
 4. Margin value = Emission level - Limit value
 5. Correction factor = Insertion loss + Cable loss
 6. Emission Level = Correction Factor + Reading Value.

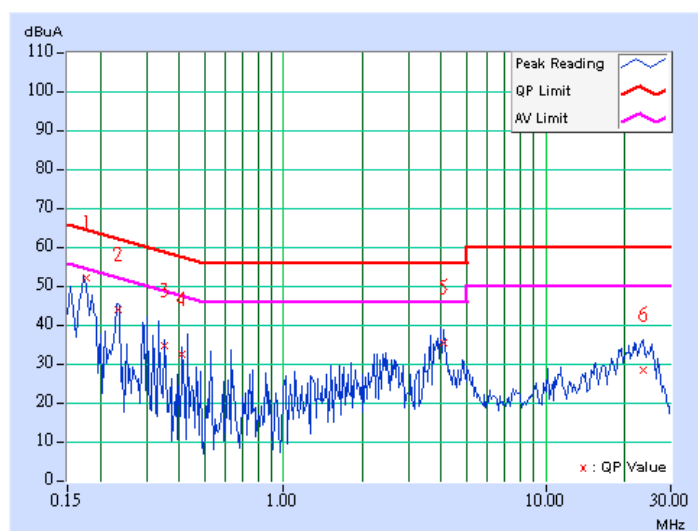

EUT TEST CONDITION		MEASUREMENT DETAIL	
CHANNEL	Channel 6	PHASE	Line 2
MODULATION TYPE	BPSK	6dB BANDWIDTH	9 kHz
TRANSFER RATE	6Mbps	ENVIRONMENTAL CONDITIONS	27deg. C, 68%RH, 998hPa
INPUT POWER (SYSTEM)	120Vac, 60 Hz	TESTED BY	Dean Wang

No	Freq. [MHz]	Corr.	Reading Value		Emission Level		Limit		Margin	
		Factor	[dB (uV)]		[dB (uV)]		[dB (uV)]		(dB)	
		(dB)	Q.P.	AV.	Q.P.	AV.	Q.P.	AV.	Q.P.	AV.
1	0.176	0.10	51.80	-	51.90	-	64.66	54.66	-12.76	-
2	0.234	0.10	44.03	-	44.13	-	62.30	52.30	-18.17	-
3	0.293	0.10	40.90	-	41.00	-	60.43	50.43	-19.43	-
4	0.410	0.10	34.37	-	34.47	-	57.64	47.64	-23.17	-
5	2.227	0.23	28.07	-	28.30	-	56.00	46.00	-27.70	-
6	3.982	0.28	36.43	-	36.71	-	56.00	46.00	-19.29	-

- REMARKS:**
1. Q.P. and AV. are abbreviations of quasi-peak and average individually.
 2. "-": The Quasi-peak reading value also meets average limit and measurement with the average detector is unnecessary.
 3. The emission levels of other frequencies were very low against the limit.
 4. Margin value = Emission level - Limit value
 5. Correction factor = Insertion loss + Cable loss
 6. Emission Level = Correction Factor + Reading Value.

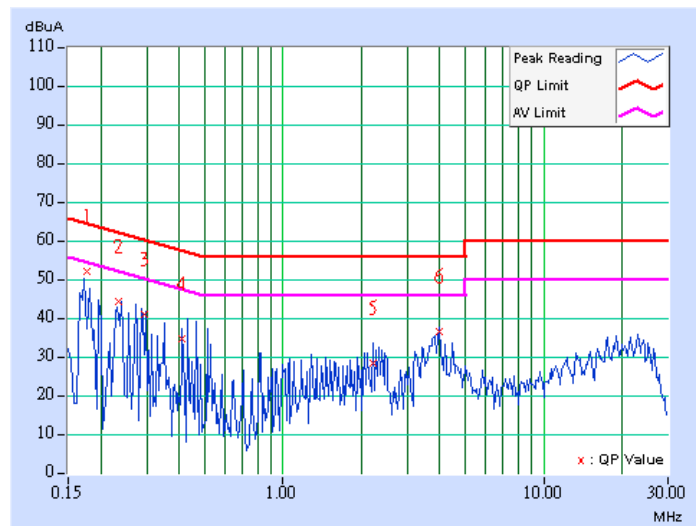

EUT TEST CONDITION		MEASUREMENT DETAIL	
CHANNEL	Channel 11	PHASE	Line 1
MODULATION TYPE	BPSK	6dB BANDWIDTH	9 kHz
TRANSFER RATE	6Mbps	ENVIRONMENTAL CONDITIONS	27deg. C, 68%RH, 998hPa
INPUT POWER (SYSTEM)	120Vac, 60 Hz	TESTED BY	Dean Wang

No	Freq. [MHz]	Corr.	Reading Value		Emission Level		Limit		Margin	
		Factor	[dB (uV)]		[dB (uV)]		[dB (uV)]		(dB)	
		(dB)	Q.P.	AV.	Q.P.	AV.	Q.P.	AV.	Q.P.	AV.
1	0.175	0.10	50.27	-	50.37	-	64.73	54.73	-14.36	-
2	0.291	0.10	38.42	-	38.52	-	60.49	50.49	-21.97	-
3	0.351	0.10	32.94	-	33.04	-	58.94	48.94	-25.90	-
4	0.584	0.10	23.67	-	23.77	-	56.00	46.00	-32.23	-
5	2.162	0.22	29.37	-	29.59	-	56.00	46.00	-26.41	-
6	4.199	0.28	26.88	-	27.16	-	56.00	46.00	-28.84	-

- REMARKS:**
1. Q.P. and AV. are abbreviations of quasi-peak and average individually.
 2. "-": The Quasi-peak reading value also meets average limit and measurement with the average detector is unnecessary.
 3. The emission levels of other frequencies were very low against the limit.
 4. Margin value = Emission level - Limit value
 5. Correction factor = Insertion loss + Cable loss
 6. Emission Level = Correction Factor + Reading Value.

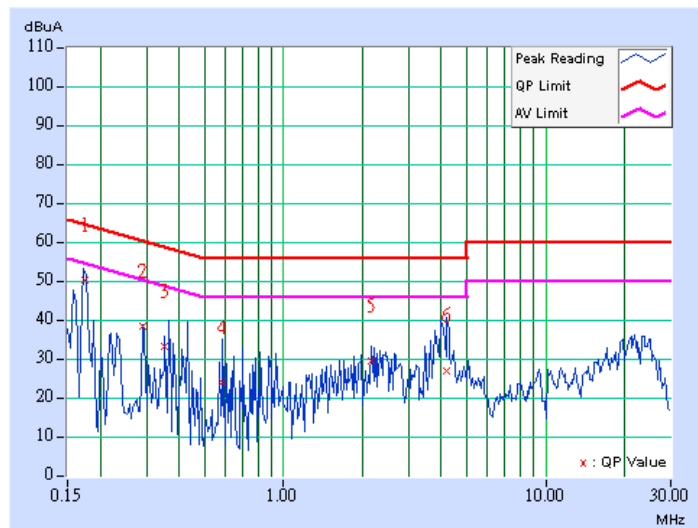

EUT TEST CONDITION		MEASUREMENT DETAIL	
CHANNEL	Channel 11	PHASE	Line 2
MODULATION TYPE	BPSK	6dB BANDWIDTH	9 kHz
TRANSFER RATE	6Mbps	ENVIRONMENTAL CONDITIONS	27deg. C, 68%RH, 998hPa
INPUT POWER (SYSTEM)	120Vac, 60 Hz	TESTED BY	Dean Wang

No	Freq. [MHz]	Corr.	Reading Value		Emission Level		Limit		Margin	
		Factor	[dB (uV)]		[dB (uV)]		[dB (uV)]		(dB)	
		(dB)	Q.P.	AV.	Q.P.	AV.	Q.P.	AV.	Q.P.	AV.
1	0.176	0.10	51.68	-	51.78	-	64.67	54.67	-12.89	-
2	0.233	0.10	43.95	-	44.05	-	62.33	52.33	-18.28	-
3	0.293	0.10	40.69	-	40.79	-	60.43	50.43	-19.64	-
4	0.409	0.10	34.40	-	34.50	-	57.67	47.67	-23.16	-
5	3.512	0.27	30.36	-	30.63	-	56.00	46.00	-25.37	-
6	3.918	0.28	36.42	-	36.70	-	56.00	46.00	-19.30	-

- REMARKS:**
1. Q.P. and AV. are abbreviations of quasi-peak and average individually.
 2. "-": The Quasi-peak reading value also meets average limit and measurement with the average detector is unnecessary.
 3. The emission levels of other frequencies were very low against the limit.
 4. Margin value = Emission level - Limit value
 5. Correction factor = Insertion loss + Cable loss
 6. Emission Level = Correction Factor + Reading Value.

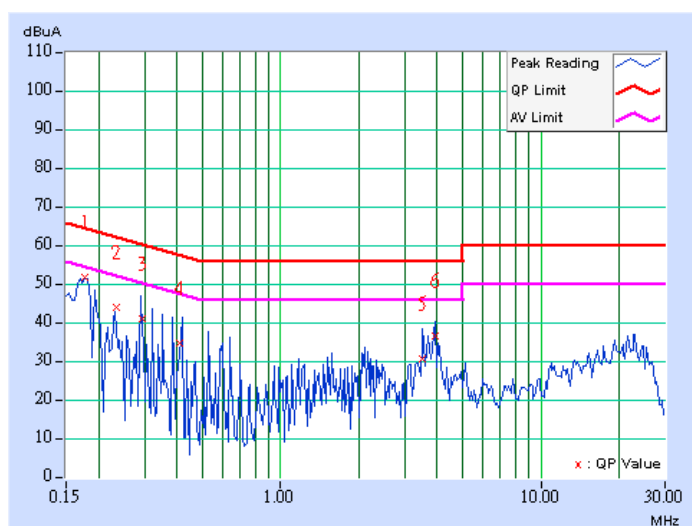

4.2 RADIATED EMISSION MEASUREMENT

4.2.1 LIMITS OF RADIATED EMISSION MEASUREMENT

Emissions radiated outside of the specified bands, shall be according to the general radiated limits in 15.209 as following:

Frequencies (MHz)	Field strength (microvolts/meter)	Measurement distance (meters)
0.009-0.490	2400/F(kHz)	300
0.490-1.705	24000/F(kHz)	30
1.705-30.0	30	30
30-88	100	3
88-216	150	3
216-960	200	3
Above 960	500	3

NOTE:

1. The lower limit shall apply at the transition frequencies.
2. Emission level (dBuV/m) = 20 log Emission level (uV/m).
3. As shown in 15.35(b), for frequencies above 1000MHz, the field strength limits are based on average detector, however, the peak field strength of any emission shall not exceed the maximum permitted average limits, specified above by more than 20dB under any condition of modulation.



4.2.2 TEST INSTRUMENTS

DESCRIPTION & MANUFACTURER	MODEL NO.	SERIAL NO.	CALIBRATED UNTIL
Test Receiver ROHDE & SCHWARZ	ESCI	100424	Jul. 27, 2008
Spectrum Analyzer ROHDE & SCHWARZ	FSP40	100269	Aug. 05, 2008
BILOG Antenna SCHWARZBECK	VULB9168	9168-153	Jan. 04, 2008
HORN Antenna SCHWARZBECK	BBHA 9120 D	9120D-563	Jul. 30, 2008
HORN Antenna SCHWARZBECK	BBHA 9170	BBHA9170242	Jan. 16, 2008
Preamplifier Agilent	8449B	3008A01910	Sep. 20, 2008
Preamplifier Agilent	8447D	2944A10638	Dec. 20, 2007
RF signal cable HUBER+SUHNNER	SUCOFLEX 104	218188/218189	Nov. 14, 2007
RF signal cable Worken	8D-FB	Cable-HYCH9-01	Aug. 09, 2008
Software	ADT_Radiated_V7.6	NA	NA
Antenna Tower EMCO	2070/2080	512.835.4684	NA
Turn Table EMCO	2087-2.03	NA	NA
Antenna Tower & Turn Table Controller EMCO	2090	NA	NA

- NOTE:**
1. The calibration interval of the above test instruments is 12 months and the calibrations are traceable to NML/ROC and NIST/USA.
 2. The test was performed in HwaYa Chamber 9.
 3. The horn antenna and HP preamplifier (model: 8449B) are used only for the measurement of emission frequency above 1GHz if tested.
 4. The IC Site Registration No. is IC3789B-9.

4.2.3 TEST PROCEDURES

- a. The EUT was placed on the top of a rotating table 0.8 meters above the ground at a 3 meters semi-anechoic chamber. The table was rotated 360 degrees to determine the position of the highest radiation.
- b. The EUT was set 3 meters away from the interference-receiving antenna, which was mounted on the top of a variable-height antenna tower.
- c. The antenna is a broadband antenna, and its height is varied from one meter to four meters above the ground to determine the maximum value of the field strength. Both horizontal and vertical polarizations of the antenna are set to make the measurement.
- d. For each suspected emission, the EUT was arranged to its worst case and then the antenna was tuned to heights from 1 meter to 4 meters and the rotatable table was turned from 0 degrees to 360 degrees to find the maximum reading.
- e. The test-receiver system was set to Peak Detect Function and Specified Bandwidth with Maximum Hold Mode.
- f. If the emission level of the EUT in peak mode was lower than the limit specified, then testing could be stopped and the peak values of the EUT would be reported. Otherwise the emissions would be re-tested one by one using peak, quasi-peak method or average method as specified and then reported in data sheet.

NOTE:

1. The resolution bandwidth and video bandwidth of test receiver/spectrum analyzer is 120kHz for Peak detection (PK) and Quasi-peak detection (QP) at frequency below 1GHz.
2. The resolution bandwidth of test receiver/spectrum analyzer is 1 MHz and video bandwidth is 3MHz for Peak detection at frequency above 1GHz.
3. The resolution bandwidth of test receiver/spectrum analyzer is 1 MHz and the video bandwidth is 10 Hz for Average detection (AV) at frequency above 1GHz.

4.2.4 DEVIATION FROM TEST STANDARD

No deviation.

4.2.5 TEST SETUP

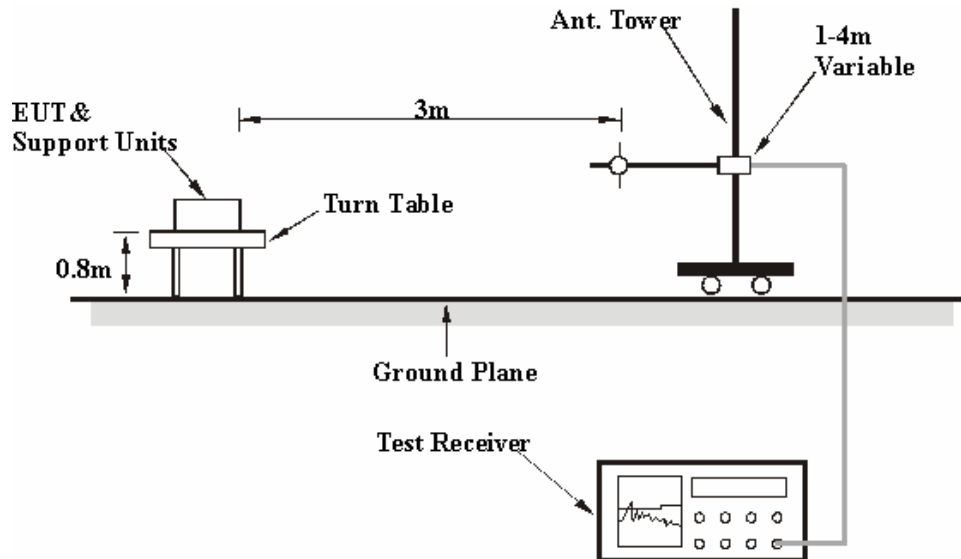

For the actual test configuration, please refer to the attached file (Test Setup Photo).

4.2.6 EUT OPERATING CONDITIONS

Same as 4.1.6.

4.2.7 TEST RESULTS

RADIATED WORST-CASE DATA: BELOW 1GHZ

FOR TEST MODE A: DIPOLE ANTENNA

EUT TEST CONDITION		MEASUREMENT DETAIL	
CHANNEL	Channel 11	FREQUENCY RANGE	Below 1000MHz
MODULATION TYPE	BPSK	DETECTOR FUNCTION	Quasi-Peak
TRANSFER RATE	6Mbps	ENVIRONMENTAL CONDITIONS	25deg. C, 70%RH, 1006hPa
INPUT POWER (SYSTEM)	120Vac, 60 Hz	TESTED BY	Lori Chiu
TEST MODE	A		

ANTENNA POLARITY & TEST DISTANCE: HORIZONTAL AT 3 M								
No.	Freq. (MHz)	Emission Level (dBuV/m)	Limit (dBuV/m)	Margin (dB)	Antenna Height (m)	Table Angle (Degree)	Raw Value (dBuV)	Correction Factor (dB/m)
1	100.59	42.05 QP	43.50	-1.45	1.75 H	64	32.83	9.22
2	131.77	40.08 QP	43.50	-3.42	1.50 H	251	28.08	12.00
3	166.24	38.67 QP	43.50	-4.83	1.00 H	358	25.66	13.01
4	199.35	40.05 QP	43.50	-3.45	1.50 H	133	29.68	10.37
5	267.42	41.26 QP	46.00	-4.74	1.75 H	205	28.43	12.83
6	809.71	43.12 QP	46.00	-2.88	1.50 H	61	18.66	24.46

ANTENNA POLARITY & TEST DISTANCE: VERTICAL AT 3 M								
No.	Freq. (MHz)	Emission Level (dBuV/m)	Limit (dBuV/m)	Margin (dB)	Antenna Height (m)	Table Angle (Degree)	Raw Value (dBuV)	Correction Factor (dB/m)
1	74.62	31.24 QP	40.00	-8.76	1.00 V	10	21.47	9.77
2	121.28	40.17 QP	43.50	-3.33	1.00 V	178	28.56	11.61
3	144.61	41.36 QP	43.50	-2.14	1.00 V	10	28.42	12.93
4	199.05	35.71 QP	43.50	-7.79	1.25 V	97	25.31	10.40
5	655.96	38.44 QP	46.00	-7.56	1.00 V	136	16.84	21.60
6	667.63	40.70 QP	46.00	-5.30	1.25 V	136	18.99	21.70
7	953.44	36.09 QP	46.00	-9.91	1.00 V	196	10.35	25.74

- REMARKS:**
1. Emission level(dBuV/m)=Raw Value(dBuV) + Correction Factor(dB/m)
 2. Correction Factor(dB/m) = Antenna Factor (dB/m) + Cable Factor (dB)
 3. The other emission levels were very low against the limit.
 4. Margin value = Emission level – Limit value.

FOR TEST MODE B: PIFA ANTENNA

EUT TEST CONDITION		MEASUREMENT DETAIL	
CHANNEL	Channel 11	FREQUENCY RANGE	Below 1000MHz
MODULATION TYPE	BPSK	DETECTOR FUNCTION	Quasi-Peak
TRANSFER RATE	6Mbps	ENVIRONMENTAL CONDITIONS	25deg. C, 70%RH, 1006hPa
INPUT POWER (SYSTEM)	120Vac, 60 Hz	TESTED BY	Lori Chiu
TEST MODE	B		

ANTENNA POLARITY & TEST DISTANCE: HORIZONTAL AT 3 M								
No.	Freq. (MHz)	Emission Level (dBuV/m)	Limit (dBuV/m)	Margin (dB)	Antenna Height (m)	Table Angle (Degree)	Raw Value (dBuV)	Correction Factor (dB/m)
1	89.16	37.09 QP	43.50	-6.41	1.90 H	18	28.16	8.93
2	99.89	41.36 QP	43.50	-2.14	2.00 H	37	32.21	9.15
3	131.67	39.66 QP	43.50	-3.84	2.06 H	5	27.67	12.00
4	166.00	39.59 QP	43.50	-3.91	1.75 H	205	26.56	13.03
5	199.05	39.49 QP	43.50	-4.01	2.00 H	49	29.09	10.40
6	267.10	41.77 QP	46.00	-4.23	1.25 H	91	28.95	12.82
7	809.56	42.31 QP	46.00	-3.69	1.00 H	4	17.85	24.46

ANTENNA POLARITY & TEST DISTANCE: VERTICAL AT 3 M								
No.	Freq. (MHz)	Emission Level (dBuV/m)	Limit (dBuV/m)	Margin (dB)	Antenna Height (m)	Table Angle (Degree)	Raw Value (dBuV)	Correction Factor (dB/m)
1	53.23	35.03 QP	40.00	-4.97	1.00 V	289	21.48	13.55
2	66.84	35.22 QP	40.00	-4.78	1.00 V	301	23.25	11.97
3	99.89	38.19 QP	43.50	-5.31	1.25 V	226	29.04	9.15
4	132.95	38.01 QP	43.50	-5.49	2.00 V	316	25.96	12.05
5	265.16	42.07 QP	46.00	-3.93	1.75 V	229	29.28	12.79
6	883.44	42.88 QP	46.00	-3.12	1.25 V	157	17.72	25.16

- REMARKS:**
1. Emission level(dBuV/m)=Raw Value(dBuV) + Correction Factor(dB/m)
 2. Correction Factor(dB/m) = Antenna Factor (dB/m) + Cable Factor (dB)
 3. The other emission levels were very low against the limit.
 4. Margin value = Emission level – Limit value.



802.11b DSSS MODULATION_FOR TEST MODE A: DIPOLE ANTENNA

EUT TEST CONDITION		MEASUREMENT DETAIL	
CHANNEL	Channel 1	FREQUENCY RANGE	1 ~ 25GHz
MODULATION TYPE	DBPSK	DETECTOR FUNCTION	Peak(PK) Average (AV)
TRANSFER RATE	1Mbps	ENVIRONMENTAL CONDITIONS	24deg. C, 71%RH, 1006hPa
INPUT POWER (SYSTEM)	120Vac, 60 Hz	TESTED BY	Dean Wang
TEST MODE	A		

ANTENNA POLARITY & TEST DISTANCE: HORIZONTAL AT 3 m								
No.	Freq. (MHz)	Emission Level (dBuV/m)	Limit (dBuV/m)	Margin (dB)	Antenna Height (m)	Table Angle (Degree)	Raw Value (dBuV)	Correction Factor (dB/m)
1	1608.000	46.68 PK	74.00	-27.32	1.00 H	348	17.77	28.91
2	1608.000	44.32 AV	54.00	-9.68	1.00 H	348	15.41	28.91
3	2390.000	58.44 PK	74.00	-15.56	1.11 H	175	26.12	32.32
4	2390.000	47.91 AV	54.00	-6.09	1.11 H	175	15.59	32.32
5	*2412.000	101.25 PK			1.11 H	177	68.93	32.32
6	*2412.000	97.23 AV			1.11 H	177	64.91	32.32
7	3216.000	49.52 PK	74.00	-24.48	1.01 H	27	15.95	33.57
8	3216.000	43.29 AV	54.00	-10.71	1.01 H	27	9.72	33.57
9	4824.000	49.31 PK	74.00	-24.69	1.00 H	211	11.31	38.00
10	4824.000	37.69 AV	54.00	-16.31	1.00 H	211	-0.31	38.00

- REMARKS:**
1. Emission level(dBuV/m)=Raw Value(dBuV) + Correction Factor(dB/m)
 2. Correction Factor(dB/m) = Antenna Factor (dB/m) + Cable Factor (dB)
 3. The other emission levels were very low against the limit.
 4. Margin value = Emission level – Limit value.
 5. “ * “ : Fundamental frequency.

EUT TEST CONDITION		MEASUREMENT DETAIL	
CHANNEL	Channel 1	FREQUENCY RANGE	1 ~ 25GHz
MODULATION TYPE	DBPSK	DETECTOR FUNCTION	Peak(PK) Average (AV)
TRANSFER RATE	1Mbps	ENVIRONMENTAL CONDITIONS	24deg. C, 71%RH, 1006hPa
INPUT POWER (SYSTEM)	120Vac, 60 Hz	TESTED BY	Dean Wang
TEST MODE	A		

ANTENNA POLARITY & TEST DISTANCE: VERTICAL AT 3 m								
No.	Freq. (MHz)	Emission Level (dBuV/m)	Limit (dBuV/m)	Margin (dB)	Antenna Height (m)	Table Angle (Degree)	Raw Value (dBuV)	Correction Factor (dB/m)
1	1608.000	51.84 PK	74.00	-22.16	1.08 V	69	22.93	28.91
2	1608.000	49.61 AV	54.00	-4.39	1.08 V	69	20.70	28.91
3	2390.000	61.97 PK	74.00	-12.03	1.39 V	330	29.65	32.32
4	2390.000	51.28 AV	54.00	-2.72	1.39 V	330	18.96	32.32
5	*2412.000	109.40 PK			1.40 V	329	77.08	32.32
6	*2412.000	105.49 AV			1.40 V	329	73.17	32.32
7	3216.000	54.04 PK	74.00	-19.96	1.03 V	183	20.47	33.57
8	3216.000	52.46 AV	54.00	-1.54	1.03 V	183	18.89	33.57
9	4824.000	52.06 PK	74.00	-21.94	1.03 V	89	14.06	38.00
10	4824.000	44.31 AV	54.00	-9.69	1.03 V	89	6.31	38.00

- REMARKS:**
1. Emission level(dBuV/m)=Raw Value(dBuV) + Correction Factor(dB/m)
 2. Correction Factor(dB/m) = Antenna Factor (dB/m) + Cable Factor (dB)
 3. The other emission levels were very low against the limit.
 4. Margin value = Emission level – Limit value.
 5. “ * “ : Fundamental frequency.

EUT TEST CONDITION		MEASUREMENT DETAIL	
CHANNEL	Channel 6	FREQUENCY RANGE	1 ~ 25GHz
MODULATION TYPE	DBPSK	DETECTOR FUNCTION	Peak(PK) Average (AV)
TRANSFER RATE	1Mbps	ENVIRONMENTAL CONDITIONS	24deg. C, 71%RH, 1006hPa
INPUT POWER (SYSTEM)	120Vac, 60 Hz	TESTED BY	Dean Wang
TEST MODE	A		

ANTENNA POLARITY & TEST DISTANCE: HORIZONTAL AT 3 m								
No.	Freq. (MHz)	Emission Level (dBuV/m)	Limit (dBuV/m)	Margin (dB)	Antenna Height (m)	Table Angle (Degree)	Raw Value (dBuV)	Correction Factor (dB/m)
1	*2437.000	101.76 PK			1.09 H	182	69.42	32.34
2	*2437.000	97.85 AV			1.09 H	182	65.51	32.34
3	4874.000	48.96 PK	74.00	-25.04	1.00 H	168	10.84	38.12
4	4874.000	37.25 AV	54.00	-16.75	1.00 H	168	-0.87	38.12

ANTENNA POLARITY & TEST DISTANCE: VERTICAL AT 3 m								
No.	Freq. (MHz)	Emission Level (dBuV/m)	Limit (dBuV/m)	Margin (dB)	Antenna Height (m)	Table Angle (Degree)	Raw Value (dBuV)	Correction Factor (dB/m)
1	1624.000	48.75 PK	74.00	-25.25	1.00 V	78	19.86	28.89
2	1624.000	45.56 AV	54.00	-8.44	1.00 V	78	16.67	28.89
3	*2437.000	110.33 PK			1.13 V	229	77.99	32.34
4	*2437.000	106.36 AV			1.13 V	229	74.02	32.34
5	3250.000	53.64 PK	74.00	-20.36	1.00 V	309	20.19	33.45
6	3250.000	50.23 AV	54.00	-3.77	1.00 V	309	16.78	33.45
7	4874.000	51.65 PK	74.00	-22.35	1.03 V	64	13.53	38.12
8	4874.000	42.46 AV	54.00	-11.54	1.03 V	64	4.34	38.12

- REMARKS:**
1. Emission level(dBuV/m)=Raw Value(dBuV) + Correction Factor(dB/m)
 2. Correction Factor(dB/m) = Antenna Factor (dB/m) + Cable Factor (dB)
 3. The other emission levels were very low against the limit.
 4. Margin value = Emission level – Limit value.
 5. " * " : Fundamental frequency.

EUT TEST CONDITION		MEASUREMENT DETAIL	
CHANNEL	Channel 11	FREQUENCY RANGE	1 ~ 25GHz
MODULATION TYPE	DBPSK	DETECTOR FUNCTION	Peak(PK) Average (AV)
TRANSFER RATE	1Mbps	ENVIRONMENTAL CONDITIONS	24deg. C, 71%RH, 1006hPa
INPUT POWER (SYSTEM)	120Vac, 60 Hz	TESTED BY	Dean Wang
TEST MODE	A		

ANTENNA POLARITY & TEST DISTANCE: HORIZONTAL AT 3 m								
No.	Freq. (MHz)	Emission Level (dBuV/m)	Limit (dBuV/m)	Margin (dB)	Antenna Height (m)	Table Angle (Degree)	Raw Value (dBuV)	Correction Factor (dB/m)
1	*2462.000	100.98 PK			1.12 H	165	68.61	32.37
2	*2462.000	97.02 AV			1.12 H	165	64.65	32.37
3	2483.500	58.96 PK	74.00	-15.04	1.10 H	171	26.57	32.39
4	2483.500	48.25 AV	54.00	-5.75	1.10 H	171	15.86	32.39
5	4924.000	49.08 PK	74.00	-24.92	1.02 H	198	10.85	38.23
6	4924.000	37.48 AV	54.00	-16.52	1.02 H	198	-0.75	38.23

ANTENNA POLARITY & TEST DISTANCE: VERTICAL AT 3 m								
No.	Freq. (MHz)	Emission Level (dBuV/m)	Limit (dBuV/m)	Margin (dB)	Antenna Height (m)	Table Angle (Degree)	Raw Value (dBuV)	Correction Factor (dB/m)
1	1641.000	48.99 PK	74.00	-25.01	1.25 V	255	20.12	28.87
2	1641.000	45.28 AV	54.00	-8.72	1.25 V	255	16.41	28.87
3	*2462.000	109.07 PK			1.15 V	229	76.70	32.37
4	*2462.000	105.19 AV			1.15 V	229	72.82	32.37
5	2483.500	63.96 PK	74.00	-10.04	1.16 V	229	31.57	32.39
6	2483.500	51.71 AV	54.00	-2.29	1.16 V	229	19.32	32.39
7	3282.000	52.88 PK	74.00	-21.12	1.16 V	256	19.54	33.34
8	3282.000	48.68 AV	54.00	-5.32	1.16 V	256	15.34	33.34
9	4924.000	51.92 PK	74.00	-22.08	1.03 V	32	13.69	38.23
10	4924.000	43.24 AV	54.00	-10.76	1.03 V	32	5.01	38.23

- REMARKS:**
1. Emission level(dBuV/m)=Raw Value(dBuV) + Correction Factor(dB/m)
 2. Correction Factor(dB/m) = Antenna Factor (dB/m) + Cable Factor (dB)
 3. The other emission levels were very low against the limit.
 4. Margin value = Emission level – Limit value.
 5. “ * “ : Fundamental frequency.

FOR TEST MODE B: PIFA ANTENNA

EUT TEST CONDITION		MEASUREMENT DETAIL	
CHANNEL	Channel 1	FREQUENCY RANGE	1 ~ 25GHz
MODULATION TYPE	DBPSK	DETECTOR FUNCTION	Peak(PK) Average (AV)
TRANSFER RATE	1Mbps	ENVIRONMENTAL CONDITIONS	24deg. C, 71%RH, 1006hPa
INPUT POWER (SYSTEM)	120Vac, 60 Hz	TESTED BY	Dean Wang
TEST MODE	B		

ANTENNA POLARITY & TEST DISTANCE: HORIZONTAL AT 3 m								
No.	Freq. (MHz)	Emission Level (dBuV/m)	Limit (dBuV/m)	Margin (dB)	Antenna Height (m)	Table Angle (Degree)	Raw Value (dBuV)	Correction Factor (dB/m)
1	1608.000	44.41 PK	74.00	-29.59	1.00 H	283	15.50	28.91
2	1608.000	38.89 AV	54.00	-15.11	1.00 H	283	9.98	28.91
3	2390.000	60.82 PK	74.00	-13.18	1.30 H	31	28.50	32.32
4	2390.000	49.52 AV	54.00	-4.48	1.30 H	31	17.20	32.32
5	*2412.000	106.22 PK			1.30 H	30	73.90	32.32
6	*2412.000	102.12 AV			1.30 H	30	69.80	32.32
7	3216.000	48.83 PK	74.00	-25.17	1.00 H	31	15.26	33.57
8	3216.000	43.52 AV	54.00	-10.48	1.00 H	31	9.95	33.57
9	4824.000	50.04 PK	74.00	-23.96	1.00 H	34	12.04	38.00
10	4824.000	38.98 AV	54.00	-15.02	1.00 H	34	0.98	38.00

- REMARKS:**
1. Emission level(dBuV/m)=Raw Value(dBuV) + Correction Factor(dB/m)
 2. Correction Factor(dB/m) = Antenna Factor (dB/m) + Cable Factor (dB)
 3. The other emission levels were very low against the limit.
 4. Margin value = Emission level – Limit value.
 5. “ * “ : Fundamental frequency.

EUT TEST CONDITION		MEASUREMENT DETAIL	
CHANNEL	Channel 1	FREQUENCY RANGE	1 ~ 25GHz
MODULATION TYPE	DBPSK	DETECTOR FUNCTION	Peak(PK) Average (AV)
TRANSFER RATE	1Mbps	ENVIRONMENTAL CONDITIONS	24deg. C, 71%RH, 1006hPa
INPUT POWER (SYSTEM)	120Vac, 60 Hz	TESTED BY	Dean Wang
TEST MODE	B		

ANTENNA POLARITY & TEST DISTANCE: VERTICAL AT 3 m								
No.	Freq. (MHz)	Emission Level (dBuV/m)	Limit (dBuV/m)	Margin (dB)	Antenna Height (m)	Table Angle (Degree)	Raw Value (dBuV)	Correction Factor (dB/m)
1	1608.000	45.53 PK	74.00	-28.47	1.14 V	81	16.62	28.91
2	1608.000	41.96 AV	54.00	-12.04	1.14 V	81	13.05	28.91
3	2390.000	61.48 PK	74.00	-12.52	1.25 V	78	29.16	32.32
4	2390.000	51.05 AV	54.00	-2.95	1.25 V	78	18.73	32.32
5	*2412.000	107.82 PK			1.25 V	78	75.50	32.32
6	*2412.000	103.78 AV			1.25 V	78	71.46	32.32
7	3216.000	50.32 PK	74.00	-23.68	1.09 V	85	16.75	33.57
8	3216.000	48.92 AV	54.00	-5.08	1.09 V	85	15.35	33.57
9	4824.000	51.89 PK	74.00	-22.11	1.12 V	92	13.89	38.00
10	4824.000	44.38 AV	54.00	-9.62	1.12 V	92	6.38	38.00

- REMARKS:**
1. Emission level(dBuV/m)=Raw Value(dBuV) + Correction Factor(dB/m)
 2. Correction Factor(dB/m) = Antenna Factor (dB/m) + Cable Factor (dB)
 3. The other emission levels were very low against the limit.
 4. Margin value = Emission level – Limit value.
 5. “ * “ : Fundamental frequency.

EUT TEST CONDITION		MEASUREMENT DETAIL	
CHANNEL	Channel 6	FREQUENCY RANGE	1 ~ 25GHz
MODULATION TYPE	DBPSK	DETECTOR FUNCTION	Peak(PK) Average (AV)
TRANSFER RATE	1Mbps	ENVIRONMENTAL CONDITIONS	24deg. C, 71%RH, 1006hPa
INPUT POWER (SYSTEM)	120Vac, 60 Hz	TESTED BY	Dean Wang
TEST MODE	B		

ANTENNA POLARITY & TEST DISTANCE: HORIZONTAL AT 3 m								
No.	Freq. (MHz)	Emission Level (dBuV/m)	Limit (dBuV/m)	Margin (dB)	Antenna Height (m)	Table Angle (Degree)	Raw Value (dBuV)	Correction Factor (dB/m)
1	*2437.000	107.34 PK			1.29 H	41	75.00	32.34
2	*2437.000	103.29 AV			1.29 H	41	70.95	32.34
3	4874.000	49.52 PK	74.00	-24.48	1.00 H	334	11.40	38.12
4	4874.000	37.68 AV	54.00	-16.32	1.00 H	334	-0.44	38.12

ANTENNA POLARITY & TEST DISTANCE: VERTICAL AT 3 m								
No.	Freq. (MHz)	Emission Level (dBuV/m)	Limit (dBuV/m)	Margin (dB)	Antenna Height (m)	Table Angle (Degree)	Raw Value (dBuV)	Correction Factor (dB/m)
1	1624.000	46.92 PK	74.00	-27.08	1.05 V	92	18.03	28.89
2	1624.000	43.87 AV	54.00	-10.13	1.05 V	92	14.98	28.89
3	*2437.000	108.89 PK			1.21 V	105	76.55	32.34
4	*2437.000	104.82 AV			1.21 V	105	72.48	32.34
5	3250.000	48.72 PK	74.00	-25.28	1.05 V	116	15.27	33.45
6	3250.000	46.52 AV	54.00	-7.48	1.05 V	116	13.07	33.45
7	4874.000	51.97 PK	74.00	-22.03	1.00 V	214	13.85	38.12
8	4874.000	43.10 AV	54.00	-10.90	1.00 V	214	4.98	38.12

- REMARKS:**
1. Emission level(dBuV/m)=Raw Value(dBuV) + Correction Factor(dB/m)
 2. Correction Factor(dB/m) = Antenna Factor (dB/m) + Cable Factor (dB)
 3. The other emission levels were very low against the limit.
 4. Margin value = Emission level – Limit value.
 5. " * " : Fundamental frequency.

EUT TEST CONDITION		MEASUREMENT DETAIL	
CHANNEL	Channel 11	FREQUENCY RANGE	1 ~ 25GHz
MODULATION TYPE	DBPSK	DETECTOR FUNCTION	Peak(PK) Average (AV)
TRANSFER RATE	1Mbps	ENVIRONMENTAL CONDITIONS	24deg. C, 71%RH, 1006hPa
INPUT POWER (SYSTEM)	120Vac, 60 Hz	TESTED BY	Dean Wang
TEST MODE	B		

ANTENNA POLARITY & TEST DISTANCE: HORIZONTAL AT 3 m								
No.	Freq. (MHz)	Emission Level (dBuV/m)	Limit (dBuV/m)	Margin (dB)	Antenna Height (m)	Table Angle (Degree)	Raw Value (dBuV)	Correction Factor (dB/m)
1	*2462.000	105.97 PK			1.29 H	34	73.60	32.37
2	*2462.000	101.89 AV			1.29 H	34	69.52	32.37
3	2483.500	62.05 PK	74.00	-11.95	1.30 H	35	29.66	32.39
4	2483.500	49.88 AV	54.00	-4.12	1.30 H	35	17.49	32.39
5	4924.000	49.87 PK	74.00	-24.13	1.00 H	121	11.64	38.23
6	4924.000	37.92 AV	54.00	-16.08	1.00 H	121	-0.31	38.23

ANTENNA POLARITY & TEST DISTANCE: VERTICAL AT 3 m								
No.	Freq. (MHz)	Emission Level (dBuV/m)	Limit (dBuV/m)	Margin (dB)	Antenna Height (m)	Table Angle (Degree)	Raw Value (dBuV)	Correction Factor (dB/m)
1	1641.000	46.99 PK	74.00	-27.01	1.09 V	121	18.12	28.87
2	1641.000	43.46 AV	54.00	-10.54	1.09 V	121	14.59	28.87
3	*2462.000	107.72 PK			1.21 V	65	75.35	32.37
4	*2462.000	103.68 AV			1.21 V	65	71.31	32.37
5	2483.500	63.29 PK	74.00	-10.71	1.25 V	71	30.90	32.39
6	2483.500	51.13 AV	54.00	-2.87	1.25 V	71	18.74	32.39
7	3282.000	48.34 PK	74.00	-25.66	1.00 V	296	15.00	33.34
8	3282.000	41.96 AV	54.00	-12.04	1.00 V	296	8.62	33.34
9	4924.000	52.13 PK	74.00	-21.87	1.08 V	106	13.90	38.23
10	4924.000	43.51 AV	54.00	-10.49	1.08 V	106	5.28	38.23

- REMARKS:**
1. Emission level(dBuV/m)=Raw Value(dBuV) + Correction Factor(dB/m)
 2. Correction Factor(dB/m) = Antenna Factor (dB/m) + Cable Factor (dB)
 3. The other emission levels were very low against the limit.
 4. Margin value = Emission level – Limit value.
 5. " * " : Fundamental frequency.



802.11g OFDM MODULATION_FOR TEST MODE A: DIPOLE ANTENNA

EUT TEST CONDITION		MEASUREMENT DETAIL	
CHANNEL	Channel 1	FREQUENCY RANGE	1 ~ 25GHz
MODULATION TYPE	BPSK	DETECTOR FUNCTION	Peak(PK) Average (AV)
TRANSFER RATE	6Mbps	ENVIRONMENTAL CONDITIONS	24deg. C, 71%RH, 1006hPa
INPUT POWER (SYSTEM)	120Vac, 60 Hz	TESTED BY	Dean Wang
TEST MODE	A		

ANTENNA POLARITY & TEST DISTANCE: HORIZONTAL AT 3 m								
No.	Freq. (MHz)	Emission Level (dBuV/m)	Limit (dBuV/m)	Margin (dB)	Antenna Height (m)	Table Angle (Degree)	Raw Value (dBuV)	Correction Factor (dB/m)
1	1608.000	46.39 PK	74.00	-27.61	1.00 H	6	17.48	28.91
2	1608.000	36.02 AV	54.00	-17.98	1.00 H	6	7.11	28.91
3	2390.000	60.86 PK	74.00	-13.14	1.38 H	34	28.54	32.32
4	2390.000	48.53 AV	54.00	-5.47	1.38 H	34	16.21	32.32
5	*2412.000	103.30 PK			1.38 H	33	70.98	32.32
6	*2412.000	91.47 AV			1.38 H	33	59.15	32.32
7	3216.000	50.54 PK	74.00	-23.46	1.00 H	47	16.97	33.57
8	3216.000	46.08 AV	54.00	-7.92	1.00 H	47	12.51	33.57
9	4824.000	49.58 PK	74.00	-24.42	1.00 H	115	11.58	38.00
10	4824.000	36.61 AV	54.00	-17.39	1.00 H	115	-1.39	38.00

- REMARKS:**
1. Emission level(dBuV/m)=Raw Value(dBuV) + Correction Factor(dB/m)
 2. Correction Factor(dB/m) = Antenna Factor (dB/m) + Cable Factor (dB)
 3. The other emission levels were very low against the limit.
 4. Margin value = Emission level – Limit value.
 5. “ * “ : Fundamental frequency.

EUT TEST CONDITION		MEASUREMENT DETAIL	
CHANNEL	Channel 1	FREQUENCY RANGE	1 ~ 25GHz
MODULATION TYPE	BPSK	DETECTOR FUNCTION	Peak(PK) Average (AV)
TRANSFER RATE	6Mbps	ENVIRONMENTAL CONDITIONS	24deg. C, 71%RH, 1006hPa
INPUT POWER (SYSTEM)	120Vac, 60 Hz	TESTED BY	Dean Wang
TEST MODE	A		

ANTENNA POLARITY & TEST DISTANCE: VERTICAL AT 3 m								
No.	Freq. (MHz)	Emission Level (dBuV/m)	Limit (dBuV/m)	Margin (dB)	Antenna Height (m)	Table Angle (Degree)	Raw Value (dBuV)	Correction Factor (dB/m)
1	1608.000	49.93 PK	74.00	-24.07	1.05 V	69	21.02	28.91
2	1608.000	36.76 AV	54.00	-17.24	1.05 V	69	7.85	28.91
3	2390.000	65.20 PK	74.00	-8.80	1.22 V	333	32.88	32.32
4	2390.000	51.60 AV	54.00	-2.40	1.22 V	333	19.28	32.32
5	*2412.000	110.34 PK			1.19 V	332	78.02	32.32
6	*2412.000	98.65 AV			1.19 V	332	66.33	32.32
7	3216.000	54.70 PK	74.00	-19.30	1.06 V	108	21.13	33.57
8	3216.000	52.66 AV	54.00	-1.34	1.06 V	108	19.09	33.57
9	4824.000	50.77 PK	74.00	-23.23	1.00 V	214	12.77	38.00
10	4824.000	37.70 AV	54.00	-16.30	1.00 V	214	-0.30	38.00

- REMARKS:**
1. Emission level(dBuV/m)=Raw Value(dBuV) + Correction Factor(dB/m)
 2. Correction Factor(dB/m) = Antenna Factor (dB/m) + Cable Factor (dB)
 3. The other emission levels were very low against the limit.
 4. Margin value = Emission level – Limit value.
 5. “ * “ : Fundamental frequency.

EUT TEST CONDITION		MEASUREMENT DETAIL	
CHANNEL	Channel 6	FREQUENCY RANGE	1 ~ 25GHz
MODULATION TYPE	BPSK	DETECTOR FUNCTION	Peak(PK) Average (AV)
TRANSFER RATE	6Mbps	ENVIRONMENTAL CONDITIONS	24deg. C, 71%RH, 1006hPa
INPUT POWER (SYSTEM)	120Vac, 60 Hz	TESTED BY	Dean Wang
TEST MODE	A		

ANTENNA POLARITY & TEST DISTANCE: HORIZONTAL AT 3 m								
No.	Freq. (MHz)	Emission Level (dBuV/m)	Limit (dBuV/m)	Margin (dB)	Antenna Height (m)	Table Angle (Degree)	Raw Value (dBuV)	Correction Factor (dB/m)
1	*2437.000	103.92 PK			1.32 H	52	71.58	32.34
2	*2437.000	92.02 AV			1.32 H	52	59.68	32.34
3	4874.000	50.13 PK	74.00	-23.87	1.00 H	187	12.01	38.12
4	4874.000	37.46 AV	54.00	-16.54	1.00 H	187	-0.66	38.12

ANTENNA POLARITY & TEST DISTANCE: VERTICAL AT 3 m								
No.	Freq. (MHz)	Emission Level (dBuV/m)	Limit (dBuV/m)	Margin (dB)	Antenna Height (m)	Table Angle (Degree)	Raw Value (dBuV)	Correction Factor (dB/m)
1	*2437.000	111.19 PK			1.13 V	231	78.85	32.34
2	*2437.000	99.06 AV			1.13 V	231	66.72	32.34
3	3250.000	53.16 PK	74.00	-20.84	1.04 V	16	19.71	33.45
4	3250.000	49.93 AV	54.00	-4.07	1.04 V	16	16.48	33.45
5	4874.000	51.16 PK	74.00	-22.84	1.00 V	156	13.04	38.12
6	4874.000	38.51 AV	54.00	-15.49	1.00 V	156	0.39	38.12

- REMARKS:**
1. Emission level(dBuV/m)=Raw Value(dBuV) + Correction Factor(dB/m)
 2. Correction Factor(dB/m) = Antenna Factor (dB/m) + Cable Factor (dB)
 3. The other emission levels were very low against the limit.
 4. Margin value = Emission level – Limit value.
 5. “ * “ : Fundamental frequency.

EUT TEST CONDITION		MEASUREMENT DETAIL	
CHANNEL	Channel 11	FREQUENCY RANGE	1 ~ 25GHz
MODULATION TYPE	BPSK	DETECTOR FUNCTION	Peak(PK) Average (AV)
TRANSFER RATE	6Mbps	ENVIRONMENTAL CONDITIONS	24deg. C, 71%RH, 1006hPa
INPUT POWER (SYSTEM)	120Vac, 60 Hz	TESTED BY	Dean Wang
TEST MODE	A		

ANTENNA POLARITY & TEST DISTANCE: HORIZONTAL AT 3 m								
No.	Freq. (MHz)	Emission Level (dBuV/m)	Limit (dBuV/m)	Margin (dB)	Antenna Height (m)	Table Angle (Degree)	Raw Value (dBuV)	Correction Factor (dB/m)
1	*2462.000	103.42 PK			1.32 H	28	71.05	32.37
2	*2462.000	91.45 AV			1.32 H	28	59.08	32.37
3	2483.500	61.12 PK	74.00	-12.88	1.32 H	30	28.73	32.39
4	2483.500	48.92 AV	54.00	-5.08	1.32 H	30	16.53	32.39
5	4924.000	49.72 PK	74.00	-24.28	1.00 H	116	11.49	38.23
6	4924.000	36.58 AV	54.00	-17.42	1.00 H	116	-1.65	38.23

ANTENNA POLARITY & TEST DISTANCE: VERTICAL AT 3 m								
No.	Freq. (MHz)	Emission Level (dBuV/m)	Limit (dBuV/m)	Margin (dB)	Antenna Height (m)	Table Angle (Degree)	Raw Value (dBuV)	Correction Factor (dB/m)
1	*2462.000	110.59 PK			1.15 V	52	78.22	32.37
2	*2462.000	98.68 AV			1.15 V	52	66.31	32.37
3	2483.500	67.38 PK	74.00	-6.62	1.15 V	53	34.99	32.39
4	2483.500	51.70 AV	54.00	-2.30	1.15 V	53	19.31	32.39
5	3282.000	53.60 PK	74.00	-20.40	1.00 V	305	20.26	33.34
6	3282.000	50.29 AV	54.00	-3.71	1.00 V	305	16.95	33.34
7	4924.000	50.93 PK	74.00	-23.07	1.00 V	214	12.70	38.23
8	4924.000	37.95 AV	54.00	-16.05	1.00 V	214	-0.28	38.23

- REMARKS:**
1. Emission level(dBuV/m)=Raw Value(dBuV) + Correction Factor(dB/m)
 2. Correction Factor(dB/m) = Antenna Factor (dB/m) + Cable Factor (dB)
 3. The other emission levels were very low against the limit.
 4. Margin value = Emission level – Limit value.
 5. “ * “ : Fundamental frequency.

FOR TEST MODE B: PIFA ANTENNA

EUT TEST CONDITION		MEASUREMENT DETAIL	
CHANNEL	Channel 1	FREQUENCY RANGE	1 ~ 25GHz
MODULATION TYPE	BPSK	DETECTOR FUNCTION	Peak(PK) Average (AV)
TRANSFER RATE	6Mbps	ENVIRONMENTAL CONDITIONS	24deg. C, 71%RH, 1006hPa
INPUT POWER (SYSTEM)	120Vac, 60 Hz	TESTED BY	Dean Wang
TEST MODE	B		

ANTENNA POLARITY & TEST DISTANCE: HORIZONTAL AT 3 m								
No.	Freq. (MHz)	Emission Level (dBuV/m)	Limit (dBuV/m)	Margin (dB)	Antenna Height (m)	Table Angle (Degree)	Raw Value (dBuV)	Correction Factor (dB/m)
1	2390.000	67.90 PK	74.00	-6.10	1.30 H	30	35.58	32.32
2	2390.000	51.22 AV	54.00	-2.78	1.30 H	30	18.90	32.32
3	*2412.000	107.08 PK			1.30 H	31	74.76	32.32
4	*2412.000	95.85 AV			1.30 H	31	63.53	32.32
5	3216.000	50.03 PK	74.00	-23.97	1.33 H	41	16.46	33.57
6	3216.000	45.19 AV	54.00	-8.81	1.33 H	41	11.62	33.57
7	4824.000	50.30 PK	74.00	-23.70	1.00 H	265	12.30	38.00
8	4824.000	36.92 AV	54.00	-17.08	1.00 H	265	-1.08	38.00

ANTENNA POLARITY & TEST DISTANCE: VERTICAL AT 3 m								
No.	Freq. (MHz)	Emission Level (dBuV/m)	Limit (dBuV/m)	Margin (dB)	Antenna Height (m)	Table Angle (Degree)	Raw Value (dBuV)	Correction Factor (dB/m)
1	2390.000	68.11 PK	74.00	-5.89	1.00 V	99	35.79	32.32
2	2390.000	52.62 AV	54.00	-1.38	1.00 V	99	20.30	32.32
3	*2412.000	109.38 PK			1.00 V	98	77.06	32.32
4	*2412.000	97.85 AV			1.00 V	98	65.53	32.32
5	3216.000	52.53 PK	74.00	-21.47	1.09 V	87	18.96	33.57
6	3216.000	48.45 AV	54.00	-5.55	1.09 V	87	14.88	33.57
7	4824.000	51.23 PK	74.00	-22.77	1.00 V	166	13.23	38.00
8	4824.000	38.16 AV	54.00	-15.84	1.00 V	166	0.16	38.00

- REMARKS:**
1. Emission level(dBuV/m)=Raw Value(dBuV) + Correction Factor(dB/m)
 2. Correction Factor(dB/m) = Antenna Factor (dB/m) + Cable Factor (dB)
 3. The other emission levels were very low against the limit.
 4. Margin value = Emission level – Limit value.
 5. “ * ” : Fundamental frequency.

EUT TEST CONDITION		MEASUREMENT DETAIL	
CHANNEL	Channel 6	FREQUENCY RANGE	1 ~ 25GHz
MODULATION TYPE	BPSK	DETECTOR FUNCTION	Peak(PK) Average (AV)
TRANSFER RATE	6Mbps	ENVIRONMENTAL CONDITIONS	24deg. C, 71%RH, 1006hPa
INPUT POWER (SYSTEM)	120Vac, 60 Hz	TESTED BY	Dean Wang
TEST MODE	B		

ANTENNA POLARITY & TEST DISTANCE: HORIZONTAL AT 3 m								
No.	Freq. (MHz)	Emission Level (dBuV/m)	Limit (dBuV/m)	Margin (dB)	Antenna Height (m)	Table Angle (Degree)	Raw Value (dBuV)	Correction Factor (dB/m)
1	*2437.000	107.65 PK			1.28 H	42	75.31	32.34
2	*2437.000	96.53 AV			1.28 H	42	64.19	32.34
3	4874.000	50.82 PK	74.00	-23.18	1.00 H	162	12.70	38.12
4	4874.000	37.61 AV	54.00	-16.39	1.00 H	162	-0.51	38.12

ANTENNA POLARITY & TEST DISTANCE: VERTICAL AT 3 m								
No.	Freq. (MHz)	Emission Level (dBuV/m)	Limit (dBuV/m)	Margin (dB)	Antenna Height (m)	Table Angle (Degree)	Raw Value (dBuV)	Correction Factor (dB/m)
1	*2437.000	110.03 PK			1.00 V	165	77.69	32.34
2	*2437.000	98.68 AV			1.00 V	165	66.34	32.34
3	3250.000	50.62 PK	74.00	-23.38	1.05 V	21	17.17	33.45
4	3250.000	44.89 AV	54.00	-9.11	1.05 V	21	11.44	33.45
5	4874.000	51.84 PK	74.00	-22.16	1.05 V	241	13.72	38.12
6	4874.000	38.92 AV	54.00	-15.08	1.05 V	241	0.80	38.12

- REMARKS:**
1. Emission level(dBuV/m)=Raw Value(dBuV) + Correction Factor(dB/m)
 2. Correction Factor(dB/m) = Antenna Factor (dB/m) + Cable Factor (dB)
 3. The other emission levels were very low against the limit.
 4. Margin value = Emission level – Limit value.
 5. “ * “ : Fundamental frequency.

EUT TEST CONDITION		MEASUREMENT DETAIL	
CHANNEL	Channel 11	FREQUENCY RANGE	1 ~ 25GHz
MODULATION TYPE	BPSK	DETECTOR FUNCTION	Peak(PK) Average (AV)
TRANSFER RATE	6Mbps	ENVIRONMENTAL CONDITIONS	24deg. C, 71%RH, 1006hPa
INPUT POWER (SYSTEM)	120Vac, 60 Hz	TESTED BY	Dean Wang
TEST MODE	B		

ANTENNA POLARITY & TEST DISTANCE: HORIZONTAL AT 3 m								
No.	Freq. (MHz)	Emission Level (dBuV/m)	Limit (dBuV/m)	Margin (dB)	Antenna Height (m)	Table Angle (Degree)	Raw Value (dBuV)	Correction Factor (dB/m)
1	*2462.000	106.89 PK			1.26 H	56	74.52	32.37
2	*2462.000	95.68 AV			1.26 H	56	63.31	32.37
3	2483.500	65.87 PK	74.00	-8.13	1.28 H	52	33.48	32.39
4	2483.500	49.53 AV	54.00	-4.47	1.28 H	52	17.14	32.39
5	4924.000	50.75 PK	74.00	-23.25	1.00 H	178	12.52	38.23
6	4924.000	37.49 AV	54.00	-16.51	1.00 H	178	-0.74	38.23

ANTENNA POLARITY & TEST DISTANCE: VERTICAL AT 3 m								
No.	Freq. (MHz)	Emission Level (dBuV/m)	Limit (dBuV/m)	Margin (dB)	Antenna Height (m)	Table Angle (Degree)	Raw Value (dBuV)	Correction Factor (dB/m)
1	*2462.000	109.14 PK			1.44 V	120	76.77	32.37
2	*2462.000	97.56 AV			1.44 V	120	65.19	32.37
3	2483.500	67.65 PK	74.00	-6.35	1.44 V	120	35.26	32.39
4	2483.500	50.75 AV	54.00	-3.25	1.44 V	120	18.36	32.39
5	3282.000	47.46 PK	74.00	-26.54	1.00 V	299	14.12	33.34
6	3282.000	39.04 AV	54.00	-14.96	1.00 V	299	5.70	33.34
7	4924.000	51.62 PK	74.00	-22.38	1.02 V	341	13.39	38.23
8	4924.000	38.51 AV	54.00	-15.49	1.02 V	341	0.28	38.23

- REMARKS:**
1. Emission level(dBuV/m)=Raw Value(dBuV) + Correction Factor(dB/m)
 2. Correction Factor(dB/m) = Antenna Factor (dB/m) + Cable Factor (dB)
 3. The other emission levels were very low against the limit.
 4. Margin value = Emission level – Limit value.
 5. “ * “ : Fundamental frequency.



4.3 6dB BANDWIDTH MEASUREMENT

4.3.1 LIMITS OF 6dB BANDWIDTH MEASUREMENT

The minimum of 6dB Bandwidth Measurement is 0.5 MHz.

4.3.2 TEST INSTRUMENTS

DESCRIPTION & MANUFACTURER	MODEL NO.	SERIAL NO.	CALIBRATED UNTIL
SPECTRUM ANALYZER	FSP 40	100040	Jun. 28, 2008

NOTE: The calibration interval of the above test instruments is 12 months and the calibrations are traceable to NML/ROC and NIST/USA.

4.3.3 TEST PROCEDURE

The transmitter output was connected to the spectrum analyzer through an attenuator. The bandwidth of the fundamental frequency was measured by spectrum analyzer with 100 kHz RBW and 300kHz VBW. The 6dB bandwidth is defined as the total spectrum the power of which is higher than peak power minus 6dB.

4.3.4 DEVIATION FROM TEST STANDARD

No deviation.

4.3.5 TEST SETUP

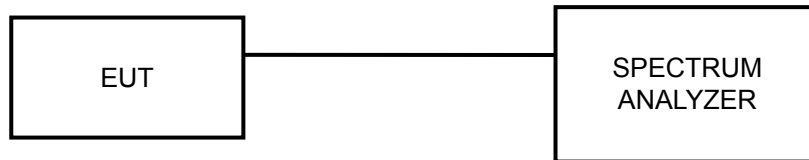

For the actual test configuration, please refer to the related Item – Photographs of the Test Configuration.

4.3.6 EUT OPERATING CONDITIONS

The software provided by client to enable the EUT under transmission condition continuously at lowest, middle and highest channel frequencies individually.



4.3.7 TEST RESULTS

802.11b DSSS MODULATION

MODULATION TYPE	DBPSK	TRANSFER RATE	1Mbps
INPUT POWER (SYSTEM)	120Vac, 60 Hz	ENVIRONMENTAL CONDITIONS	26deg. C, 67%RH, 1005hPa
TESTED BY	Brad Wu		

CHANNEL	CHANNEL FREQUENCY (MHz)	6dB BANDWIDTH (MHz)	MINIMUM LIMIT (MHz)	PASS/FAIL
1	2412	10.12	0.5	PASS
6	2437	10.12	0.5	PASS
11	2462	10.12	0.5	PASS

CH 1

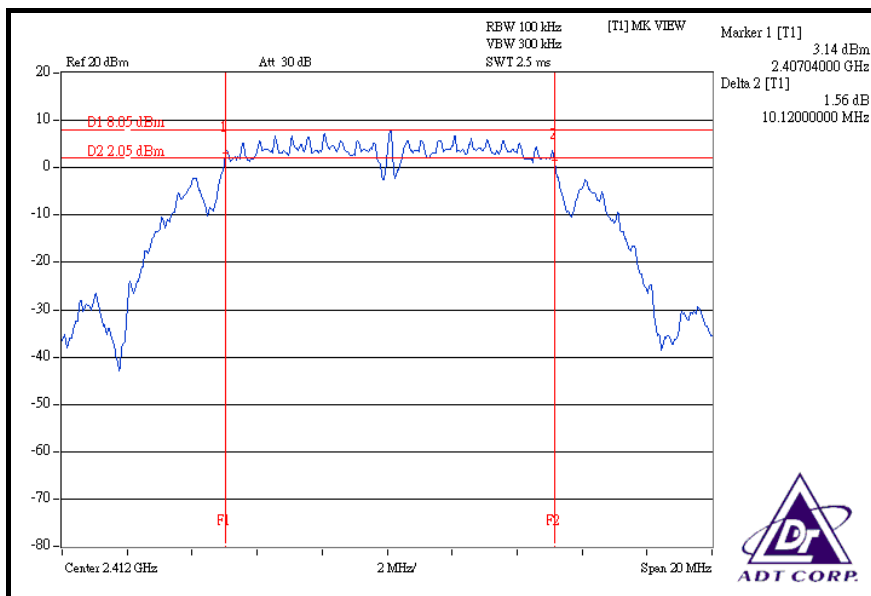

CH 6

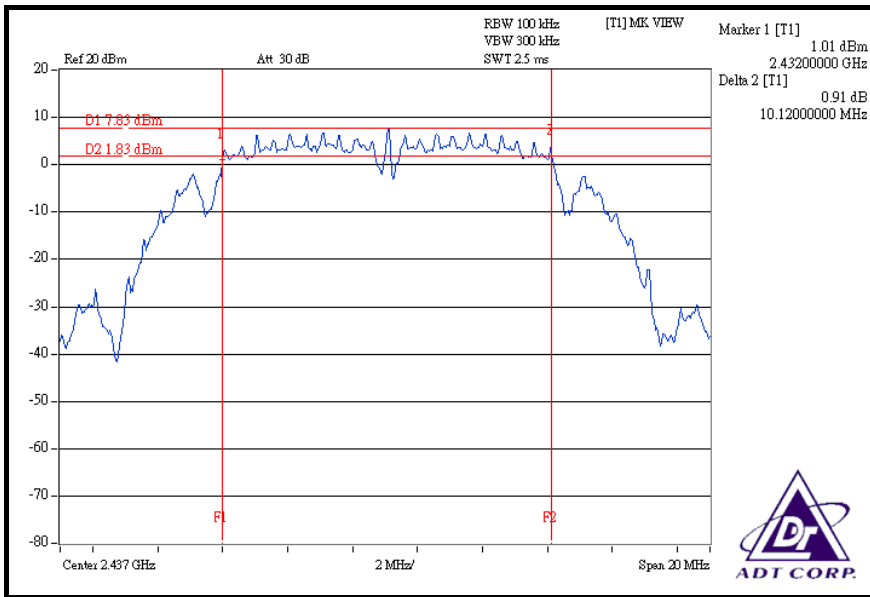

CH 11

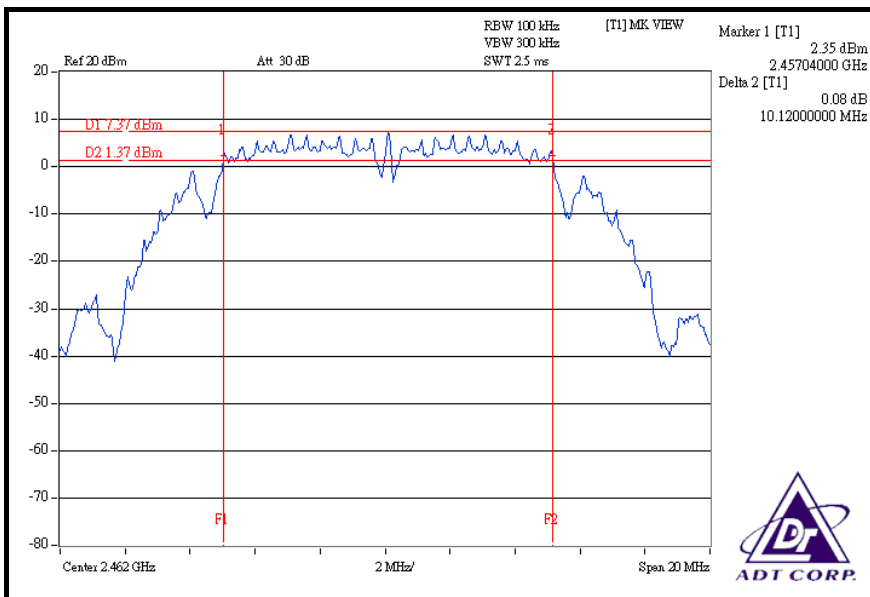



802.11g OFDM MODULATION

MODULATION TYPE	BPSK	TRANSFER RATE	6Mbps
INPUT POWER (SYSTEM)	120Vac, 60 Hz	ENVIRONMENTAL CONDITIONS	26deg. C, 67%RH, 1005hPa
TESTED BY	Brad Wu		

CHANNEL	CHANNEL FREQUENCY (MHz)	6dB BANDWIDTH (MHz)	MINIMUM LIMIT (MHz)	PASS/FAIL
1	2412	16.40	0.5	PASS
6	2437	16.36	0.5	PASS
11	2462	16.44	0.5	PASS

CH 1

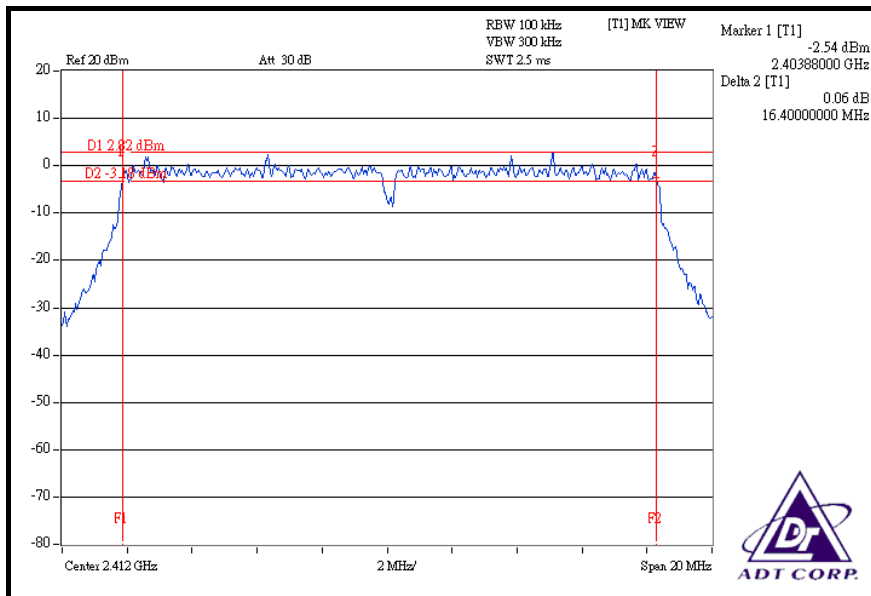

CH 6

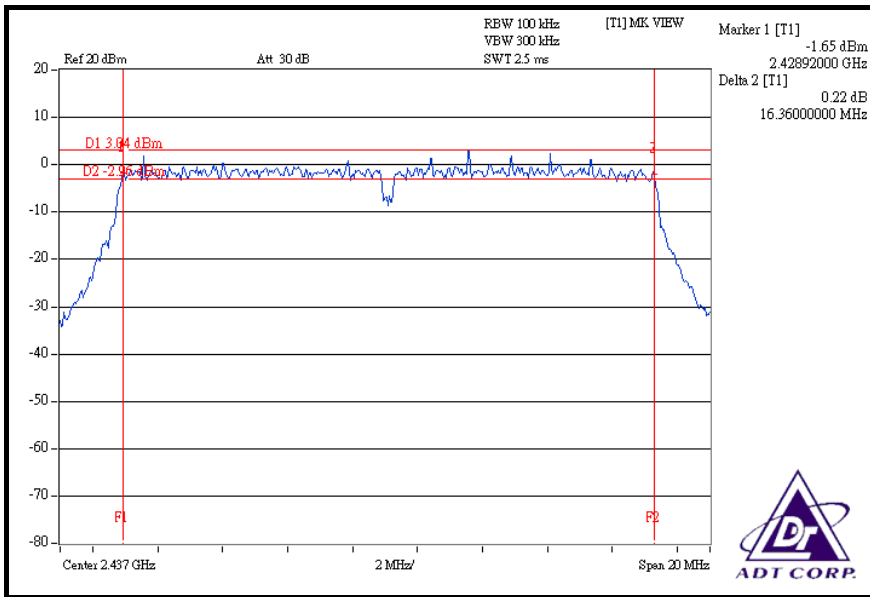

CH 11

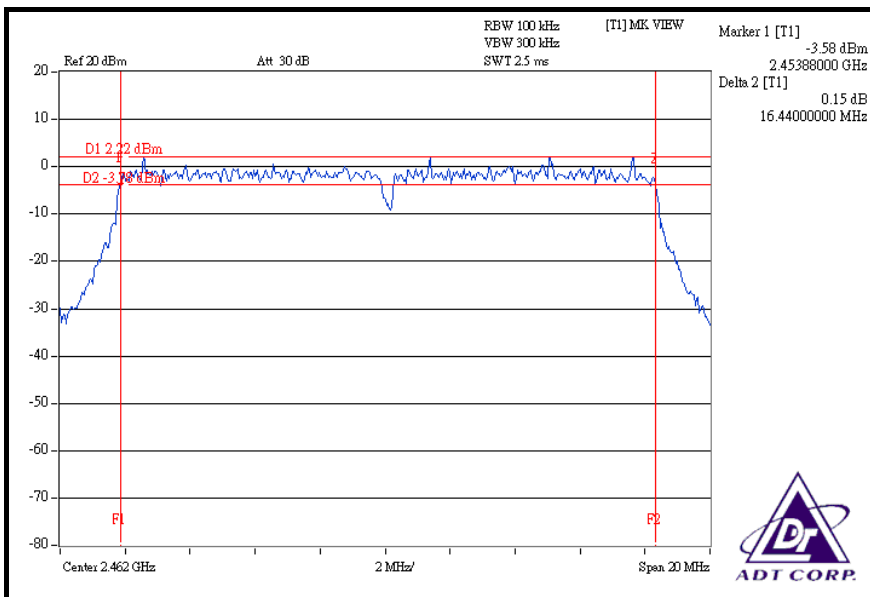



4.4 MAXIMUM PEAK OUTPUT POWER

4.4.1 LIMITS OF MAXIMUM PEAK OUTPUT POWER MEASUREMENT

The Maximum Peak Output Power Measurement is 30dBm.

4.4.2 TEST INSTRUMENTS

DESCRIPTION & MANUFACTURER	MODEL NO.	SERIAL NO.	CALIBRATED UNTIL
R&S SPECTRUM ANALYZER	FSP40	100040	Jun. 28, 2008
AGILENT SIGNAL GENERATOR	E8257C	MY43320668	Dec. 28, 2007
TEKTRONIX OSCILLOSCOPE	TDS1012	C037299	Nov. 27, 2007
NARDA DETECTOR	4503A	FSCM99899	NA

NOTE: The calibration interval of the above test instruments is 12 months and the calibrations are traceable to NML/ROC and NIST/USA.

4.4.3 TEST PROCEDURES

- a. A detector was used on the output port of the EUT. An oscilloscope was used to peak the response of the detector.
- b. Replaced the EUT by the signal generator. The center frequency of the S.G was adjusted to the center frequency of the measured channel.
- c. Adjusted the power to have the same peak reading on oscilloscope. Record the power level.

4.4.4 DEVIATION FROM TEST STANDARD

No deviation.

4.4.5 TEST SETUP

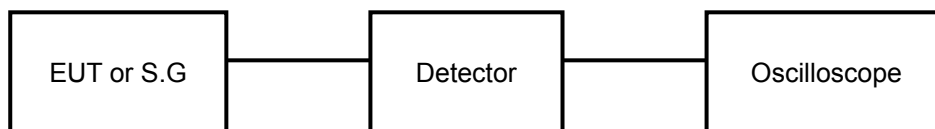

4.4.6 EUT OPERATING CONDITIONS

Same as 4.3.6.



4.4.7 TEST RESULTS

802.11b DSSS MODULATION

MODULATION TYPE	DBPSK	TRANSFER RATE	1Mbps
INPUT POWER (SYSTEM)	120Vac, 60 Hz	ENVIRONMENTAL CONDITIONS	26deg. C, 67%RH, 1005hPa
TESTED BY	Brad Wu		

CHANNEL	CHANNEL FREQUENCY (MHz)	PEAK POWER OUTPUT (mW)	PEAK POWER OUTPUT (dBm)	PEAK POWER LIMIT (dBm)	PASS/FAIL
1	2412	65.013	18.13	30	PASS
6	2437	63.680	18.04	30	PASS
11	2462	56.364	17.51	30	PASS

802.11g OFDM MODULATION

MODULATION TYPE	BPSK	TRANSFER RATE	6Mbps
INPUT POWER (SYSTEM)	120Vac, 60 Hz	ENVIRONMENTAL CONDITIONS	26deg. C, 67%RH, 1005hPa
TESTED BY	Brad Wu		

CHANNEL	CHANNEL FREQUENCY (MHz)	PEAK POWER OUTPUT (mW)	PEAK POWER OUTPUT (dBm)	PEAK POWER LIMIT (dBm)	PASS/FAIL
1	2412	71.614	18.55	30	PASS
6	2437	71.450	18.54	30	PASS
11	2462	64.121	18.07	30	PASS

4.5 POWER SPECTRAL DENSITY MEASUREMENT

4.5.1 LIMITS OF POWER SPECTRAL DENSITY MEASUREMENT

The Maximum of Power Spectral Density Measurement is 8dBm.

4.5.2 TEST INSTRUMENTS

DESCRIPTION & MANUFACTURER	MODEL NO.	SERIAL NO.	CALIBRATED UNTIL
R&S SPECTRUM ANALYZER	FSP 40	100040	Jun. 28, 2008

NOTE: The calibration interval of the above test instruments is 12 months and the calibrations are traceable to NML/ROC and NIST/USA.

4.5.3 TEST PROCEDURE

The transmitter output was connected to the spectrum analyzer through an attenuator, the bandwidth of the fundamental frequency was measured with the spectrum analyzer using 3kHz RBW and 30kHz VBW, set sweep time = span/3kHz. The power spectral density was measured and recorded.

The sweep time is allowed to be longer than span/3kHz for a full response of the mixer in the spectrum analyzer.

4.5.4 DEVIATION FROM TEST STANDARD

No deviation.

4.5.5 TEST SETUP

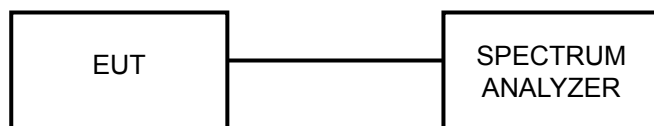

4.5.6 EUT OPERATING CONDITIONS

Same as 4.3.6.

4.5.7 TEST RESULTS

802.11b DSSS MODULATION

MODULATION TYPE	DBPSK	TRANSFER RATE	1Mbps
INPUT POWER (SYSTEM)	120Vac, 60 Hz	ENVIRONMENTAL CONDITIONS	26deg. C, 67%RH, 1005hPa
TESTED BY	Brad Wu		

CHANNEL	CHANNEL FREQUENCY (MHz)	RF POWER LEVEL IN 3 kHz BW (dBm)	MAXIMUM LIMIT (dBm)	PASS/FAIL
1	2412	-7.22	8	PASS
6	2437	-7.33	8	PASS
11	2462	-7.68	8	PASS

CH 1

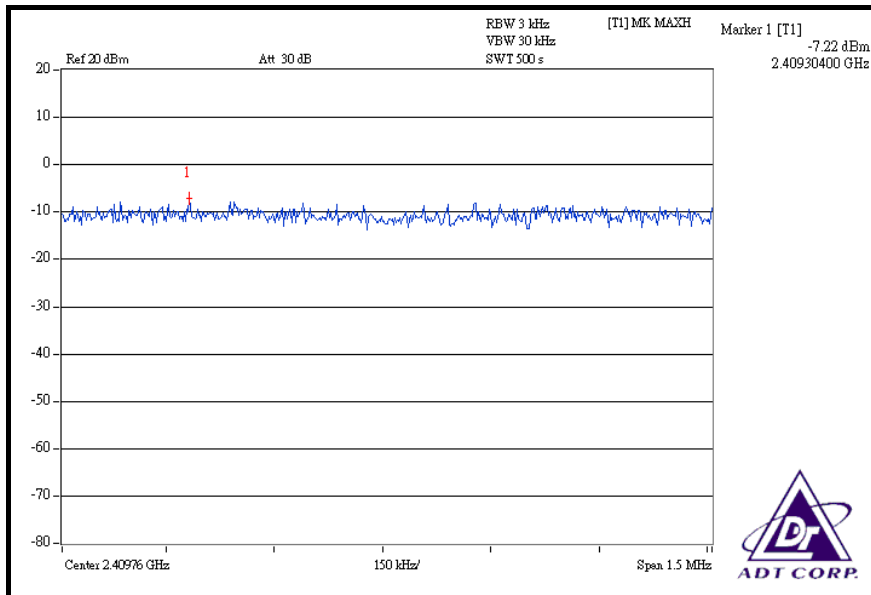



802.11g OFDM MODULATION

MODULATION TYPE	BPSK	TRANSFER RATE	6Mbps
INPUT POWER (SYSTEM)	120Vac, 60 Hz	ENVIRONMENTAL CONDITIONS	26deg. C, 67%RH, 1005hPa
TESTED BY	Brad Wu		

CHANNEL	CHANNEL FREQUENCY (MHz)	RF POWER LEVEL IN 3 kHz BW (dBm)	MAXIMUM LIMIT (dBm)	PASS/FAIL
1	2412	-11.81	8	PASS
6	2437	-11.63	8	PASS
11	2462	-12.12	8	PASS

CH 1

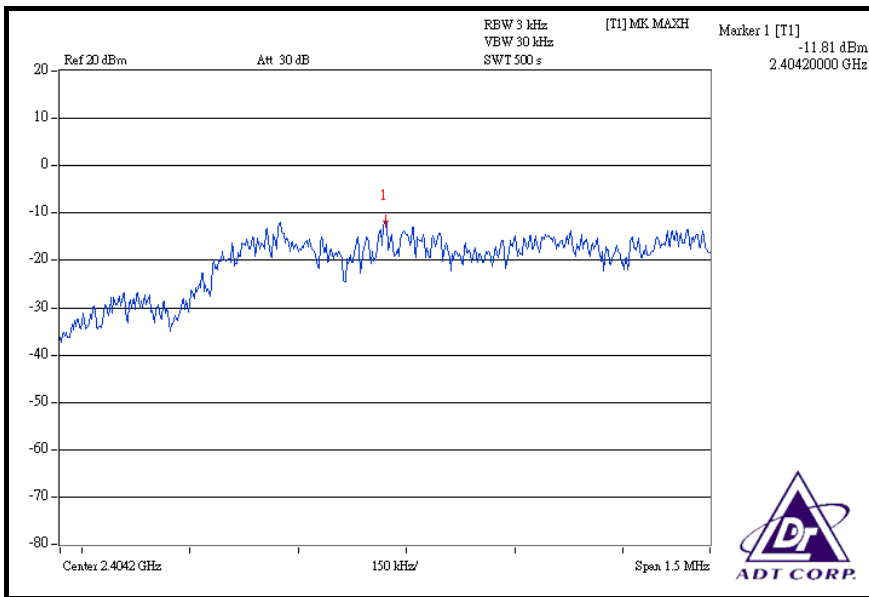



4.6 BAND EDGES MEASUREMENT

4.6.1 LIMITS OF BAND EDGES MEASUREMENT

Below -20dB of the highest emission level of operating band (in 100kHz Resolution Bandwidth).

4.6.2 TEST INSTRUMENTS

DESCRIPTION & MANUFACTURER	MODEL NO.	SERIAL NO.	CALIBRATED UNTIL
R&S SPECTRUM ANALYZER	FSP 40	100040	Jun. 28, 2008

NOTE: The calibration interval of the above test instruments is 12 months and the calibrations are traceable to NML/ROC and NIST/USA.

4.6.3 TEST PROCEDURE

The transmitter output was connected to the spectrum analyzer via a low loss cable. Set both RBW and VBW of spectrum analyzer to 100kHz and 300kHz with suitable frequency span including 100MHz bandwidth from band edge. The band edges was measured and recorded.

The spectrum plots (Peak RBW=100kHz, VBW=300kHz; Average RBW=1MHz, VBW= 10Hz) are attached on the following pages.

4.6.4 DEVIATION FROM TEST STANDARD

No deviation.

4.6.5 EUT OPERATING CONDITION

Same as 4.3.6.



4.6.6 TEST RESULTS

The spectrum plots are attached on the following 12 images. D1 line indicates the highest level, and D2 line indicates the 20dB offset below D1. It shows compliance with the requirement in part 15.247(d).

802.11b DSSS MODULATION_FOR TEST MODE A

NOTE 1: The band edge emission plot on the next second page shows 53.82dBc between carrier maximum power and local maximum emission in restrict band (2.35740GHz). The emission of carrier strength list in the test result of channel 1 at the item 4.2.7 is 109.40dBuV/m (Peak), so the maximum field strength in restrict band is $109.40 - 53.82 = 55.58$ dBuV/m which is under 74dBuV/m limit.

The band edge emission plot on the next second page shows 57.93dBc between carrier maximum power and local maximum emission in restrict band (2.39000GHz). The emission of carrier strength list in the test result of channel 1 at the item 4.2.7 is 105.49dBuV/m (Peak), so the maximum field strength in restrict band is $105.49 - 57.93 = 47.56$ dBuV/m which is under 54dBuV/m limit.

NOTE 2: The band edge emission plot on the next third page shows 54.77dBc between carrier maximum power and local maximum emission in restrict band (2.48420GHz). The emission of carrier strength list in the test result of channel 11 at the item 4.2.7 is 109.07dBuV/m (Peak), so the maximum field strength in restrict band is $109.07 - 54.77 = 54.30$ dBuV/m which is under 74dBuV/m limit.

The band edge emission plot on the next fourth page shows 55.55dBc between carrier maximum power and local maximum emission in restrict band (2.48350GHz). The emission of carrier strength list in the test result of channel 11 at the item 4.2.7 is 105.19dBuV/m (Peak), so the maximum field strength in restrict band is $105.19 - 55.55 = 49.64$ dBuV/m which is under 54dBuV/m limit.



FOR TEST MODE B

NOTE 1: The band edge emission plot on the next page shows 53.82dBc between carrier maximum power and local maximum emission in restrict band (2.35740GHz). The emission of carrier strength list in the test result of channel 1 at the item 4.2.7 is 107.82dBuV/m (Peak), so the maximum field strength in restrict band is $107.82 - 53.82 = 54.00$ dBuV/m which is under 74dBuV/m limit.

The band edge emission plot on the next page shows 57.93dBc between carrier maximum power and local maximum emission in restrict band (2.39000GHz). The emission of carrier strength list in the test result of channel 1 at the item 4.2.7 is 103.78dBuV/m (Peak), so the maximum field strength in restrict band is $103.78 - 57.93 = 45.85$ dBuV/m which is under 54dBuV/m limit.

NOTE 2: The band edge emission plot on the next second page shows 54.77dBc between carrier maximum power and local maximum emission in restrict band (2.48420GHz). The emission of carrier strength list in the test result of channel 11 at the item 4.2.7 is 107.72dBuV/m (Peak), so the maximum field strength in restrict band is $107.72 - 54.77 = 52.95$ dBuV/m which is under 74dBuV/m limit.

The band edge emission plot on the next third page shows 55.55dBc between carrier maximum power and local maximum emission in restrict band (2.48350GHz). The emission of carrier strength list in the test result of channel 11 at the item 4.2.7 is 103.68dBuV/m (Peak), so the maximum field strength in restrict band is $103.68 - 55.55 = 48.13$ dBuV/m which is under 54dBuV/m limit.

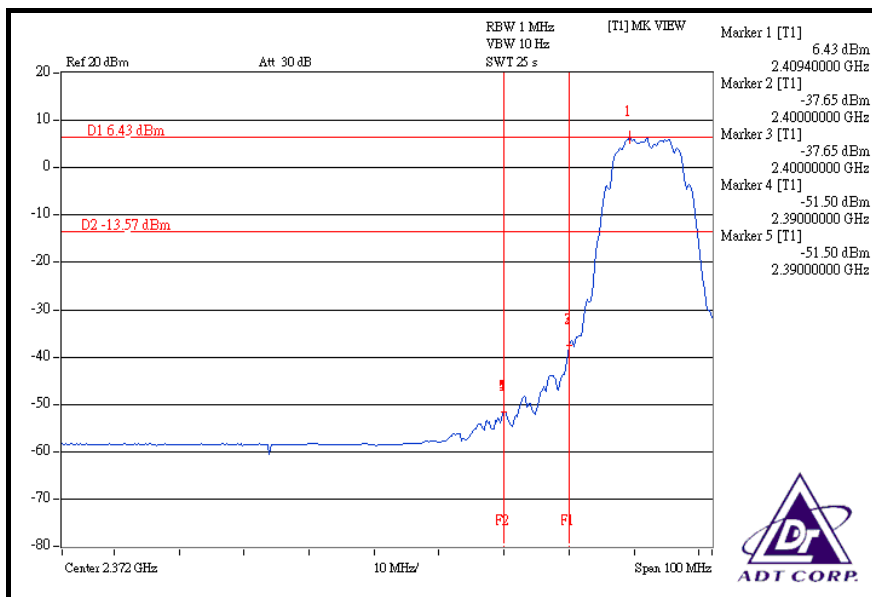
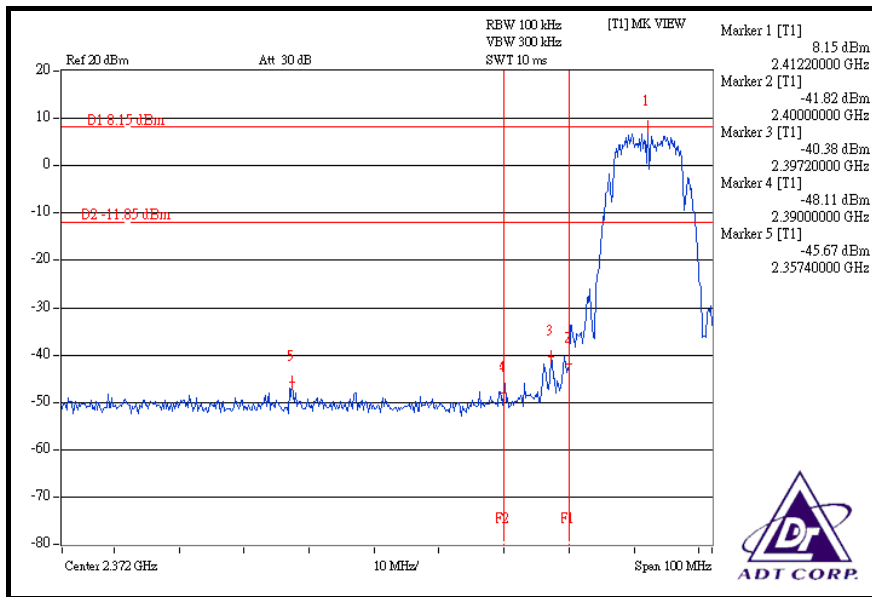

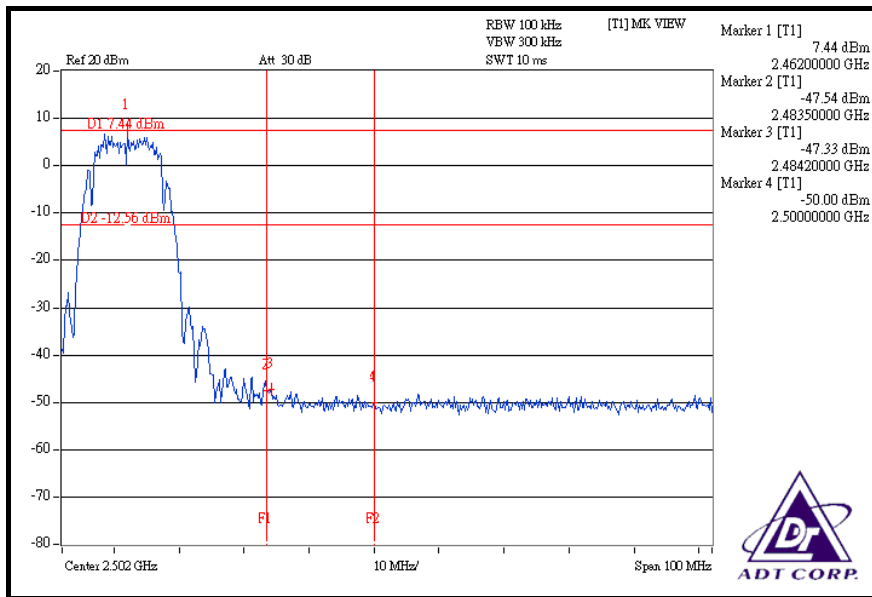
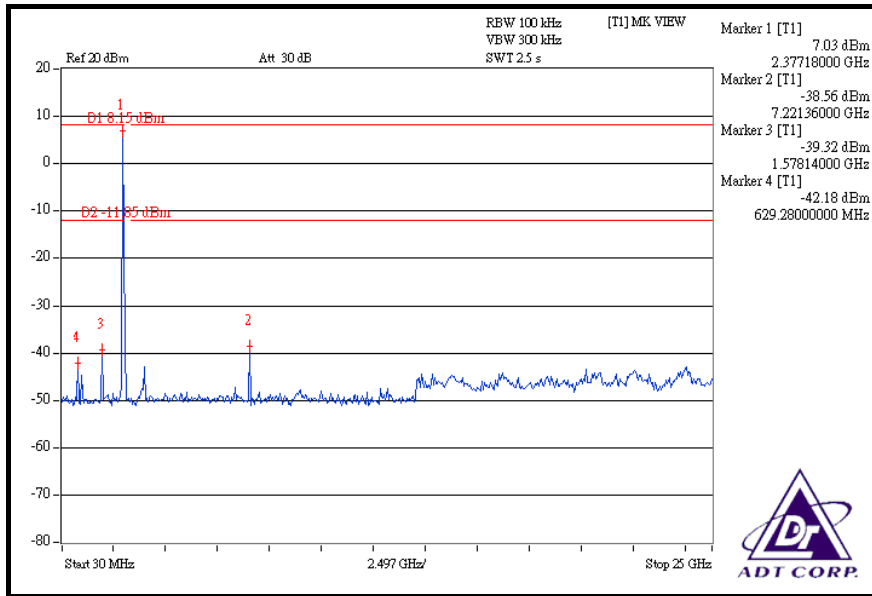

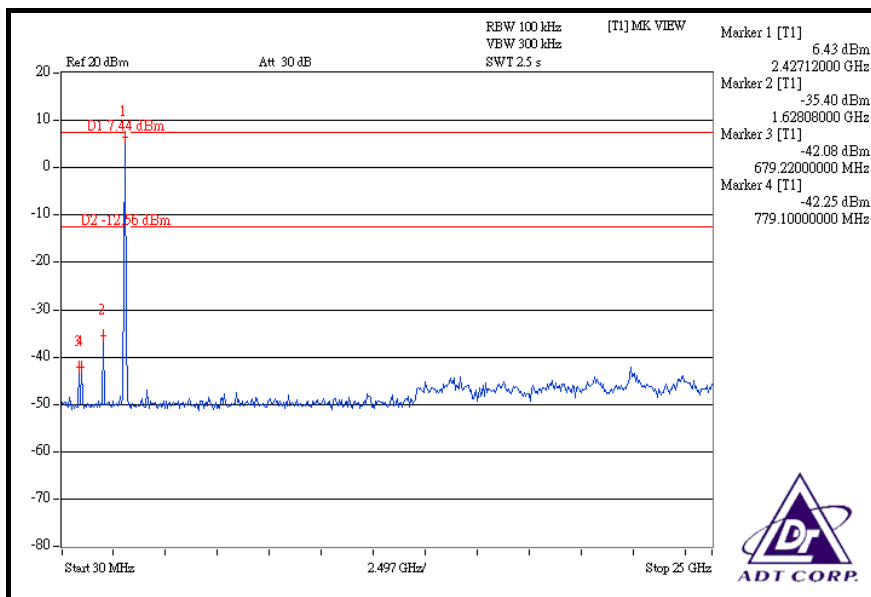
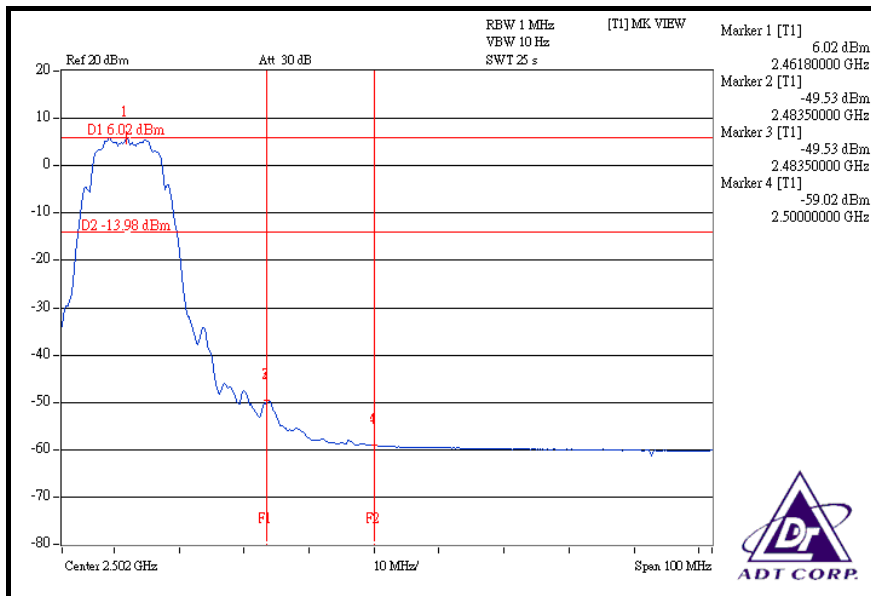

802.11g OFDM MODULATION _FOR TEST MODE A

NOTE 1: The band edge emission plot on the next second page shows 46.80dBc between carrier maximum power and local maximum emission in restrict band (2.38840GHz). The emission of carrier strength list in the test result of channel 1 at the item 4.2.7 is 110.34dBuV/m (Peak), so the maximum field strength in restrict band is $110.34 - 46.80 = 63.54$ dBuV/m which is under 74dBuV/m limit.

The band edge emission plot on the next second page shows 45.77dBc between carrier maximum power and local maximum emission in restrict band (2.39000GHz). The emission of carrier strength list in the test result of channel 1 at the item 4.2.7 is 98.65dBuV/m (Peak), so the maximum field strength in restrict band is $98.65 - 45.77 = 52.88$ dBuV/m which is under 54dBuV/m limit.

NOTE 2: The band edge emission plot on the next third page shows 49.33dBc between carrier maximum power and local maximum emission in restrict band (2.48460GHz). The emission of carrier strength list in the test result of channel 11 at the item 4.2.7 is 110.59dBuV/m (Peak), so the maximum field strength in restrict band is $110.59 - 49.33 = 61.26$ dBuV/m which is under 74dBuV/m limit.

The band edge emission plot on the next fourth page shows 45.85dBc between carrier maximum power and local maximum emission in restrict band (2.48350GHz). The emission of carrier strength list in the test result of channel 11 at the item 4.2.7 is 98.68dBuV/m (Peak), so the maximum field strength in restrict band is $98.68 - 45.85 = 52.83$ dBuV/m which is under 54dBuV/m limit.

FOR TEST MODE B

NOTE 1: The band edge emission plot on the next page shows 46.80dBc between carrier maximum power and local maximum emission in restrict band (2.38840GHz). The emission of carrier strength list in the test result of channel 1 at the item 4.2.7 is 109.38dBuV/m (Peak), so the maximum field strength in restrict band is $109.38 - 46.80 = 62.58$ dBuV/m which is under 74dBuV/m limit.

The band edge emission plot on the next page shows 45.77dBc between carrier maximum power and local maximum emission in restrict band (2.39000GHz). The emission of carrier strength list in the test result of channel 1 at the item 4.2.7 is 97.85dBuV/m (Peak), so the maximum field strength in restrict band is $97.85 - 45.77 = 52.08$ dBuV/m which is under 54dBuV/m limit.

NOTE 2: The band edge emission plot on the next second page shows 49.33dBc between carrier maximum power and local maximum emission in restrict band (2.48460GHz). The emission of carrier strength list in the test result of channel 11 at the item 4.2.7 is 109.14dBuV/m (Peak), so the maximum field strength in restrict band is $109.14 - 49.33 = 59.81$ dBuV/m which is under 74dBuV/m limit.

The band edge emission plot on the next third page shows 45.85dBc between carrier maximum power and local maximum emission in restrict band (2.48350GHz). The emission of carrier strength list in the test result of channel 11 at the item 4.2.7 is 97.56dBuV/m (Peak), so the maximum field strength in restrict band is $97.56 - 45.85 = 51.71$ dBuV/m which is under 54dBuV/m limit.

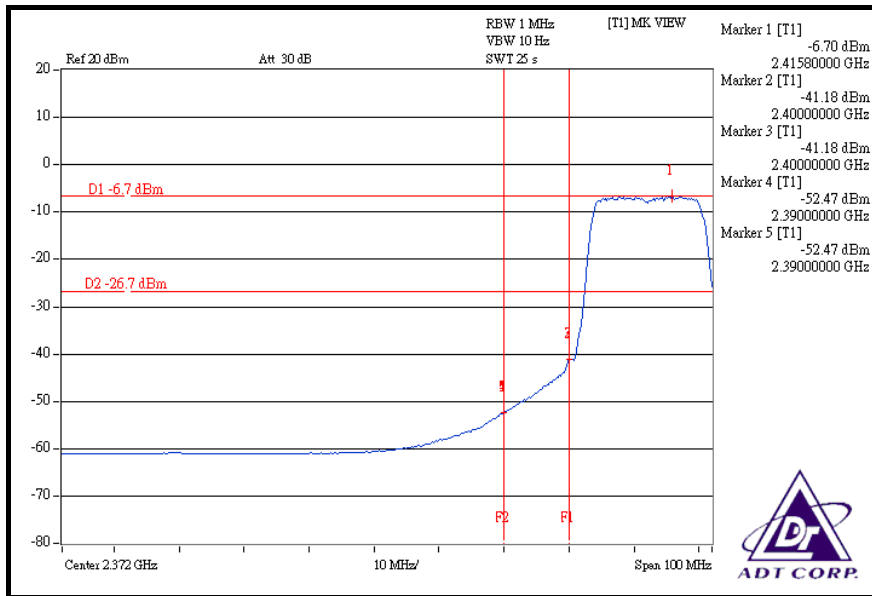
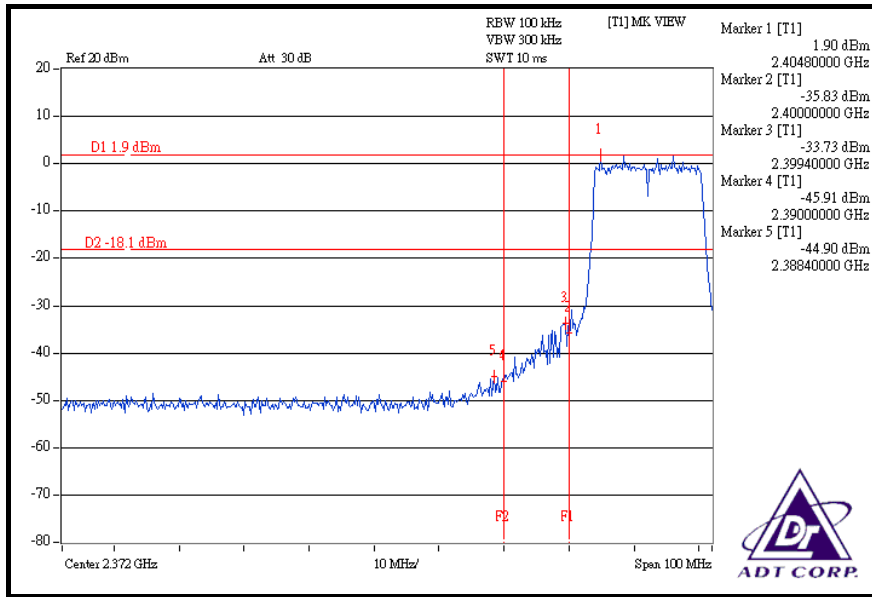

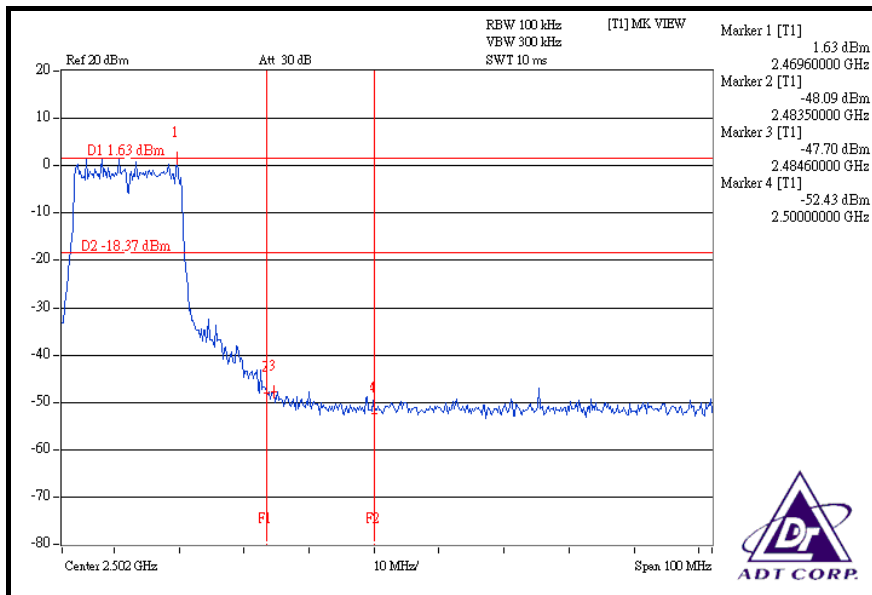
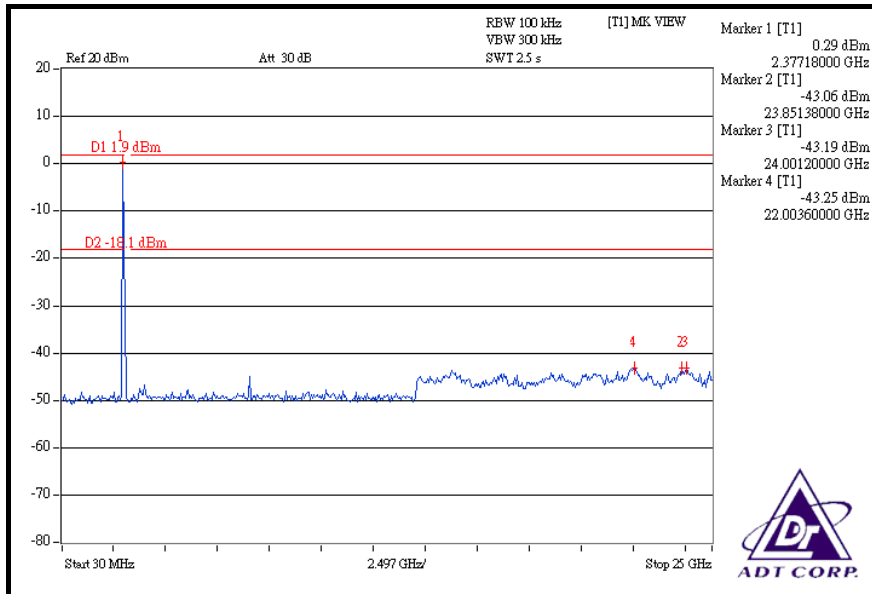

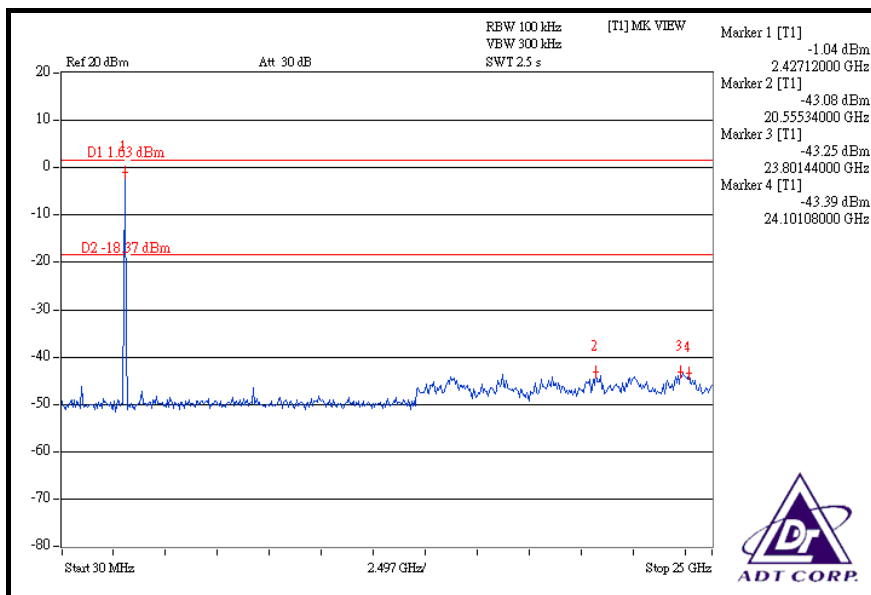
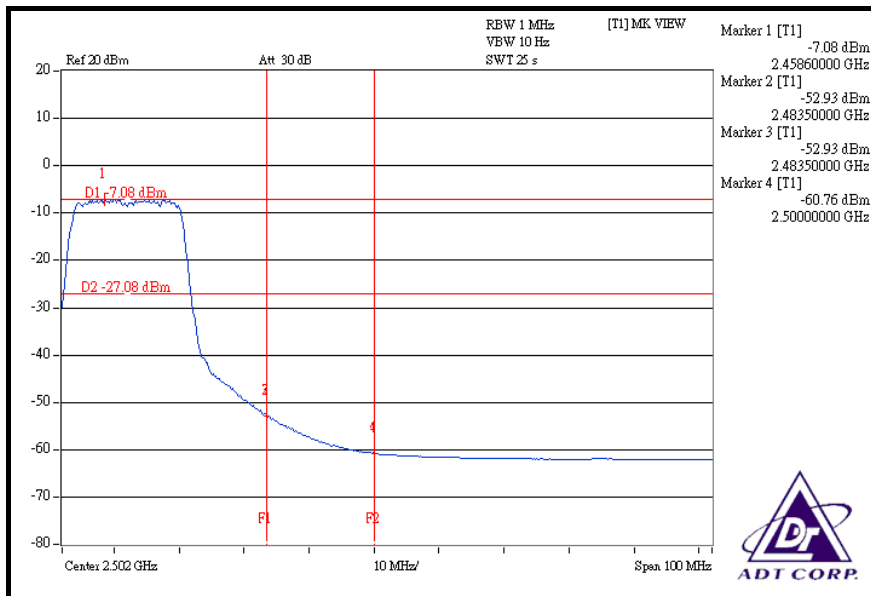

4.7 ANTENNA REQUIREMENT

4.7.1 STANDARD APPLICABLE

For intentional device, according to FCC 47 CFR Section 15.203, an intentional radiator shall be designed to ensure that no antenna other than that furnished by the responsible party shall be used with the device.

And according to FCC 47 CFR Section 15.247 (b), if transmitting antennas of directional gain greater than 6dBi are used, the power shall be reduced by the amount in dB that the directional gain of the antenna exceeds 6dBi.

4.7.2 ANTENNA CONNECTED CONSTRUCTION

The antennas used in this product are Dipole antenna with R-SMA connector and PIFA antenna with UFL antenna connector. The maximum Gain of the antenna is 2dBi.



5 PHOTOGRAPHS OF THE TEST CONFIGURATION

Please refer to the attached file (Test Setup Photo).



6 INFORMATION ON THE TESTING LABORATORIES

We, ADT Corp., were founded in 1988 to provide our best service in EMC, Radio, Telecom and Safety consultation. Our laboratories are accredited and approved by the following approval agencies according to ISO/IEC 17025.

USA	FCC, UL, A2LA
Germany	TUV Rheinland
Japan	VCCI
Norway	NEMKO
Canada	INDUSTRY CANADA , CSA
R.O.C.	TAF, BSMI, NCC
Netherlands	Telefication
Singapore	GOST-ASIA(MOU)
Russia	CERTIS(MOU)

Copies of accreditation certificates of our laboratories obtained from approval agencies can be downloaded from our web site: www.adt.com.tw/index.5/phtml. If you have any comments, please feel free to contact us at the following:

Linko EMC/RF Lab
Tel: 886-2-26052180
Fax: 886-2-26051924

Hsin Chu EMC/RF Lab
Tel: 886-3-5935343
Fax: 886-3-5935342

Hwa Ya EMC/RF/Safety/Telecom Lab
Tel: 886-3-3183232
Fax: 886-3-3185050

Web Site: www.adt.com.tw

The address and road map of all our labs can be found in our web site also.

7 APPENDIX A – MODIFICATIONS RECORDERS FOR ENGINEERING CHANGES TO THE EUT BY THE LAB

No any modifications are made to the EUT by the lab during the test.