



FCC TEST REPORT

REPORT NO.: RF961119L11
MODEL NO.: WLG-1204 (refer to item 3.1 for more details)
RECEIVED: Nov. 19, 2007
TESTED: Nov. 20 ~ Dec. 28, 2007
ISSUED: Jan. 02, 2008

APPLICANT: CAMEO COMMUNICATIONS, INC.

ADDRESS: 5F, No.42, Sec. 6, Mincyuan E. Rd., Neihu District, Taipei City 114, Taiwan

ISSUED BY: Advance Data Technology Corporation

LAB ADDRESS: No. 47, 14th Ling, Chia Pau Tsuen, Lin Kou Hsiang, Taipei Hsien, Taiwan, R.O.C.

TEST LOCATION: No. 19, Hwa Ya 2nd Rd., Wen Hwa Tsuen, Kwei Shan Hsiang, Taoyuan Hsien, Taiwan, R.O.C.

This test report consists of 53 pages in total. It may be duplicated completely for legal use with the approval of the applicant. It should not be reproduced except in full, without the written approval of our laboratory. The client should not use it to claim product endorsement by TAF, A2LA or any government agencies. The test results in the report only apply to the tested sample.





Table of Contents

1	CERTIFICATION.....	4
2	SUMMARY OF TEST RESULTS	5
2.1	MEASUREMENT UNCERTAINTY.....	5
3	GENERAL INFORMATION.....	6
3.1	GENERAL DESCRIPTION OF EUT	6
3.2	DESCRIPTION OF TEST MODES	7
3.2.1	CONFIGURATION OF SYSTEM UNDER TEST	7
3.2.2	TEST MODE APPLICABILITY AND TESTED CHANNEL DETAIL	8
3.3	GENERAL DESCRIPTION OF APPLIED STANDARDS	9
3.4	DESCRIPTION OF SUPPORT UNITS	10
4	TEST TYPES AND RESULTS	11
4.1	RADIATED EMISSION MEASUREMENT	11
4.1.1	LIMITS OF RADIATED EMISSION MEASUREMENT.....	11
4.1.2	TEST INSTRUMENTS.....	12
4.1.3	TEST PROCEDURES	13
4.1.4	DEVIATION FROM TEST STANDARD.....	13
4.1.5	TEST SETUP.....	14
4.1.6	EUT OPERATING CONDITIONS	14
4.1.7	TEST RESULTS	15
4.2	CONDUCTED EMISSION MEASUREMENT	22
4.2.1	LIMITS OF CONDUCTED EMISSION MEASUREMENT.....	22
4.2.2	TEST INSTRUMENTS.....	22
4.2.3	TEST PROCEDURES	23
4.2.4	DEVIATION FROM TEST STANDARD.....	23
4.2.5	TEST SETUP.....	24
4.2.6	EUT OPERATING CONDITIONS	24
4.2.7	TEST RESULTS	25
4.3	6dB BANDWIDTH MEASUREMENT.....	27
4.3.1	LIMITS OF 6dB BANDWIDTH MEASUREMENT	27
4.3.2	TEST INSTRUMENTS.....	27
4.3.3	TEST PROCEDURE.....	27
4.3.4	DEVIATION FROM TEST STANDARD.....	27
4.3.5	TEST SETUP.....	28
4.3.6	EUT OPERATING CONDITIONS	28
4.3.7	TEST RESULTS	29
4.4	MAXIMUM PEAK OUTPUT POWER.....	33
4.4.1	LIMITS OF MAXIMUM PEAK OUTPUT POWER MEASUREMENT	33
4.4.2	TEST INSTRUMENTS.....	33
4.4.3	TEST PROCEDURES	34
4.4.4	DEVIATION FROM TEST STANDARD.....	34
4.4.5	TEST SETUP.....	34
4.4.6	EUT OPERATING CONDITIONS	34



4.4.7	TEST RESULTS	35
4.5	POWER SPECTRAL DENSITY MEASUREMENT	36
4.5.1	LIMITS OF POWER SPECTRAL DENSITY MEASUREMENT	36
4.5.2	TEST INSTRUMENTS.....	36
4.5.3	TEST PROCEDURE.....	36
4.5.4	DEVIATION FROM TEST STANDARD.....	36
4.5.5	TEST SETUP.....	36
4.5.6	EUT OPERATING CONDITIONS	36
4.5.7	TEST RESULTS	37
4.6	BAND EDGES MEASUREMENT	41
4.6.1	LIMITS OF BAND EDGES MEASUREMENT.....	41
4.6.2	TEST INSTRUMENTS.....	41
4.6.3	TEST PROCEDURE.....	41
4.6.4	DEVIATION FROM TEST STANDARD.....	41
4.6.5	EUT OPERATING CONDITION.....	41
4.6.6	TEST RESULTS	42
4.7	ANTENNA REQUIREMENT	50
4.7.1	STANDARD APPLICABLE	50
4.7.2	ANTENNA CONNECTED CONSTRUCTION	50
5	PHOTOGRAPHS OF THE TEST CONFIGURATION.....	51
6	INFORMATION ON THE TESTING LABORATORIES	52
7	APPENDIX A – MODIFICATIONS RECORDERS FOR ENGINEERING CHANGES TO THE EUT BY THE LAB.....	53



1 CERTIFICATION

PRODUCT: 802.11g Wireless PCI Adapter
MODEL: WLG-1204 (refer to item 3.1 for more details)
BRAND: CAMEO
APPLICANT: CAMEO COMMUNICATIONS, INC.
TESTED: Nov. 20 ~ Dec. 28, 2007
TEST SAMPLE: ENGINEERING SAMPLE
STANDARDS: **FCC Part 15, Subpart C (Section 15.247)**
ANSI C63.4-2003

The above equipment (model: WLG-1204) has been tested by **Advance Data Technology Corporation**, and found compliance with the requirement of the above standards. The test record, data evaluation & Equipment Under Test (EUT) configurations represented herein are true and accurate accounts of the measurements of the sample's EMC characteristics under the conditions specified in this report.

PREPARED BY :  , **DATE:** Jan. 02, 2008
Joanna Wang / Senior Specialist

TECHNICAL ACCEPTANCE :  , **DATE:** Jan. 02, 2008
Responsible for RF Long Chen / Senior Engineer

APPROVED BY :  , **DATE:** Jan. 02, 2008
Gary Chang / Assistant Manager

2 SUMMARY OF TEST RESULTS

The EUT has been tested according to the following specifications:

APPLIED STANDARD: FCC Part 15, Subpart C			
Standard Section	Test Type and Limit	Result	Remark
15.207	AC Power Conducted Emission	PASS	Meet the requirement of limit. Minimum passing margin is -13.99dB at 0.654MHz.
15.247(a)(2)	Spectrum Bandwidth of a Direct Sequence Spread Spectrum System Limit: min. 500kHz	PASS	Meet the requirement of limit.
15.247(b)	Maximum Peak Output Power Limit: max. 30dBm	PASS	Meet the requirement of limit.
15.247(d)	Radiated Emissions Limit: Table 15.209	PASS	Meet the requirement of limit. Minimum passing margin is -1.46dB at 2483.500MHz.
15.247(e)	Power Spectral Density Limit: max. 8dBm	PASS	Meet the requirement of limit.
15.247(d)	Band Edge Measurement Limit: 20dB less than the peak value of fundamental frequency	PASS	Meet the requirement of limit.

2.1 MEASUREMENT UNCERTAINTY

Where relevant, the following measurement uncertainty levels have been estimated for tests performed on the EUT as specified in CISPR 16-4-2:

MEASUREMENT	FREQUENCY	UNCERTAINTY
Conducted emissions	9kHz ~ 30MHz	2.44 dB
Radiated emissions	30MHz ~ 200MHz	3.34 dB
	200MHz ~ 1000MHz	3.35 dB
	1GHz ~ 18GHz	2.26 dB
	18GHz ~ 40GHz	1.94 dB

This uncertainty represents an expanded uncertainty expressed at approximately the 95% confidence level using a coverage factor of k=2.



3 GENERAL INFORMATION

3.1 GENERAL DESCRIPTION OF EUT

PRODUCT	802.11g Wireless PCI Adapter
MODEL NO.	WLG-1204 (refer to NOTE 1 for more details)
FCC ID	NHPWLG1204B
POWER SUPPLY	3.3Vdc from host equipment
MODULATION TYPE	CCK, DQPSK, DBPSK for DSSS 64QAM, 16QAM, QPSK, BPSK for OFDM
MODULATION TECHNOLOGY	DSSS, OFDM
TRANSFER RATE	802.11b: 11/5.5/2/1Mbps 802.11g: 54/48/36/24/18/12/9/6Mbps
FREQUENCY RANGE	2412MHz ~ 2462MHz
NUMBER OF CHANNEL	11
MAXIMUM OUTPUT POWER	45.186mW
ANTENNA TYPE	Dipole antenna with 1.8dBi gain
DATA CABLE	NA
I/O PORTS	NA
ACCESSORY DEVICES	NA

NOTE:

1. The models as below are identical to each other except for their model name and brand name due to marketing requirement.

BRAND NAME	MODEL NAME	BRAND NAME	MODEL NAME
CAMEO	WLG-1204	Connectland	WIRE-CNL-G-PCI
PLANET	WL-8317	Linktek	ET-WNP-0154R
Level One	WNC-0301	Azio	AWD254
AIRLINK101	AWLH3028	EUSSO	UGL2454-VPB
ALLNET	ALL0261R	Atlantisland	A02-PCI-W54
TRENDware	TEW-423PI	X-Net	WGLPC
Encore	ENLWI-G2	Digitus	DN-7006GT
PEABIRD	PEAB-WLG-PCI	-	-

2. The EUT, operates in the 2.4GHz frequency range, lets you connect IEEE 802.11g or IEEE 802.11b devices to the network. With its high-speed data transmissions of up to 54Mbps.
3. The above EUT information was declared by manufacturer and for more detailed features description, please refer to the manufacturer's specifications or User's Manual.

3.2 DESCRIPTION OF TEST MODES

Eleven channels are provided to this EUT.

CHANNEL	FREQUENCY	CHANNEL	FREQUENCY
1	2412 MHz	7	2442 MHz
2	2417 MHz	8	2447 MHz
3	2422 MHz	9	2452 MHz
4	2427 MHz	10	2457 MHz
5	2432 MHz	11	2462 MHz
6	2437 MHz		

3.2.1 CONFIGURATION OF SYSTEM UNDER TEST

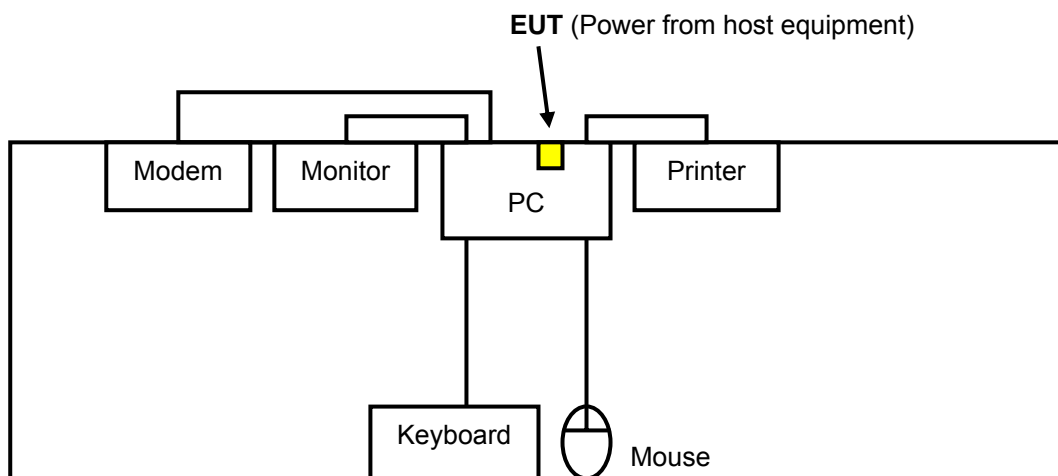

3.2.2 TEST MODE APPLICABILITY AND TESTED CHANNEL DETAIL

EUT Configure Mode	Applicable to				Description
	RE \geq 1G	RE $<$ 1G	PLC	APCM	
-	√	√	√	√	-

Where **PLC**: Power Line Conducted Emission **RE $<$ 1G**: Radiated Emission below 1GHz
RE \geq 1G: Radiated Emission above 1GHz **APCM**: Antenna Port Conducted Measurement

RADIATED EMISSION TEST (ABOVE 1 GHz):

- Pre-Scan has been conducted to determine the worst-case mode from all possible combinations between available modulations, data rates, and antenna ports (if EUT with antenna diversity architecture).
- Following channel(s) was (were) selected for the final test as listed below.

Mode	Available Channel	Tested Channel	Modulation Technology	Modulation Type	Data Rate (Mbps)
802.11b	1 to 11	1, 6, 11	DSSS	DBPSK	1
802.11g	1 to 11	1, 6, 11	OFDM	BPSK	6

RADIATED EMISSION TEST (BELOW 1 GHz):

- Pre-Scan has been conducted to determine the worst-case mode from all possible combinations between available modulations, data rates, and antenna ports (if EUT with antenna diversity architecture).
- Following channel(s) was (were) selected for the final test as listed below.

Mode	Available Channel	Tested Channel	Modulation Technology	Modulation Type	Data Rate (Mbps)
802.11b	1 to 11	6	DSSS	DBPSK	1

POWER LINE CONDUCTED EMISSION TEST:

- Pre-Scan has been conducted to determine the worst-case mode from all possible combinations between available modulations, data rates and antenna ports (if EUT with antenna diversity architecture).
- Following channel(s) was (were) selected for the final test as listed below.

Mode	Available Channel	Tested Channel	Modulation Technology	Modulation Type	Data Rate (Mbps)
802.11b	1 to 11	6	DSSS	DBPSK	1

BANDEDGE MEASUREMENT:

- Pre-Scan has been conducted to determine the worst-case mode from all possible combinations between available modulations, data rates and antenna ports (if EUT with antenna diversity architecture).
- Following channel(s) was (were) selected for the final test as listed below.

Mode	Available Channel	Tested Channel	Modulation Technology	Modulation Type	Data Rate (Mbps)
802.11b	1 to 11	1, 11	DSSS	DBPSK	1
802.11g	1 to 11	1, 11	OFDM	BPSK	6

ANTENNA PORT CONDUCTED MEASUREMENT:

- Pre-Scan has been conducted to determine the worst-case mode from all possible combinations between available modulations, data rates and antenna ports (if EUT with antenna diversity architecture).
- Following channel(s) was (were) selected for the final test as listed below.

Mode	Available Channel	Tested Channel	Modulation Technology	Modulation Type	Data Rate (Mbps)
802.11b	1 to 11	1, 6, 11	DSSS	DBPSK	1
802.11g	1 to 11	1, 6, 11	OFDM	BPSK	6

3.3 GENERAL DESCRIPTION OF APPLIED STANDARDS

The EUT is a RF product. According to the specifications of the manufacturer, it must comply with the requirements of the following standards:

FCC Part 15, Subpart C (15.247)

ANSI C63.4- 2003

All test items have been performed and recorded as per the above standards.

NOTE: The EUT is also considered as a kind of computer peripheral, because the connection to computer is necessary for typical use. It has been verified to comply with the requirements of FCC Part 15, Subpart B, Class B (DoC). The test report has been issued separately.



3.4 DESCRIPTION OF SUPPORT UNITS

The EUT has been tested as an independent unit together with other necessary accessories or support units. The following support units or accessories were used to form a representative test configuration during the tests.

NO.	PRODUCT	BRAND	MODEL NO.	SERIAL NO.	FCC ID
1	PC	MSI	Hetis 865G Giga	3AS0119585	FCC DoC Approved
2	LCD MONITOR	E-GOLDEN	PA1502	1721502F01210124	FCC DoC Approved
3	PRINTER	EPSON	LQ-300+	DCGY054011	FCC DoC Approved
4	MODEM	ACEEX	1414V/3	0401008253	IFAXDM1414
5	KEYBOARD	HP	SK-1688	C0306115117	GYUR84SK
6	MOUSE	ASUS	990215467	NA	IOWCM-PS2C

NO.	SIGNAL CABLE DESCRIPTION OF THE ABOVE SUPPORT UNITS
1	NA
2	1.8m shielded cable without core.
3	1.8m braid shielded wire, DB25 connector, w/o core.
4	1.2m braid shielded wire, DB25 & DB9 connector, w/o core.
5	1.3m foil shielded wire, PS/2 Connector, w/o core.
6	1.2m shielded cable without core.

NOTE: All power cords of the above support units are non shielded (1.8m).

4 TEST TYPES AND RESULTS

4.1 RADIATED EMISSION MEASUREMENT

4.1.1 LIMITS OF RADIATED EMISSION MEASUREMENT

Emissions radiated outside of the specified bands, shall be according to the general radiated limits in 15.209 as following:

Frequencies (MHz)	Field strength (microvolts/meter)	Measurement distance (meters)
0.009-0.490	2400/F(kHz)	300
0.490-1.705	24000/F(kHz)	30
1.705-30.0	30	30
30-88	100	3
88-216	150	3
216-960	200	3
Above 960	500	3

NOTE:

1. The lower limit shall apply at the transition frequencies.
2. Emission level (dBuV/m) = 20 log Emission level (uV/m).
3. As shown in 15.35(b), for frequencies above 1000MHz, the field strength limits are based on average detector, however, the peak field strength of any emission shall not exceed the maximum permitted average limits, specified above by more than 20dB under any condition of modulation.



4.1.2 TEST INSTRUMENTS

DESCRIPTION & MANUFACTURER	MODEL NO.	SERIAL NO.	CALIBRATED UNTIL
Test Receiver ROHDE & SCHWARZ	ESCI	100424	Jul. 27, 2008
Spectrum Analyzer ROHDE & SCHWARZ	FSP40	100041	Feb. 26, 2008
BILOG Antenna SCHWARZBECK	VULB9168	9168-160	May 31, 2008
HORN Antenna SCHWARZBECK	9120D	9120D-209	Jun. 28, 2008
HORN Antenna SCHWARZBECK	BBHA 9170	BBHA9170243	Dec. 24, 2008
Preamplifier Agilent	8447D	2944A10633	Oct. 28, 2008
Preamplifier Agilent	8449B	3008A01964	Oct. 23, 2008
RF signal cable HUBER+SUHNNER	SUCOFLEX 104	283402/4	Dec. 06, 2008
RF signal cable HUBER+SUHNNER	SUCOFLEX 104	251644/4	Dec. 06, 2008
Software ADT.	ADT_Radiated_V7.6	NA	NA
Antenna Tower inn-co GmbH	MA 4000	013303	NA
Antenna Tower Controller inn-co GmbH	CO2000	017303	NA
Turn Table ADT.	TT100.	TT93021703	NA
Turn Table Controller ADT.	SC100.	SC93021703	NA

- NOTE:**
1. The calibration interval of the above test instruments is 12 months and the calibrations are traceable to NML/ROC and NIST/USA.
 2. The test was performed in HwaYa Chamber 3.
 3. The horn antenna and HP preamplifier (model: 8449B) are used only for the measurement of emission frequency above 1GHz if tested.
 4. The VCCI Site Registration No. is R-237.
 5. The IC Site Registration No. is IC3789B-3.

4.1.3 TEST PROCEDURES

- a. The EUT was placed on the top of a rotating table 0.8 meters above the ground at a 3 meters semi-anechoic chamber. The table was rotated 360 degrees to determine the position of the highest radiation.
- b. The EUT was set 3 meters away from the interference-receiving antenna, which was mounted on the top of a variable-height antenna tower.
- c. The antenna is a broadband antenna, and its height is varied from one meter to four meters above the ground to determine the maximum value of the field strength. Both horizontal and vertical polarizations of the antenna are set to make the measurement.
- d. For each suspected emission, the EUT was arranged to its worst case and then the antenna was tuned to heights from 1 meter to 4 meters and the rotatable table was turned from 0 degrees to 360 degrees to find the maximum reading.
- e. The test-receiver system was set to Peak Detect Function and Specified Bandwidth with Maximum Hold Mode.
- f. If the emission level of the EUT in peak mode was lower than the limit specified, then testing could be stopped and the peak values of the EUT would be reported. Otherwise the emissions would be re-tested one by one using peak, quasi-peak method or average method as specified and then reported in data sheet.

NOTE:

1. The resolution bandwidth and video bandwidth of test receiver/spectrum analyzer is 120kHz for Peak detection (PK) and Quasi-peak detection (QP) at frequency below 1GHz.
2. The resolution bandwidth of test receiver/spectrum analyzer is 1 MHz and video bandwidth is 3MHz for Peak detection at frequency above 1GHz.
3. The resolution bandwidth of test receiver/spectrum analyzer is 1 MHz and the video bandwidth is 10 Hz for Average detection (AV) at frequency above 1GHz.
4. All modes of operation were investigated and the worst-case emissions are reported.

4.1.4 DEVIATION FROM TEST STANDARD

No deviation.

4.1.5 TEST SETUP

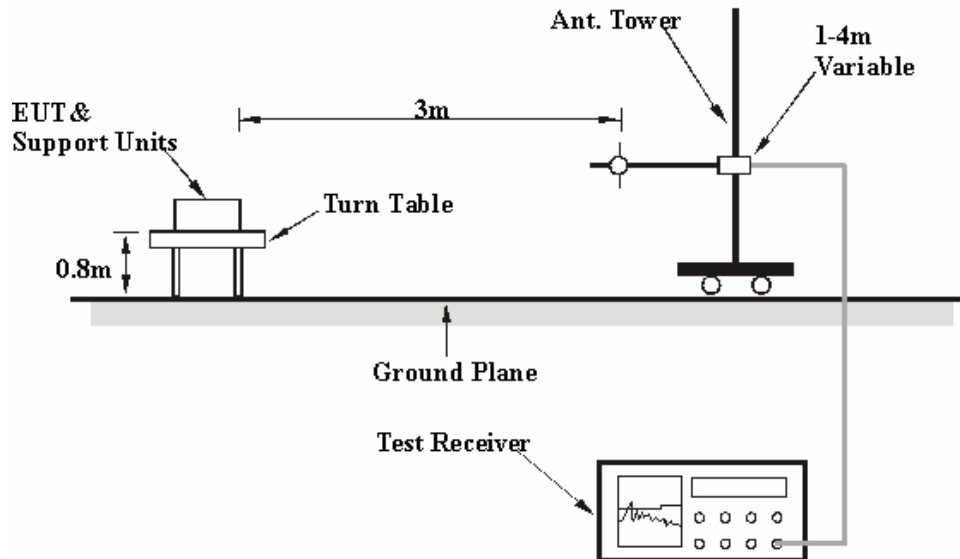

For the actual test configuration, please refer to the attached file (Test Setup Photo).

4.1.6 EUT OPERATING CONDITIONS

- Plugged the EUT into PC and placed on a testing table.
- The PC ran a test program (provided by manufacturer) to enable EUT under transmission condition continuously at specific channel frequency.
- The necessary accessories enable the system in full functions.



4.1.7 TEST RESULTS

802.11b DSSS MODULATION

EUT TEST CONDITION		MEASUREMENT DETAIL	
CHANNEL	Channel 1	FREQUENCY RANGE	1 ~ 25GHz
INPUT POWER (SYSTEM)	120Vac, 60 Hz	DETECTOR FUNCTION	Peak (PK) Average (AV)
ENVIRONMENTAL CONDITIONS	25deg. C, 66%RH 1016hPa	TESTED BY	Dean Wang

ANTENNA POLARITY & TEST DISTANCE: HORIZONTAL AT 3 M								
NO.	FREQ. (MHz)	EMISSION LEVEL (dBuV/m)	LIMIT (dBuV/m)	MARGIN (dB)	ANTENNA HEIGHT (m)	TABLE ANGLE (Degree)	RAW VALUE (dBuV)	CORRECTION FACTOR (dB/m)
1	2386.00	58.26 PK	74.00	-15.74	1.13 H	27	26.03	32.23
2	2386.00	48.04 AV	54.00	-5.96	1.13 H	27	15.81	32.23
3	*2412.00	106.42 PK			1.13 H	27	74.10	32.32
4	*2412.00	102.02 AV			1.13 H	27	69.70	32.32
5	4824.00	53.08 PK	74.00	-20.92	1.06 H	0	14.95	38.13
6	4824.00	47.18 AV	54.00	-6.82	1.06 H	0	9.05	38.13
ANTENNA POLARITY & TEST DISTANCE: VERTICAL AT 3 M								
NO.	FREQ. (MHz)	EMISSION LEVEL (dBuV/m)	LIMIT (dBuV/m)	MARGIN (dB)	ANTENNA HEIGHT (m)	TABLE ANGLE (Degree)	RAW VALUE (dBuV)	CORRECTION FACTOR (dB/m)
1	2386.00	60.24 PK	74.00	-13.76	1.15 V	337	28.01	32.23
2	2386.00	49.50 AV	54.00	-4.50	1.15 V	337	17.27	32.23
3	*2412.00	109.02 PK			1.15 V	337	76.70	32.32
4	*2412.00	104.46 AV			1.15 V	337	72.14	32.32
5	4824.00	56.02 PK	74.00	-17.98	1.16 V	9	17.89	38.13
6	4824.00	52.03 AV	54.00	-1.97	1.16 V	9	13.90	38.13

- REMARKS:**
1. Emission level (dBuV/m) = Raw Value (dBuV) + Correction Factor (dB/m).
 2. Correction Factor (dB/m) = Antenna Factor (dB/m) + Cable Factor (dB).
 3. The other emission levels were very low against the limit.
 4. Margin value = Emission level – Limit value.
 5. “ * “: Fundamental frequency.



EUT TEST CONDITION		MEASUREMENT DETAIL	
CHANNEL	Channel 6	FREQUENCY RANGE	1 ~ 25GHz
INPUT POWER (SYSTEM)	120Vac, 60 Hz	DETECTOR FUNCTION	Peak (PK) Average (AV)
ENVIRONMENTAL CONDITIONS	25deg. C, 66%RH 1016hPa	TESTED BY	Dean Wang

ANTENNA POLARITY & TEST DISTANCE: HORIZONTAL AT 3 M								
NO.	FREQ. (MHz)	EMISSION LEVEL (dBuV/m)	LIMIT (dBuV/m)	MARGIN (dB)	ANTENNA HEIGHT (m)	TABLE ANGLE (Degree)	RAW VALUE (dBuV)	CORRECTION FACTOR (dB/m)
1	*2437.00	106.93 PK			1.15 H	31	74.53	32.40
2	*2437.00	102.57 AV			1.15 H	31	70.17	32.40
3	4874.00	53.82 PK	74.00	-20.18	1.05 H	12	15.50	38.32
4	4874.00	47.69 AV	54.00	-6.31	1.05 H	12	9.37	38.32
ANTENNA POLARITY & TEST DISTANCE: VERTICAL AT 3 M								
NO.	FREQ. (MHz)	EMISSION LEVEL (dBuV/m)	LIMIT (dBuV/m)	MARGIN (dB)	ANTENNA HEIGHT (m)	TABLE ANGLE (Degree)	RAW VALUE (dBuV)	CORRECTION FACTOR (dB/m)
1	*2437.00	109.60 PK			1.13 V	8	77.20	32.40
2	*2437.00	105.08 AV			1.13 V	8	72.68	32.40
3	4874.00	56.12 PK	74.00	-17.88	1.25 V	345	17.80	38.32
4	4874.00	52.47 AV	54.00	-1.53	1.25 V	345	14.15	38.32

- REMARKS:**
1. Emission level (dBuV/m) = Raw Value (dBuV) + Correction Factor (dB/m).
 2. Correction Factor (dB/m) = Antenna Factor (dB/m) + Cable Factor (dB).
 3. The other emission levels were very low against the limit.
 4. Margin value = Emission level – Limit value.
 5. “ * “: Fundamental frequency.



EUT TEST CONDITION		MEASUREMENT DETAIL	
CHANNEL	Channel 11	FREQUENCY RANGE	1 ~ 25GHz
INPUT POWER (SYSTEM)	120Vac, 60 Hz	DETECTOR FUNCTION	Peak (PK) Average (AV)
ENVIRONMENTAL CONDITIONS	25deg. C, 66%RH 1016hPa	TESTED BY	Dean Wang

ANTENNA POLARITY & TEST DISTANCE: HORIZONTAL AT 3 M								
NO.	FREQ. (MHz)	EMISSION LEVEL (dBuV/m)	LIMIT (dBuV/m)	MARGIN (dB)	ANTENNA HEIGHT (m)	TABLE ANGLE (Degree)	RAW VALUE (dBuV)	CORRECTION FACTOR (dB/m)
1	*2462.00	106.85 PK			1.08 H	23	74.37	32.48
2	*2462.00	102.24 AV			1.08 H	23	69.76	32.48
3	2483.50	58.69 PK	74.00	-15.31	1.08 H	23	26.13	32.56
4	2483.50	48.07 AV	54.00	-5.93	1.08 H	23	15.51	32.56
5	4924.00	53.57 PK	74.00	-20.43	1.23 H	35	15.11	38.46
6	4924.00	48.11 AV	54.00	-5.89	1.23 H	35	9.65	38.46
ANTENNA POLARITY & TEST DISTANCE: VERTICAL AT 3 M								
NO.	FREQ. (MHz)	EMISSION LEVEL (dBuV/m)	LIMIT (dBuV/m)	MARGIN (dB)	ANTENNA HEIGHT (m)	TABLE ANGLE (Degree)	RAW VALUE (dBuV)	CORRECTION FACTOR (dB/m)
1	*2462.00	109.44 PK			1.13 V	11	76.96	32.48
2	*2462.00	104.99 AV			1.13 V	11	72.51	32.48
3	2483.50	59.69 PK	74.00	-14.31	1.13 V	11	27.13	32.56
4	2483.50	49.41 AV	54.00	-4.59	1.13 V	11	16.85	32.56
5	4924.00	55.58 PK	74.00	-18.42	1.11 V	346	17.12	38.46
6	4924.00	51.53 AV	54.00	-2.47	1.11 V	346	13.07	38.46

- REMARKS:**
1. Emission level (dBuV/m) = Raw Value (dBuV) + Correction Factor (dB/m).
 2. Correction Factor (dB/m) = Antenna Factor (dB/m) + Cable Factor (dB).
 3. The other emission levels were very low against the limit.
 4. Margin value = Emission level – Limit value.
 5. “ * “: Fundamental frequency.

802.11g OFDM MODULATION

EUT TEST CONDITION		MEASUREMENT DETAIL	
CHANNEL	Channel 1	FREQUENCY RANGE	1 ~ 25GHz
INPUT POWER (SYSTEM)	120Vac, 60 Hz	DETECTOR FUNCTION	Peak (PK) Average (AV)
ENVIRONMENTAL CONDITIONS	25deg. C, 66%RH 1016hPa	TESTED BY	Dean Wang

ANTENNA POLARITY & TEST DISTANCE: HORIZONTAL AT 3 M								
NO.	FREQ. (MHz)	EMISSION LEVEL (dBuV/m)	LIMIT (dBuV/m)	MARGIN (dB)	ANTENNA HEIGHT (m)	TABLE ANGLE (Degree)	RAW VALUE (dBuV)	CORRECTION FACTOR (dB/m)
1	2360.00	57.99 PK	74.00	-16.01	1.00 H	58	25.86	32.13
2	2360.00	47.34 AV	54.00	-6.66	1.00 H	58	15.21	32.13
3	2390.00	63.42 PK	74.00	-10.58	1.00 H	58	31.18	32.24
4	2390.00	49.94 AV	54.00	-4.06	1.00 H	58	17.70	32.24
5	*2412.00	106.59 PK			1.00 H	58	74.27	32.32
6	*2412.00	96.47 AV			1.00 H	58	64.15	32.32
7	4824.00	49.22 PK	74.00	-24.78	1.30 H	348	11.09	38.13
8	4824.00	35.96 AV	54.00	-18.04	1.30 H	348	-2.17	38.13
ANTENNA POLARITY & TEST DISTANCE: VERTICAL AT 3 M								
NO.	FREQ. (MHz)	EMISSION LEVEL (dBuV/m)	LIMIT (dBuV/m)	MARGIN (dB)	ANTENNA HEIGHT (m)	TABLE ANGLE (Degree)	RAW VALUE (dBuV)	CORRECTION FACTOR (dB/m)
1	2360.00	59.00 PK	74.00	-15.00	1.18 V	354	26.87	32.13
2	2360.00	49.58 AV	54.00	-4.42	1.18 V	354	17.45	32.13
3	2390.00	66.81 PK	74.00	-7.19	1.18 V	354	34.57	32.24
4	2390.00	52.13 AV	54.00	-1.87	1.18 V	354	19.89	32.24
5	*2412.00	110.22 PK			1.17 V	320	77.90	32.32
6	*2412.00	100.41 AV			1.17 V	320	68.09	32.32
7	4824.00	52.33 PK	74.00	-21.67	1.07 V	24	14.20	38.13
8	4824.00	39.21 AV	54.00	-14.79	1.07 V	24	1.08	38.13

- REMARKS:**
1. Emission level (dBuV/m) = Raw Value (dBuV) + Correction Factor (dB/m).
 2. Correction Factor (dB/m) = Antenna Factor (dB/m) + Cable Factor (dB).
 3. The other emission levels were very low against the limit.
 4. Margin value = Emission level – Limit value.
 5. “ * “: Fundamental frequency.



EUT TEST CONDITION		MEASUREMENT DETAIL	
CHANNEL	Channel 6	FREQUENCY RANGE	1 ~ 25GHz
INPUT POWER (SYSTEM)	120Vac, 60 Hz	DETECTOR FUNCTION	Peak (PK) Average (AV)
ENVIRONMENTAL CONDITIONS	25deg. C, 66%RH 1016hPa	TESTED BY	Dean Wang

ANTENNA POLARITY & TEST DISTANCE: HORIZONTAL AT 3 M								
NO.	FREQ. (MHz)	EMISSION LEVEL (dBuV/m)	LIMIT (dBuV/m)	MARGIN (dB)	ANTENNA HEIGHT (m)	TABLE ANGLE (Degree)	RAW VALUE (dBuV)	CORRECTION FACTOR (dB/m)
1	2360.00	58.37 PK	74.00	-15.63	1.14 H	354	26.24	32.13
2	2360.00	48.49 AV	54.00	-5.51	1.14 H	354	16.36	32.13
3	*2437.00	106.92 PK			1.00 H	56	74.52	32.40
4	*2437.00	96.82 AV			1.00 H	56	64.42	32.40
5	4874.00	50.17 PK	74.00	-23.83	1.00 H	43	11.85	38.32
6	4874.00	37.16 AV	54.00	-16.84	1.00 H	43	-1.16	38.32
ANTENNA POLARITY & TEST DISTANCE: VERTICAL AT 3 M								
NO.	FREQ. (MHz)	EMISSION LEVEL (dBuV/m)	LIMIT (dBuV/m)	MARGIN (dB)	ANTENNA HEIGHT (m)	TABLE ANGLE (Degree)	RAW VALUE (dBuV)	CORRECTION FACTOR (dB/m)
1	2360.00	61.52 PK	74.00	-12.48	1.14 V	354	29.39	32.13
2	2360.00	51.63 AV	54.00	-2.37	1.14 V	354	19.50	32.13
3	*2437.00	110.92 PK			1.14 V	354	78.52	32.40
4	*2437.00	100.74 AV			1.14 V	354	68.34	32.40
5	4874.00	54.74 PK	74.00	-19.26	1.13 V	335	16.42	38.32
6	4874.00	40.91 AV	54.00	-13.09	1.13 V	335	2.59	38.32

- REMARKS:**
1. Emission level (dBuV/m) = Raw Value (dBuV) + Correction Factor (dB/m).
 2. Correction Factor (dB/m) = Antenna Factor (dB/m) + Cable Factor (dB).
 3. The other emission levels were very low against the limit.
 4. Margin value = Emission level – Limit value.
 5. “ * ”: Fundamental frequency.



EUT TEST CONDITION		MEASUREMENT DETAIL	
CHANNEL	Channel 11	FREQUENCY RANGE	1 ~ 25GHz
INPUT POWER (SYSTEM)	120Vac, 60 Hz	DETECTOR FUNCTION	Peak (PK) Average (AV)
ENVIRONMENTAL CONDITIONS	25deg. C, 66%RH 1016hPa	TESTED BY	Dean Wang

ANTENNA POLARITY & TEST DISTANCE: HORIZONTAL AT 3 M								
NO.	FREQ. (MHz)	EMISSION LEVEL (dBuV/m)	LIMIT (dBuV/m)	MARGIN (dB)	ANTENNA HEIGHT (m)	TABLE ANGLE (Degree)	RAW VALUE (dBuV)	CORRECTION FACTOR (dB/m)
1	*2462.00	107.39 PK			1.13 H	37	74.91	32.48
2	*2462.00	97.10 AV			1.13 H	37	64.62	32.48
3	2483.50	70.84 PK	74.00	-3.16	1.13 H	37	38.28	32.56
4	2483.50	50.79 AV	54.00	-3.21	1.13 H	37	18.23	32.56
5	#2520.00	61.28 PK	87.39	-26.11	1.13 H	37	28.60	32.68
6	#2520.00	50.99 AV	77.10	-26.11	1.13 H	37	18.31	32.68
7	4924.00	50.69 PK	74.00	-23.31	1.12 H	36	12.23	38.46
8	4924.00	37.81 AV	54.00	-16.19	1.12 H	36	-0.65	38.46
ANTENNA POLARITY & TEST DISTANCE: VERTICAL AT 3 M								
NO.	FREQ. (MHz)	EMISSION LEVEL (dBuV/m)	LIMIT (dBuV/m)	MARGIN (dB)	ANTENNA HEIGHT (m)	TABLE ANGLE (Degree)	RAW VALUE (dBuV)	CORRECTION FACTOR (dB/m)
1	*2462.00	110.91 PK			1.12 V	24	78.43	32.48
2	*2462.00	101.20 AV			1.12 V	24	68.72	32.48
3	2483.50	71.75 PK	74.00	-2.25	1.00 V	44	39.19	32.56
4	2483.50	52.54 AV	54.00	-1.46	1.00 V	44	19.98	32.56
5	#2520.00	62.31 PK	90.91	-28.60	1.12 V	24	29.63	32.68
6	#2520.00	53.21 AV	81.20	-27.99	1.12 V	24	20.53	32.68
7	4924.00	53.56 PK	74.00	-20.44	1.35 V	343	15.10	38.46
8	4924.00	39.77 AV	54.00	-14.23	1.35 V	343	1.31	38.46

- REMARKS:**
1. Emission level (dBuV/m) = Raw Value (dBuV) + Correction Factor (dB/m).
 2. Correction Factor (dB/m) = Antenna Factor (dB/m) + Cable Factor (dB).
 3. The other emission levels were very low against the limit.
 4. Margin value = Emission level – Limit value.
 5. “ * “: Fundamental frequency.
 6. “#”The radiated frequency falling in the nonrestrictive band.

BELOW 1GHz WORST-CASE DATA : 802.11b DSSS MODULATION

EUT TEST CONDITION		MEASUREMENT DETAIL	
CHANNEL	Channel 6	FREQUENCY RANGE	Below 1000MHz
INPUT POWER (SYSTEM)	120Vac, 60 Hz	DETECTOR FUNCTION	Quasi-Peak
ENVIRONMENTAL CONDITIONS	24deg. C, 64%RH 1016hPa	TESTED BY	Match Tsui

ANTENNA POLARITY & TEST DISTANCE: HORIZONTAL AT 3 M

NO.	FREQ. (MHz)	EMISSION LEVEL (dBuV/m)	LIMIT (dBuV/m)	MARGIN (dB)	ANTENNA HEIGHT (m)	TABLE ANGLE (Degree)	RAW VALUE (dBuV)	CORRECTION FACTOR (dB/m)
1	488.75	40.92 QP	46.00	-5.08	1.50 H	70	22.51	18.41
2	496.53	40.82 QP	46.00	-5.18	1.50 H	61	22.18	18.65
3	760.95	39.10 QP	46.00	-6.90	1.00 H	112	15.65	23.45
4	792.06	41.31 QP	46.00	-4.69	1.50 H	64	17.13	24.18
5	840.67	42.69 QP	46.00	-3.31	1.50 H	76	17.94	24.76
6	881.50	40.32 QP	46.00	-5.68	1.50 H	139	15.18	25.14
7	920.38	39.70 QP	46.00	-6.30	1.50 H	130	14.22	25.48

ANTENNA POLARITY & TEST DISTANCE: VERTICAL AT 3 M

NO.	FREQ. (MHz)	EMISSION LEVEL (dBuV/m)	LIMIT (dBuV/m)	MARGIN (dB)	ANTENNA HEIGHT (m)	TABLE ANGLE (Degree)	RAW VALUE (dBuV)	CORRECTION FACTOR (dB/m)
1	436.26	41.07 QP	46.00	-4.93	1.00 V	34	24.27	16.80
2	482.92	42.26 QP	46.00	-3.74	1.50 V	151	24.04	18.23
3	496.53	39.06 QP	46.00	-6.94	2.00 V	31	20.41	18.65
4	560.69	37.79 QP	46.00	-8.21	1.00 V	13	17.62	20.18
5	840.67	41.63 QP	46.00	-4.37	1.00 V	199	16.88	24.76
6	869.83	40.80 QP	46.00	-5.20	1.50 V	349	15.77	25.03
7	881.50	38.86 QP	46.00	-7.14	1.50 V	190	13.72	25.14
8	920.38	38.56 QP	46.00	-7.44	1.50 V	202	13.08	25.48

- REMARKS:**
1. Emission level (dBuV/m) = Raw Value (dBuV) + Correction Factor (dB/m).
 2. Correction Factor (dB/m) = Antenna Factor (dB/m) + Cable Factor (dB).
 3. The other emission levels were very low against the limit.
 4. Margin value = Emission level – Limit value.

4.2 CONDUCTED EMISSION MEASUREMENT

4.2.1 LIMITS OF CONDUCTED EMISSION MEASUREMENT

FREQUENCY OF EMISSION (MHz)	CONDUCTED LIMIT (dB μ V)	
	Quasi-peak	Average
0.15 ~ 0.5	66 to 56	56 to 46
0.5 ~ 5	56	46
5 ~ 30	60	50

- NOTE:**
1. The lower limit shall apply at the transition frequencies.
 2. The limit decreases in line with the logarithm of the frequency in the range of 0.15 to 0.50 MHz.
 3. All emanations from a class A/B digital device or system, including any network of conductors and apparatus connected thereto, shall not exceed the level of field strengths specified above.

4.2.2 TEST INSTRUMENTS

DESCRIPTION & MANUFACTURER	MODEL NO.	SERIAL NO.	CALIBRATED UNTIL
Test Receiver ROHDE & SCHWARZ	ESCS30	100289	Dec. 06, 2008
RF signal cable Woken	5D-FB	Cable-HYC01-01	Jan. 06, 2008
LISN ROHDE & SCHWARZ	ESH3-Z5	100312	Feb. 13, 2008
LISN ROHDE & SCHWARZ	NNBL 8226-2	8226-142	May 07, 2008
Software ADT	ADT_Cond_V3	NA	NA

- NOTE:**
1. The calibration interval of the above test instruments is 12 months and the calibrations are traceable to NML/ROC and NIST/USA.
 2. The test was performed in HwaYa Shielded Room 1.
 3. The VCCI Site Registration No. is C-2040.

4.2.3 TEST PROCEDURES

- a. The EUT was placed 0.4 meters from the conducting wall of the shielded room with EUT being connected to the power mains through a line impedance stabilization network (LISN). Other support units were connected to the power mains through another LISN. The two LISNs provide 50 ohm/ 50uH of coupling impedance for the measuring instrument.
- b. Both lines of the power mains connected to the EUT were checked for maximum conducted interference.
- c. The frequency range from 150kHz to 30MHz was searched. Emission levels under (Limit - 20dB) was not recorded.

NOTE: All modes of operation were investigated and the worst-case emissions are reported.

4.2.4 DEVIATION FROM TEST STANDARD

No deviation.

4.2.5 TEST SETUP

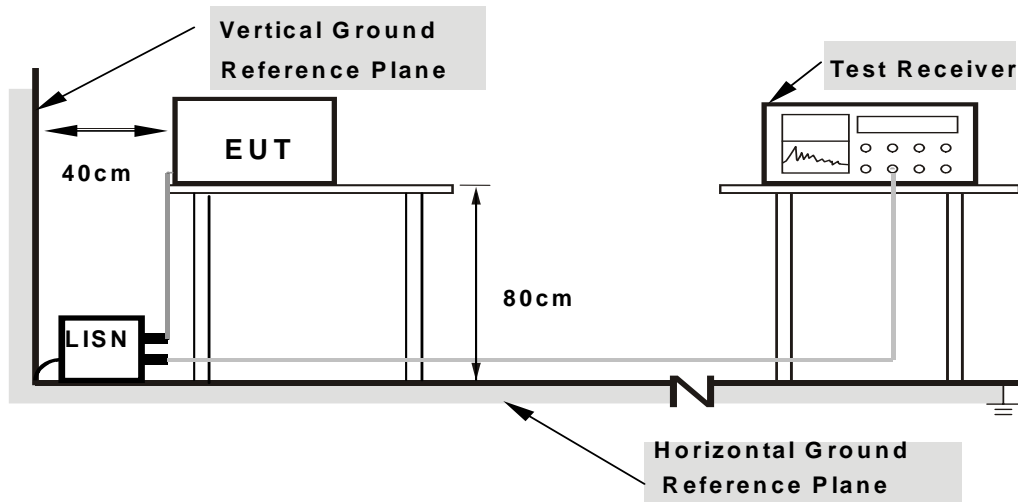

Note: 1.Support units were connected to second LISN.

**2.Both of LISNs (AMN) are 80 cm from EUT and at least 80
from other units and other metal planes**

For the actual test configuration, please refer to the attached file (Test Setup Photo).

4.2.6 EUT OPERATING CONDITIONS

Same as 4.1.6.

4.2.7 TEST RESULTS

CONDUCTED WORST-CASE DATA

EUT TEST CONDITION		MEASUREMENT DETAIL	
CHANNEL	Channel 6	PHASE	Line 1
MODULATION TYPE	DBPSK	6dB BANDWIDTH	9 kHz
TRANSFER RATE	1Mbps	ENVIRONMENTAL CONDITIONS	20deg. C, 60%RH, 1016hPa
TESTED BY	Match Tsui	INPUT POWER (SYSTEM)	120Vac, 60 Hz

No	Freq. [MHz]	Corr.	Reading Value		Emission Level		Limit		Margin	
		Factor	[dB (uV)]		[dB (uV)]		[dB (uV)]		(dB)	
		(dB)	Q.P.	AV.	Q.P.	AV.	Q.P.	AV.	Q.P.	AV.
1	0.197	0.21	46.22	-	46.43	-	63.74	53.74	-17.31	-
2	0.263	0.21	39.15	-	39.36	-	61.33	51.33	-21.97	-
3	0.459	0.21	37.74	-	37.95	-	56.72	46.72	-18.77	-
4	0.982	0.24	36.98	-	37.22	-	56.00	46.00	-18.78	-
5	2.875	0.32	34.28	-	34.60	-	56.00	46.00	-21.40	-
6	23.156	1.30	43.54	-	44.84	-	60.00	50.00	-15.16	-

- REMARKS:**
1. Q.P. and AV. are abbreviations of quasi-peak and average individually.
 2. "-": The Quasi-peak reading value also meets average limit and measurement with the average detector is unnecessary.
 3. The emission levels of other frequencies were very low against the limit.
 4. Margin value = Emission level - Limit value
 5. Correction factor = Insertion loss + Cable loss
 6. Emission Level = Correction Factor + Reading Value.

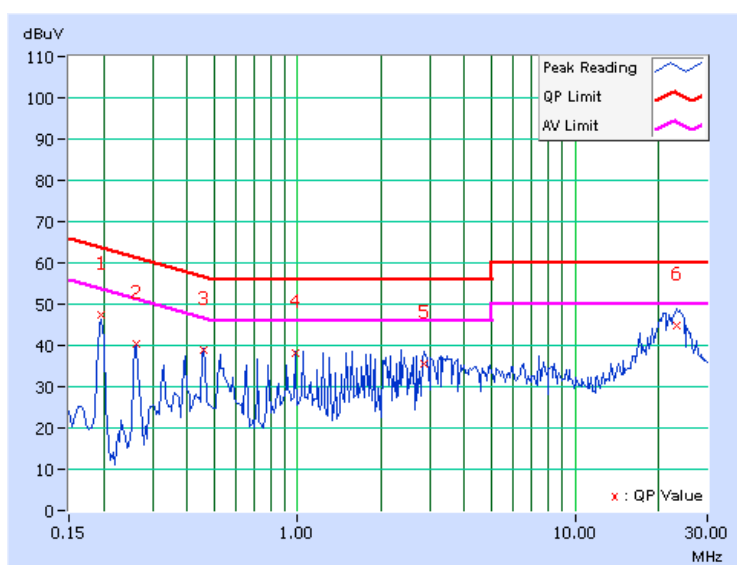

EUT TEST CONDITION		MEASUREMENT DETAIL	
CHANNEL	Channel 6	PHASE	Line 2
MODULATION TYPE	DBPSK	6dB BANDWIDTH	9 kHz
TRANSFER RATE	1Mbps	ENVIRONMENTAL CONDITIONS	20deg. C, 60%RH, 1016hPa
TESTED BY	Match Tsui	INPUT POWER (SYSTEM)	120Vac, 60 Hz

No	Freq. [MHz]	Corr.	Reading Value		Emission Level		Limit		Margin	
		Factor	[dB (uV)]		[dB (uV)]		[dB (uV)]		(dB)	
		(dB)	Q.P.	AV.	Q.P.	AV.	Q.P.	AV.	Q.P.	AV.
1	0.197	0.21	43.52	-	43.73	-	63.74	53.74	-20.01	-
2	0.392	0.21	41.54	-	41.75	-	58.02	48.02	-16.27	-
3	0.654	0.22	41.79	-	42.01	-	56.00	46.00	-13.99	-
4	0.982	0.24	39.70	-	39.94	-	56.00	46.00	-16.06	-
5	3.270	0.34	33.61	-	33.95	-	56.00	46.00	-22.05	-
6	23.763	0.55	42.79	-	43.34	-	60.00	50.00	-16.66	-

- REMARKS:**
1. Q.P. and AV. are abbreviations of quasi-peak and average individually.
 2. "-": The Quasi-peak reading value also meets average limit and measurement with the average detector is unnecessary.
 3. The emission levels of other frequencies were very low against the limit.
 4. Margin value = Emission level - Limit value
 5. Correction factor = Insertion loss + Cable loss
 6. Emission Level = Correction Factor + Reading Value.

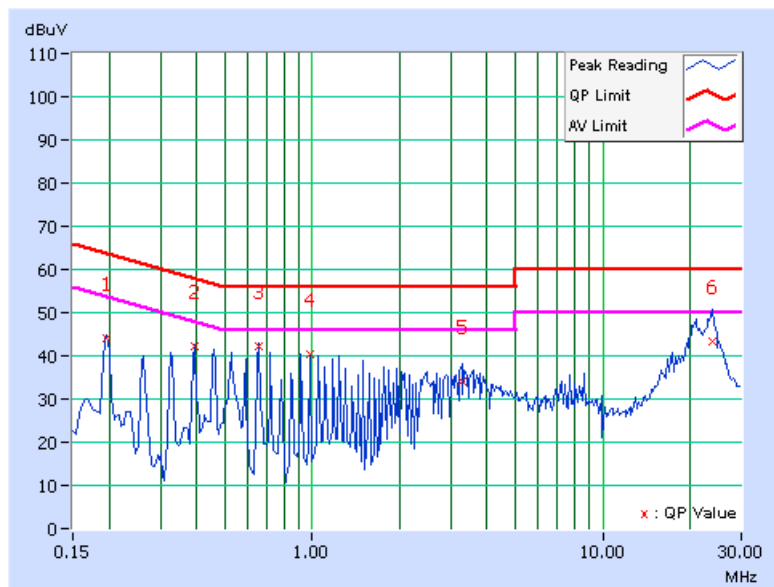



4.3 6dB BANDWIDTH MEASUREMENT

4.3.1 LIMITS OF 6dB BANDWIDTH MEASUREMENT

The minimum of 6dB Bandwidth Measurement is 0.5 MHz.

4.3.2 TEST INSTRUMENTS

DESCRIPTION & MANUFACTURER	MODEL NO.	SERIAL NO.	CALIBRATED UNTIL
SPECTRUM ANALYZER	FSP 40	100040	Jun. 28, 2008

NOTE: The calibration interval of the above test instruments is 12 months and the calibrations are traceable to NML/ROC and NIST/USA.

4.3.3 TEST PROCEDURE

The transmitter output was connected to the spectrum analyzer through an attenuator. The bandwidth of the fundamental frequency was measured by spectrum analyzer with 100 kHz RBW and 300kHz VBW. The 6dB bandwidth is defined as the total spectrum the power of which is higher than peak power minus 6dB.

4.3.4 DEVIATION FROM TEST STANDARD

No deviation.

4.3.5 TEST SETUP

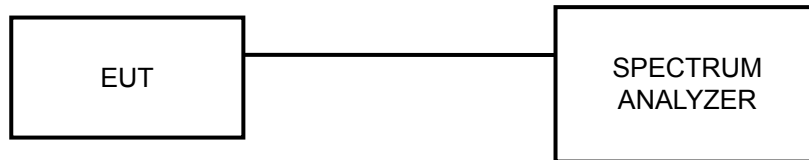

For the actual test configuration, please refer to the related Item – Photographs of the Test Configuration.

4.3.6 EUT OPERATING CONDITIONS

The software provided by client to enable the EUT under transmission condition continuously at lowest, middle and highest channel frequencies individually.



4.3.7 TEST RESULTS

802.11b DSSS MODULATION

MODULATION TYPE	DBPSK	TRANSFER RATE	1Mbps
INPUT POWER (SYSTEM)	120Vac, 60 Hz	ENVIRONMENTAL CONDITIONS	25deg. C, 65%RH, 1016hPa
TESTED BY	Long Chen		

CHANNEL	CHANNEL FREQUENCY (MHz)	6dB BANDWIDTH (MHz)	MINIMUM LIMIT (MHz)	PASS/FAIL
1	2412	10.08	0.5	PASS
6	2437	10.11	0.5	PASS
11	2462	10.07	0.5	PASS

CH1

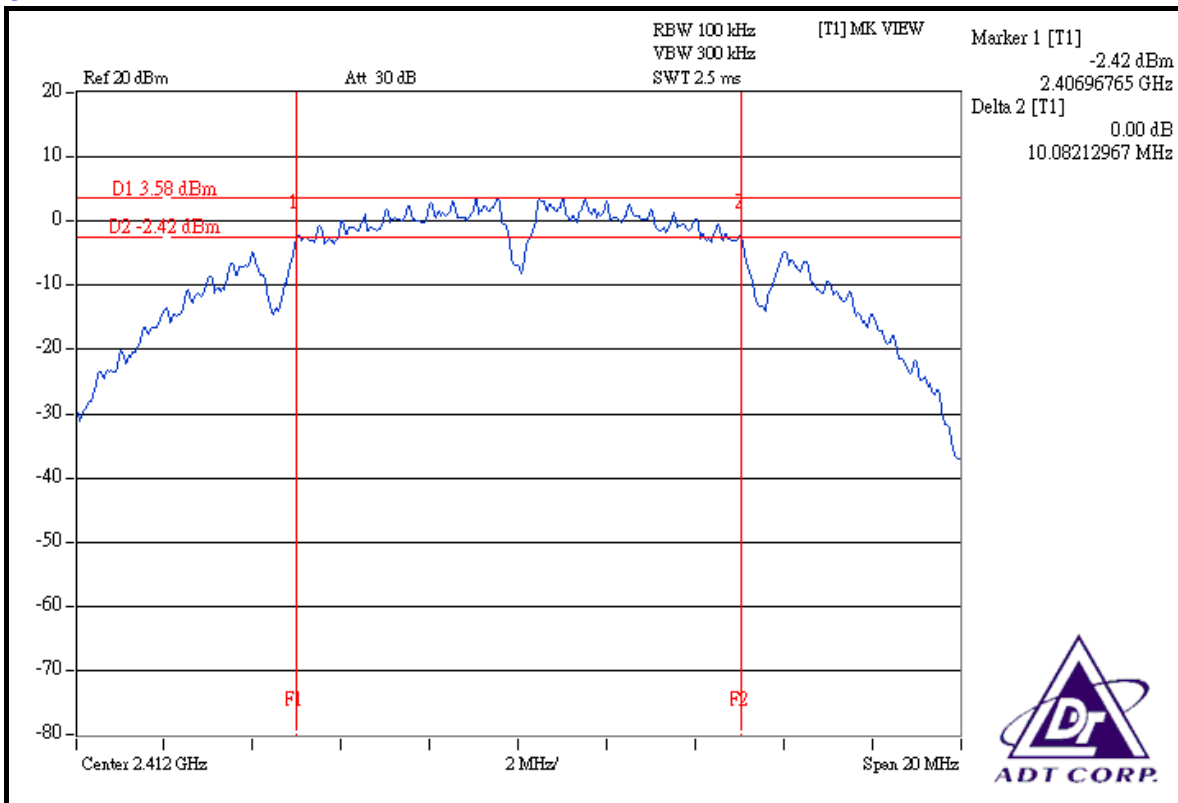



CH6

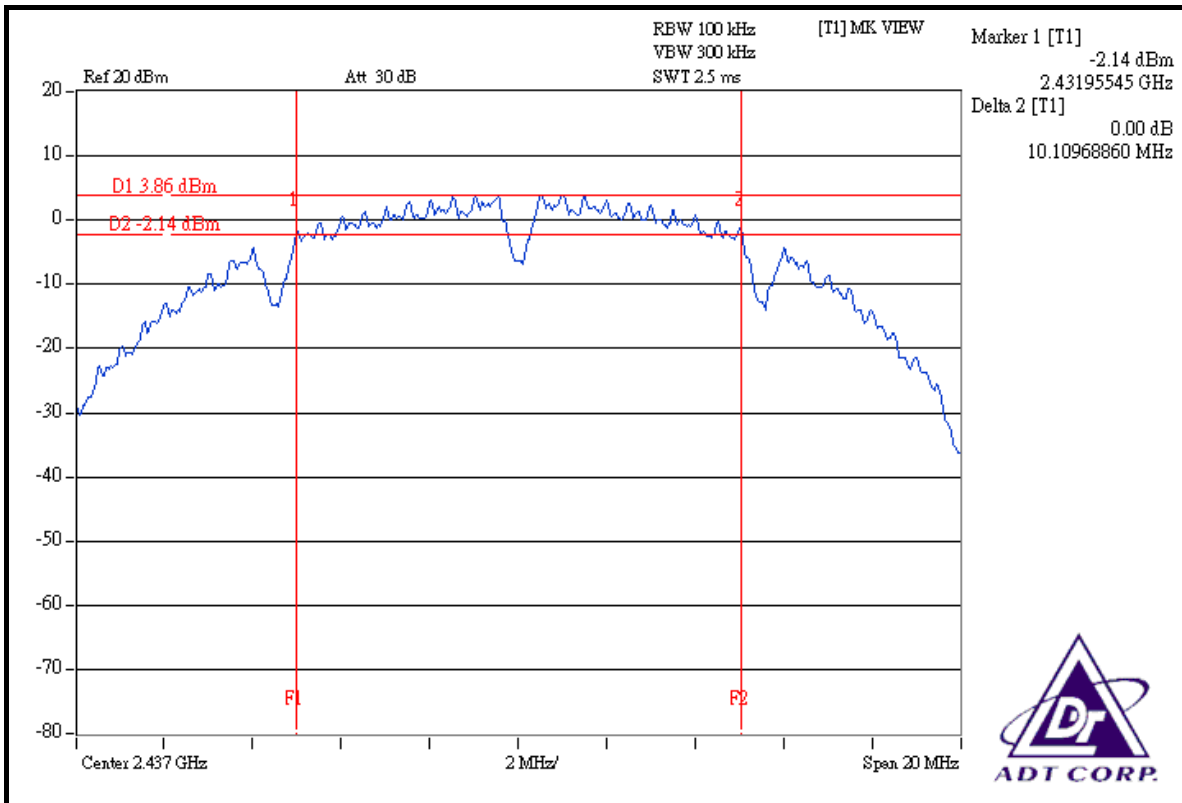

CH11

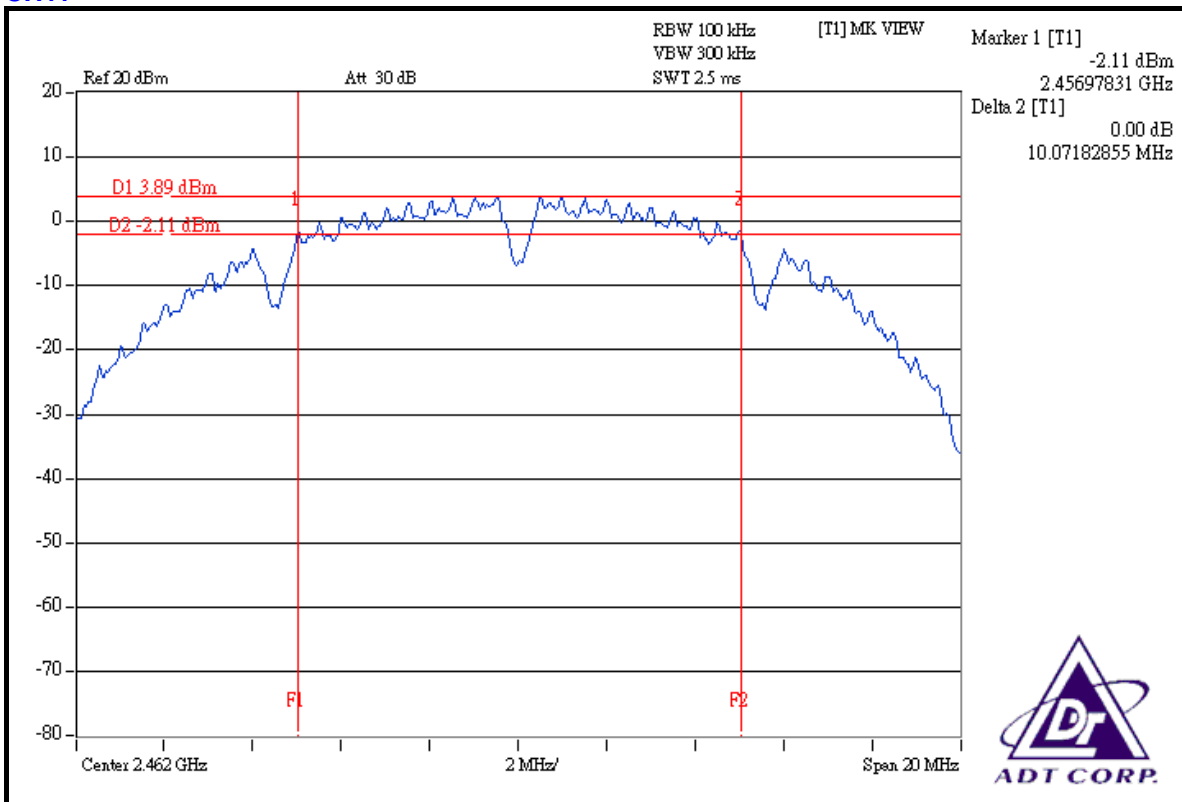



802.11g OFDM MODULATION

MODULATION TYPE	BPSK	TRANSFER RATE	6Mbps
INPUT POWER (SYSTEM)	120Vac, 60 Hz	ENVIRONMENTAL CONDITIONS	25deg. C, 65%RH, 1016hPa
TESTED BY	Long Chen		

CHANNEL	CHANNEL FREQUENCY (MHz)	6dB BANDWIDTH (MHz)	MINIMUM LIMIT (MHz)	PASS/FAIL
1	2412	15.82	0.5	PASS
6	2437	15.85	0.5	PASS
11	2462	15.87	0.5	PASS

CH1

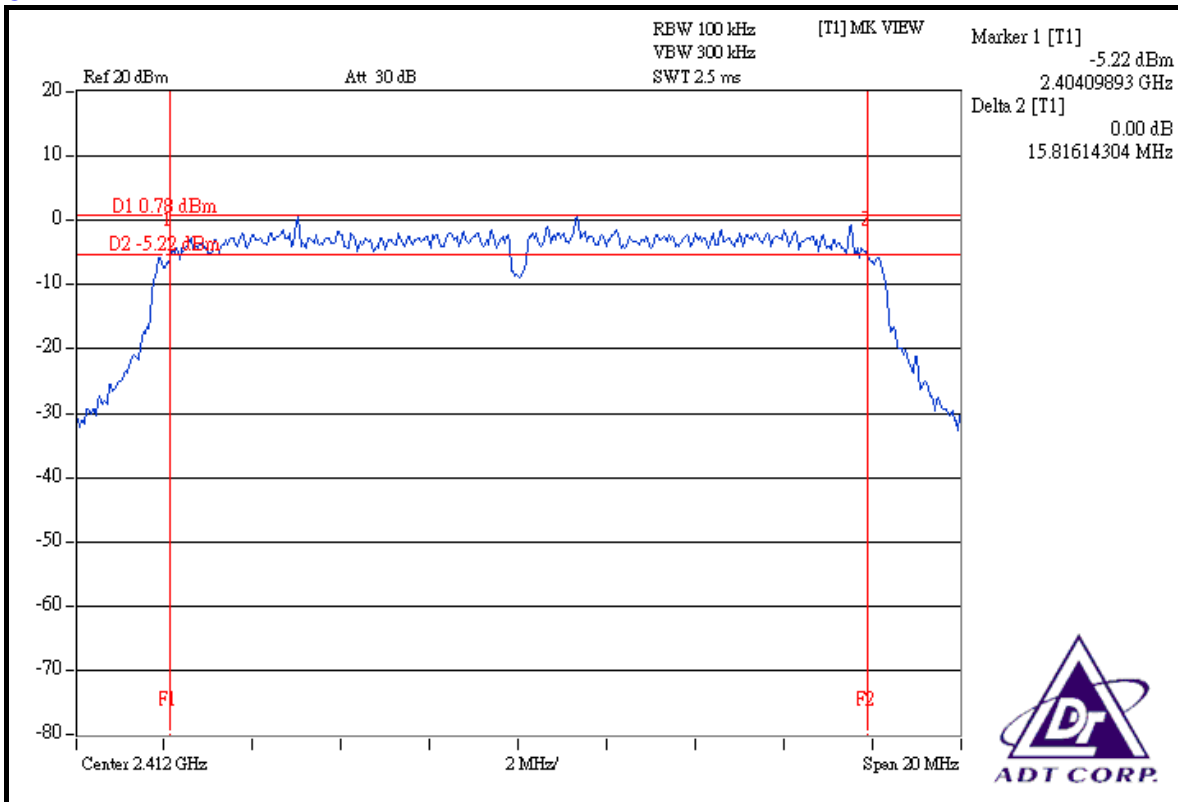



CH6

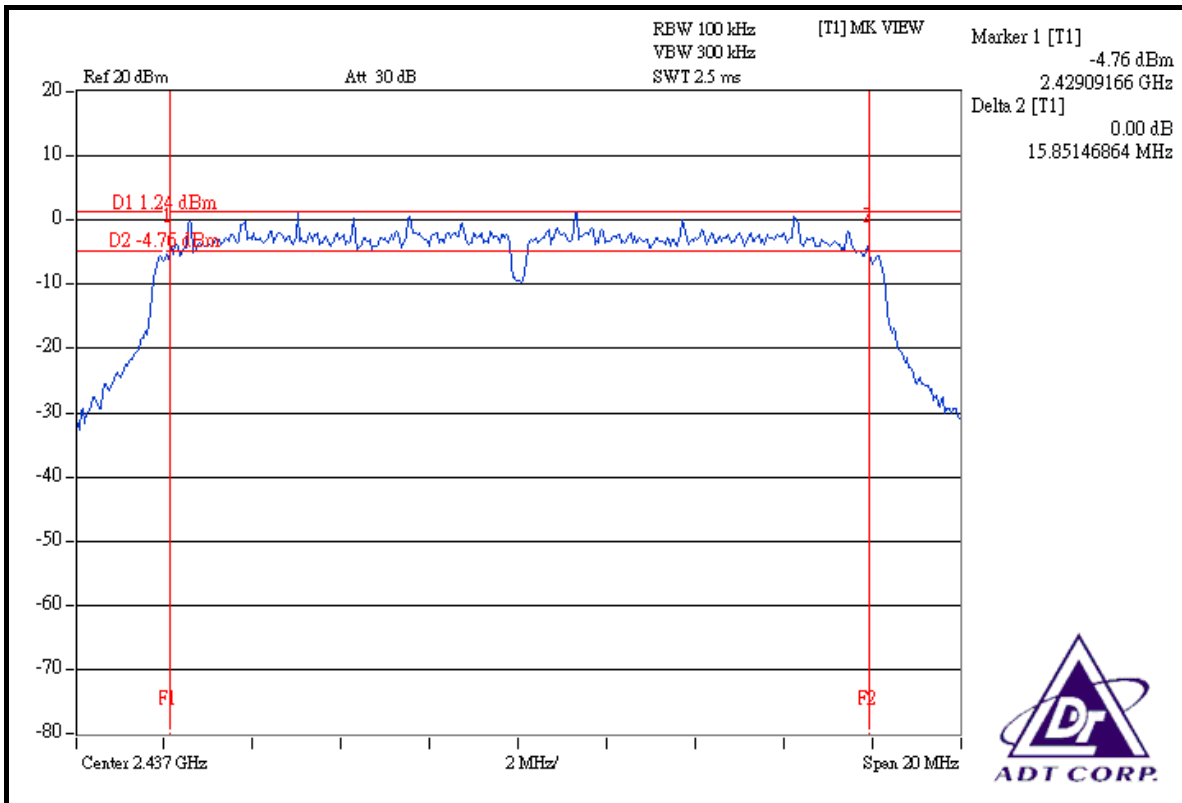

CH11

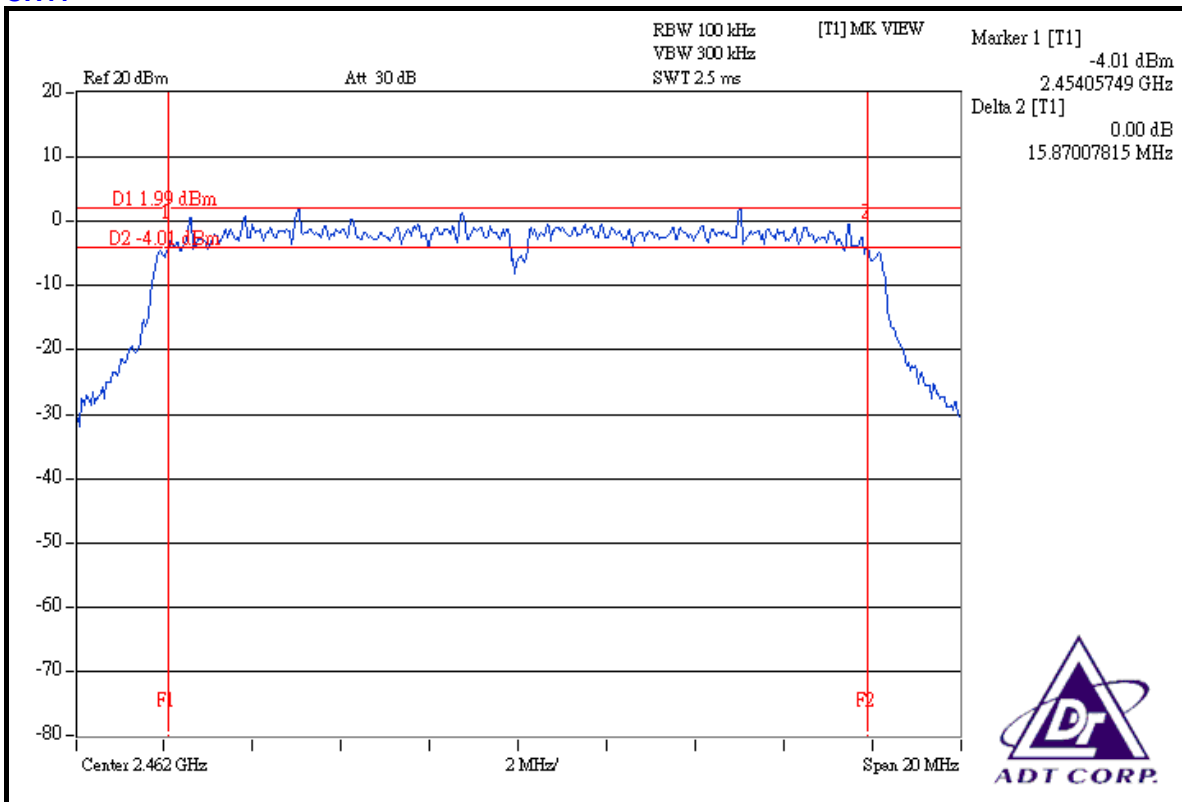



4.4 MAXIMUM PEAK OUTPUT POWER

4.4.1 LIMITS OF MAXIMUM PEAK OUTPUT POWER MEASUREMENT

The Maximum Peak Output Power Measurement is 30dBm.

4.4.2 TEST INSTRUMENTS

DESCRIPTION & MANUFACTURER	MODEL NO.	SERIAL NO.	CALIBRATED UNTIL
R&S SPECTRUM ANALYZER	FSP40	100040	Jun. 28, 2008
AGILENT SIGNAL GENERATOR	E8257C	MY43320668	Dec. 25, 2008
TEKTRONIX OSCILLOSCOPE	TDS1012	C037299	Nov. 21, 2008
NARDA DETECTOR	4503A	FSCM99899	NA

NOTE: The calibration interval of the above test instruments is 12 months and the calibrations are traceable to NML/ROC and NIST/USA.

4.4.3 TEST PROCEDURES

- a. A detector was used on the output port of the EUT. An oscilloscope was used to peak the response of the detector.
- b. Replaced the EUT by the signal generator. The center frequency of the S.G was adjusted to the center frequency of the measured channel.
- c. Adjusted the power to have the same peak reading on oscilloscope. Record the power level.

4.4.4 DEVIATION FROM TEST STANDARD

No deviation.

4.4.5 TEST SETUP

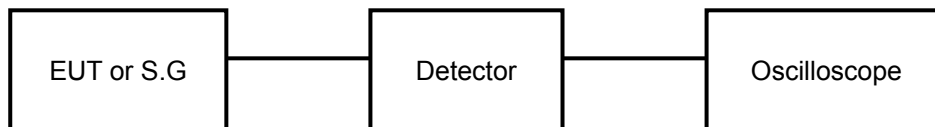

4.4.6 EUT OPERATING CONDITIONS

Same as 4.3.6.



4.4.7 TEST RESULTS

802.11b DSSS MODULATION

MODULATION TYPE	DBPSK	TRANSFER RATE	1Mbps
INPUT POWER (SYSTEM)	120Vac, 60 Hz	ENVIRONMENTAL CONDITIONS	25deg. C, 65%RH, 1016hPa
TESTED BY	Long Chen		

CHANNEL	CHANNEL FREQUENCY (MHz)	PEAK POWER OUTPUT (mW)	PEAK POWER OUTPUT (dBm)	PEAK POWER LIMIT (dBm)	PASS/FAIL
1	2412	31.769	15.02	30	PASS
6	2437	36.224	15.59	30	PASS
11	2462	35.975	15.56	30	PASS

802.11g OFDM MODULATION

MODULATION TYPE	BPSK	TRANSFER RATE	6Mbps
INPUT POWER (SYSTEM)	120Vac, 60 Hz	ENVIRONMENTAL CONDITIONS	25deg. C, 65%RH, 1016hPa
TESTED BY	Long Chen		

CHANNEL	CHANNEL FREQUENCY (MHz)	PEAK POWER OUTPUT (mW)	PEAK POWER OUTPUT (dBm)	PEAK POWER LIMIT (dBm)	PASS/FAIL
1	2412	35.727	15.53	30	PASS
6	2437	40.551	16.08	30	PASS
11	2462	45.186	16.55	30	PASS

4.5 POWER SPECTRAL DENSITY MEASUREMENT

4.5.1 LIMITS OF POWER SPECTRAL DENSITY MEASUREMENT

The Maximum of Power Spectral Density Measurement is 8dBm.

4.5.2 TEST INSTRUMENTS

DESCRIPTION & MANUFACTURER	MODEL NO.	SERIAL NO.	CALIBRATED UNTIL
R&S SPECTRUM ANALYZER	FSP 40	100040	Jun. 28, 2008

NOTE: The calibration interval of the above test instruments is 12 months and the calibrations are traceable to NML/ROC and NIST/USA.

4.5.3 TEST PROCEDURE

The transmitter output was connected to the spectrum analyzer through an attenuator, the bandwidth of the fundamental frequency was measured with the spectrum analyzer using 3kHz RBW and 30kHz VBW, set sweep time = span/3kHz. The power spectral density was measured and recorded.

The sweep time is allowed to be longer than span/3kHz for a full response of the mixer in the spectrum analyzer.

4.5.4 DEVIATION FROM TEST STANDARD

No deviation.

4.5.5 TEST SETUP

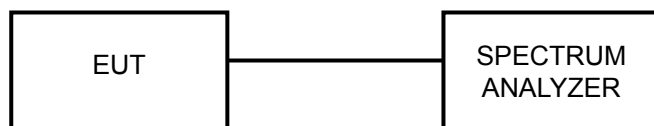

4.5.6 EUT OPERATING CONDITIONS

Same as 4.3.6.



4.5.7 TEST RESULTS

802.11b DSSS MODULATION

MODULATION TYPE	DBPSK	TRANSFER RATE	1Mbps
INPUT POWER (SYSTEM)	120Vac, 60 Hz	ENVIRONMENTAL CONDITIONS	25deg. C, 65%RH, 1016hPa
TESTED BY	Long Chen		

CHANNEL	CHANNEL FREQUENCY (MHz)	RF POWER LEVEL IN 3 kHz BW (dBm)	MAXIMUM LIMIT (dBm)	PASS/FAIL
1	2412	-16.20	8	PASS
6	2437	-15.48	8	PASS
11	2462	-15.95	8	PASS

CH1

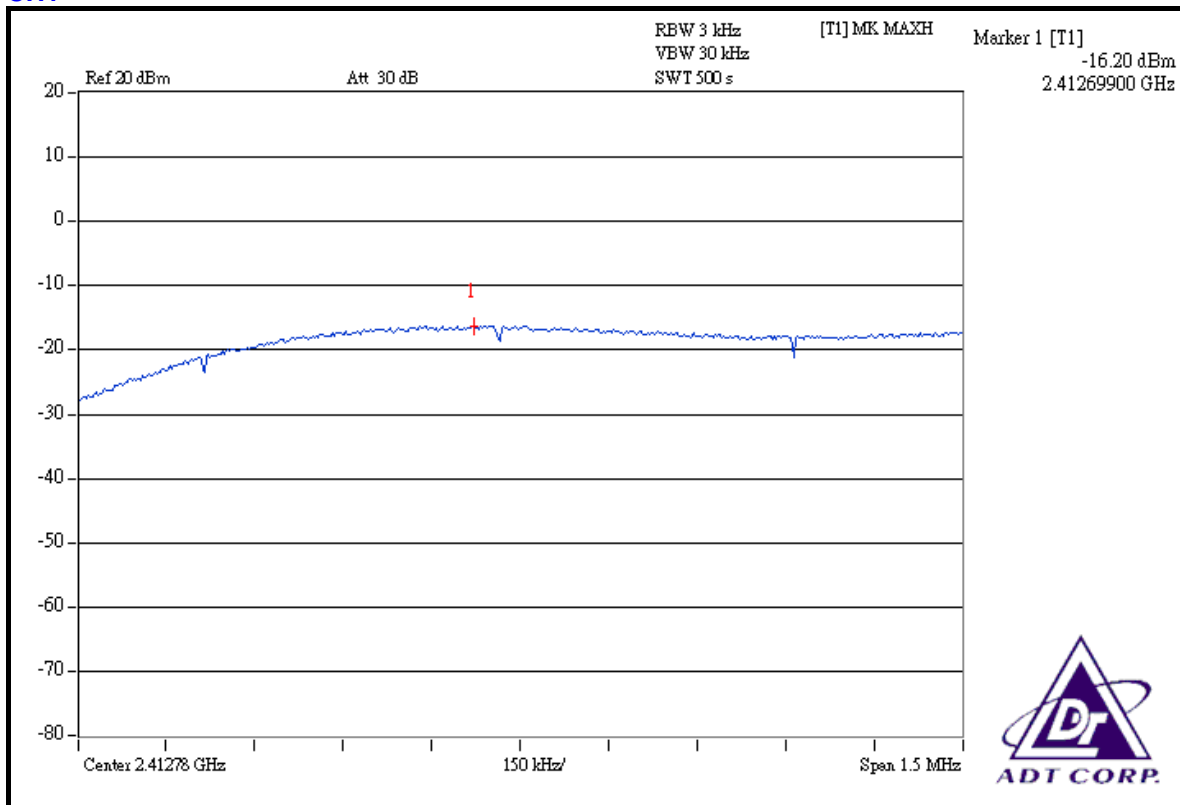



CH6

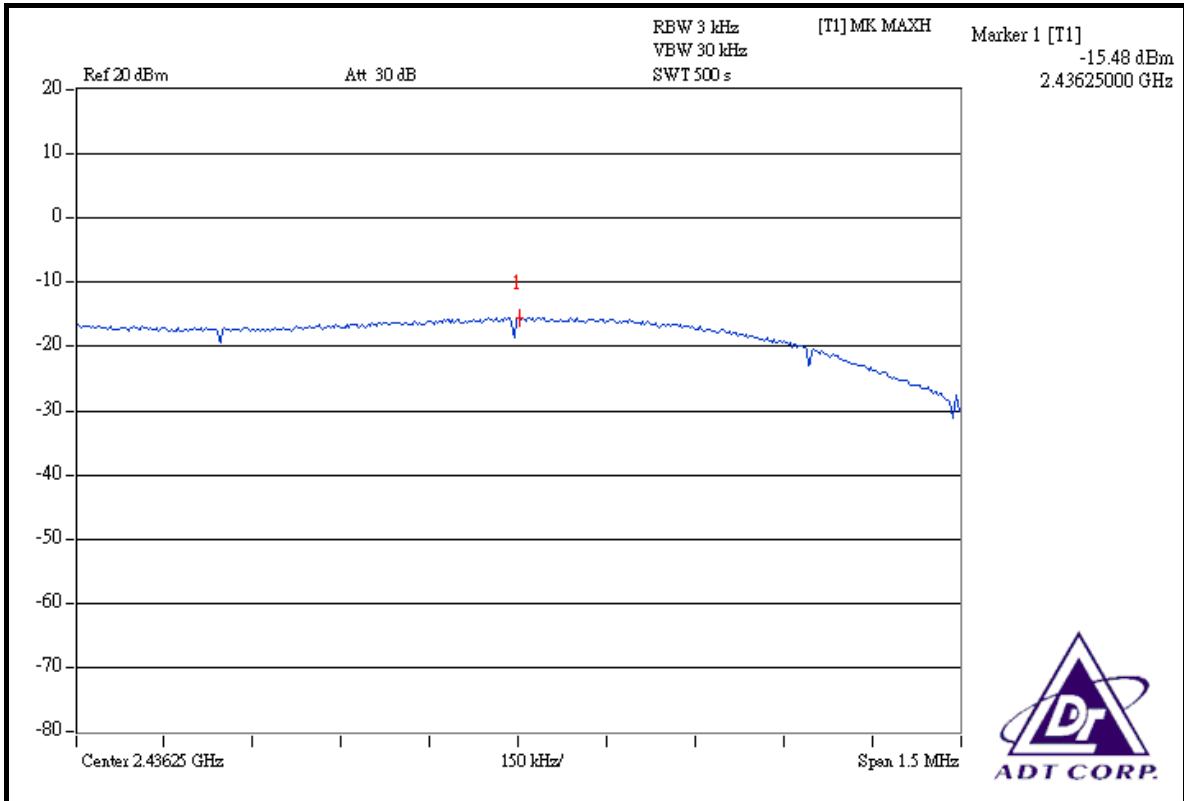

CH11

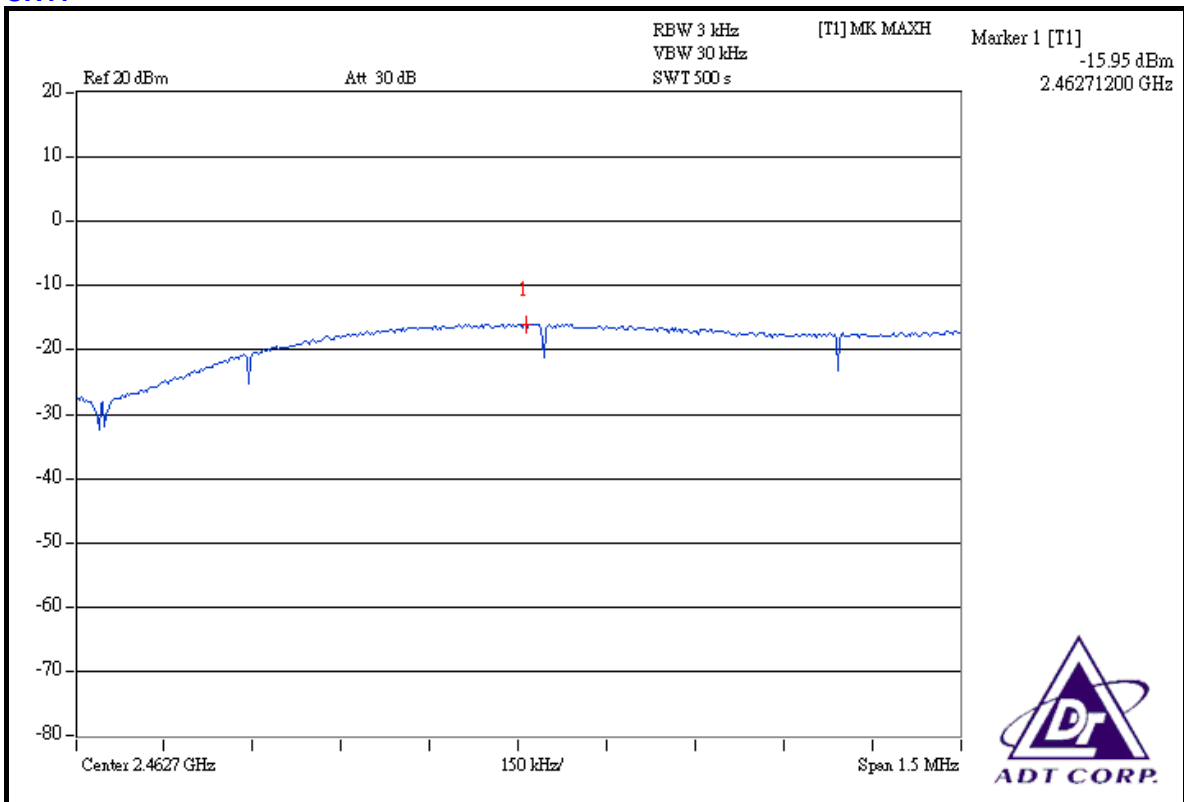



802.11g OFDM MODULATION

MODULATION TYPE	BPSK	TRANSFER RATE	6Mbps
INPUT POWER (SYSTEM)	120Vac, 60 Hz	ENVIRONMENTAL CONDITIONS	25deg. C, 65%RH, 1016hPa
TESTED BY	Long Chen		

CHANNEL	CHANNEL FREQUENCY (MHz)	RF POWER LEVEL IN 3 kHz BW (dBm)	MAXIMUM LIMIT (dBm)	PASS/FAIL
1	2412	-13.78	8	PASS
6	2437	-13.12	8	PASS
11	2462	-12.63	8	PASS

CH1

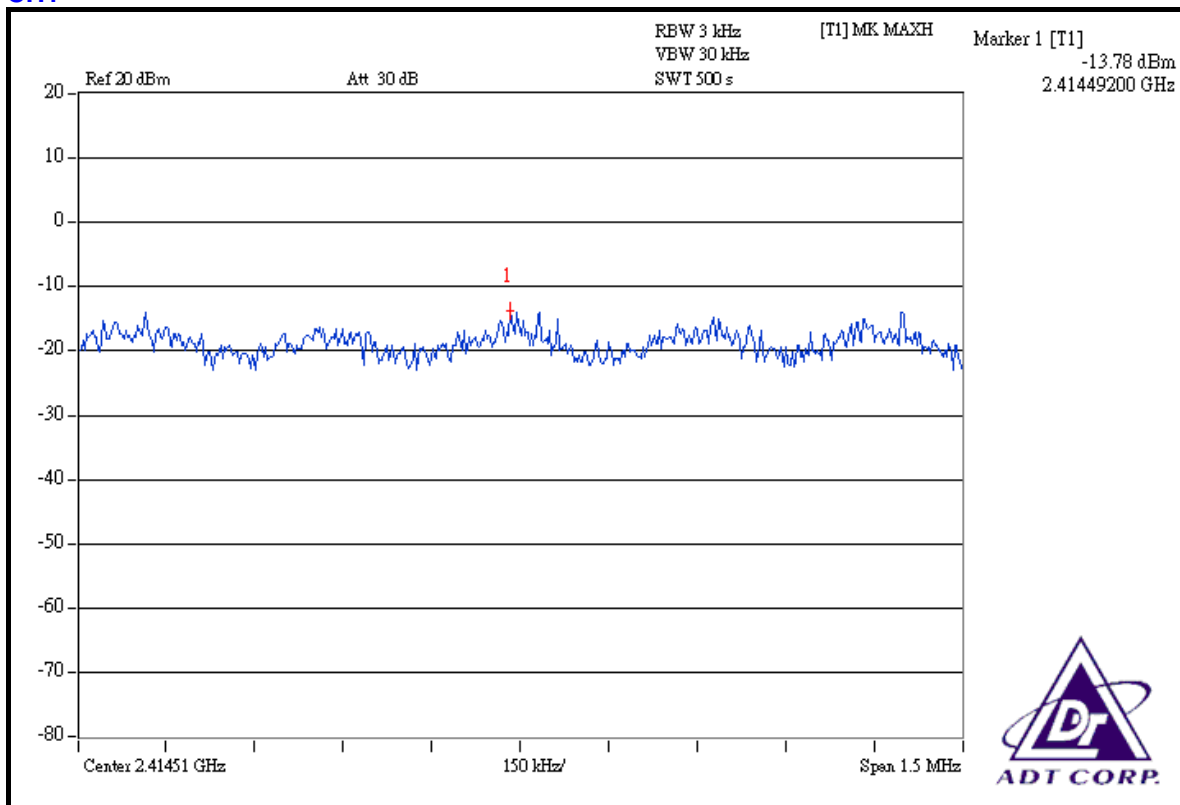



CH6

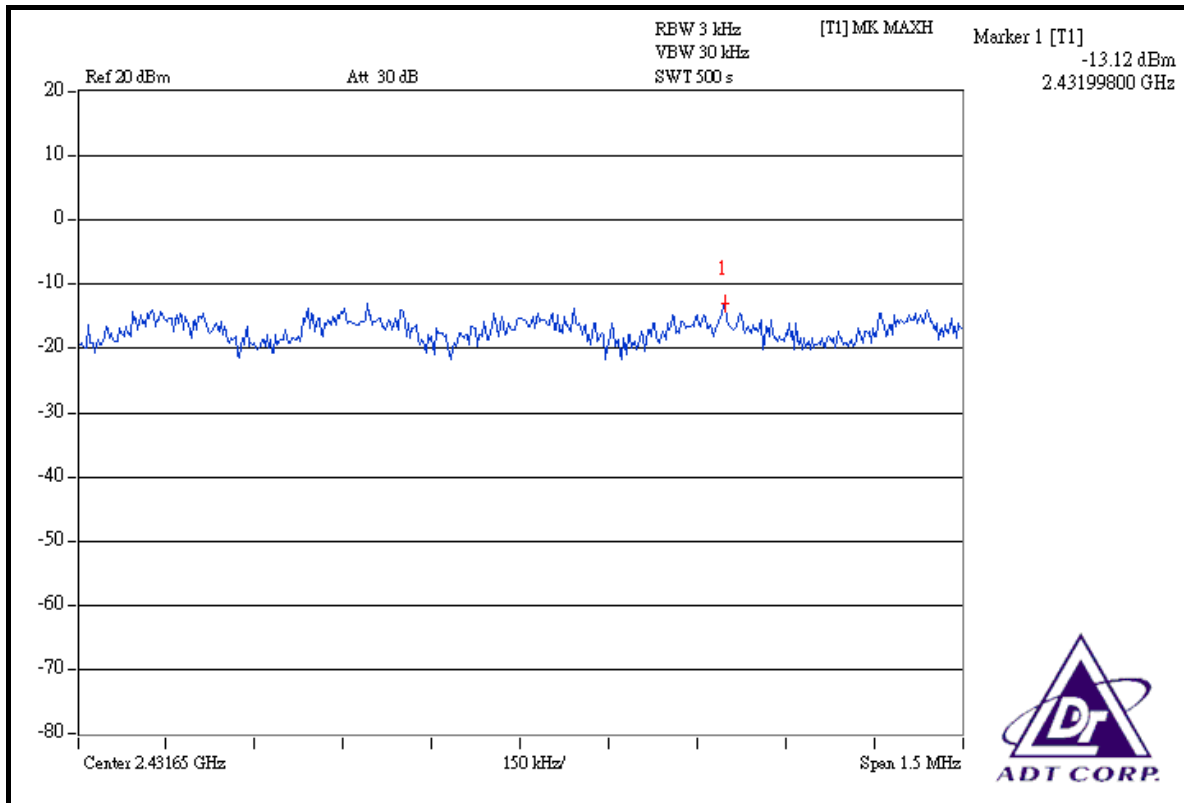

CH11

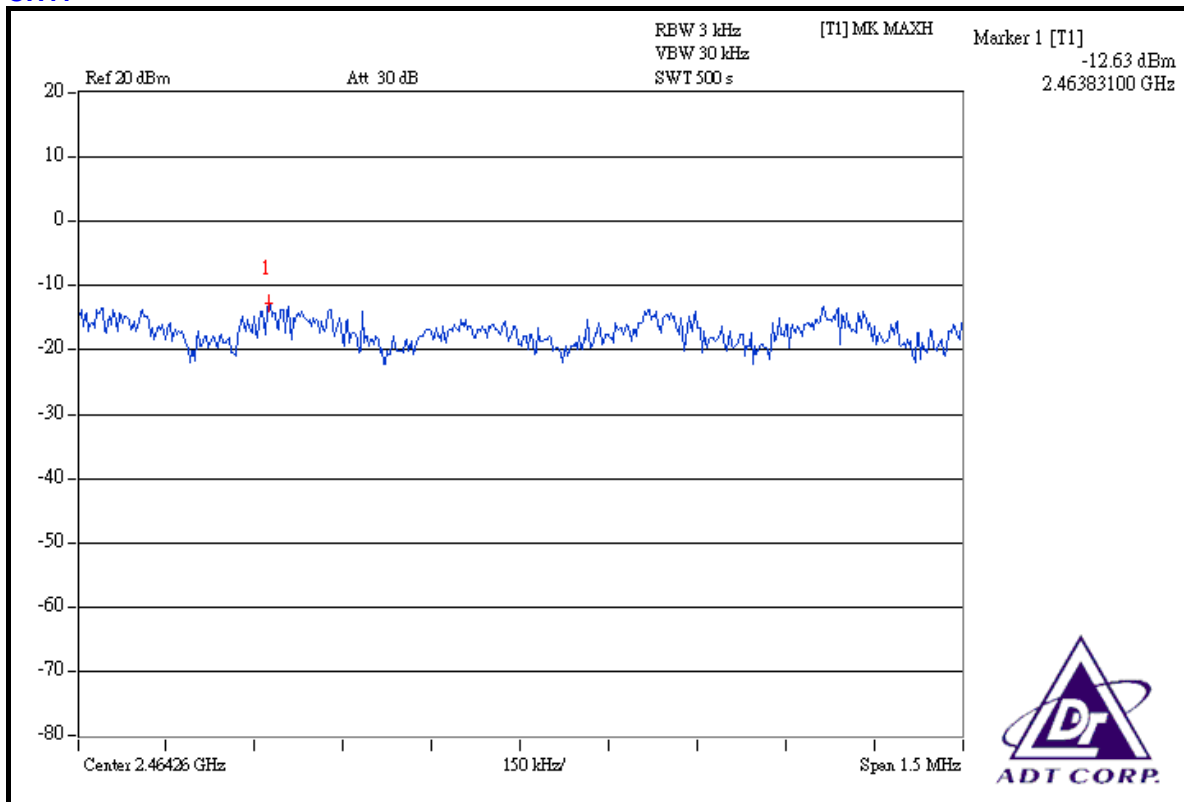



4.6 BAND EDGES MEASUREMENT

4.6.1 LIMITS OF BAND EDGES MEASUREMENT

Below -20dB of the highest emission level of operating band (in 100kHz Resolution Bandwidth).

4.6.2 TEST INSTRUMENTS

DESCRIPTION & MANUFACTURER	MODEL NO.	SERIAL NO.	CALIBRATED UNTIL
R&S SPECTRUM ANALYZER	FSP 40	100040	Jun. 28, 2008

NOTE: The calibration interval of the above test instruments is 12 months and the calibrations are traceable to NML/ROC and NIST/USA.

4.6.3 TEST PROCEDURE

The transmitter output was connected to the spectrum analyzer via a low loss cable. Set both RBW and VBW of spectrum analyzer to 100kHz and 300kHz with suitable frequency span including 100MHz bandwidth from band edge. The band edges was measured and recorded.

The spectrum plots (Peak RBW=100kHz, VBW=300kHz; Average RBW=1MHz, VBW= 10Hz are attached on the following pages.

4.6.4 DEVIATION FROM TEST STANDARD

No deviation.

4.6.5 EUT OPERATING CONDITION

Same as 4.3.6.

4.6.6 TEST RESULTS

The spectrum plots are attached on the following 12 images. D1 line indicates the highest level, and D2 line indicates the 20dB offset below D1. It shows compliance with the requirement in part 15.247(d).

802.11b DSSS MODULATION

NOTE 1: The band edge emission plot on the next page shows 51.80dBc between carrier maximum power and local maximum emission in restrict band (2.33020GHz). The emission of carrier strength list in the test result of channel 1 at the item 4.1.7 is 109.02dBuV/m (Peak), so the maximum field strength in restrict band is $109.02 - 51.80 = 57.22$ dBuV/m which is under 74dBuV/m limit.

The band edge emission plot on the next page shows 60.26dBc between carrier maximum power and local maximum emission in restrict band (2.38600GHz). The emission of carrier strength list in the test result of channel 1 at the item 4.1.7 is 104.46dBuV/m (Peak), so the maximum field strength in restrict band is $104.46 - 60.26 = 44.20$ dBuV/m which is under 54dBuV/m limit.

NOTE 2: The band edge emission plot on the next second page shows 52.23dBc between carrier maximum power and local maximum emission in restrict band (2.48880GHz). The emission of carrier strength list in the test result of channel 11 at the item 4.1.7 is 109.44dBuV/m (Peak), so the maximum field strength in restrict band is $109.44 - 52.23 = 57.21$ dBuV/m which is under 74dBuV/m limit.

The band edge emission plot on the next third page shows 61.22dBc between carrier maximum power and local maximum emission in restrict band (2.48480GHz). The emission of carrier strength list in the test result of channel 11 at the item 4.1.7 is 104.99dBuV/m (Peak), so the maximum field strength in restrict band is $104.99 - 61.22 = 43.77$ dBuV/m which is under 54dBuV/m limit.

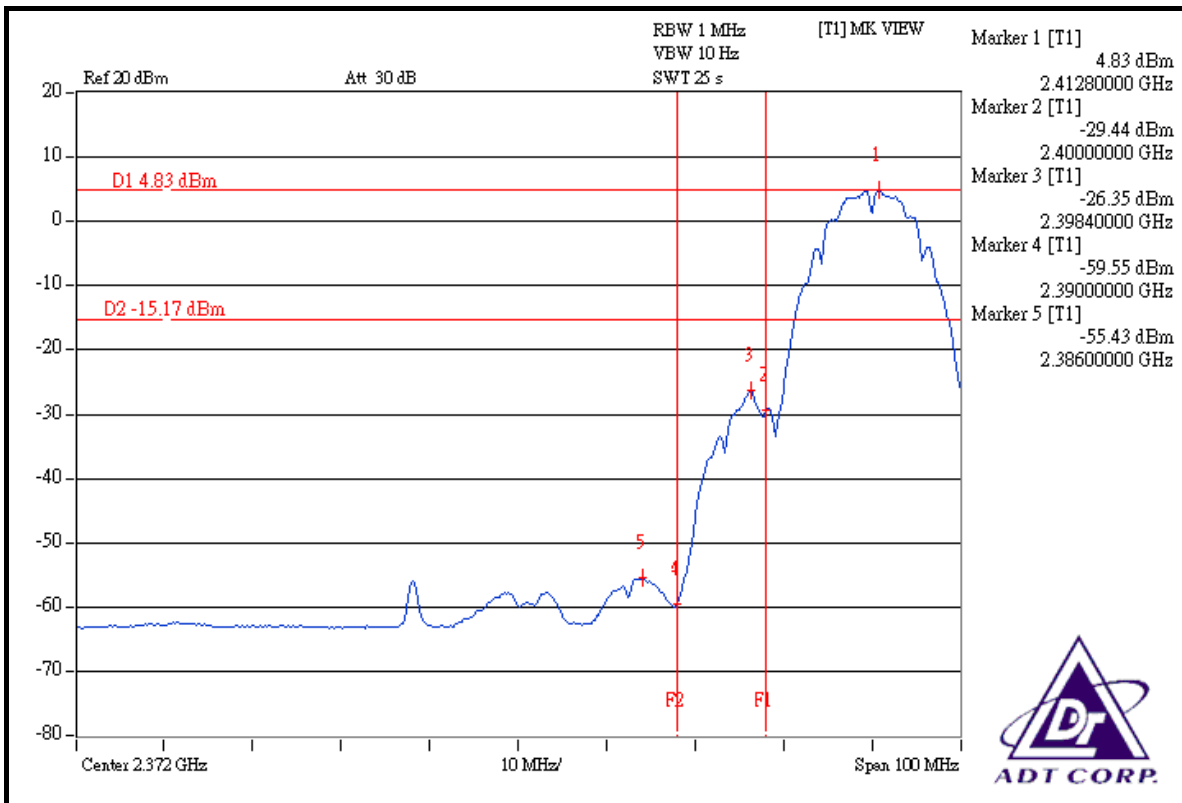
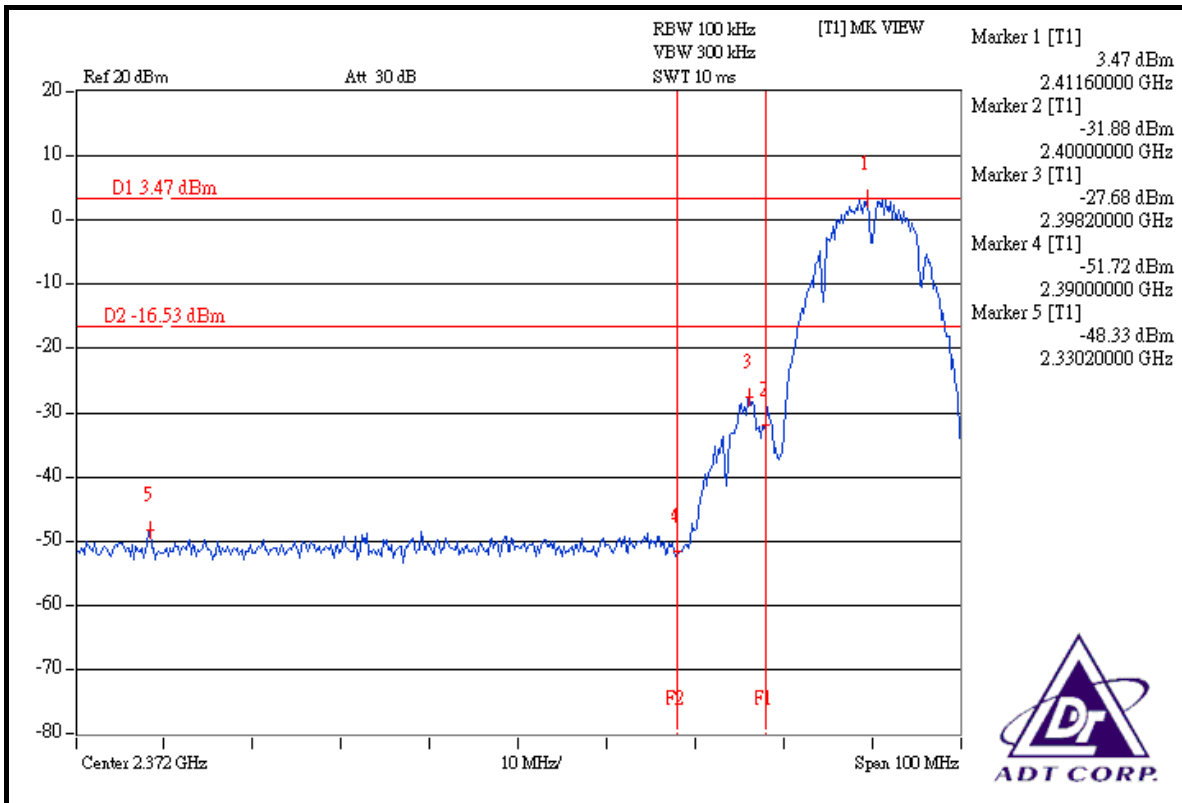

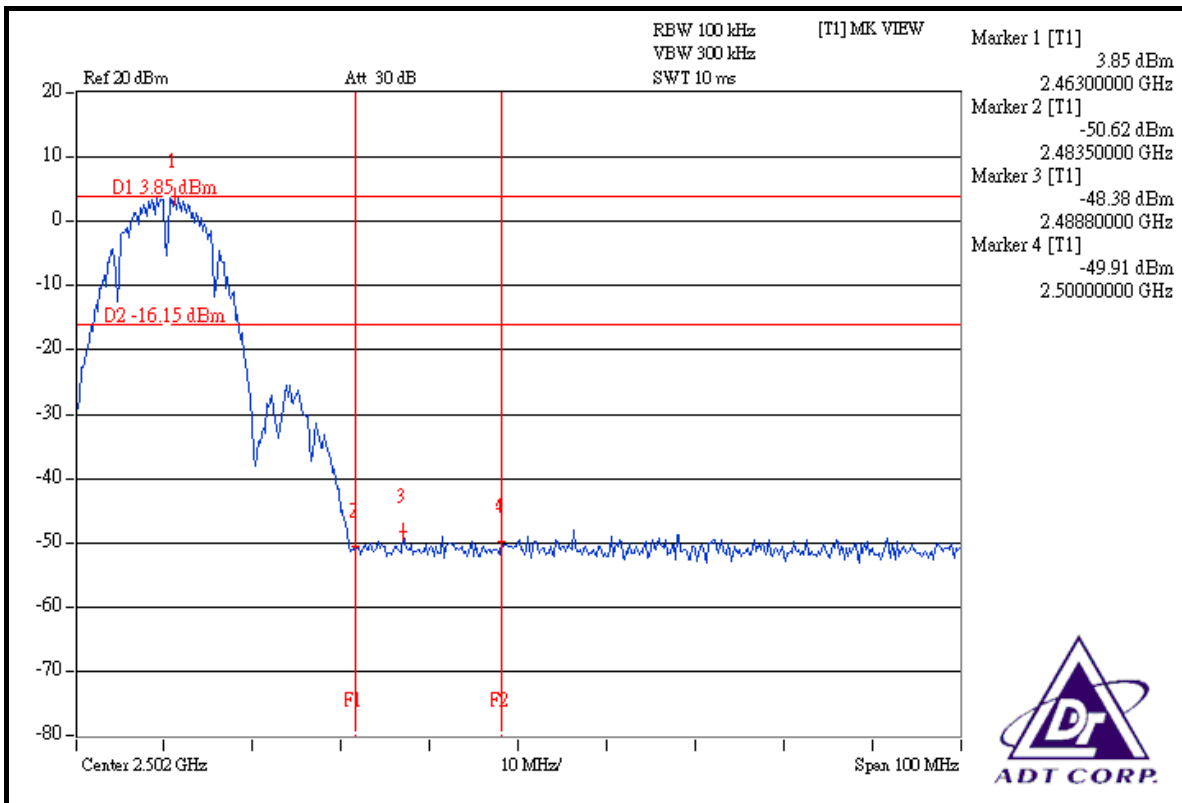
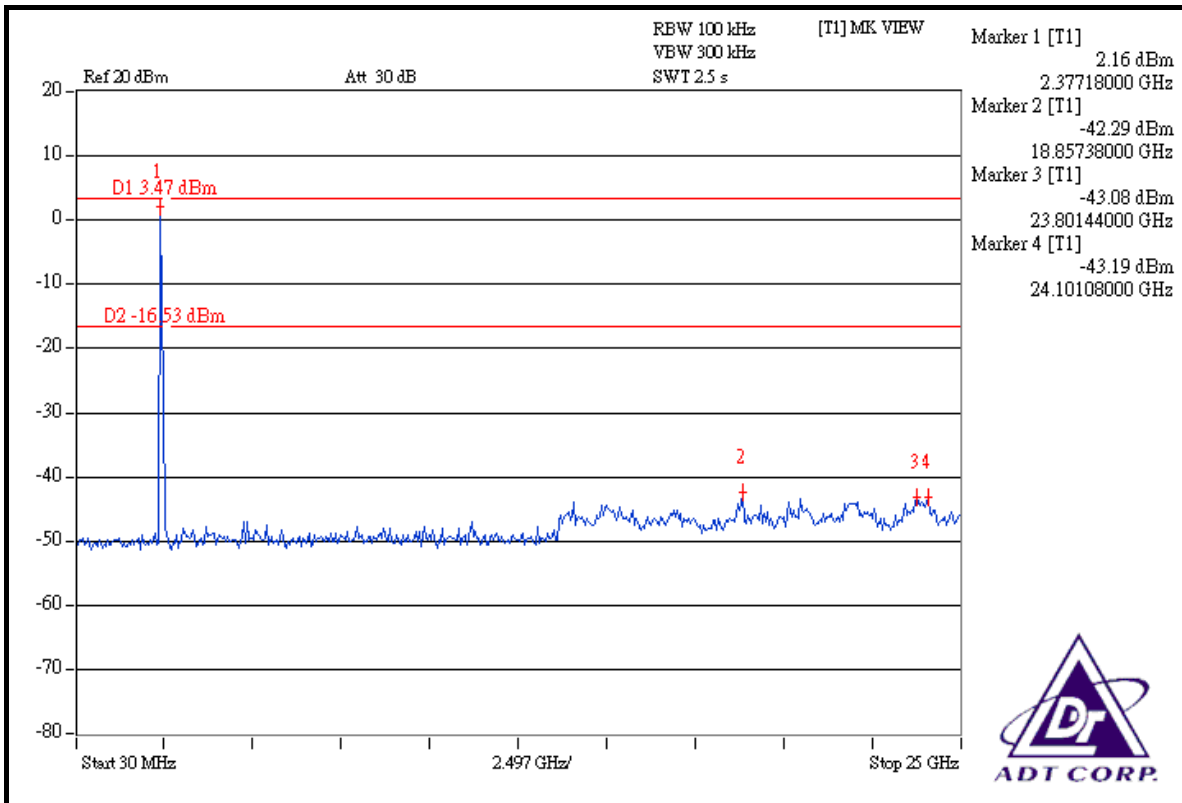

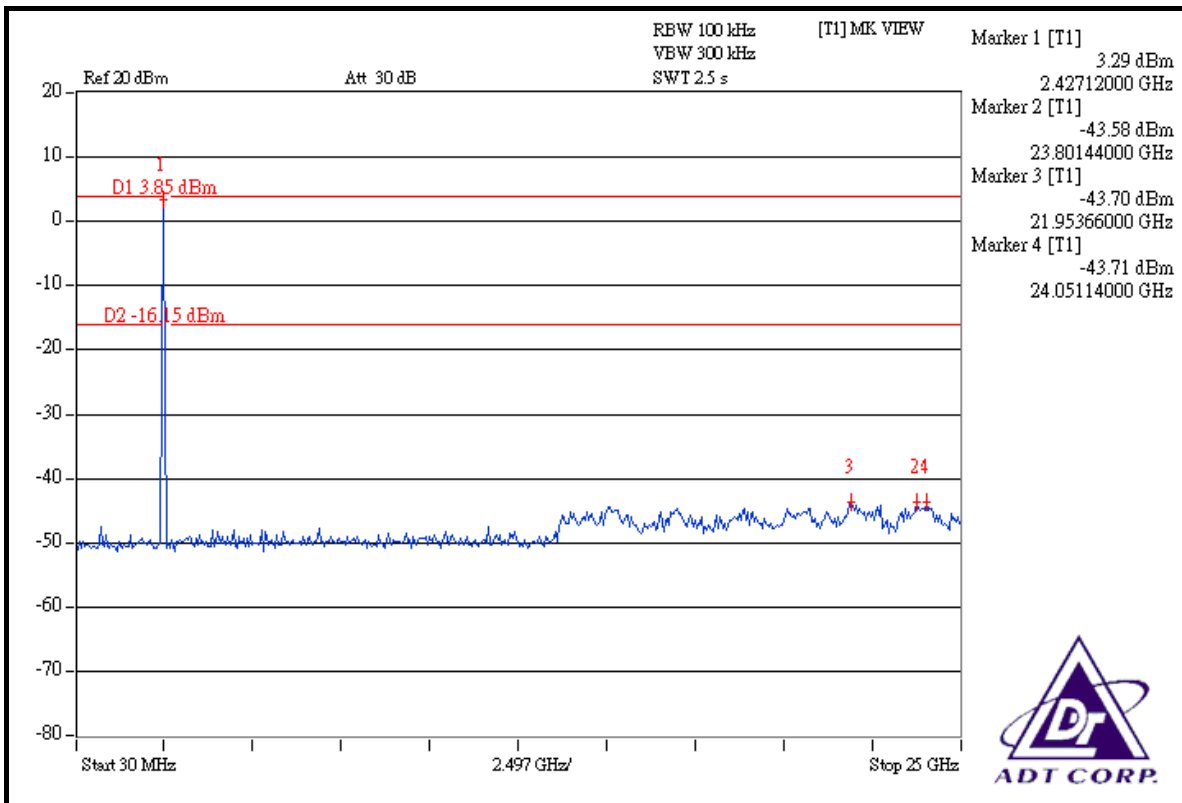
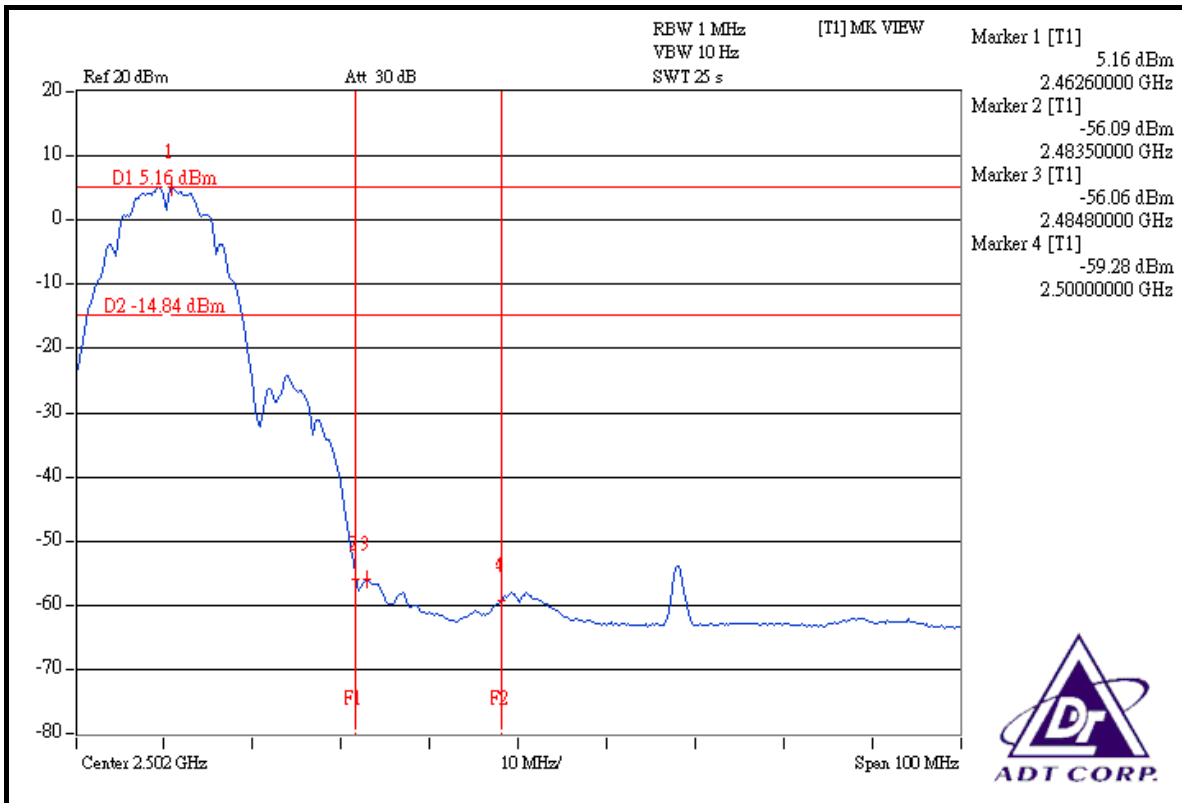

802.11g OFDM MODULATION

NOTE 1: The band edge emission plot on the next page shows 44.47dBc between carrier maximum power and local maximum emission in restrict band (2.36000GHz). The emission of carrier strength list in the test result of channel 1 at the item 4.2.7 is 110.22dBuV/m (Peak), so the maximum field strength in restrict band is $110.22 - 44.47 = 65.75$ dBuV/m which is under 74dBuV/m limit.

The band edge emission plot on the next page shows 49.84dBc between carrier maximum power and local maximum emission in restrict band (2.36000GHz). The emission of carrier strength list in the test result of channel 1 at the item 4.2.7 is 100.41dBuV/m (Peak), so the maximum field strength in restrict band is $100.41 - 49.84 = 50.57$ dBuV/m which is under 54dBuV/m limit.

NOTE 2: The band edge emission plot on the next second page shows 46.19dBc between carrier maximum power and local maximum emission in restrict band (2.48440GHz). The emission of carrier strength list in the test result of channel 11 at the item 4.2.7 is 110.91dBuV/m (Peak), so the maximum field strength in restrict band is $110.91 - 46.19 = 64.72$ dBuV/m which is under 74dBuV/m limit.

The band edge emission plot on the next third page shows 49.35dBc between carrier maximum power and local maximum emission in restrict band (2.48350GHz). The emission of carrier strength list in the test result of channel 11 at the item 4.2.7 is 101.20dBuV/m (Peak), so the maximum field strength in restrict band is $101.20 - 49.35 = 51.85$ dBuV/m which is under 54dBuV/m limit.

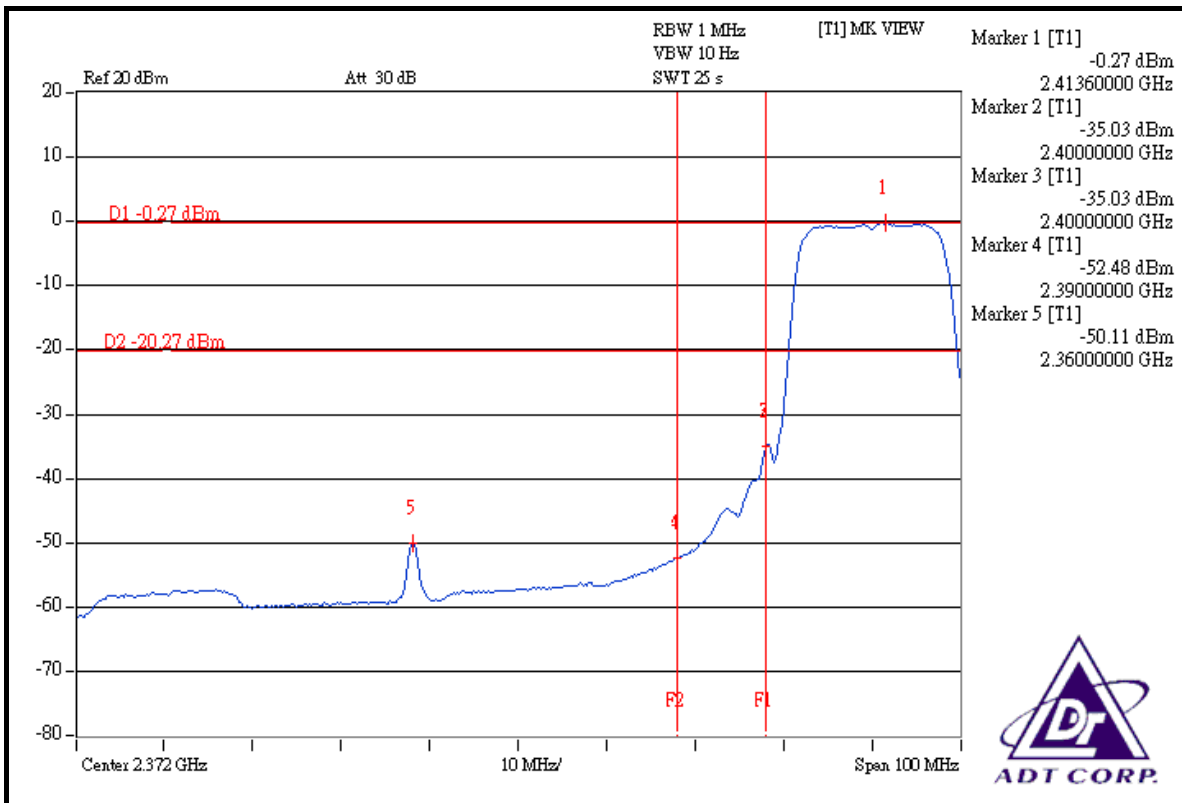
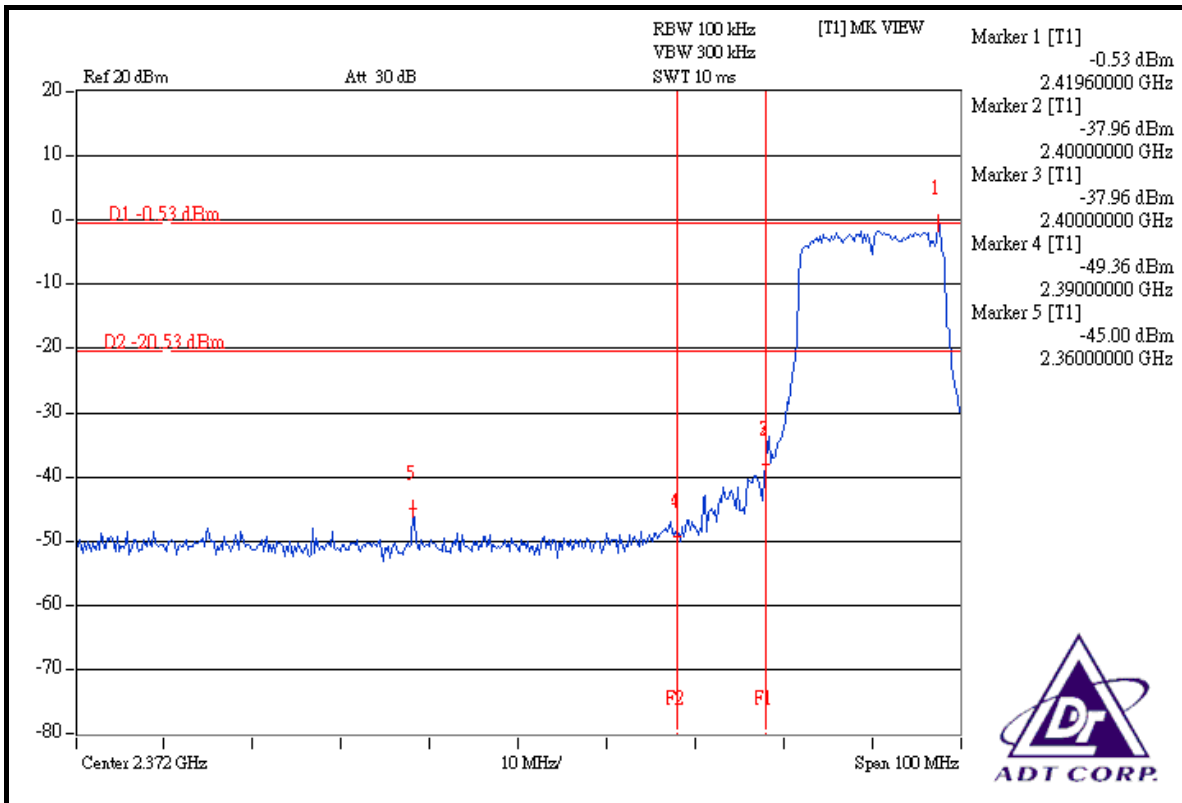

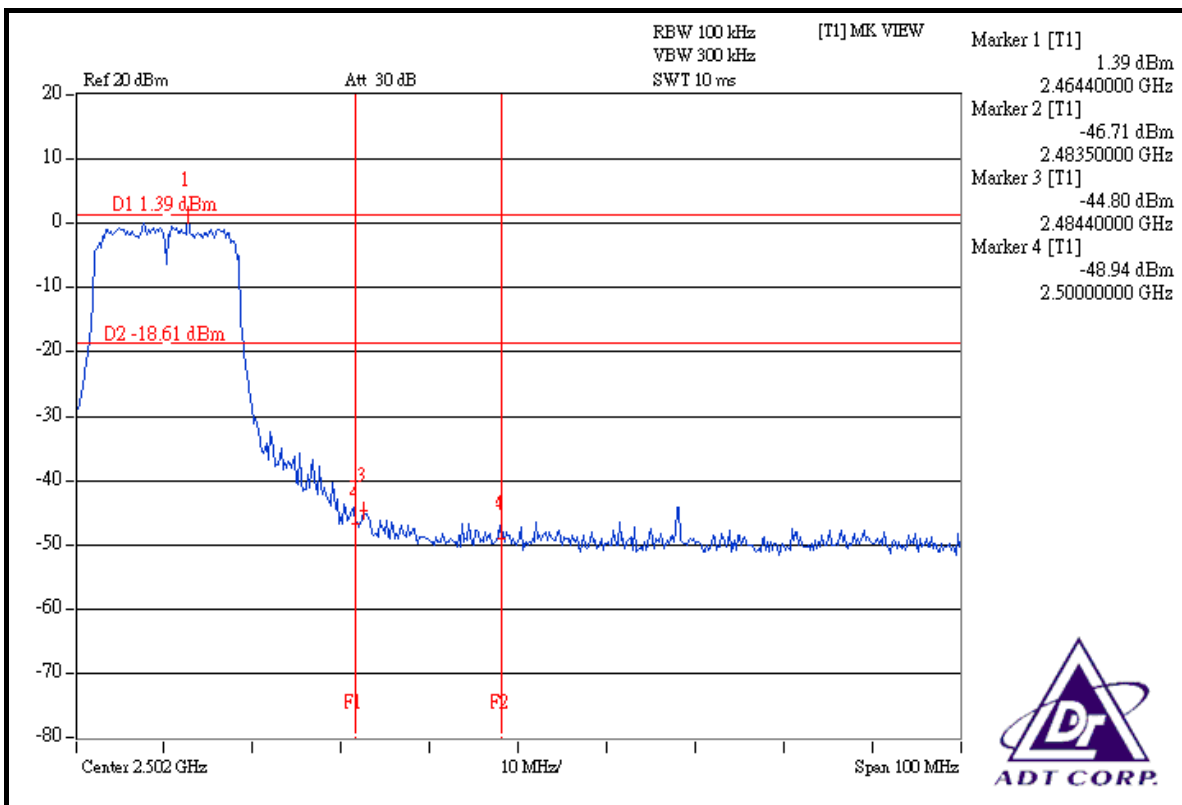
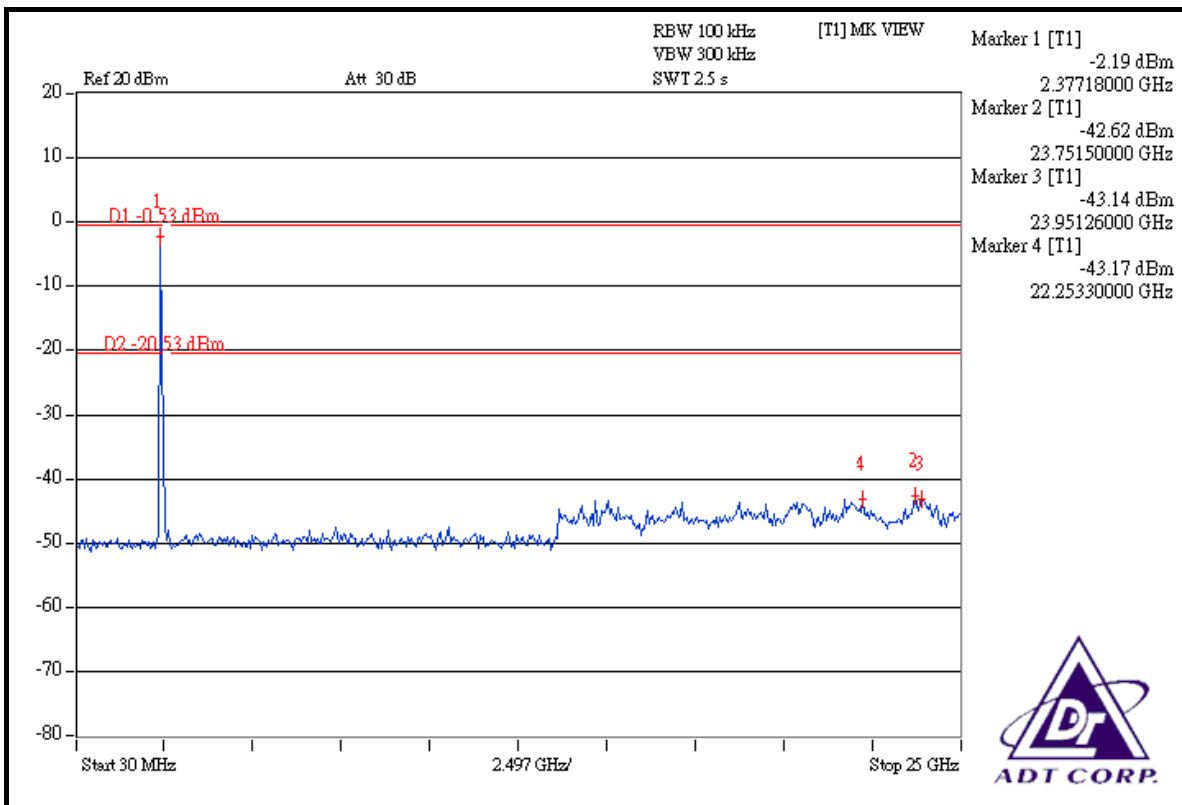

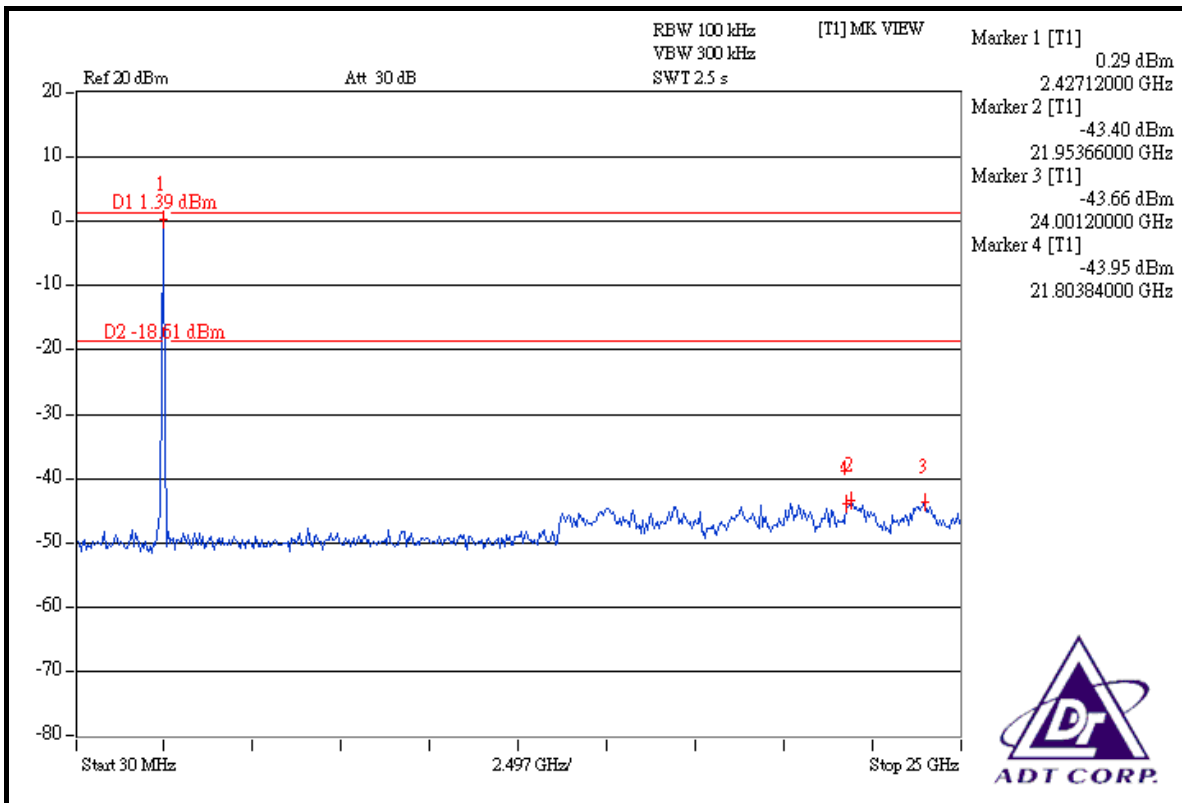
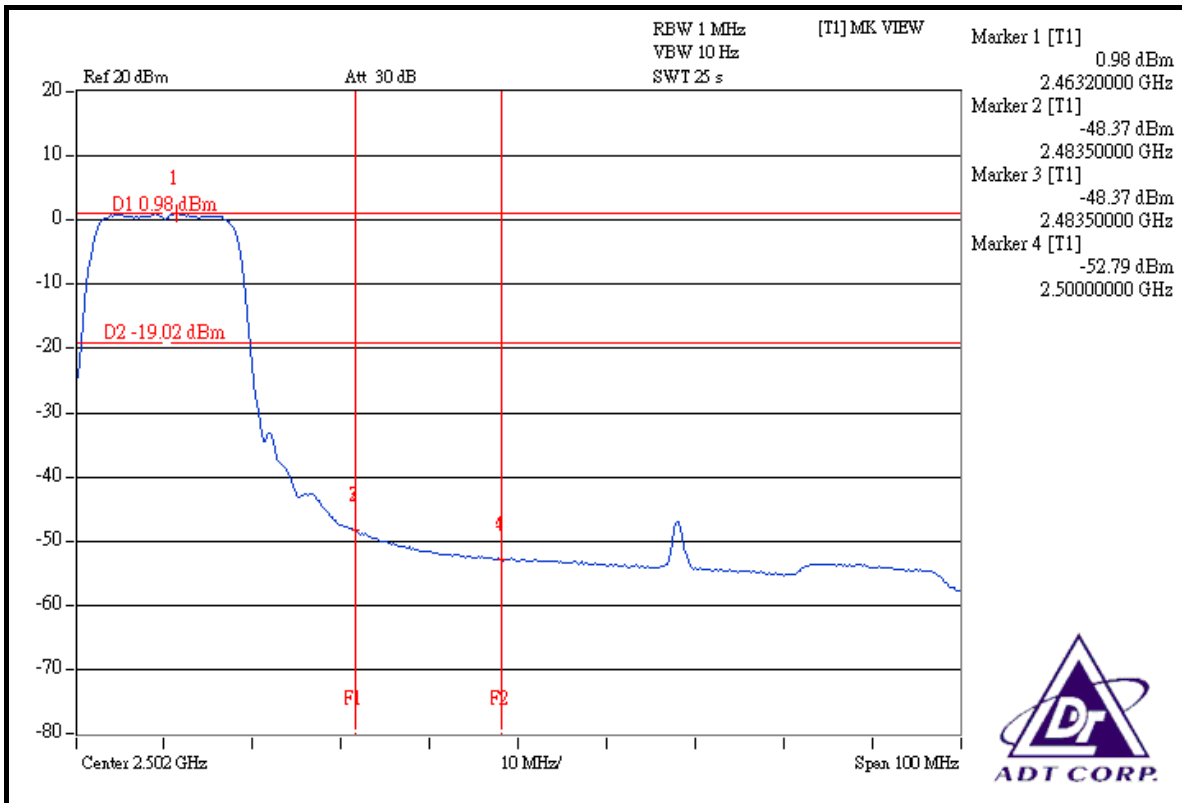

4.7 ANTENNA REQUIREMENT

4.7.1 STANDARD APPLICABLE

For intentional device, according to FCC 47 CFR Section 15.203, an intentional radiator shall be designed to ensure that no antenna other than that furnished by the responsible party shall be used with the device.

And according to FCC 47 CFR Section 15.247 (b), if transmitting antennas of directional gain greater than 6dBi are used, the power shall be reduced by the amount in dB that the directional gain of the antenna exceeds 6dBi.

4.7.2 ANTENNA CONNECTED CONSTRUCTION

The antenna type used in this product is Dipole antenna with R-SMA antenna connector. The maximum Gain of the antenna is 1.8dBi.



5 PHOTOGRAPHS OF THE TEST CONFIGURATION

Please refer to the attached file (Test Setup Photo).



6 INFORMATION ON THE TESTING LABORATORIES

We, ADT Corp., were founded in 1988 to provide our best service in EMC, Radio, Telecom and Safety consultation. Our laboratories are accredited and approved by the following approval agencies according to ISO/IEC 17025.

USA	FCC, UL, A2LA
Germany	TUV Rheinland
Japan	VCCI
Norway	NEMKO
Canada	INDUSTRY CANADA , CSA
R.O.C.	TAF, BSMI, NCC
Netherlands	Telefication
Singapore	GOST-ASIA(MOU)
Russia	CERTIS(MOU)

Copies of accreditation certificates of our laboratories obtained from approval agencies can be downloaded from our web site: www.adt.com.tw/index.5/phtml. If you have any comments, please feel free to contact us at the following:

Linko EMC/RF Lab
Tel: 886-2-26052180
Fax: 886-2-26051924

Hsin Chu EMC/RF Lab
Tel: 886-3-5935343
Fax: 886-3-5935342

Hwa Ya EMC/RF/Safety/Telecom Lab
Tel: 886-3-3183232
Fax: 886-3-3185050

Web Site: www.adt.com.tw

The address and road map of all our labs can be found in our web site also.

7 APPENDIX A – MODIFICATIONS RECORDERS FOR ENGINEERING CHANGES TO THE EUT BY THE LAB

No any modifications are made to the EUT by the lab during the test.