



FCC TEST REPORT (15.407)

REPORT NO.: RF971112L07-1

MODEL NO.: DIR-825

MODEL NO.: WLAN-2000
(refer to item 3.1 for more detail)

RECEIVED: Nov. 11, 2008

TESTED: Nov. 13 ~ Nov. 18, 2008

APPLICANT: CAMEO COMMUNICATIONS, INC.

ADDRESS: 5F, No. 42, Sec. 6, Mincyuan E. Rd., Neihu District, Taipei City 114, Taiwan

ISSUED BY: Bureau Veritas Consumer Products Services (H.K.) Ltd., Taoyuan Branch

LAB ADDRESS: No. 47, 14th Ling, Chia Pau Tsuen, Lin Kou Hsiang, Taipei Hsien 244, Taiwan, R.O.C.

TEST LOCATION: No. 19, Hwa Ya 2nd Rd, Wen Hwa Tsuen, Kwei Shan Hsiang, Taoyuan Hsien 333, Taiwan, R.O.C.

This test report consists of 102 pages in total. It may be duplicated completely for legal use with the approval of the applicant. It should not be reproduced except in full, without the written approval of our laboratory. The client should not use it to claim product endorsement by TAF or any government agencies. The test results in the report only apply to the tested sample.





TABLE OF CONTENTS

1.	CERTIFICATION.....	4
2.	SUMMARY OF TEST RESULTS	5
2.1	MEASUREMENT UNCERTAINTY	5
3.	GENERAL INFORMATION.....	6
3.1	GENERAL DESCRIPTION OF EUT	6
3.2	DESCRIPTION OF TEST MODES	8
3.2.1	CONFIGURATION OF SYSTEM UNDER TEST	8
3.2.2	TEST MODE APPLICABILITY AND TESTED CHANNEL DETAIL	9
3.3	GENERAL DESCRIPTION OF APPLIED STANDARDS	11
3.4	DESCRIPTION OF SUPPORT UNITS	11
4.	TEST TYPES AND RESULTS	12
4.1	RADIATED EMISSION MEASUREMENT	12
4.1.1	LIMITS OF RADIATED EMISSION MEASUREMENT	12
4.1.2	LIMITS OF UNWANTED EMISSION OUT OF THE RESTRICTED BANDS	12
4.1.3	TEST INSTRUMENTS.....	13
4.1.4	TEST PROCEDURES	14
4.1.5	DEVIATION FROM TEST STANDARD.....	14
4.1.6	TEST SETUP	15
4.1.7	EUT OPERATING CONDITION.....	15
4.1.8	TEST RESULTS	16
4.2	CONDUCTED EMISSION MEASUREMENT	26
4.2.1	LIMITS OF CONDUCTED EMISSION MEASUREMENT	26
4.2.2	TEST INSTRUMENTS.....	26
4.2.3	TEST PROCEDURES	27
4.2.4	DEVIATION FROM TEST STANDARD.....	27
4.2.5	TEST SETUP	28
4.2.6	EUT OPERATING CONDITIONS	28
4.2.7	TEST RESULTS	29
4.3	PEAK TRANSMIT POWER MEASUREMENT	33
4.3.1	LIMITS OF PEAK TRANSMIT POWER MEASUREMENT	33
4.3.2	TEST INSTRUMENTS.....	33
4.3.3	TEST PROCEDURE.....	33
4.3.4	DEVIATION FROM TEST STANDARD.....	34
4.3.5	TEST SETUP	34
4.3.6	EUT OPERATING CONDITIONS	34
4.3.7	TEST RESULTS	35
4.4	PEAK POWER EXCURSION MEASUREMENT	48
4.4.1	LIMITS OF PEAK POWER EXCURSION MEASUREMENT	48
4.4.2	TEST INSTRUMENTS.....	48
4.4.3	TEST PROCEDURE.....	48
4.4.4	DEVIATION FROM TEST STANDARD.....	49
4.4.5	TEST SETUP	49
4.4.6	EUT OPERATING CONDITIONS	49
4.4.7	TEST RESULTS	50



A D T

4.5	PEAK POWER SPECTRAL DENSITY MEASUREMENT	69
4.5.1	LIMITS OF PEAK POWER SPECTRAL DENSITY MEASUREMENT	69
4.5.2	TEST INSTRUMENTS	69
4.5.3	TEST PROCEDURES	69
4.5.4	DEVIATION FROM TEST STANDARD	70
4.5.5	TEST SETUP	70
4.5.6	EUT OPERATING CONDITIONS	70
4.5.7	TEST RESULTS	71
4.6	FREQUENCY STABILITY	82
4.6.1	LIMITS OF FREQUENCY STABILITY MEASUREMENT	82
4.6.2	TEST INSTRUMENTS	82
4.6.3	TEST PROCEDURE	82
4.6.4	DEVIATION FROM TEST STANDARD	83
4.6.5	TEST SETUP	83
4.6.6	EUT OPERATING CONDITION	83
4.6.7	TEST RESULTS	84
4.7	BAND EDGES MEASUREMENT	85
4.7.1	TEST INSTRUMENTS	85
4.7.2	TEST PROCEDURE	86
4.7.3	EUT OPERATING CONDITION	86
4.7.4	TEST RESULTS	87
4.8	ANTENNA REQUIREMENT	99
4.8.1	STANDARD APPLICABLE	99
4.8.2	ANTENNA CONNECTED CONSTRUCTION	99
5.	PHOTOGRAPHS OF THE TEST CONFIGURATION	100
6.	INFORMATION ON THE TESTING LABORATORIES	101
7.	APPENDIX A - MODIFICATIONS RECORDERS FOR ENGINEERING CHANGES TO THE EUT BY THE LAB	102



1. CERTIFICATION

PRODUCT: 802.11a/b/g/n 2.4/5G Dual Band Access Point

MODEL: WLAN-2000 (refer to item 3.1 for more detail)

BRAND: CAMEO (refer to item 3.1 for more detail)

APPLICANT: CAMEO COMMUNICATIONS, INC.

TEST SAMPLE: ENGINEERING SAMPLE

TESTED: Nov. 13 ~ Nov. 18, 2008

STANDARDS: FCC Part 15, Subpart E (Section 15.407)

ANSI C63.4-2003

The above equipment (Model: WLAN-2000) has been tested by **Bureau Veritas Consumer Products Services (H.K.) Ltd., Taoyuan Branch**, and found compliance with the requirement of the above standards. The test record, data evaluation & Equipment Under Test (EUT) configurations represented herein are true and accurate accounts of the measurements of the sample's EMC characteristics under the conditions specified in this report.

PREPARED BY : Andrea Hsia , **DATE:** Nov. 27, 2008
Andrea Hsia / Specialist

TECHNICAL ACCEPTANCE : Long Chen , **DATE:** Nov. 27, 2008
Responsible for RF Long Chen / Senior Engineer

APPROVED BY : Gary Chang , **DATE:** Nov. 27, 2008
Gary Chang / Assistant Manager

2. SUMMARY OF TEST RESULTS

The EUT has been tested according to the following specifications:

APPLIED STANDARD: FCC PART 15, SUBPART E (SECTION 15.407)			
STANDARD SECTION	TEST TYPE AND LIMIT	RESULT	REMARK
15.407(b)(5)	AC Power Conducted Emission	PASS	Meet the requirement of limit. Minimum passing margin is -9.00dB at 17.070 & 17.297MHz.
15.407(b)(1/2/3) (b)(5)	Electric Field Strength Spurious Emissions, 30MHz ~ 40000MHz	PASS	Meet the requirement of limit. Minimum passing margin is -3.44dB at 5150.00MHz.
15.407(a)(1/2/3)	Peak Transmit Power	PASS	Meet the requirement of limit.
15.407(a)(6)	Peak Power Excursion	PASS	Meet the requirement of limit.
15.407(a)(1/2/3)	Peak Power Spectral Density	PASS	Meet the requirement of limit.
15.407(g)	Frequency Stability	PASS	Meet the requirement of limit.

2.1 MEASUREMENT UNCERTAINTY

Where relevant, the following measurement uncertainty levels have been estimated for tests performed on the EUT as specified in CISPR 16-4-2:

MEASUREMENT	FREQUENCY	UNCERTAINTY
Conducted emissions	9kHz~30MHz	2.44 dB
Radiated emissions	30MHz ~ 200MHz	3.34 dB
	200MHz ~1000MHz	3.35 dB
	1GHz ~ 18GHz	2.26 dB
	18GHz ~ 40GHz	1.94 dB

This uncertainty represents an expanded uncertainty expressed at approximately the 95% confidence level using a coverage factor of $k = 2$.

3. GENERAL INFORMATION

3.1 GENERAL DESCRIPTION OF EUT

EUT	802.11a/b/g/n 2.4/5G Dual Band Access Point
MODEL NO.	WLAN-2000 (refer to note as below)
FCC ID	NHPWLAN2000
POWER SUPPLY	5.0Vdc from AC adapter 7.5Vdc from AC adapter
MODULATION TYPE	CCK, DQPSK, DBPSK for DSSS 64QAM, 16QAM, QPSK, BPSK for OFDM
MODULATION TECHNOLOGY	DSSS, OFDM
TRANSFER RATE	802.11b: 11.0/ 5.5/ 2.0/ 1.0Mbps 802.11g: 54.0/ 48.0/ 36.0/ 24.0/ 18.0/ 12.0/ 9.0/ 6.0Mbps 802.11a: 54.0/ 48.0/ 36.0/ 24.0/ 18.0/ 12.0/ 9.0/ 6.0Mbps Draft 802.11n: up to 300.0Mbps
FREQUENCY RANGE	2.4GHz: 2400.0 ~ 2483.5MHz 5.0GHz: 5150.0 ~ 5250.0MHz, 5725.0 ~ 5825.0MHz
NUMBER OF CHANNEL	2.4GHz: 11 for 802.11b, 802.11g, draft 802.11n (20MHz) 7 for draft 802.11n (40MHz) 5.0GHz: 9 for 802.11a, draft 802.11n (20MHz) 4 for draft 802.11n (40MHz)
OUTPUT POWER	361.851mW for 2400.0 ~ 2483.5MHz 43.825mW for 5150.0 ~ 5250.0MHz 320.882mW for 5725.0 ~ 5825.0MHz
ANTENNA TYPE	2.4GHz: Dipole antenna with 2.0dBi gain 5.0GHz: Dipole antenna with 3.0dBi gain Dipole antenna with 2.0dBi gain
DATA CABLE	NA
I/O PORTS	RJ45
ASSOCIATED DEVICES	Adapter

NOTE:

- The EUT is a 802.11a/b/g/n 2.4/5G Dual Band Access Point. The functions of EUT listed as below:

	TEST STANDARD	REFERENCE REPORT
WLAN 802.11b/g, draft 802.11n	FCC Part 15, Subpart C (Section 15.247)	RF971112L07
WLAN 802.11a, draft 802.11n (5725~5825 MHz)		
WLAN 802.11a, draft 802.11n (5150~ 5250MHz)	FCC Part 15, Subpart E (Section 15.407)	RF971112L07-1

2. The following models are provided to this EUT.

BRAND	MODEL NAME	REMARK
CAMEO	WLAN-2000	For marketing different
TRENDnet	TEW-670APB	For marketing different

3. The frequency bands used in this EUT are listed as follows:

Frequency Band (MHz)	2400~2483.5	5150~5250	5725~5825
802.11b	√		
802.11g	√		
802.11a		√	√
Draft 802.11n (20MHz)	√	√	√
Draft 802.11n (40MHz)	√	√	√

4. The EUT was powered by the following adapters:

ADAPTER 1	
BRAND:	JENTEC TECHNOLOGY CO., LTD.
MODEL:	AF1805-A
INPUT:	100-120Vac~0.4A, 50-60Hz
OUTPUT:	5.0Vdc, 2.5A
POWER LINE:	1.8m non-shielded cable without core

ADAPTER 2	
BRAND:	LEADER ELECTRONICS INC.
MODEL:	MT12-Y075100-A1
INPUT:	100-120Vac~60Hz, 0.3A
OUTPUT:	7.5Vdc, 1A
POWER LINE:	1.8m non-shielded cable without core

5. The EUT incorporates a MIMO function. Physically, the EUT provides two completed transmitters and two receivers.

MODULATION MODE	TX FUNCTION
802.11b	2TX
802.11g	2TX
802.11a	2TX
Draft 802.11n (20MHz)	2TX
Draft 802.11n (40MHz)	2TX

6. The above EUT information was declared by manufacturer and for more detailed features description, please refer to the manufacturer's specifications or user's manual.

3.2 DESCRIPTION OF TEST MODES

4 channels are provided for 802.11a, draft 802.11n (20MHz):

CHANNEL	FREQUENCY	CHANNEL	FREQUENCY
36	5180MHz	44	5220MHz
40	5200MHz	48	5240MHz

2 channels are provided for draft 802.11n (40MHz):

CHANNEL	FREQUENCY	CHANNEL	FREQUENCY
38	5190MHz	46	5230MHz

3.2.1 CONFIGURATION OF SYSTEM UNDER TEST

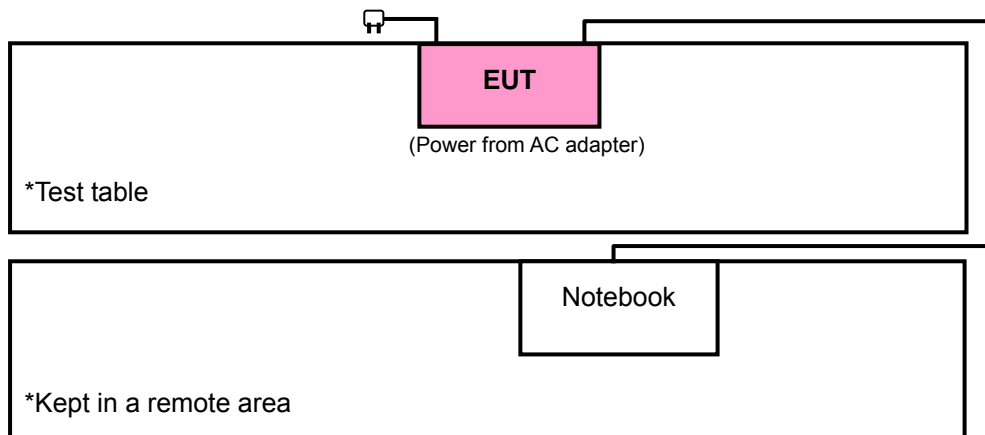



3.2.2 TEST MODE APPLICABILITY AND TESTED CHANNEL DETAIL

EUT CONFIGURE MODE	APPLICABLE TO				DESCRIPTION
	RE≥1G	RE<1G	PLC	APCM	
A	√	√	√	√	Power from AC Adapter 1
B	-	√	√	-	Power from AC Adapter 2

Where **RE≥1G**: Radiated Emission above 1GHz **RE<1G**: Radiated Emission below 1GHz
PLC: Power Line Conducted Emission **APCM**: Antenna Port Conducted Measurement
Note: “-” means no effect.

RADIATED EMISSION TEST (ABOVE 1GHz):

- Pre-Scan has been conducted to determine the worst-case mode from all possible combinations between available modulations, data rates and antenna ports (if EUT with antenna diversity architecture).
- Following channel(s) was (were) selected for the final test as listed below.

EUT CONFIGURE MODE	MODE	AVAILABLE CHANNEL	TESTED CHANNEL	MODULATION TECHNOLOGY	MODULATION TYPE	DATA RATE (Mbps)
A	802.11a	36 to 48	36, 40, 48	OFDM	BPSK	6.0
A	Draft 802.11n (20MHz)	36 to 48	36, 40, 48	OFDM	BPSK	7.2
A	Draft 802.11n (40MHz)	38 to 46	38, 46	OFDM	BPSK	15.0

RADIATED EMISSION TEST (BELOW 1GHz):

- Pre-Scan has been conducted to determine the worst-case mode from all possible combinations between available modulations, data rates and antenna ports (if EUT with antenna diversity architecture).
- Following channel(s) was (were) selected for the final test as listed below.

EUT CONFIGURE MODE	MODE	AVAILABLE CHANNEL	TESTED CHANNEL	MODULATION TECHNOLOGY	MODULATION TYPE	DATA RATE (Mbps)
A	802.11a	36 to 48	40	OFDM	BPSK	6.0
B	802.11a	36 to 48	40	OFDM	BPSK	6.0

POWER LINE CONDUCTED EMISSION TEST:

- Pre-Scan has been conducted to determine the worst-case mode from all possible combinations between available modulations, data rates and antenna ports (if EUT with antenna diversity architecture).
- Following channel(s) was (were) selected for the final test as listed below.

EUT CONFIGURE MODE	MODE	AVAILABLE CHANNEL	TESTED CHANNEL	MODULATION TECHNOLOGY	MODULATION TYPE	DATA RATE (Mbps)
A	802.11a	36 to 48	40	OFDM	BPSK	6.0
B	802.11a	36 to 48	40	OFDM	BPSK	6.0

BANDEDGE MEASUREMENT:

- Pre-Scan has been conducted to determine the worst-case mode from all possible combinations between available modulations, data rates and antenna ports (if EUT with antenna diversity architecture).
- Following channel(s) was (were) selected for the final test as listed below.

EUT CONFIGURE MODE	MODE	AVAILABLE CHANNEL	TESTED CHANNEL	MODULATION TECHNOLOGY	MODULATION TYPE	DATA RATE (Mbps)
A	802.11a	36 to 48	36, 48	OFDM	BPSK	6.0
A	Draft 802.11n (20MHz)	36 to 48	36, 48	OFDM	BPSK	7.2
A	Draft 802.11n (40MHz)	38 to 46	38, 46	OFDM	BPSK	15.0

ANTENNA PORT CONDUCTED MEASUREMENT:

- Pre-Scan has been conducted to determine the worst-case mode from all possible combinations between available modulations, data rates and antenna ports (if EUT with antenna diversity architecture).
- Following channel(s) was (were) selected for the final test as listed below.

EUT CONFIGURE MODE	MODE	AVAILABLE CHANNEL	TESTED CHANNEL	MODULATION TECHNOLOGY	MODULATION TYPE	DATA RATE (Mbps)
A	802.11a	36 to 48	36, 40, 48	OFDM	BPSK	6.0
A	Draft 802.11n (20MHz)	36 to 48	36, 40, 48	OFDM	BPSK	7.2
A	Draft 802.11n (40MHz)	38 to 46	38, 46	OFDM	BPSK	15.0

3.3 GENERAL DESCRIPTION OF APPLIED STANDARDS

The EUT is a RF Product. According to the specifications of the manufacturer, it must comply with the requirements of the following standards:

FCC Part 15, Subpart E (15.407)
ANSI C63.4-2003

All test items have been performed and recorded as per the above standards.

NOTE: The EUT is also considered as a kind of computer peripheral, because the connection to computer is necessary for typical use. It has been verified to comply with the requirements of FCC Part 15, Subpart B, Class B (DoC). The test report has been issued separately.

3.4 DESCRIPTION OF SUPPORT UNITS

The EUT has been tested as an independent unit together with other necessary accessories or support units. The following support units or accessories were used to form a representative test configuration during the tests.

NO.	PRODUCT	BRAND	MODEL NO.	SERIAL NO.	FCC ID
1	NOTEBOOK	DELL	PP05L	12130898320	E2K24CLNS

NO.	SIGNAL CABLE DESCRIPTION OF THE ABOVE SUPPORT UNITS
1	10m RJ45 UTP cable

NOTE: 1. All power cords of the above support units are non shielded (1.8m).
 2. Item 1 acted as communication partners to transfer data.

4. TEST TYPES AND RESULTS

4.1 RADIATED EMISSION MEASUREMENT

4.1.1 LIMITS OF RADIATED EMISSION MEASUREMENT

Emissions radiated outside of the specified bands, shall be according to the general radiated limits in 15.209 as following:

FREQUENCIES (MHz)	FIELD STRENGTH (microvolts/meter)	MEASUREMENT DISTANCE (meters)
0.009 ~ 0.490	2400/F(kHz)	300
0.490 ~ 1.705	24000/F(kHz)	30
1.705 ~ 30.0	30	30
30 ~ 88	100	3
88 ~ 216	150	3
216 ~ 960	200	3
Above 960	500	3

NOTE:

1. The lower limit shall apply at the transition frequencies.
2. Emission level (dBuV/m) = 20 log Emission level (uV/m).
3. As shown in 15.35(b), for frequencies above 1000MHz, the field strength limits are based on average detector, however, the peak field strength of any emission shall not exceed the maximum permitted average limits, specified above by more than 20dB under any condition of modulation.

4.1.2 LIMITS OF UNWANTED EMISSION OUT OF THE RESTRICTED BANDS

FREQUENCIES (MHz)	EIRP LIMIT (dBm)	EQUIVALENT FIELD STRENGTH AT 3m (dBµV/m) *NOTE 3
	PK	PK
5150 ~ 5250	-27	68.3

NOTE:

1. For frequencies 10MHz or greater above or below the band edge.
2. All emissions within the frequency range from the band edge to 10MHz above or below the band edge.
3. The following formula is used to convert the equipment isotropic radiated power (eirp) to field strength:

$$E = \frac{1000000\sqrt{30P}}{3} \mu\text{V/m, where P is the eirp (Watts).}$$

4.1.3 TEST INSTRUMENTS

DESCRIPTION & MANUFACTURER	MODEL NO.	SERIAL NO.	DATE OF CALIBRATION	DUE DATE OF CALIBRATION
Test Receiver ROHDE & SCHWARZ	ESI7	100033	Jun. 30, 2008	Jun. 29, 2009
Spectrum Analyzer ROHDE & SCHWARZ	FSP40	100041	Apr. 22, 2008	Apr. 21, 2009
BILOG Antenna SCHWARZBECK	VULB9168	9168-160	May 02, 2008	May 01, 2009
HORN Antenna SCHWARZBECK	9120D	9120D-209	Jun. 24, 2008	Jun. 23, 2009
HORN Antenna SCHWARZBECK	BBHA 9170	BBHA9170243	Dec. 25, 2007	Dec. 24, 2008
Preamplifier Agilent	8447D	2944A10633	Nov. 03, 2008	Nov. 02, 2009
Preamplifier Agilent	8449B	3008A01964	Oct. 23, 2008	Oct. 22, 2009
RF signal cable HUBER+SUHNNER	SUCOFLEX 104	238141/4	May 20, 2008	May 19, 2009
RF signal cable HUBER+SUHNNER	SUCOFLEX 104	12738/6	May 20, 2008	May 19, 2009
Software ADT.	ADT_Radiated_V7.6	NA	NA	NA
Antenna Tower inn-co GmbH	MA 4000	013303	NA	NA
Antenna Tower Controller inn-co GmbH	CO2000	017303	NA	NA
Turn Table ADT.	TT100.	TT93021703	NA	NA
Turn Table Controller ADT.	SC100.	SC93021703	NA	NA

- NOTE:**
1. The calibration interval of the above test instruments is 12 months and the calibrations are traceable to NML/ROC and NIST/USA.
 2. The test was performed in HwaYa Chamber 3.
 3. The horn antenna and HP preamplifier (model: 8449B) are used only for the measurement of emission frequency above 1GHz if tested.
 4. The FCC Site Registration No. is 988962.
 5. The IC Site Registration No. is IC3789B-3.

4.1.4 TEST PROCEDURES

- a. The EUT was placed on the top of a rotating table 0.8 meters above the ground at a 3 meter semi-anechoic chamber. The table was rotated 360 degrees to determine the position of the highest radiation.
- b. The EUT was set 3 meters away from the interference-receiving antenna, which was mounted on the top of a variable-height antenna tower.
- c. The antenna is a broadband antenna, and its height is varied from one meter to four meters above the ground to determine the maximum value of the field strength. Both horizontal and vertical polarizations of the antenna are set to make the measurement.
- d. For each suspected emission, the EUT was arranged to its worst case and then the antenna was tuned to heights from 1 meter to 4 meters and the rotatable table was turned from 0 degrees to 360 degrees to find the maximum reading.
- e. The test-receiver system was set to Peak Detect Function and Specified Bandwidth with Maximum Hold Mode.
- f. If the emission level of the EUT in peak mode was 10dB lower than the limit specified, then testing could be stopped and the peak values of the EUT would be reported. Otherwise the emissions that did not have 10dB margin would be re-tested one by one using peak, quasi-peak or average method as specified and then reported in a data sheet.

NOTE:

1. The resolution bandwidth and video bandwidth of test receiver/spectrum analyzer is 120kHz for Peak detection (PK) and Quasi-peak detection (QP) at frequency below 1GHz.
2. The resolution bandwidth of test receiver/spectrum analyzer is 1MHz and video bandwidth is 3MHz for Peak detection at frequency above 1GHz.
3. The resolution bandwidth of test receiver/spectrum analyzer is 1MHz and the video bandwidth is 10Hz for Average detection (AV) at frequency above 1GHz.
4. All modes of operation were investigated and the worst-case emissions are reported.

4.1.5 DEVIATION FROM TEST STANDARD

No deviation.

4.1.6 TEST SETUP

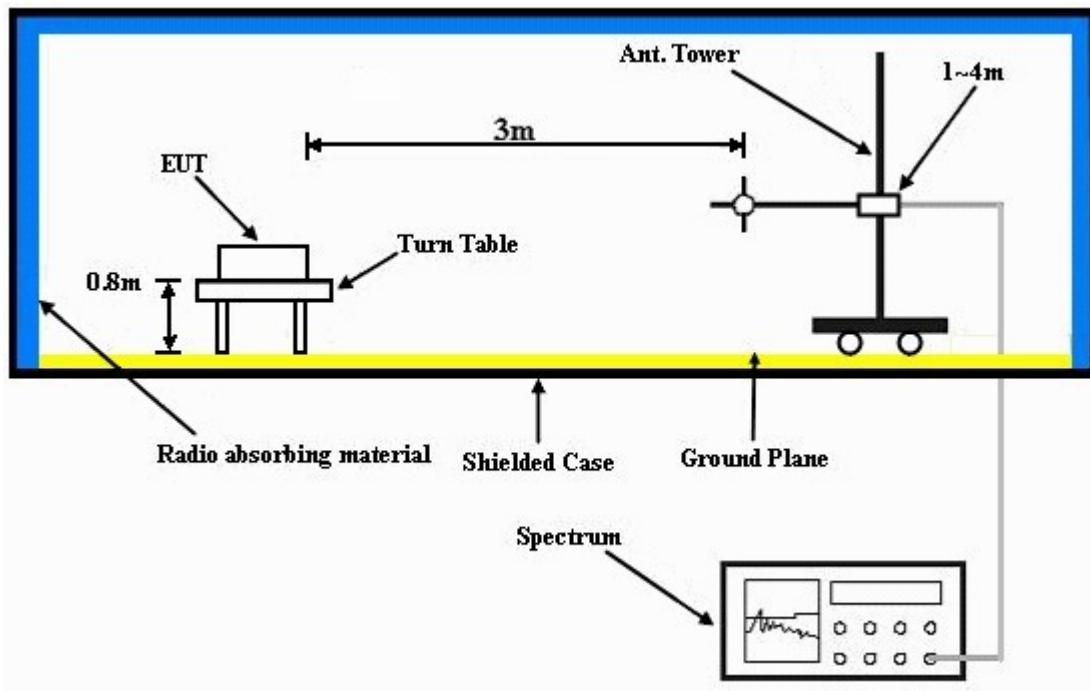

For the actual test configuration, please refer to the attached file (Test Setup Photo).

4.1.7 EUT OPERATING CONDITION

- Placed the EUT on the testing table.
- Prepared notebook system outside of testing area to act as a communication partners.
- The communication partner connected with EUT via a RJ45 UTP cable and run a test program (provided by manufacturer) to enable EUT under transmission condition continuously at specific channel frequency.
- The communication partner sent data to EUT by command "PING".

4.1.8 TEST RESULTS

802.11a OFDM MODULATION

EUT TEST CONDITION		MEASUREMENT DETAIL	
CHANNEL	Channel 36	FREQUENCY RANGE	1 ~ 40GHz
INPUT POWER (SYSTEM)	120Vac, 60 Hz	DETECTOR FUNCTION	Peak (PK) Average (AV)
ENVIRONMENTAL CONDITIONS	24deg. C, 62%RH 1000hPa	TESTED BY	Kevin Liang

ANTENNA POLARITY & TEST DISTANCE: HORIZONTAL AT 3 M								
NO.	FREQ. (MHz)	EMISSION LEVEL (dBuV/m)	LIMIT (dBuV/m)	MARGIN (dB)	ANTENNA HEIGHT (m)	TABLE ANGLE (Degree)	RAW VALUE (dBuV)	CORRECTION FACTOR (dB/m)
1	5150.00	49.03 PK	74.00	-24.97	1.00 H	17	8.54	40.49
2	5150.00	37.16 AV	54.00	-16.84	1.00 H	17	-3.33	40.49
3	*5180.00	100.81 PK			1.00 H	17	60.25	40.56
4	*5180.00	89.61 AV			1.00 H	17	49.05	40.56
5	#10360.00	60.99 PK	68.30	-7.31	1.22 H	143	8.88	52.11
ANTENNA POLARITY & TEST DISTANCE: VERTICAL AT 3 M								
NO.	FREQ. (MHz)	EMISSION LEVEL (dBuV/m)	LIMIT (dBuV/m)	MARGIN (dB)	ANTENNA HEIGHT (m)	TABLE ANGLE (Degree)	RAW VALUE (dBuV)	CORRECTION FACTOR (dB/m)
1	5150.00	59.51 PK	74.00	-14.49	1.18 V	158	19.02	40.49
2	5150.00	40.18 AV	54.00	-13.82	1.18 V	158	-0.31	40.49
3	*5180.00	111.01 PK			1.18 V	158	70.45	40.56
4	*5180.00	99.74 AV			1.18 V	158	59.18	40.56
5	#10360.00	60.41 PK	68.30	-7.89	1.41 V	20	8.30	52.11

- REMARKS:**
1. Emission level (dBuV/m) = Raw Value (dBuV) + Correction Factor (dB/m).
 2. Correction Factor (dB/m) = Antenna Factor (dB/m) + Cable Factor (dB).
 3. The other emission levels were very low against the limit.
 4. Margin value = Emission level – Limit value.
 5. “ * “: Fundamental frequency.
 6. “#”:The radiated frequency is out the restricted band.



A D T

EUT TEST CONDITION		MEASUREMENT DETAIL	
CHANNEL	Channel 40	FREQUENCY RANGE	1 ~ 40GHz
INPUT POWER (SYSTEM)	120Vac, 60 Hz	DETECTOR FUNCTION	Peak (PK) Average (AV)
ENVIRONMENTAL CONDITIONS	24deg. C, 62%RH 1000hPa	TESTED BY	Kevin Liang

ANTENNA POLARITY & TEST DISTANCE: HORIZONTAL AT 3 M								
NO.	FREQ. (MHz)	EMISSION LEVEL (dBuV/m)	LIMIT (dBuV/m)	MARGIN (dB)	ANTENNA HEIGHT (m)	TABLE ANGLE (Degree)	RAW VALUE (dBuV)	CORRECTION FACTOR (dB/m)
1	*5200.00	100.00 PK			1.00 H	205	59.40	40.60
2	*5200.00	88.70 AV			1.00 H	205	48.10	40.60
3	#10400.00	60.86 PK	68.30	-7.44	1.17 H	155	8.59	52.27
ANTENNA POLARITY & TEST DISTANCE: VERTICAL AT 3 M								
NO.	FREQ. (MHz)	EMISSION LEVEL (dBuV/m)	LIMIT (dBuV/m)	MARGIN (dB)	ANTENNA HEIGHT (m)	TABLE ANGLE (Degree)	RAW VALUE (dBuV)	CORRECTION FACTOR (dB/m)
1	*5200.00	110.92 PK			1.16 V	156	70.32	40.60
2	*5200.00	99.57 AV			1.16 V	156	58.97	40.60
3	#10400.00	61.28 PK	68.30	-7.02	1.05 V	75	9.01	52.27

- REMARKS:**
1. Emission level (dBuV/m) = Raw Value (dBuV) + Correction Factor (dB/m).
 2. Correction Factor (dB/m) = Antenna Factor (dB/m) + Cable Factor (dB).
 3. The other emission levels were very low against the limit.
 4. Margin value = Emission level – Limit value.
 5. “ * “: Fundamental frequency.
 6. "#":The radiated frequency is out the restricted band.



A D T

EUT TEST CONDITION		MEASUREMENT DETAIL	
CHANNEL	Channel 48	FREQUENCY RANGE	1 ~ 40GHz
INPUT POWER (SYSTEM)	120Vac, 60 Hz	DETECTOR FUNCTION	Peak (PK) Average (AV)
ENVIRONMENTAL CONDITIONS	24deg. C, 62%RH 1000hPa	TESTED BY	Kevin Liang

ANTENNA POLARITY & TEST DISTANCE: HORIZONTAL AT 3 M								
NO.	FREQ. (MHz)	EMISSION LEVEL (dBuV/m)	LIMIT (dBuV/m)	MARGIN (dB)	ANTENNA HEIGHT (m)	TABLE ANGLE (Degree)	RAW VALUE (dBuV)	CORRECTION FACTOR (dB/m)
1	*5240.00	99.29 PK			1.01 H	210	58.62	40.67
2	*5240.00	88.13 AV			1.01 H	210	47.46	40.67
3	5350.00	46.41 PK	74.00	-27.59	1.00 H	224	5.59	40.82
4	5350.00	32.86 AV	54.00	-21.14	1.00 H	224	-7.96	40.82
5	#10480.00	60.48 PK	68.30	-7.82	1.09 H	194	8.10	52.38
ANTENNA POLARITY & TEST DISTANCE: VERTICAL AT 3 M								
NO.	FREQ. (MHz)	EMISSION LEVEL (dBuV/m)	LIMIT (dBuV/m)	MARGIN (dB)	ANTENNA HEIGHT (m)	TABLE ANGLE (Degree)	RAW VALUE (dBuV)	CORRECTION FACTOR (dB/m)
1	*5240.00	110.91 PK			1.16 V	160	70.24	40.67
2	*5240.00	99.69 AV			1.16 V	160	59.02	40.67
3	5350.00	49.82 PK	74.00	-24.18	1.16 V	160	9.00	40.82
4	5350.00	37.21 AV	54.00	-16.79	1.16 V	160	-3.61	40.82
5	#10480.00	61.38 PK	68.30	-6.92	1.23 V	81	9.00	52.38

- REMARKS:**
1. Emission level (dBuV/m) = Raw Value (dBuV) + Correction Factor (dB/m).
 2. Correction Factor (dB/m) = Antenna Factor (dB/m) + Cable Factor (dB).
 3. The other emission levels were very low against the limit.
 4. Margin value = Emission level – Limit value.
 5. “ * “: Fundamental frequency.
 6. “#”:The radiated frequency is out the restricted band.

DRAFT 802.11n (20MHz) OFDM MODULATION

EUT TEST CONDITION		MEASUREMENT DETAIL	
CHANNEL	Channel 36	FREQUENCY RANGE	1 ~ 40GHz
INPUT POWER (SYSTEM)	120Vac, 60 Hz	DETECTOR FUNCTION	Peak (PK) Average (AV)
ENVIRONMENTAL CONDITIONS	24deg. C, 62%RH 1000hPa	TESTED BY	Match Tsui

ANTENNA POLARITY & TEST DISTANCE: HORIZONTAL AT 3 M								
NO.	FREQ. (MHz)	EMISSION LEVEL (dBuV/m)	LIMIT (dBuV/m)	MARGIN (dB)	ANTENNA HEIGHT (m)	TABLE ANGLE (Degree)	RAW VALUE (dBuV)	CORRECTION FACTOR (dB/m)
1	5150.00	49.36 PK	74.00	-24.64	1.00 H	28	8.87	40.49
2	5150.00	36.04 AV	54.00	-17.96	1.00 H	28	-4.45	40.49
3	*5180.00	100.69 PK			1.00 H	28	60.13	40.56
4	*5180.00	90.00 AV			1.00 H	28	49.44	40.56
5	#10360.00	60.32 PK	68.30	-7.98	1.00 H	360	8.21	52.11
ANTENNA POLARITY & TEST DISTANCE: VERTICAL AT 3 M								
NO.	FREQ. (MHz)	EMISSION LEVEL (dBuV/m)	LIMIT (dBuV/m)	MARGIN (dB)	ANTENNA HEIGHT (m)	TABLE ANGLE (Degree)	RAW VALUE (dBuV)	CORRECTION FACTOR (dB/m)
1	5150.00	52.20 PK	74.00	-21.80	1.49 V	282	11.71	40.49
2	5150.00	41.30 AV	54.00	-12.70	1.49 V	282	0.81	40.49
3	*5180.00	111.05 PK			1.49 V	282	70.49	40.56
4	*5180.00	100.45 AV			1.49 V	282	59.89	40.56
5	#6906.00	54.16 PK	68.30	-14.14	1.38 V	359	8.71	45.45
6	#6906.00	45.12 AV	54.00	-8.88	1.38 V	359	-0.33	45.45
7	#10360.00	61.64 PK	68.30	-6.66	1.15 V	0	9.53	52.11

- REMARKS:**
1. Emission level (dBuV/m) = Raw Value (dBuV) + Correction Factor (dB/m).
 2. Correction Factor (dB/m) = Antenna Factor (dB/m) + Cable Factor (dB).
 3. The other emission levels were very low against the limit.
 4. Margin value = Emission level – Limit value.
 5. “ * “: Fundamental frequency.
 6. “#”:The radiated frequency is out the restricted band.



A D T

EUT TEST CONDITION		MEASUREMENT DETAIL	
CHANNEL	Channel 40	FREQUENCY RANGE	1 ~ 40GHz
INPUT POWER (SYSTEM)	120Vac, 60 Hz	DETECTOR FUNCTION	Peak (PK) Average (AV)
ENVIRONMENTAL CONDITIONS	24deg. C, 62%RH 1000hPa	TESTED BY	Match Tsui

ANTENNA POLARITY & TEST DISTANCE: HORIZONTAL AT 3 M								
NO.	FREQ. (MHz)	EMISSION LEVEL (dBuV/m)	LIMIT (dBuV/m)	MARGIN (dB)	ANTENNA HEIGHT (m)	TABLE ANGLE (Degree)	RAW VALUE (dBuV)	CORRECTION FACTOR (dB/m)
1	*5200.00	99.40 PK			1.36 H	27	58.80	40.60
2	*5200.00	88.61 AV			1.36 H	27	48.01	40.60
3	#10400.00	61.18 PK	68.30	-7.12	1.10 H	10	8.91	52.27
ANTENNA POLARITY & TEST DISTANCE: VERTICAL AT 3 M								
NO.	FREQ. (MHz)	EMISSION LEVEL (dBuV/m)	LIMIT (dBuV/m)	MARGIN (dB)	ANTENNA HEIGHT (m)	TABLE ANGLE (Degree)	RAW VALUE (dBuV)	CORRECTION FACTOR (dB/m)
1	*5200.00	110.14 PK			1.08 V	27	69.54	40.60
2	*5200.00	99.58 AV			1.08 V	27	58.98	40.60
3	#10400.00	61.46 PK	68.30	-6.84	1.08 V	350	9.19	52.27

- REMARKS:**
1. Emission level (dBuV/m) = Raw Value (dBuV) + Correction Factor (dB/m).
 2. Correction Factor (dB/m) = Antenna Factor (dB/m) + Cable Factor (dB).
 3. The other emission levels were very low against the limit.
 4. Margin value = Emission level – Limit value.
 5. “ * “: Fundamental frequency.
 6. “#”:The radiated frequency is out the restricted band.



A D T

EUT TEST CONDITION		MEASUREMENT DETAIL	
CHANNEL	Channel 48	FREQUENCY RANGE	1 ~ 40GHz
INPUT POWER (SYSTEM)	120Vac, 60 Hz	DETECTOR FUNCTION	Peak (PK) Average (AV)
ENVIRONMENTAL CONDITIONS	24deg. C, 62%RH 1000hPa	TESTED BY	Match Tsui

ANTENNA POLARITY & TEST DISTANCE: HORIZONTAL AT 3 M								
NO.	FREQ. (MHz)	EMISSION LEVEL (dBuV/m)	LIMIT (dBuV/m)	MARGIN (dB)	ANTENNA HEIGHT (m)	TABLE ANGLE (Degree)	RAW VALUE (dBuV)	CORRECTION FACTOR (dB/m)
1	*5240.00	99.55 PK			1.00 H	21	58.88	40.67
2	*5240.00	88.69 AV			1.00 H	21	48.02	40.67
3	5350.00	47.00 PK	74.00	-27.00	1.00 H	21	6.18	40.82
4	5350.00	36.67 AV	54.00	-17.33	1.00 H	21	-4.15	40.82
5	#10480.00	60.98 PK	68.30	-7.32	1.00 H	0	8.60	52.38
ANTENNA POLARITY & TEST DISTANCE: VERTICAL AT 3 M								
NO.	FREQ. (MHz)	EMISSION LEVEL (dBuV/m)	LIMIT (dBuV/m)	MARGIN (dB)	ANTENNA HEIGHT (m)	TABLE ANGLE (Degree)	RAW VALUE (dBuV)	CORRECTION FACTOR (dB/m)
1	*5240.00	112.35 PK			1.04 V	216	71.68	40.67
2	*5240.00	100.99 AV			1.04 V	216	60.32	40.67
3	5350.00	47.69 PK	74.00	-26.31	1.04 V	216	6.87	40.82
4	5350.00	37.07 AV	54.00	-16.93	1.04 V	216	-3.75	40.82
5	#10480.00	61.77 PK	68.30	-6.53	1.04 V	360	9.39	52.38

- REMARKS:**
1. Emission level (dBuV/m) = Raw Value (dBuV) + Correction Factor (dB/m).
 2. Correction Factor (dB/m) = Antenna Factor (dB/m) + Cable Factor (dB).
 3. The other emission levels were very low against the limit.
 4. Margin value = Emission level – Limit value.
 5. “ * “: Fundamental frequency.
 6. “#”:The radiated frequency is out the restricted band.

DRAFT 802.11n (40MHz) OFDM MODULATION

EUT TEST CONDITION		MEASUREMENT DETAIL	
CHANNEL	Channel 38	FREQUENCY RANGE	1 ~ 40GHz
INPUT POWER (SYSTEM)	120Vac, 60 Hz	DETECTOR FUNCTION	Peak (PK) Average (AV)
ENVIRONMENTAL CONDITIONS	24deg. C, 62%RH 1000hPa	TESTED BY	Match Tsui

ANTENNA POLARITY & TEST DISTANCE: HORIZONTAL AT 3 M								
NO.	FREQ. (MHz)	EMISSION LEVEL (dBuV/m)	LIMIT (dBuV/m)	MARGIN (dB)	ANTENNA HEIGHT (m)	TABLE ANGLE (Degree)	RAW VALUE (dBuV)	CORRECTION FACTOR (dB/m)
1	5150.00	59.12 PK	74.00	-14.88	1.00 H	191	18.63	40.49
2	5150.00	39.96 AV	54.00	-14.04	1.00 H	191	-0.53	40.49
3	*5190.00	98.11 PK			1.00 H	191	57.53	40.58
4	*5190.00	85.38 AV			1.00 H	191	44.80	40.58
5	#10380.00	60.30 PK	68.30	-8.00	1.00 H	10	8.11	52.19
ANTENNA POLARITY & TEST DISTANCE: VERTICAL AT 3 M								
NO.	FREQ. (MHz)	EMISSION LEVEL (dBuV/m)	LIMIT (dBuV/m)	MARGIN (dB)	ANTENNA HEIGHT (m)	TABLE ANGLE (Degree)	RAW VALUE (dBuV)	CORRECTION FACTOR (dB/m)
1	5150.00	70.11 PK	74.00	-3.89	1.05 V	186	29.62	40.49
2	5150.00	50.56 AV	54.00	-3.44	1.05 V	186	10.07	40.49
3	*5190.00	109.50 PK			1.05 V	186	68.92	40.58
4	*5190.00	97.21 AV			1.05 V	186	56.63	40.58
5	#10380.00	60.39 PK	68.30	-7.91	1.00 V	360	8.20	52.19

- REMARKS:**
1. Emission level (dBuV/m) = Raw Value (dBuV) + Correction Factor (dB/m).
 2. Correction Factor (dB/m) = Antenna Factor (dB/m) + Cable Factor (dB).
 3. The other emission levels were very low against the limit.
 4. Margin value = Emission level – Limit value.
 5. “ * “: Fundamental frequency.
 6. “#”:The radiated frequency is out the restricted band.



A D T

EUT TEST CONDITION		MEASUREMENT DETAIL	
CHANNEL	Channel 46	FREQUENCY RANGE	1 ~ 40GHz
INPUT POWER (SYSTEM)	120Vac, 60 Hz	DETECTOR FUNCTION	Peak (PK) Average (AV)
ENVIRONMENTAL CONDITIONS	24deg. C, 62%RH 1000hPa	TESTED BY	Match Tsui

ANTENNA POLARITY & TEST DISTANCE: HORIZONTAL AT 3 M								
NO.	FREQ. (MHz)	EMISSION LEVEL (dBuV/m)	LIMIT (dBuV/m)	MARGIN (dB)	ANTENNA HEIGHT (m)	TABLE ANGLE (Degree)	RAW VALUE (dBuV)	CORRECTION FACTOR (dB/m)
1	*5230.00	98.20 PK			1.10 H	191	57.55	40.65
2	*5230.00	85.38 AV			1.10 H	191	44.73	40.65
3	5350.00	48.89 PK	74.00	-25.11	1.10 H	191	8.07	40.82
4	5350.00	37.71 AV	54.00	-16.29	1.10 H	191	-3.11	40.82
5	#10460.00	60.77 PK	68.30	-7.53	1.00 H	360	8.42	52.35
ANTENNA POLARITY & TEST DISTANCE: VERTICAL AT 3 M								
NO.	FREQ. (MHz)	EMISSION LEVEL (dBuV/m)	LIMIT (dBuV/m)	MARGIN (dB)	ANTENNA HEIGHT (m)	TABLE ANGLE (Degree)	RAW VALUE (dBuV)	CORRECTION FACTOR (dB/m)
1	*5230.00	109.66 PK			1.03 V	192	69.01	40.65
2	*5230.00	97.31 AV			1.03 V	192	56.66	40.65
3	5350.00	49.02 PK	74.00	-24.98	1.03 V	192	8.20	40.82
4	5350.00	37.83 AV	54.00	-16.17	1.03 V	192	-2.99	40.82
5	#10460.00	60.37 PK	68.30	-7.93	1.03 V	0	8.02	52.35

- REMARKS:**
1. Emission level (dBuV/m) = Raw Value (dBuV) + Correction Factor (dB/m).
 2. Correction Factor (dB/m) = Antenna Factor (dB/m) + Cable Factor (dB).
 3. The other emission levels were very low against the limit.
 4. Margin value = Emission level – Limit value.
 5. “ * “: Fundamental frequency.
 6. "#":The radiated frequency is out the restricted band.



A D T

BELOW 1GHz WORST-CASE DATA : 802.11a OFDM MODULATION

EUT TEST CONDITION		MEASUREMENT DETAIL	
CHANNEL	Channel 36	FREQUENCY RANGE	Below 1000MHz
INPUT POWER (SYSTEM)	120Vac, 60 Hz	DETECTOR FUNCTION	Quasi-Peak
ENVIRONMENTAL CONDITIONS	24deg. C, 64%RH 999hPa	TEST MODE	A
TESTED BY	Match Tsui		

ANTENNA POLARITY & TEST DISTANCE: HORIZONTAL AT 3 M								
NO.	FREQ. (MHz)	EMISSION LEVEL (dBuV/m)	LIMIT (dBuV/m)	MARGIN (dB)	ANTENNA HEIGHT (m)	TABLE ANGLE (Degree)	RAW VALUE (dBuV)	CORRECTION FACTOR (dB/m)
1	97.95	33.20 QP	43.50	-10.30	1.50 H	349	21.98	11.22
2	160.17	32.46 QP	43.50	-11.04	1.50 H	7	17.63	14.83
3	173.78	34.48 QP	43.50	-9.02	1.50 H	85	20.47	14.01
4	249.60	38.50 QP	46.00	-7.50	1.00 H	241	24.09	14.40
5	399.31	42.16 QP	46.00	-3.84	1.25 H	355	23.25	18.91
6	500.42	36.39 QP	46.00	-9.61	1.50 H	193	14.92	21.48
7	550.97	33.85 QP	46.00	-12.15	1.50 H	151	11.25	22.60
8	751.23	33.90 QP	46.00	-12.10	1.00 H	40	6.84	27.06
9	799.84	35.09 QP	46.00	-10.91	1.00 H	28	7.54	27.54
10	951.49	33.92 QP	46.00	-12.08	1.50 H	313	3.46	30.46
ANTENNA POLARITY & TEST DISTANCE: VERTICAL AT 3 M								
NO.	FREQ. (MHz)	EMISSION LEVEL (dBuV/m)	LIMIT (dBuV/m)	MARGIN (dB)	ANTENNA HEIGHT (m)	TABLE ANGLE (Degree)	RAW VALUE (dBuV)	CORRECTION FACTOR (dB/m)
1	57.12	30.77 QP	40.00	-9.23	1.00 V	313	17.48	13.29
2	97.95	35.13 QP	43.50	-8.37	1.00 V	238	23.91	11.22
3	399.31	39.30 QP	46.00	-6.70	1.00 V	316	20.39	18.91
4	500.42	36.18 QP	46.00	-9.82	1.00 V	46	14.70	21.48
5	799.84	34.47 QP	46.00	-11.53	1.50 V	4	6.93	27.54
6	875.67	33.86 QP	46.00	-12.14	1.00 V	349	4.53	29.33
7	951.49	34.32 QP	46.00	-11.68	1.00 V	73	3.86	30.46

- REMARKS:**
1. Emission level (dBuV/m) = Raw Value (dBuV) + Correction Factor (dB/m).
 2. Correction Factor (dB/m) = Antenna Factor (dB/m) + Cable Factor (dB).
 3. The other emission levels were very low against the limit.
 4. Margin value = Emission level – Limit value.



A D T

EUT TEST CONDITION		MEASUREMENT DETAIL	
CHANNEL	Channel 36	FREQUENCY RANGE	Below 1000MHz
INPUT POWER (SYSTEM)	120Vac, 60 Hz	DETECTOR FUNCTION	Quasi-Peak
ENVIRONMENTAL CONDITIONS	24deg. C, 64%RH 999hPa	TEST MODE	B
TESTED BY	Match Tsui		

ANTENNA POLARITY & TEST DISTANCE: HORIZONTAL AT 3 M								
NO.	FREQ. (MHz)	EMISSION LEVEL (dBuV/m)	LIMIT (dBuV/m)	MARGIN (dB)	ANTENNA HEIGHT (m)	TABLE ANGLE (Degree)	RAW VALUE (dBuV)	CORRECTION FACTOR (dB/m)
1	101.84	32.57 QP	43.50	-10.93	2.00 H	340	20.61	11.96
2	160.17	37.45 QP	43.50	-6.05	1.25 H	274	22.62	14.83
3	167.94	39.57 QP	43.50	-3.93	1.50 H	61	25.21	14.36
4	249.60	38.59 QP	46.00	-7.41	1.00 H	274	24.19	14.40
5	399.31	41.01 QP	46.00	-4.99	1.00 H	151	22.10	18.91
6	751.23	35.53 QP	46.00	-10.47	1.00 H	304	8.47	27.06
7	799.84	36.38 QP	46.00	-9.62	1.00 H	10	8.84	27.54
8	875.67	37.28 QP	46.00	-8.72	1.50 H	1	7.94	29.33
ANTENNA POLARITY & TEST DISTANCE: VERTICAL AT 3 M								
NO.	FREQ. (MHz)	EMISSION LEVEL (dBuV/m)	LIMIT (dBuV/m)	MARGIN (dB)	ANTENNA HEIGHT (m)	TABLE ANGLE (Degree)	RAW VALUE (dBuV)	CORRECTION FACTOR (dB/m)
1	55.18	33.91 QP	40.00	-6.09	1.50 V	178	20.57	13.34
2	64.90	32.47 QP	40.00	-7.53	1.50 V	304	19.05	13.42
3	101.84	38.83 QP	43.50	-4.67	1.50 V	214	26.87	11.96
4	162.11	33.38 QP	43.50	-10.12	1.50 V	280	18.67	14.71
5	399.31	38.56 QP	46.00	-7.44	1.25 V	37	19.66	18.91
6	751.23	35.72 QP	46.00	-10.28	1.50 V	343	8.66	27.06
7	799.84	35.21 QP	46.00	-10.79	1.25 V	10	7.67	27.54
8	951.49	35.76 QP	46.00	-10.24	1.00 V	70	5.29	30.46

- REMARKS:**
1. Emission level (dBuV/m) = Raw Value (dBuV) + Correction Factor (dB/m).
 2. Correction Factor (dB/m) = Antenna Factor (dB/m) + Cable Factor (dB).
 3. The other emission levels were very low against the limit.
 4. Margin value = Emission level – Limit value.

4.2 CONDUCTED EMISSION MEASUREMENT

4.2.1 LIMITS OF CONDUCTED EMISSION MEASUREMENT

FREQUENCY OF EMISSION (MHz)	CONDUCTED LIMIT (dB μ V)	
	Quasi-peak	Average
0.15 ~ 0.5	66 to 56	56 to 46
0.5 ~ 5	56	46
5 ~ 30	60	50

- NOTE:**
1. The lower limit shall apply at the transition frequencies.
 2. The limit decreases in line with the logarithm of the frequency in the range of 0.15 to 0.50MHz.
 3. All emanations from a class A/B digital device or system, including any network of conductors and apparatus connected thereto, shall not exceed the level of field strengths specified above.

4.2.2 TEST INSTRUMENTS

DESCRIPTION & MANUFACTURER	MODEL NO.	SERIAL NO.	DATE OF CALIBRATION	DUE DATE OF CALIBRATION
Test Receiver ROHDE & SCHWARZ	ESCS30	100291	Nov. 19, 2008	Nov. 18, 2009
RF signal cable Woken	5D-FB	Cable-HYC01-01	Jan. 04, 2008	Jan. 03, 2009
LISN ROHDE & SCHWARZ	ESH3-Z5	100312	Jun. 13, 2008	Jun. 12, 2009
V-LISN SCHWARZBECK	NNBL 8226-2	8226-142	Jun. 10, 2008	Jun. 09, 2009
Software ADT	ADT_Cond_V3	NA	NA	NA

- NOTE:**
1. The calibration interval of the above test instruments is 12 months and the calibrations are traceable to NML/ROC and NIST/USA.
 2. The test was performed in HwaYa Shielded Room 1.
 3. The VCCI Site Registration No. is C-2040.

4.2.3 TEST PROCEDURES

- a. The EUT was placed 0.4 meters from the conducting wall of the shielded room with EUT being connected to the power mains through a line impedance stabilization network (LISN). Other support units were connected to the power mains through another LISN. The two LISNs provide 50 ohm/ 50uH of coupling impedance for the measuring instrument.
- b. Both lines of the power mains connected to the EUT were checked for maximum conducted interference.
- c. The frequency range from 150kHz to 30MHz was searched. Emission levels under (Limit - 20dB) was not recorded.

4.2.4 DEVIATION FROM TEST STANDARD

No deviation.

4.2.5 TEST SETUP

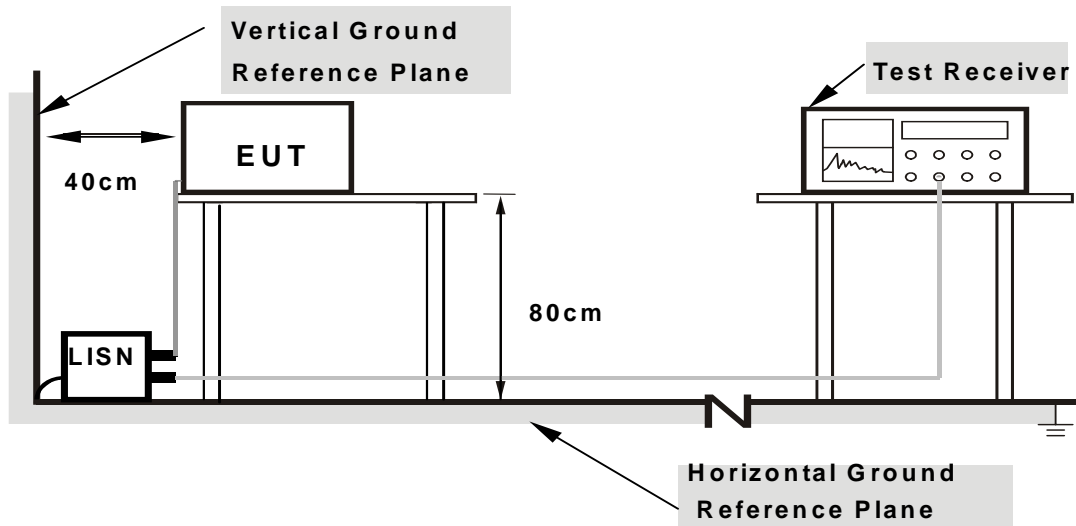

Note: 1.Support units were connected to second LISN.

2.Both of LISNs (AMN) are 80 cm from EUT and at least 80 from other units and other metal planes

For the actual test configuration, please refer to the attached file (Test Setup Photo).

4.2.6 EUT OPERATING CONDITIONS

Same as 4.1.6.



4.2.7 TEST RESULTS

CONDUCTED WORST-CASE DATA : 802.11a OFDM MODULATION

EUT TEST CONDITION		MEASUREMENT DETAIL	
CHANNEL	Channel 40	PHASE	Line 1
MODULATION TYPE	BPSK	INPUT POWER	120Vac, 60Hz
TRANSFER RATE	6Mbps	6dB BANDWIDTH	9kHz
ENVIRONMENTAL CONDITIONS	22deg. C, 60%RH, 1021hPa	TEST MODE	A
TESTED BY	Kevin Liang		

No	Freq. [MHz]	Corr. Factor (dB)	Reading Value [dB (uV)]		Emission Level [dB (uV)]		Limit [dB (uV)]		Margin (dB)	
			Q.P.	AV.	Q.P.	AV.	Q.P.	AV.	Q.P.	AV.
1	0.166	0.20	44.79	-	44.99	-	65.18	55.18	-20.19	-
2	0.224	0.20	39.28	-	39.48	-	62.66	52.66	-23.18	-
3	0.545	0.20	34.64	-	34.84	-	56.00	46.00	-21.16	-
4	0.845	0.20	31.79	-	31.99	-	56.00	46.00	-24.01	-
5	2.563	0.26	34.04	-	34.30	-	56.00	46.00	-21.70	-
6	18.094	0.93	33.37	-	34.30	-	60.00	50.00	-25.70	-

- REMARKS:**
1. Q.P. and AV. are abbreviations of quasi-peak and average individually.
 2. "-": The Quasi-peak reading value also meets average limit and measurement with the average detector is unnecessary.
 3. The emission levels of other frequencies were very low against the limit.
 4. Margin value = Emission level - Limit value
 5. Correction factor = Insertion loss + Cable loss
 6. Emission Level = Correction Factor + Reading Value.

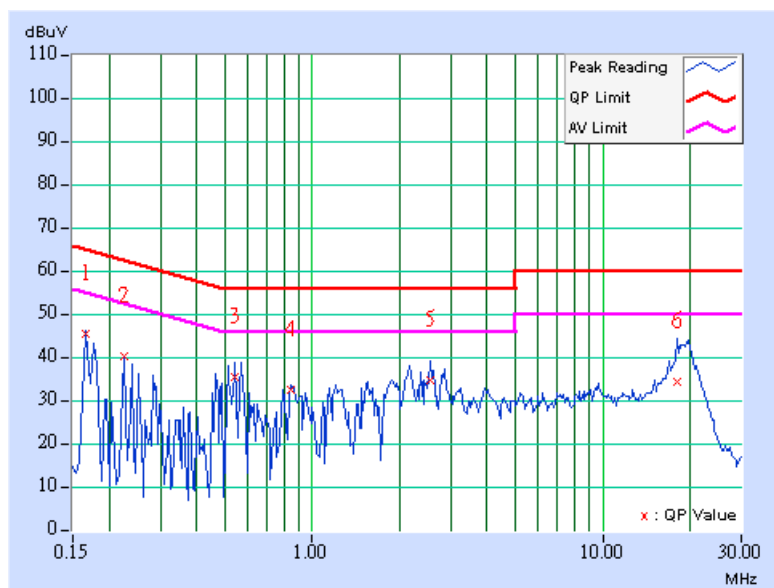

EUT TEST CONDITION		MEASUREMENT DETAIL	
CHANNEL	Channel 40	PHASE	Line 2
MODULATION TYPE	BPSK	INPUT POWER	120Vac, 60Hz
TRANSFER RATE	6Mbps	6dB BANDWIDTH	9kHz
ENVIRONMENTAL CONDITIONS	22deg. C, 60%RH, 1021hPa	TEST MODE	A
TESTED BY	Kevin Liang		

No	Freq. [MHz]	Corr. Factor (dB)	Reading Value [dB (uV)]		Emission Level [dB (uV)]		Limit [dB (uV)]		Margin (dB)	
			Q.P.	AV.	Q.P.	AV.	Q.P.	AV.	Q.P.	AV.
1	0.177	0.20	46.38	-	46.58	-	64.61	54.61	-18.03	-
2	0.241	0.20	39.89	-	40.09	-	62.06	52.06	-21.97	-
3	0.505	0.20	40.73	-	40.93	-	56.00	46.00	-15.07	-
4	0.857	0.20	31.39	-	31.59	-	56.00	46.00	-24.41	-
5	2.488	0.25	33.83	-	34.08	-	56.00	46.00	-21.92	-
6	19.316	0.51	36.65	-	37.16	-	60.00	50.00	-22.84	-

- REMARKS:**
1. Q.P. and AV. are abbreviations of quasi-peak and average individually.
 2. "-": The Quasi-peak reading value also meets average limit and measurement with the average detector is unnecessary.
 3. The emission levels of other frequencies were very low against the limit.
 4. Margin value = Emission level - Limit value
 5. Correction factor = Insertion loss + Cable loss
 6. Emission Level = Correction Factor + Reading Value.

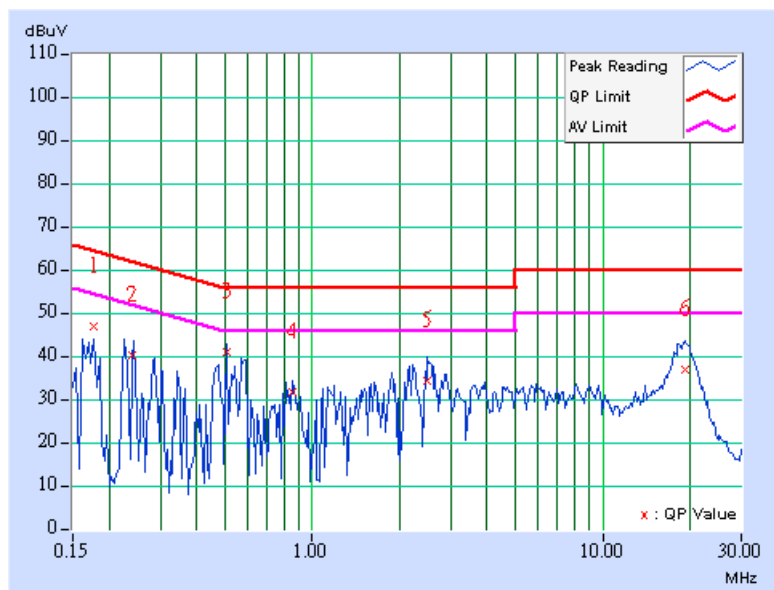

EUT TEST CONDITION		MEASUREMENT DETAIL	
CHANNEL	Channel 40	PHASE	Line 1
MODULATION TYPE	BPSK	INPUT POWER	120Vac, 60Hz
TRANSFER RATE	6Mbps	6dB BANDWIDTH	9kHz
ENVIRONMENTAL CONDITIONS	22deg. C, 60%RH, 1021hPa	TEST MODE	B
TESTED BY	Kevin Liang		

No	Freq. [MHz]	Corr. Factor (dB)	Reading Value [dB (uV)]		Emission Level [dB (uV)]		Limit [dB (uV)]		Margin (dB)	
			Q.P.	AV.	Q.P.	AV.	Q.P.	AV.	Q.P.	AV.
1	0.412	0.20	42.03	-	42.23	-	57.61	47.61	-15.38	-
2	0.759	0.20	41.43	-	41.63	-	56.00	46.00	-14.37	-
3	3.266	0.33	36.58	-	36.91	-	56.00	46.00	-19.09	-
4	4.668	0.41	41.83	-	42.24	-	56.00	46.00	-13.76	-
5	9.328	0.52	47.46	-	47.98	-	60.00	50.00	-12.02	-
6	17.070	0.89	50.11	36.47	51.00	37.36	60.00	50.00	-9.00	-12.64

- REMARKS:**
1. Q.P. and AV. are abbreviations of quasi-peak and average individually.
 2. "-": The Quasi-peak reading value also meets average limit and measurement with the average detector is unnecessary.
 3. The emission levels of other frequencies were very low against the limit.
 4. Margin value = Emission level - Limit value
 5. Correction factor = Insertion loss + Cable loss
 6. Emission Level = Correction Factor + Reading Value.

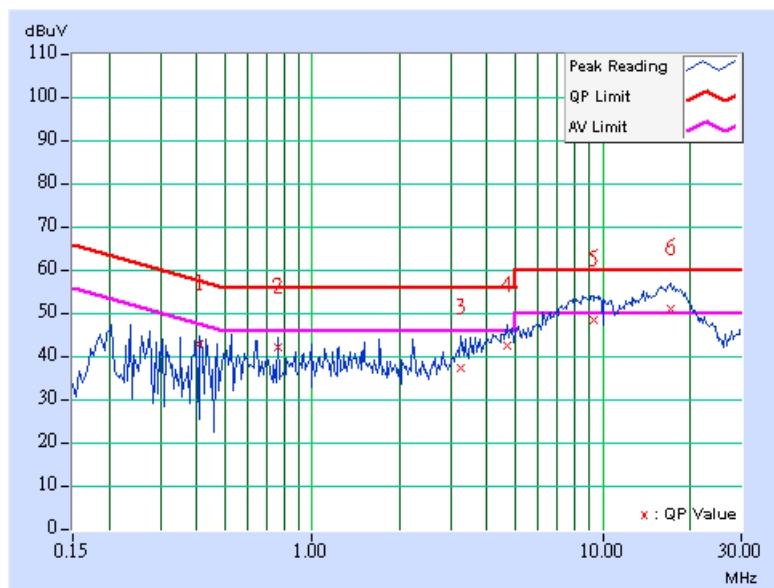



EUT TEST CONDITION		MEASUREMENT DETAIL	
CHANNEL	Channel 40	PHASE	Line 2
MODULATION TYPE	BPSK	INPUT POWER	120Vac, 60Hz
TRANSFER RATE	6Mbps	6dB BANDWIDTH	9kHz
ENVIRONMENTAL CONDITIONS	22deg. C, 60%RH, 1021hPa	TEST MODE	B
TESTED BY	Kevin Liang		

No	Freq. [MHz]	Corr. Factor (dB)	Reading Value [dB (uV)]		Emission Level [dB (uV)]		Limit [dB (uV)]		Margin (dB)	
			Q.P.	AV.	Q.P.	AV.	Q.P.	AV.	Q.P.	AV.
1	0.412	0.20	42.41	-	42.61	-	57.61	47.61	-15.00	-
2	0.646	0.20	42.19	-	42.39	-	56.00	46.00	-13.61	-
3	2.801	0.28	35.57	-	35.85	-	56.00	46.00	-20.15	-
4	5.578	0.43	40.53	-	40.96	-	60.00	50.00	-19.04	-
5	8.270	0.49	48.04	-	48.53	-	60.00	50.00	-11.47	-
6	17.297	0.50	50.50	37.50	51.00	38.00	60.00	50.00	-9.00	-12.00

- REMARKS:**
1. Q.P. and AV. are abbreviations of quasi-peak and average individually.
 2. "-": The Quasi-peak reading value also meets average limit and measurement with the average detector is unnecessary.
 3. The emission levels of other frequencies were very low against the limit.
 4. Margin value = Emission level - Limit value
 5. Correction factor = Insertion loss + Cable loss
 6. Emission Level = Correction Factor + Reading Value.

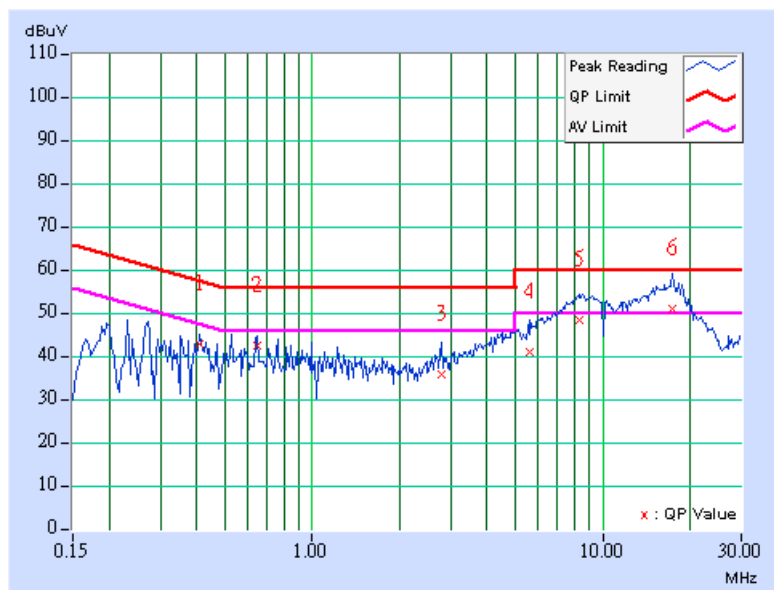

4.3 PEAK TRANSMIT POWER MEASUREMENT

4.3.1 LIMITS OF PEAK TRANSMIT POWER MEASUREMENT

FREQUENCY BAND	LIMIT
5.15 ~ 5.25GHz	The lesser of 50mW (17dBm) or 4dBm + 10logB

NOTE: Where B is the 26dB emission bandwidth in MHz.

4.3.2 TEST INSTRUMENTS

DESCRIPTION & MANUFACTURER	MODEL NO.	SERIAL NO.	DATE OF CALIBRATION	CALIBRATED UNTIL
High Speed Peak Power Meter	ML2495A	0824012	Aug. 04, 2008	Aug. 03, 2009
Power Sensor	MA2444B	0738138	Aug. 04, 2008	Aug. 03, 2009

NOTE:

1. The calibration interval of the above test instruments is 12 months and the calibrations are traceable to NML/ROC and NIST/USA.
2. Measurement Bandwidth of ML2495A is 65MHz greater than 26dB bandwidth of emission.

4.3.3 TEST PROCEDURE

A power sensor was used on the output port of the EUT. A power meter was used to read the response of the power sensor. Record the power level.

4.3.4 DEVIATION FROM TEST STANDARD

No deviation.

4.3.5 TEST SETUP

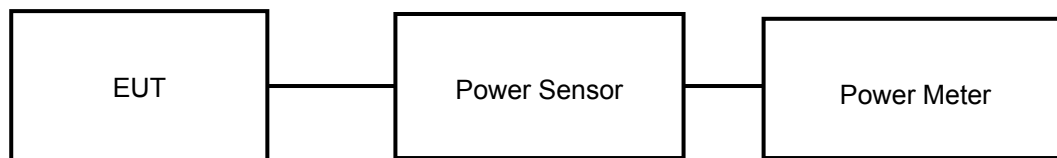

4.3.6 EUT OPERATING CONDITIONS

The software provided by client to enable the EUT under transmission condition continuously at specific channel frequencies individually.

4.3.7 TEST RESULTS

PEAK POWER OUTPUT: 802.11a OFDM MODULATION

MODULATION TYPE	BPSK	TRANSFER RATE	6.0Mbps
INPUT POWER	120Vac, 60Hz	ENVIRONMENTAL CONDITIONS	25 deg.C, 65 %RH, 1021hPa
TESTED BY	Match Tsui		

CHAN.	CHAN. FREQ. (MHz)	PEAK POWER OUTPUT (dBm)		TOTAL PEAK POWER (mW)	TOTAL PEAK POWER (dBm)	PEAK POWER LIMIT (dBm)	PASS / FAIL
		CHAIN 0	CHAIN 1				
36	5180	12.56	14.03	43.323	16.37	30	PASS
40	5200	12.61	14.08	43.825	16.42	30	PASS
48	5240	12.53	14.04	43.257	16.36	30	PASS

DRAFT 802.11n (20MHz) OFDM MODULATION

MODULATION TYPE	BPSK	TRANSFER RATE	7.2Mbps
INPUT POWER	120Vac, 60Hz	ENVIRONMENTAL CONDITIONS	23 deg.C, 66 %RH, 1021hPa
TESTED BY	Match Tsui		

CHAN.	CHAN. FREQ. (MHz)	PEAK POWER OUTPUT (dBm)		TOTAL PEAK POWER (mW)	TOTAL PEAK POWER (dBm)	PEAK POWER LIMIT (dBm)	PASS / FAIL
		CHAIN 0	CHAIN 1				
36	5180	12.53	14.03	43.199	16.35	30	PASS
40	5200	12.59	13.56	40.854	16.11	30	PASS
48	5240	12.55	13.52	40.479	16.07	30	PASS



DRAFT 802.11n (40MHz) OFDM MODULATION

MODULATION TYPE	BPSK	TRANSFER RATE	15.0Mbps
INPUT POWER	120Vac, 60Hz	ENVIRONMENTAL CONDITIONS	23 deg.C, 66 %RH, 1021hPa
TESTED BY	Match Tsui		

CHAN.	CHAN. FREQ. (MHz)	PEAK POWER OUTPUT (dBm)		TOTAL PEAK POWER (mW)	TOTAL PEAK POWER (dBm)	PEAK POWER LIMIT (dBm)	PASS / FAIL
		CHAIN 0	CHAIN 1				
38	5190	11.57	13.09	34.725	15.41	30	PASS
46	5230	11.53	13.04	34.361	15.36	30	PASS



A D T

26dB OCCUPIED BANDWIDTH: 802.11a OFDM MODULATION

MODULATION TYPE	BPSK	TRANSFER RATE	6.0Mbps
INPUT POWER	120Vac, 60Hz	ENVIRONMENTAL CONDITIONS	23 deg.C, 66 %RH, 1021hPa
TESTED BY	Match Tsui		

CHANNEL	CHANNEL FREQUENCY (MHz)	26dBc OCCUPIED BANDWIDTH (MHz)		PASS / FAIL
		CHAIN 0	CHAIN 1	
36	5180	23.66	23.74	PASS
40	5200	24.39	23.73	PASS
48	5240	24.54	24.21	PASS



A D T

FOR CHAIN 0: CH 36

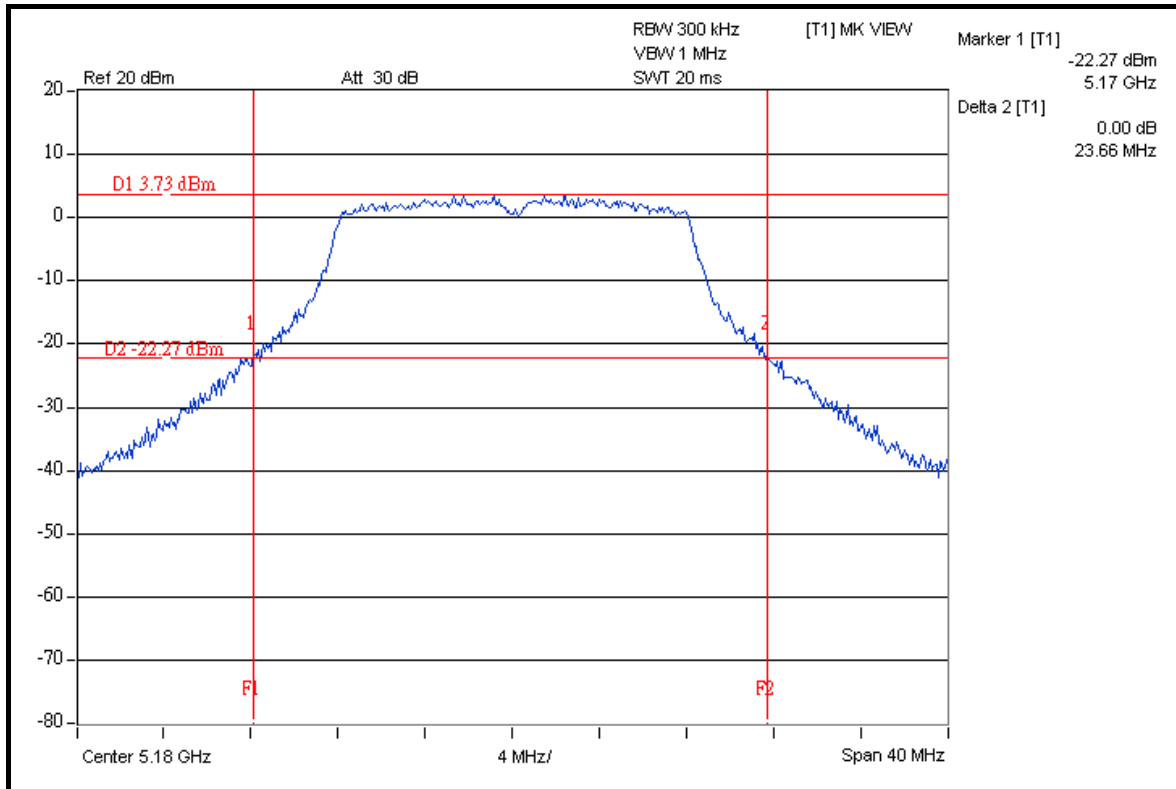

CH 40

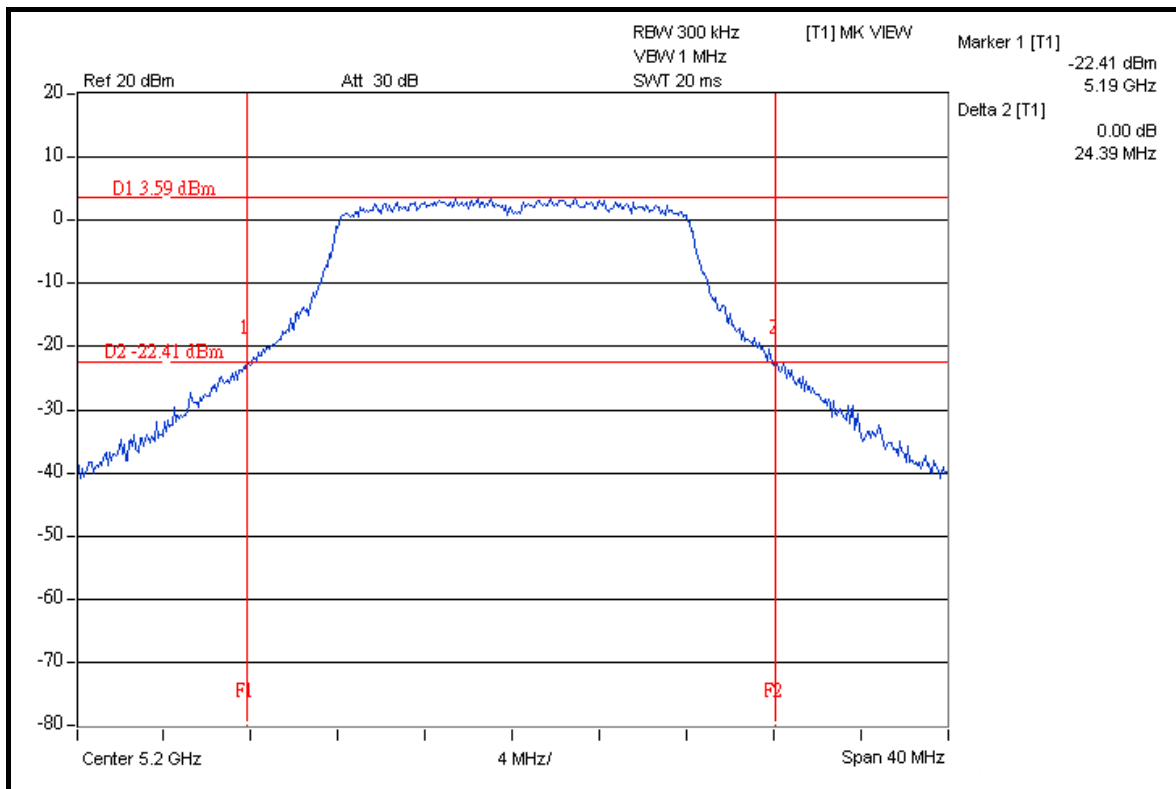



A D T

CH 48

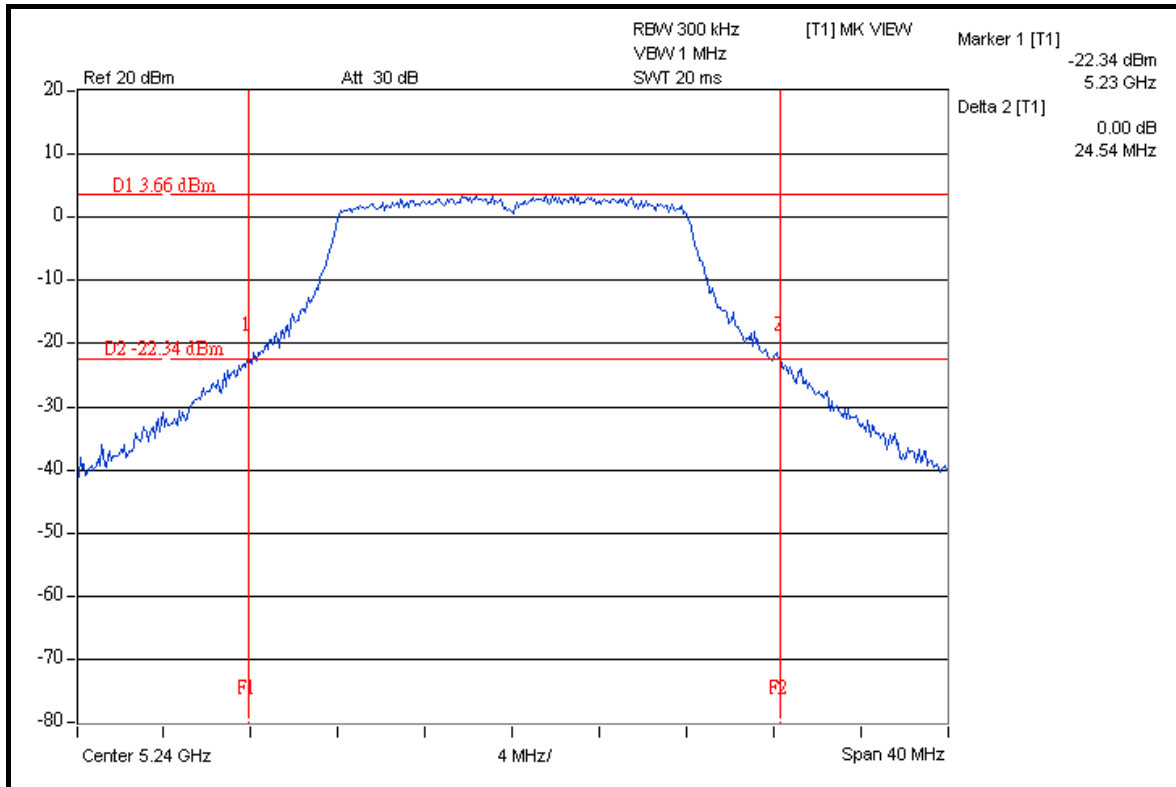

FOR CHAIN 1: CH 36

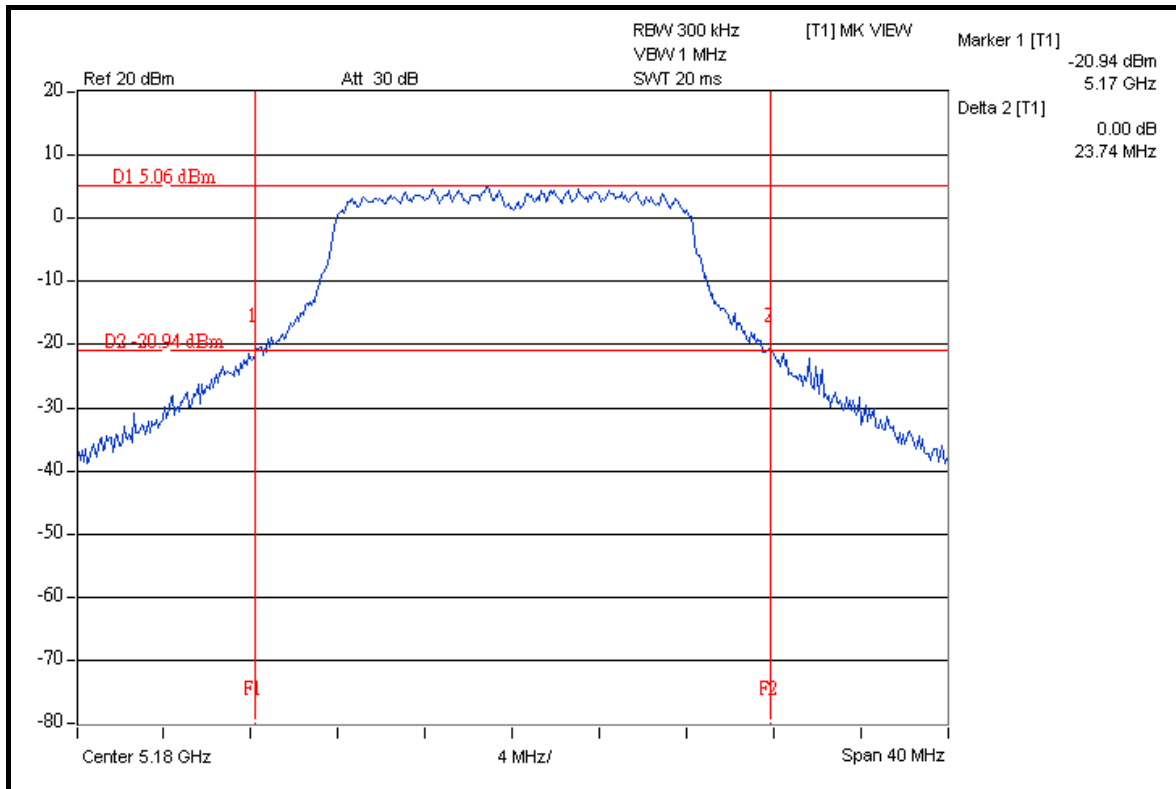



A D T

CH 40

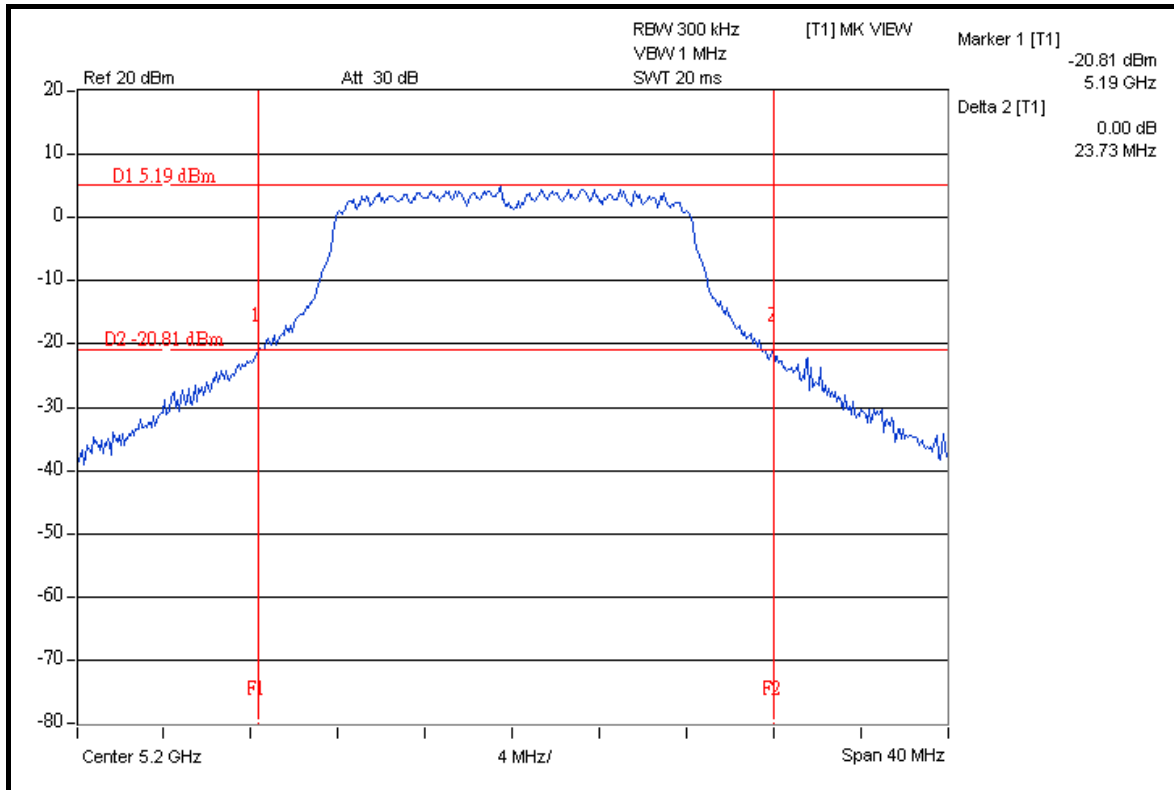

CH 48

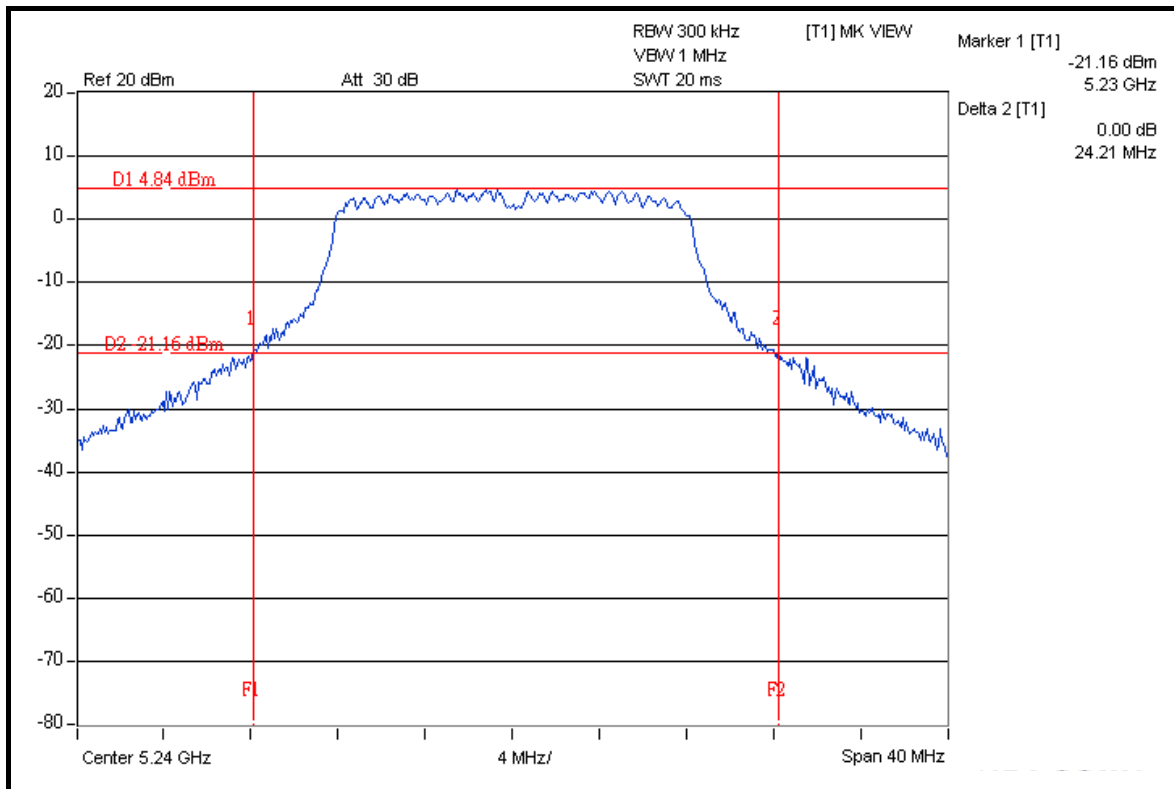



A D T

DRAFT 802.11n (20MHz) OFDM MODULATION

MODULATION TYPE	BPSK	TRANSFER RATE	7.2Mbps
INPUT POWER	120Vac, 60Hz	ENVIRONMENTAL CONDITIONS	23 deg.C, 66 %RH, 1021hPa
TESTED BY	Match Tsui		

CHANNEL	CHANNEL FREQUENCY (MHz)	26dBc OCCUPIED BANDWIDTH (MHz)		PASS / FAIL
		CHAIN 0	CHAIN 1	
36	5180	24.64	25.72	PASS
40	5200	24.85	25.59	PASS
48	5240	25.18	25.56	PASS



A D T

FOR CHAIN 0: CH 36

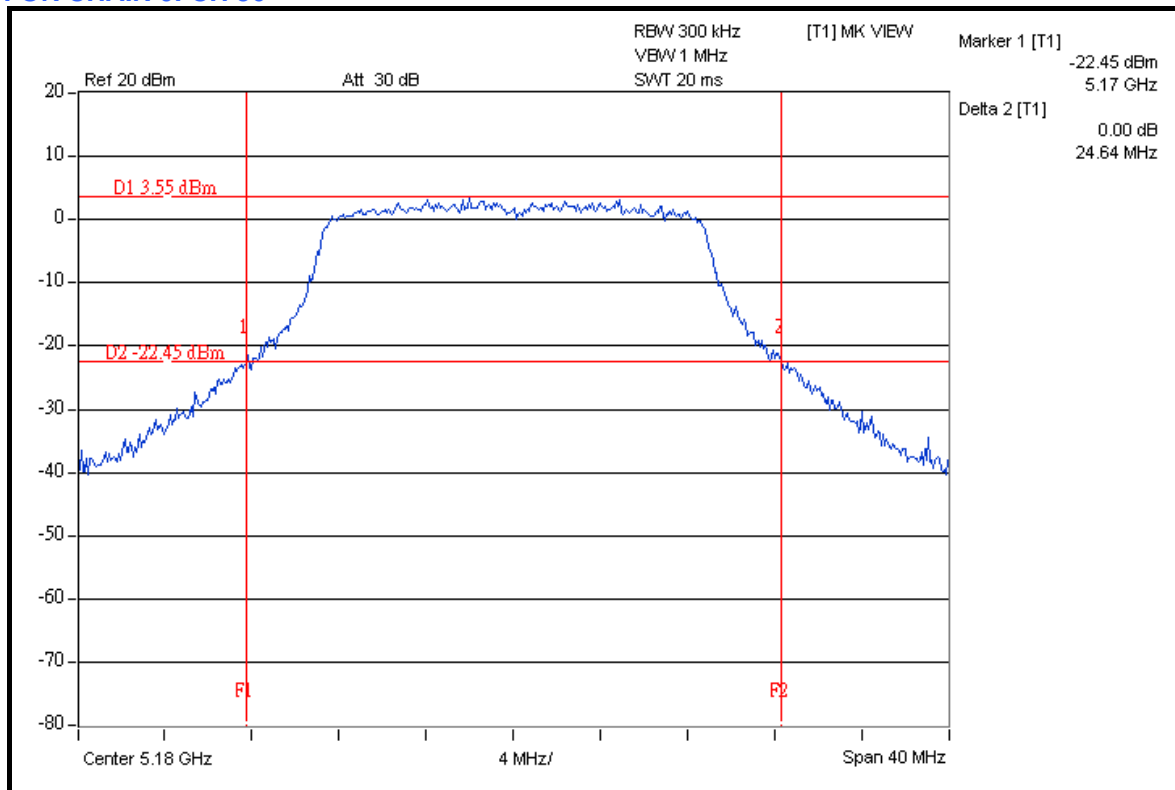

CH 40

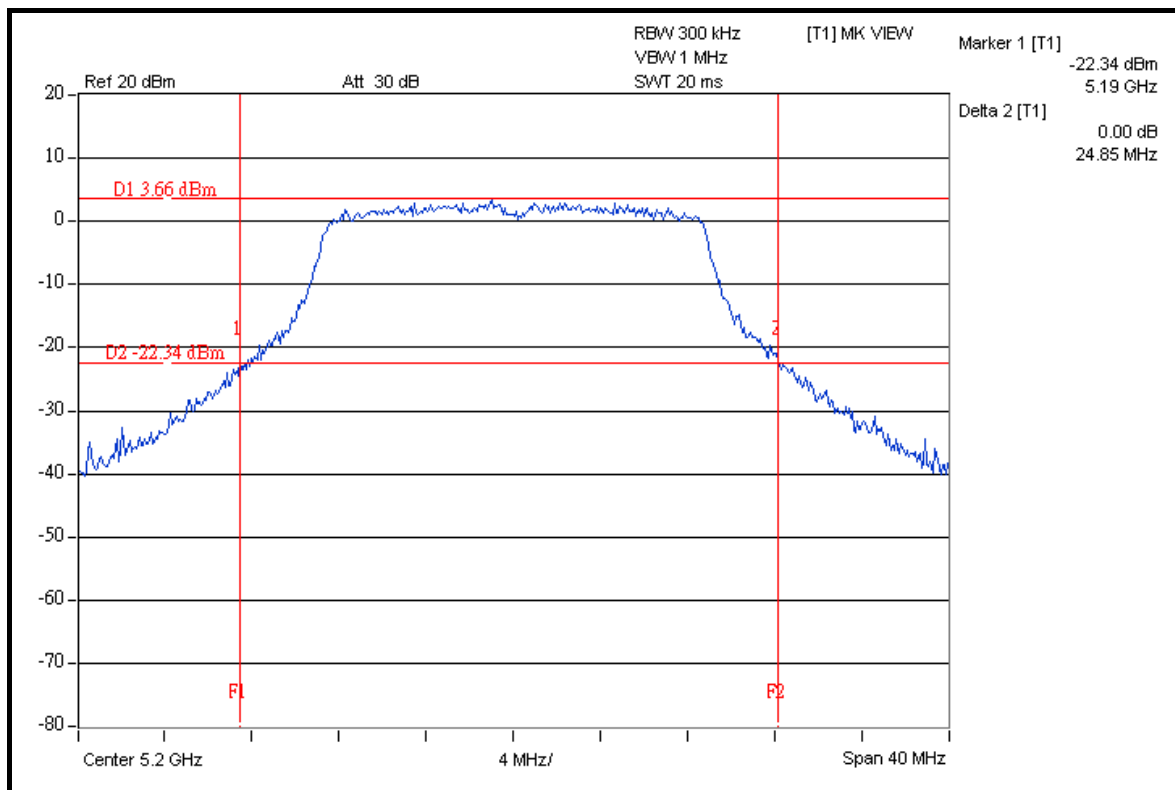



A D T

CH 48

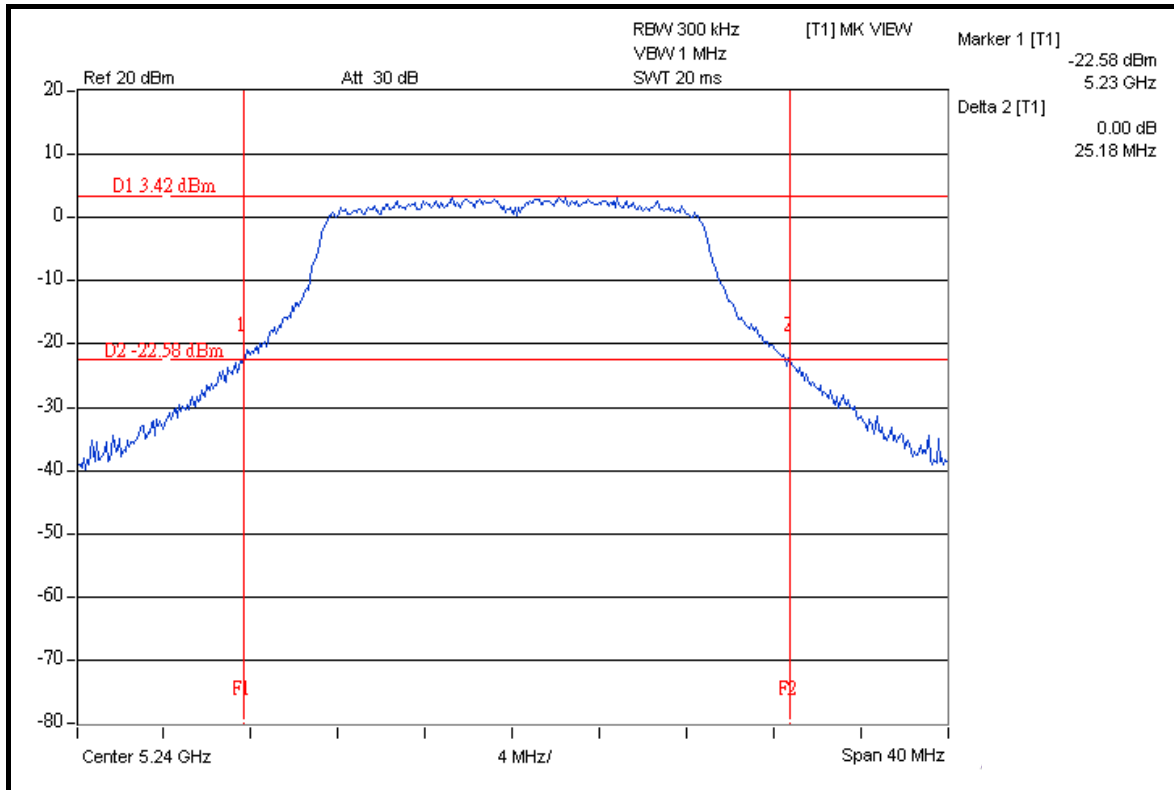

FOR CHAIN 1: CH 36

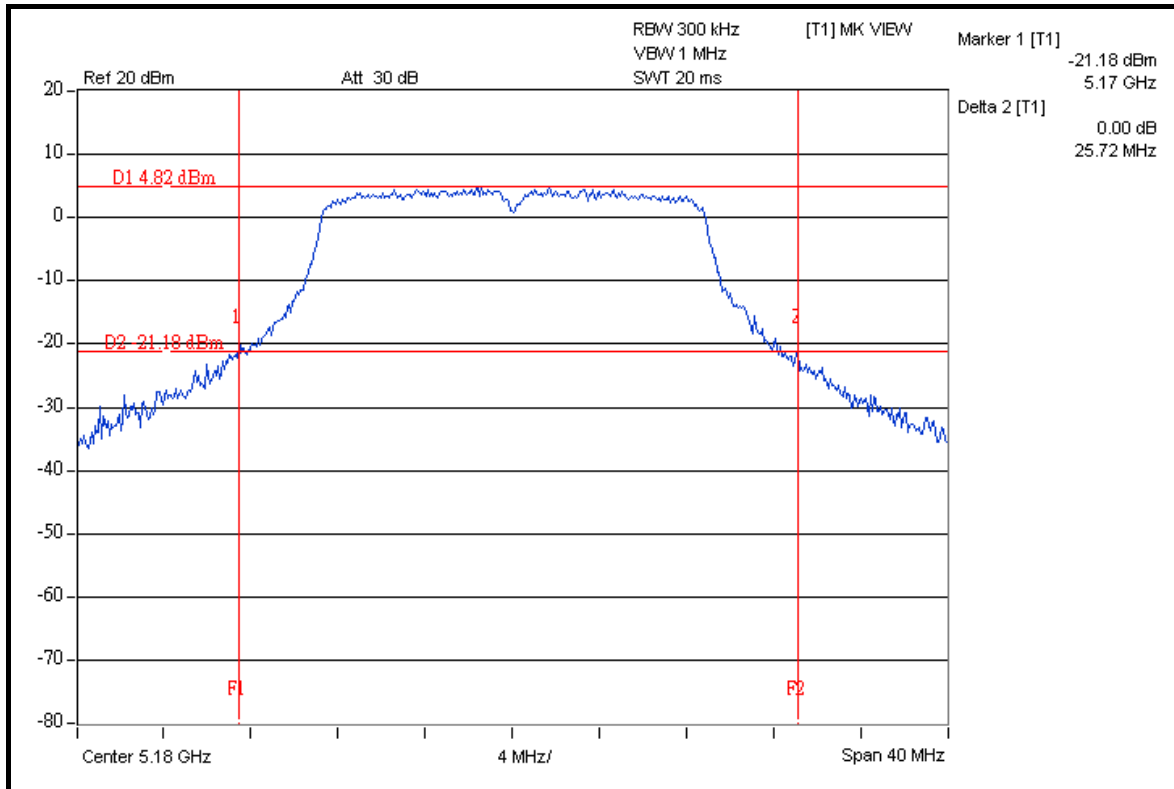



A D T

CH 40

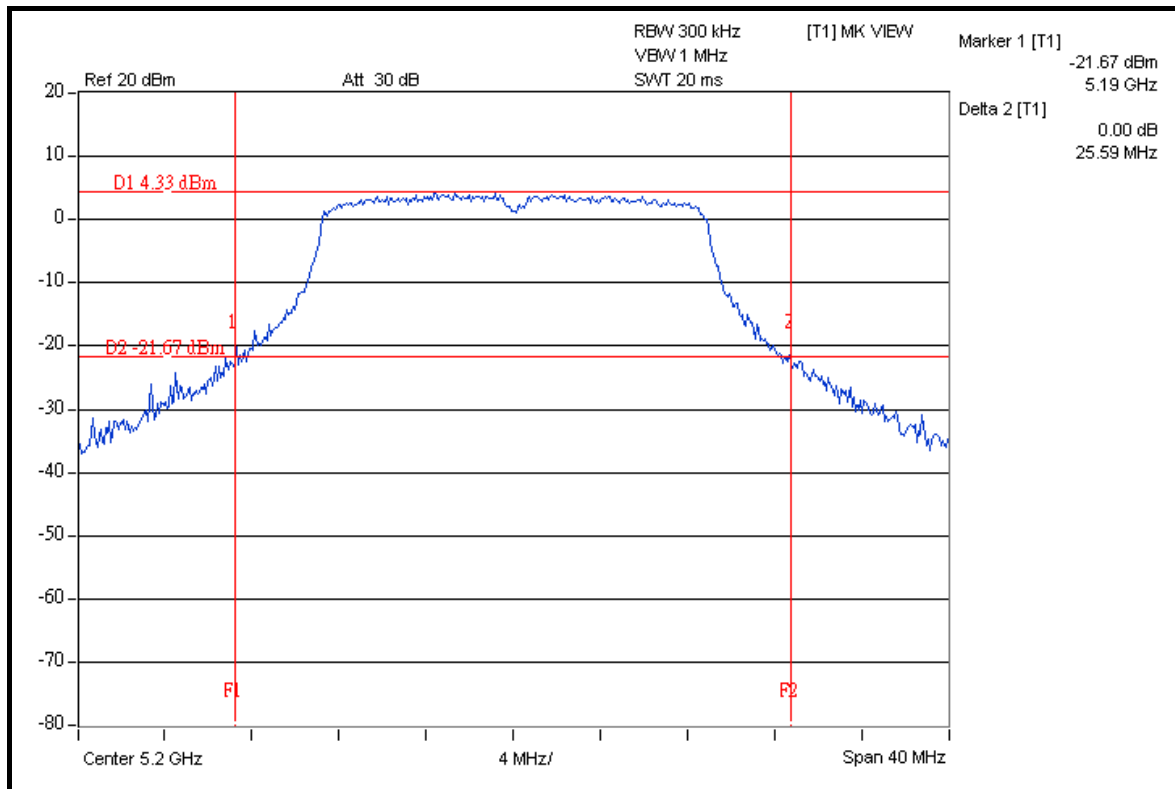

CH 48

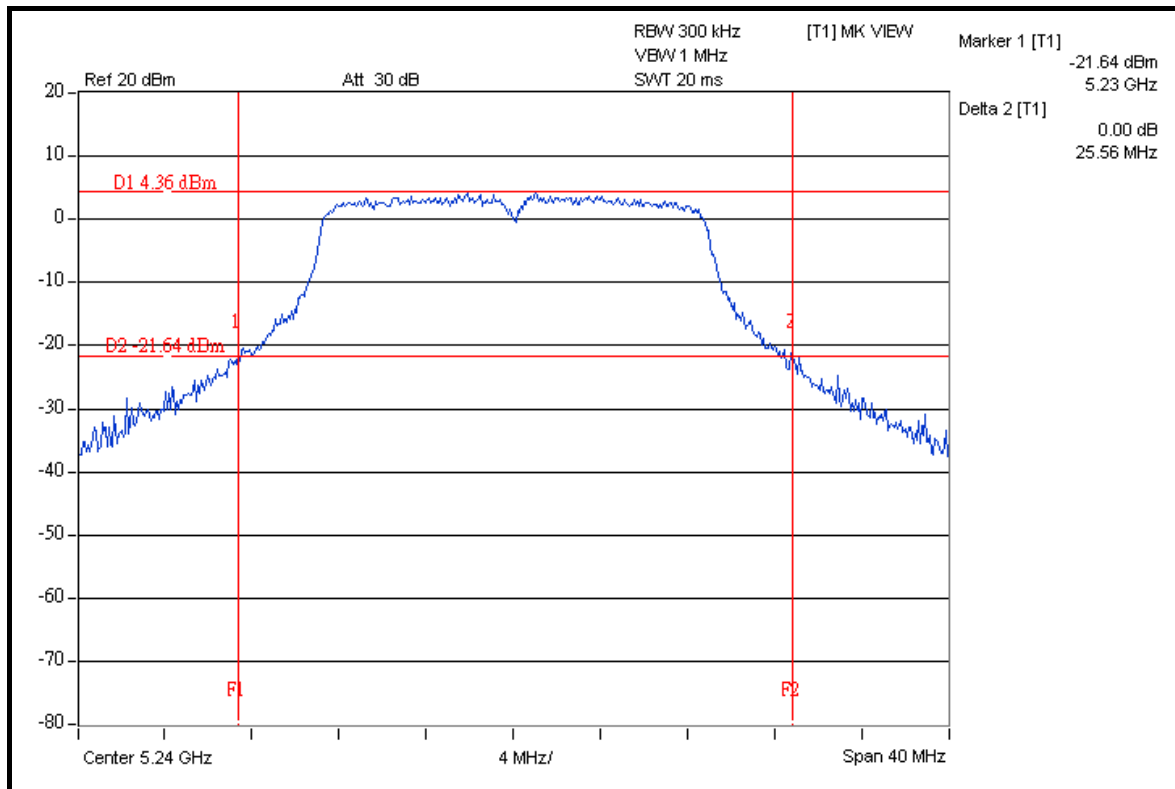



DRAFT 802.11n (40MHz) OFDM MODULATION

MODULATION TYPE	BPSK	TRANSFER RATE	15.0Mbps
INPUT POWER	120Vac, 60Hz	ENVIRONMENTAL CONDITIONS	23 deg.C, 66 %RH, 1021hPa
TESTED BY	Match Tsui		

CHANNEL	CHANNEL FREQUENCY (MHz)	26dBc OCCUPIED BANDWIDTH (MHz)		PASS / FAIL
		CHAIN 0	CHAIN 1	
38	5190	46.19	46.28	PASS
46	5230	46.38	45.94	PASS



A D T

FOR CHAIN 0: CH 38

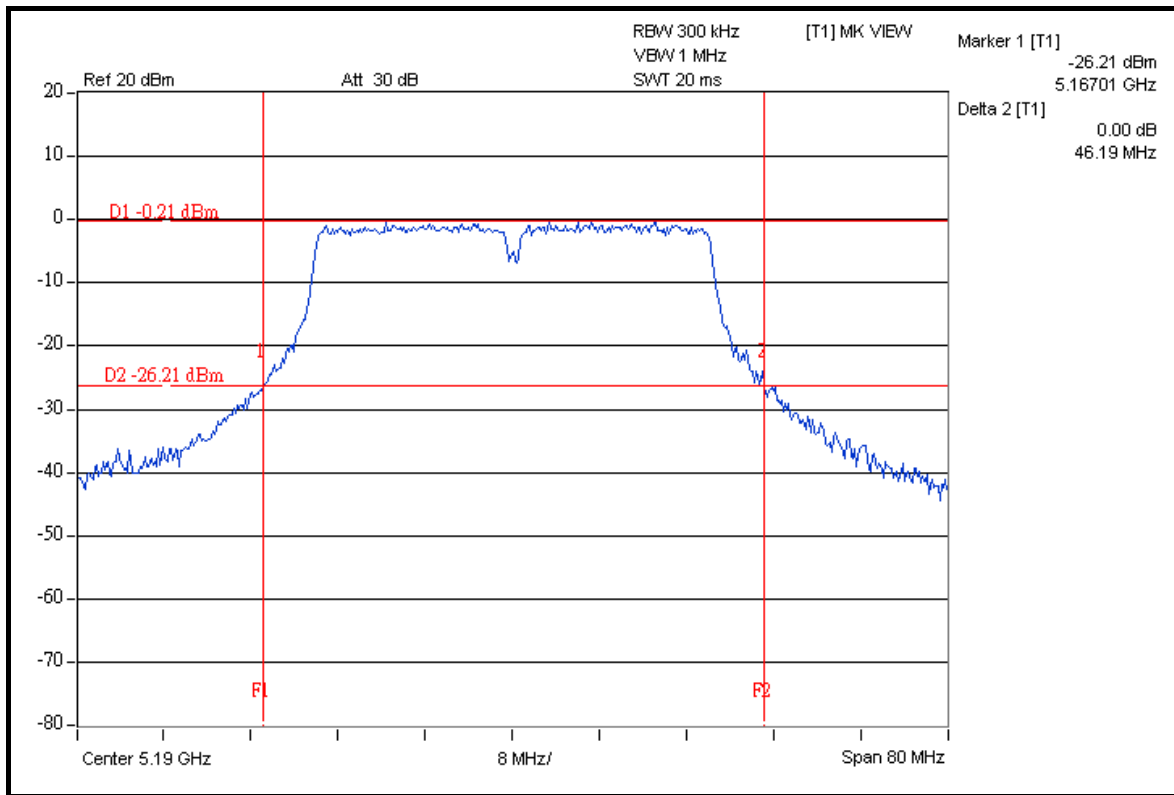

CH 46

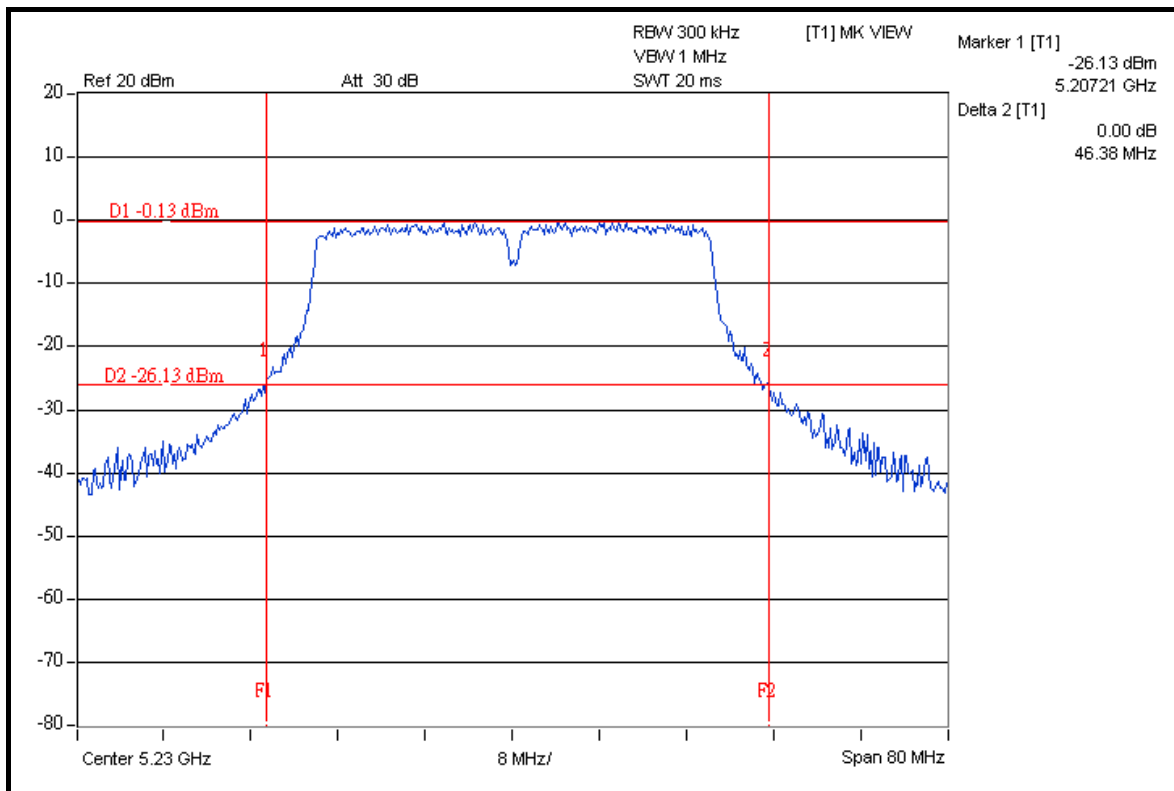



A D T

FOR CHAIN 1: CH 38

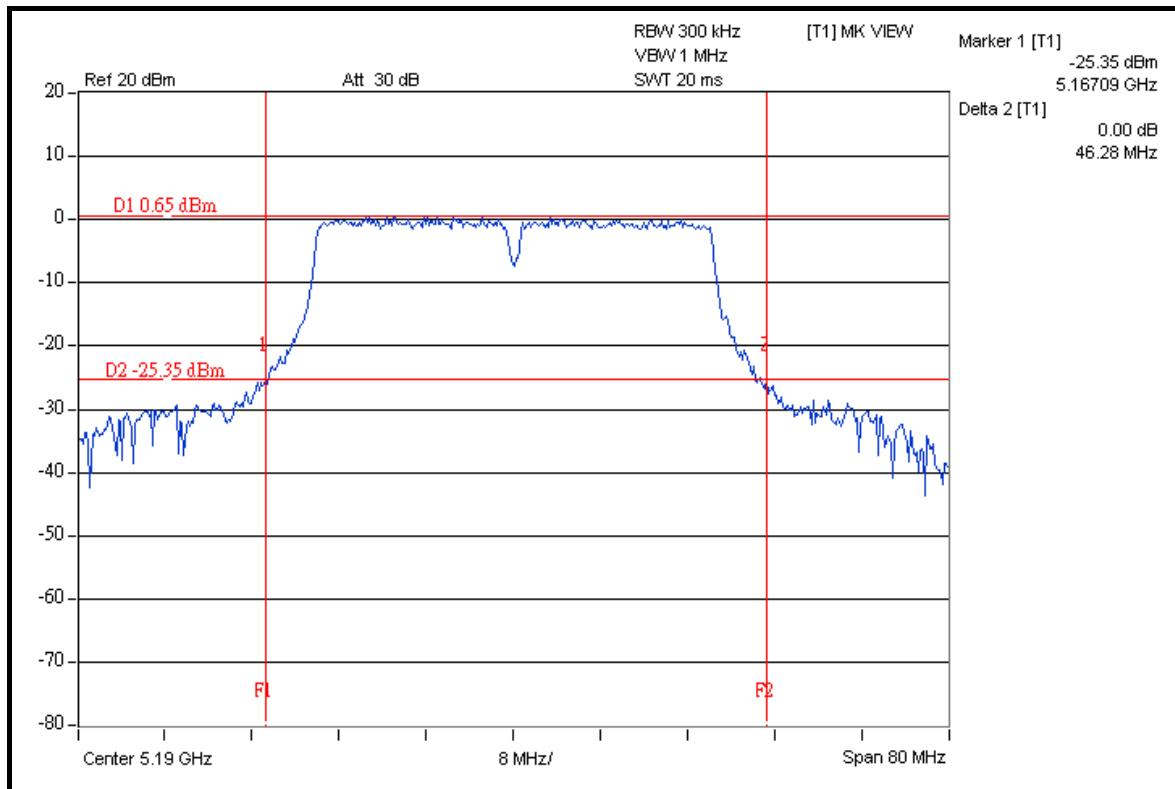

CH 46

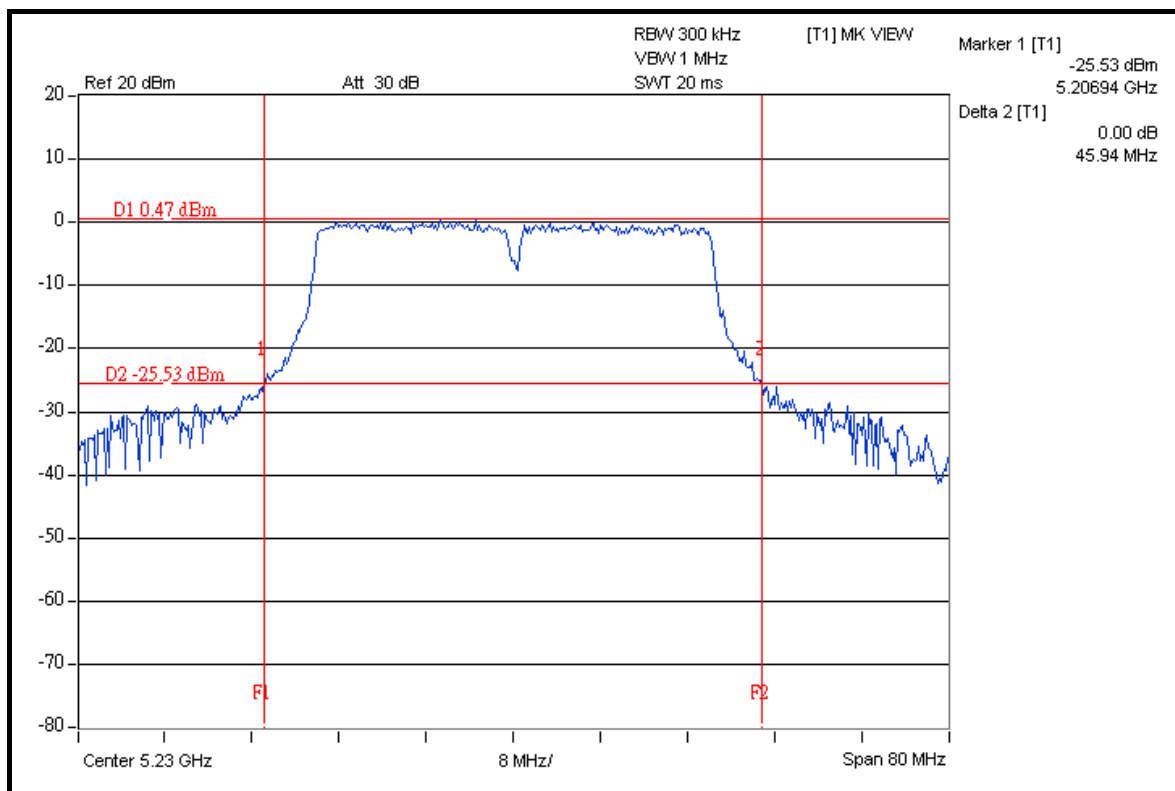

4.4 PEAK POWER EXCURSION MEASUREMENT

4.4.1 LIMITS OF PEAK POWER EXCURSION MEASUREMENT

FREQUENCY BAND	LIMIT
5.15 ~ 5.25GHz	13dB

4.4.2 TEST INSTRUMENTS

DESCRIPTION & MANUFACTURER	MODEL NO.	SERIAL NO.	DATE OF CALIBRATION	CALIBRATED UNTIL
R&S SPECTRUM ANALYZER	FSP40	100041	Apr. 22, 2008	Apr. 21, 2009

NOTE: The calibration interval of the above test instruments is 12 months and the calibrations are traceable to NML/ROC and NIST/USA.

4.4.3 TEST PROCEDURE

- a. The transmitter output was connected to the spectrum analyzer.
- b. Set the spectrum bandwidth span to view the entire spectrum.
- c. Using peak detector and Max-hold function for Trace 1 (RB = 1MHz, VB = 3MHz) and 2 (RB = 1MHz, VB = 300kHz).
- d. The differences between Trace1 and Trace 2 in any 1MHz band at f1 to f2 range were recorded and showed to another trace.

4.4.4 DEVIATION FROM TEST STANDARD

No deviation.

4.4.5 TEST SETUP

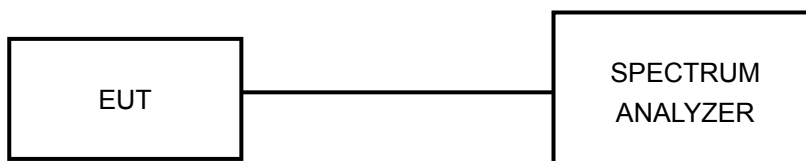

4.4.6 EUT OPERATING CONDITIONS

The software provided by client to enable the EUT under transmission condition continuously at specific channel frequencies individually.

4.4.7 TEST RESULTS

802.11a OFDM MODULATION

MODULATION TYPE	BPSK	TRANSFER RATE	6.0Mbps
INPUT POWER	120Vac, 60Hz	ENVIRONMENTAL CONDITIONS	23 deg.C, 66 %RH, 1021hPa
TESTED BY	Match Tsui		

CHANNEL	CHANNEL FREQUENCY (MHz)	PEAK POWER EXCURSION (dB)		PEAK to AVERAGE EXCURSION LIMIT (dB)	PASS/FAIL
		CHAIN 0	CHAIN 1		
36	5180	8.05	7.82	13	PASS
40	5200	7.73	7.48	13	PASS
48	5240	8.51	8.38	13	PASS



A D T

FOR CHAIN 0: CH 36

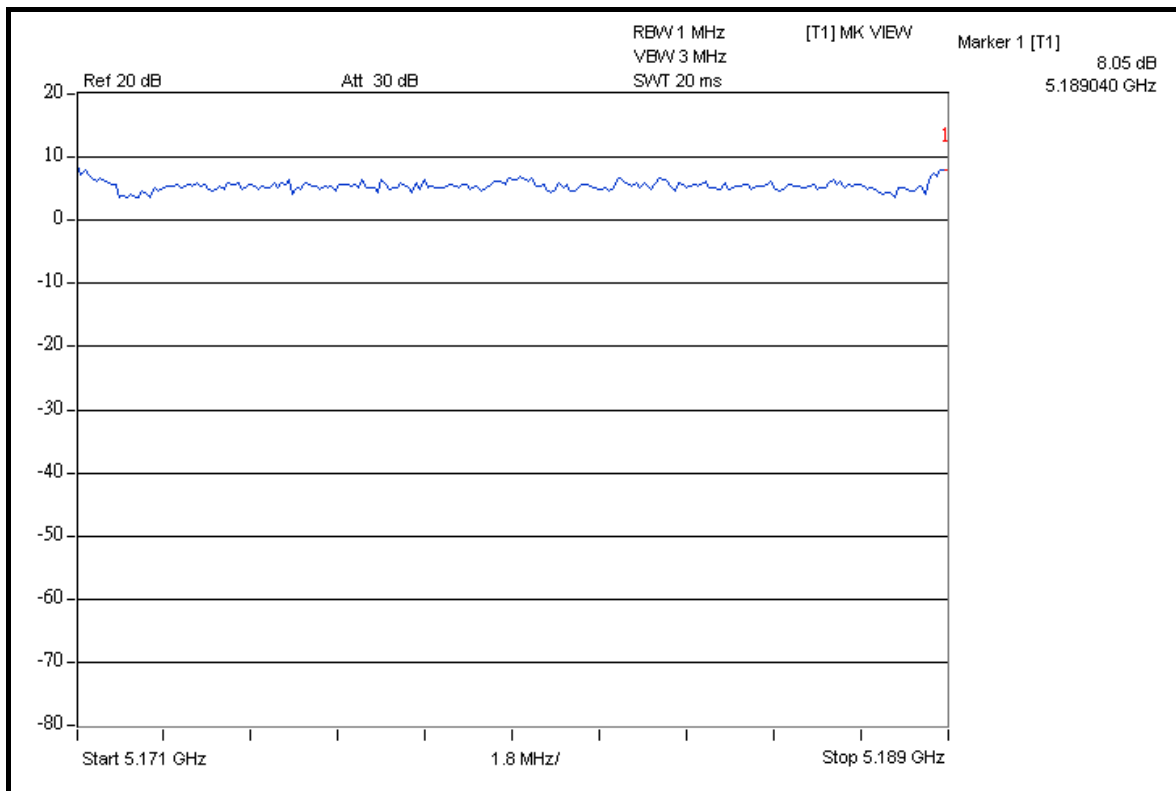
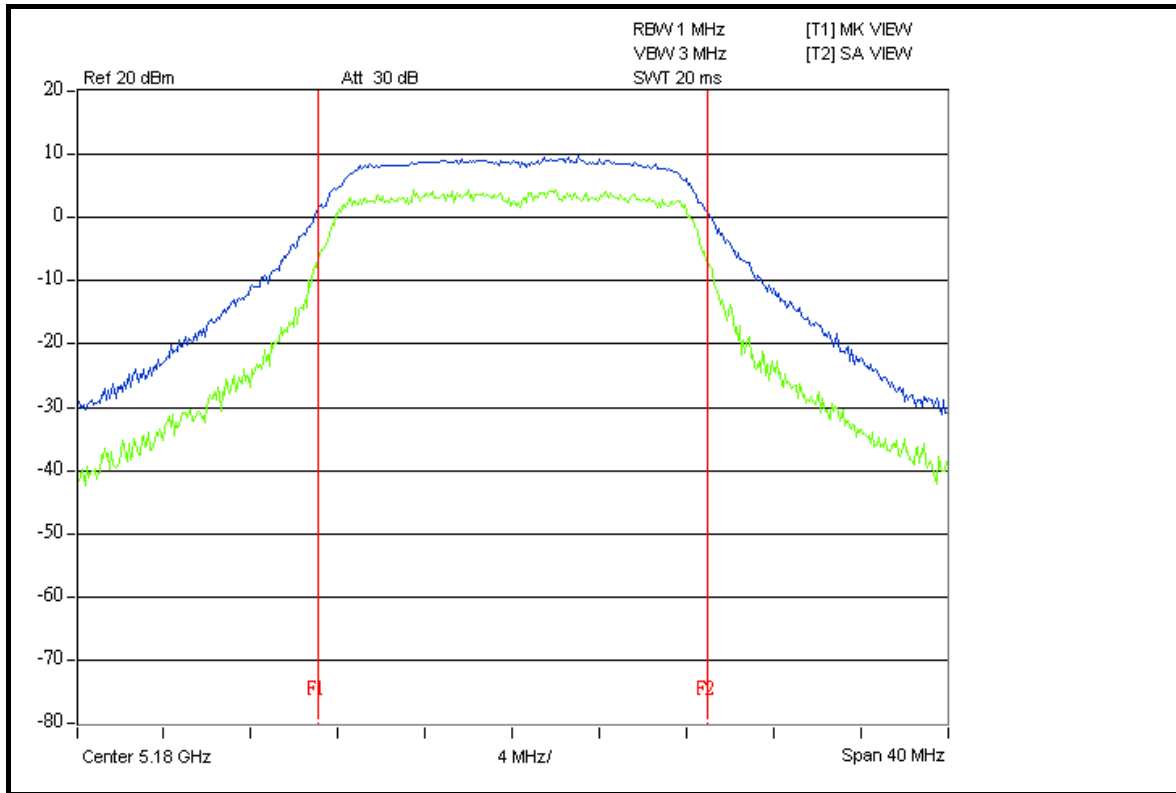



A D T

CH 40

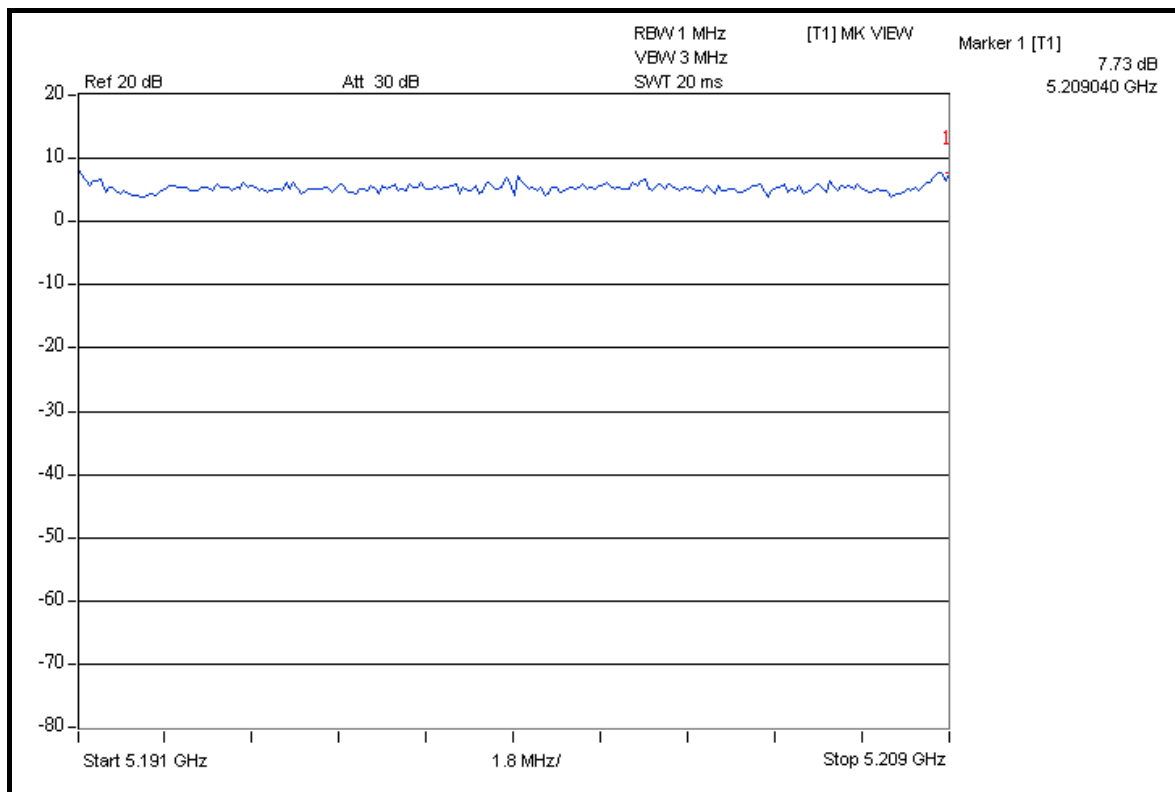
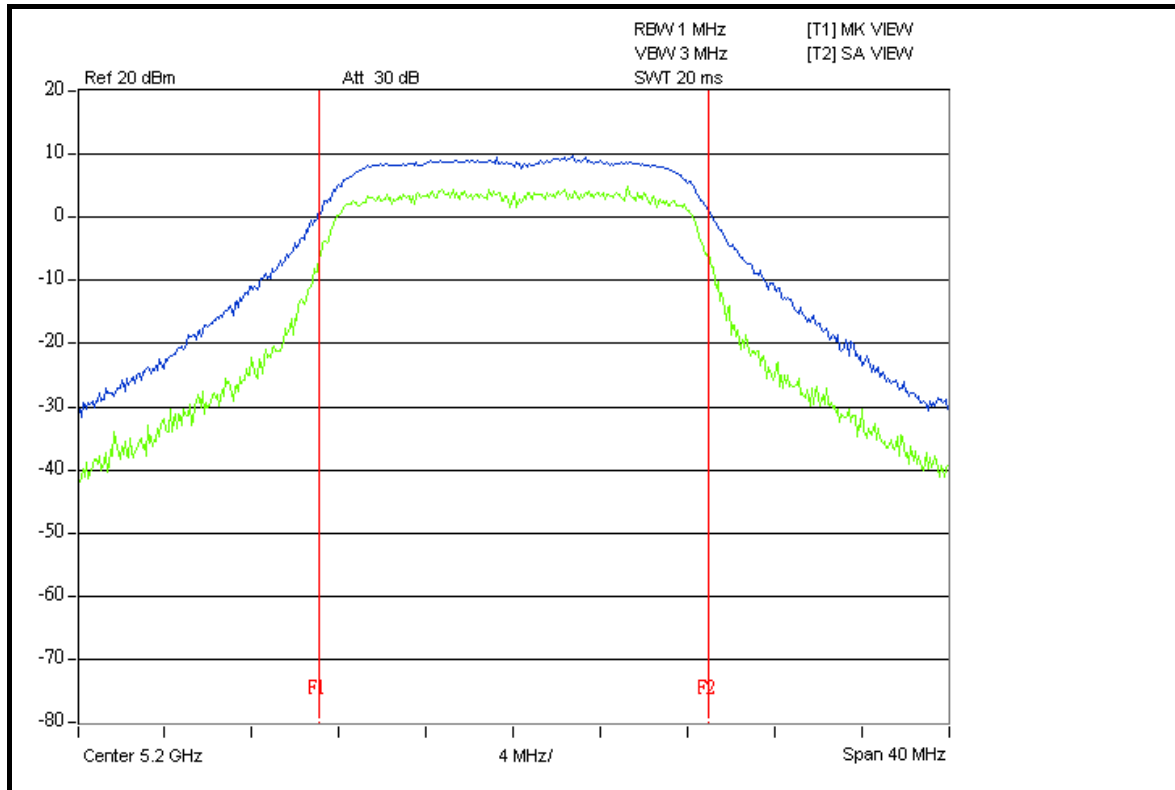



A D T

CH 48

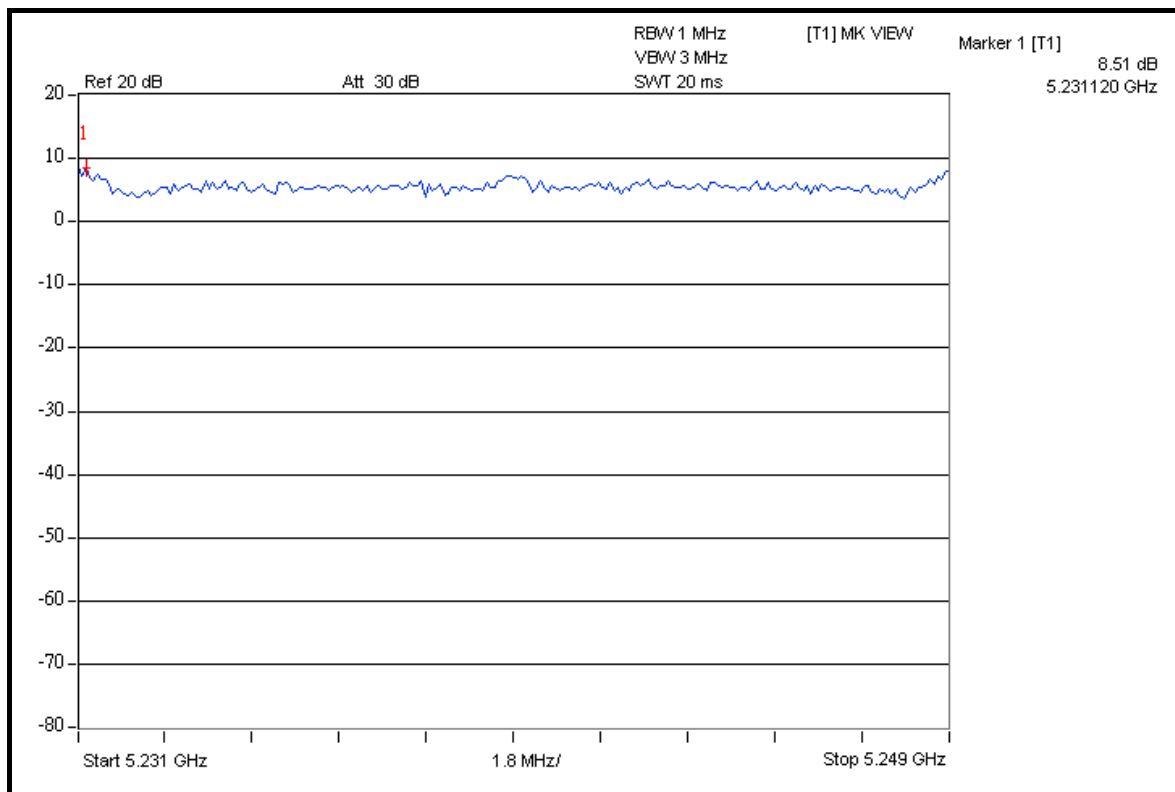
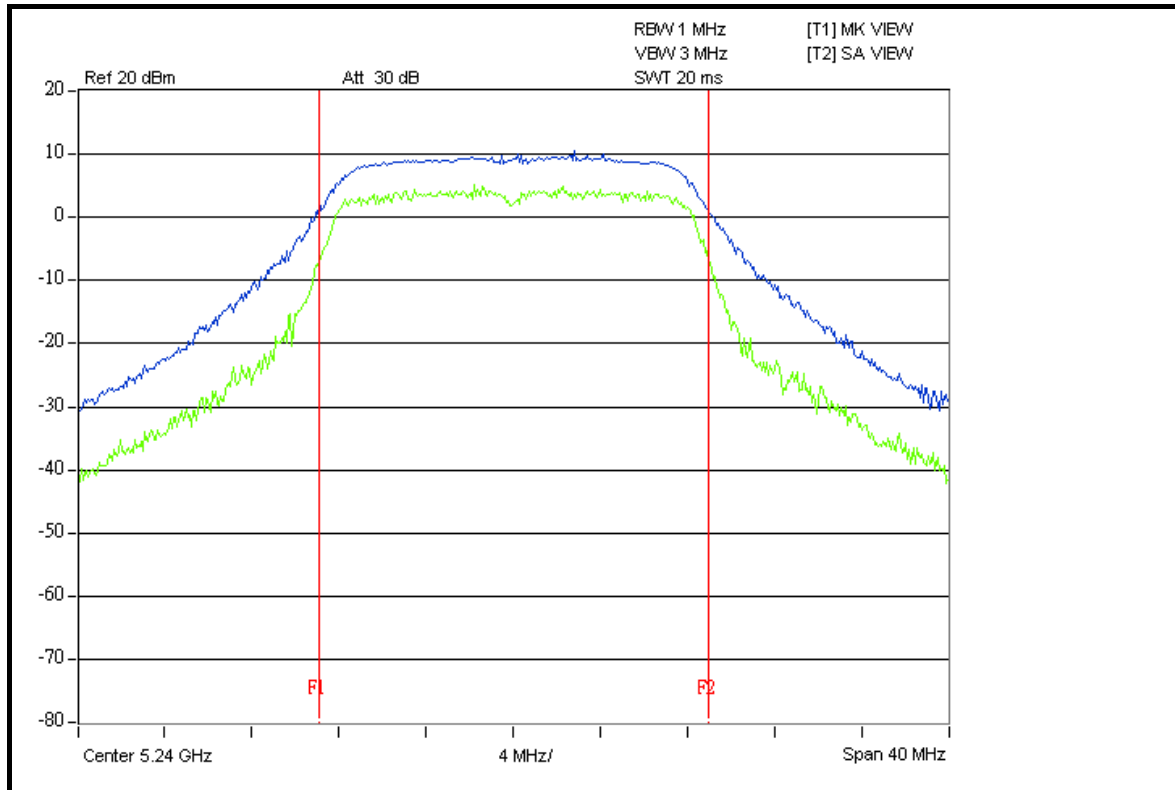



A D T

FOR CHAIN 1: CH 36

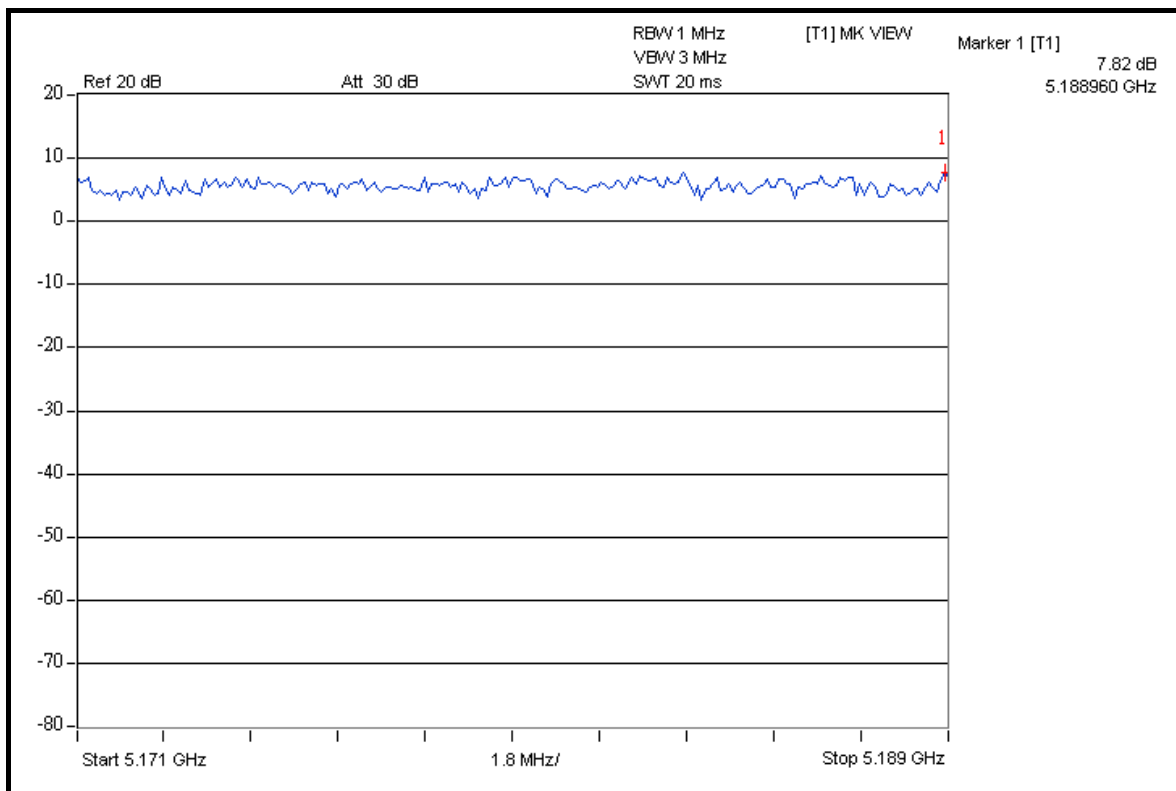
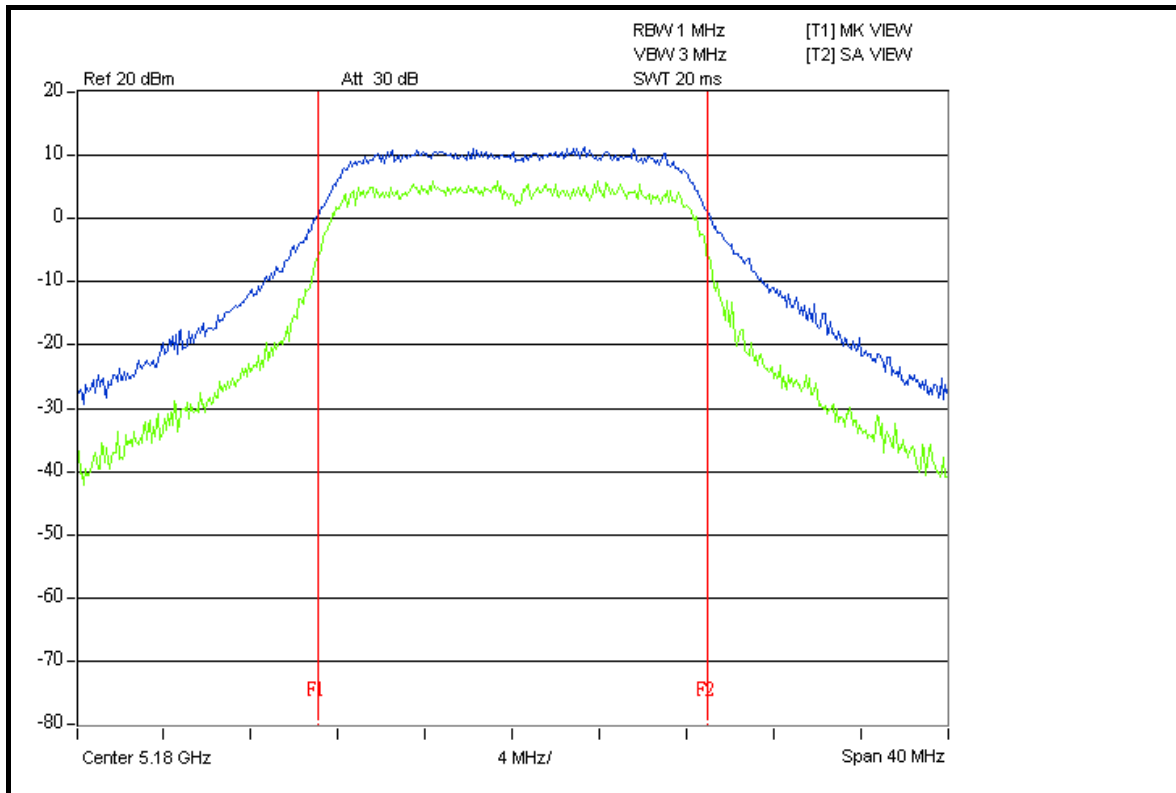



A D T

CH 40

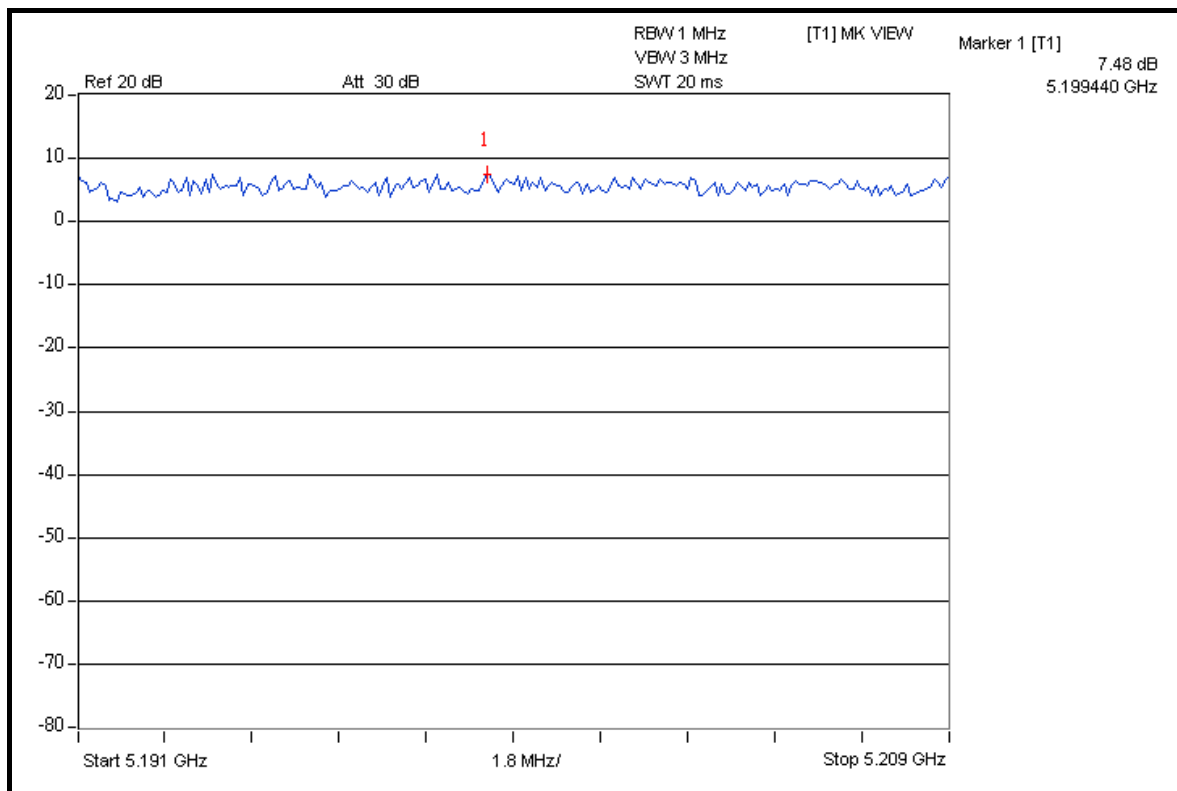
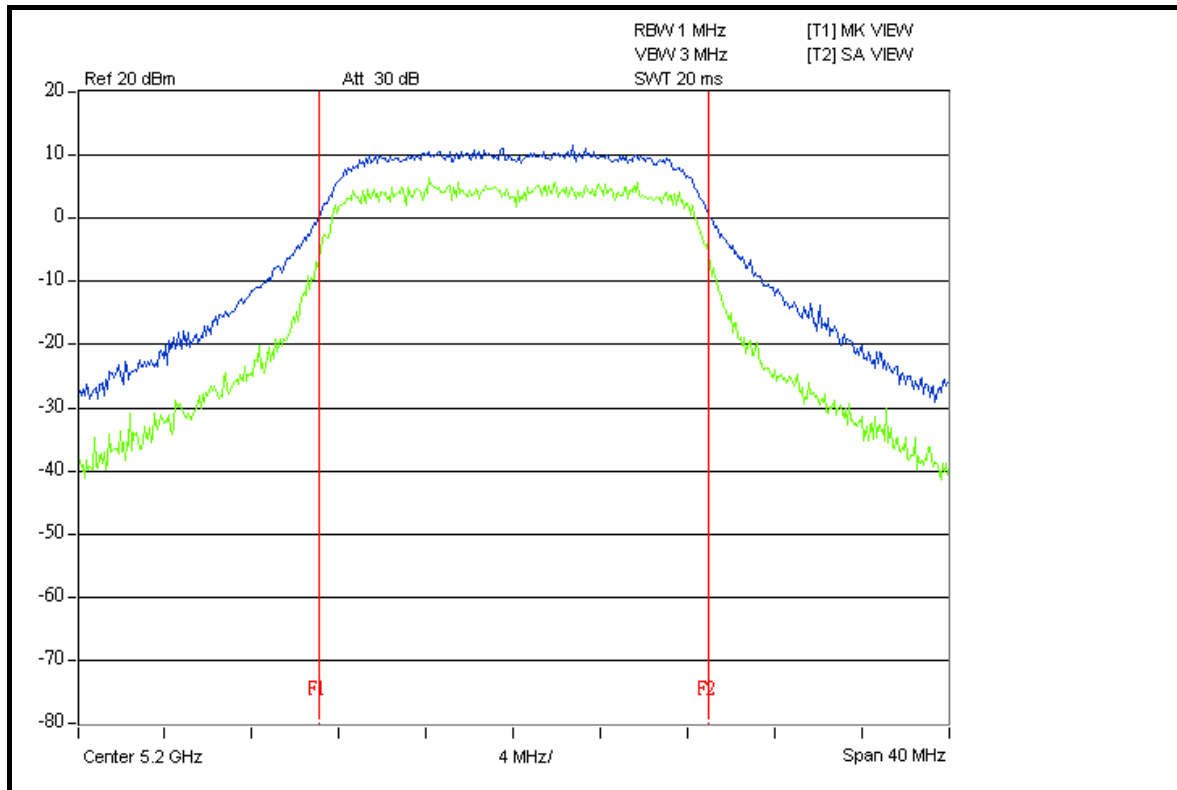



A D T

CH 48

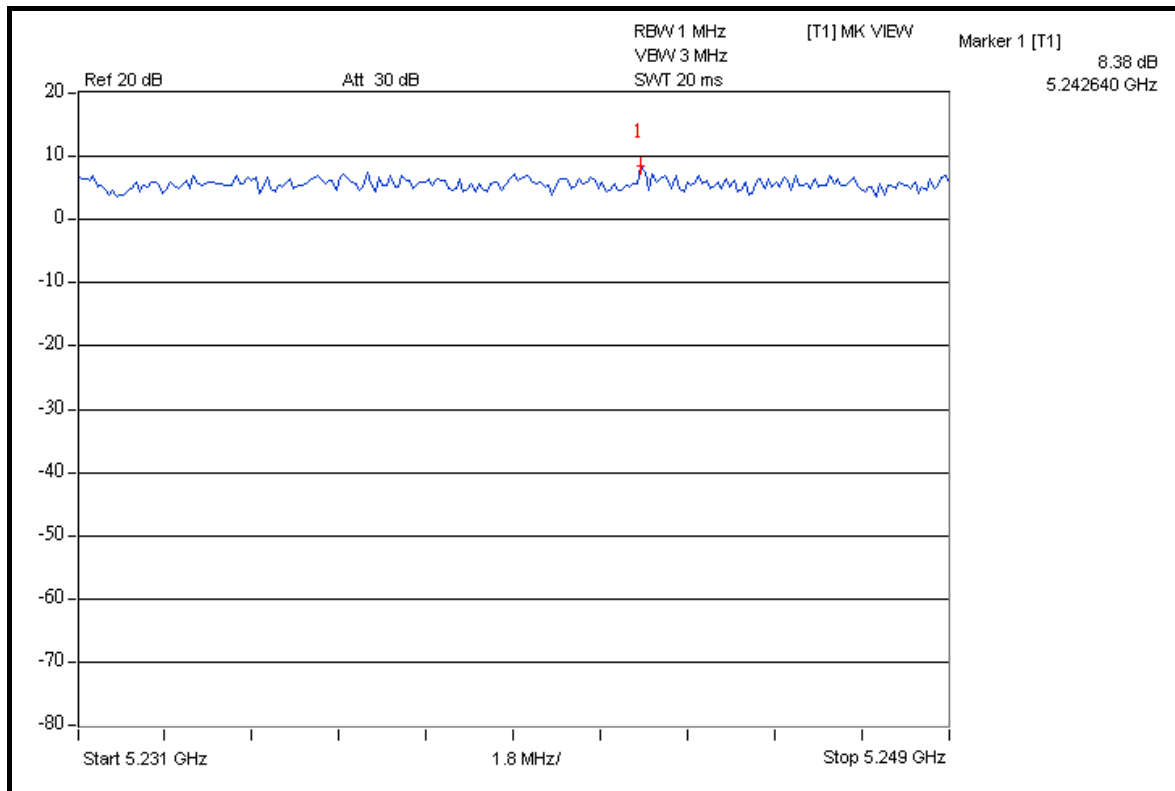
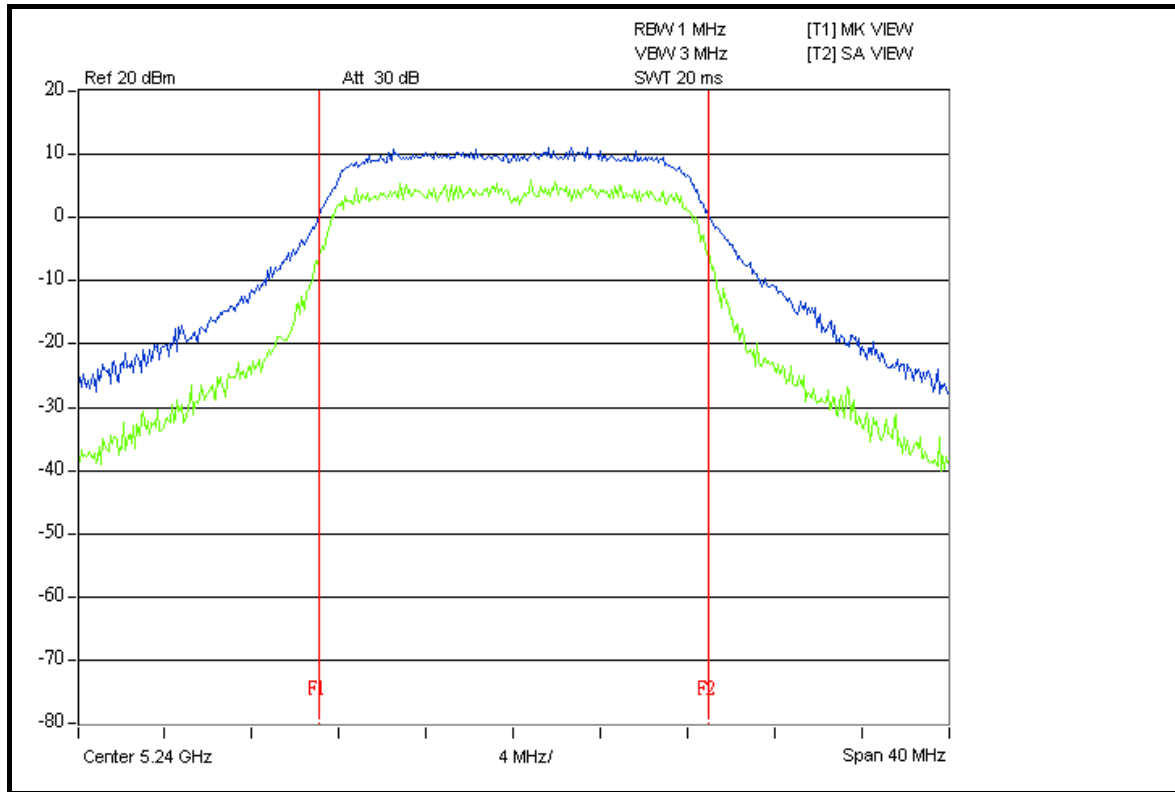



A D T

DRAFT 802.11n (20MHz) OFDM MODULATION

MODULATION TYPE	BPSK	TRANSFER RATE	7.2Mbps
INPUT POWER	120Vac, 60Hz	ENVIRONMENTAL CONDITIONS	23 deg.C, 66 %RH, 1021hPa
TESTED BY	Match Tsui		

CHANNEL	CHANNEL FREQUENCY (MHz)	PEAK POWER EXCURSION (dB)		PEAK to AVERAGE EXCURSION LIMIT (dB)	PASS/FAIL
		CHAIN 0	CHAIN 1		
36	5180	7.22	6.37	13	PASS
40	5200	6.79	6.78	13	PASS
48	5240	8.39	6.74	13	PASS



A D T

FOR CHAIN 0: CH 36

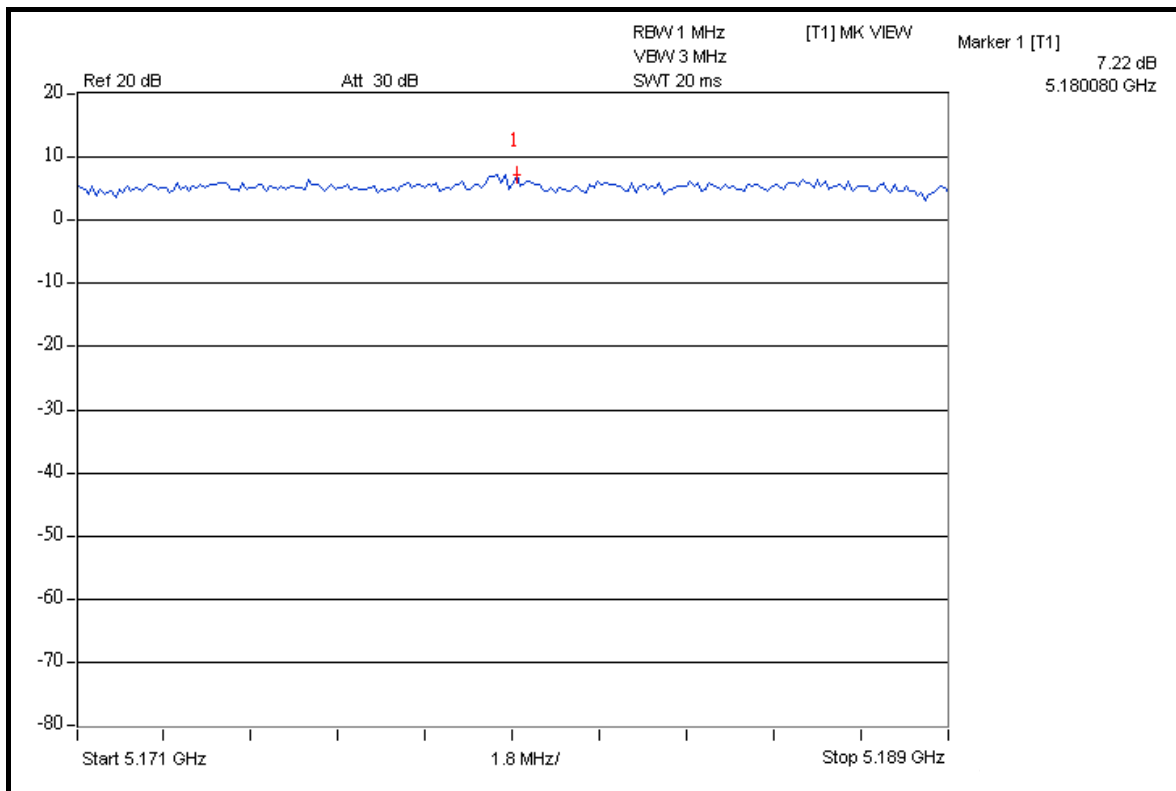
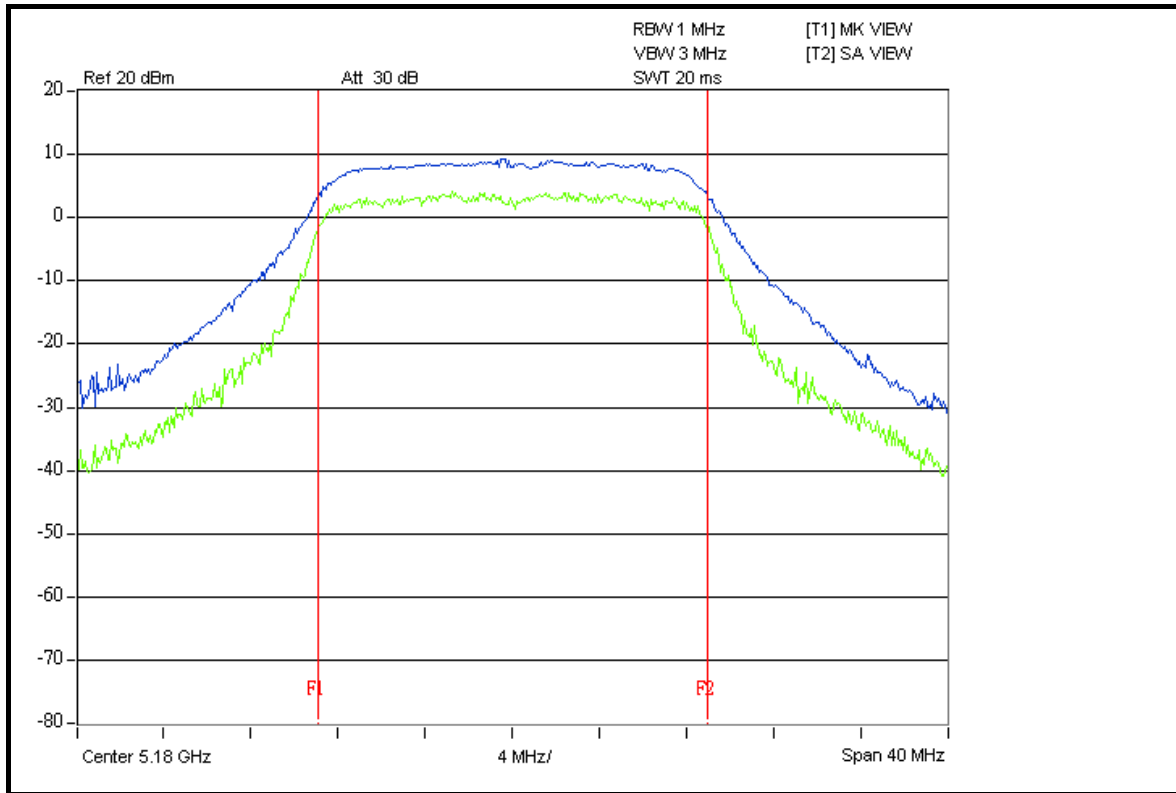



A D T

CH 40

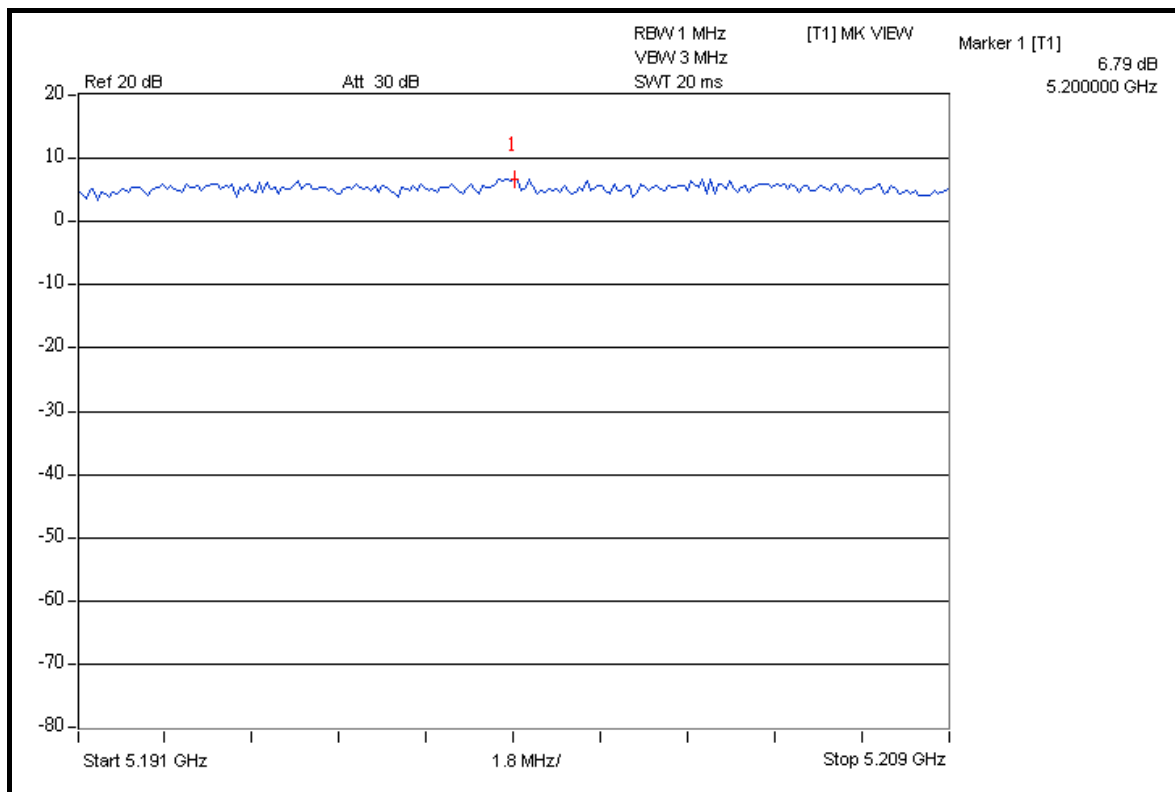
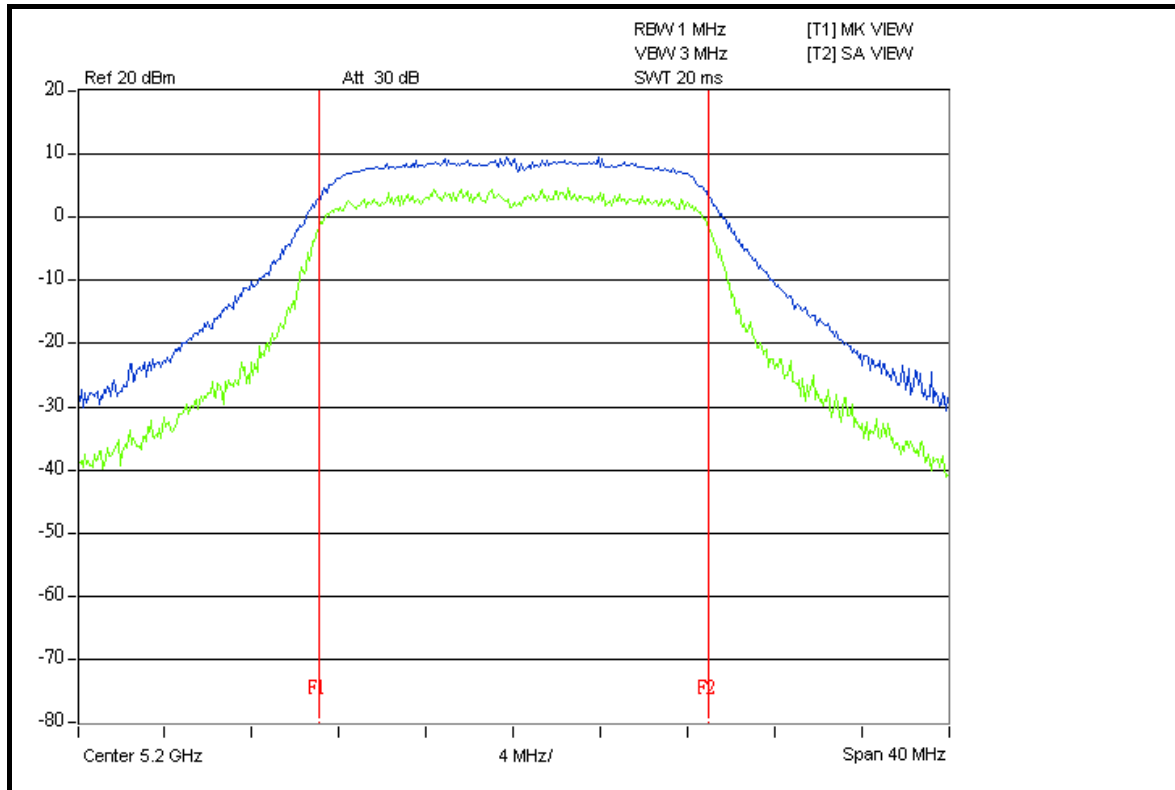



A D T

CH 48

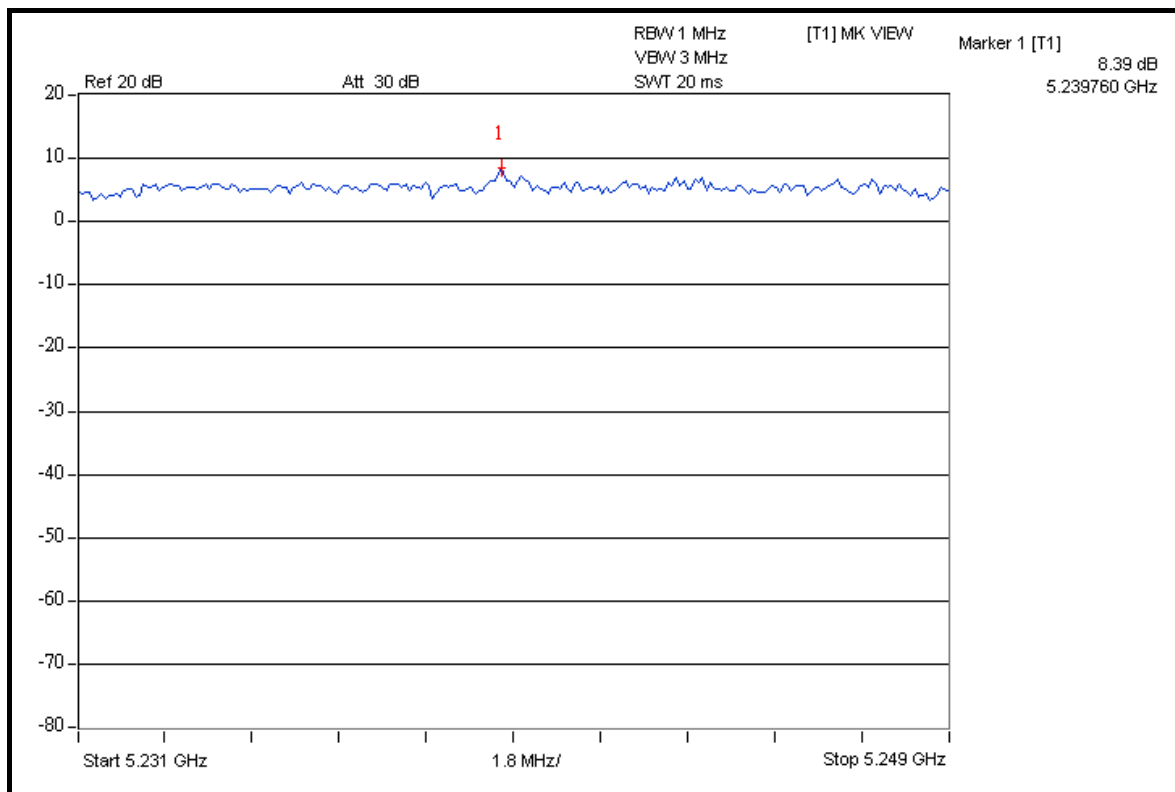
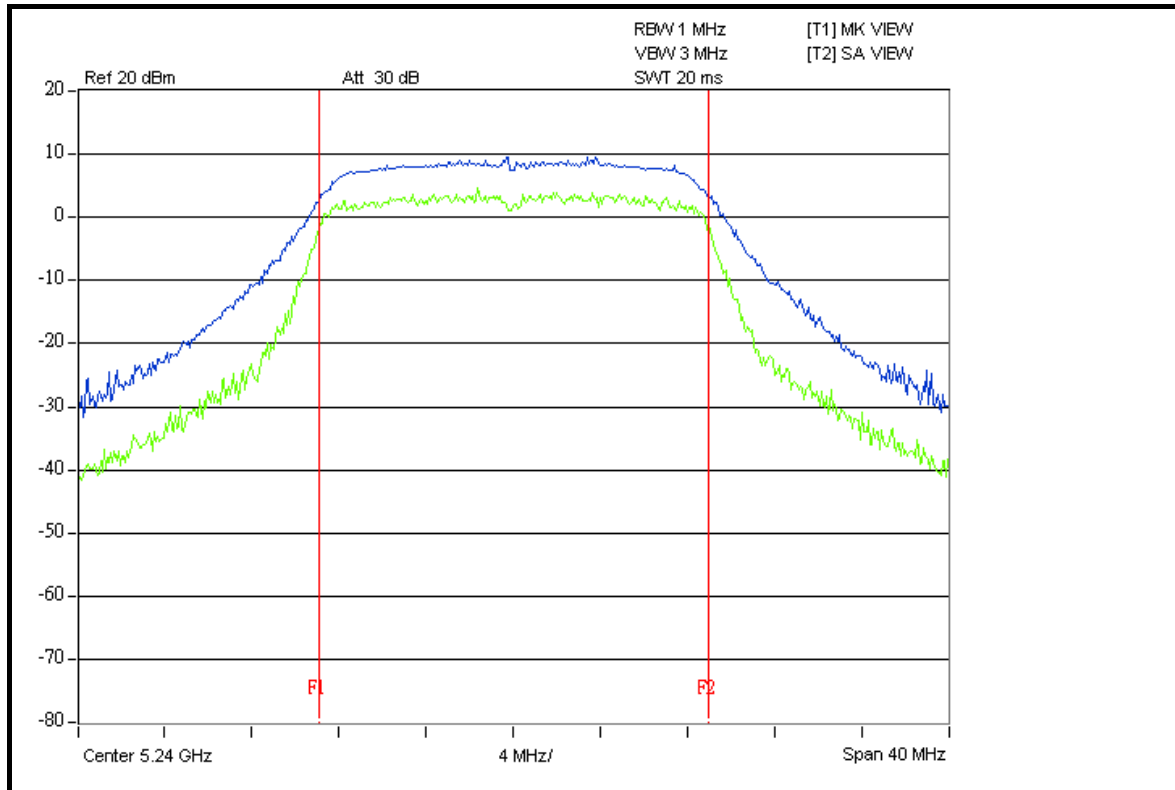



A D T

FOR CHAIN 1: CH 36

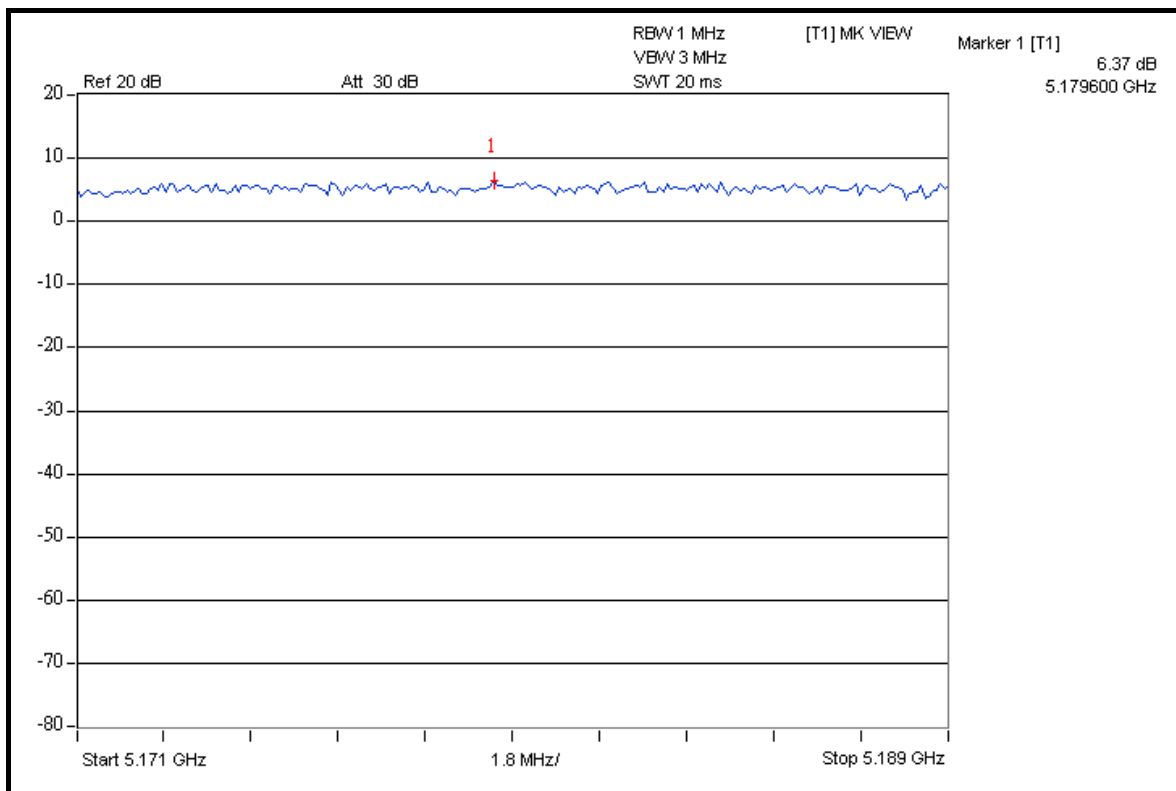
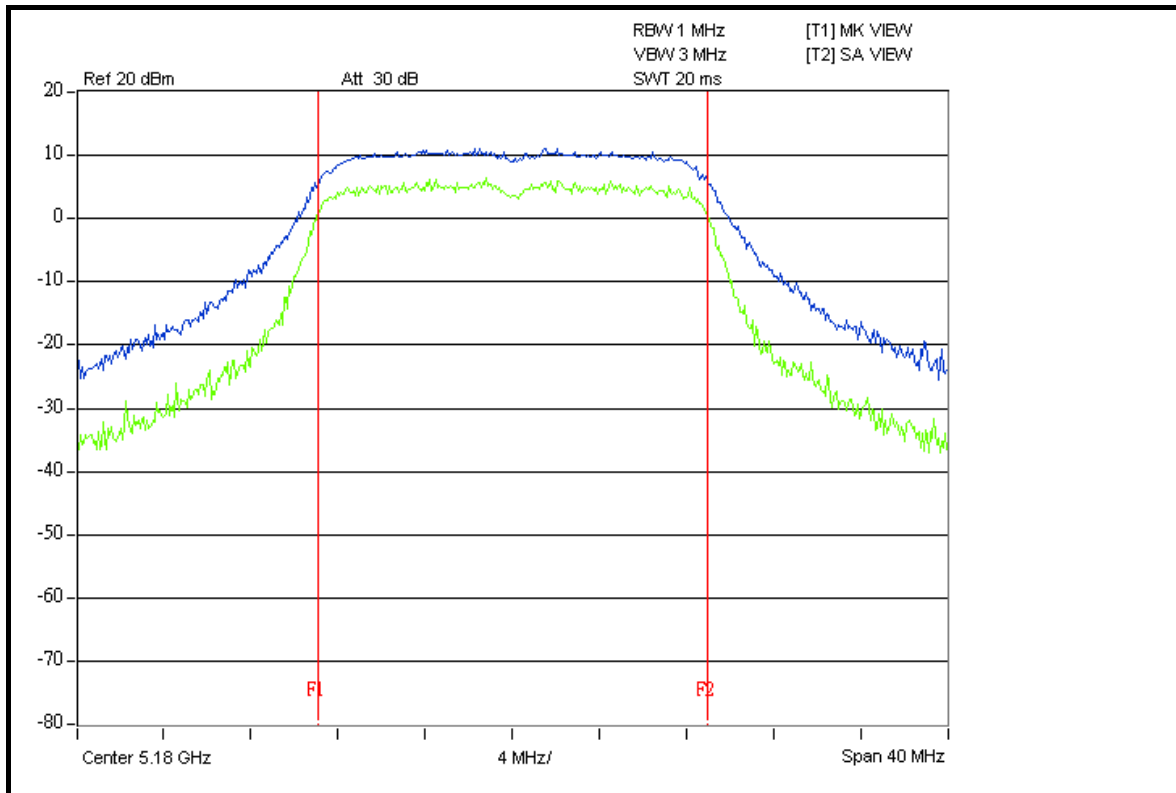



A D T

CH 40

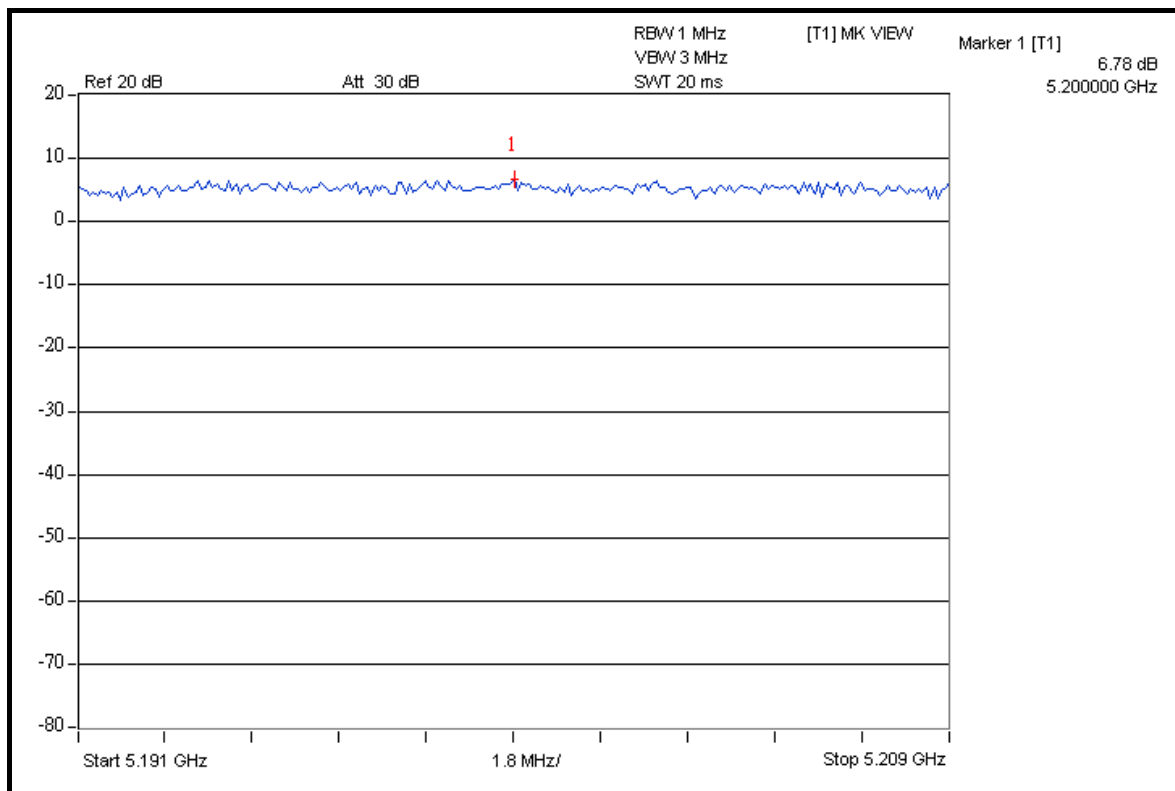
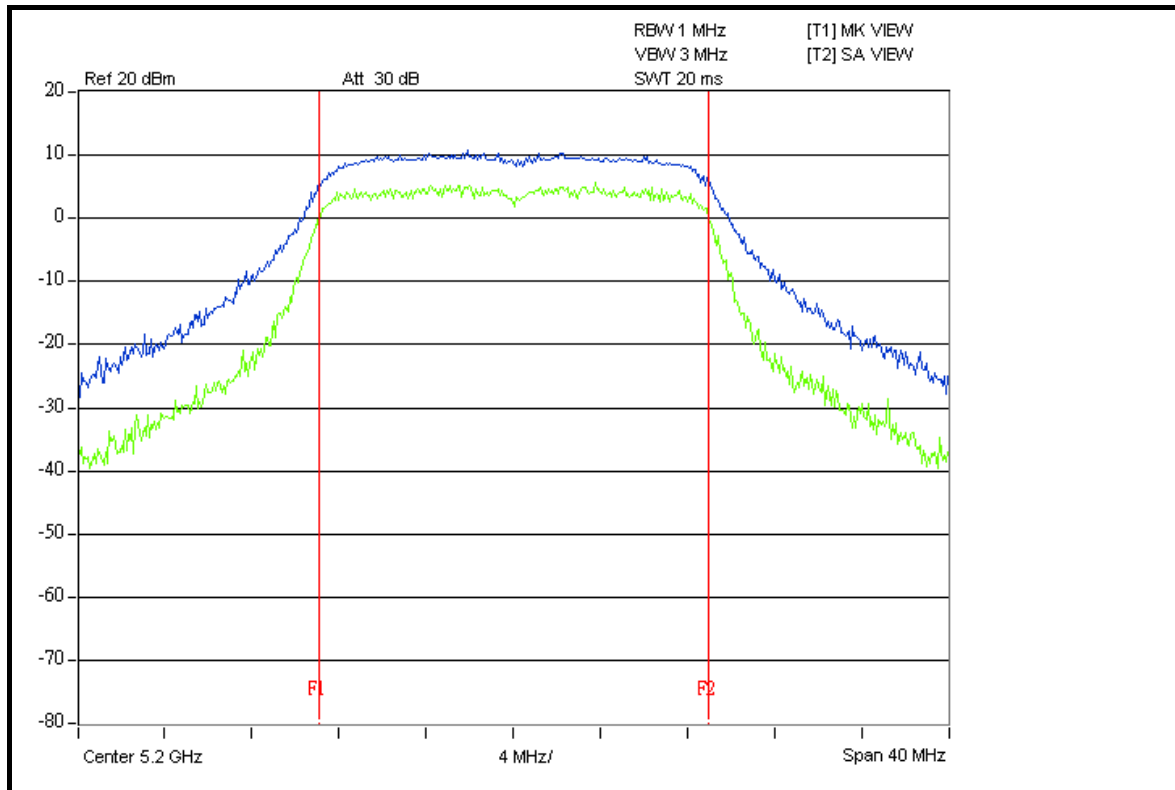



A D T

CH 48

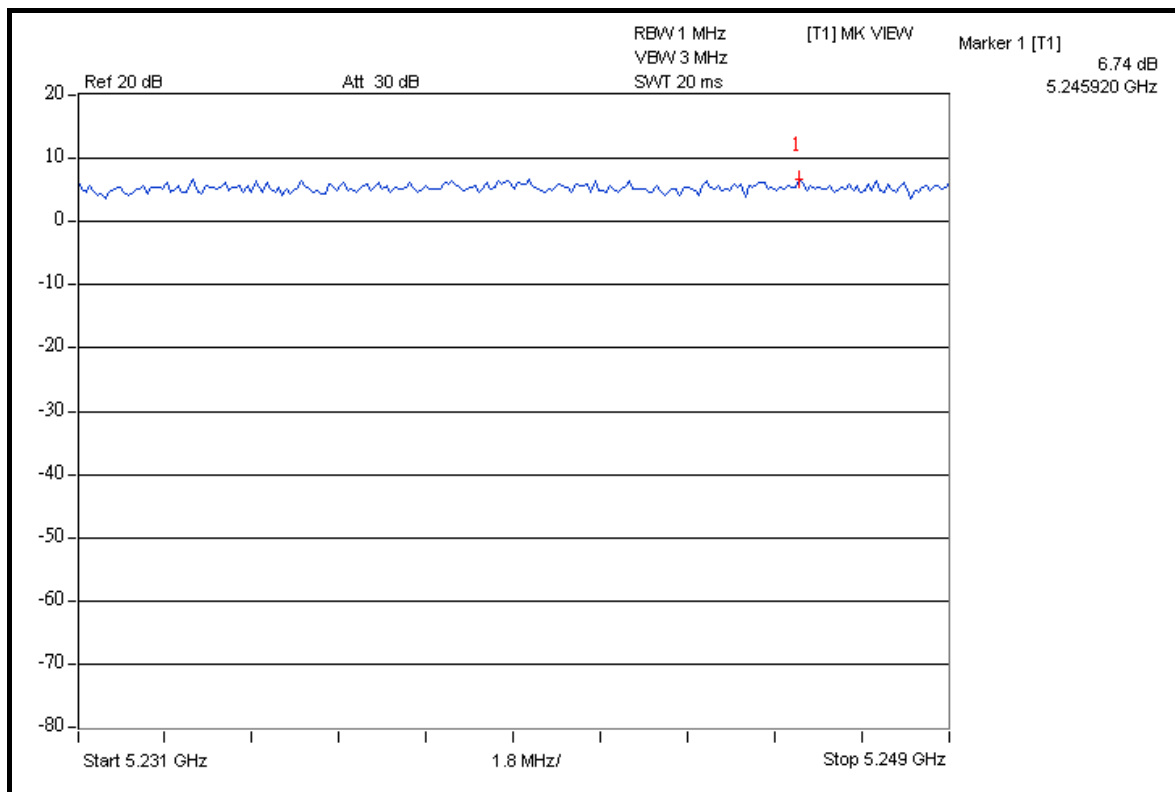
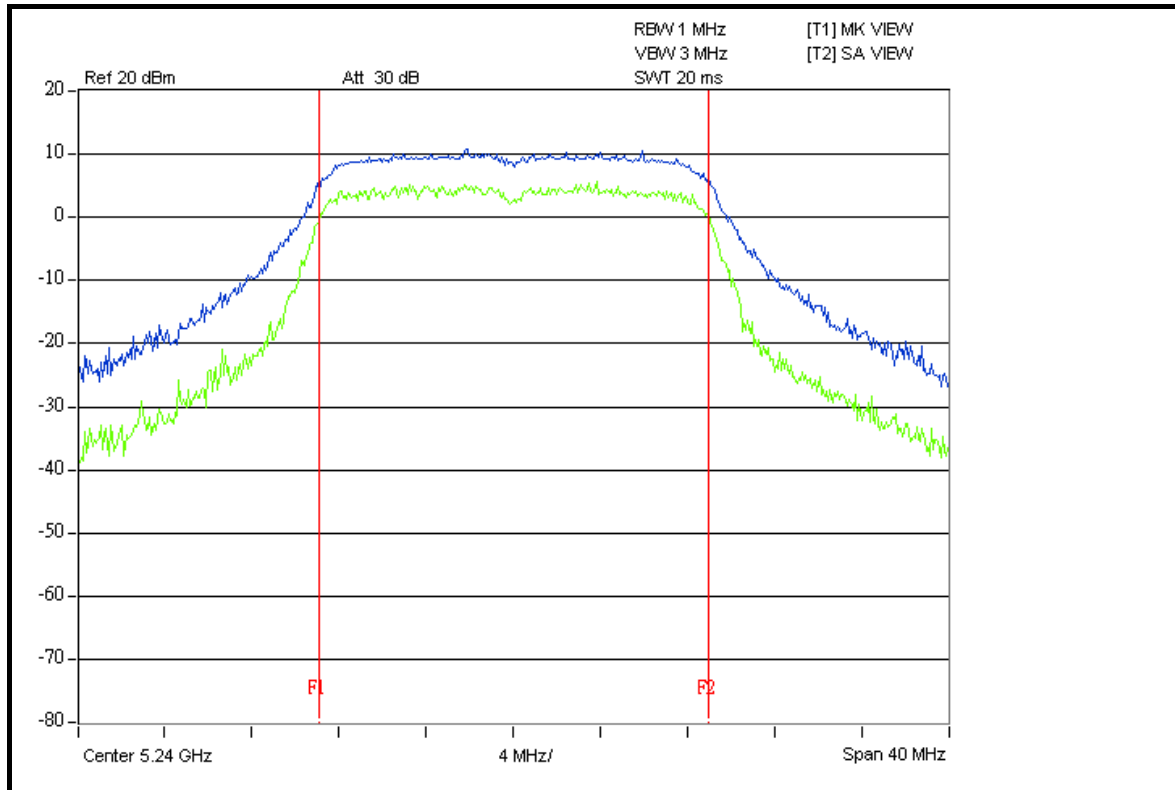



A D T

DRAFT 802.11n (40MHz) OFDM MODULATION

MODULATION TYPE	BPSK	TRANSFER RATE	15.0Mbps
INPUT POWER	120Vac, 60Hz	ENVIRONMENTAL CONDITIONS	23 deg.C, 66 %RH, 1021hPa
TESTED BY	Match Tsui		

CHANNEL	CHANNEL FREQUENCY (MHz)	PEAK POWER EXCURSION (dB)		PEAK to AVERAGE EXCURSION LIMIT (dB)	PASS/FAIL
		CHAIN 0	CHAIN 1		
38	5190	7.98	9.00	13	PASS
46	5230	8.82	8.91	13	PASS



A D T

FOR CHAIN 0: CH 38

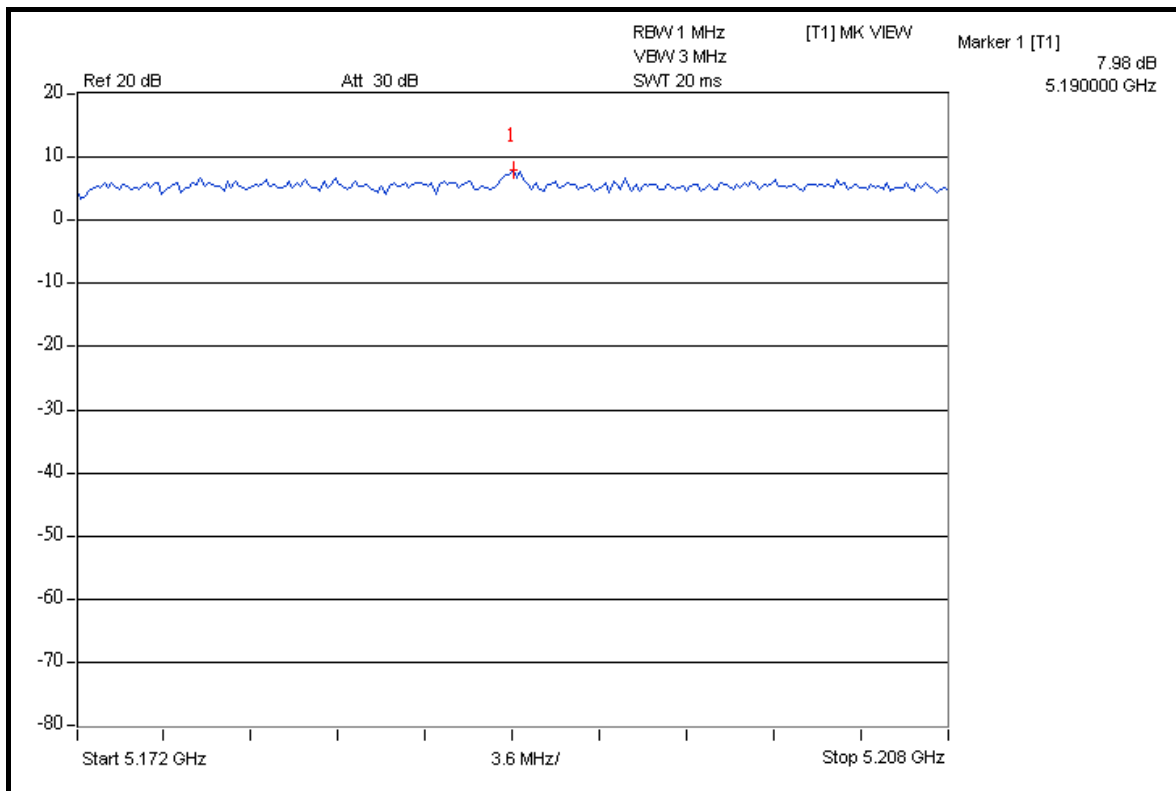
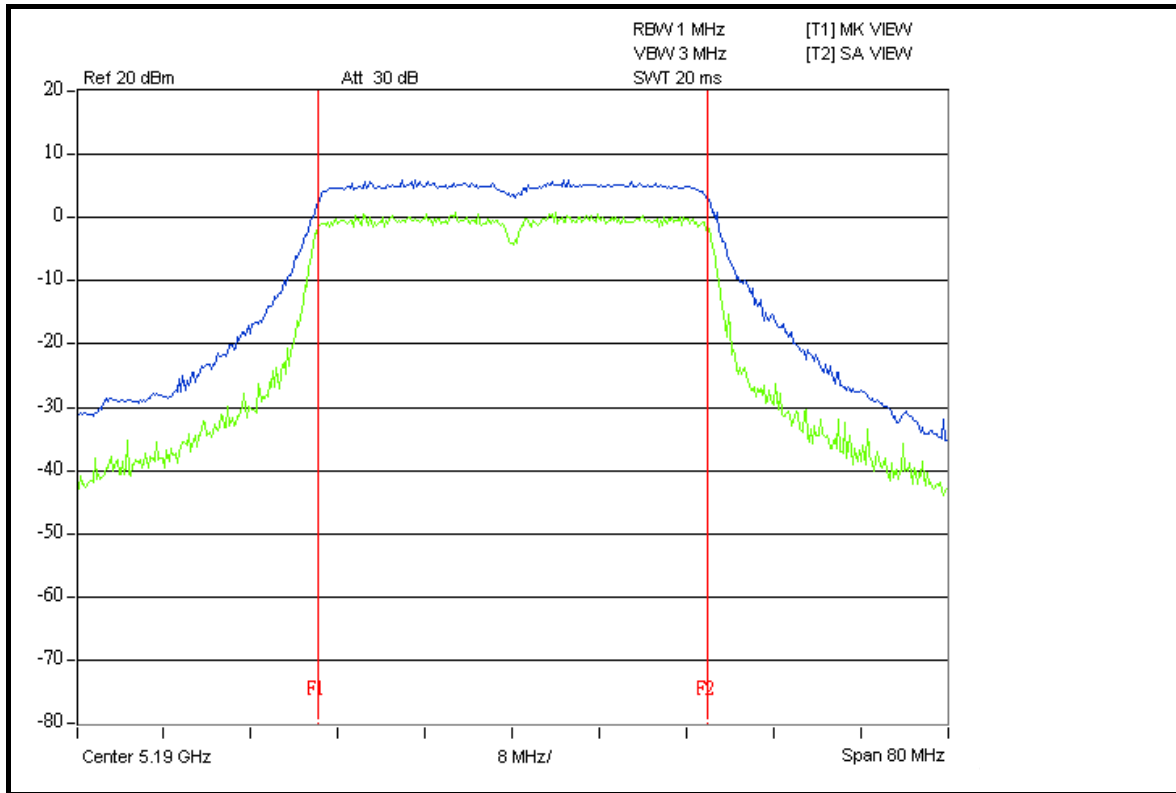



A D T

CH 46

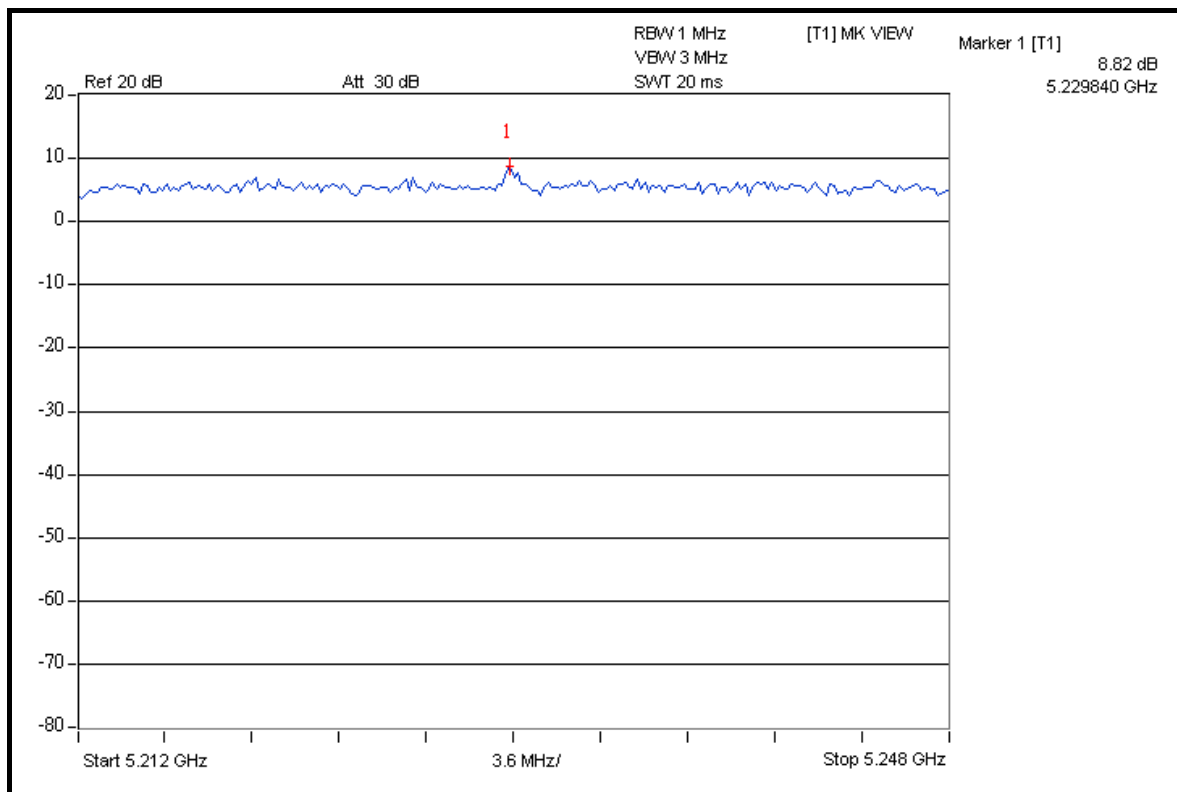
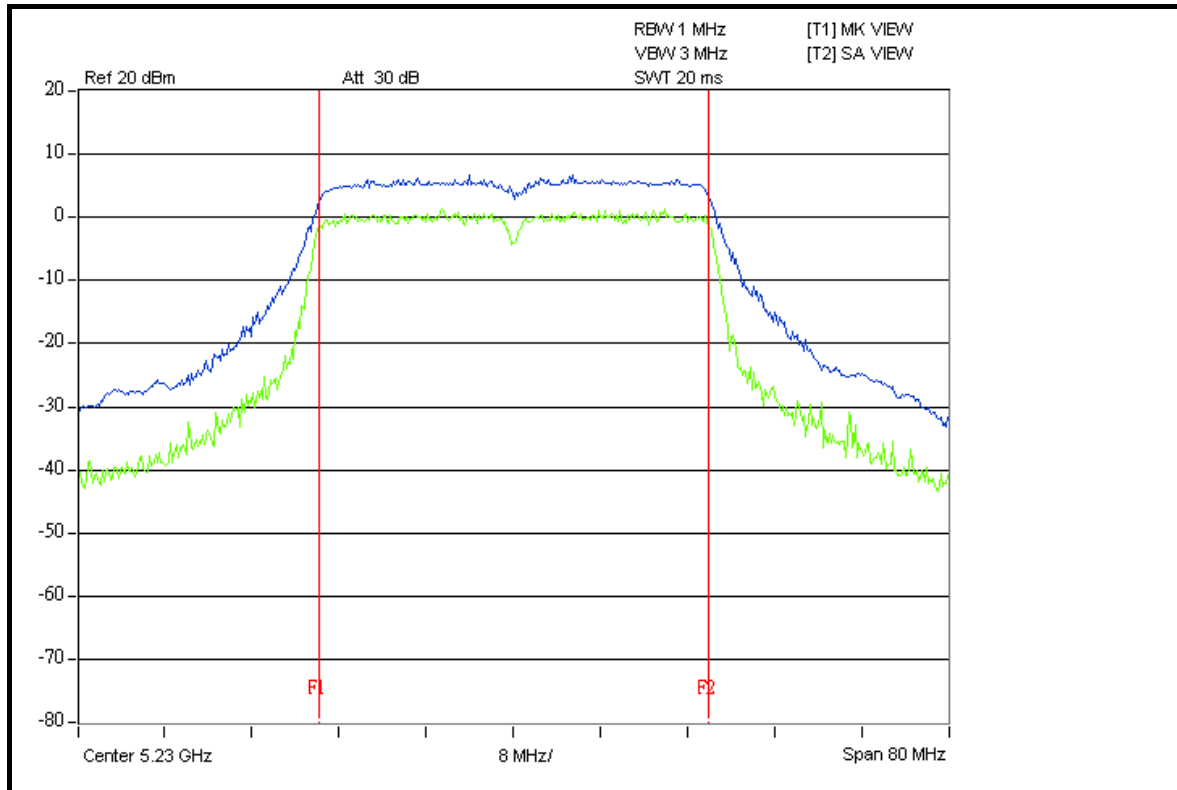



A D T

FOR CHAIN 1: CH 38

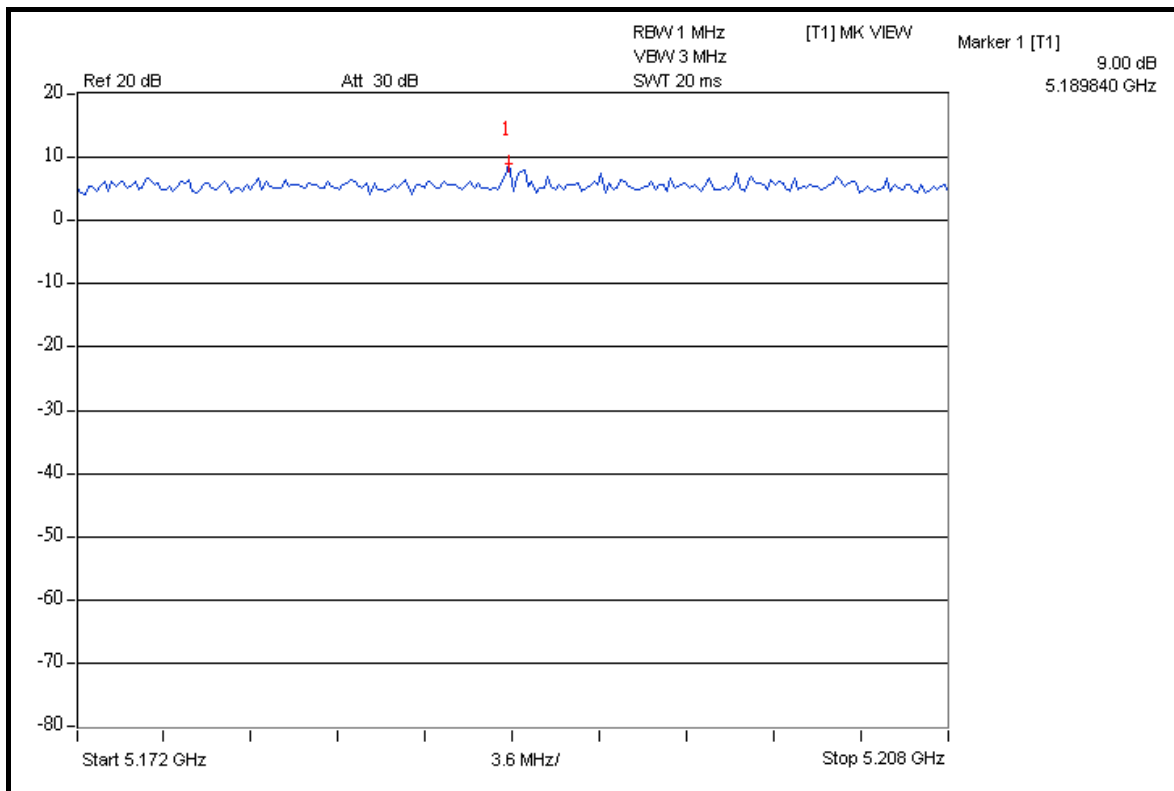
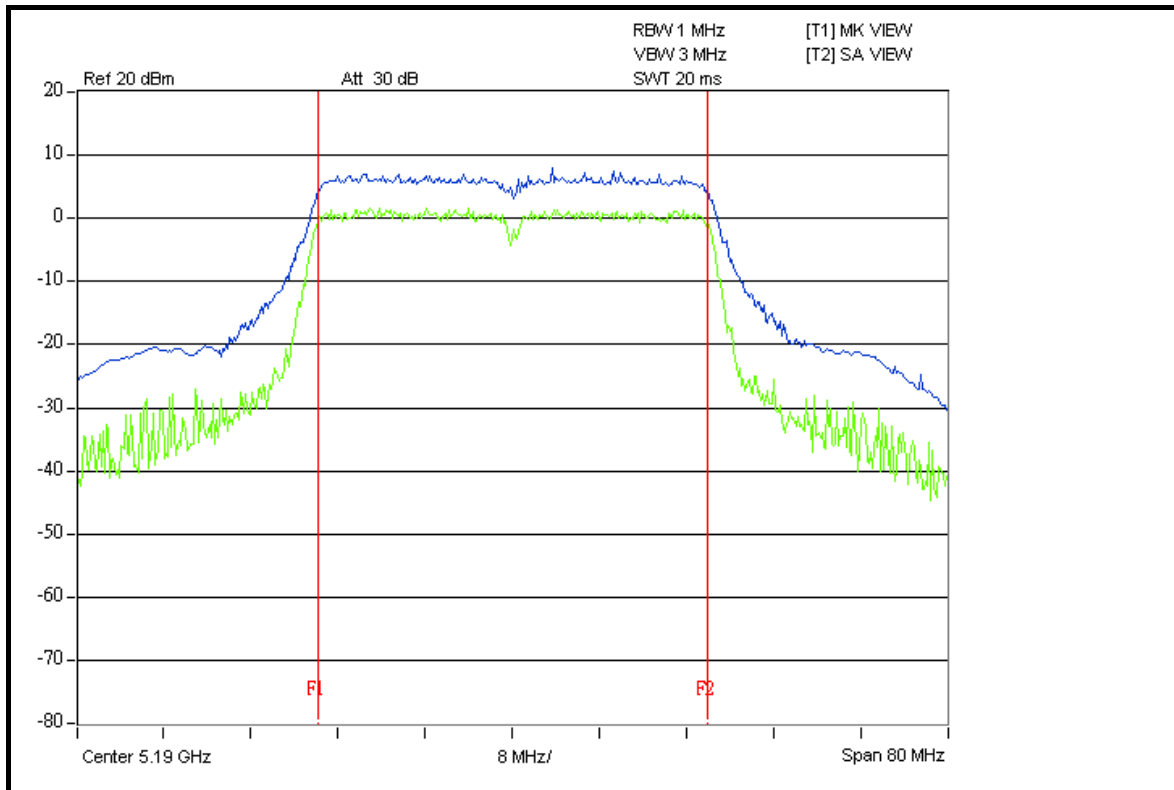



A D T

CH 46

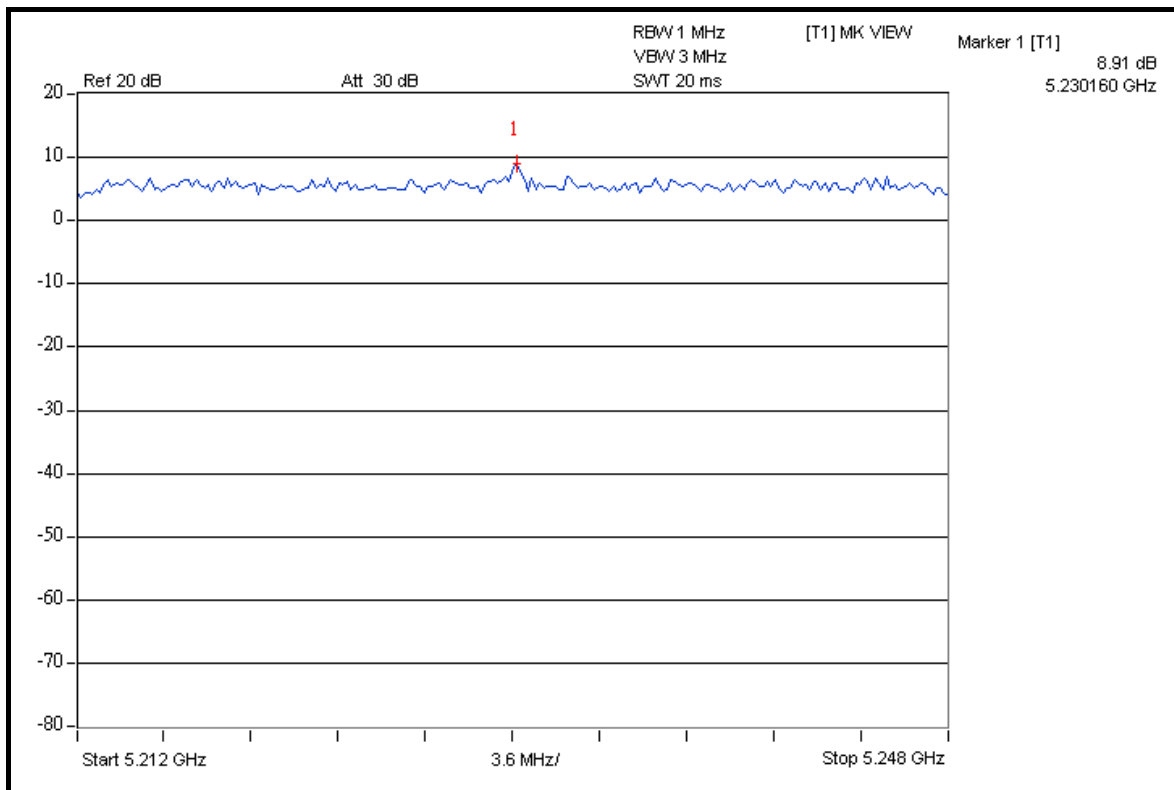
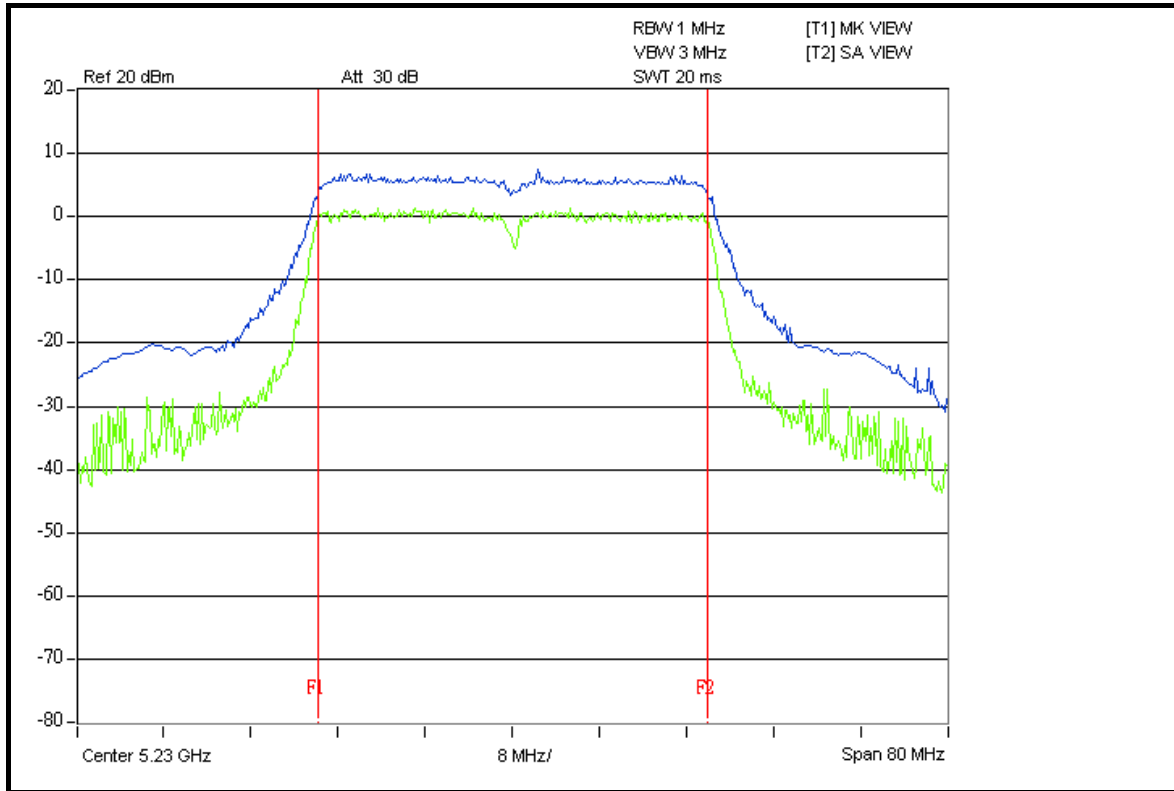

4.5 PEAK POWER SPECTRAL DENSITY MEASUREMENT

4.5.1 LIMITS OF PEAK POWER SPECTRAL DENSITY MEASUREMENT

FREQUENCY BAND	LIMIT
5.15 ~ 5.25GHz	4dBm

4.5.2 TEST INSTRUMENTS

DESCRIPTION & MANUFACTURER	MODEL NO.	SERIAL NO.	DATE OF CALIBRATION	CALIBRATED UNTIL
R&S SPECTRUM ANALYZER	FSP40	100041	Apr. 22, 2008	Apr. 21, 2009

NOTE: The calibration interval of the above test instruments is 12 months and the calibrations are traceable to NML/ROC and NIST/USA.

4.5.3 TEST PROCEDURES

- a. The transmitter output was connected to the spectrum analyzer.
- b. Set RBW = 1MHz, VBW = 3MHz. The PPSD is the highest level found across the emission in any 1MHz band.

4.5.4 DEVIATION FROM TEST STANDARD

No deviation.

4.5.5 TEST SETUP

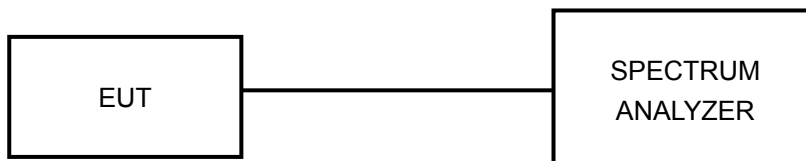

4.5.6 EUT OPERATING CONDITIONS

Same as 5.3.6.

4.5.7 TEST RESULTS

802.11a OFDM MODULATION

MODULATION TYPE	BPSK	TRANSFER RATE	6.0Mbps
INPUT POWER	120Vac, 60Hz	ENVIRONMENTAL CONDITIONS	23 deg.C, 66 %RH, 1021hPa
TESTED BY	Match Tsui		

CHAN.	CHAN. FREQ. (MHz)	RF POWER LEVEL IN 1MHz BW (dBm)		TOTAL POWER DENSITY (mW)	TOTAL POWER DENSITY (dBm)	MAX. LIMIT (dBm)	PASS / FAIL
		CHAIN 0	CHAIN 1				
36	5180	-1.49	-0.37	1.628	2.12	4	PASS
40	5200	-1.33	-0.25	1.680	2.25	4	PASS
48	5240	-1.28	-0.47	1.642	2.15	4	PASS



A D T

FOR CHAIN 0: CH 36

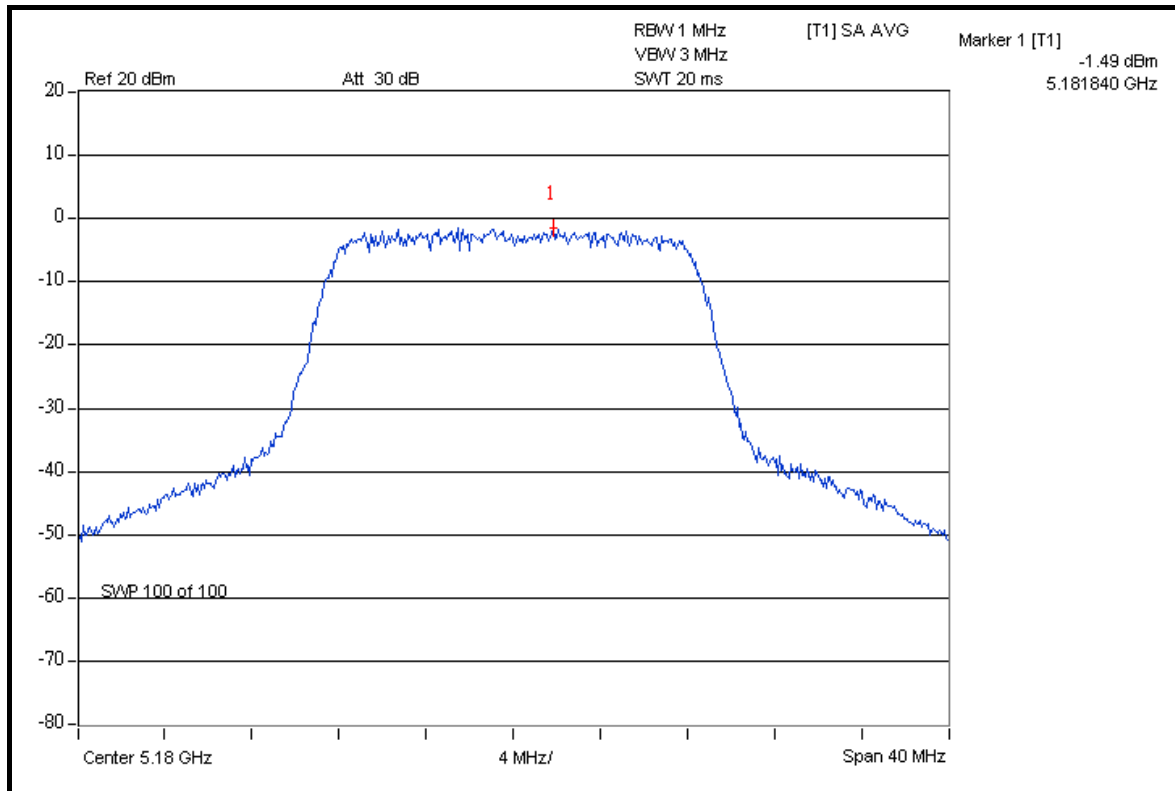

CH 40

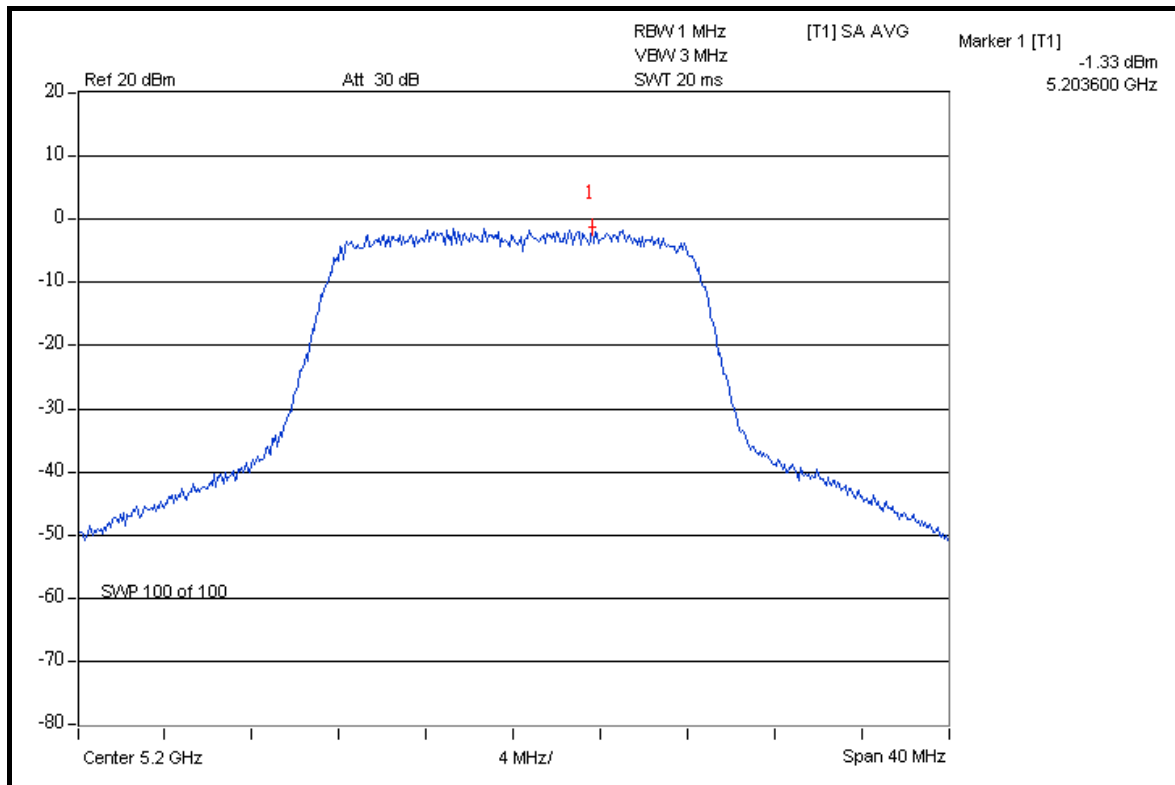



A D T

CH 48

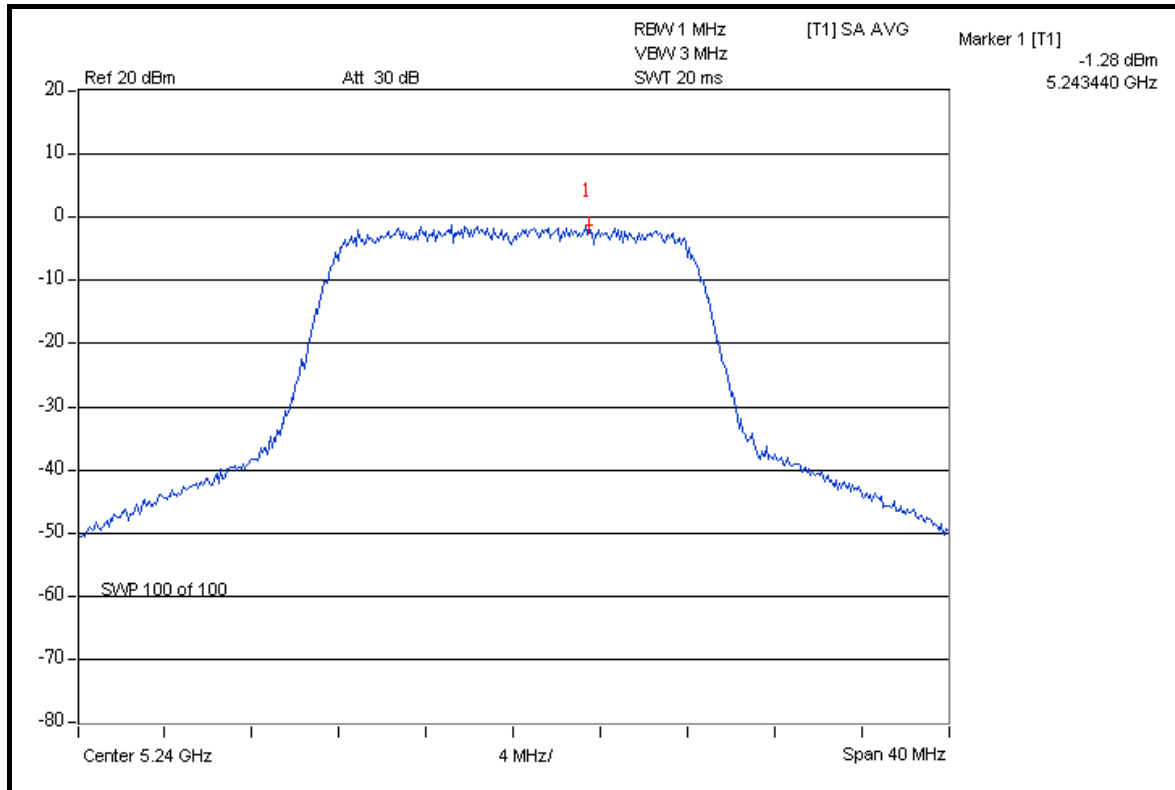

FOR CHAIN 1: CH 36

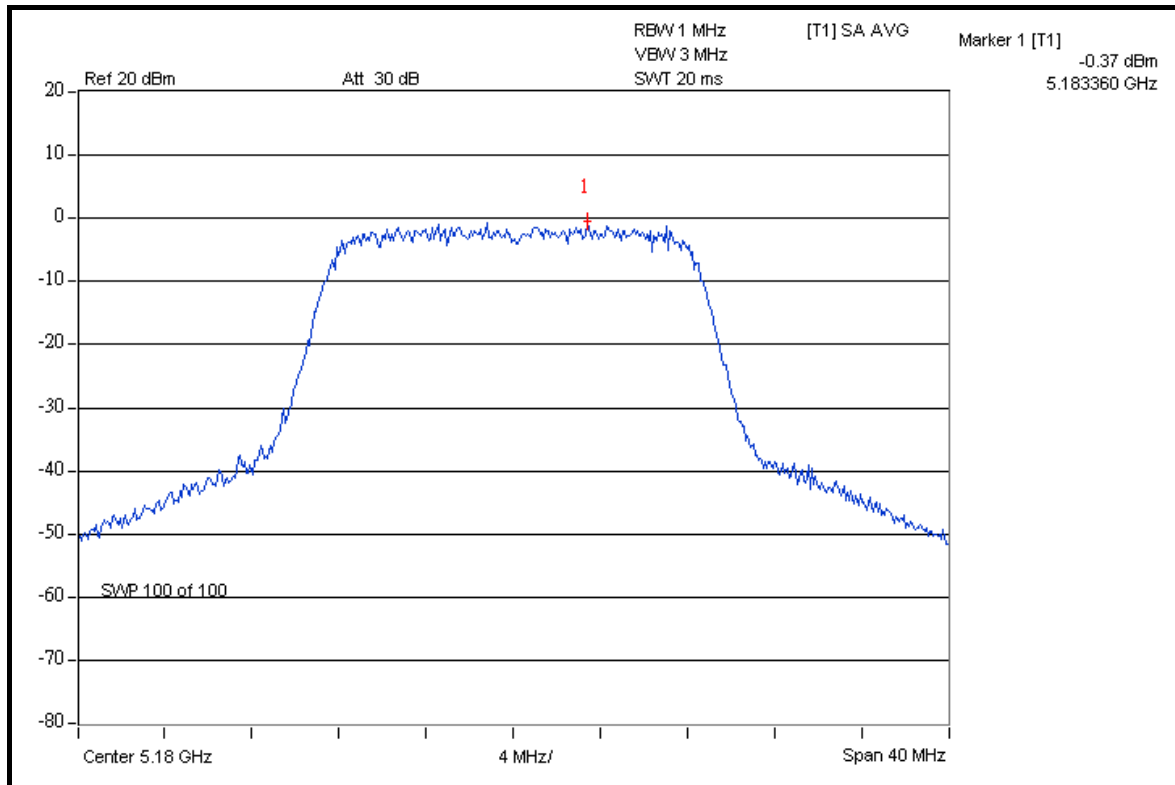



A D T

CH 40

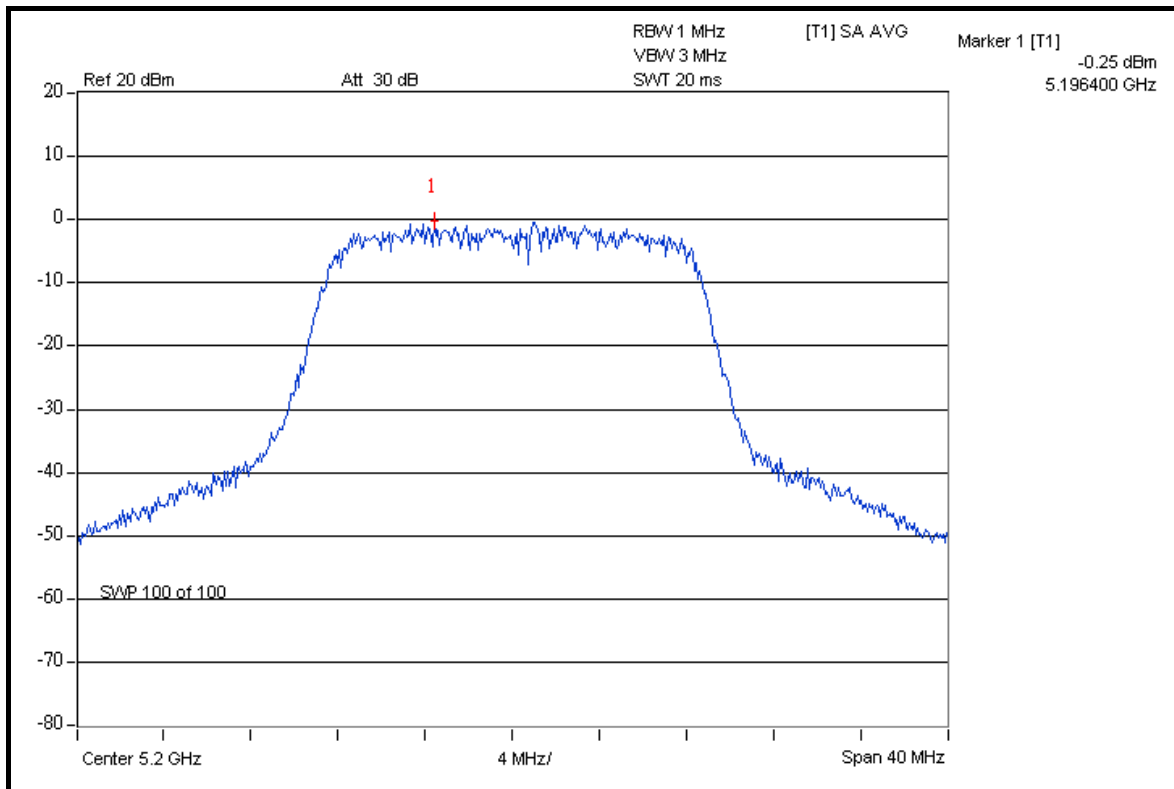

CH 48

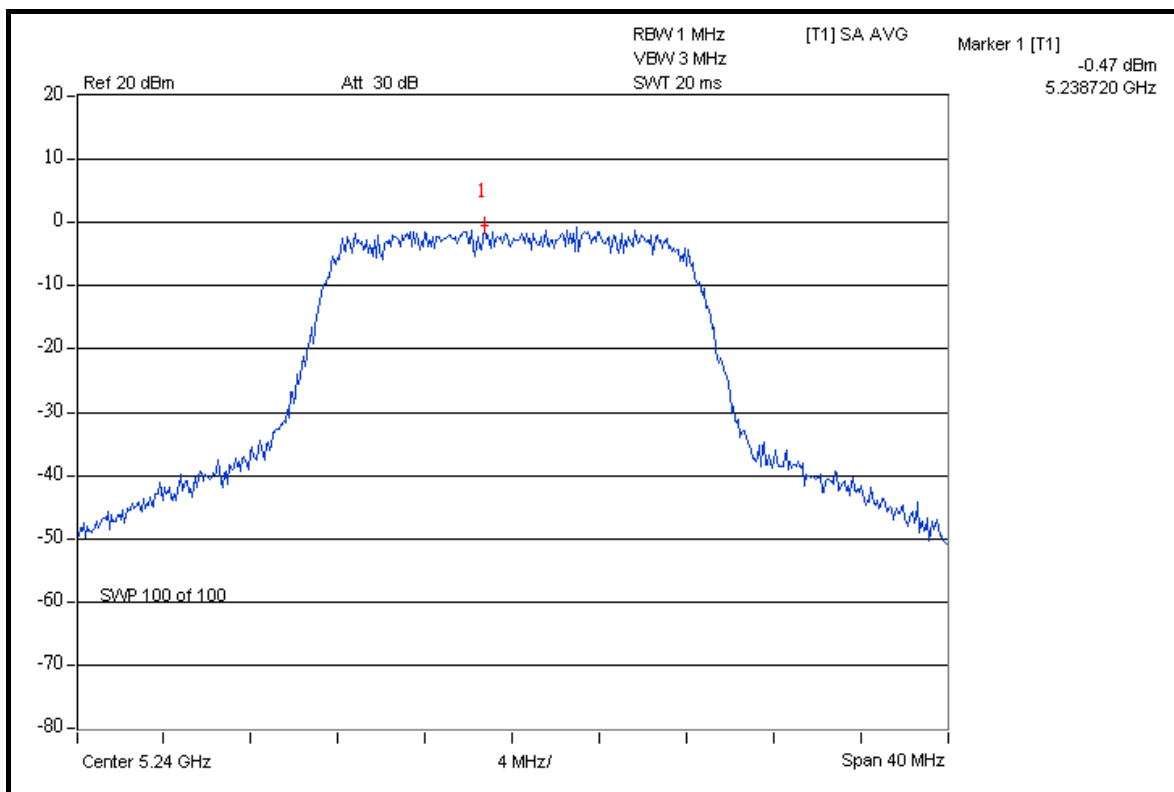



A D T

DRAFT 802.11n (20MHz) OFDM MODULATION

MODULATION TYPE	BPSK	TRANSFER RATE	7.2Mbps
INPUT POWER	120Vac, 60Hz	ENVIRONMENTAL CONDITIONS	23 deg.C, 66 %RH, 1021hPa
TESTED BY	Match Tsui		

CHAN.	CHAN. FREQ. (MHz)	RF POWER LEVEL IN 1MHz BW (dBm)		TOTAL POWER DENSITY (mW)	TOTAL POWER DENSITY (dBm)	MAX. LIMIT (dBm)	PASS / FAIL
		CHAIN 0	CHAIN 1				
36	5180	-1.53	0.15	1.738	2.40	4	PASS
40	5200	-1.48	-0.21	1.664	2.21	4	PASS
48	5240	-1.46	-0.37	1.633	2.13	4	PASS



A D T

FOR CHAIN 0: CH 36

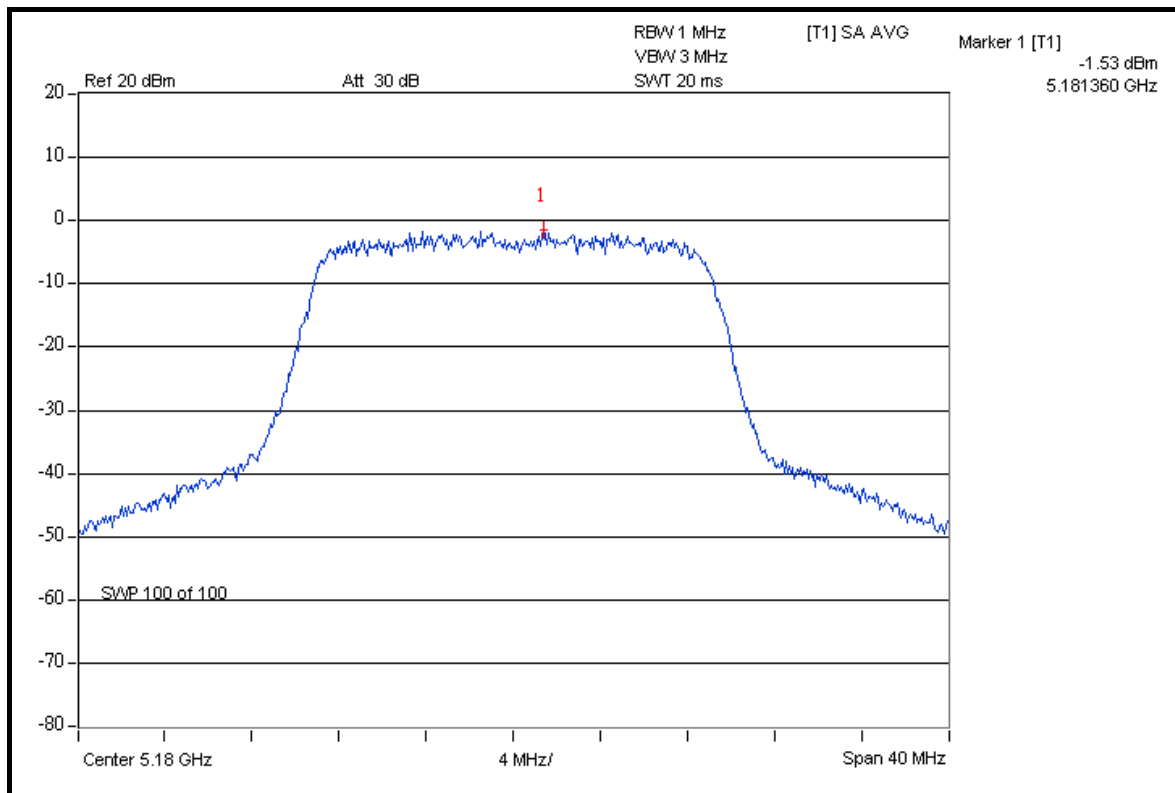

CH 40

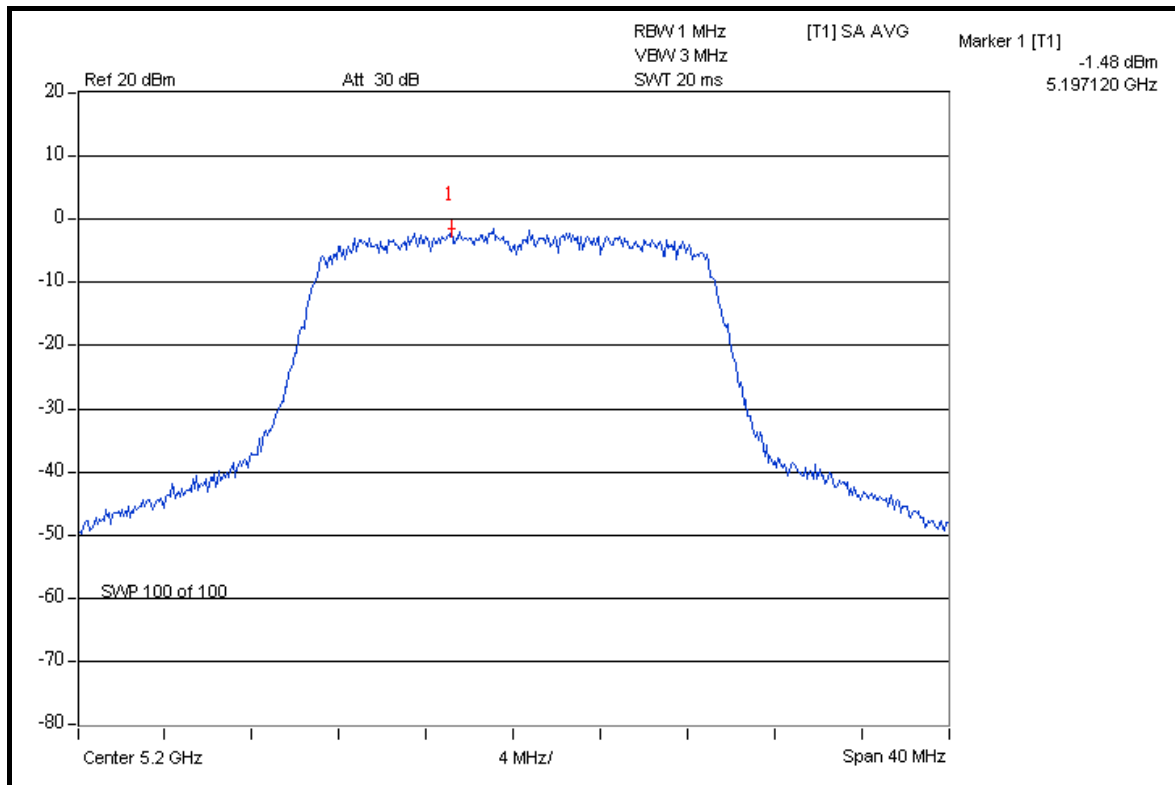



A D T

CH 48

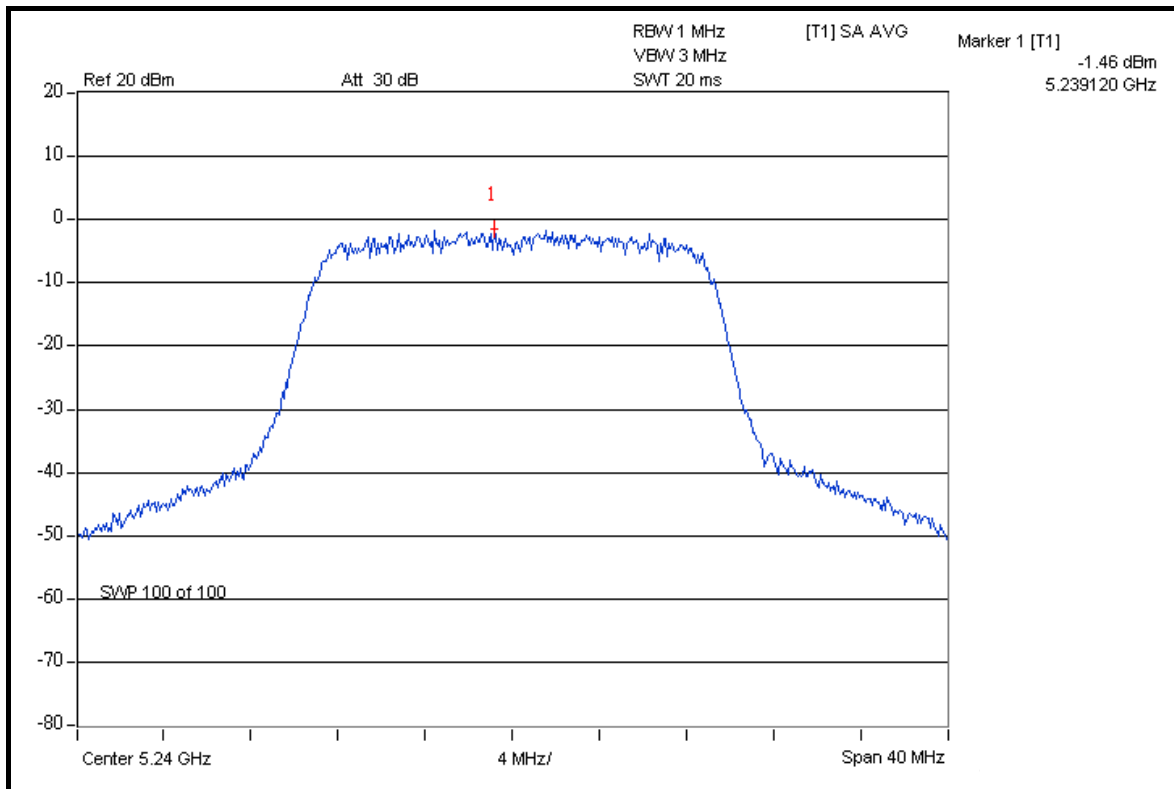

FOR CHAIN 1: CH 36

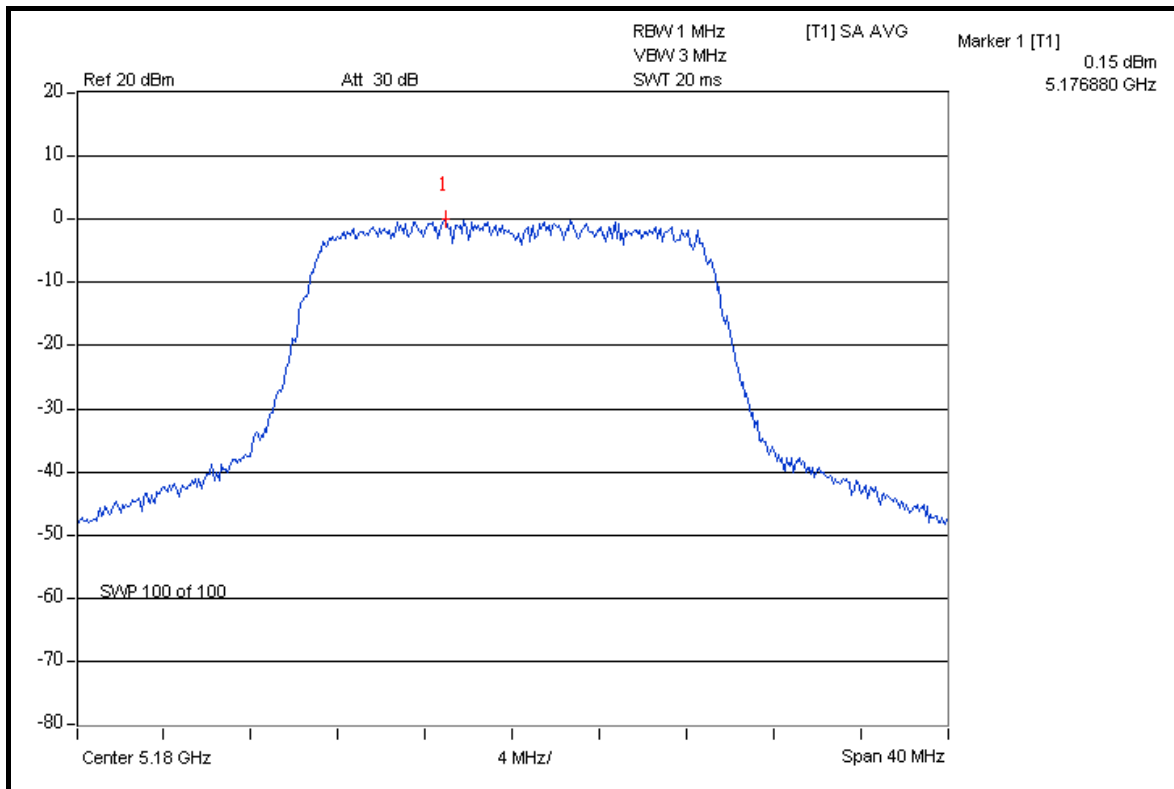



A D T

CH 40

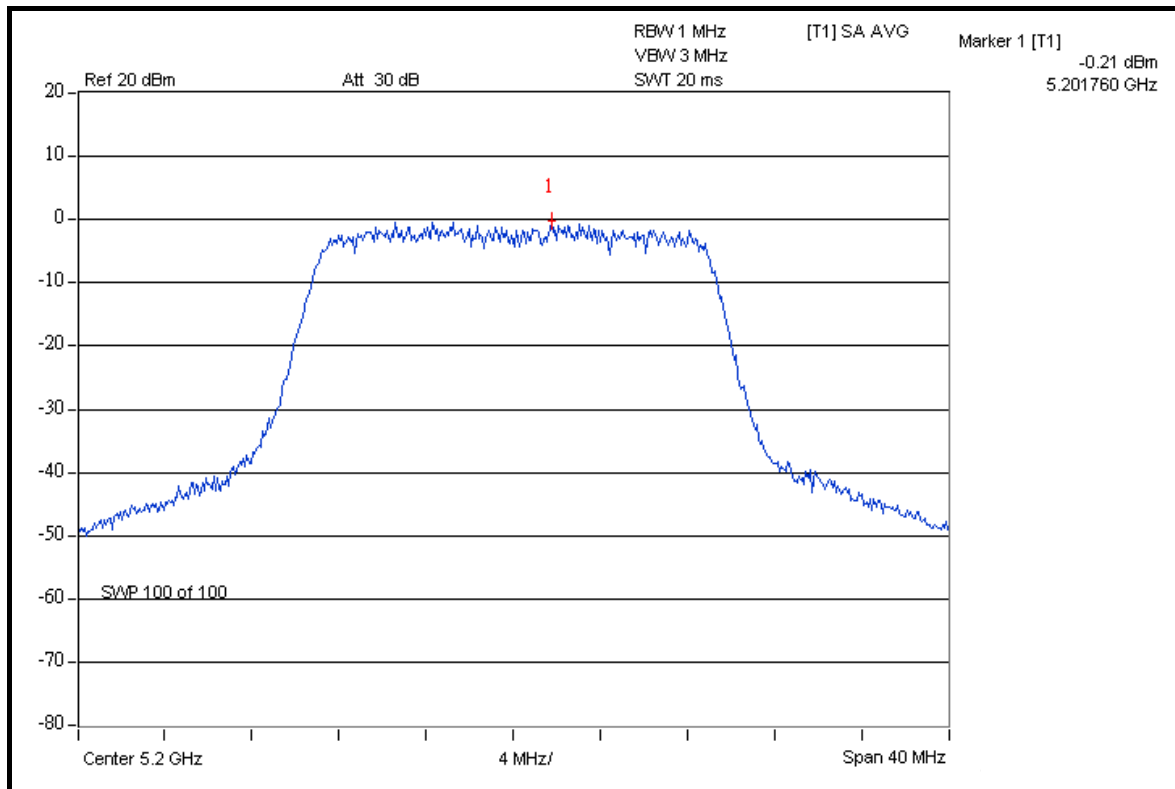

CH 48

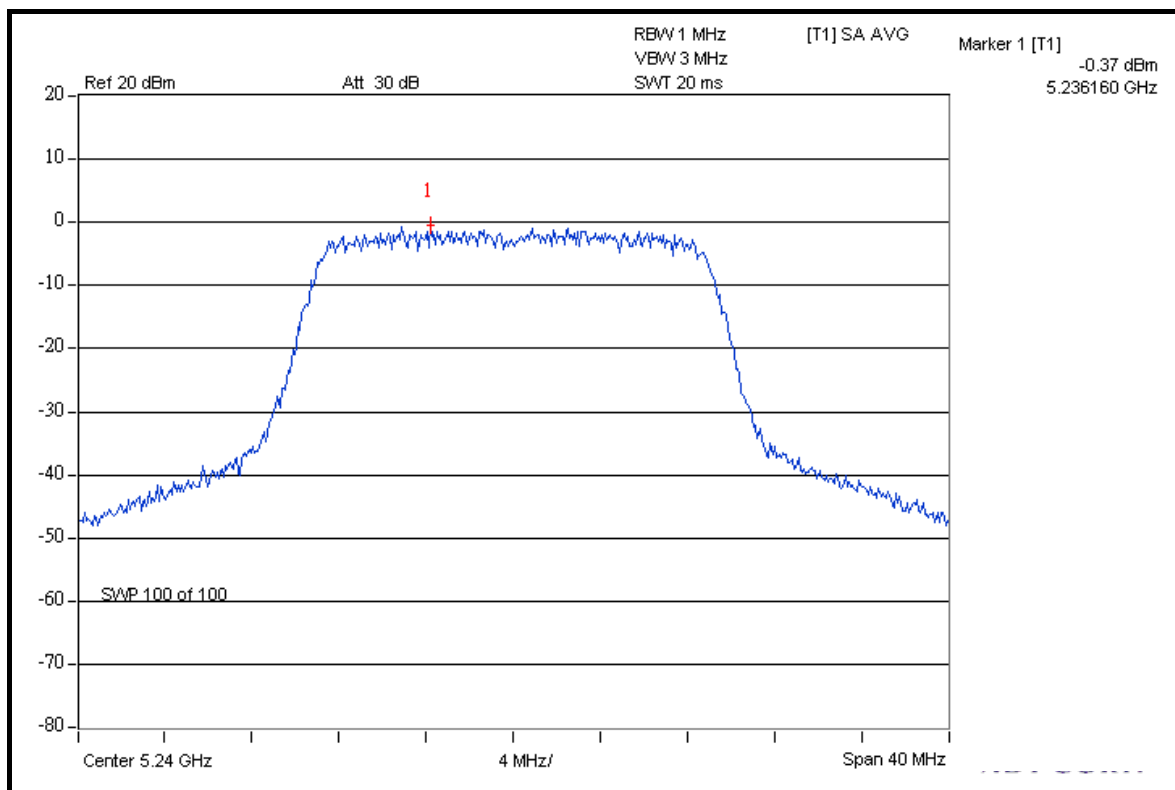



A D T

DRAFT 802.11n (40MHz) OFDM MODULATION

MODULATION TYPE	BPSK	TRANSFER RATE	15.0Mbps
INPUT POWER	120Vac, 60Hz	ENVIRONMENTAL CONDITIONS	23 deg.C, 66 %RH, 1021hPa
TESTED BY	Match Tsui		

CHAN.	CHAN. FREQ. (MHz)	RF POWER LEVEL IN 1MHz BW (dBm)		TOTAL POWER DENSITY (mW)	TOTAL POWER DENSITY (dBm)	MAX. LIMIT (dBm)	PASS / FAIL
		CHAIN 0	CHAIN 1				
38	5190	-5.48	-4.21	0.662	-1.79	4	PASS
46	5230	-5.28	-4.06	0.689	-1.62	4	PASS



A D T

FOR CHAIN 0: CH 38

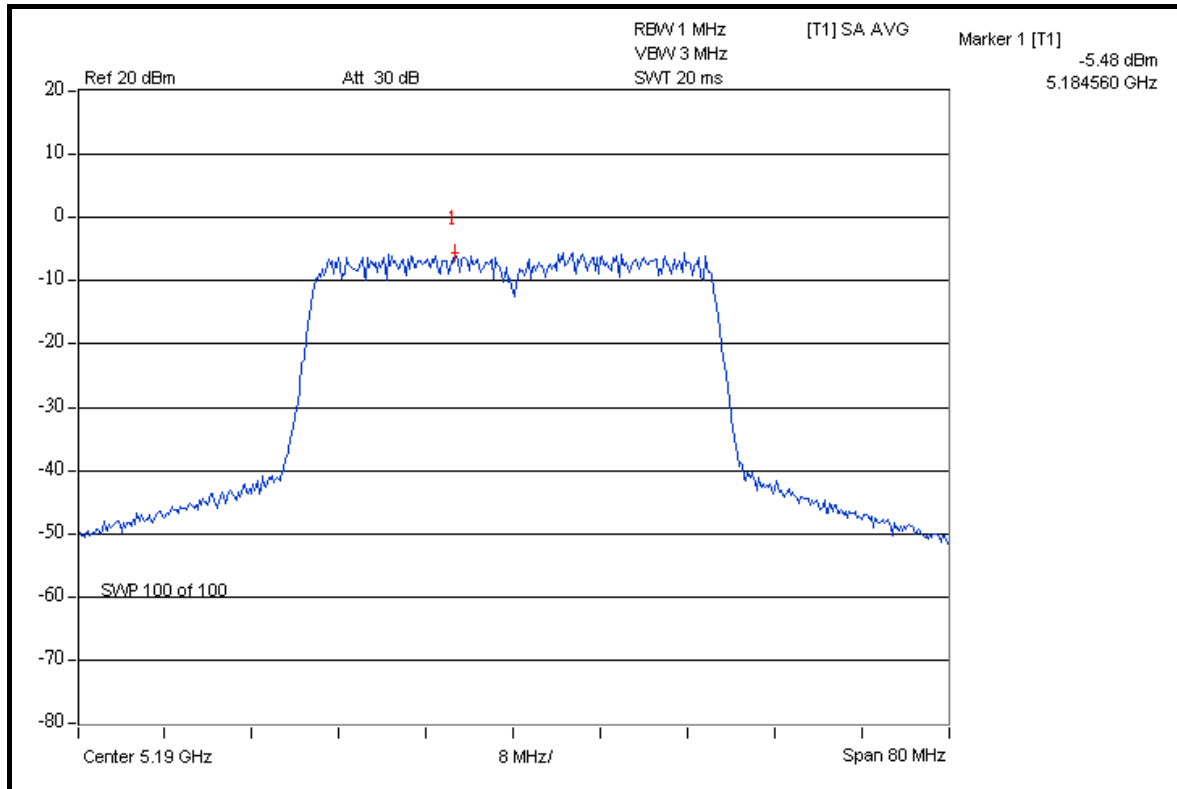

CH 46

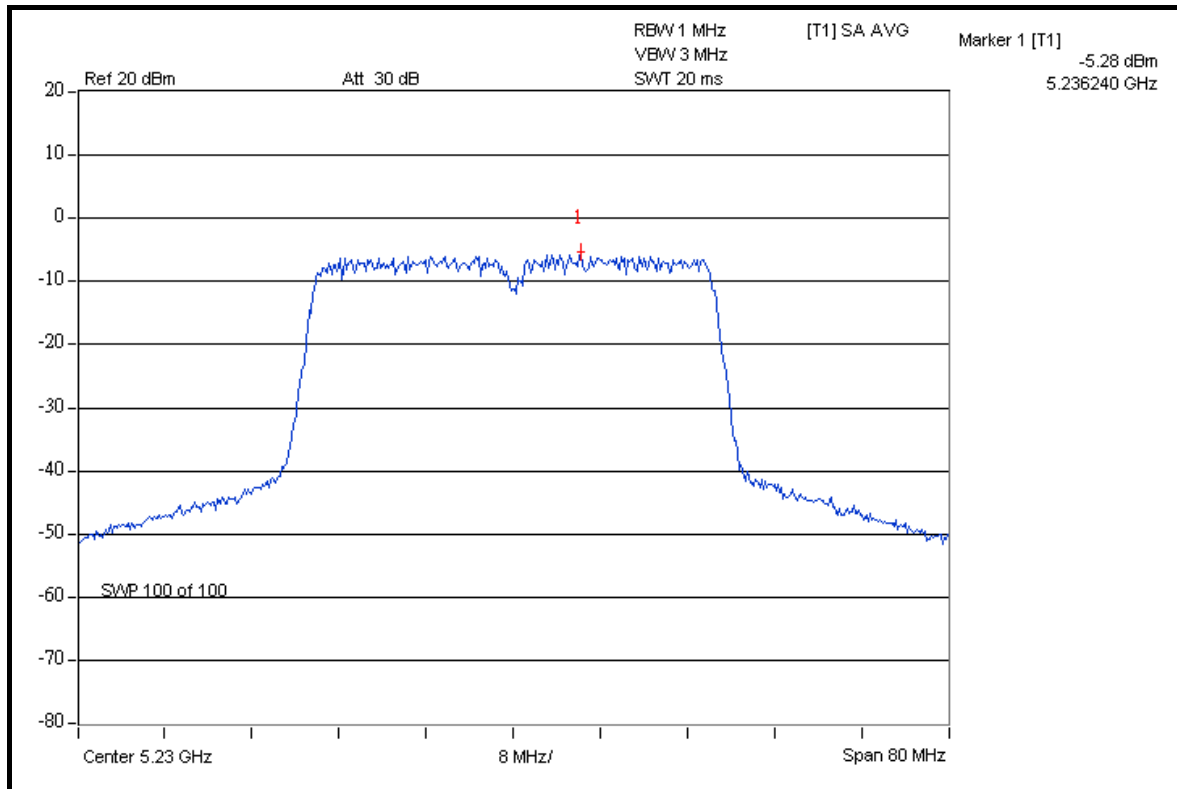



A D T

FOR CHAIN 1: CH 38

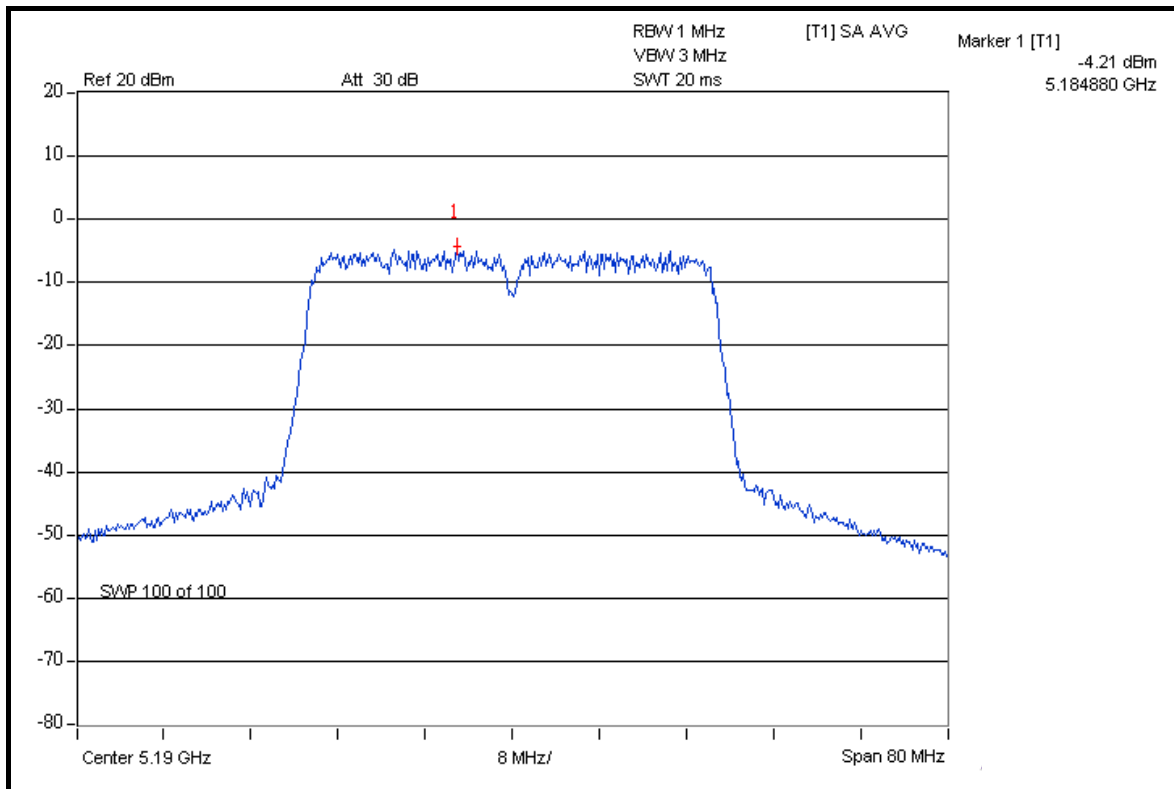

CH 46

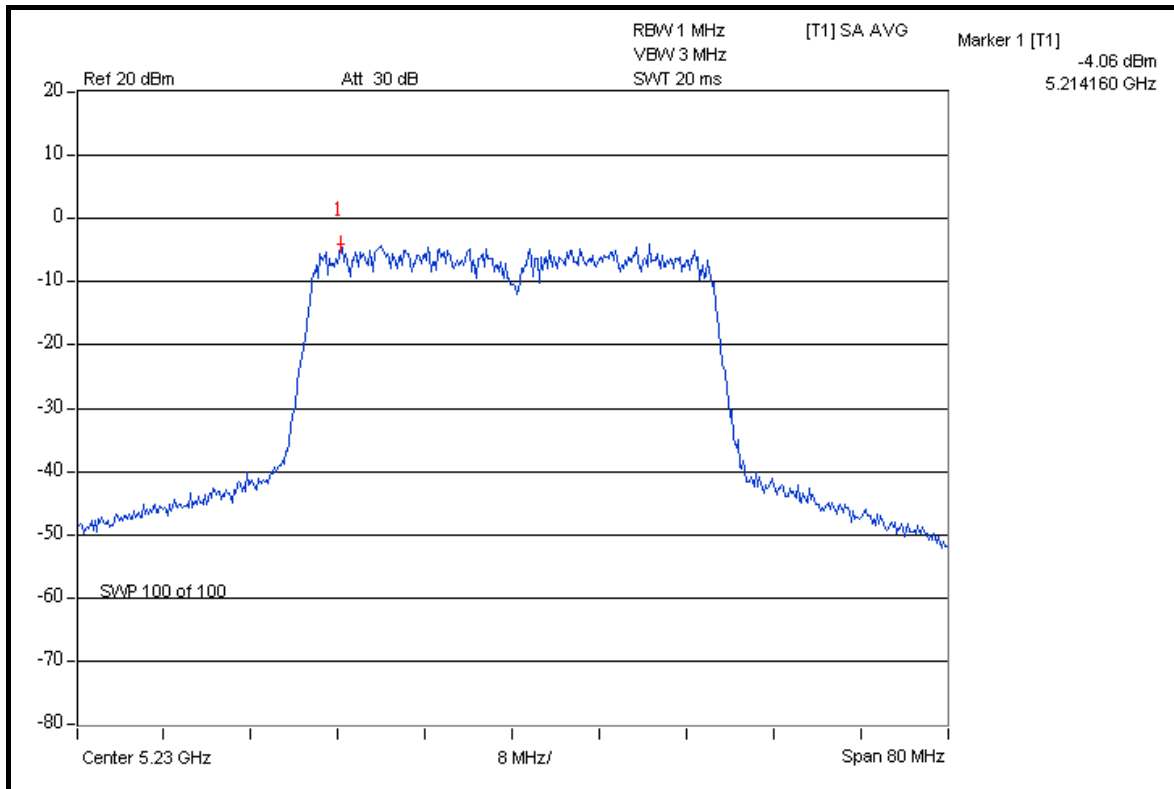

4.6 FREQUENCY STABILITY

4.6.1 LIMITS OF FREQUENCY STABILITY MEASUREMENT

The frequency tolerance of the carrier signal shall be maintained within +/- 0.02% of the operating frequency over a temperature variation of -30 degrees to 50 degrees C at normal supply voltage, and for a variation in the primary supply voltage from 85% to 115% of the rated supply voltage at a temperature of 20 degrees C.

4.6.2 TEST INSTRUMENTS

DESCRIPTION & MANUFACTURER	MODEL NO.	SERIAL NO.	DATE OF CALIBRATION	CALIBRATED UNTIL
ANRITSU SPECTRUM ANALYZER	MS2667C	M10281	Nov. 22, 2007	Nov. 21, 2008
WIT STANDARD TEMPERATURE AND HUMIDITY CHAMBER	TH-4S-C	W981030	Jun. 28, 2008	Jun. 27, 2009

NOTE: The calibration interval of the above test instruments is 12 months and the calibrations are traceable to NML/ROC and NIST/USA.

4.6.3 TEST PROCEDURE

- a. The EUT was placed inside the environmental test chamber and powered by nominal DC voltage.
- b. Turn the EUT on and couple its output to a spectrum analyzer.
- c. Turn the EUT off and set the chamber to the highest temperature specified.
- d. Allow sufficient time (approximately 30 min) for the temperature of the chamber to stabilize, turn the EUT on and measure the operating frequency after 2, 5, and 10 minutes.
- e. Repeat step 2 and 3 with the temperature chamber set to the lowest temperature.
- f. The test chamber was allowed to stabilize at +20 degree C for a minimum of 30 minutes. The supply voltage was then adjusted on the EUT from 85% to 115% and the frequency record.

4.6.4 DEVIATION FROM TEST STANDARD

No deviation.

4.6.5 TEST SETUP

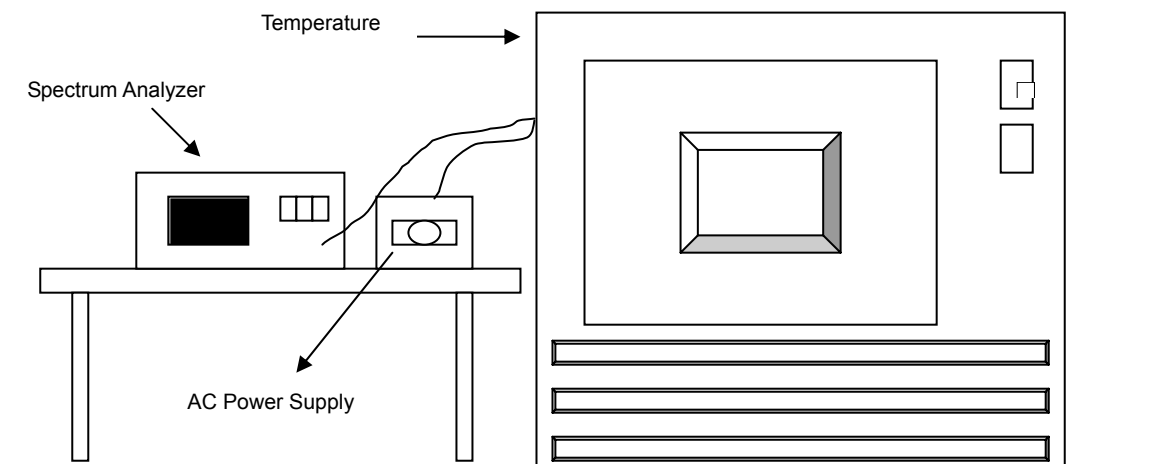

4.6.6 EUT OPERATING CONDITION

Same as Item 4.1.6.

4.6.7 TEST RESULTS

OPERATING FREQUENCY: 5200MHz						LIMIT: ± 0.01%			
TEMP. (°C)	POWER SUPPLY (Vac)	0 MINUTE		2 MINUTE		5 MINUTE		10 MINUTE	
		(MHz)	(%)	(MHz)	(%)	(MHz)	(%)	(MHz)	(%)
50	126.5	5199.999210	-0.0000152	5199.997674	-0.0000447	5199.997881	-0.0000407	5199.999322	-0.0000130
	110.0	5199.983595	-0.0003155	5200.003203	0.0000616	5200.003580	0.0000688	5199.983188	-0.0003233
	93.5	5199.987023	-0.0002496	5200.006522	0.0001254	5200.006408	0.0001232	5199.987064	-0.0002488
40	126.5	5199.979109	-0.0004017	5199.998746	-0.0000241	5199.998451	-0.0000298	5199.979230	-0.0003994
	110.0	5199.984885	-0.0002907	5200.004688	0.0000902	5200.004671	0.0000898	5199.984656	-0.0002951
	93.5	5199.997259	-0.0000527	5200.016807	0.0003232	5200.017066	0.0003282	5199.996731	-0.0000629
30	126.5	5199.979933	-0.0003859	5200.000274	0.0000053	5200.000598	0.0000115	5199.980157	-0.0003816
	110.0	5199.985989	-0.0002694	5200.005856	0.0001126	5200.006027	0.0001159	5199.986046	-0.0002683
	93.5	5200.003737	0.0000719	5200.023653	0.0004549	5200.023987	0.0004613	5200.004695	0.0000903
20	126.5	5199.986687	-0.0002560	5200.006821	0.0001312	5200.006591	0.0001268	5199.987150	-0.0002471
	110.0	5199.987330	-0.0002437	5200.007379	0.0001419	5200.007453	0.0001433	5199.987392	-0.0002425
	93.5	5200.011362	0.0002185	5200.031963	0.0006147	5200.031520	0.0006062	5200.011338	0.0002180
10	126.5	5199.994550	-0.0001048	5200.014146	0.0002720	5200.014305	0.0002751	5199.994447	-0.0001068
	110.0	5200.002694	0.0000518	5200.022701	0.0004366	5200.022665	0.0004359	5200.002416	0.0000465
	93.5	5200.018279	0.0003515	5200.037460	0.0007204	5200.037640	0.0007238	5200.017715	0.0003407
0	126.5	5199.997953	-0.0000394	5200.017402	0.0003347	5200.017703	0.0003404	5199.998021	-0.0000381
	110.0	5200.010285	0.0001978	5200.029510	0.0005675	5200.029816	0.0005734	5200.009935	0.0001911
	93.5	5200.024043	0.0004624	5200.044071	0.0008475	5200.043515	0.0008368	5200.024108	0.0004636
-10	126.5	5200.010149	0.0001952	5200.029695	0.0005711	5200.029514	0.0005676	5200.010079	0.0001938
	110.0	5200.017100	0.0003288	5200.037171	0.0007148	5200.037109	0.0007136	5200.016483	0.0003170
	93.5	5200.031414	0.0006041	5200.051377	0.0009880	5200.051176	0.0009842	5200.030706	0.0005905
-20	126.5	5200.015220	0.0002927	5200.035210	0.0006771	5200.035471	0.0006821	5200.015283	0.0002939
	110.0	5200.020595	0.0003961	5200.039712	0.0007637	5200.040077	0.0007707	5200.020671	0.0003975
	93.5	5200.034698	0.0006673	5200.055047	0.0010586	5200.054832	0.0010545	5200.034959	0.0006723
-30	126.5	5200.020979	0.0004034	5200.040571	0.0007802	5200.040571	0.0007802	5200.020514	0.0003945
	110.0	5200.035016	0.0006734	5200.054803	0.0010539	5200.054682	0.0010516	5200.034614	0.0006657
	93.5	5200.037377	0.0007188	5200.057860	0.0011127	5200.057307	0.0011021	5200.038065	0.0007320

4.7 BAND EDGES MEASUREMENT

4.7.1 TEST INSTRUMENTS

DESCRIPTION & MANUFACTURER	MODEL NO.	SERIAL NO.	DATE OF CALIBRATION	DUE DATE OF CALIBRATION
Test Receiver ROHDE & SCHWARZ	ESI7	100033	Jun. 30, 2008	Jun. 29, 2009
Spectrum Analyzer ROHDE & SCHWARZ	FSP40	100041	Apr. 22, 2008	Apr. 21, 2009
BILOG Antenna SCHWARZBECK	VULB9168	9168-160	May 02, 2008	May 01, 2009
HORN Antenna SCHWARZBECK	9120D	9120D-209	Jun. 24, 2008	Jun. 23, 2009
HORN Antenna SCHWARZBECK	BBHA 9170	BBHA9170243	Dec. 25, 2007	Dec. 24, 2008
Preamplifier Agilent	8447D	2944A10633	Nov. 03, 2008	Nov. 02, 2009
Preamplifier Agilent	8449B	3008A01964	Oct. 23, 2008	Oct. 22, 2009
RF signal cable HUBER+SUHNNER	SUCOFLEX 104	238141/4	May 20, 2008	May 19, 2009
RF signal cable HUBER+SUHNNER	SUCOFLEX 104	12738/6	May 20, 2008	May 19, 2009
Software ADT.	ADT_Radiated_V7.6	NA	NA	NA
Antenna Tower inn-co GmbH	MA 4000	013303	NA	NA
Antenna Tower Controller inn-co GmbH	CO2000	017303	NA	NA
Turn Table ADT.	TT100.	TT93021703	NA	NA
Turn Table Controller ADT.	SC100.	SC93021703	NA	NA

- NOTE:** 1. The calibration interval of the above test instruments is 12 months and the calibrations are traceable to NML/ROC and NIST/USA.
2. The test was performed in HwaYa Chamber 3.
3. The horn antenna and HP preamplifier (model: 8449B) are used only for the measurement of emission frequency above 1GHz if tested.
4. The FCC Site Registration No. is 988962.
5. The IC Site Registration No. is IC3789B-3.

4.7.2 TEST PROCEDURE

- a. The EUT was placed on the top of a rotating table 0.8 meters above the ground at a 3 meter semi-anechoic chamber. The table was rotated 360 degrees to determine the position of the highest radiation.
- b. The EUT was set 3 meters away from the interference-receiving antenna, which was mounted on the top of a variable-height antenna tower.
- c. The antenna is a broadband antenna, and its height is varied from one meter to four meters above the ground to determine the maximum value of the field strength. Both horizontal and vertical polarizations of the antenna are set to make the measurement.
- d. For each suspected emission, the EUT was arranged to its worst case and then the antenna was tuned to heights from 1 meter to 4 meters and the rotatable table was turned from 0 degrees to 360 degrees to find the maximum reading.
- e. Set both RBW and VBW of spectrum analyzer to 1MHz and 3MHz with suitable frequency span including 100MHz bandwidth from band edge. The band edges was measured and recorded.

NOTE: The resolution bandwidth of test receiver/spectrum analyzer is 1MHz and the video bandwidth is 10Hz for Average detection (AV) at frequency above 1GHz

4.7.3 EUT OPERATING CONDITION

The software provided by client to enable the EUT under transmission condition continuously at specific channel frequencies individually.

4.7.4 TEST RESULTS

For signals in the restricted bands above and below the 5.15 to 5.25GHz allocated band a measurement was made of the amplitude of the spurious emissions with respect to the intentional signals. The relative amplitude, in dBc, was applied to the average and peak field strength of the intentional signal made on the OATS to calculate the field strength of the unintentional signals.

The spectrum plots (Peak RBW = 1MHz, VBW = 3MHz) are attached on the following pages.

802.11a OFDM MODULATION

Channel 36 (5180MHz)

The band edge emission plot on the next page shows 47.08dBc between carrier maximum power and local maximum emission in restrict band. The emission of carrier strength list in the test result of channel 36 is 111.01dBuV/m (Peak), so the maximum field strength in restrict band is $111.01 - 47.08 = 63.93$ dBuV/m which is under 74dBuV/m limit.

The band edge emission plot on the next page shows 51.27dBc between carrier maximum power and local maximum emission in restrict band. The emission of carrier strength list in the test result of channel 36 is 99.74dBuV/m (Average), so the maximum field strength in restrict band is $99.74 - 51.27 = 48.47$ dBuV/m which is under 54dBuV/m limit.

Channel 48 (5240MHz)

The band edge emission plot on the next second page shows 49.10dBc between carrier maximum power and local maximum emission in restrict band. The emission of carrier strength list in the test result of channel 48 is 110.91dBuV/m (Peak), so the maximum field strength in restrict band is $110.91 - 49.10 = 61.81$ dBuV/m which is under 74dBuV/m limit.

The band edge emission plot on the next third page shows 52.02dBc between carrier maximum power and local maximum emission in restrict band. The emission of carrier strength list in the test result of channel 48 is 99.69dBuV/m (Average), so the maximum field strength in restrict band is $99.69 - 52.02 = 47.67$ dBuV/m which is under 54dBuV/m limit.



A D T

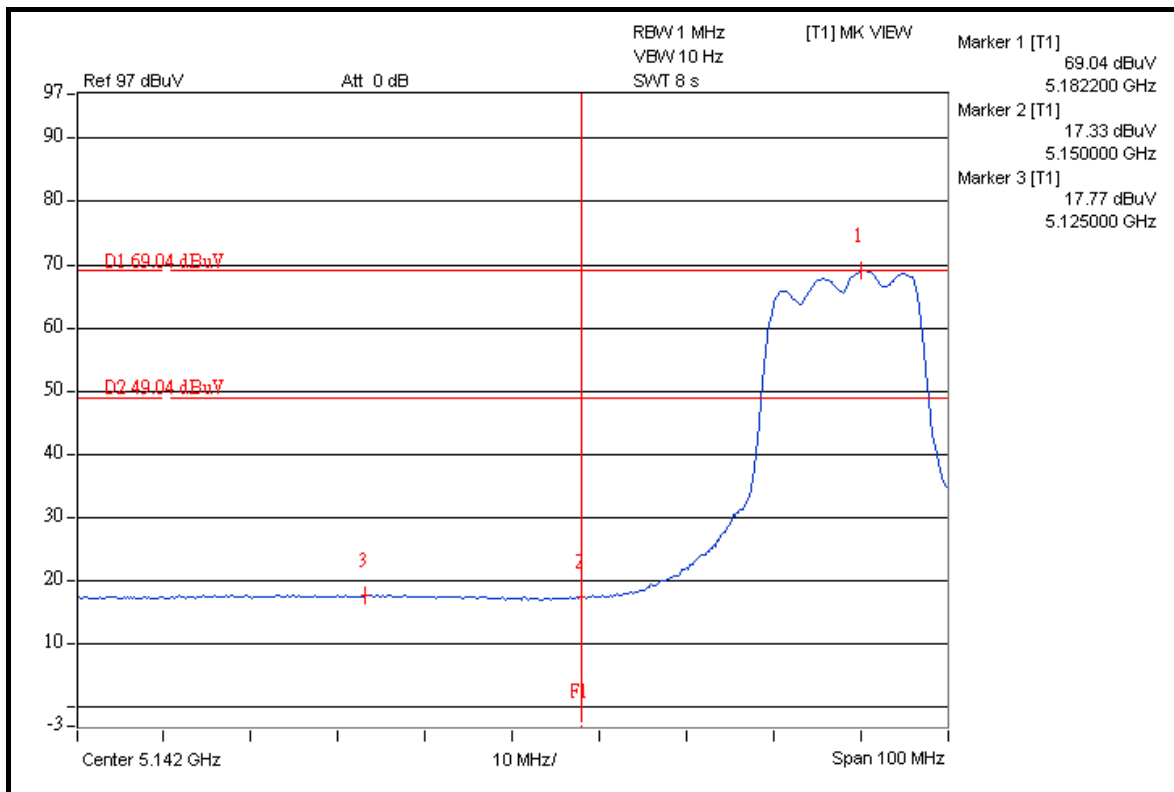
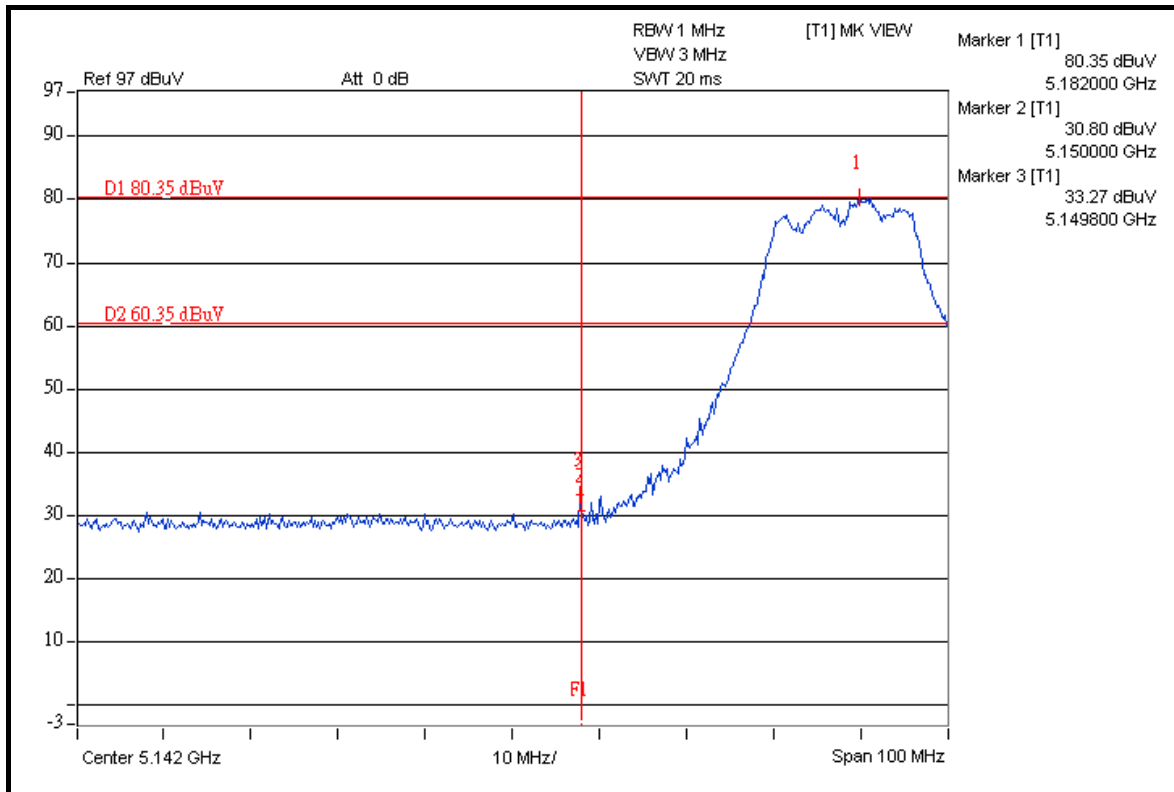



A D T

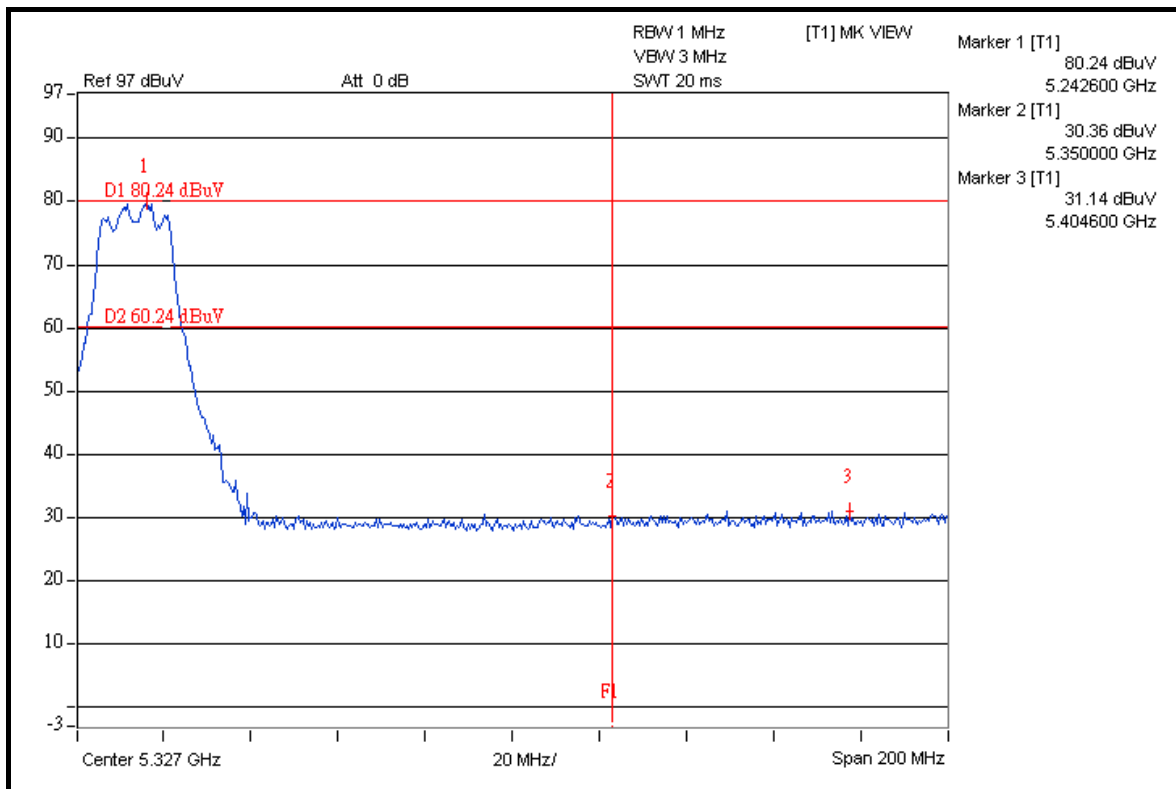
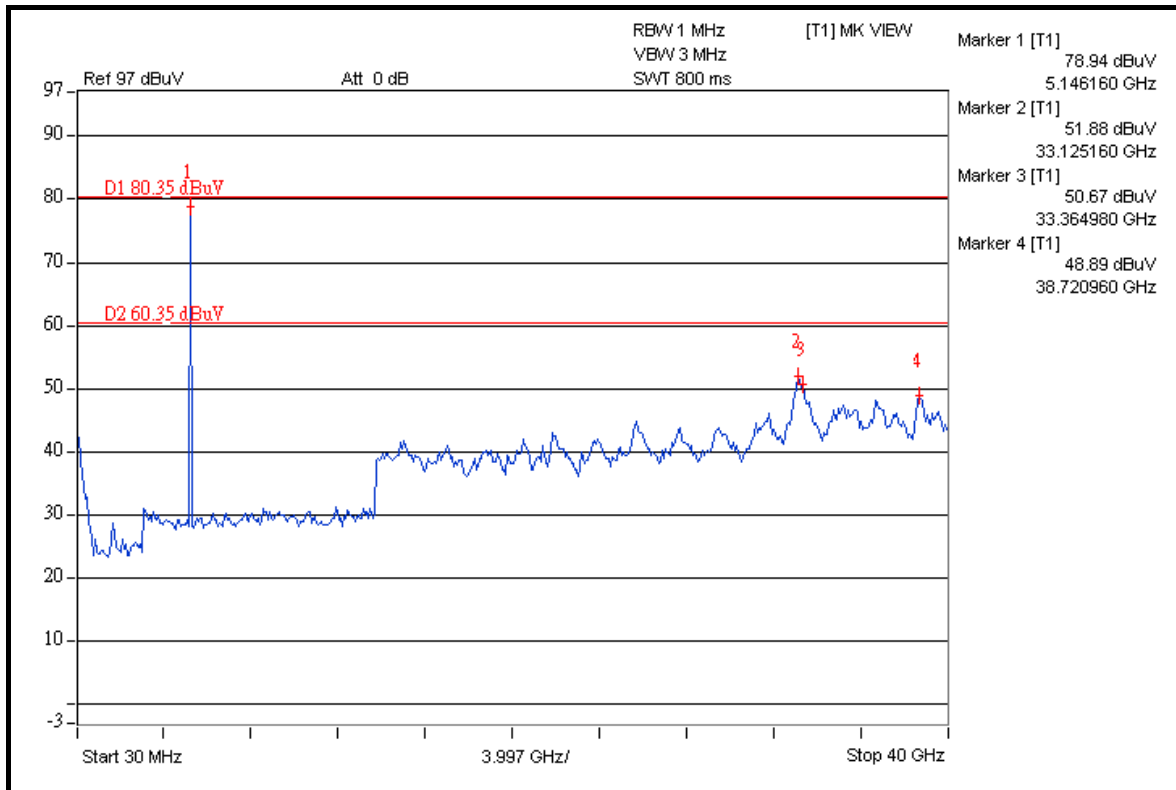



A D T

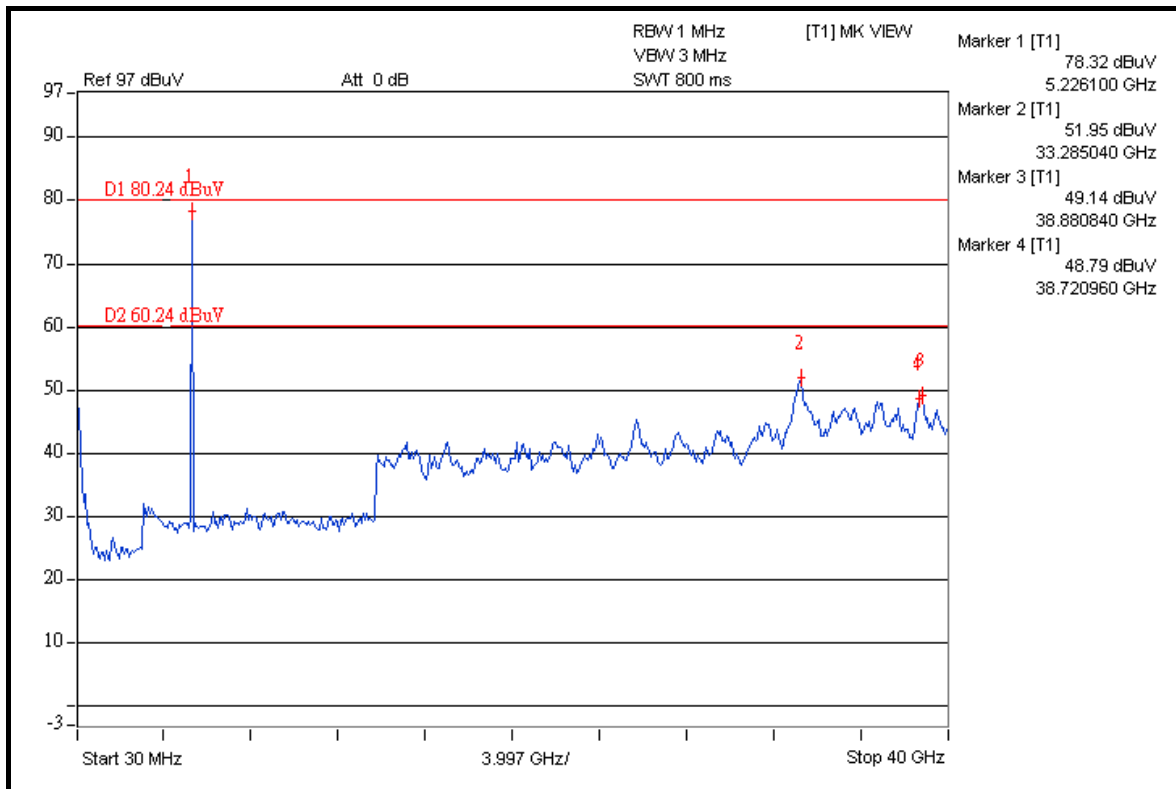
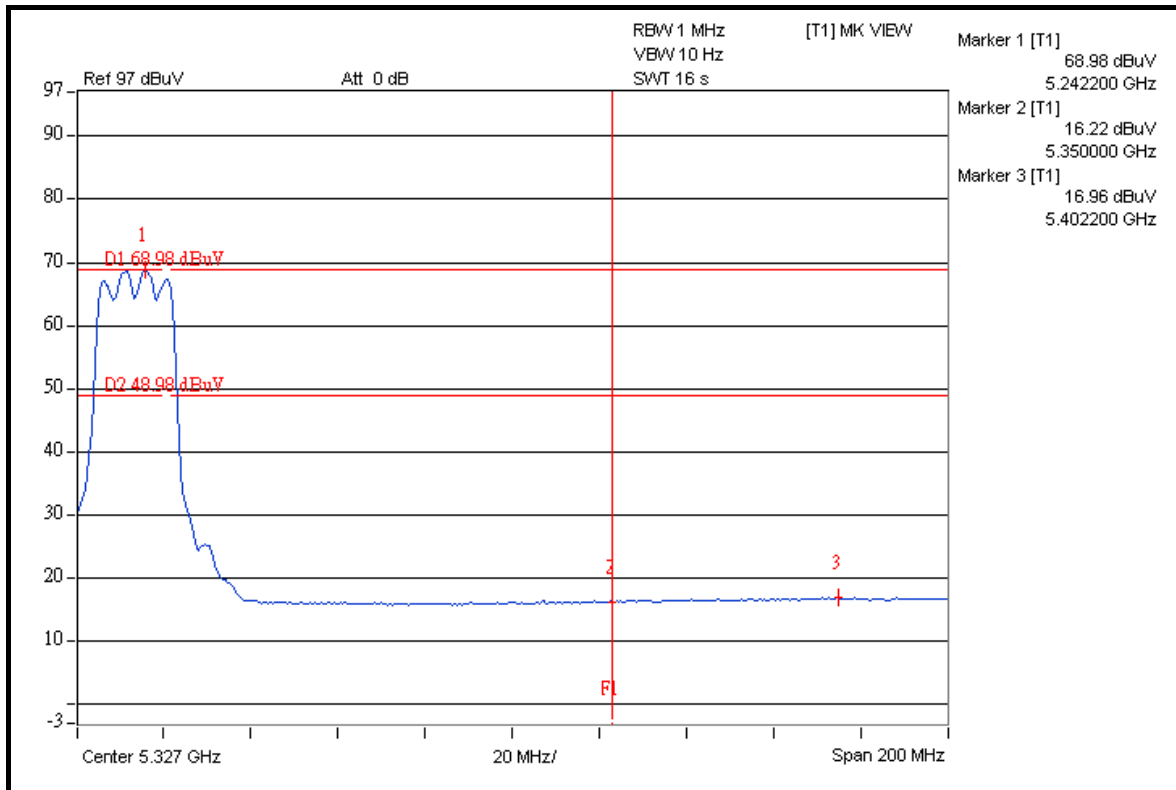

DRAFT 802.11n (20MHz) OFDM MODULATION

Channel 36 (5180MHz)

The band edge emission plot on the next page shows 47.17dBc between carrier maximum power and local maximum emission in restrict band. The emission of carrier strength list in the test result of channel 36 is 111.05dBuV/m (Peak), so the maximum field strength in restrict band is $111.05 - 47.17 = 63.34$ dBuV/m which is under 74dBuV/m limit.

The band edge emission plot on the next page shows 52.32dBc between carrier maximum power and local maximum emission in restrict band. The emission of carrier strength list in the test result of channel 36 is 100.45dBuV/m (Average), so the maximum field strength in restrict band is $100.45 - 52.32 = 48.13$ dBuV/m which is under 54dBuV/m limit.

Channel 48 (5240MHz)

The band edge emission plot on the next second page shows 49.74dBc between carrier maximum power and local maximum emission in restrict band. The emission of carrier strength list in the test result of channel 48 is 112.35dBuV/m (Peak), so the maximum field strength in restrict band is $112.35 - 49.74 = 62.61$ dBuV/m which is under 74dBuV/m limit.

The band edge emission plot on the next third page shows 51.86dBc between carrier maximum power and local maximum emission in restrict band. The emission of carrier strength list in the test result of channel 48 is 100.99dBuV/m (Average), so the maximum field strength in restrict band is $100.99 - 51.86 = 49.13$ dBuV/m which is under 54dBuV/m limit.



A D T

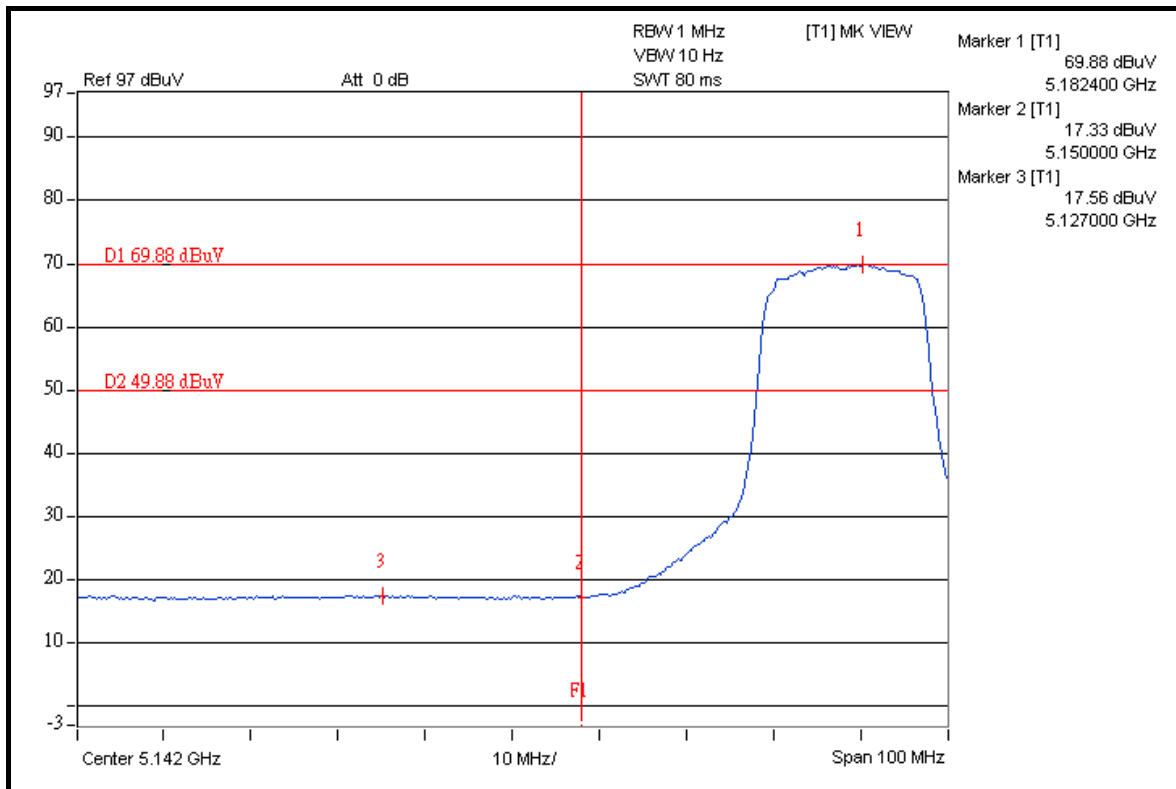
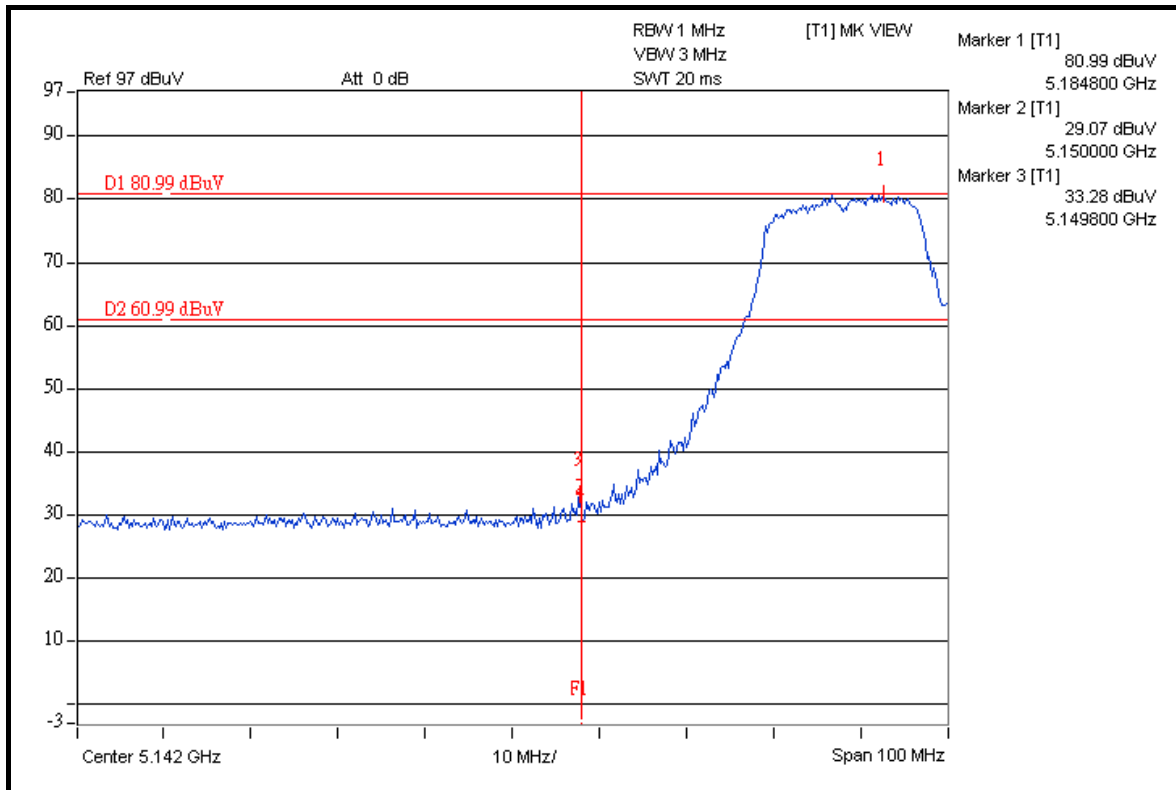



A D T

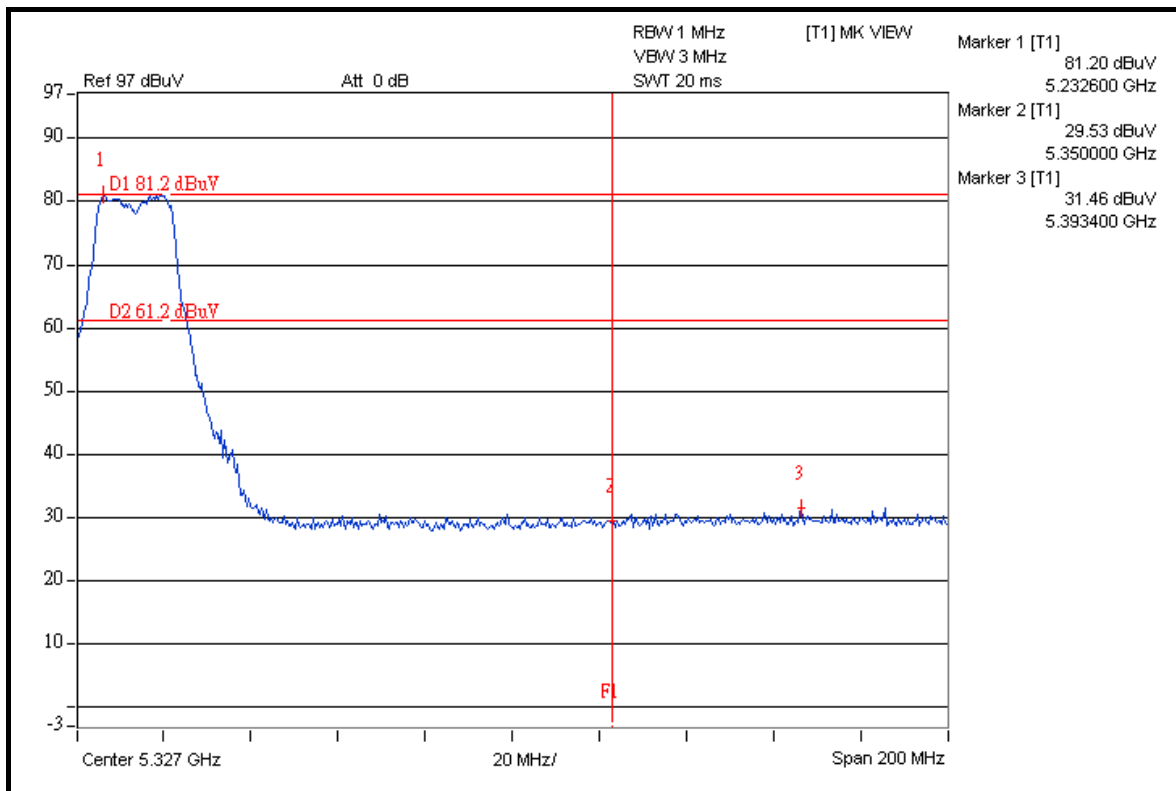
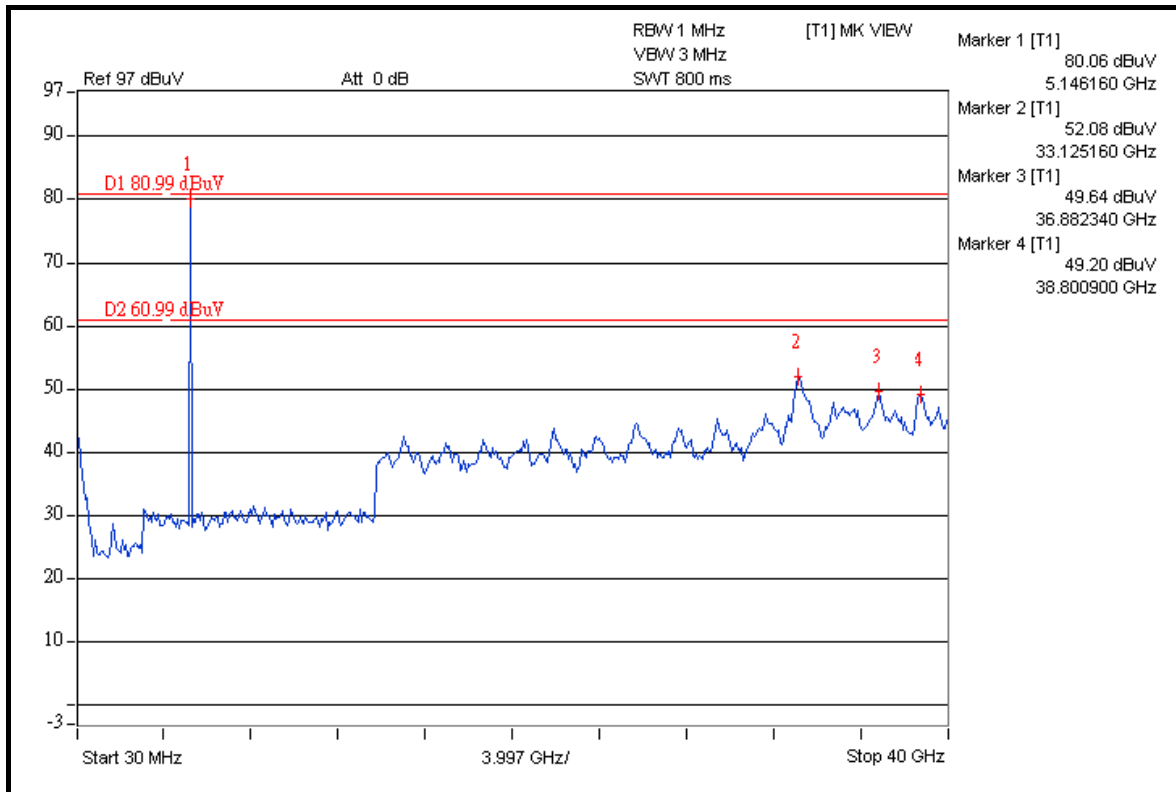



A D T

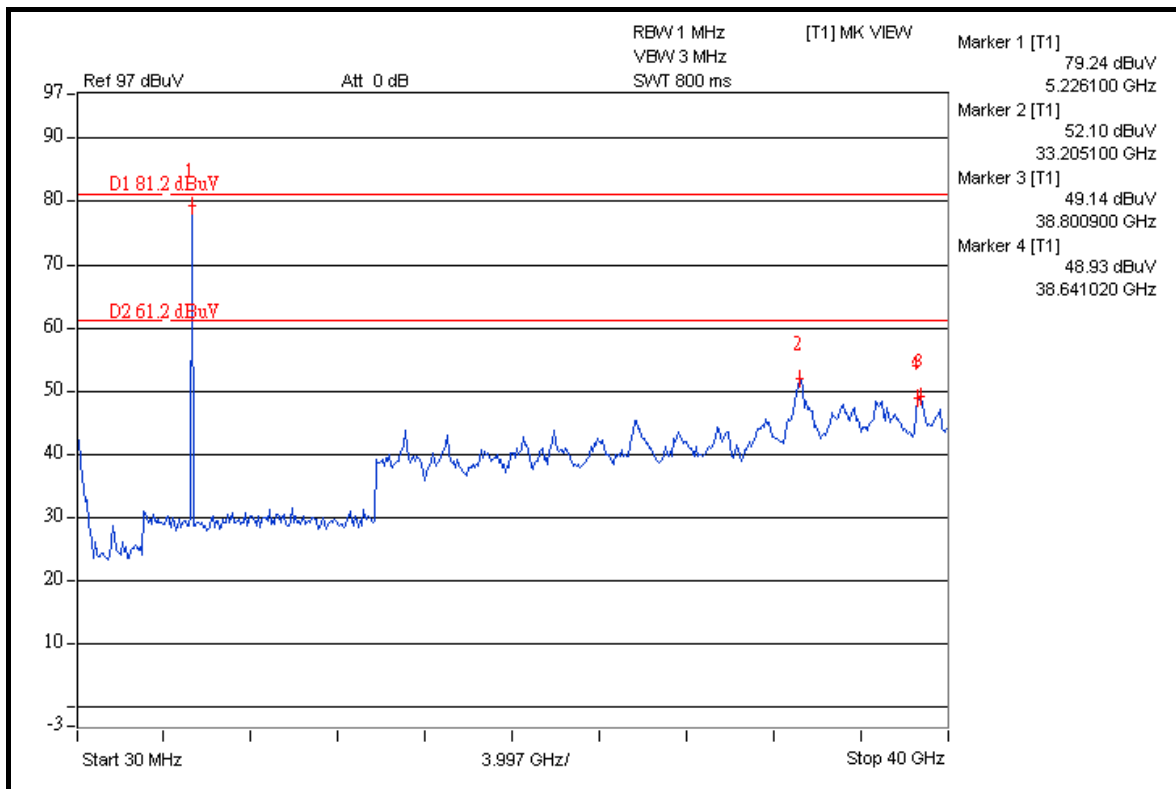
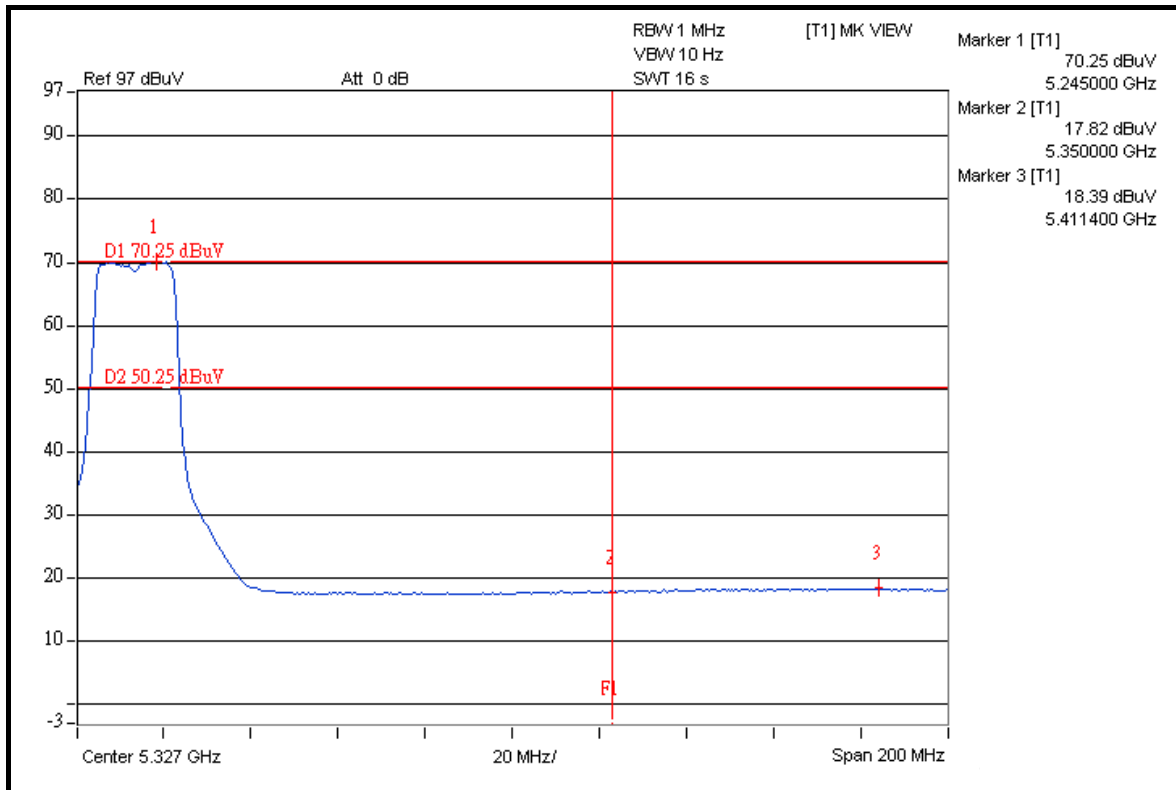

DRAFT 802.11n (40MHz) OFDM MODULATION

Channel 38 (5190MHz)

The band edge emission plot on the next page shows 46.56dBc between carrier maximum power and local maximum emission in restrict band. The emission of carrier strength list in the test result of channel 38 is 109.50dBuV/m (Peak), so the maximum field strength in restrict band is $109.50 - 46.56 = 62.94$ dBuV/m which is under 74dBuV/m limit.

The band edge emission plot on the next page shows 47.40dBc between carrier maximum power and local maximum emission in restrict band. The emission of carrier strength list in the test result of channel 38 is 97.21dBuV/m (Average), so the maximum field strength in restrict band is $97.21 - 47.40 = 49.81$ dBuV/m which is under 54dBuV/m limit.

Channel 46 (5230MHz)

The band edge emission plot on the next second page shows 47.42dBc between carrier maximum power and local maximum emission in restrict band. The emission of carrier strength list in the test result of channel 46 is 109.66dBuV/m (Peak), so the maximum field strength in restrict band is $109.66 - 47.42 = 62.24$ dBuV/m which is under 74dBuV/m limit.

The band edge emission plot on the next third page shows 48.71dBc between carrier maximum power and local maximum emission in restrict band. The emission of carrier strength list in the test result of channel 46 is 97.31dBuV/m (Average), so the maximum field strength in restrict band is $97.31 - 48.71 = 48.60$ dBuV/m which is under 54dBuV/m limit.



A D T

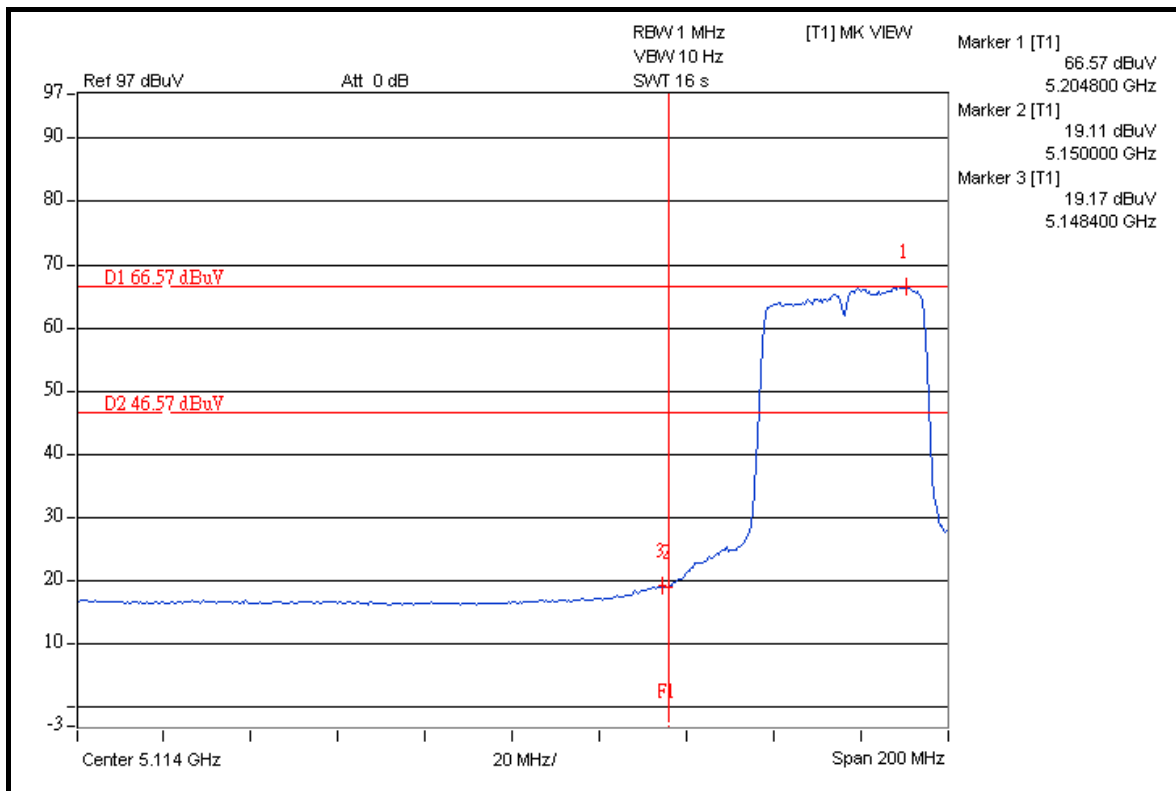
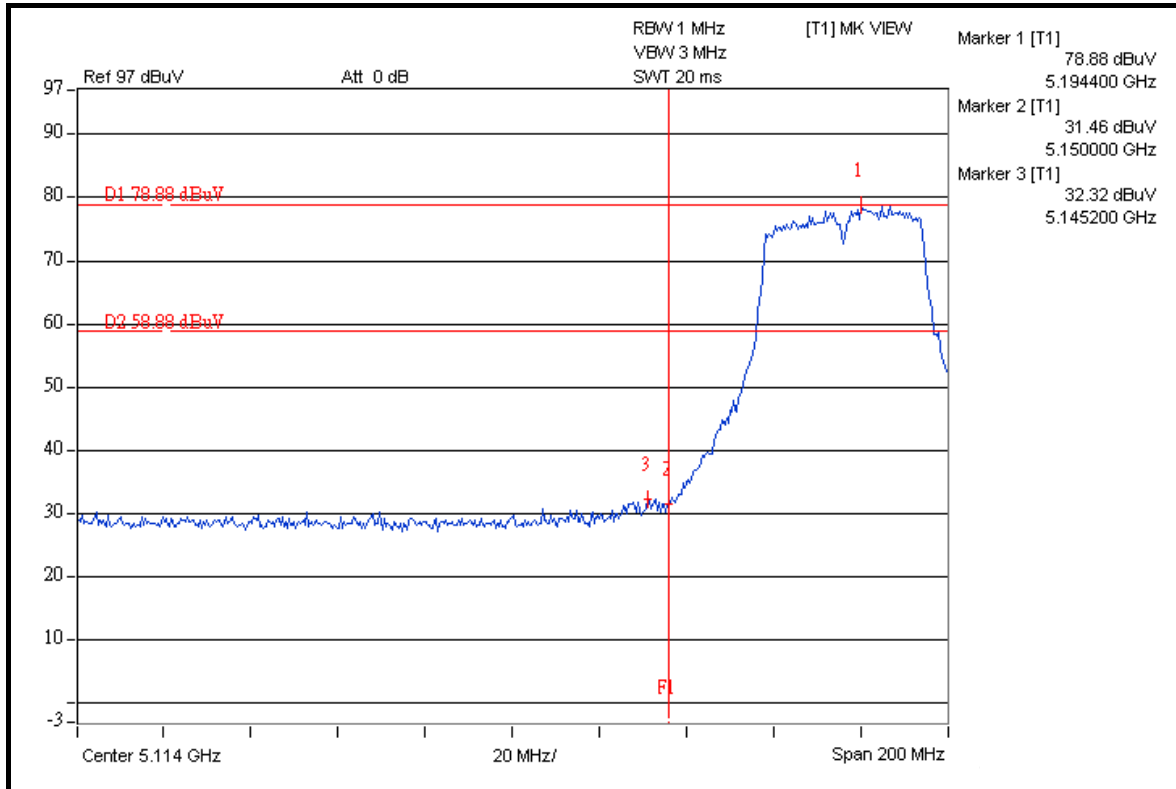



A D T

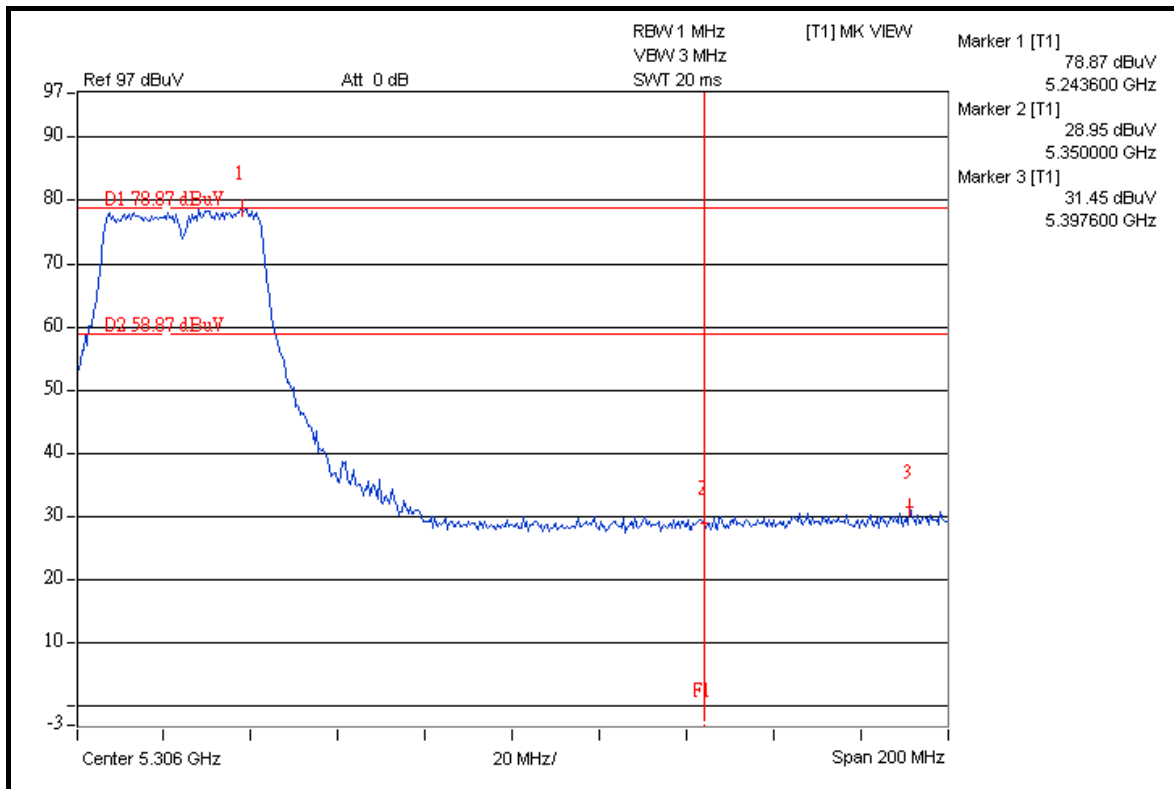
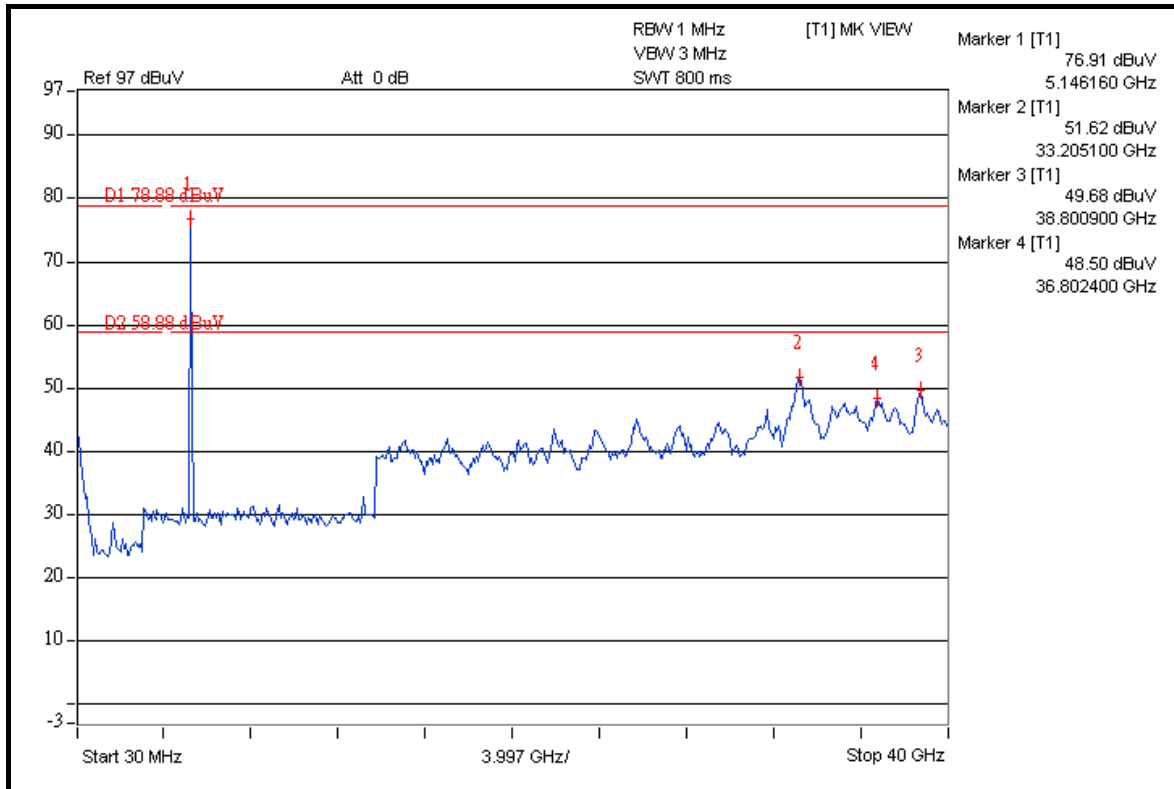



A D T

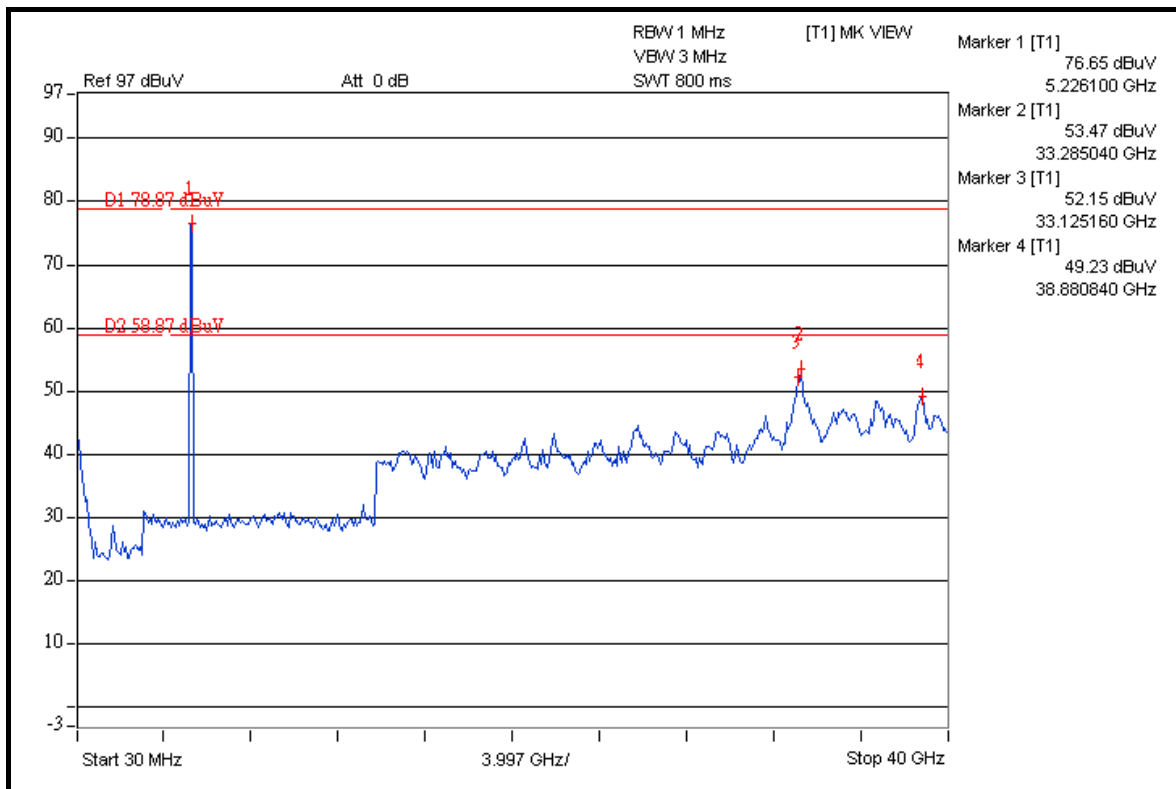
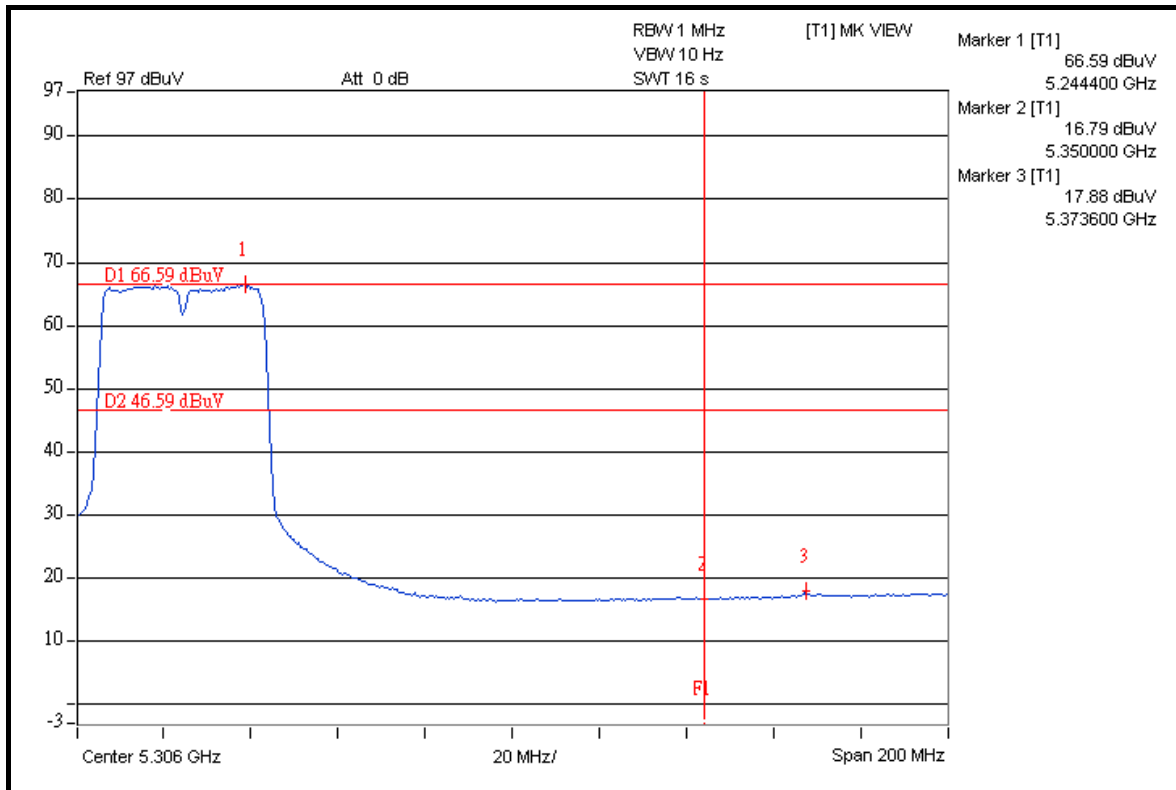

4.8 ANTENNA REQUIREMENT

4.8.1 STANDARD APPLICABLE

For intentional device, according to FCC 47 CFR Section 15.203, an intentional radiator shall be designed to ensure that no antenna other than that furnished by the responsible party shall be used with the device.

And according to FCC 47 CFR Section 15.407(a), if transmitting antennas of directional gain greater than 6dBi are used, the power shall be reduced by the amount in dB that the directional gain of the antenna exceeds 6dBi.

4.8.2 ANTENNA CONNECTED CONSTRUCTION

The antenna used in this product is Dipole antenna with R-SMA connector. The maximum gain of the antenna is 3dBi.

5. PHOTOGRAPHS OF THE TEST CONFIGURATION

Please refer to the attached file (Test Setup Photo).



6. INFORMATION ON THE TESTING LABORATORIES

We, Bureau Veritas Consumer Products Services (H.K.) Ltd., Taoyuan Branch, were founded in 1988 to provide our best service in EMC, Radio, Telecom and Safety consultation. Our laboratories are accredited and approved by the following approval agencies according to ISO/IEC 17025.

USA	FCC, UL, NVLAP
Germany	TUV Rheinland
Japan	VCCI
Norway	NEMKO
Canada	INDUSTRY CANADA , CSA
R.O.C.	TAF, BSMI, NCC
Netherlands	Telefication
Singapore	GOST-ASIA(MOU)
Russia	CERTIS(MOU)

Copies of accreditation certificates of our laboratories obtained from approval agencies can be downloaded from our web site:
www.adt.com.tw/index.5/phtml. If you have any comments, please feel free to contact us at the following:

Linko EMC/RF Lab:
Tel: 886-2-26052180
Fax: 886-2-26051924

Hsin Chu EMC/RF Lab:
Tel: 886-3-5935343
Fax: 886-3-5935342

Hwa Ya EMC/RF/Safety Telecom Lab:
Tel: 886-3-3183232
Fax: 886-3-3185050

Web Site: www.adt.com.tw

The address and road map of all our labs can be found in our web site also.

7. APPENDIX A - MODIFICATIONS RECORDERS FOR ENGINEERING CHANGES TO THE EUT BY THE LAB

No any modifications are made to the EUT by the lab during the test.

---END---