



A D T

FCC TEST REPORT (15.247)

REPORT NO.: RF971112L07

MODEL NO.: WLAN-2000
(refer to item 3.1 for more detail)

RECEIVED: Nov. 11, 2008

TESTED: Nov. 13 ~ Nov. 18, 2008

ISSUED: Nov. 27, 2008

APPLICANT: CAMEO COMMUNICATIONS, INC.

ADDRESS: 5F, No. 42, Sec. 6, Mincyuan E. Rd., Neihu
District, Taipei City 114, Taiwan

ISSUED BY: Bureau Veritas Consumer Products Services
(H.K.) Ltd., Taoyuan Branch

LAB ADDRESS: No. 47, 14th Ling, Chia Pau Tsuen, Lin Kou
Hsiang, Taipei Hsien 244, Taiwan, R.O.C.

TEST LOCATION: No. 19, Hwa Ya 2nd Rd, Wen Hwa Tsuen, Kwei
Shan Hsiang, Taoyuan Hsien 333, Taiwan,
R.O.C.

This test report consists of 166 pages in total. It may be duplicated completely for legal use with the approval of the applicant. It should not be reproduced except in full, without the written approval of our laboratory. The client should not use it to claim product endorsement by TAF or any government agencies. The test results in the report only apply to the tested sample.





A D T

TABLE OF CONTENTS

1.	CERTIFICATION.....	5
2.	SUMMARY OF TEST RESULTS	6
2.1	MEASUREMENT UNCERTAINTY.....	6
3.	GENERAL INFORMATION.....	7
3.1	GENERAL DESCRIPTION OF EUT	7
3.2	DESCRIPTION OF TEST MODES	9
3.2.1	CONFIGURATION OF SYSTEM UNDER TEST	9
3.2.2	TEST MODE APPLICABILITY AND TESTED CHANNEL DETAIL	10
3.3	GENERAL DESCRIPTION OF APPLIED STANDARDS	14
3.4	DESCRIPTION OF SUPPORT UNITS	14
4.	TEST TYPES AND RESULTS (FOR 2.4GHz BAND).....	15
4.1	RADIATED EMISSION MEASUREMENT	15
4.1.1	LIMITS OF RADIATED EMISSION MEASUREMENT.....	15
4.1.2	TEST INSTRUMENTS.....	16
4.1.3	TEST PROCEDURES	17
4.1.4	DEVIATION FROM TEST STANDARD.....	17
4.1.5	TEST SETUP.....	18
4.1.6	EUT OPERATING CONDITIONS	18
4.1.7	TEST RESULTS	19
4.2	CONDUCTED EMISSION MEASUREMENT	33
4.2.1	LIMITS OF CONDUCTED EMISSION MEASUREMENT	33
4.2.2	TEST INSTRUMENTS.....	33
4.2.3	TEST PROCEDURES	34
4.2.4	DEVIATION FROM TEST STANDARD.....	34
4.2.5	TEST SETUP.....	35
4.2.6	EUT OPERATING CONDITIONS	35
4.2.7	TEST RESULTS	36
4.3	6dB BANDWIDTH MEASUREMENT.....	40
4.3.1	LIMITS OF 6dB BANDWIDTH MEASUREMENT	40
4.3.2	TEST INSTRUMENTS.....	40
4.3.3	TEST PROCEDURE.....	40
4.3.4	DEVIATION FROM TEST STANDARD.....	40
4.3.5	TEST SETUP.....	41
4.3.6	EUT OPERATING CONDITIONS	41
4.3.7	TEST RESULTS	42
4.4	MAXIMUM PEAK OUTPUT POWER.....	58
4.4.1	LIMITS OF MAXIMUM PEAK OUTPUT POWER MEASUREMENT	58
4.4.2	INSTRUMENTS.....	58
4.4.3	TEST PROCEDURES	58
4.4.4	DEVIATION FROM TEST STANDARD.....	59
4.4.5	TEST SETUP.....	59
4.4.6	EUT OPERATING CONDITIONS	59
4.4.7	TEST RESULTS	60
4.5	POWER SPECTRAL DENSITY MEASUREMENT	62
4.5.1	LIMITS OF POWER SPECTRAL DENSITY MEASUREMENT	62
4.5.2	TEST INSTRUMENTS.....	62
4.5.3	TEST PROCEDURE.....	62
4.5.4	DEVIATION FROM TEST STANDARD.....	63



A D T

4.5.5	TEST SETUP	63
4.5.6	EUT OPERATING CONDITION.....	63
4.5.7	TEST RESULTS	64
4.6	BAND EDGES MEASUREMENT	80
4.6.1	LIMITS OF BAND EDGES MEASUREMENT.....	80
4.6.2	TEST INSTRUMENTS.....	80
4.6.3	TEST PROCEDURE.....	81
4.6.4	DEVIATION FROM TEST STANDARD.....	82
4.6.5	EUT OPERATING CONDITION.....	82
4.6.6	TEST RESULTS	83
4.7	ANTENNA REQUIREMENT	99
4.7.1	STANDARD APPLICABLE	99
4.7.2	ANTENNA CONNECTED CONSTRUCTION	99
5.	TEST TYPES AND RESULTS (FOR 5.0GHz BAND)	100
5.1	RADIATED EMISSION MEASUREMENT	100
5.1.1	LIMITS OF RADIATED EMISSION MEASUREMENT.....	100
5.1.2	TEST INSTRUMENTS.....	101
5.1.3	TEST PROCEDURES	102
5.1.4	DEVIATION FROM TEST STANDARD.....	102
5.1.5	TEST SETUP.....	103
5.1.6	EUT OPERATING CONDITIONS	103
5.1.7	TEST RESULTS	104
5.2	CONDUCTED EMISSION MEASUREMENT	114
5.2.1	LIMITS OF CONDUCTED EMISSION MEASUREMENT.....	114
5.2.2	TEST INSTRUMENTS.....	114
5.2.3	TEST PROCEDURES	115
5.2.4	DEVIATION FROM TEST STANDARD.....	115
5.2.5	TEST SETUP.....	116
5.2.6	EUT OPERATING CONDITIONS	116
5.2.7	TEST RESULTS	117
5.3	6dB BANDWIDTH MEASUREMENT.....	121
5.3.1	LIMITS OF 6dB BANDWIDTH MEASUREMENT	121
5.3.2	TEST INSTRUMENTS.....	121
5.3.3	TEST PROCEDURE.....	121
5.3.4	DEVIATION FROM TEST STANDARD.....	122
5.3.5	TEST SETUP.....	122
5.3.6	EUT OPERATING CONDITIONS	122
5.3.7	TEST RESULTS	123
5.4	MAXIMUM PEAK OUTPUT POWER.....	134
5.4.1	LIMITS OF MAXIMUM PEAK OUTPUT POWER MEASUREMENT	134
5.4.2	INSTRUMENTS.....	134
5.4.3	TEST PROCEDURES	134
5.4.4	DEVIATION FROM TEST STANDARD.....	135
5.4.5	TEST SETUP.....	135
5.4.6	EUT OPERATING CONDITIONS	135
5.4.7	TEST RESULTS	136
5.5	POWER SPECTRAL DENSITY MEASUREMENT.....	138
5.5.1	LIMITS OF POWER SPECTRAL DENSITY MEASUREMENT	138
5.5.2	TEST INSTRUMENTS.....	138
5.5.3	TEST PROCEDURE.....	138
5.5.4	DEVIATION FROM TEST STANDARD.....	139



A D T

5.5.5	TEST SETUP	139
5.5.6	EUT OPERATING CONDITION.....	139
5.5.7	TEST RESULTS	140
5.6	BAND EDGES MEASUREMENT	151
5.6.1	LIMITS OF BAND EDGES MEASUREMENT	151
5.6.2	TEST INSTRUMENTS.....	151
5.6.3	TEST PROCEDURE.....	152
5.6.4	DEVIATION FROM TEST STANDARD.....	153
5.6.5	EUT OPERATING CONDITION.....	153
5.6.6	TEST RESULTS	153
5.7	ANTENNA REQUIREMENT	163
5.7.1	STANDARD APPLICABLE	163
5.7.2	ANTENNA CONNECTED CONSTRUCTION	163
6.	PHOTOGRAPHS OF THE TEST CONFIGURATION.....	164
7.	INFORMATION ON THE TESTING LABORATORIES	165
8.	APPENDIX A - MODIFICATIONS RECORDERS FOR ENGINEERING CHANGES TO THE EUT BY THE LAB.....	166



A D T

1. CERTIFICATION

PRODUCT: 802.11a/b/g/n 2.4/5G Dual Band Access Point

MODEL: WLAN-2000 (refer to item 3.1 for more detail)

BRAND: CAMEO (refer to item 3.1 for more detail)

APPLICANT: CAMEO COMMUNICATIONS, INC.

TEST SAMPLE: ENGINEERING SAMPLE

TESTED: Nov. 13 ~ Nov. 18, 2008

STANDARDS: FCC Part 15, Subpart C (Section 15.247)

ANSI C63.4-2003

The above equipment (Model: WLAN-2000) has been tested by **Bureau Veritas Consumer Products Services (H.K.) Ltd., Taoyuan Branch**, and found compliance with the requirement of the above standards. The test record, data evaluation & Equipment Under Test (EUT) configurations represented herein are true and accurate accounts of the measurements of the sample's EMC characteristics under the conditions specified in this report.

PREPARED BY : Andrea Hsia , **DATE:** Nov. 27, 2008
Andrea Hsia / Specialist

TECHNICAL ACCEPTANCE : Long Chen , **DATE:** Nov. 27, 2008
Responsible for RF Long Chen / Senior Engineer

APPROVED BY : Gary Chang , **DATE:** Nov. 27, 2008
Gary Chang / Assistant Manager



2. SUMMARY OF TEST RESULTS

The EUT has been tested according to the following specifications:

APPLIED STANDARD: FCC PART 15, SUBPART C (SECTION 15.247)			
STANDARD SECTION	TEST TYPE AND LIMIT	RESULT	REMARK
15.207	AC Power Conducted Emission	PASS	Meet the requirement of limit. Minimum passing margin is -7.99dB at 17.299MHz
15.247(a)(2)	Spectrum Bandwidth of a Direct Sequence Spread Spectrum System Limit: min. 500kHz	PASS	Meet the requirement of limit.
15.247(b)	Maximum Peak Output Power Limit: max. 30dBm	PASS	Meet the requirement of limit.
15.247(d)	Radiated Emissions Limit: Table 15.209	PASS	Meet the requirement of limit. Minimum passing margin is -1.24dB at 2390.00MHz
15.247(e)	Power Spectral Density Limit: max. 8dBm	PASS	Meet the requirement of limit.
15.247(d)	Band Edge Measurement Limit: 20dB less than the peak value of fundamental frequency	PASS	Meet the requirement of limit.

2.1 MEASUREMENT UNCERTAINTY

Where relevant, the following measurement uncertainty levels have been estimated for tests performed on the EUT as specified in CISPR 16-4-2:

MEASUREMENT	FREQUENCY	UNCERTAINTY
Conducted emissions	9kHz~30MHz	2.44 dB
Radiated emissions	30MHz ~ 200MHz	3.34 dB
	200MHz ~1000MHz	3.35 dB
	1GHz ~ 18GHz	2.26 dB
	18GHz ~ 40GHz	1.94 dB

This uncertainty represents an expanded uncertainty expressed at approximately the 95% confidence level using a coverage factor of $k = 2$.



3. GENERAL INFORMATION

3.1 GENERAL DESCRIPTION OF EUT

EUT	802.11a/b/g/n 2.4/5G Dual Band Access Point
MODEL NO.	WLAN-2000 (refer to note as below)
FCC ID	NHPWLAN2000
POWER SUPPLY	5.0Vdc from AC adapter 7.5Vdc from AC adapter
MODULATION TYPE	CCK, DQPSK, DBPSK for DSSS 64QAM, 16QAM, QPSK, BPSK for OFDM
MODULATION TECHNOLOGY	DSSS, OFDM
TRANSFER RATE	802.11b: 11.0/ 5.5/ 2.0/ 1.0Mbps 802.11g: 54.0/ 48.0/ 36.0/ 24.0/ 18.0/ 12.0/ 9.0/ 6.0Mbps 802.11a: 54.0/ 48.0/ 36.0/ 24.0/ 18.0/ 12.0/ 9.0/ 6.0Mbps Draft 802.11n: up to 300.0Mbps
FREQUENCY RANGE	2.4GHz: 2400.0 ~ 2483.5MHz 5.0GHz: 5150.0 ~ 5250.0MHz, 5725.0 ~ 5825.0MHz
NUMBER OF CHANNEL	2.4GHz: 11 for 802.11b, 802.11g, draft 802.11n (20MHz) 7 for draft 802.11n (40MHz) 5.0GHz: 9 for 802.11a, draft 802.11n (20MHz) 4 for draft 802.11n (40MHz)
OUTPUT POWER	361.851mW for 2400.0 ~ 2483.5MHz 43.825mW for 5150.0 ~ 5250.0MHz 320.882mW for 5725.0 ~ 5825.0MHz
ANTENNA TYPE	2.4GHz: Dipole antenna with 2.0dBi gain 5.0GHz: Dipole antenna with 3.0dBi gain Dipole antenna with 2.0dBi gain
DATA CABLE	NA
I/O PORTS	RJ45
ASSOCIATED DEVICES	Adapter

NOTE:

- The EUT is a 802.11a/b/g/n 2.4/5G Dual Band Access Point. The functions of EUT listed as below:

	TEST STANDARD	REFERENCE REPORT
WLAN 802.11b/g, draft 802.11n	FCC Part 15, Subpart C (Section 15.247)	RF971112L07
WLAN 802.11a, draft 802.11n (5725~5825 MHz)		
WLAN 802.11a, draft 802.11n (5150~ 5250MHz)	FCC Part 15, Subpart E (Section 15.407)	RF971112L07-1

2. The following models are provided to this EUT.

BRAND	MODEL NAME	REMARK
CAMEO	WLAN-2000	For marketing different
TRENDnet	TEW-670APB	For marketing different

3. The frequency bands used in this EUT are listed as follows:

Frequency Band (MHz)	2400~2483.5	5150~5250	5725~5825
802.11b	√		
802.11g	√		
802.11a		√	√
Draft 802.11n (20MHz)	√	√	√
Draft 802.11n (40MHz)	√	√	√

4. The EUT was powered by the following adapters:

ADAPTER 1	
BRAND:	JENTEC TECHNOLOGY CO., LTD.
MODEL:	AF1805-A
INPUT:	100-120Vac, 0.4A, 50-60Hz
OUTPUT:	5.0Vdc, 2.5A
POWER LINE:	1.8m non-shielded cable without core

ADAPTER 2	
BRAND:	LEADER ELECTRONICS INC.
MODEL:	MT12-Y075100-A1
INPUT:	100-120Vac, 60Hz, 0.3A
OUTPUT:	7.5Vdc, 1A
POWER LINE:	1.8m non-shielded cable without core

5. The EUT incorporates a MIMO function. Physically, the EUT provides two completed transmitters and two receivers.

MODULATION MODE	TX FUNCTION
802.11b	2TX
802.11g	2TX
802.11a	2TX
Draft 802.11n (20MHz)	2TX
Draft 802.11n (40MHz)	2TX

6. The above EUT information was declared by manufacturer and for more detailed features description, please refer to the manufacturer's specifications or user's manual.

3.2 DESCRIPTION OF TEST MODES

FOR 2.4GHz:

11 channels are provided for 802.11b, 802.11g and draft 802.11n (20MHz):

CHANNEL	FREQUENCY	CHANNEL	FREQUENCY
1	2412MHz	7	2442MHz
2	2417MHz	8	2447MHz
3	2422MHz	9	2452MHz
4	2427MHz	10	2457MHz
5	2432MHz	11	2462MHz
6	2437MHz		

7 channels are provided for draft 802.11n (40MHz):

CHANNEL	FREQUENCY	CHANNEL	FREQUENCY
1	2422MHz	5	2442MHz
2	2427MHz	6	2447MHz
3	2432MHz	7	2452MHz
4	2437MHz		

FOR 5.0GHz (5725 ~ 5825MHz):

5 channels are provided for 802.11a, draft 802.11n (20MHz):

CHANNEL	FREQUENCY	CHANNEL	FREQUENCY
149	5745MHz	161	5805MHz
153	5765MHz	165	5825MHz
157	5785MHz		

2 channels are provided for draft 802.11n (40MHz):

CHANNEL	FREQUENCY	CHANNEL	FREQUENCY
151	5755MHz	159	5795MHz

3.2.1 CONFIGURATION OF SYSTEM UNDER TEST

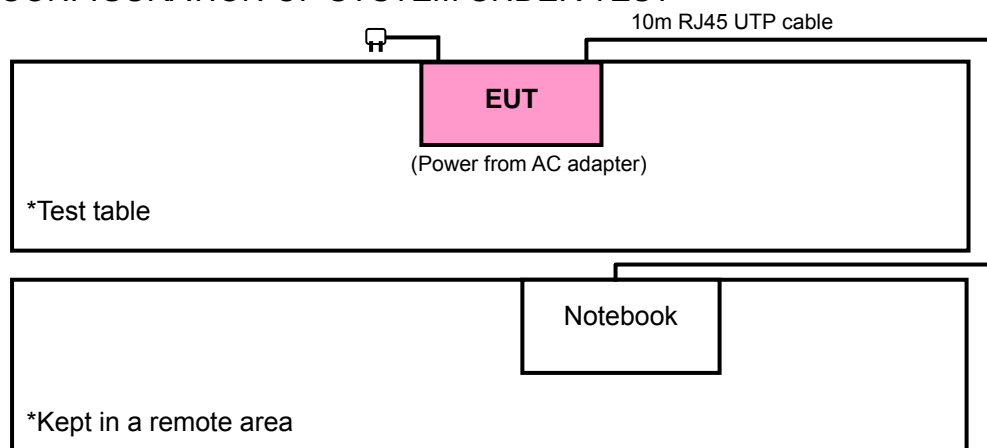



3.2.2 TEST MODE APPLICABILITY AND TESTED CHANNEL DETAIL FOR 2.400 ~ 2.4835GHz:

EUT CONFIGURE MODE	APPLICABLE TO				DESCRIPTION
	RE≥1G	RE<1G	PLC	APCM	
A	√	√	√	√	Power from AC Adapter 1
B	-	√	√	-	Power from AC Adapter 2

Where **RE≥1G**: Radiated Emission above 1GHz **RE<1G**: Radiated Emission below 1GHz
PLC: Power Line Conducted Emission **APCM**: Antenna Port Conducted Measurement
Note: "-" means no effect.

RADIATED EMISSION TEST (ABOVE 1GHz):

- Pre-Scan has been conducted to determine the worst-case mode from all possible combinations between available modulations, data rates and antenna ports (if EUT with antenna diversity architecture).
- Following channel(s) was (were) selected for the final test as listed below.

EUT CONFIGURE MODE	MODE	AVAILABLE CHANNEL	TESTED CHANNEL	MODULATION TECHNOLOGY	MODULATION TYPE	DATA RATE (Mbps)
A	802.11b	1 to 11	1, 6, 11	DSSS	DBPSK	1.0
A	802.11g	1 to 11	1, 6, 11	OFDM	BPSK	6.0
A	Draft 802.11n (20MHz)	1 to 11	1, 6, 11	OFDM	BPSK	7.2
A	Draft 802.11n (40MHz)	1 to 7	1, 4, 7	OFDM	BPSK	15.0

RADIATED EMISSION TEST (BELOW 1GHz):

- Pre-Scan has been conducted to determine the worst-case mode from all possible combinations between available modulations, data rates and antenna ports (if EUT with antenna diversity architecture).
- Following channel(s) was (were) selected for the final test as listed below.

EUT CONFIGURE MODE	MODE	AVAILABLE CHANNEL	TESTED CHANNEL	MODULATION TECHNOLOGY	MODULATION TYPE	DATA RATE (Mbps)
A	802.11g	1 to 11	6	OFDM	BPSK	6.0
B	802.11g	1 to 11	6	OFDM	BPSK	6.0

POWER LINE CONDUCTED EMISSION TEST:

- Pre-Scan has been conducted to determine the worst-case mode from all possible combinations between available modulations, data rates and antenna ports (if EUT with antenna diversity architecture).
- Following channel(s) was (were) selected for the final test as listed below.

EUT CONFIGURE MODE	MODE	AVAILABLE CHANNEL	TESTED CHANNEL	MODULATION TECHNOLOGY	MODULATION TYPE	DATA RATE (Mbps)
A	802.11g	1 to 11	6	OFDM	BPSK	6.0
B	802.11g	1 to 11	6	OFDM	BPSK	6.0



BANDEDGE MEASUREMENT:

- Pre-Scan has been conducted to determine the worst-case mode from all possible combinations between available modulations, data rates and antenna ports (if EUT with antenna diversity architecture).
- Following channel(s) was (were) selected for the final test as listed below.

EUT CONFIGURE MODE	MODE	AVAILABLE CHANNEL	TESTED CHANNEL	MODULATION TECHNOLOGY	MODULATION TYPE	DATA RATE (Mbps)
A	802.11b	1 to 11	1, 11	DSSS	DBPSK	1.0
A	802.11g	1 to 11	1, 11	OFDM	BPSK	6.0
A	Draft 802.11n (20MHz)	1 to 11	1, 11	OFDM	BPSK	7.2
A	Draft 802.11n (40MHz)	1 to 7	1, 7	OFDM	BPSK	15.0

ANTENNA PORT CONDUCTED MEASUREMENT:

- Pre-Scan has been conducted to determine the worst-case mode from all possible combinations between available modulations, data rates and antenna ports (if EUT with antenna diversity architecture).
- Following channel(s) was (were) selected for the final test as listed below.

EUT CONFIGURE MODE	MODE	AVAILABLE CHANNEL	TESTED CHANNEL	MODULATION TECHNOLOGY	MODULATION TYPE	DATA RATE (Mbps)
A	802.11b	1 to 11	1, 6, 11	DSSS	DBPSK	1.0
A	802.11g	1 to 11	1, 6, 11	OFDM	BPSK	6.0
A	Draft 802.11n (20MHz)	1 to 11	1, 6, 11	OFDM	BPSK	7.2
A	Draft 802.11n (40MHz)	1 to 7	1, 4, 7	OFDM	BPSK	15.0



A D T

FOR 5.725 ~ 5.825GHz:

EUT CONFIGURE MODE	APPLICABLE TO				DESCRIPTION
	RE≥1G	RE<1G	PLC	APCM	
A	√	√	√	√	Power from AC Adapter 1
B	-	√	√	-	Power from AC Adapter 2

Where **PLC:** Power Line Conducted Emission **RE<1G:** Radiated Emission below 1GHz
RE≥1G: Radiated Emission above 1GHz **APCM:** Antenna Port Conducted Measurement
Note: “-” means no effect.

RADIATED EMISSION TEST (ABOVE 1GHz):

- Pre-Scan has been conducted to determine the worst-case mode from all possible combinations between available modulations, data rates and antenna ports (if EUT with antenna diversity architecture).
- Following channel(s) was (were) selected for the final test as listed below.

EUT CONFIGURE MODE	MODE	AVAILABLE CHANNEL	TESTED CHANNEL	MODULATION TECHNOLOGY	MODULATION TYPE	DATA RATE (Mbps)
A	802.11a	149 to 165	149, 157, 165	OFDM	BPSK	6.0
A	Draft 802.11n (20MHz)	149 to 165	149, 157, 165	OFDM	BPSK	7.2
A	Draft 802.11n (40MHz)	151 to 159	151, 159	OFDM	BPSK	15.0

RADIATED EMISSION TEST (BELOW 1GHz):

- Pre-Scan has been conducted to determine the worst-case mode from all possible combinations between available modulations, data rates and antenna ports (if EUT with antenna diversity architecture).
- Following channel(s) was (were) selected for the final test as listed below.

EUT CONFIGURE MODE	MODE	AVAILABLE CHANNEL	TESTED CHANNEL	MODULATION TECHNOLOGY	MODULATION TYPE	DATA RATE (Mbps)
A	802.11a	149 to 165	165	OFDM	BPSK	6.0
B	802.11a	149 to 165	165	OFDM	BPSK	6.0

POWER LINE CONDUCTED EMISSION TEST:

- Pre-Scan has been conducted to determine the worst-case mode from all possible combinations between available modulations, data rates and antenna ports (if EUT with antenna diversity architecture).
- Following channel(s) was (were) selected for the final test as listed below.

EUT CONFIGURE MODE	MODE	AVAILABLE CHANNEL	TESTED CHANNEL	MODULATION TECHNOLOGY	MODULATION TYPE	DATA RATE (Mbps)
A	802.11a	149 to 165	165	OFDM	BPSK	6.0
B	802.11a	149 to 165	165	OFDM	BPSK	6.0



A D T

BANDEDGE MEASUREMENT:

- Pre-Scan has been conducted to determine the worst-case mode from all possible combinations between available modulations, data rates and antenna ports (if EUT with antenna diversity architecture).
- Following channel(s) was (were) selected for the final test as listed below.

EUT CONFIGURE MODE	MODE	AVAILABLE CHANNEL	TESTED CHANNEL	MODULATION TECHNOLOGY	MODULATION TYPE	DATA RATE (Mbps)
A	802.11a	149 to 165	149, 165	OFDM	BPSK	6.0
A	Draft 802.11n (20MHz)	149 to 165	149, 165	OFDM	BPSK	7.2
A	Draft 802.11n (40MHz)	151 to 159	151, 159	OFDM	BPSK	15.0

ANTENNA PORT CONDUCTED MEASUREMENT:

- Pre-Scan has been conducted to determine the worst-case mode from all possible combinations between available modulations, data rates and antenna ports (if EUT with antenna diversity architecture).
- Following channel(s) was (were) selected for the final test as listed below.

EUT CONFIGURE MODE	MODE	AVAILABLE CHANNEL	TESTED CHANNEL	MODULATION TECHNOLOGY	MODULATION TYPE	DATA RATE (Mbps)
A	802.11a	149 to 165	149, 157, 165	OFDM	BPSK	6.0
A	Draft 802.11n (20MHz)	149 to 165	149, 157, 165	OFDM	BPSK	7.2
A	Draft 802.11n (40MHz)	151 to 159	151, 159	OFDM	BPSK	15.0



A D T

3.3 GENERAL DESCRIPTION OF APPLIED STANDARDS

The EUT is a RF Product. According to the specifications of the manufacturer, it must comply with the requirements of the following standards:

FCC Part 15, Subpart C (15.247)

ANSI C63.4-2003

All test items have been performed and recorded as per the above standards.

NOTE: The EUT is also considered as a kind of computer peripheral, because the connection to computer is necessary for typical use. It has been verified to comply with the requirements of FCC Part 15, Subpart B, Class B (DoC). The test report has been issued separately.

3.4 DESCRIPTION OF SUPPORT UNITS

The EUT has been tested as an independent unit together with other necessary accessories or support units. The following support units or accessories were used to form a representative test configuration during the tests.

NO.	PRODUCT	BRAND	MODEL NO.	SERIAL NO.	FCC ID
1	NOTEBOOK	DELL	PP05L	12130898320	E2K24CLNS

NO.	SIGNAL CABLE DESCRIPTION OF THE ABOVE SUPPORT UNITS
1	10m RJ45 UTP cable

NOTE: 1. All power cords of the above support units are non shielded (1.8m).
2. Item 1 acted as communication partners to transfer data.

4. TEST TYPES AND RESULTS (FOR 2.4GHz BAND)

4.1 RADIATED EMISSION MEASUREMENT

4.1.1 LIMITS OF RADIATED EMISSION MEASUREMENT

Emissions radiated outside of the specified bands, shall be according to the general radiated limits in 15.209 as following:

FREQUENCIES (MHz)	FIELD STRENGTH (microvolts/meter)	MEASUREMENT DISTANCE (meters)
0.009 ~ 0.490	2400/F(kHz)	300
0.490 ~ 1.705	24000/F(kHz)	30
1.705 ~ 30.0	30	30
30 ~ 88	100	3
88 ~ 216	150	3
216 ~ 960	200	3
Above 960	500	3

NOTE:

1. The lower limit shall apply at the transition frequencies.
2. Emission level (dBuV/m) = 20 log Emission level (uV/m).
3. As shown in 15.35(b), for frequencies above 1000MHz, the field strength limits are based on average detector, however, the peak field strength of any emission shall not exceed the maximum permitted average limits, specified above by more than 20dB under any condition of modulation.



A D T

4.1.2 TEST INSTRUMENTS

DESCRIPTION & MANUFACTURER	MODEL NO.	SERIAL NO.	DATE OF CALIBRATION	DUE DATE OF CALIBRATION
Test Receiver ROHDE & SCHWARZ	ESI7	100033	Jun. 30, 2008	Jun. 29, 2009
Spectrum Analyzer ROHDE & SCHWARZ	FSP40	100041	Apr. 22, 2008	Apr. 21, 2009
BILOG Antenna SCHWARZBECK	VULB9168	9168-160	May 02, 2008	May 01, 2009
HORN Antenna SCHWARZBECK	9120D	9120D-209	Jun. 24, 2008	Jun. 23, 2009
HORN Antenna SCHWARZBECK	BBHA 9170	BBHA9170243	Dec. 25, 2007	Dec. 24, 2008
Preamplifier Agilent	8447D	2944A10633	Nov. 03, 2008	Nov. 02, 2009
Preamplifier Agilent	8449B	3008A01964	Oct. 23, 2008	Oct. 22, 2009
RF signal cable HUBER+SUHNNER	SUCOFLEX 104	238141/4	May 20, 2008	May 19, 2009
RF signal cable HUBER+SUHNNER	SUCOFLEX 104	12738/6	May 20, 2008	May 19, 2009
Software ADT.	ADT_Radiated_V7.6	NA	NA	NA
Antenna Tower inn-co GmbH	MA 4000	013303	NA	NA
Antenna Tower Controller inn-co GmbH	CO2000	017303	NA	NA
Turn Table ADT.	TT100.	TT93021703	NA	NA
Turn Table Controller ADT.	SC100.	SC93021703	NA	NA

- NOTE:**
1. The calibration interval of the above test instruments is 12 months and the calibrations are traceable to NML/ROC and NIST/USA.
 2. The test was performed in HwaYa Chamber 3.
 3. The horn antenna and HP preamplifier (model: 8449B) are used only for the measurement of emission frequency above 1GHz if tested.
 4. The FCC Site Registration No. is 988962.
 5. The IC Site Registration No. is IC3450F-3.



4.1.3 TEST PROCEDURES

- a. The EUT was placed on the top of a rotating table 0.8 meters above the ground at a 3 meters semi-anechoic chamber. The table was rotated 360 degrees to determine the position of the highest radiation.
- b. The EUT was set 3 meters away from the interference-receiving antenna, which was mounted on the top of a variable-height antenna tower.
- c. The antenna is a broadband antenna, and its height is varied from one meter to four meters above the ground to determine the maximum value of the field strength. Both horizontal and vertical polarizations of the antenna are set to make the measurement.
- d. For each suspected emission, the EUT was arranged to its worst case and then the antenna was tuned to heights from 1 meter to 4 meters and the rotatable table was turned from 0 degrees to 360 degrees to find the maximum reading.
- e. The test-receiver system was set to Peak Detect Function and Specified Bandwidth with Maximum Hold Mode.
- f. If the emission level of the EUT in peak mode was lower than the limit specified, then testing could be stopped and the peak values of the EUT would be reported. Otherwise the emissions would be re-tested one by one using peak, quasi-peak or average method as specified and then reported in a data sheet.

NOTE:

1. The resolution bandwidth and video bandwidth of test receiver/spectrum analyzer is 120kHz for Quasi-peak detection at frequency below 1GHz.
2. The resolution bandwidth of test receiver/spectrum analyzer is 1MHz and video bandwidth is 3MHz for Peak detection at frequency above 1GHz.
3. The resolution bandwidth of test receiver/spectrum analyzer is 1MHz and the video bandwidth is 10Hz for Average detection (AV) at frequency above 1GHz.
4. All modes of operation were investigated and the worst-case emissions are reported.

4.1.4 DEVIATION FROM TEST STANDARD

No deviation.

4.1.5 TEST SETUP

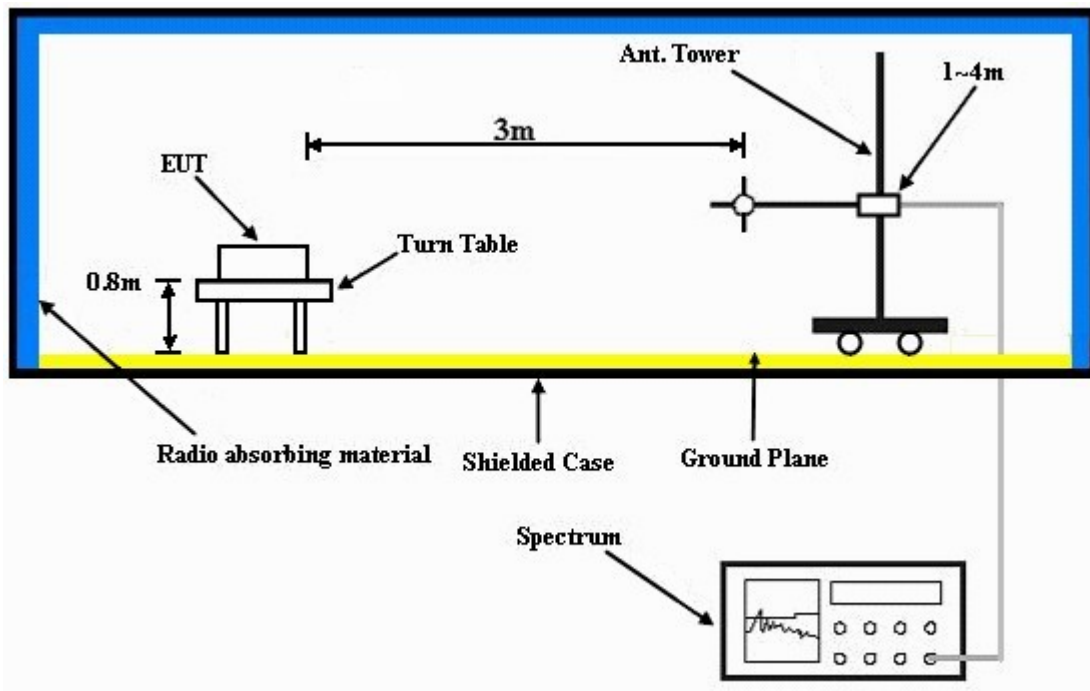

For the actual test configuration, please refer to the attached file (Test Setup Photo).

4.1.6 EUT OPERATING CONDITIONS

- Placed the EUT on the testing table.
- Prepared notebook system outside of testing area to act as a communication partners.
- The communication partner connected with EUT via a RJ45 UTP cable and run a test program (provided by manufacturer) to enable EUT under transmission condition continuously at specific channel frequency.
- The communication partner sent data to EUT by command "PING".



A D T

4.1.7 TEST RESULTS

802.11b DSSS MODULATION

EUT TEST CONDITION		MEASUREMENT DETAIL	
CHANNEL	Channel 1	FREQUENCY RANGE	1 ~ 25GHz
INPUT POWER (SYSTEM)	120Vac, 60 Hz	DETECTOR FUNCTION	Peak (PK) Average (AV)
ENVIRONMENTAL CONDITIONS	25deg. C, 64%RH 1000hPa	TESTED BY	Kevin Liang

ANTENNA POLARITY & TEST DISTANCE: HORIZONTAL AT 3 M								
NO.	FREQ. (MHz)	EMISSION LEVEL (dBuV/m)	LIMIT (dBuV/m)	MARGIN (dB)	ANTENNA HEIGHT (m)	TABLE ANGLE (Degree)	RAW VALUE (dBuV)	CORRECTION FACTOR (dB/m)
1	2390.00	58.74 PK	74.00	-15.26	1.00 H	156	25.41	33.33
2	2390.00	47.05 AV	54.00	-6.95	1.00 H	156	13.72	33.33
3	*2412.00	98.08 PK			1.00 H	156	64.67	33.41
4	*2412.00	92.72 AV			1.00 H	156	59.31	33.41
5	4824.00	47.09 PK	74.00	-26.91	1.22 H	186	7.33	39.76
6	4824.00	34.06 AV	54.00	-19.94	1.22 H	186	-5.70	39.76
ANTENNA POLARITY & TEST DISTANCE: VERTICAL AT 3 M								
NO.	FREQ. (MHz)	EMISSION LEVEL (dBuV/m)	LIMIT (dBuV/m)	MARGIN (dB)	ANTENNA HEIGHT (m)	TABLE ANGLE (Degree)	RAW VALUE (dBuV)	CORRECTION FACTOR (dB/m)
1	2390.00	57.73 PK	74.00	-16.27	1.18 V	350	24.40	33.33
2	2390.00	47.04 AV	54.00	-6.96	1.18 V	350	13.71	33.33
3	*2412.00	104.84 PK			1.18 V	170	71.43	33.41
4	*2412.00	100.26 AV			1.18 V	170	66.85	33.41
5	4824.00	48.33 PK	74.00	-25.67	1.18 V	7	8.57	39.76
6	4824.00	39.98 AV	54.00	-14.02	1.18 V	7	0.22	39.76

- REMARKS:**
1. Emission level (dBuV/m) = Raw Value (dBuV) + Correction Factor (dB/m).
 2. Correction Factor (dB/m) = Antenna Factor (dB/m) + Cable Factor (dB).
 3. The other emission levels were very low against the limit.
 4. Margin value = Emission level – Limit value.
 5. “ * “: Fundamental frequency.



A D T

EUT TEST CONDITION		MEASUREMENT DETAIL	
CHANNEL	Channel 6	FREQUENCY RANGE	1 ~ 25GHz
INPUT POWER (SYSTEM)	120Vac, 60 Hz	DETECTOR FUNCTION	Peak (PK) Average (AV)
ENVIRONMENTAL CONDITIONS	25deg. C, 64%RH 1000hPa	TESTED BY	Kevin Liang

ANTENNA POLARITY & TEST DISTANCE: HORIZONTAL AT 3 M								
NO.	FREQ. (MHz)	EMISSION LEVEL (dBuV/m)	LIMIT (dBuV/m)	MARGIN (dB)	ANTENNA HEIGHT (m)	TABLE ANGLE (Degree)	RAW VALUE (dBuV)	CORRECTION FACTOR (dB/m)
1	*2437.00	98.21 PK			1.00 H	158	64.72	33.49
2	*2437.00	92.71 AV			1.00 H	158	59.22	33.49
3	4874.00	46.93 PK	74.00	-27.07	1.14 H	214	7.05	39.88
4	4874.00	33.89 AV	54.00	-20.11	1.14 H	214	-5.99	39.88
ANTENNA POLARITY & TEST DISTANCE: VERTICAL AT 3 M								
NO.	FREQ. (MHz)	EMISSION LEVEL (dBuV/m)	LIMIT (dBuV/m)	MARGIN (dB)	ANTENNA HEIGHT (m)	TABLE ANGLE (Degree)	RAW VALUE (dBuV)	CORRECTION FACTOR (dB/m)
1	*2437.00	104.54 PK			1.16 V	10	71.05	33.49
2	*2437.00	99.82 AV			1.16 V	10	66.33	33.49
3	4874.00	47.22 PK	74.00	-26.78	1.00 V	20	7.34	39.88
4	4874.00	36.46 AV	54.00	-17.54	1.00 V	20	-3.42	39.88

- REMARKS:**
1. Emission level (dBuV/m) = Raw Value (dBuV) + Correction Factor (dB/m).
 2. Correction Factor (dB/m) = Antenna Factor (dB/m) + Cable Factor (dB).
 3. The other emission levels were very low against the limit.
 4. Margin value = Emission level – Limit value.
 5. “ * “: Fundamental frequency.



A D T

EUT TEST CONDITION		MEASUREMENT DETAIL	
CHANNEL	Channel 11	FREQUENCY RANGE	1 ~ 25GHz
INPUT POWER (SYSTEM)	120Vac, 60 Hz	DETECTOR FUNCTION	Peak (PK) Average (AV)
ENVIRONMENTAL CONDITIONS	25deg. C, 64%RH 1000hPa	TESTED BY	Kevin Liang

ANTENNA POLARITY & TEST DISTANCE: HORIZONTAL AT 3 M								
NO.	FREQ. (MHz)	EMISSION LEVEL (dBuV/m)	LIMIT (dBuV/m)	MARGIN (dB)	ANTENNA HEIGHT (m)	TABLE ANGLE (Degree)	RAW VALUE (dBuV)	CORRECTION FACTOR (dB/m)
1	*2462.00	97.67 PK			1.01 H	157	64.10	33.57
2	*2462.00	92.85 AV			1.01 H	157	59.28	33.57
3	2483.50	60.07 PK	74.00	-13.93	1.01 H	157	26.43	33.64
4	2483.50	47.41 AV	54.00	-6.59	1.01 H	157	13.77	33.64
5	4924.00	47.18 PK	74.00	-26.82	1.19 H	194	7.15	40.03
6	4924.00	34.15 AV	54.00	-19.85	1.19 H	194	-5.88	40.03
ANTENNA POLARITY & TEST DISTANCE: VERTICAL AT 3 M								
NO.	FREQ. (MHz)	EMISSION LEVEL (dBuV/m)	LIMIT (dBuV/m)	MARGIN (dB)	ANTENNA HEIGHT (m)	TABLE ANGLE (Degree)	RAW VALUE (dBuV)	CORRECTION FACTOR (dB/m)
1	*2462.00	104.67 PK			1.17 V	166	71.10	33.57
2	*2462.00	99.34 AV			1.17 V	166	65.77	33.57
3	2483.50	59.19 PK	74.00	-14.81	1.17 V	166	25.55	33.64
4	2483.50	47.31 AV	54.00	-6.69	1.17 V	166	13.67	33.64
5	4924.00	48.49 PK	74.00	-25.51	1.19 V	23	8.46	40.03
6	4924.00	40.15 AV	54.00	-13.85	1.19 V	23	0.12	40.03

- REMARKS:**
1. Emission level (dBuV/m) = Raw Value (dBuV) + Correction Factor (dB/m).
 2. Correction Factor (dB/m) = Antenna Factor (dB/m) + Cable Factor (dB).
 3. The other emission levels were very low against the limit.
 4. Margin value = Emission level – Limit value.
 5. “ * “: Fundamental frequency.



A D T

802.11g OFDM MODULATION

EUT TEST CONDITION		MEASUREMENT DETAIL	
CHANNEL	Channel 1	FREQUENCY RANGE	1 ~ 25GHz
INPUT POWER (SYSTEM)	120Vac, 60 Hz	DETECTOR FUNCTION	Peak (PK) Average (AV)
ENVIRONMENTAL CONDITIONS	25deg. C, 64%RH 1000hPa	TESTED BY	Kevin Liang

ANTENNA POLARITY & TEST DISTANCE: HORIZONTAL AT 3 M								
NO.	FREQ. (MHz)	EMISSION LEVEL (dBuV/m)	LIMIT (dBuV/m)	MARGIN (dB)	ANTENNA HEIGHT (m)	TABLE ANGLE (Degree)	RAW VALUE (dBuV)	CORRECTION FACTOR (dB/m)
1	2390.00	62.23 PK	74.00	-11.77	1.03 H	156	28.90	33.33
2	2390.00	46.93 AV	54.00	-7.07	1.03 H	156	13.60	33.33
3	*2412.00	99.41 PK			1.03 H	156	66.00	33.41
4	*2412.00	88.28 AV			1.03 H	156	54.87	33.41
5	4824.00	47.18 PK	74.00	-26.82	1.07 H	201	7.42	39.76
6	4824.00	33.69 AV	54.00	-20.31	1.07 H	201	-6.07	39.76
ANTENNA POLARITY & TEST DISTANCE: VERTICAL AT 3 M								
NO.	FREQ. (MHz)	EMISSION LEVEL (dBuV/m)	LIMIT (dBuV/m)	MARGIN (dB)	ANTENNA HEIGHT (m)	TABLE ANGLE (Degree)	RAW VALUE (dBuV)	CORRECTION FACTOR (dB/m)
1	2390.00	65.30 PK	74.00	-8.70	1.19 V	348	31.97	33.33
2	2390.00	50.05 AV	54.00	-3.95	1.19 V	348	16.72	33.33
3	*2412.00	108.11 PK			1.19 V	348	74.70	33.41
4	*2412.00	96.11 AV			1.19 V	348	62.70	33.41
5	4824.00	48.14 PK	74.00	-25.86	1.17 V	358	8.38	39.76
6	4824.00	34.68 AV	54.00	-19.32	1.17 V	358	-5.08	39.76

- REMARKS:**
1. Emission level (dBuV/m) = Raw Value (dBuV) + Correction Factor (dB/m).
 2. Correction Factor (dB/m) = Antenna Factor (dB/m) + Cable Factor (dB).
 3. The other emission levels were very low against the limit.
 4. Margin value = Emission level – Limit value.
 5. “ * “: Fundamental frequency.



A D T

EUT TEST CONDITION		MEASUREMENT DETAIL	
CHANNEL	Channel 6	FREQUENCY RANGE	1 ~ 25GHz
INPUT POWER (SYSTEM)	120Vac, 60 Hz	DETECTOR FUNCTION	Peak (PK) Average (AV)
ENVIRONMENTAL CONDITIONS	25deg. C, 64%RH 1000hPa	TESTED BY	Kevin Liang

ANTENNA POLARITY & TEST DISTANCE: HORIZONTAL AT 3 M								
NO.	FREQ. (MHz)	EMISSION LEVEL (dBuV/m)	LIMIT (dBuV/m)	MARGIN (dB)	ANTENNA HEIGHT (m)	TABLE ANGLE (Degree)	RAW VALUE (dBuV)	CORRECTION FACTOR (dB/m)
1	*2437.00	101.96 PK			1.00 H	156	68.47	33.49
2	*2437.00	90.60 AV			1.00 H	156	57.11	33.49
3	4874.00	47.35 PK	74.00	-26.65	1.08 H	223	7.47	39.88
4	4874.00	33.87 AV	54.00	-20.13	1.08 H	223	-6.01	39.88
ANTENNA POLARITY & TEST DISTANCE: VERTICAL AT 3 M								
NO.	FREQ. (MHz)	EMISSION LEVEL (dBuV/m)	LIMIT (dBuV/m)	MARGIN (dB)	ANTENNA HEIGHT (m)	TABLE ANGLE (Degree)	RAW VALUE (dBuV)	CORRECTION FACTOR (dB/m)
1	*2437.00	107.80 PK			1.00 V	185	74.31	33.49
2	*2437.00	96.51 AV			1.00 V	185	63.02	33.49
3	4874.00	48.23 PK	74.00	-25.77	1.13 V	344	8.35	39.88
4	4874.00	34.76 AV	54.00	-19.24	1.13 V	344	-5.12	39.88

- REMARKS:**
1. Emission level (dBuV/m) = Raw Value (dBuV) + Correction Factor (dB/m).
 2. Correction Factor (dB/m) = Antenna Factor (dB/m) + Cable Factor (dB).
 3. The other emission levels were very low against the limit.
 4. Margin value = Emission level – Limit value.
 5. “ * “: Fundamental frequency.



A D T

EUT TEST CONDITION		MEASUREMENT DETAIL	
CHANNEL	Channel 11	FREQUENCY RANGE	1 ~ 25GHz
INPUT POWER (SYSTEM)	120Vac, 60 Hz	DETECTOR FUNCTION	Peak (PK) Average (AV)
ENVIRONMENTAL CONDITIONS	25deg. C, 64%RH 1000hPa	TESTED BY	Kevin Liang

ANTENNA POLARITY & TEST DISTANCE: HORIZONTAL AT 3 M								
NO.	FREQ. (MHz)	EMISSION LEVEL (dBuV/m)	LIMIT (dBuV/m)	MARGIN (dB)	ANTENNA HEIGHT (m)	TABLE ANGLE (Degree)	RAW VALUE (dBuV)	CORRECTION FACTOR (dB/m)
1	*2462.00	103.19 PK			1.00 H	219	69.62	33.57
2	*2462.00	91.77 AV			1.00 H	219	58.20	33.57
3	2483.50	66.68 PK	74.00	-7.32	1.00 H	218	33.04	33.64
4	2483.50	48.76 AV	54.00	-5.24	1.00 H	218	15.12	33.64
5	4924.00	47.39 PK	74.00	-26.61	1.00 H	197	7.36	40.03
6	4924.00	33.82 AV	54.00	-20.18	1.00 H	197	-6.21	40.03
ANTENNA POLARITY & TEST DISTANCE: VERTICAL AT 3 M								
NO.	FREQ. (MHz)	EMISSION LEVEL (dBuV/m)	LIMIT (dBuV/m)	MARGIN (dB)	ANTENNA HEIGHT (m)	TABLE ANGLE (Degree)	RAW VALUE (dBuV)	CORRECTION FACTOR (dB/m)
1	*2462.00	107.56 PK			1.15 V	167	73.99	33.57
2	*2462.00	96.47 AV			1.15 V	167	62.90	33.57
3	2483.50	68.94 PK	74.00	-5.06	1.15 V	167	35.30	33.64
4	2483.50	50.27 AV	54.00	-3.73	1.15 V	167	16.63	33.64
5	4924.00	49.16 PK	74.00	-24.84	3.45 V	167	9.12	40.03
6	4924.00	35.74 AV	54.00	-18.26	3.45 V	167	-4.30	40.03

- REMARKS:**
1. Emission level (dBuV/m) = Raw Value (dBuV) + Correction Factor (dB/m).
 2. Correction Factor (dB/m) = Antenna Factor (dB/m) + Cable Factor (dB).
 3. The other emission levels were very low against the limit.
 4. Margin value = Emission level – Limit value.
 5. “ * “: Fundamental frequency.



A D T

DRAFT 802.11n (20MHz) OFDM MODULATION

EUT TEST CONDITION		MEASUREMENT DETAIL	
CHANNEL	Channel 1	FREQUENCY RANGE	1 ~ 25GHz
INPUT POWER (SYSTEM)	120Vac, 60 Hz	DETECTOR FUNCTION	Peak (PK) Average (AV)
ENVIRONMENTAL CONDITIONS	24deg. C, 62%RH 1000hPa	TESTED BY	Kevin Liang

ANTENNA POLARITY & TEST DISTANCE: HORIZONTAL AT 3 M								
NO.	FREQ. (MHz)	EMISSION LEVEL (dBuV/m)	LIMIT (dBuV/m)	MARGIN (dB)	ANTENNA HEIGHT (m)	TABLE ANGLE (Degree)	RAW VALUE (dBuV)	CORRECTION FACTOR (dB/m)
1	2390.00	61.25 PK	74.00	-12.75	1.00 H	173	27.92	33.33
2	2390.00	48.00 AV	54.00	-6.00	1.00 H	173	14.67	33.33
3	*2412.00	98.62 PK			1.00 H	173	65.21	33.41
4	*2412.00	87.42 AV			1.00 H	173	54.01	33.41
5	4824.00	47.26 PK	74.00	-26.74	1.03 H	231	7.50	39.76
6	4824.00	33.59 AV	54.00	-20.41	1.03 H	231	-6.17	39.76
ANTENNA POLARITY & TEST DISTANCE: VERTICAL AT 3 M								
NO.	FREQ. (MHz)	EMISSION LEVEL (dBuV/m)	LIMIT (dBuV/m)	MARGIN (dB)	ANTENNA HEIGHT (m)	TABLE ANGLE (Degree)	RAW VALUE (dBuV)	CORRECTION FACTOR (dB/m)
1	2390.00	69.95 PK	74.00	-4.05	1.17 V	0	36.62	33.33
2	2390.00	52.76 AV	54.00	-1.24	1.17 V	0	19.43	33.33
3	*2412.00	107.94 PK			1.17 V	15	74.53	33.41
4	*2412.00	96.53 AV			1.17 V	15	63.12	33.41
5	4824.00	47.66 PK	74.00	-26.34	1.17 V	164	7.90	39.76
6	4824.00	33.67 AV	54.00	-20.33	1.17 V	164	-6.09	39.76

- REMARKS:**
1. Emission level (dBuV/m) = Raw Value (dBuV) + Correction Factor (dB/m).
 2. Correction Factor (dB/m) = Antenna Factor (dB/m) + Cable Factor (dB).
 3. The other emission levels were very low against the limit.
 4. Margin value = Emission level – Limit value.
 5. “ * “: Fundamental frequency.



A D T

EUT TEST CONDITION		MEASUREMENT DETAIL	
CHANNEL	Channel 6	FREQUENCY RANGE	1 ~ 25GHz
INPUT POWER (SYSTEM)	120Vac, 60 Hz	DETECTOR FUNCTION	Peak (PK) Average (AV)
ENVIRONMENTAL CONDITIONS	24deg. C, 62%RH 1000hPa	TESTED BY	Kevin Liang

ANTENNA POLARITY & TEST DISTANCE: HORIZONTAL AT 3 M								
NO.	FREQ. (MHz)	EMISSION LEVEL (dBuV/m)	LIMIT (dBuV/m)	MARGIN (dB)	ANTENNA HEIGHT (m)	TABLE ANGLE (Degree)	RAW VALUE (dBuV)	CORRECTION FACTOR (dB/m)
1	*2437.00	98.12 PK			1.00 H	170	64.63	33.49
2	*2437.00	86.91 AV			1.00 H	170	53.42	33.49
3	4874.00	47.47 PK	74.00	-26.53	1.07 H	226	7.59	39.88
4	4874.00	33.60 AV	54.00	-20.40	1.07 H	226	-6.28	39.88
ANTENNA POLARITY & TEST DISTANCE: VERTICAL AT 3 M								
NO.	FREQ. (MHz)	EMISSION LEVEL (dBuV/m)	LIMIT (dBuV/m)	MARGIN (dB)	ANTENNA HEIGHT (m)	TABLE ANGLE (Degree)	RAW VALUE (dBuV)	CORRECTION FACTOR (dB/m)
1	*2437.00	108.12 PK			1.11 V	175	74.63	33.49
2	*2437.00	96.42 AV			1.11 V	175	62.93	33.49
3	4874.00	47.90 PK	74.00	-26.10	1.20 V	35	8.02	39.88
4	4874.00	34.27 AV	54.00	-19.73	1.20 V	35	-5.61	39.88

- REMARKS:**
1. Emission level (dBuV/m) = Raw Value (dBuV) + Correction Factor (dB/m).
 2. Correction Factor (dB/m) = Antenna Factor (dB/m) + Cable Factor (dB).
 3. The other emission levels were very low against the limit.
 4. Margin value = Emission level – Limit value.
 5. “ * “: Fundamental frequency.



A D T

EUT TEST CONDITION		MEASUREMENT DETAIL	
CHANNEL	Channel 11	FREQUENCY RANGE	1 ~ 25GHz
INPUT POWER (SYSTEM)	120Vac, 60 Hz	DETECTOR FUNCTION	Peak (PK) Average (AV)
ENVIRONMENTAL CONDITIONS	24deg. C, 62%RH 1000hPa	TESTED BY	Kevin Liang

ANTENNA POLARITY & TEST DISTANCE: HORIZONTAL AT 3 M								
NO.	FREQ. (MHz)	EMISSION LEVEL (dBuV/m)	LIMIT (dBuV/m)	MARGIN (dB)	ANTENNA HEIGHT (m)	TABLE ANGLE (Degree)	RAW VALUE (dBuV)	CORRECTION FACTOR (dB/m)
1	*2462.00	98.74 PK			1.02 H	168	65.17	33.57
2	*2462.00	87.67 AV			1.02 H	168	54.10	33.57
3	2483.50	58.36 PK	74.00	-15.64	1.03 H	168	24.72	33.64
4	2483.50	47.50 AV	54.00	-6.50	1.03 H	168	13.86	33.64
5	4924.00	47.86 PK	74.00	-26.14	1.11 H	195	7.82	40.03
6	4924.00	34.21 AV	54.00	-19.79	1.11 H	195	-5.83	40.03
ANTENNA POLARITY & TEST DISTANCE: VERTICAL AT 3 M								
NO.	FREQ. (MHz)	EMISSION LEVEL (dBuV/m)	LIMIT (dBuV/m)	MARGIN (dB)	ANTENNA HEIGHT (m)	TABLE ANGLE (Degree)	RAW VALUE (dBuV)	CORRECTION FACTOR (dB/m)
1	*2462.00	107.79 PK			1.12 V	169	74.22	33.57
2	*2462.00	96.39 AV			1.12 V	169	62.82	33.57
3	2483.50	69.29 PK	74.00	-4.71	1.12 V	170	35.65	33.64
4	2483.50	52.15 AV	54.00	-1.85	1.12 V	170	18.51	33.64
5	4924.00	48.17 PK	74.00	-25.83	1.06 V	241	8.13	40.03
6	4924.00	34.34 AV	54.00	-19.66	1.06 V	241	-5.70	40.03

- REMARKS:**
1. Emission level (dBuV/m) = Raw Value (dBuV) + Correction Factor (dB/m).
 2. Correction Factor (dB/m) = Antenna Factor (dB/m) + Cable Factor (dB).
 3. The other emission levels were very low against the limit.
 4. Margin value = Emission level – Limit value.
 5. “ * “: Fundamental frequency.



A D T

DRAFT 802.11n (40MHz) OFDM MODULATION

EUT TEST CONDITION		MEASUREMENT DETAIL	
CHANNEL	Channel 1	FREQUENCY RANGE	1 ~ 25GHz
INPUT POWER (SYSTEM)	120Vac, 60 Hz	DETECTOR FUNCTION	Peak (PK) Average (AV)
ENVIRONMENTAL CONDITIONS	24deg. C, 62%RH 1000hPa	TESTED BY	Kevin Liang

ANTENNA POLARITY & TEST DISTANCE: HORIZONTAL AT 3 M								
NO.	FREQ. (MHz)	EMISSION LEVEL (dBuV/m)	LIMIT (dBuV/m)	MARGIN (dB)	ANTENNA HEIGHT (m)	TABLE ANGLE (Degree)	RAW VALUE (dBuV)	CORRECTION FACTOR (dB/m)
1	2390.00	60.79 PK	74.00	-13.21	1.00 H	172	27.46	33.33
2	2390.00	47.96 AV	54.00	-6.04	1.00 H	172	14.63	33.33
3	*2422.00	93.47 PK			1.00 H	172	60.03	33.44
4	*2422.00	82.34 AV			1.00 H	172	48.90	33.44
5	4844.00	46.87 PK	74.00	-27.13	1.20 H	167	7.07	39.81
6	4844.00	34.23 AV	54.00	-19.77	1.20 H	167	-5.57	39.81
ANTENNA POLARITY & TEST DISTANCE: VERTICAL AT 3 M								
NO.	FREQ. (MHz)	EMISSION LEVEL (dBuV/m)	LIMIT (dBuV/m)	MARGIN (dB)	ANTENNA HEIGHT (m)	TABLE ANGLE (Degree)	RAW VALUE (dBuV)	CORRECTION FACTOR (dB/m)
1	2390.00	67.45 PK	74.00	-6.55	1.17 V	196	34.12	33.33
2	2390.00	52.73 AV	54.00	-1.27	1.17 V	196	19.40	33.33
3	*2422.00	104.10 PK			1.17 V	12	70.66	33.44
4	*2422.00	91.96 AV			1.17 V	12	58.52	33.44
5	4844.00	47.71 PK	74.00	-26.29	1.08 V	143	7.91	39.81
6	4844.00	34.14 AV	54.00	-19.86	1.08 V	143	-5.66	39.81

- REMARKS:**
1. Emission level (dBuV/m) = Raw Value (dBuV) + Correction Factor (dB/m).
 2. Correction Factor (dB/m) = Antenna Factor (dB/m) + Cable Factor (dB).
 3. The other emission levels were very low against the limit.
 4. Margin value = Emission level – Limit value.
 5. “ * “: Fundamental frequency.



A D T

EUT TEST CONDITION		MEASUREMENT DETAIL	
CHANNEL	Channel 4	FREQUENCY RANGE	1 ~ 25GHz
INPUT POWER (SYSTEM)	120Vac, 60 Hz	DETECTOR FUNCTION	Peak (PK) Average (AV)
ENVIRONMENTAL CONDITIONS	24deg. C, 62%RH 1000hPa	TESTED BY	Kevin Liang

ANTENNA POLARITY & TEST DISTANCE: HORIZONTAL AT 3 M								
NO.	FREQ. (MHz)	EMISSION LEVEL (dBuV/m)	LIMIT (dBuV/m)	MARGIN (dB)	ANTENNA HEIGHT (m)	TABLE ANGLE (Degree)	RAW VALUE (dBuV)	CORRECTION FACTOR (dB/m)
1	*2437.00	94.49 PK			1.00 H	170	61.00	33.49
2	*2437.00	82.60 AV			1.00 H	170	49.11	33.49
3	4874.00	47.13 PK	74.00	-26.87	1.04 H	215	7.25	39.88
4	4874.00	34.46 AV	54.00	-19.54	1.04 H	215	-5.42	39.88
ANTENNA POLARITY & TEST DISTANCE: VERTICAL AT 3 M								
NO.	FREQ. (MHz)	EMISSION LEVEL (dBuV/m)	LIMIT (dBuV/m)	MARGIN (dB)	ANTENNA HEIGHT (m)	TABLE ANGLE (Degree)	RAW VALUE (dBuV)	CORRECTION FACTOR (dB/m)
1	*2437.00	104.08 PK			1.14 V	175	70.59	33.49
2	*2437.00	91.75 AV			1.14 V	175	58.26	33.49
3	4874.00	47.69 PK	74.00	-26.31	1.10 V	68	7.81	39.88
4	4874.00	34.65 AV	54.00	-19.35	1.10 V	68	-5.23	39.88

- REMARKS:**
1. Emission level (dBuV/m) = Raw Value (dBuV) + Correction Factor (dB/m).
 2. Correction Factor (dB/m) = Antenna Factor (dB/m) + Cable Factor (dB).
 3. The other emission levels were very low against the limit.
 4. Margin value = Emission level – Limit value.
 5. “ * “: Fundamental frequency.



A D T

EUT TEST CONDITION		MEASUREMENT DETAIL	
CHANNEL	Channel 7	FREQUENCY RANGE	1 ~ 25GHz
INPUT POWER (SYSTEM)	120Vac, 60 Hz	DETECTOR FUNCTION	Peak (PK) Average (AV)
ENVIRONMENTAL CONDITIONS	24deg. C, 62%RH 1000hPa	TESTED BY	Kevin Liang

ANTENNA POLARITY & TEST DISTANCE: HORIZONTAL AT 3 M								
NO.	FREQ. (MHz)	EMISSION LEVEL (dBuV/m)	LIMIT (dBuV/m)	MARGIN (dB)	ANTENNA HEIGHT (m)	TABLE ANGLE (Degree)	RAW VALUE (dBuV)	CORRECTION FACTOR (dB/m)
1	*2452.00	93.96 PK			1.00 H	171	60.42	33.54
2	*2452.00	81.93 AV			1.00 H	171	48.39	33.54
3	2483.50	62.80 PK	74.00	-11.20	1.00 H	171	29.16	33.64
4	2483.50	47.56 AV	54.00	-6.44	1.00 H	171	13.92	33.64
5	4904.00	47.45 PK	74.00	-26.55	1.02 H	55	7.49	39.96
6	4904.00	34.47 AV	54.00	-19.53	1.02 H	55	-5.49	39.96
ANTENNA POLARITY & TEST DISTANCE: VERTICAL AT 3 M								
NO.	FREQ. (MHz)	EMISSION LEVEL (dBuV/m)	LIMIT (dBuV/m)	MARGIN (dB)	ANTENNA HEIGHT (m)	TABLE ANGLE (Degree)	RAW VALUE (dBuV)	CORRECTION FACTOR (dB/m)
1	*2452.00	103.15 PK			1.15 V	176	69.61	33.54
2	*2452.00	91.29 AV			1.15 V	176	57.75	33.54
3	2483.50	72.46 PK	74.00	-1.54	1.15 V	115	38.82	33.64
4	2483.50	51.79 AV	54.00	-2.21	1.15 V	115	18.15	33.64
5	4904.00	47.52 PK	74.00	-26.48	1.18 V	192	7.56	39.96
6	4904.00	34.75 AV	54.00	-19.25	1.18 V	192	-5.21	39.96

- REMARKS:**
1. Emission level (dBuV/m) = Raw Value (dBuV) + Correction Factor (dB/m).
 2. Correction Factor (dB/m) = Antenna Factor (dB/m) + Cable Factor (dB).
 3. The other emission levels were very low against the limit.
 4. Margin value = Emission level – Limit value.
 5. “ * “: Fundamental frequency.



A D T

BELOW 1GHz WORST-CASE DATA : 802.11g OFDM MODULATION

EUT TEST CONDITION		MEASUREMENT DETAIL	
CHANNEL	Channel 6	FREQUENCY RANGE	Below 1000MHz
INPUT POWER (SYSTEM)	120Vac, 60 Hz	DETECTOR FUNCTION	Quasi-Peak
ENVIRONMENTAL CONDITIONS	24deg. C, 64%RH 999hPa	TEST MODE	A
TESTED BY	Match Tsui		

ANTENNA POLARITY & TEST DISTANCE: HORIZONTAL AT 3 M								
NO.	FREQ. (MHz)	EMISSION LEVEL (dBuV/m)	LIMIT (dBuV/m)	MARGIN (dB)	ANTENNA HEIGHT (m)	TABLE ANGLE (Degree)	RAW VALUE (dBuV)	CORRECTION FACTOR (dB/m)
1	94.06	31.86 QP	43.50	-11.64	1.50 H	322	22.08	9.78
2	160.17	31.97 QP	43.50	-11.53	1.50 H	358	17.14	14.83
3	173.78	34.04 QP	43.50	-9.46	1.50 H	85	20.04	14.01
4	249.60	37.65 QP	46.00	-8.35	1.00 H	232	23.24	14.40
5	399.31	42.26 QP	46.00	-3.74	1.00 H	355	23.35	18.91
6	500.42	38.27 QP	46.00	-7.73	2.00 H	193	16.79	21.48
7	550.97	33.88 QP	46.00	-12.12	1.50 H	151	11.28	22.60
8	599.58	33.33 QP	46.00	-12.67	1.25 H	250	9.68	23.65
9	751.23	33.88 QP	46.00	-12.12	2.00 H	52	6.83	27.06
10	799.84	34.09 QP	46.00	-11.91	1.25 H	13	6.55	27.54
11	951.49	33.70 QP	46.00	-12.30	1.50 H	196	3.24	30.46

ANTENNA POLARITY & TEST DISTANCE: VERTICAL AT 3 M								
NO.	FREQ. (MHz)	EMISSION LEVEL (dBuV/m)	LIMIT (dBuV/m)	MARGIN (dB)	ANTENNA HEIGHT (m)	TABLE ANGLE (Degree)	RAW VALUE (dBuV)	CORRECTION FACTOR (dB/m)
1	57.12	29.93 QP	40.00	-10.07	1.00 V	193	16.64	13.29
2	64.90	31.86 QP	40.00	-8.14	1.00 V	349	18.43	13.42
3	99.89	35.63 QP	43.50	-7.87	1.25 V	202	23.69	11.94
4	249.60	32.63 QP	46.00	-13.37	1.00 V	160	18.23	14.40
5	399.31	39.35 QP	46.00	-6.65	1.00 V	67	20.44	18.91
6	500.42	37.64 QP	46.00	-8.36	1.00 V	49	16.16	21.48
7	751.23	32.99 QP	46.00	-13.01	1.25 V	334	5.93	27.06
8	799.84	32.17 QP	46.00	-13.83	1.00 V	10	4.63	27.54
9	875.67	32.28 QP	46.00	-13.72	1.25 V	349	2.95	29.33
10	951.49	33.81 QP	46.00	-12.19	1.00 V	109	3.35	30.46

- REMARKS:**
1. Emission level (dBuV/m) = Raw Value (dBuV) + Correction Factor (dB/m).
 2. Correction Factor (dB/m) = Antenna Factor (dB/m) + Cable Factor (dB).
 3. The other emission levels were very low against the limit.
 4. Margin value = Emission level – Limit value.



A D T

EUT TEST CONDITION		MEASUREMENT DETAIL	
CHANNEL	Channel 6	FREQUENCY RANGE	Below 1000MHz
INPUT POWER (SYSTEM)	120Vac, 60 Hz	DETECTOR FUNCTION	Quasi-Peak
ENVIRONMENTAL CONDITIONS	24deg. C, 64%RH 999hPa	TEST MODE	B
TESTED BY	Match Tsui		

ANTENNA POLARITY & TEST DISTANCE: HORIZONTAL AT 3 M								
NO.	FREQ. (MHz)	EMISSION LEVEL (dBuV/m)	LIMIT (dBuV/m)	MARGIN (dB)	ANTENNA HEIGHT (m)	TABLE ANGLE (Degree)	RAW VALUE (dBuV)	CORRECTION FACTOR (dB/m)
1	160.17	37.03 QP	43.50	-6.47	1.50 H	88	22.20	14.83
2	167.94	39.75 QP	43.50	-3.75	1.50 H	43	25.39	14.36
3	249.60	38.57 QP	46.00	-7.43	1.00 H	250	24.17	14.40
4	399.31	41.15 QP	46.00	-4.85	1.00 H	139	22.24	18.91
5	599.58	37.04 QP	46.00	-8.96	1.50 H	37	13.39	23.65
6	624.85	35.16 QP	46.00	-10.84	1.25 H	34	10.80	24.36
7	751.23	36.74 QP	46.00	-9.26	1.00 H	7	9.68	27.06
8	799.84	36.68 QP	46.00	-9.32	1.00 H	10	9.14	27.54
9	875.67	37.42 QP	46.00	-8.58	1.50 H	10	8.09	29.33
ANTENNA POLARITY & TEST DISTANCE: VERTICAL AT 3 M								
NO.	FREQ. (MHz)	EMISSION LEVEL (dBuV/m)	LIMIT (dBuV/m)	MARGIN (dB)	ANTENNA HEIGHT (m)	TABLE ANGLE (Degree)	RAW VALUE (dBuV)	CORRECTION FACTOR (dB/m)
1	55.18	33.56 QP	40.00	-6.44	1.50 V	145	20.23	13.34
2	101.84	38.83 QP	43.50	-4.67	1.50 V	247	26.86	11.96
3	160.17	33.36 QP	43.50	-10.14	2.00 V	298	18.53	14.83
4	399.31	39.06 QP	46.00	-6.94	1.25 V	37	20.15	18.91
5	500.42	35.02 QP	46.00	-10.98	1.00 V	124	13.55	21.48
6	599.58	35.32 QP	46.00	-10.68	1.00 V	283	11.67	23.65
7	751.23	36.69 QP	46.00	-9.31	1.50 V	355	9.63	27.06

- REMARKS:**
1. Emission level (dBuV/m) = Raw Value (dBuV) + Correction Factor (dB/m).
 2. Correction Factor (dB/m) = Antenna Factor (dB/m) + Cable Factor (dB).
 3. The other emission levels were very low against the limit.
 4. Margin value = Emission level – Limit value.



ADT

4.2 CONDUCTED EMISSION MEASUREMENT

4.2.1 LIMITS OF CONDUCTED EMISSION MEASUREMENT

FREQUENCY OF EMISSION (MHz)	CONDUCTED LIMIT (dB μ V)	
	Quasi-peak	Average
0.15 ~ 0.5	66 to 56	56 to 46
0.5 ~ 5	56	46
5 ~ 30	60	50

- NOTE:** 1. The lower limit shall apply at the transition frequencies.
2. The limit decreases in line with the logarithm of the frequency in the range of 0.15 to 0.50MHz.
3. All emanations from a class A/B digital device or system, including any network of conductors and apparatus connected thereto, shall not exceed the level of field strengths specified above.

4.2.2 TEST INSTRUMENTS

DESCRIPTION & MANUFACTURER	MODEL NO.	SERIAL NO.	DATE OF CALIBRATION	DUE DATE OF CALIBRATION
Test Receiver ROHDE & SCHWARZ	ESCS30	100291	Nov. 19, 2008	Nov. 18, 2009
RF signal cable Woken	5D-FB	Cable-HYC01-01	Jan. 04, 2008	Jan. 03, 2009
LISN ROHDE & SCHWARZ	ESH3-Z5	100312	Jun. 13, 2008	Jun. 12, 2009
V-LISN SCHWARZBECK	NNBL 8226-2	8226-142	Jun. 10, 2008	Jun. 09, 2009
Software ADT	ADT_Cond_V3	NA	NA	NA

- NOTE:** 1. The calibration interval of the above test instruments is 12 months and the calibrations are traceable to NML/ROC and NIST/USA.
2. The test was performed in HwaYa Shielded Room 1.
3. The VCCI Site Registration No. is C-2040.



A D T

4.2.3 TEST PROCEDURES

- a. The EUT was placed 0.4 meters from the conducting wall of the shielded room with EUT being connected to the power mains through a line impedance stabilization network (LISN). Other support units were connected to the power mains through another LISN. The two LISNs provide 50 ohm/ 50uH of coupling impedance for the measuring instrument.
- b. Both lines of the power mains connected to the EUT were checked for maximum conducted interference.
- c. The frequency range from 150kHz to 30MHz was searched. Emission levels under (Limit - 20dB) was not recorded.

NOTE: All modes of operation were investigated and the worst-case emissions are reported.

4.2.4 DEVIATION FROM TEST STANDARD

No deviation.

4.2.5 TEST SETUP

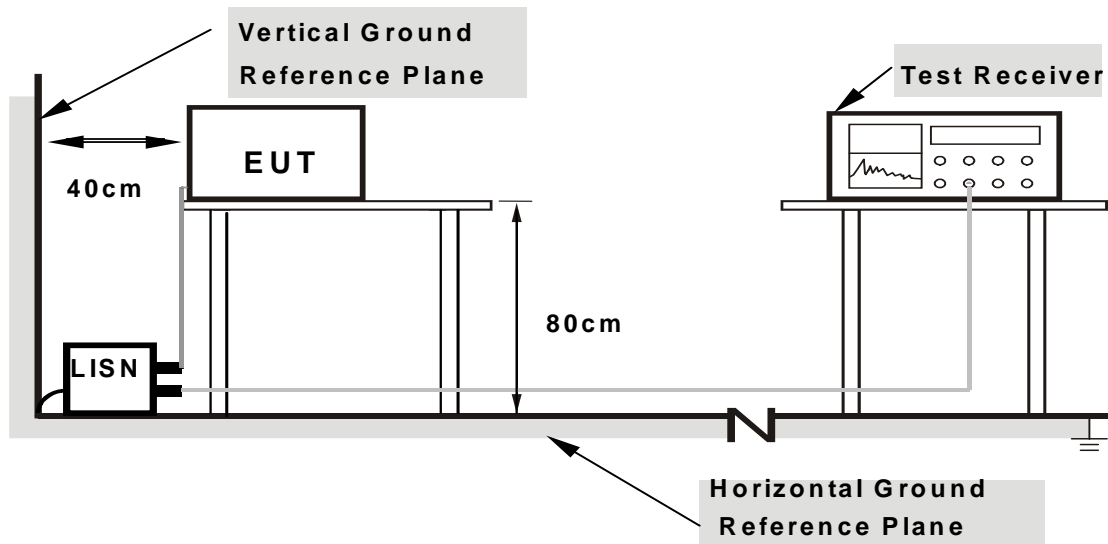

- Note:**
1. Support units were connected to second LISN.
 2. Both of LISNs (AMN) are 80 cm from EUT and at least 80 from other units and other metal planes

For the actual test configuration, please refer to the attached file (Test Setup Photo).

4.2.6 EUT OPERATING CONDITIONS

Same as 4.1.6.

4.2.7 TEST RESULTS

CONDUCTED WORST-CASE DATA : 802.11g OFDM MODULATION

EUT TEST CONDITION		MEASUREMENT DETAIL	
CHANNEL	Channel 6	PHASE	Line 1
MODULATION TYPE	BPSK	INPUT POWER	120Vac, 60Hz
TRANSFER RATE	6.0Mbps	6dB BANDWIDTH	9kHz
ENVIRONMENTAL CONDITIONS	22deg. C, 60%RH, 1021hPa	TEST MODE	A
TESTED BY	Kevin Liang		

No	Freq. [MHz]	Corr. Factor [dB]	Reading Value [dB (uV)]		Emission Level [dB (uV)]		Limit [dB (uV)]		Margin (dB)	
			Q.P.	AV.	Q.P.	AV.	Q.P.	AV.	Q.P.	AV.
1	0.177	0.20	48.05	-	48.25	-	64.61	54.61	-16.36	-
2	0.236	0.20	41.81	-	42.01	-	62.24	52.24	-20.23	-
3	0.502	0.20	39.11	-	39.31	-	56.00	46.00	-16.69	-
4	0.591	0.20	36.38	-	36.58	-	56.00	46.00	-19.42	-
5	2.688	0.27	31.89	-	32.16	-	56.00	46.00	-23.84	-
6	19.234	0.98	36.89	-	37.87	-	60.00	50.00	-22.13	-

- REMARKS:**
1. Q.P. and AV. are abbreviations of quasi-peak and average individually.
 2. "-": The Quasi-peak reading value also meets average limit and measurement with the average detector is unnecessary.
 3. The emission levels of other frequencies were very low against the limit.
 4. Margin value = Emission level - Limit value
 5. Correction factor = Insertion loss + Cable loss
 6. Emission Level = Correction Factor + Reading Value.

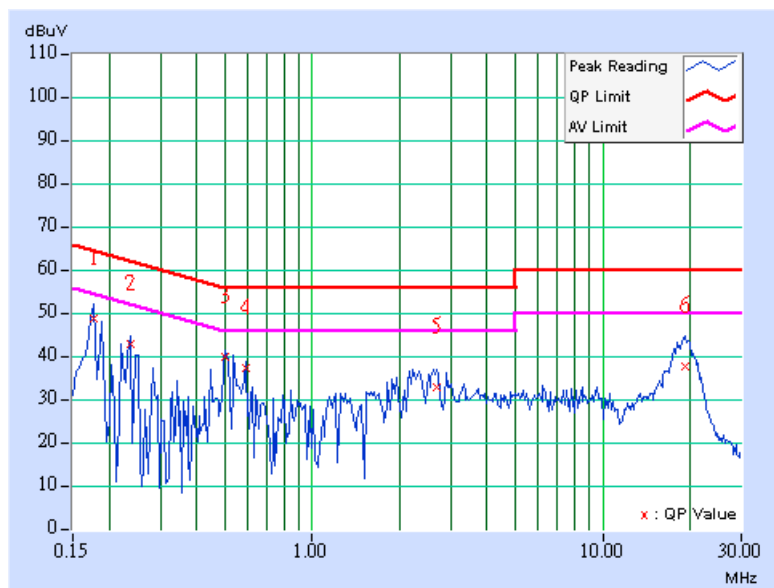



A D T

EUT TEST CONDITION		MEASUREMENT DETAIL	
CHANNEL	Channel 6	PHASE	Line 2
MODULATION TYPE	BPSK	INPUT POWER	120Vac, 60Hz
TRANSFER RATE	6.0Mbps	6dB BANDWIDTH	9kHz
ENVIRONMENTAL CONDITIONS	22deg. C, 60%RH, 1021hPa	TEST MODE	A
TESTED BY	Kevin Liang		

No	Freq. [MHz]	Corr. Factor (dB)	Reading Value [dB (uV)]		Emission Level [dB (uV)]		Limit [dB (uV)]		Margin (dB)	
			Q.P.	AV.	Q.P.	AV.	Q.P.	AV.	Q.P.	AV.
1	0.173	0.20	48.89	-	49.09	-	64.79	54.79	-15.70	-
2	0.232	0.20	40.86	-	41.06	-	62.38	52.38	-21.32	-
3	0.505	0.20	38.97	-	39.17	-	56.00	46.00	-16.83	-
4	0.572	0.20	38.35	-	38.55	-	56.00	46.00	-17.45	-
5	2.645	0.26	31.99	-	32.25	-	56.00	46.00	-23.75	-
6	18.941	0.51	36.65	-	37.16	-	60.00	50.00	-22.84	-

- REMARKS:**
1. Q.P. and AV. are abbreviations of quasi-peak and average individually.
 2. "-": The Quasi-peak reading value also meets average limit and measurement with the average detector is unnecessary.
 3. The emission levels of other frequencies were very low against the limit.
 4. Margin value = Emission level - Limit value
 5. Correction factor = Insertion loss + Cable loss
 6. Emission Level = Correction Factor + Reading Value.

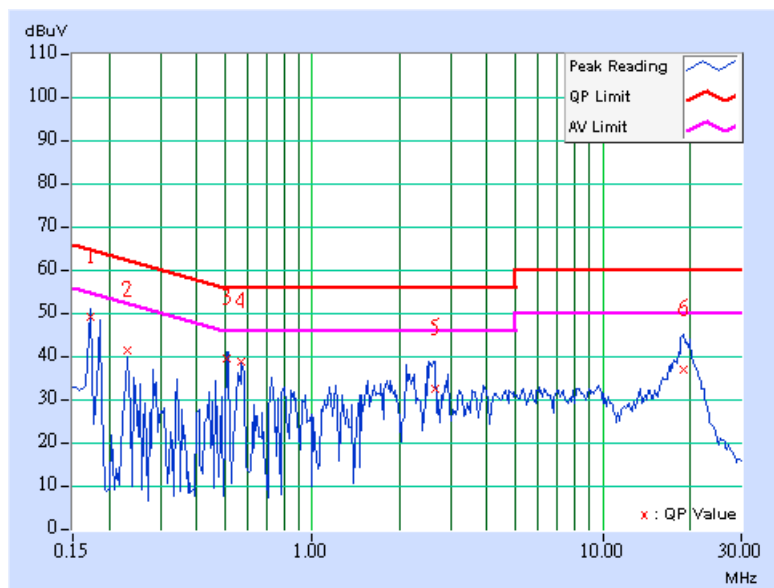

EUT TEST CONDITION		MEASUREMENT DETAIL	
CHANNEL	Channel 6	PHASE	Line 1
MODULATION TYPE	BPSK	INPUT POWER	120Vac, 60Hz
TRANSFER RATE	6.0Mbps	6dB BANDWIDTH	9kHz
ENVIRONMENTAL CONDITIONS	22deg. C, 60%RH, 1021hPa	TEST MODE	B
TESTED BY	Kevin Liang		

No	Freq. [MHz]	Corr. Factor (dB)	Reading Value [dB (uV)]		Emission Level [dB (uV)]		Limit [dB (uV)]		Margin (dB)	
			Q.P.	AV.	Q.P.	AV.	Q.P.	AV.	Q.P.	AV.
1	0.349	0.20	41.35	-	41.55	-	58.98	48.98	-17.43	-
2	0.584	0.20	36.88	-	37.08	-	56.00	46.00	-18.92	-
3	4.008	0.40	36.99	-	37.39	-	56.00	46.00	-18.61	-
4	4.836	0.42	37.59	-	38.01	-	56.00	46.00	-17.99	-
5	7.906	0.48	44.79	-	45.27	-	60.00	50.00	-14.73	-
6	18.183	0.93	50.85	38.33	51.78	39.26	60.00	50.00	-8.22	-10.74

- REMARKS:**
1. Q.P. and AV. are abbreviations of quasi-peak and average individually.
 2. "-": The Quasi-peak reading value also meets average limit and measurement with the average detector is unnecessary.
 3. The emission levels of other frequencies were very low against the limit.
 4. Margin value = Emission level - Limit value
 5. Correction factor = Insertion loss + Cable loss
 6. Emission Level = Correction Factor + Reading Value.

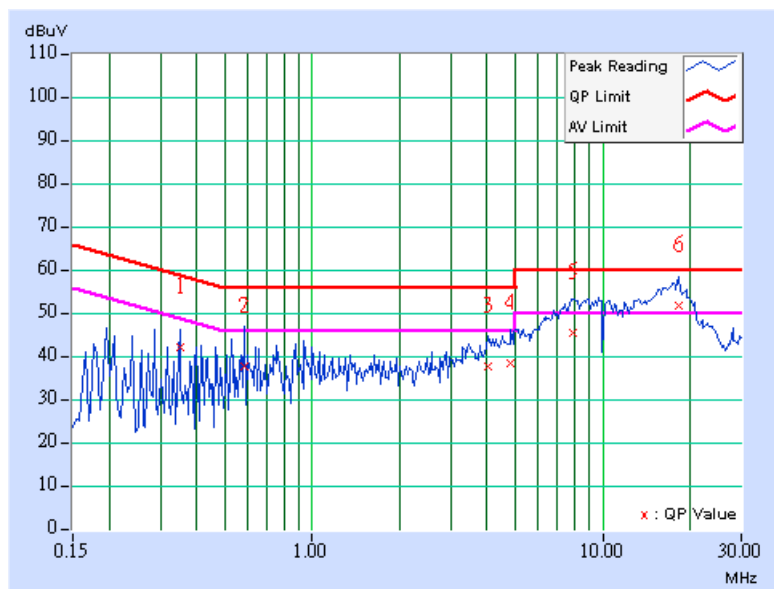

EUT TEST CONDITION		MEASUREMENT DETAIL	
CHANNEL	Channel 6	PHASE	Line 2
MODULATION TYPE	BPSK	INPUT POWER	120Vac, 60Hz
TRANSFER RATE	6.0Mbps	6dB BANDWIDTH	9kHz
ENVIRONMENTAL CONDITIONS	22deg. C, 60%RH, 1021hPa	TEST MODE	B
TESTED BY	Kevin Liang		

No	Freq. [MHz]	Corr. Factor (dB)	Reading Value [dB (uV)]		Emission Level [dB (uV)]		Limit [dB (uV)]		Margin (dB)	
			Q.P.	AV.	Q.P.	AV.	Q.P.	AV.	Q.P.	AV.
1	0.271	0.20	41.78	-	41.98	-	61.08	51.08	-19.10	-
2	0.529	0.20	41.82	-	42.02	-	56.00	46.00	-13.98	-
3	3.727	0.37	36.26	-	36.63	-	56.00	46.00	-19.37	-
4	4.910	0.42	39.07	-	39.49	-	56.00	46.00	-16.51	-
5	7.641	0.48	45.22	-	45.70	-	60.00	50.00	-14.30	-
6	16.992	0.50	49.56	36.72	50.06	37.22	60.00	50.00	-9.94	-12.78

- REMARKS:**
1. Q.P. and AV. are abbreviations of quasi-peak and average individually.
 2. "-": The Quasi-peak reading value also meets average limit and measurement with the average detector is unnecessary.
 3. The emission levels of other frequencies were very low against the limit.
 4. Margin value = Emission level - Limit value
 5. Correction factor = Insertion loss + Cable loss
 6. Emission Level = Correction Factor + Reading Value.

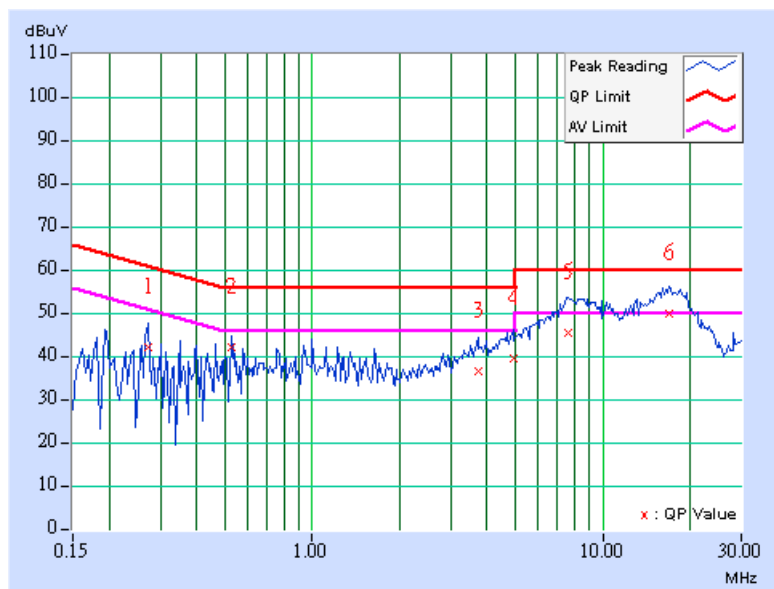



4.3 6dB BANDWIDTH MEASUREMENT

4.3.1 LIMITS OF 6dB BANDWIDTH MEASUREMENT

The minimum of 6dB Bandwidth Measurement is 0.5 MHz.

4.3.2 TEST INSTRUMENTS

DESCRIPTION & MANUFACTURER	MODEL NO.	SERIAL NO.	DATE OF CALIBRATION	CALIBRATED UNTIL
R&S SPECTRUM ANALYZER	FSP40	100041	Apr. 22, 2008	Apr. 21, 2009

NOTE: The calibration interval of the above test instruments is 12 months and the calibrations are traceable to NML/ROC and NIST/USA.

4.3.3 TEST PROCEDURE

The transmitter output was connected to the spectrum analyzer through an attenuator. The bandwidth of the fundamental frequency was measured by spectrum analyzer with 100kHz RBW and 300kHz VBW. The 6dB bandwidth is defined as the total spectrum the power of which is higher than peak power minus 6dB.

4.3.4 DEVIATION FROM TEST STANDARD

No deviation.

4.3.5 TEST SETUP

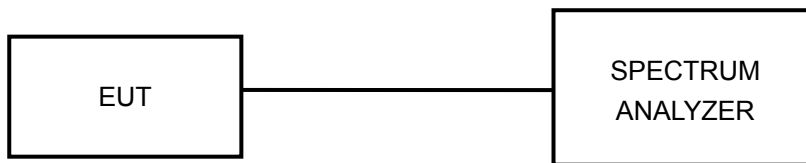

4.3.6 EUT OPERATING CONDITIONS

The software provided by client to enable the EUT under transmission condition continuously at lowest, middle and highest channel frequencies individually.



A D T

4.3.7 TEST RESULTS

802.11b DSSS MODULATION

MODULATION TYPE	DBPSK	TRANSFER RATE	1.0Mbps
INPUT POWER	120Vac, 60Hz	ENVIRONMENTAL CONDITIONS	25 deg.C, 65 %RH, 1021hPa
TESTED BY	Match Tsui		

CHANNEL	CHANNEL FREQUENCY (MHz)	6dB BANDWIDTH (MHz)		MINIMUM LIMIT (MHz)	PASS / FAIL
		CHAIN 0	CHAIN 1		
1	2412	10.14	12.09	0.5	PASS
6	2437	11.15	11.14	0.5	PASS
11	2462	12.08	11.09	0.5	PASS



A D T

FOR CHAIN 0: CH 1

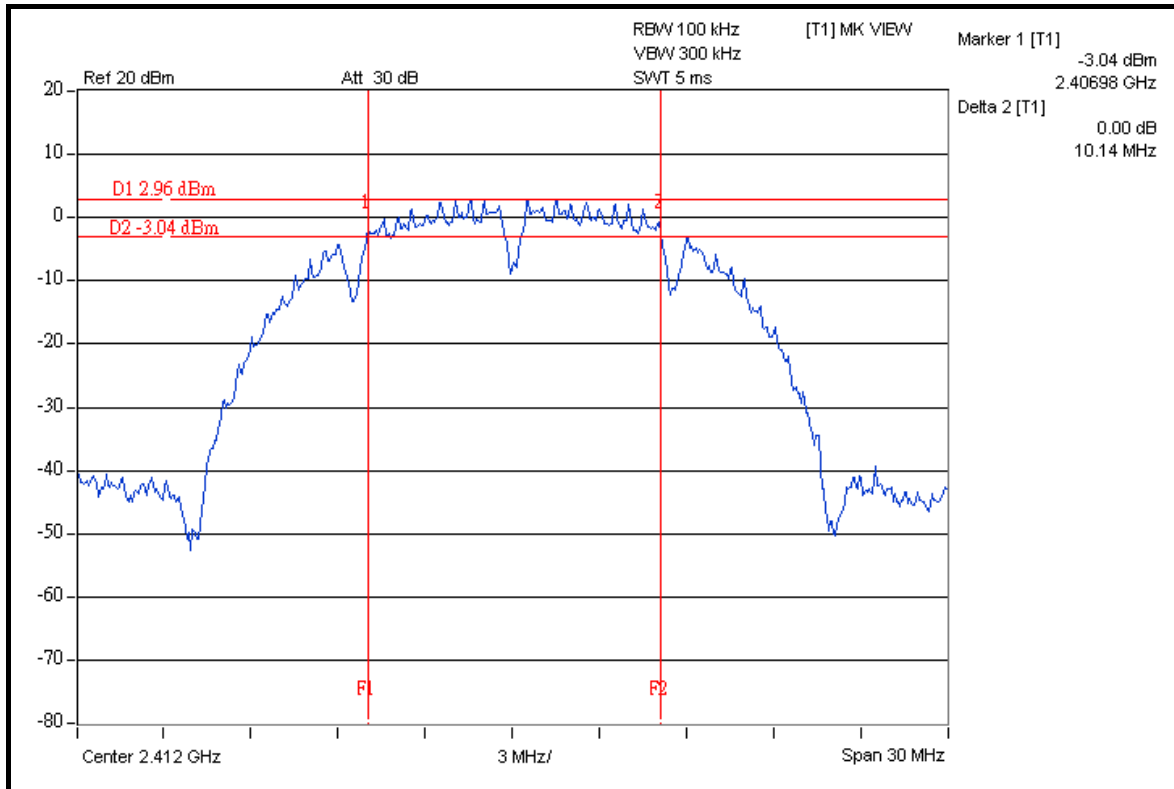

CH 6

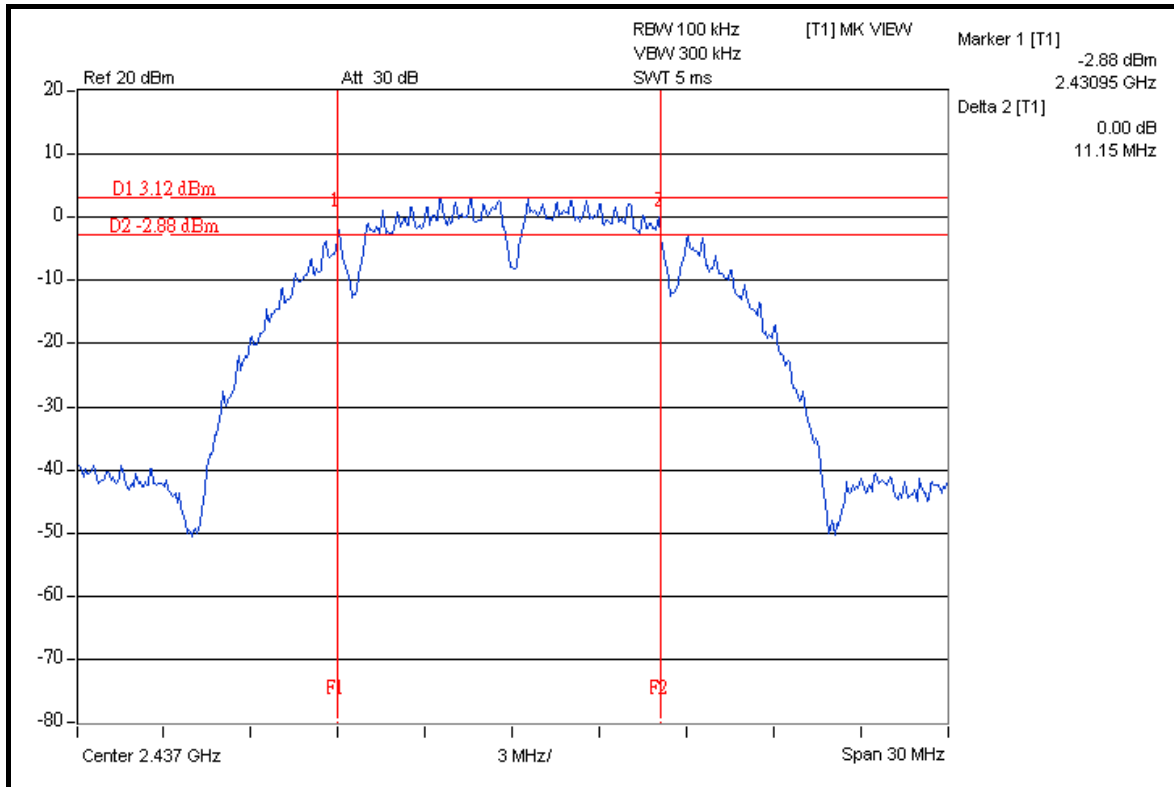



A D T

CH 11

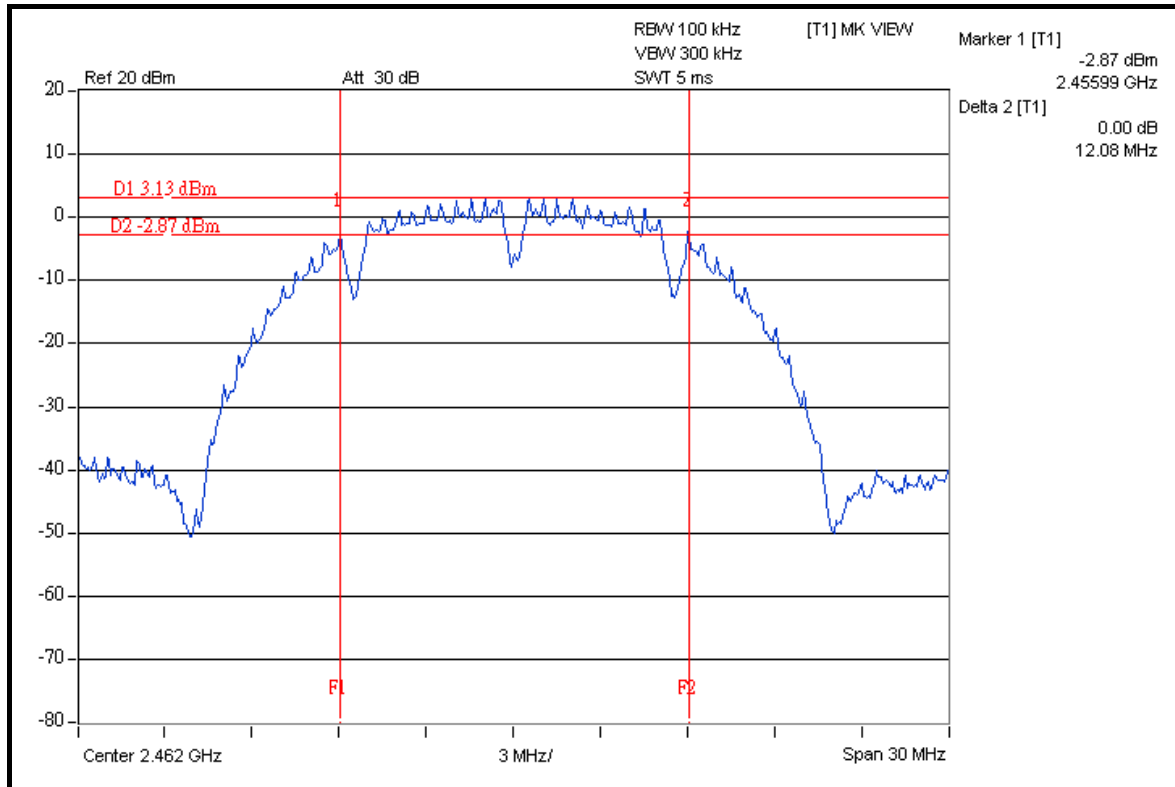

FOR CHAIN 1: CH 1

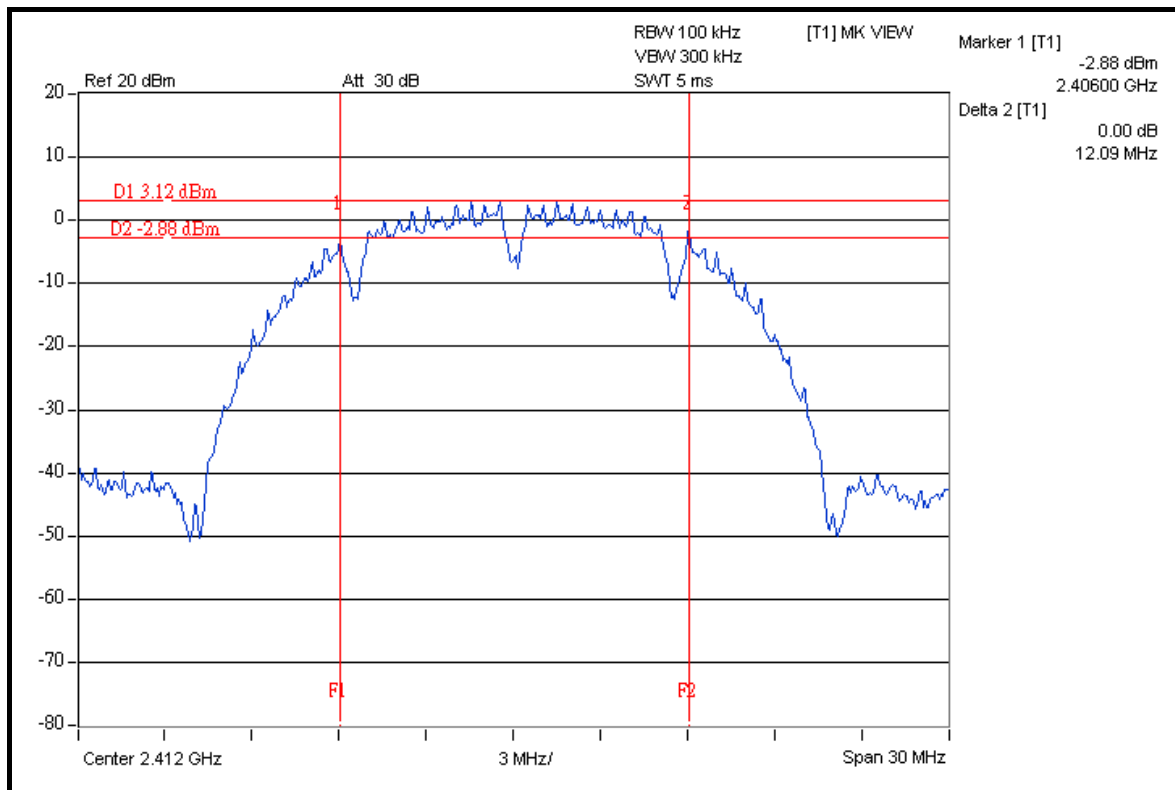



A D T

CH 6

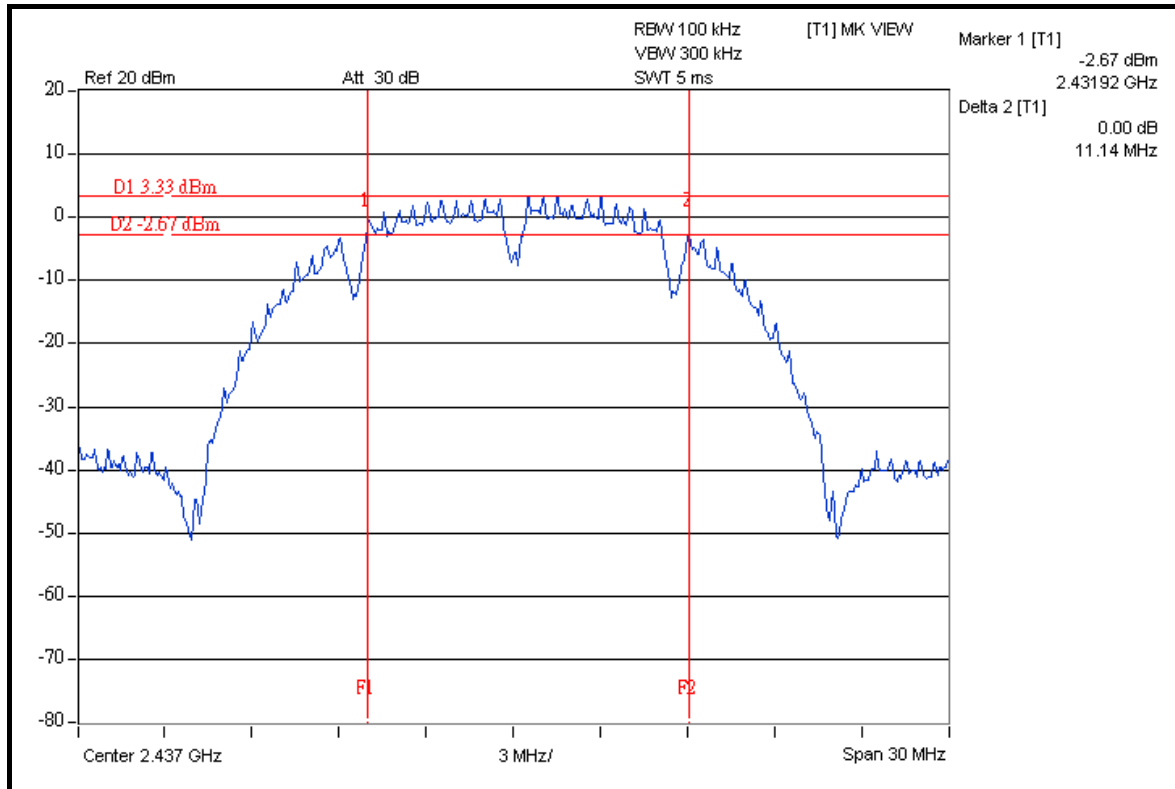

CH 11

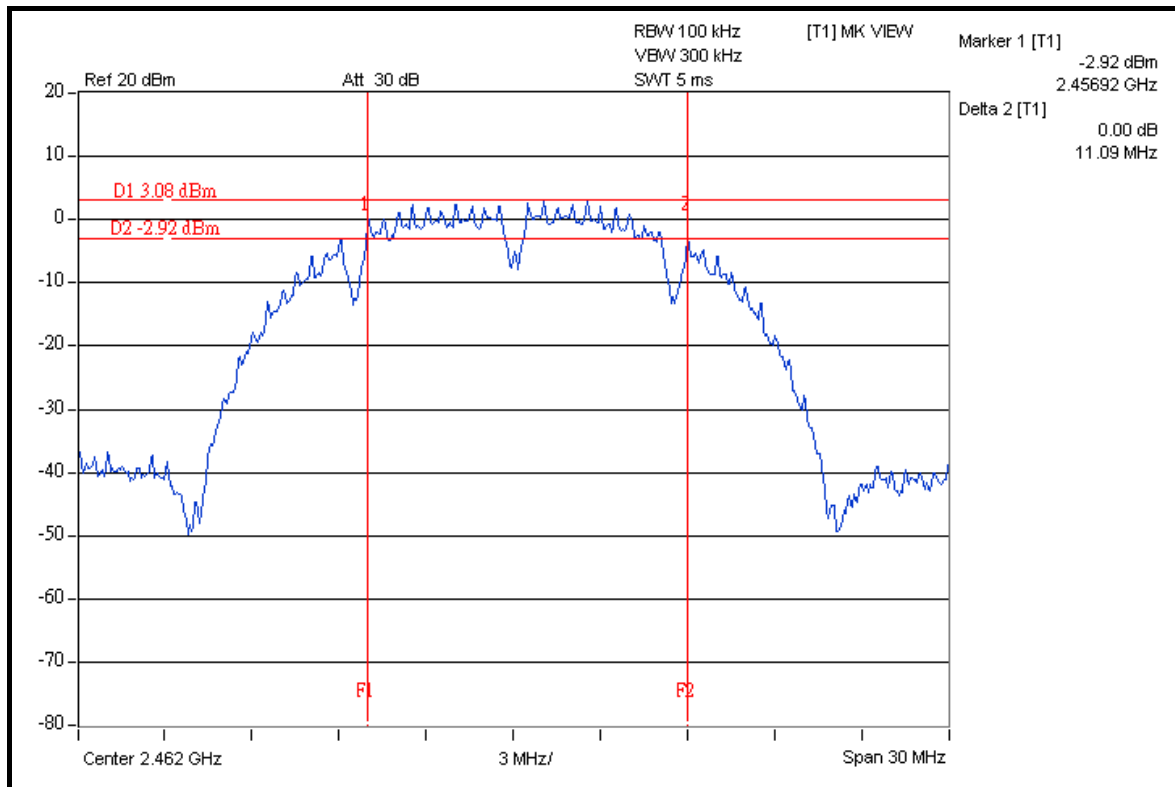



A D T

802.11g OFDM MODULATION

MODULATION TYPE	BPSK	TRANSFER RATE	6.0Mbps
INPUT POWER	120Vac, 60Hz	ENVIRONMENTAL CONDITIONS	25 deg.C, 65 %RH, 1021hPa
TESTED BY	Match Tsui		

CHANNEL	CHANNEL FREQUENCY (MHz)	6dB BANDWIDTH (MHz)		MINIMUM LIMIT (MHz)	PASS / FAIL
		CHAIN 0	CHAIN 1		
1	2412	16.43	16.39	0.5	PASS
6	2437	16.43	16.42	0.5	PASS
11	2462	16.41	16.42	10.5	PASS



A D T

FOR CHAIN 0: CH 1

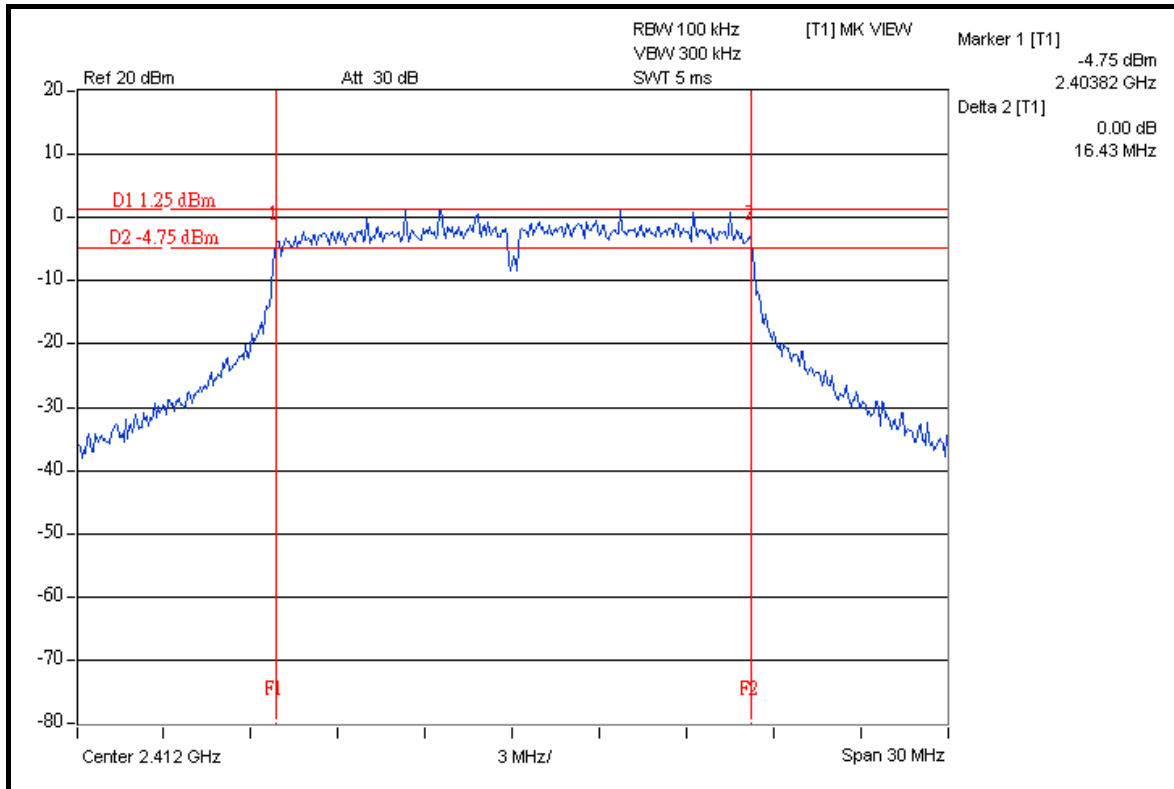

CH 6

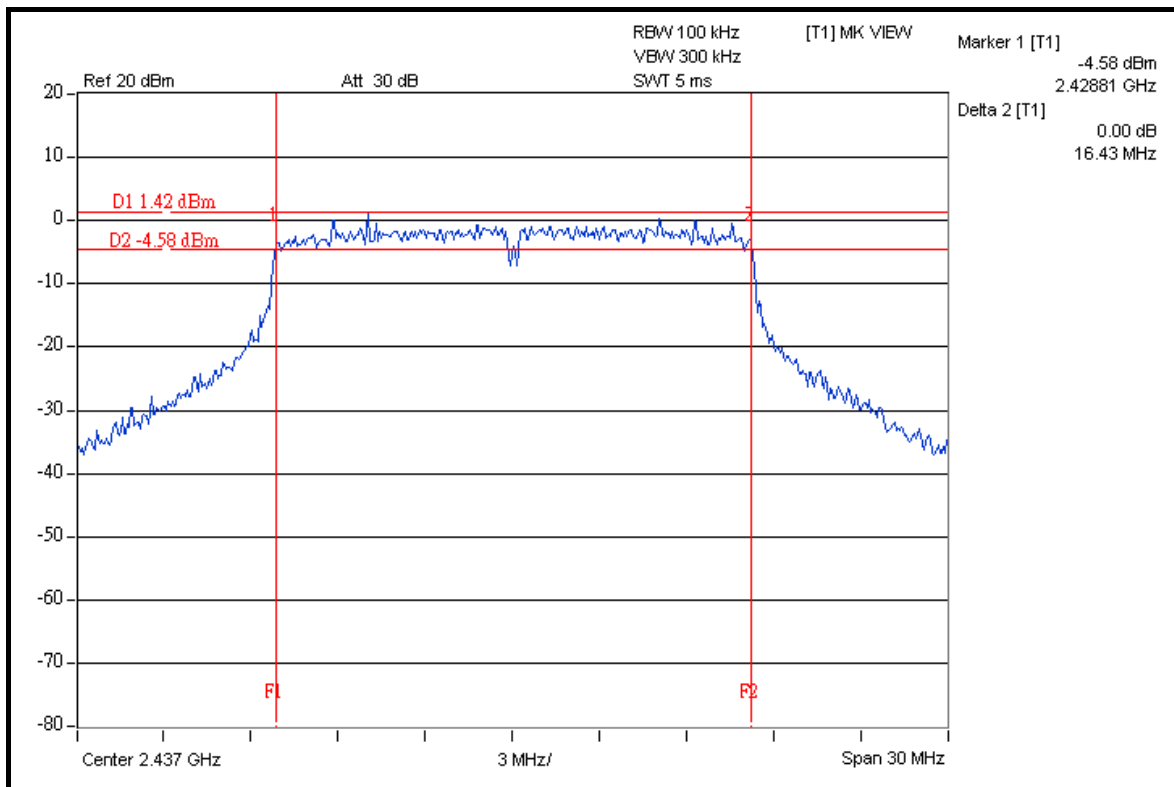



A D T

CH 11

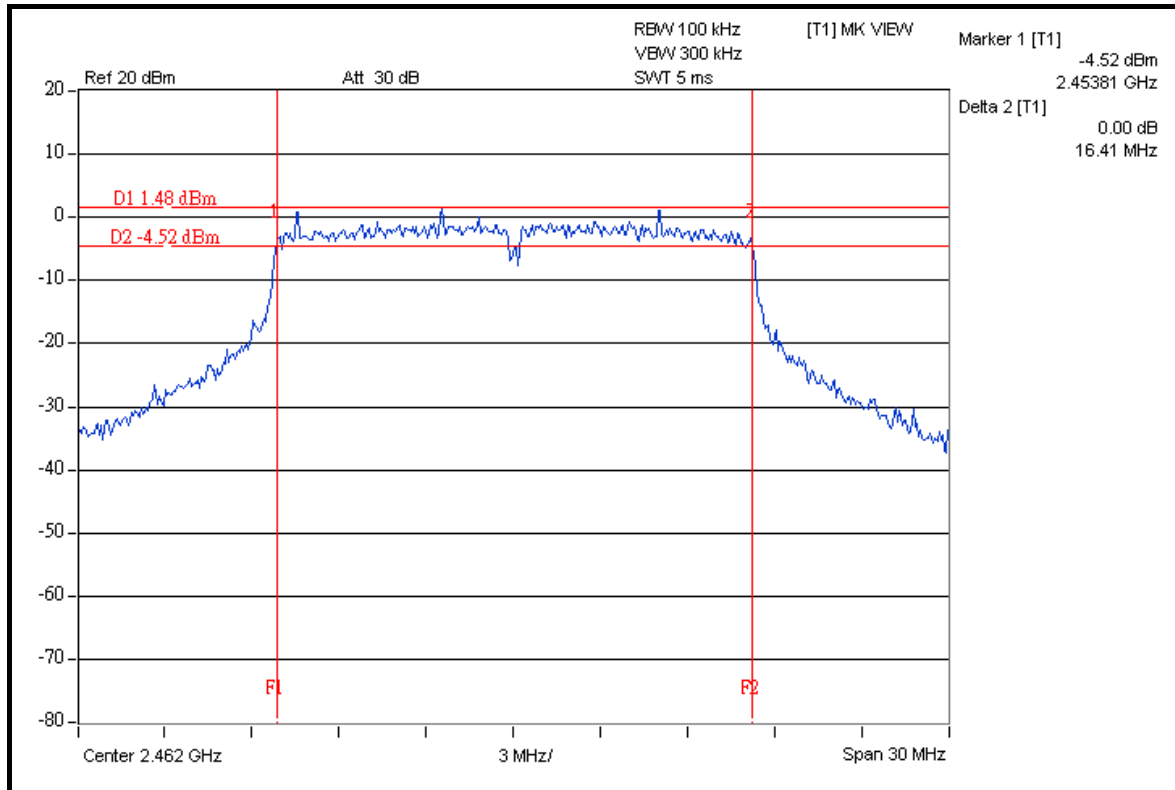

FOR CHAIN 1: CH 1

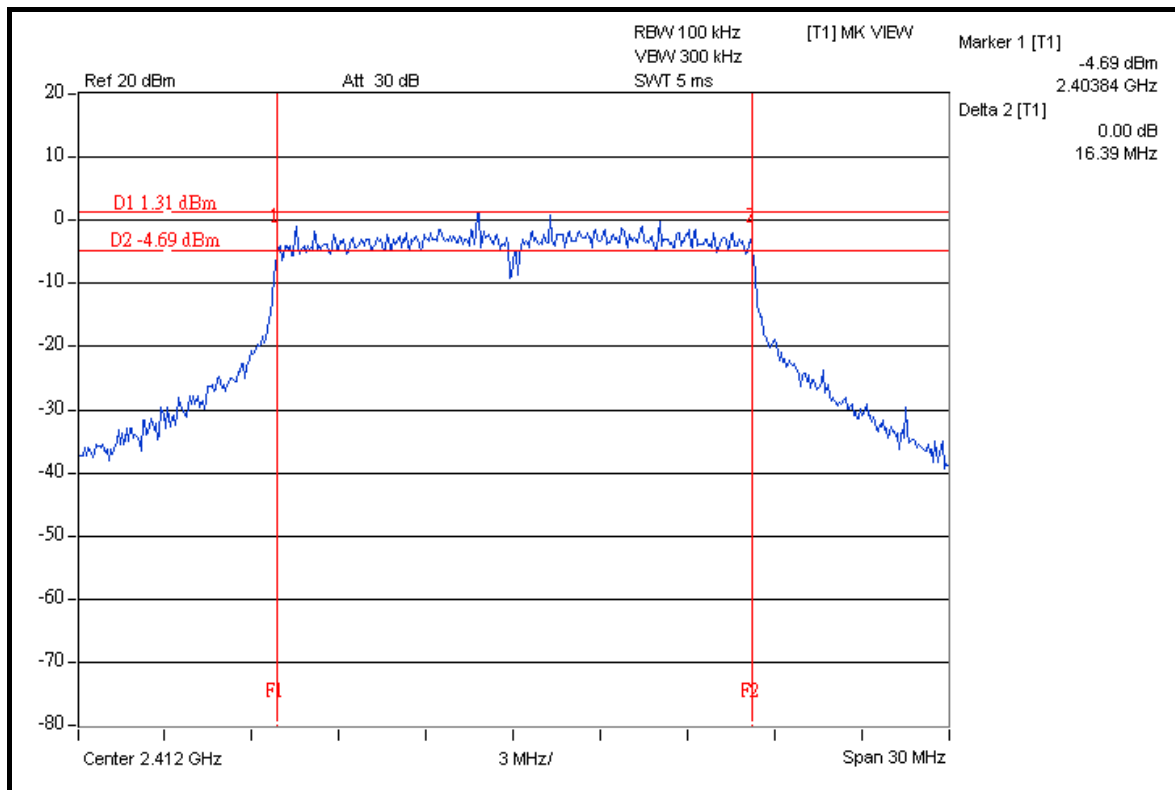



A D T

CH 6

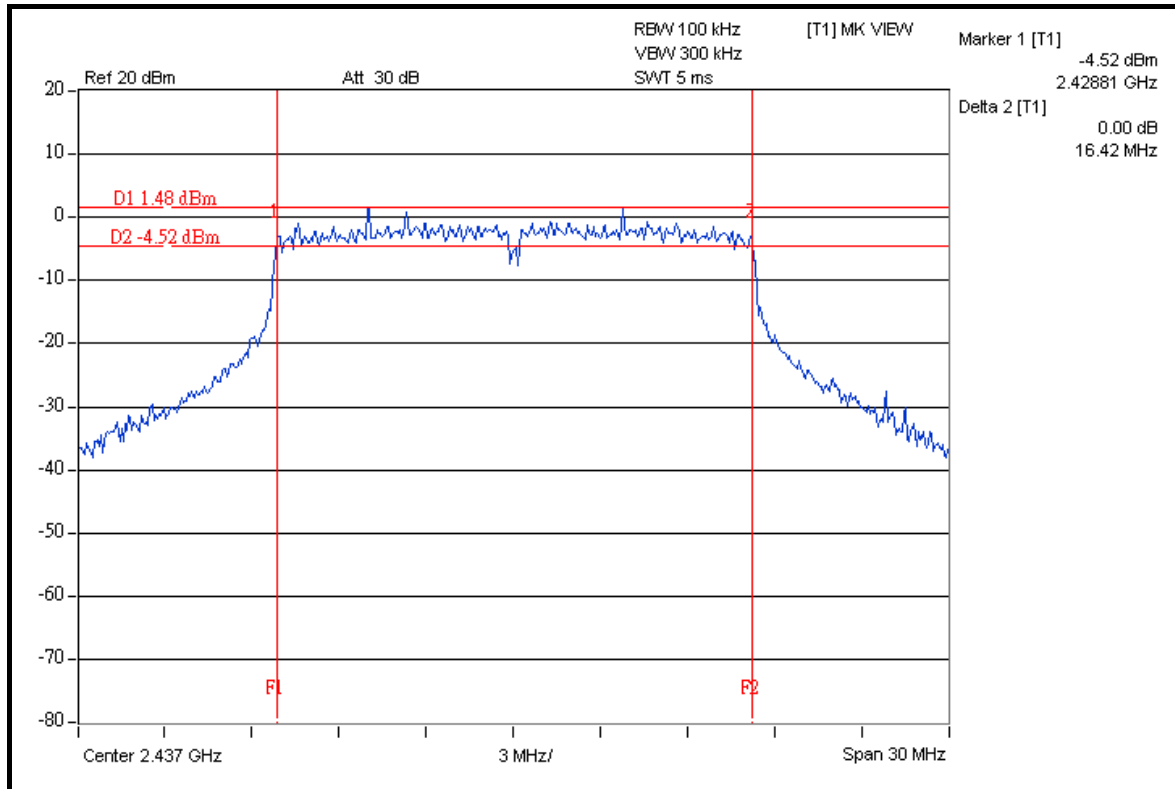

CH 11

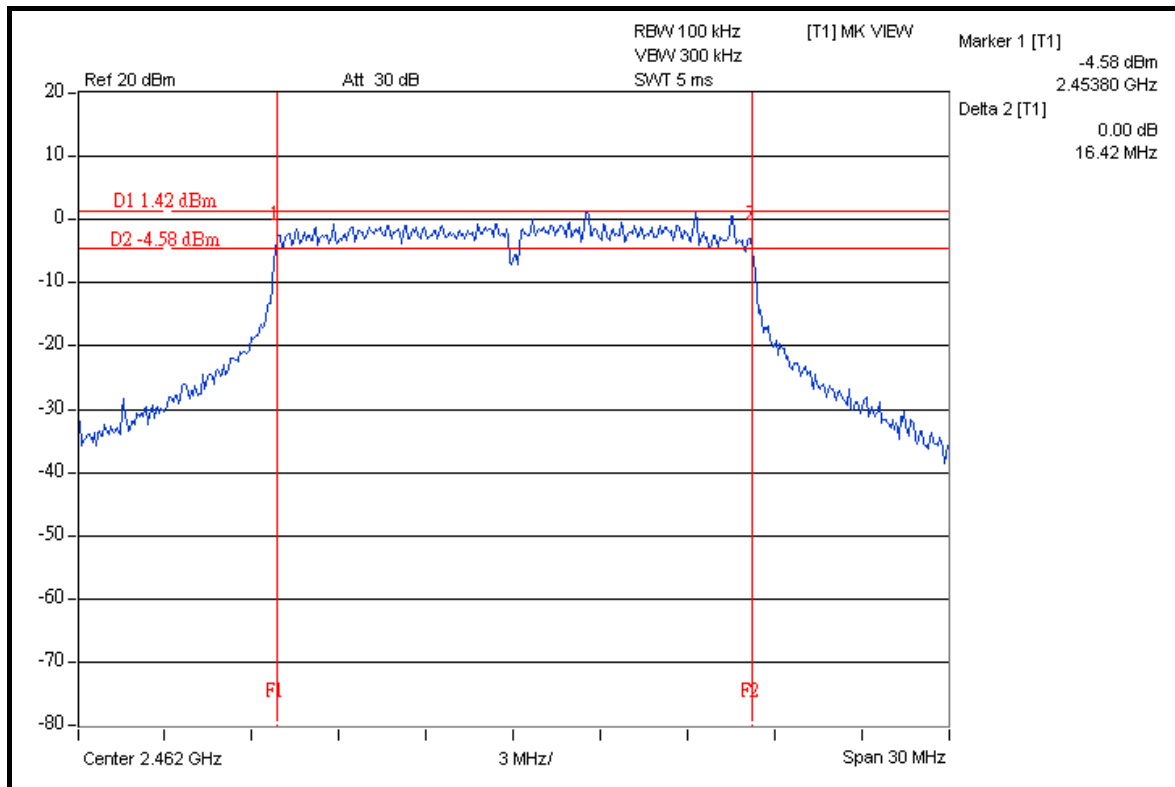



A D T

DRAFT 802.11n (20MHz) OFDM MODULATION

MODULATION TYPE	BPSK	TRANSFER RATE	7.2Mbps
INPUT POWER	120Vac, 60Hz	ENVIRONMENTAL CONDITIONS	25 deg.C, 65 %RH, 1021hPa
TESTED BY	Match Tsui		

CHANNEL	CHANNEL FREQUENCY (MHz)	6dB BANDWIDTH (MHz)		MINIMUM LIMIT (MHz)	PASS / FAIL
		CHAIN 0	CHAIN 1		
1	2412	17.61	17.63	0.5	PASS
6	2437	17.63	17.37	0.5	PASS
11	2462	17.67	17.63	0.5	PASS



A D T

FOR CHAIN 0: CH 1

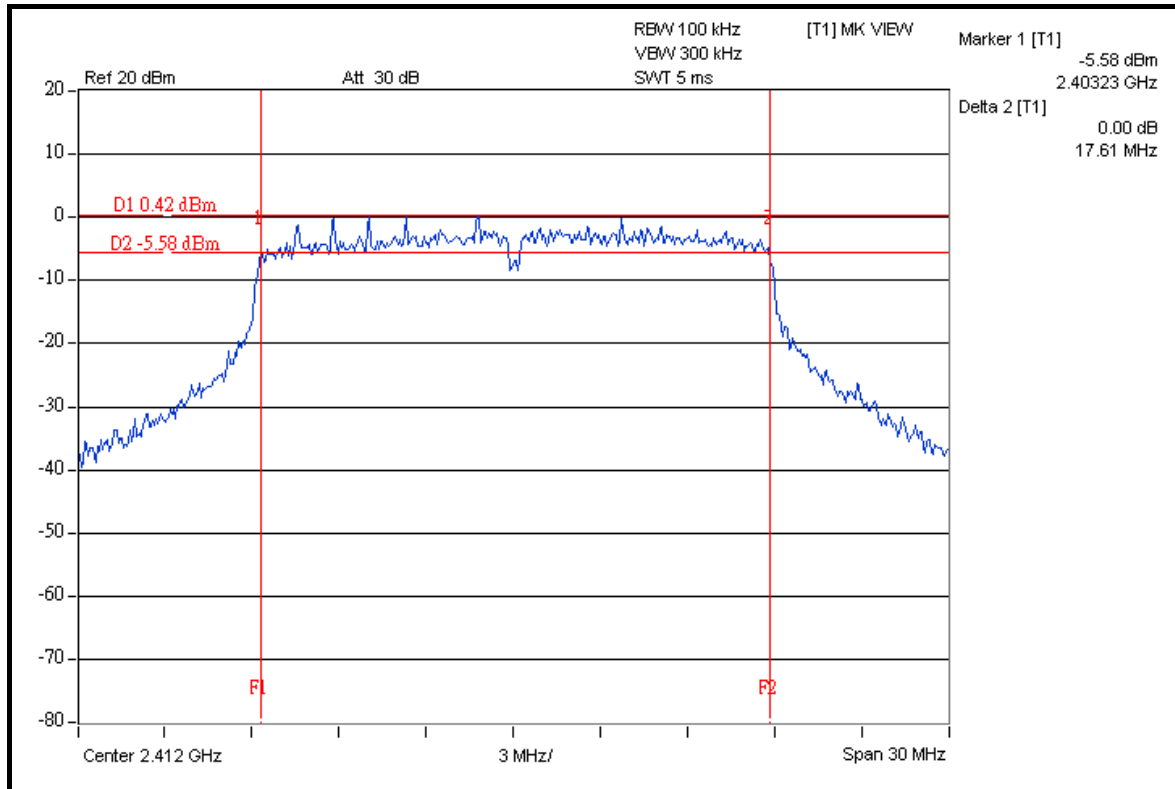

CH 6

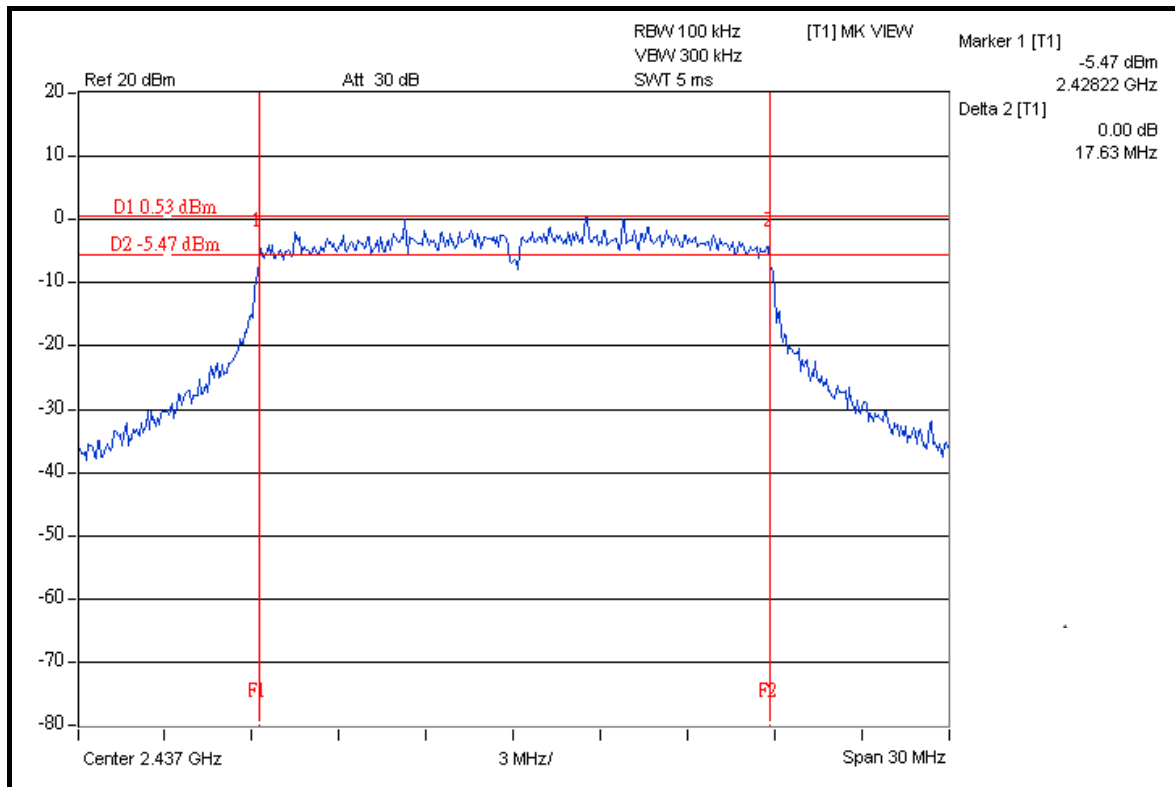



A D T

CH 11

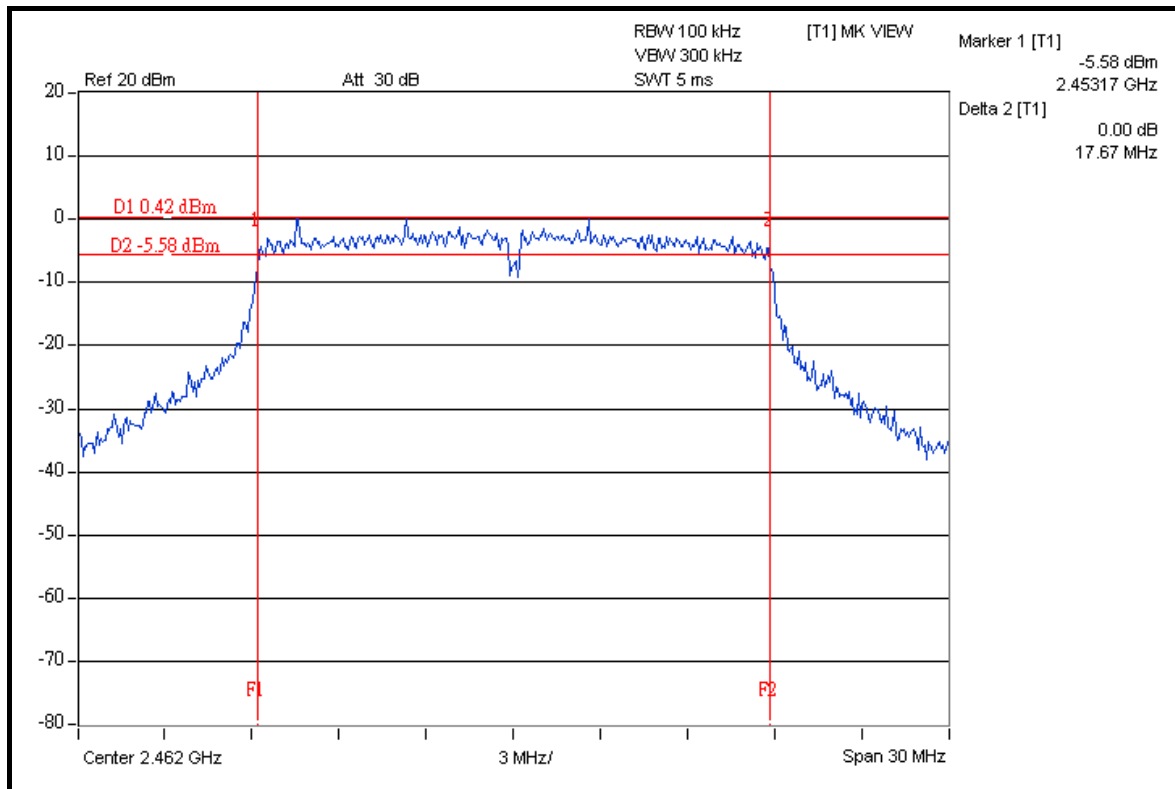

FOR CHAIN 1: CH 1

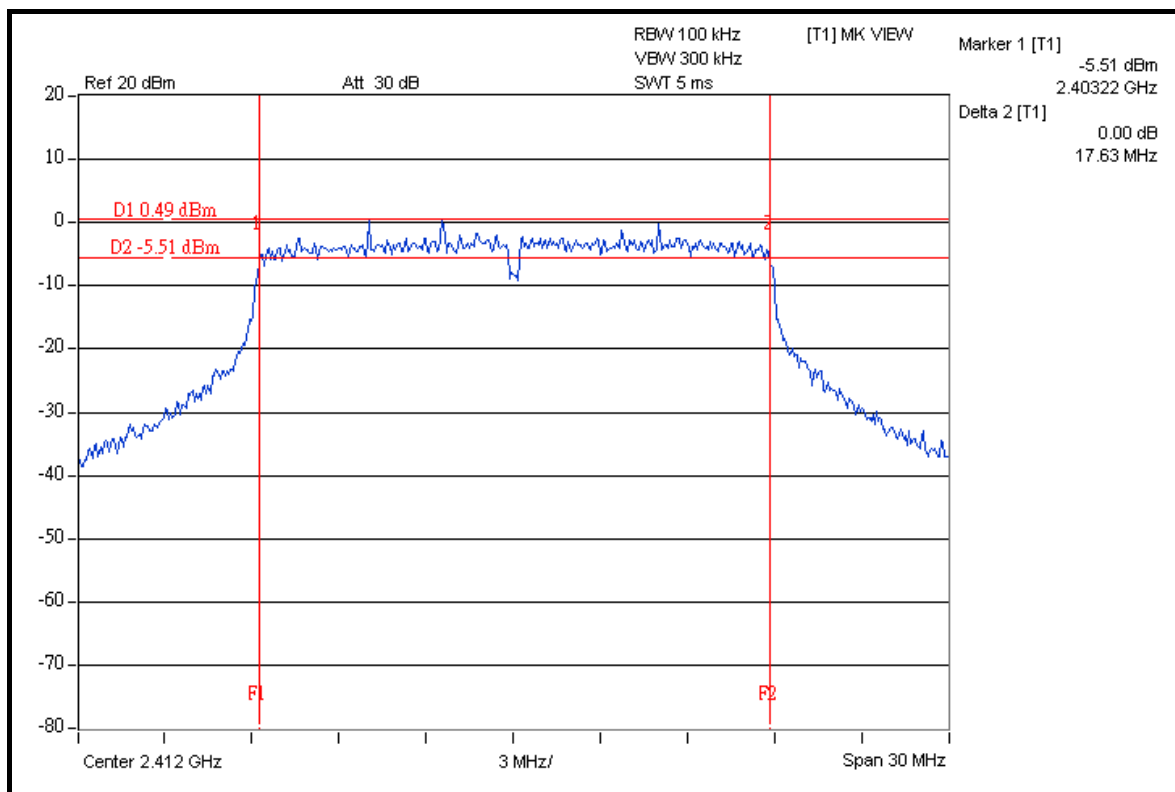



A D T

CH 6

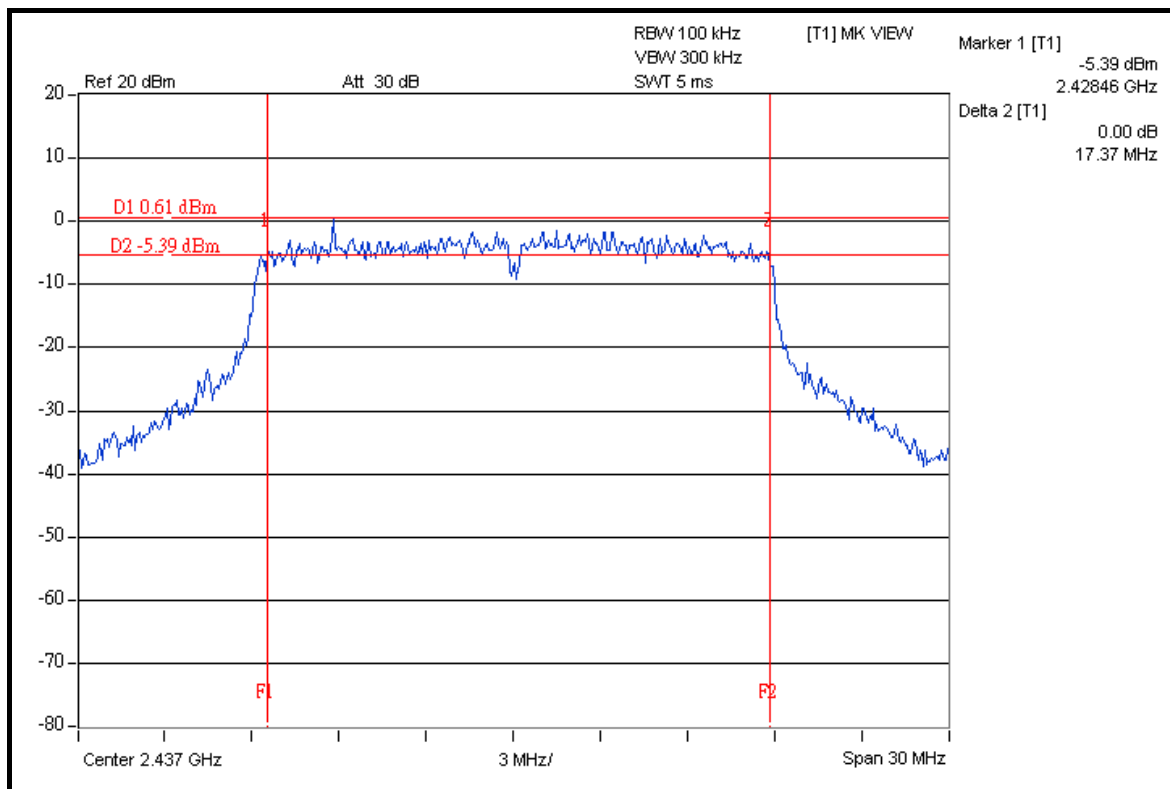

CH 11

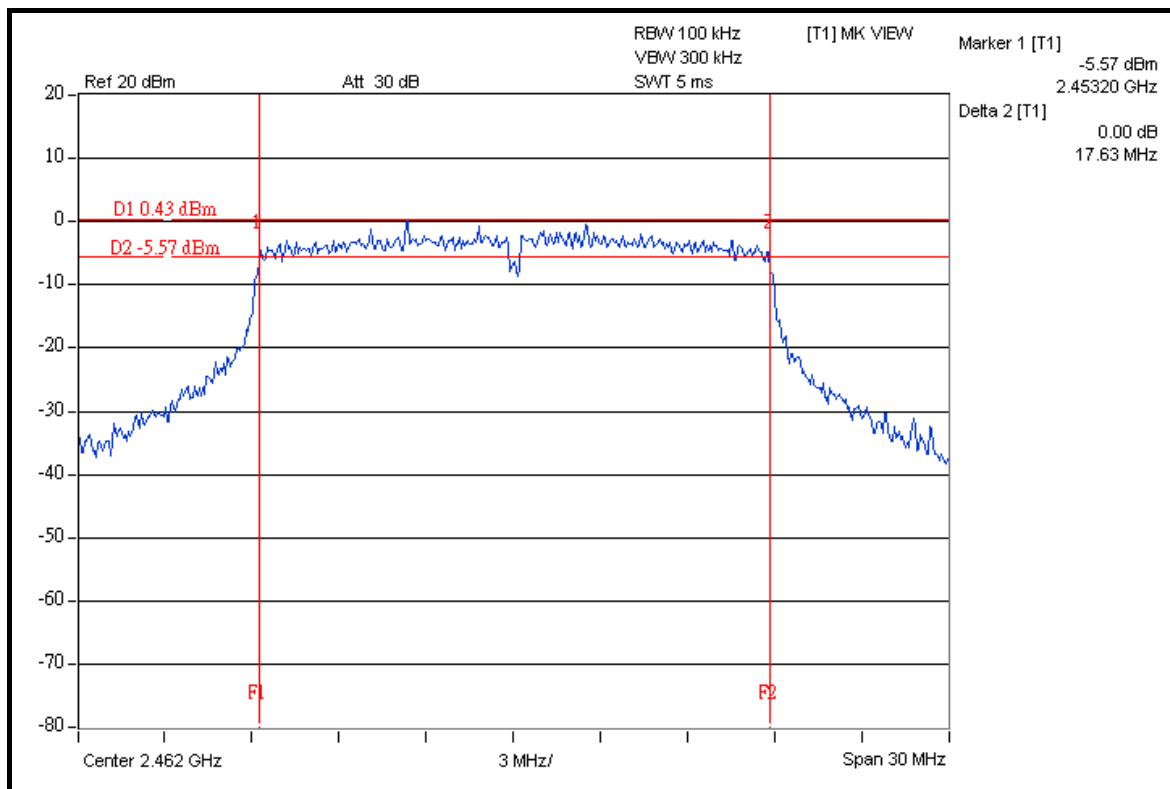



A D T

DRAFT 802.11n (40MHz) OFDM MODULATION

MODULATION TYPE	BPSK	TRANSFER RATE	15.0Mbps
INPUT POWER	120Vac, 60Hz	ENVIRONMENTAL CONDITIONS	25 deg.C, 65 %RH, 1021hPa
TESTED BY	Match Tsui		

CHANNEL	CHANNEL FREQUENCY (MHz)	6dB BANDWIDTH (MHz)		MINIMUM LIMIT (MHz)	PASS / FAIL
		CHAIN 0	CHAIN 1		
1	2422	36.44	36.22	0.5	PASS
4	2437	36.49	36.53	0.5	PASS
7	2452	36.51	36.49	0.5	PASS



A D T

FOR CHAIN 0: CH 1

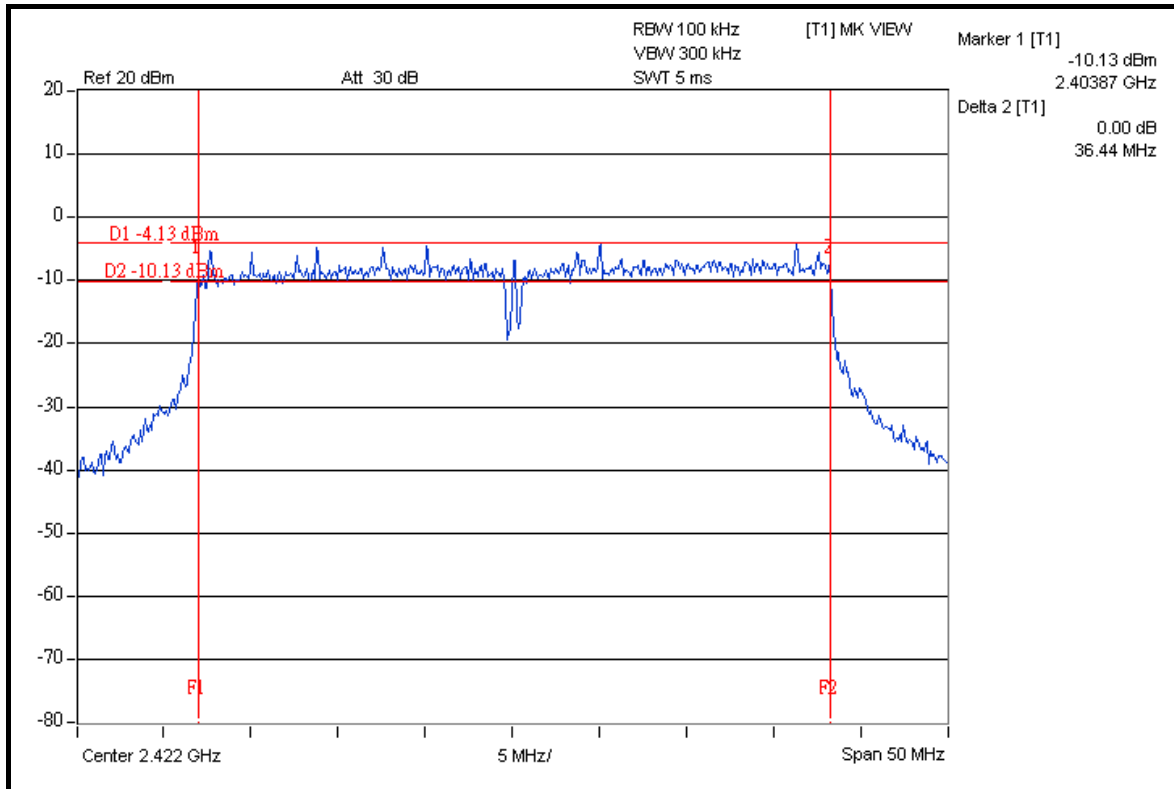

CH 4

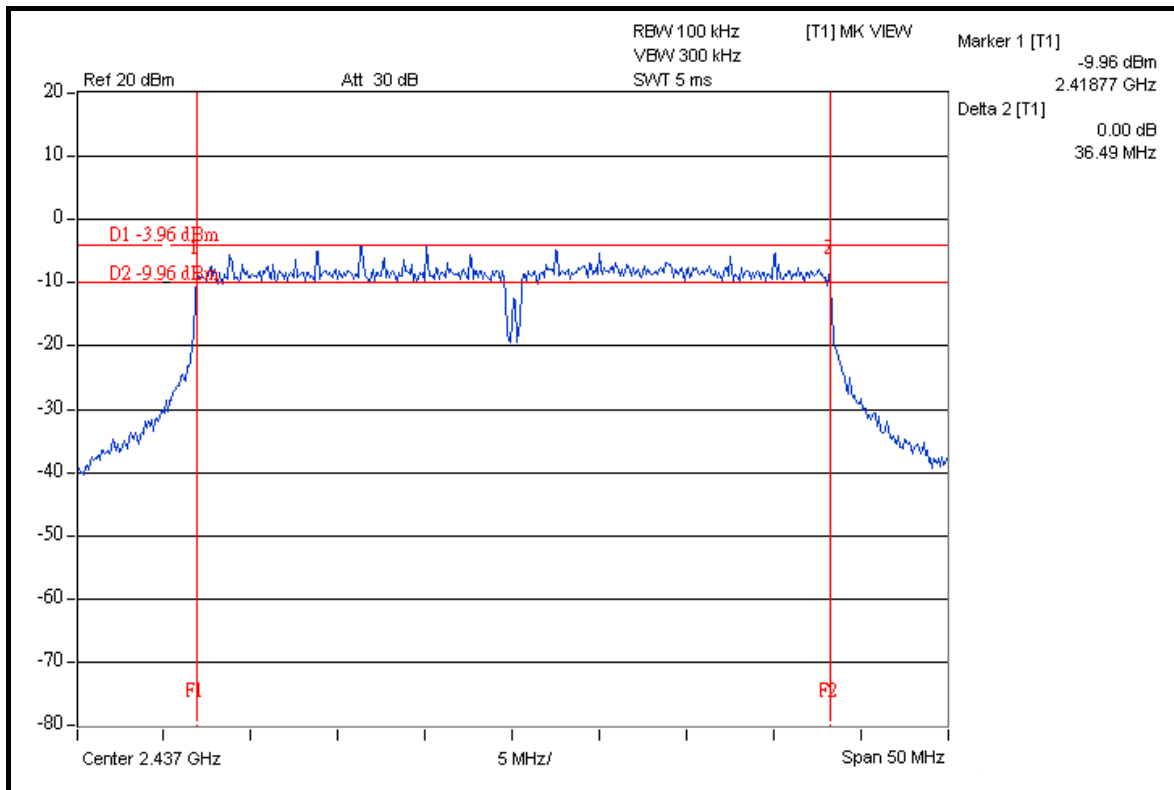



A D T

CH 7

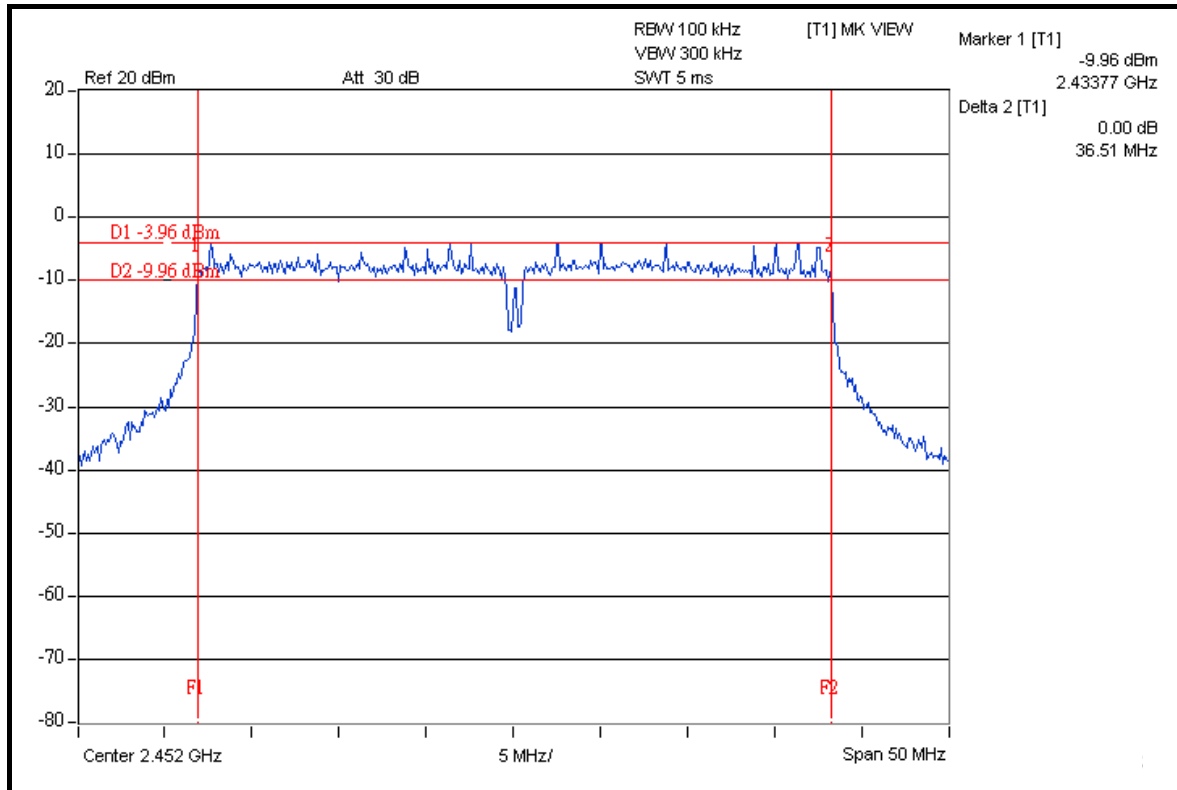

FOR CHAIN 1: CH 1

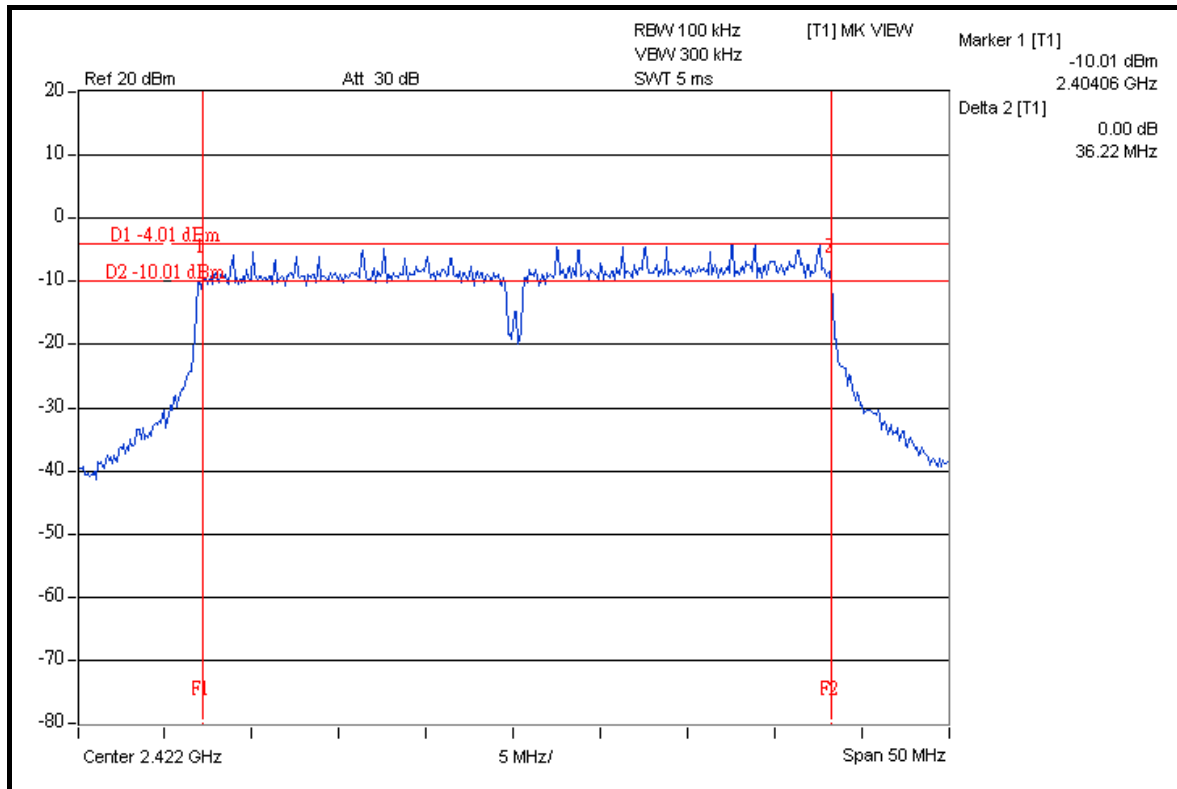



A D T

CH 4

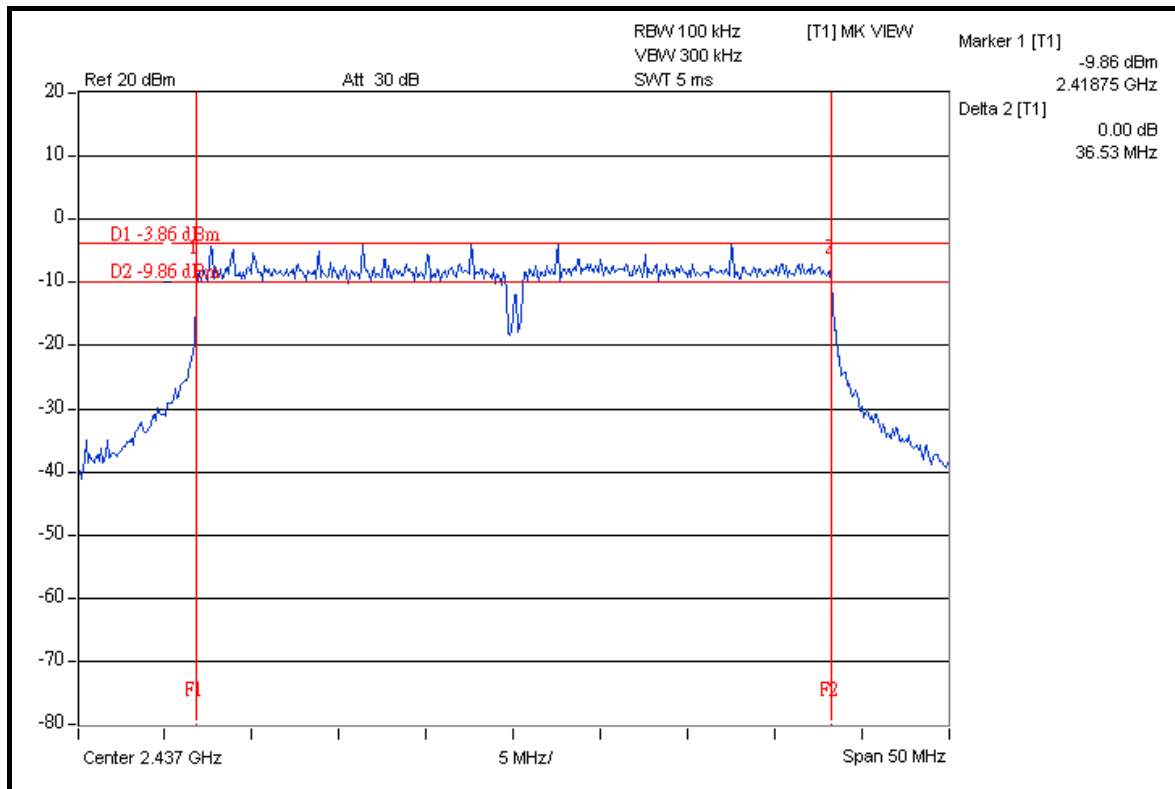

CH 7

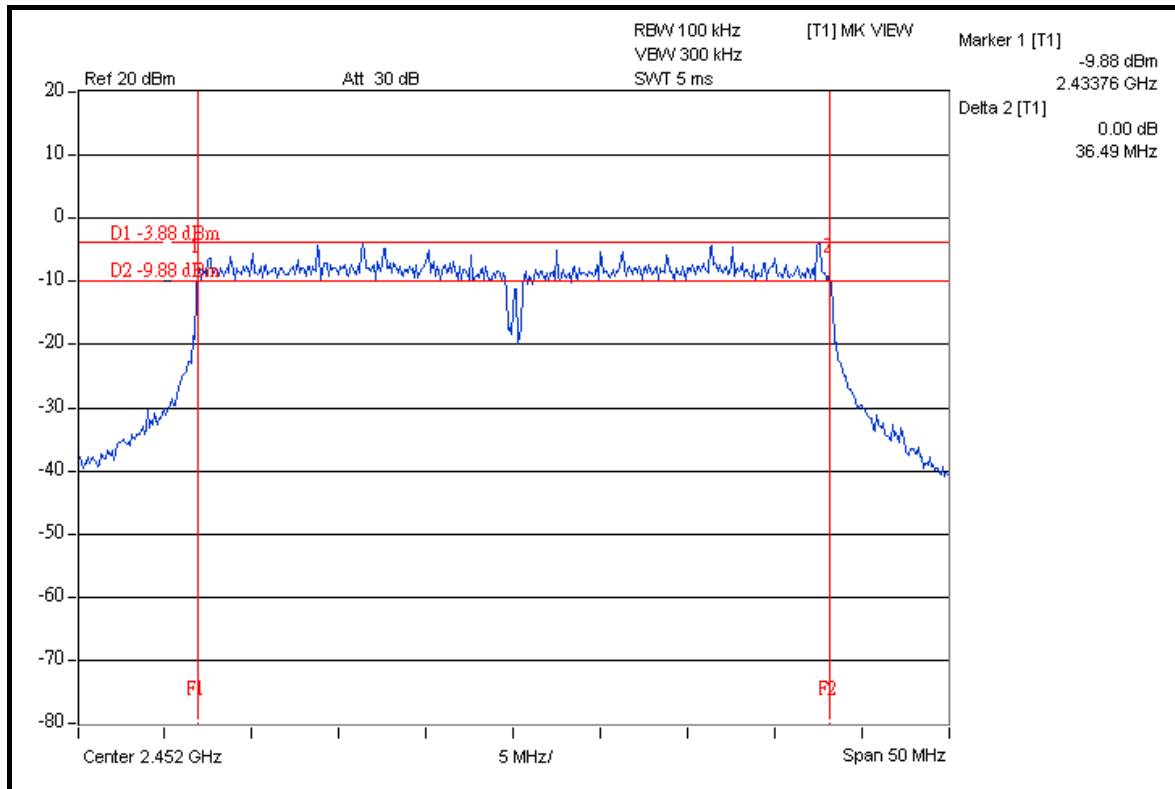



A D T

4.4 MAXIMUM PEAK OUTPUT POWER

4.4.1 LIMITS OF MAXIMUM PEAK OUTPUT POWER MEASUREMENT

The Maximum Peak Output Power Measurement is 30dBm.

4.4.2 INSTRUMENTS

DESCRIPTION & MANUFACTURER	MODEL NO.	SERIAL NO.	DATE OF CALIBRATION	CALIBRATED UNTIL
High Speed Peak Power Meter	ML2495A	0824012	Aug. 04, 2008	Aug. 03, 2009
Power Sensor	MA2444B	0738138	Aug. 04, 2008	Aug. 03, 2009

NOTE:

1. The calibration interval of the above test instruments is 12 months and the calibrations are traceable to NML/ROC and NIST/USA.
2. Measurement Bandwidth of ML2495A is 65MHz greater than 6dB bandwidth of emission.

4.4.3 TEST PROCEDURES

A power sensor was used on the output port of the EUT. A power meter was used to read the response of the power sensor. Record the power level.

4.4.4 DEVIATION FROM TEST STANDARD

No deviation.

4.4.5 TEST SETUP

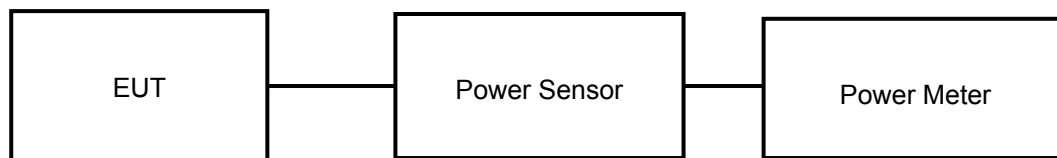

4.4.6 EUT OPERATING CONDITIONS

Same as Item 4.3.6.



4.4.7 TEST RESULTS

802.11b DSSS MODULATION

MODULATION TYPE	DBPSK	TRANSFER RATE	1.0Mbps
INPUT POWER	120Vac, 60Hz	ENVIRONMENTAL CONDITIONS	25 deg.C, 65 %RH, 1021hPa
TESTED BY	Match Tsui		

CHAN.	CHAN. FREQ. (MHz)	PEAK POWER OUTPUT (dBm)		TOTAL PEAK POWER (mW)	TOTAL PEAK POWER (dBm)	PEAK POWER LIMIT (dBm)	PASS / FAIL
		CHAIN 0	CHAIN 1				
1	2412	16.54	16.52	89.956	19.54	30	PASS
6	2437	16.59	16.57	90.998	19.59	30	PASS
11	2462	16.56	16.53	90.268	19.56	30	PASS

802.11g OFDM MODULATION

MODULATION TYPE	BPSK	TRANSFER RATE	6.0Mbps
INPUT POWER	120Vac, 60Hz	ENVIRONMENTAL CONDITIONS	25 deg.C, 65 %RH, 1021hPa
TESTED BY	Match Tsui		

CHAN.	CHAN. FREQ. (MHz)	PEAK POWER OUTPUT (dBm)		TOTAL PEAK POWER (mW)	TOTAL PEAK POWER (dBm)	PEAK POWER LIMIT (dBm)	PASS / FAIL
		CHAIN 0	CHAIN 1				
1	2412	22.53	22.54	358.534	25.55	30	PASS
6	2437	22.57	22.58	361.851	25.59	30	PASS
11	2462	22.51	22.55	358.125	25.54	30	PASS



A D T

DRAFT 802.11n (20MHz) OFDM MODULATION

MODULATION TYPE	BPSK	TRANSFER RATE	7.2Mbps
INPUT POWER	120Vac, 60Hz	ENVIRONMENTAL CONDITIONS	25 deg.C, 65 %RH, 1021hPa
TESTED BY	Match Tsui		

CHAN.	CHAN. FREQ. (MHz)	PEAK POWER OUTPUT (dBm)		TOTAL PEAK POWER (mW)	TOTAL PEAK POWER (dBm)	PEAK POWER LIMIT (dBm)	PASS / FAIL
		CHAIN 0	CHAIN 1				
1	2412	22.05	22.06	321.019	25.07	30	PASS
6	2437	22.08	22.12	324.365	25.11	30	PASS
11	2462	22.04	22.07	321.020	25.07	30	PASS

DRAFT 802.11n (40MHz) OFDM MODULATION

MODULATION TYPE	BPSK	TRANSFER RATE	15.0Mbps
INPUT POWER	120Vac, 60Hz	ENVIRONMENTAL CONDITIONS	25 deg.C, 65 %RH, 1021hPa
TESTED BY	Match Tsui		

CHAN.	CHAN. FREQ. (MHz)	PEAK POWER OUTPUT (dBm)		TOTAL PEAK POWER (mW)	TOTAL PEAK POWER (dBm)	PEAK POWER LIMIT (dBm)	PASS / FAIL
		CHAIN 0	CHAIN 1				
1	2422	20.52	20.53	225.699	23.54	30	PASS
4	2437	20.58	20.56	228.051	23.58	30	PASS
7	2452	20.54	20.52	225.960	23.54	30	PASS



4.5 POWER SPECTRAL DENSITY MEASUREMENT

4.5.1 LIMITS OF POWER SPECTRAL DENSITY MEASUREMENT

The Maximum of Power Spectral Density Measurement is 8dBm.

4.5.2 TEST INSTRUMENTS

DESCRIPTION & MANUFACTURER	MODEL NO.	SERIAL NO.	DATE OF CALIBRATION	CALIBRATED UNTIL
R&S SPECTRUM ANALYZER	FSP40	100041	Apr. 22, 2008	Apr. 21, 2009

NOTE: The calibration interval of the above test instruments is 12 months and the calibrations are traceable to NML/ROC and NIST/USA.

4.5.3 TEST PROCEDURE

The transmitter output was connected to the spectrum analyzer through an attenuator, the bandwidth of the fundamental frequency was measured with the spectrum analyzer using 3kHz RBW and 30kHz VBW, set sweep time = span/3kHz. The power spectral density was measured and recorded.

The sweep time is allowed to be longer than span/3kHz for a full response of the mixer in the spectrum analyzer.



A D T

4.5.4 DEVIATION FROM TEST STANDARD

No deviation

4.5.5 TEST SETUP

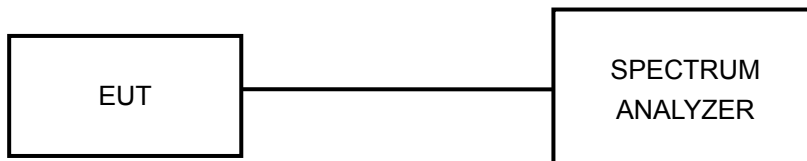

4.5.6 EUT OPERATING CONDITION

Same as Item 4.3.6



4.5.7 TEST RESULTS

802.11b DSSS MODULATION

MODULATION TYPE	DBPSK	TRANSFER RATE	1.0Mbps
INPUT POWER	120Vac, 60Hz	ENVIRONMENTAL CONDITIONS	25 deg.C, 65 %RH, 1021hPa
TESTED BY	Match Tsui		

CHAN.	CHAN. FREQ. (MHz)	RF POWER LEVEL IN 3kHz BW (dBm)		TOTAL POWER DENSITY (mW)	TOTAL POWER DENSITY (dBm)	MAX. LIMIT (dBm)	PASS / FAIL
		CHAIN 0	CHAIN 1				
1	2412	-9.96	-10.32	0.194	-7.13	8	PASS
6	2437	-9.82	-10.27	0.198	-7.03	8	PASS
11	2462	-9.89	-10.42	0.193	-7.14	8	PASS



A D T

FOR CHAIN 0: CH 1

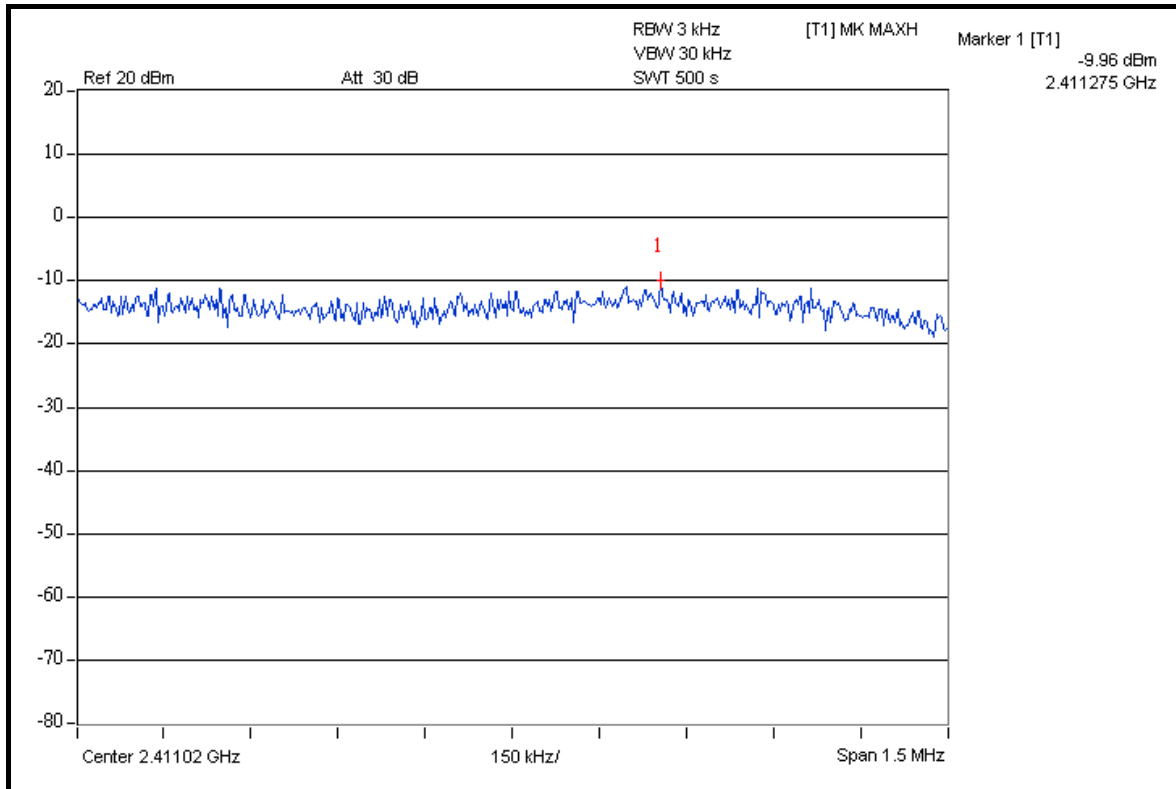

CH 6

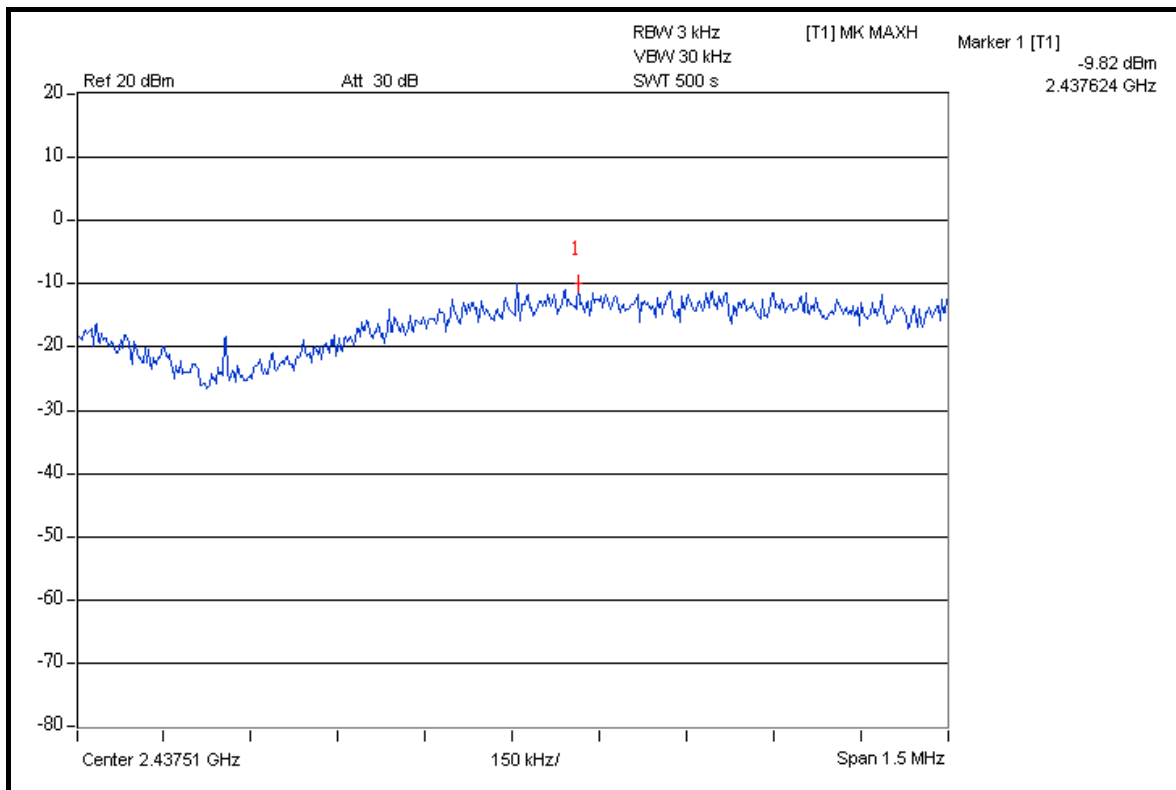



A D T

CH 11

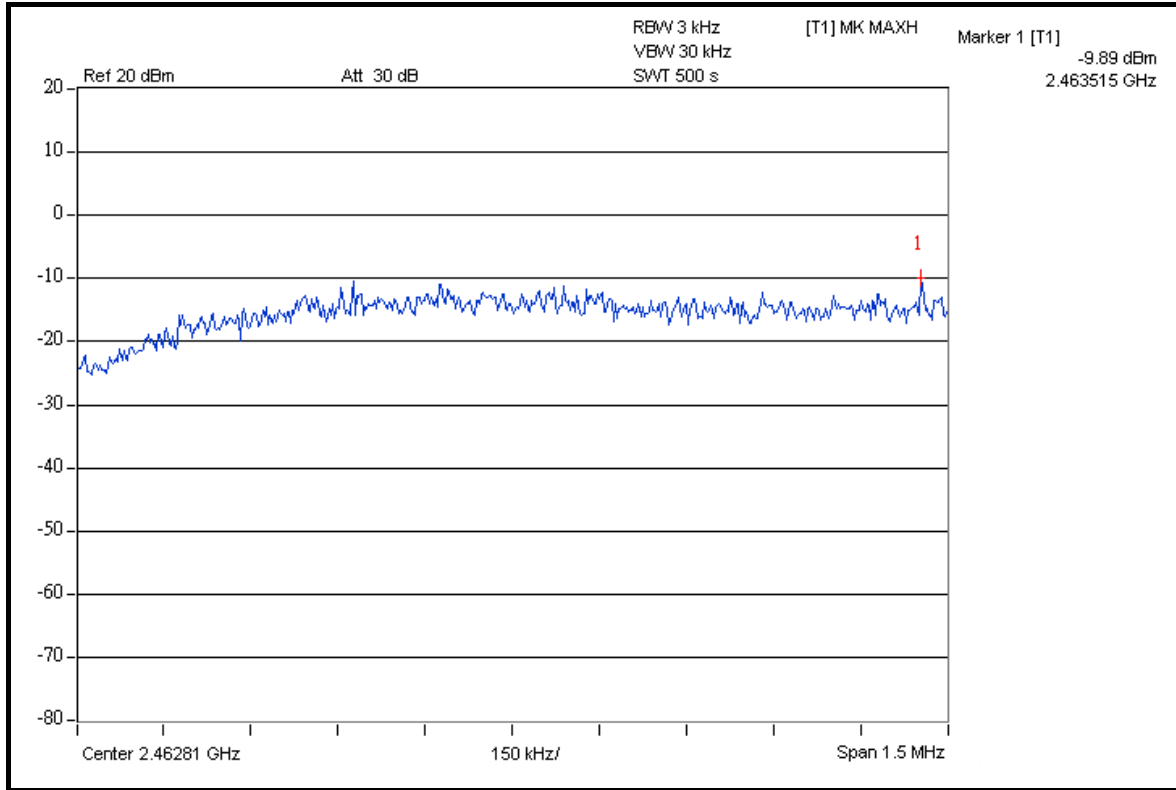

FOR CHAIN 1: CH 1

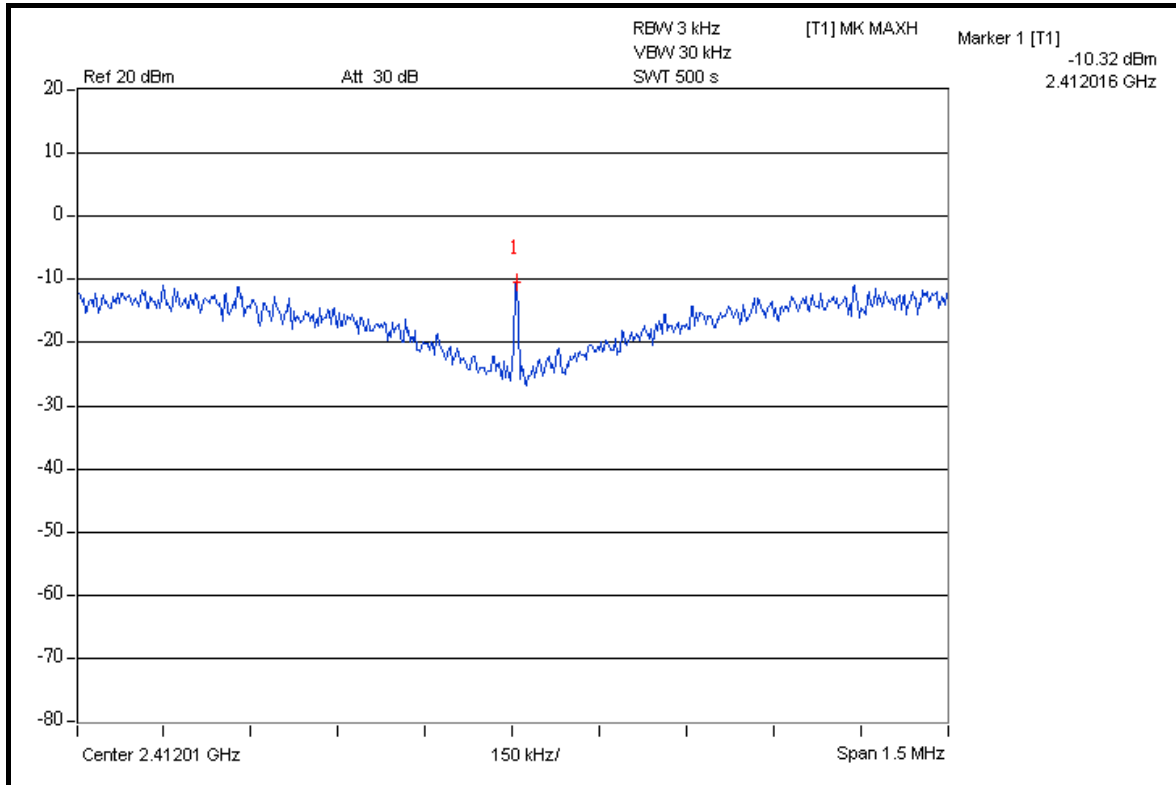



A D T

CH 6

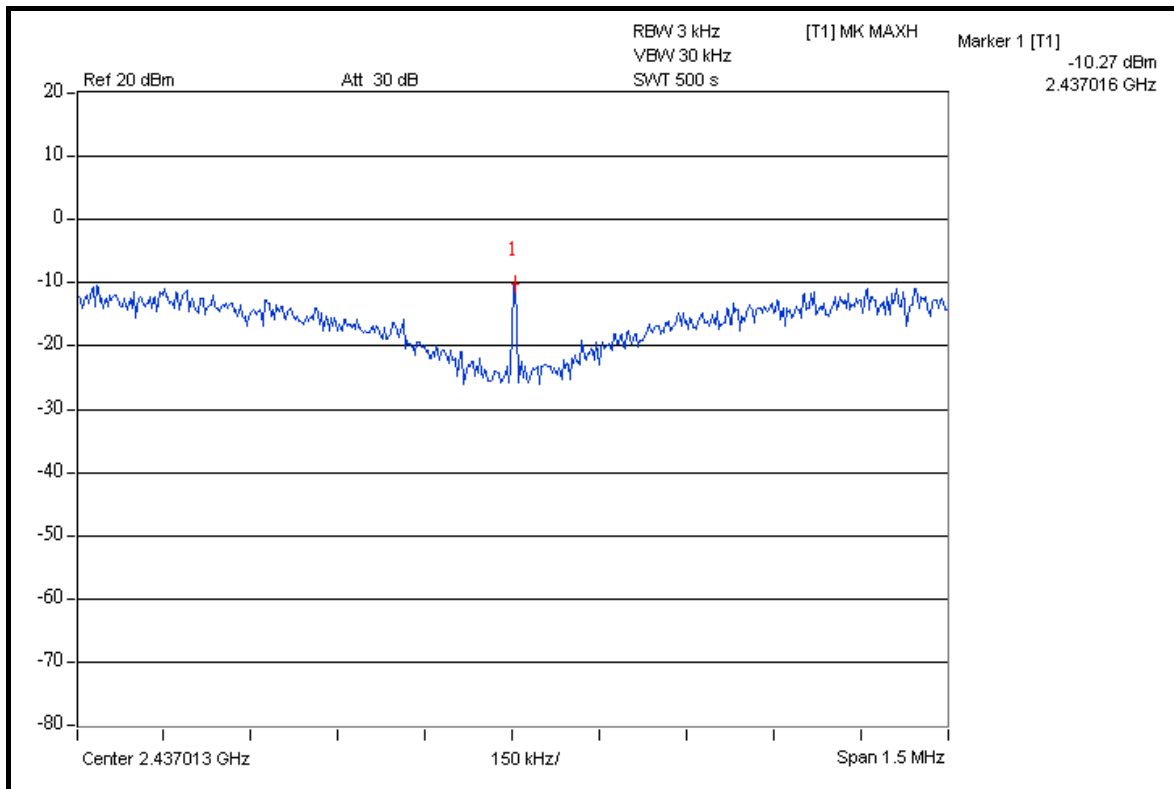

CH 11

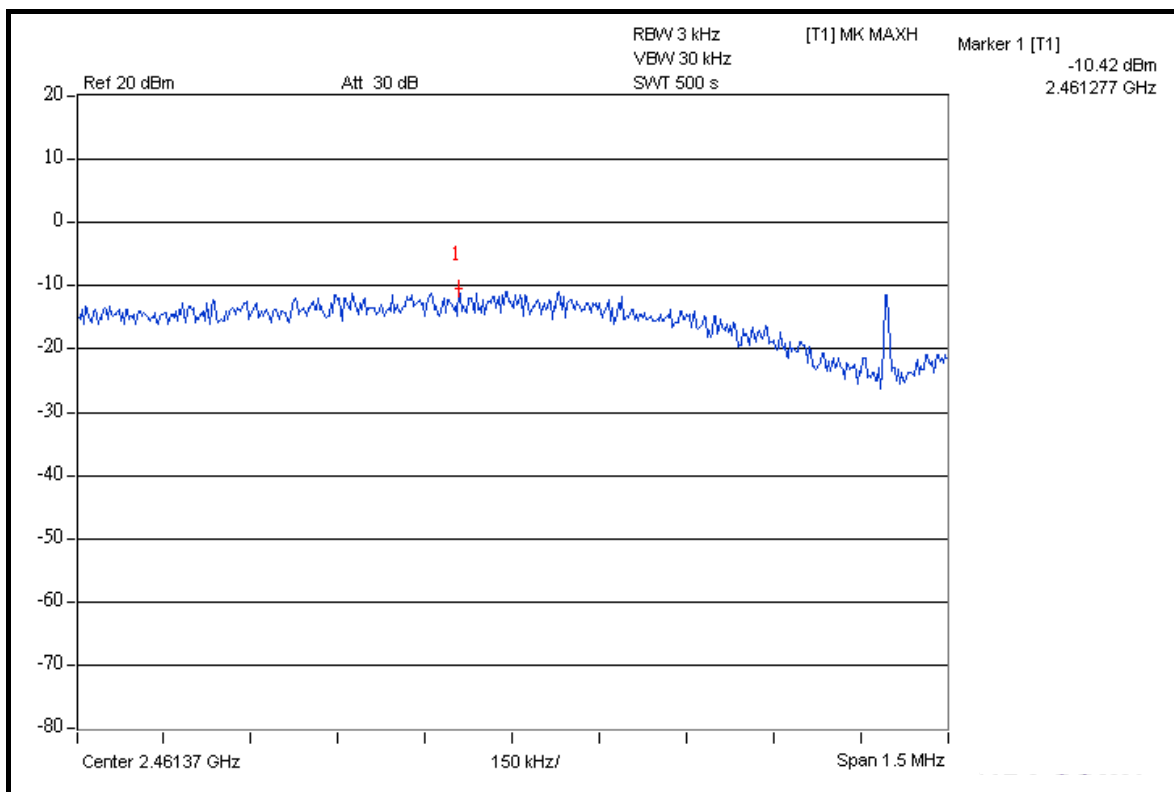



A D T

802.11g OFDM MODULATION

MODULATION TYPE	BPSK	TRANSFER RATE	6.0Mbps
INPUT POWER	120Vac, 60Hz	ENVIRONMENTAL CONDITIONS	24deg.C, 64%RH, 1021hPa
TESTED BY	Match Tsui		

CHAN.	CHAN. FREQ. (MHz)	RF POWER LEVEL IN 3kHz BW (dBm)		TOTAL POWER DENSITY (mW)	TOTAL POWER DENSITY (dBm)	MAX. LIMIT (dBm)	PASS / FAIL
		CHAIN 0	CHAIN 1				
1	2412	-11.21	-9.75	0.182	-7.41	8	PASS
6	2437	-11.04	-9.75	0.185	-7.34	8	PASS
11	2462	-11.38	-9.80	0.177	-7.51	8	PASS



A D T

FOR CHAIN 0: CH 1

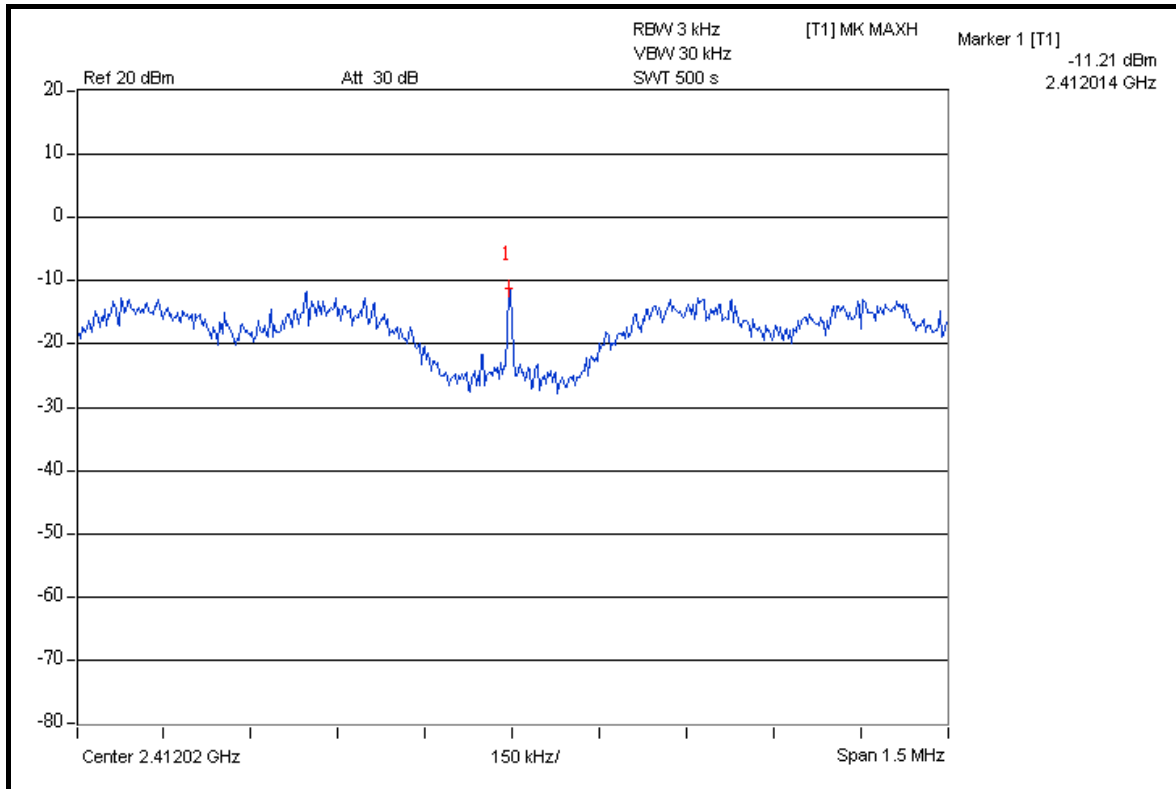

CH 6

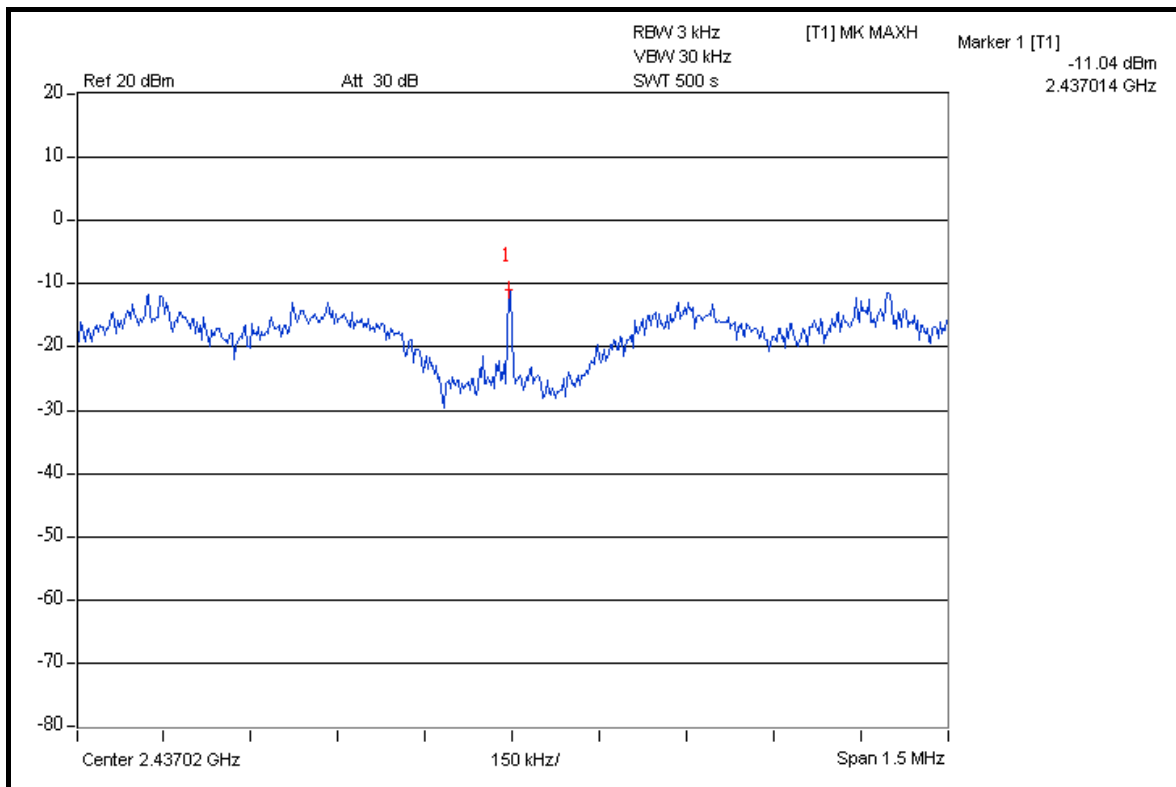



A D T

CH 11

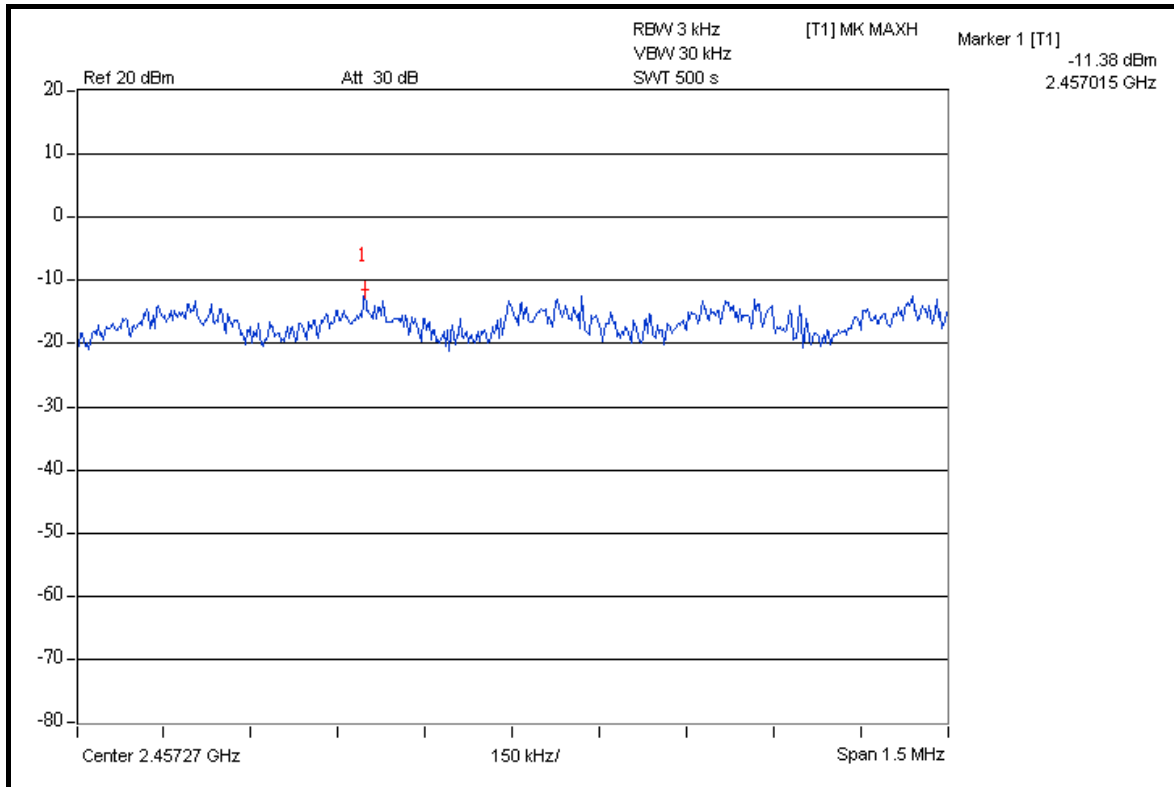

FOR CHAIN 1: CH 1

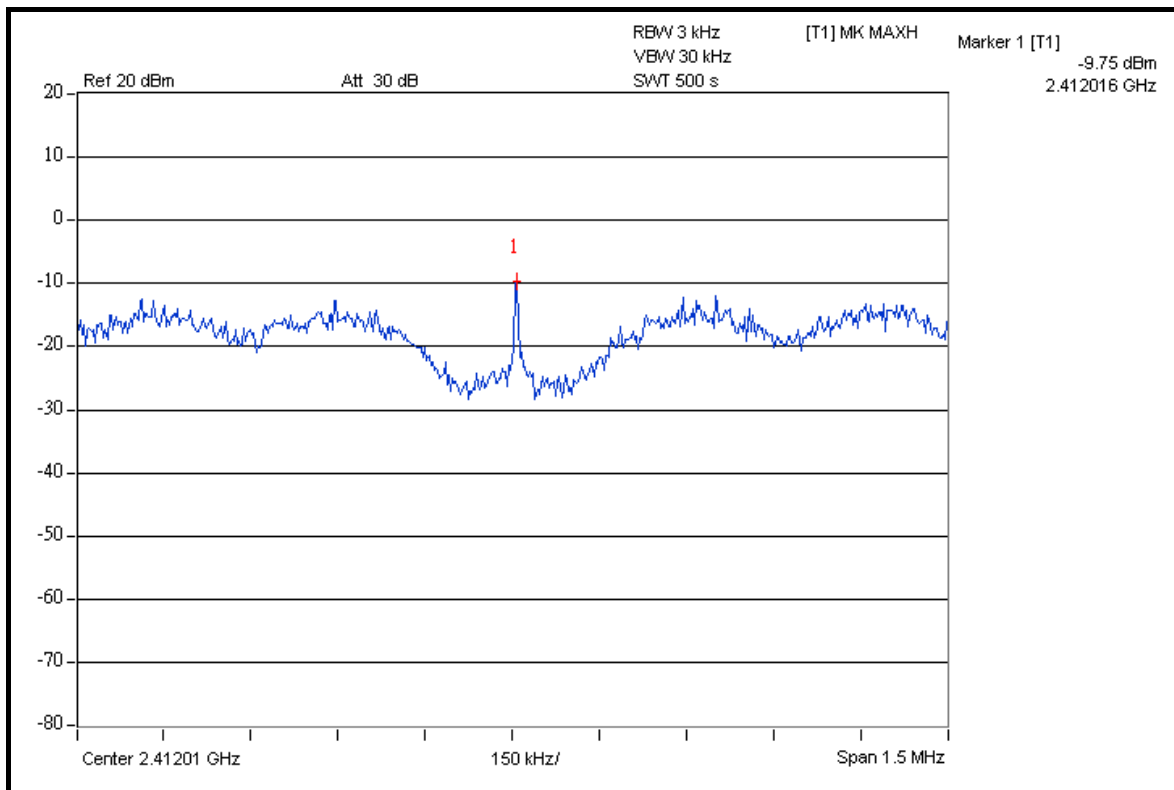



A D T

CH 6

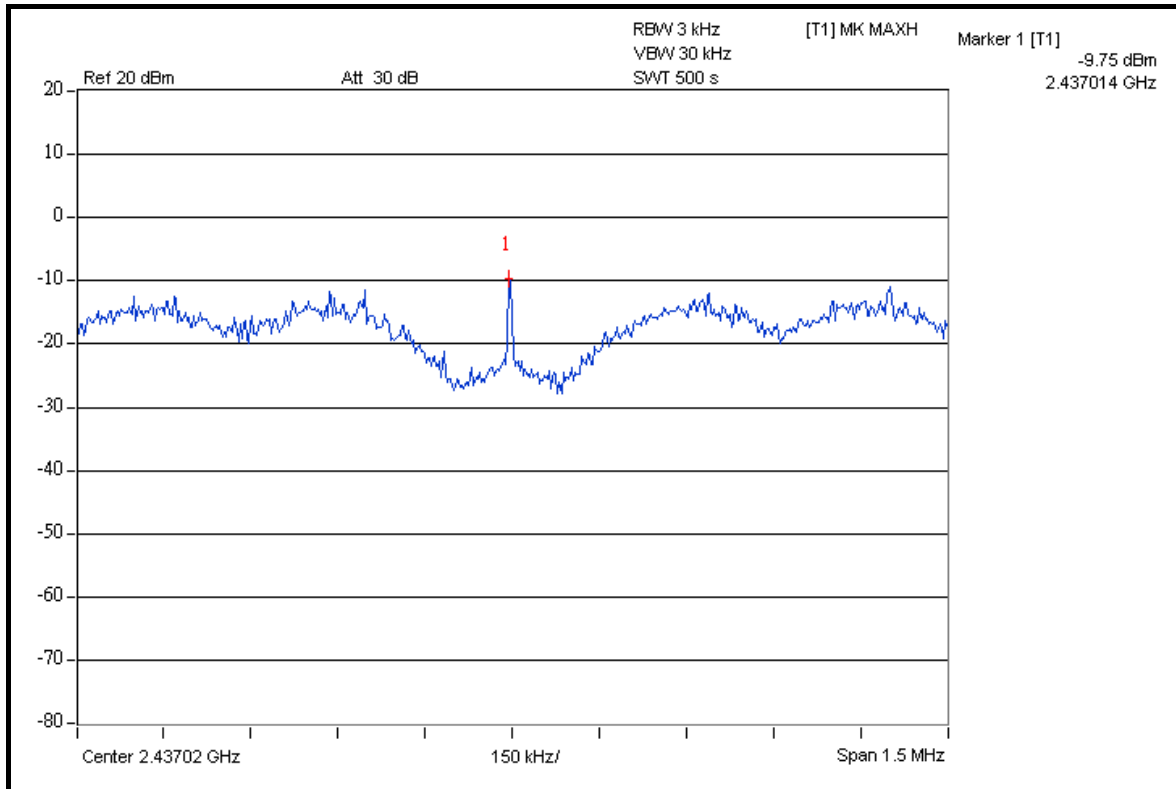

CH 11

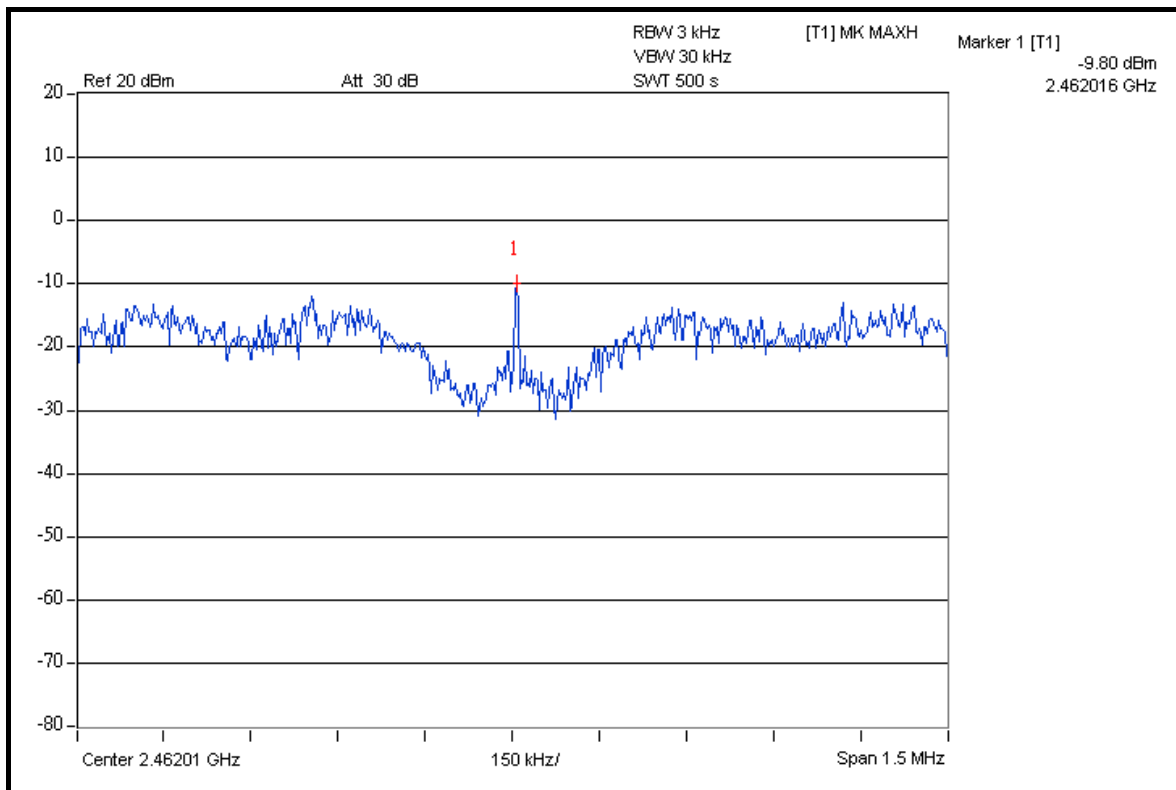



A D T

DRAFT 802.11n (20MHz) OFDM MODULATION

MODULATION TYPE	BPSK	TRANSFER RATE	7.2Mbps
INPUT POWER	120Vac, 60Hz	ENVIRONMENTAL CONDITIONS	25 deg.C, 65 %RH, 1021hPa
TESTED BY	Match Tsui		

CHAN.	CHAN. FREQ. (MHz)	RF POWER LEVEL IN 3kHz BW (dBm)		TOTAL POWER DENSITY (mW)	TOTAL POWER DENSITY (dBm)	MAX. LIMIT (dBm)	PASS / FAIL
		CHAIN 0	CHAIN 1				
1	2412	-11.33	-11.17	0.150	-8.24	8	PASS
6	2437	-11.14	-10.96	0.157	-8.04	8	PASS
11	2462	-11.39	-11.09	0.150	-8.23	8	PASS



A D T

FOR CHAIN 0: CH 1

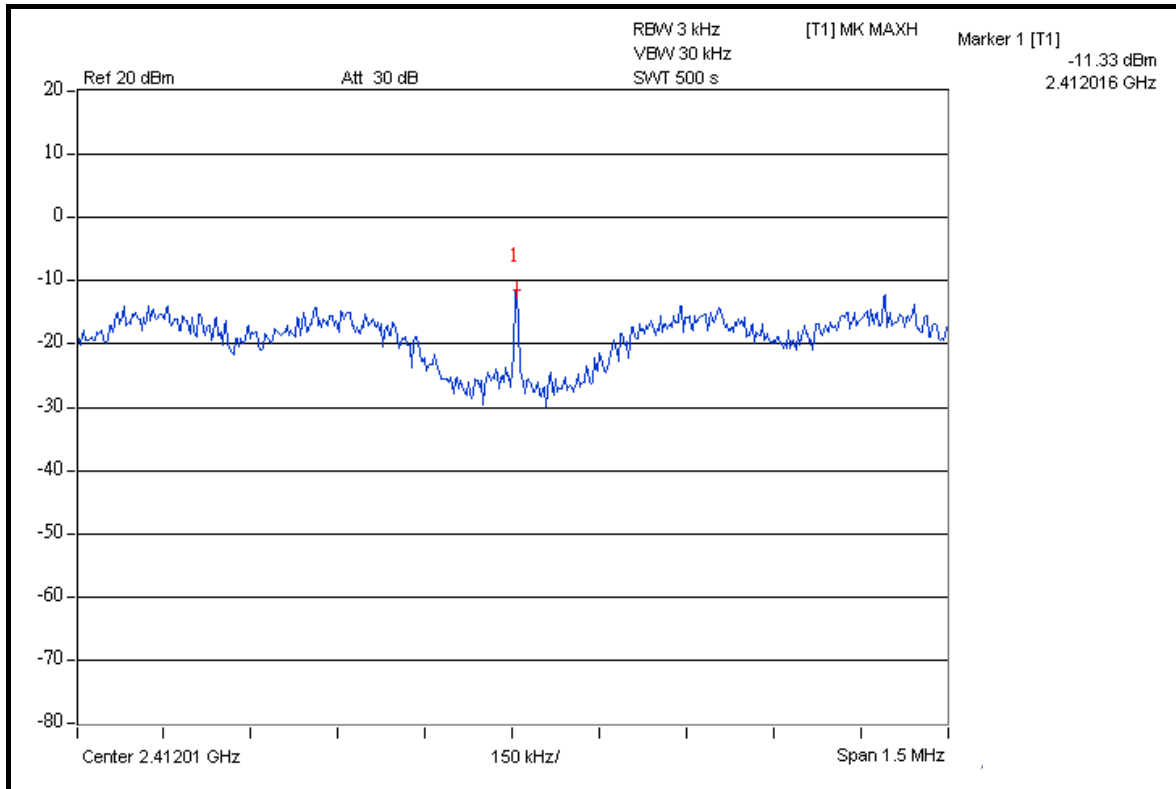

CH 6

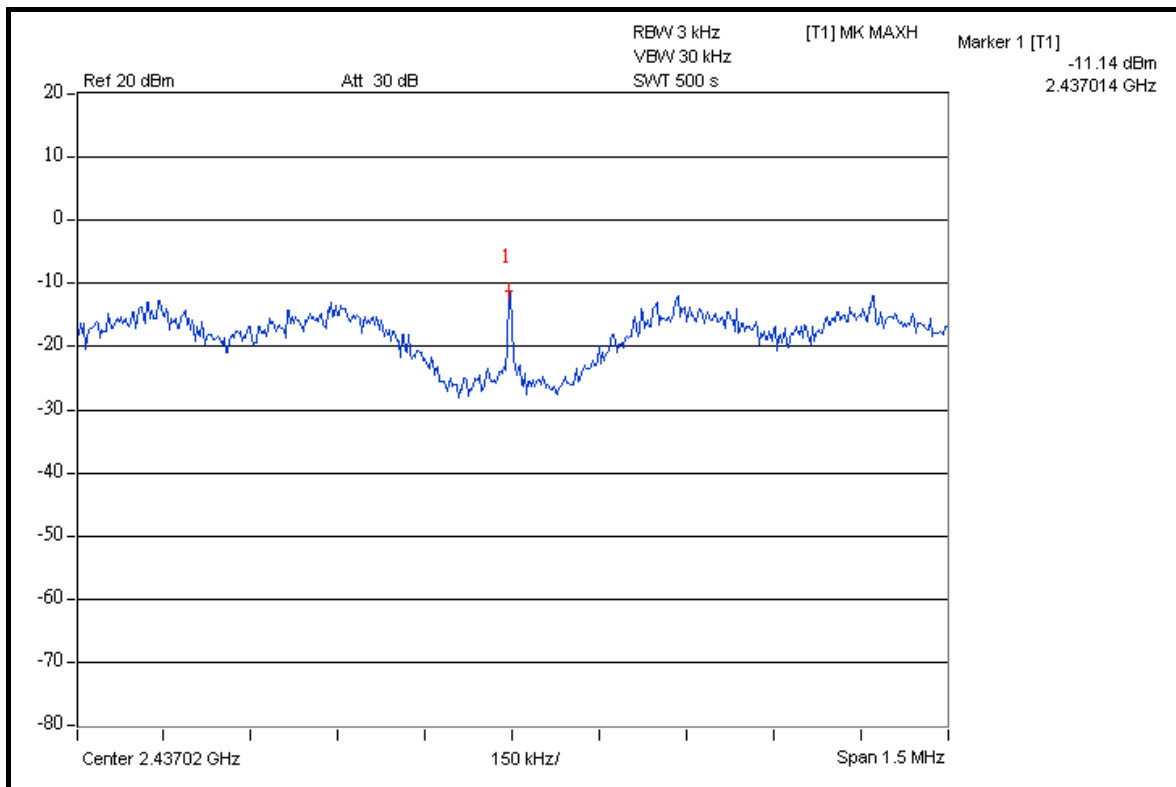



A D T

CH 11

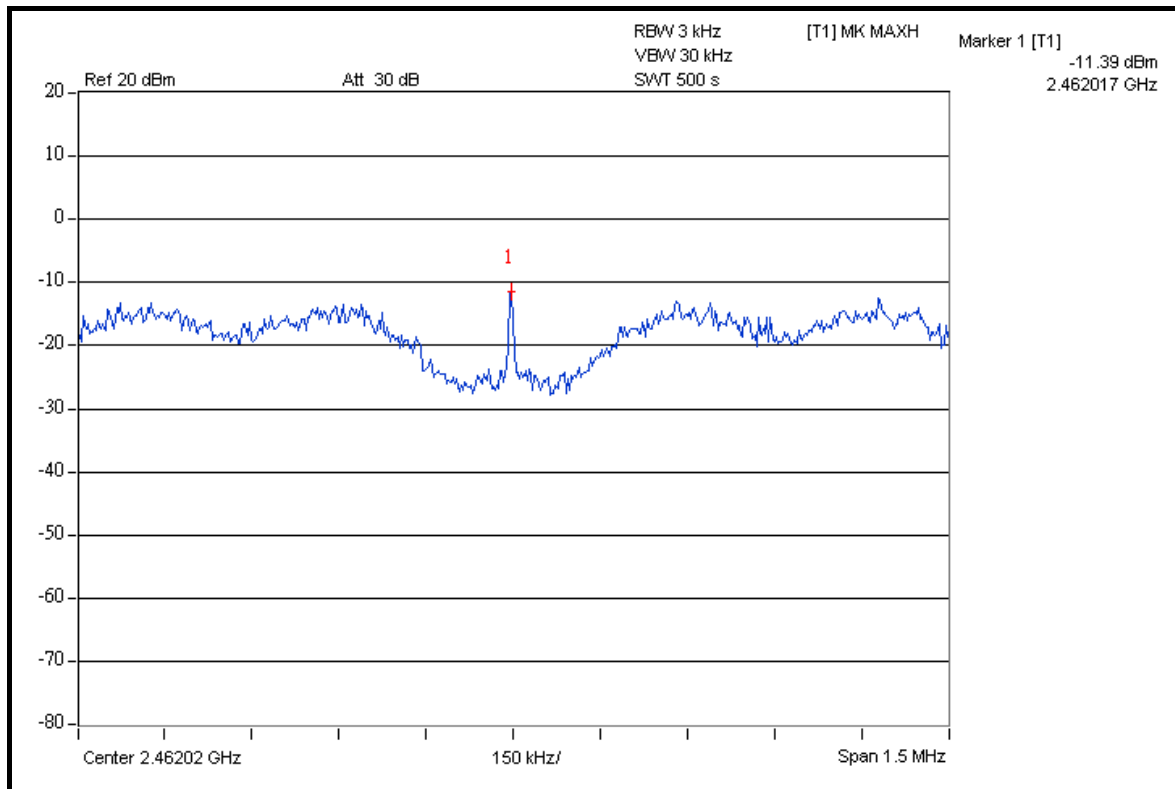

FOR CHAIN 1: CH 1

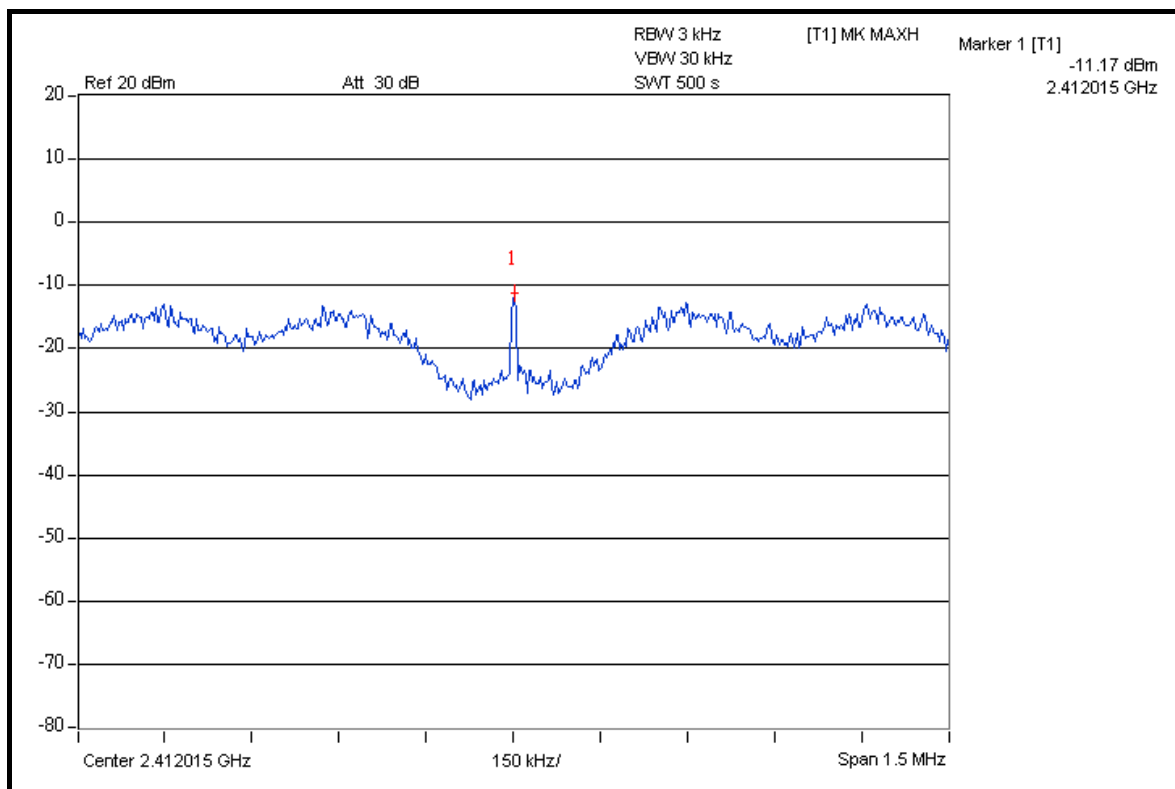



A D T

CH 6

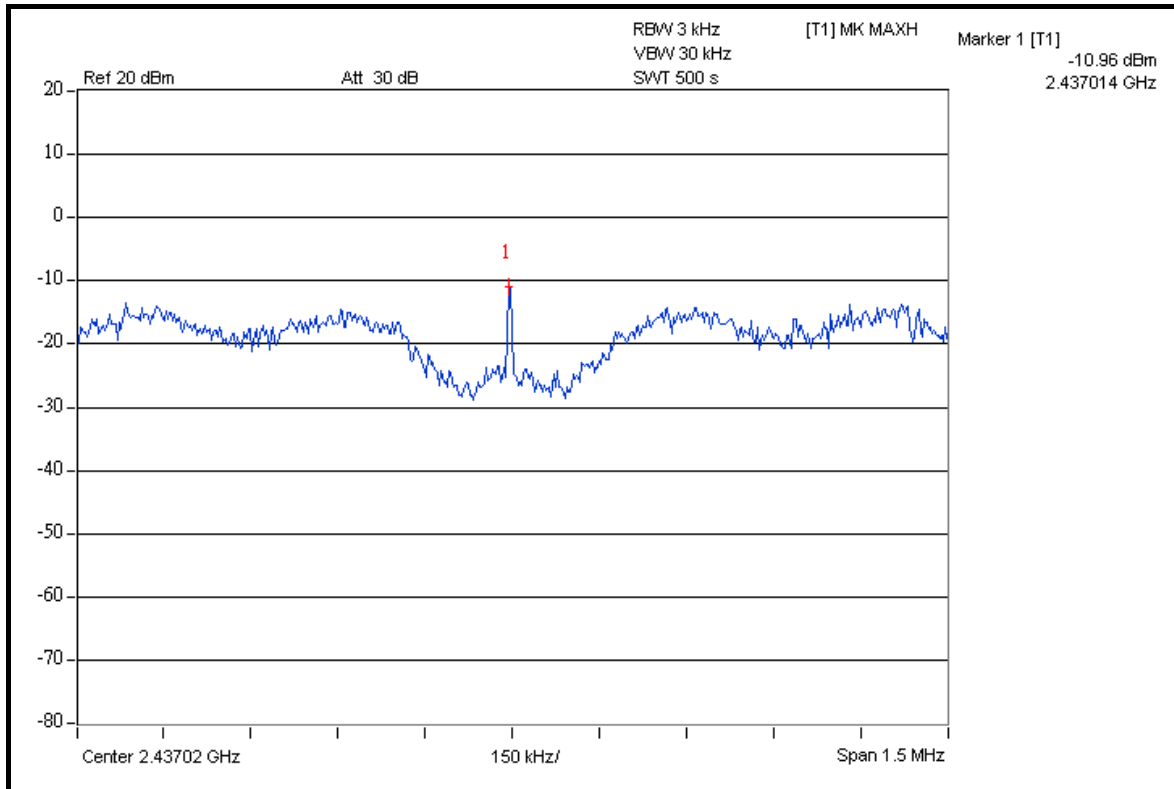

CH 11

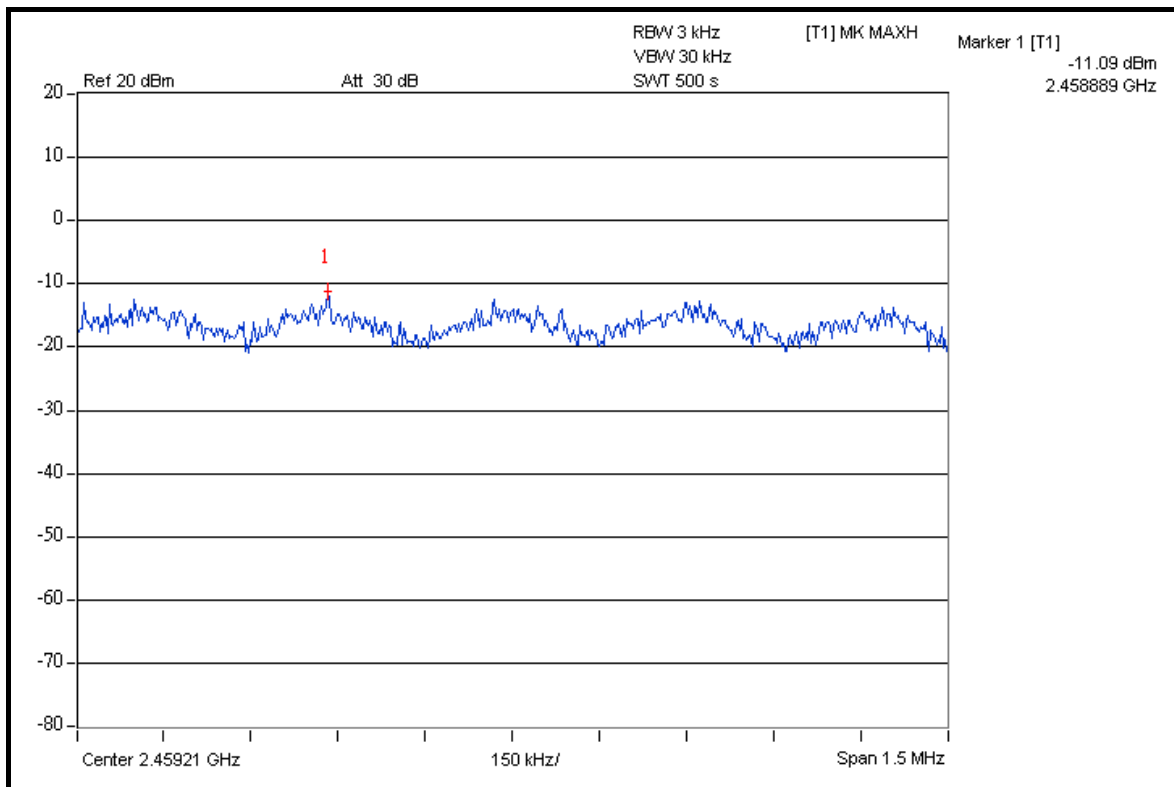



A D T

DRAFT 802.11n (40MHz) OFDM MODULATION

MODULATION TYPE	BPSK	TRANSFER RATE	15.0Mbps
INPUT POWER	120Vac, 60Hz	ENVIRONMENTAL CONDITIONS	25 deg.C, 65 %RH, 1021hPa
TESTED BY	Match Tsui		

CHAN.	CHAN. FREQ. (MHz)	RF POWER LEVEL IN 3kHz BW (dBm)		TOTAL POWER DENSITY (mW)	TOTAL POWER DENSITY (dBm)	MAX. LIMIT (dBm)	PASS / FAIL
		CHAIN 0	CHAIN 1				
1	2422	-8.10	-11.14	0.232	-6.35	8	PASS
4	2437	-7.99	-10.90	0.240	-6.20	8	PASS
7	2452	-7.89	-10.89	0.244	-6.13	8	PASS



A D T

FOR CHAIN 0: CH 1

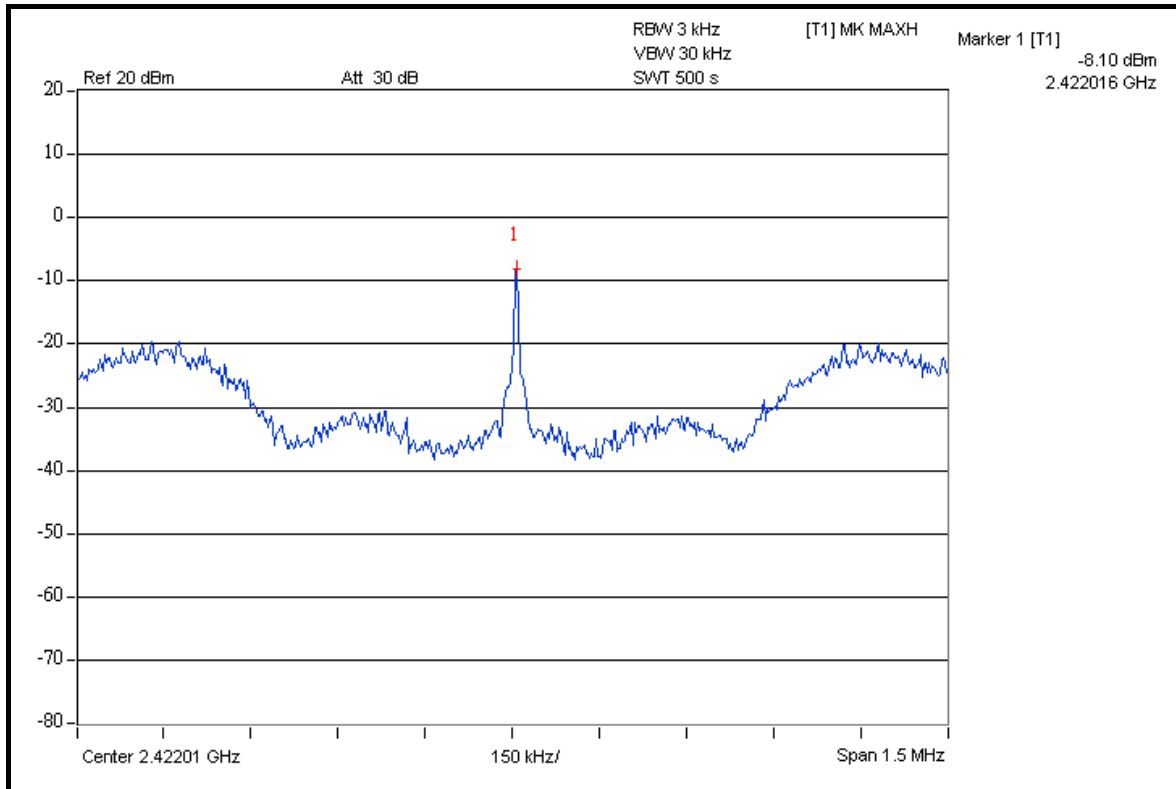

CH 4

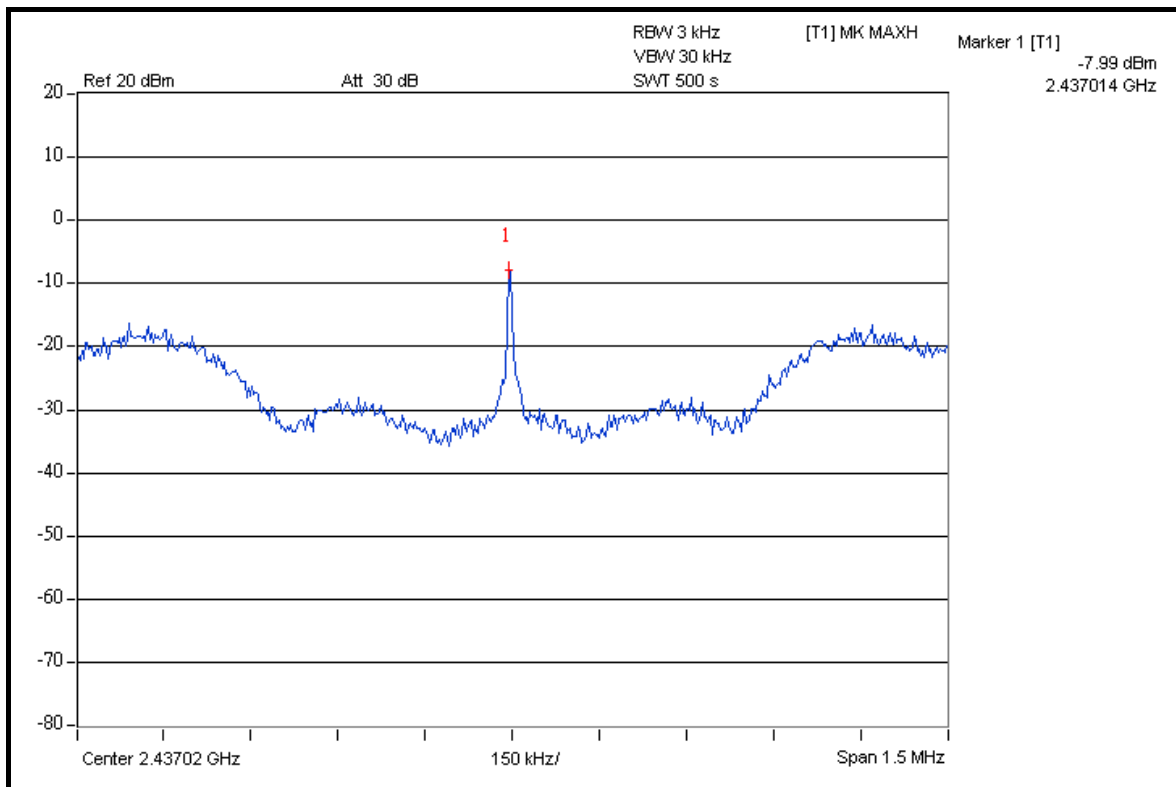



A D T

CH 7

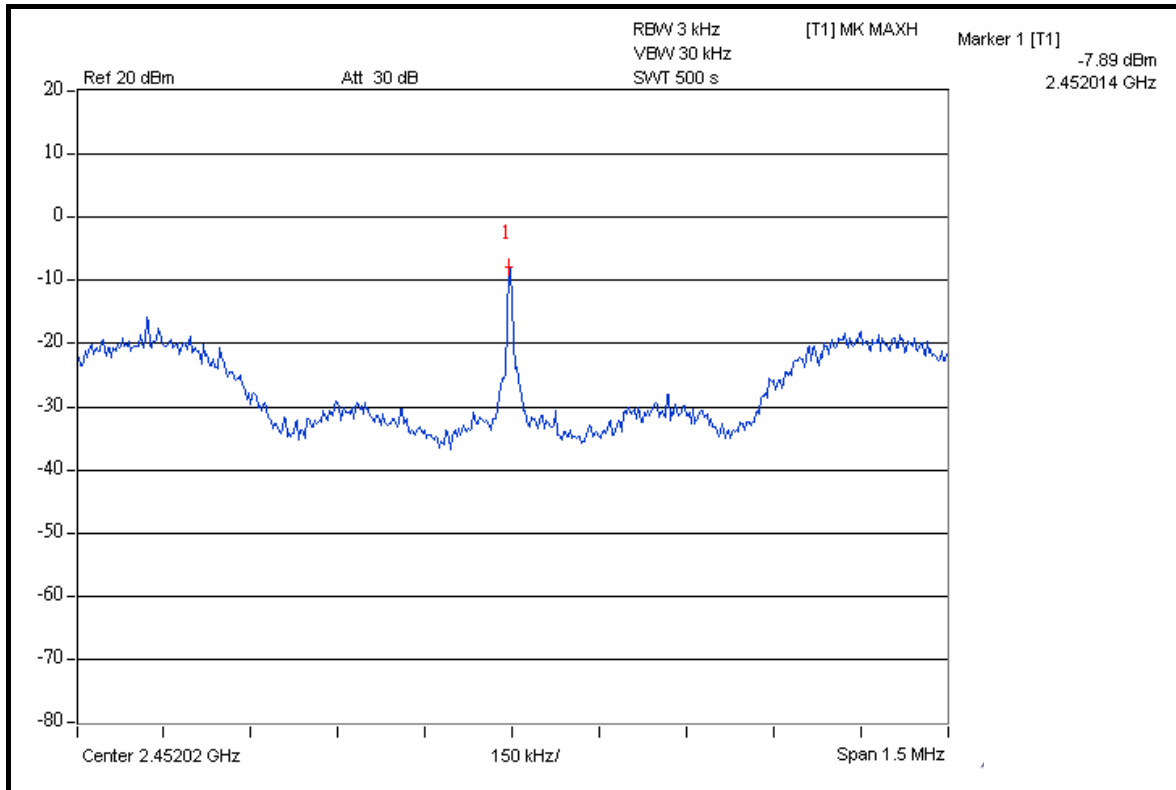

FOR CHAIN 1: CH 1

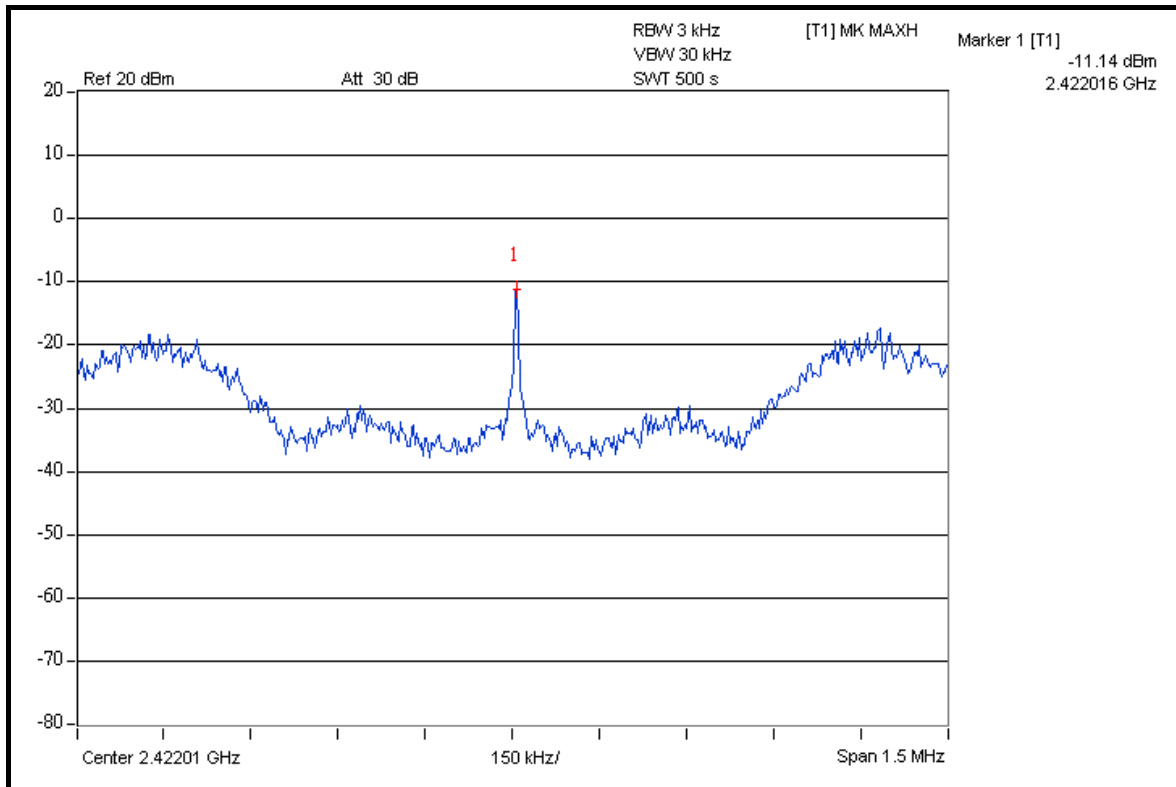



A D T

CH 4

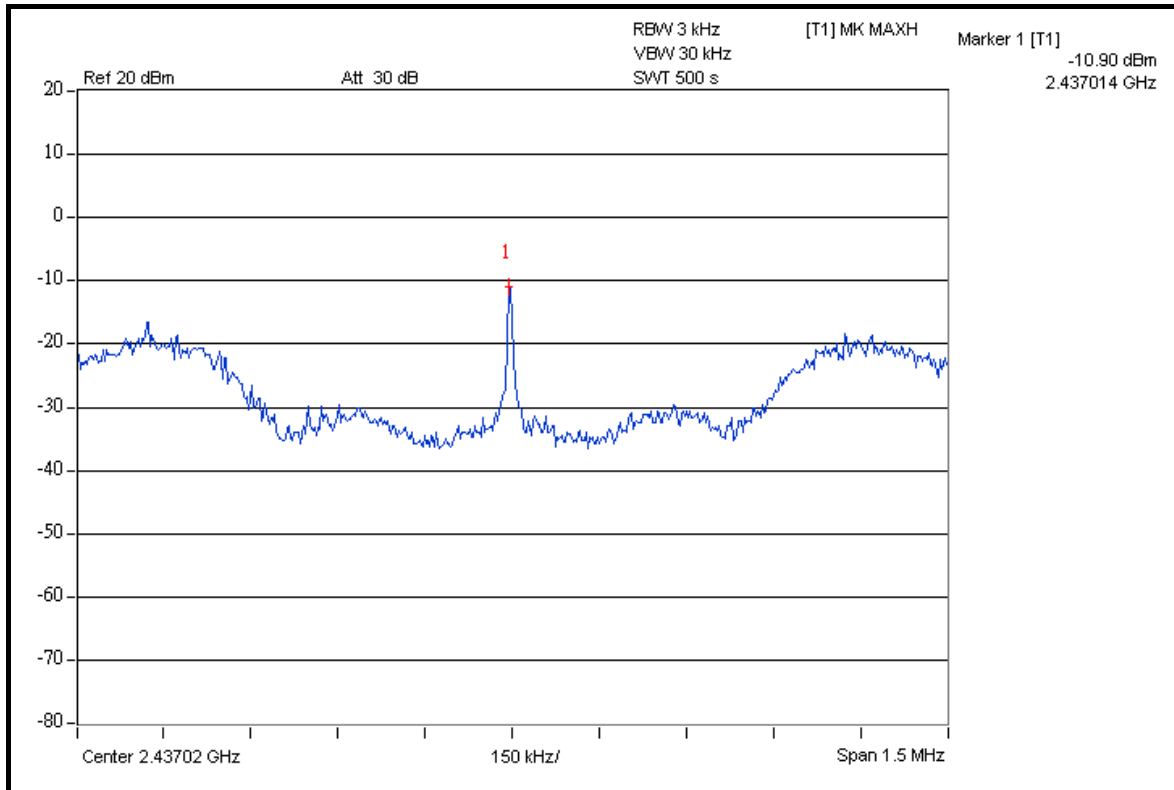

CH 7

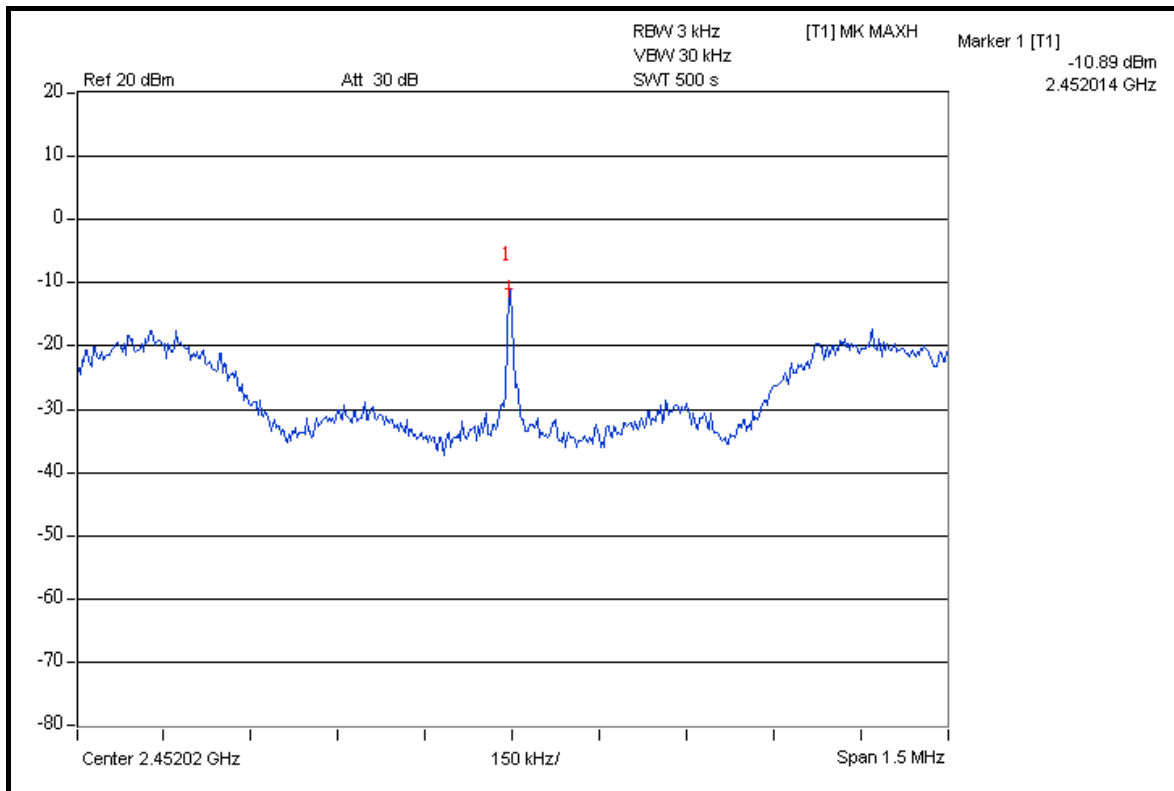

4.6 BAND EDGES MEASUREMENT

4.6.1 LIMITS OF BAND EDGES MEASUREMENT

Below -20dB of the highest emission level of operating band (in 100kHz Resolution Bandwidth).

4.6.2 TEST INSTRUMENTS

DESCRIPTION & MANUFACTURER	MODEL NO.	SERIAL NO.	DATE OF CALIBRATION	DUE DATE OF CALIBRATION
Test Receiver ROHDE & SCHWARZ	ESI7	100033	Jun. 30, 2008	Jun. 29, 2009
Spectrum Analyzer ROHDE & SCHWARZ	FSP40	100041	Apr. 22, 2008	Apr. 21, 2009
BILOG Antenna SCHWARZBECK	VULB9168	9168-160	May 02, 2008	May 01, 2009
HORN Antenna SCHWARZBECK	9120D	9120D-209	Jun. 24, 2008	Jun. 23, 2009
HORN Antenna SCHWARZBECK	BBHA 9170	BBHA9170243	Dec. 25, 2007	Dec. 24, 2008
Preamplifier Agilent	8447D	2944A10633	Nov. 03, 2008	Nov. 02, 2009
Preamplifier Agilent	8449B	3008A01964	Oct. 23, 2008	Oct. 22, 2009
RF signal cable HUBER+SUHNNER	SUCOFLEX 104	238141/4	May 20, 2008	May 19, 2009
RF signal cable HUBER+SUHNNER	SUCOFLEX 104	12738/6	May 20, 2008	May 19, 2009
Software ADT.	ADT_Radiated_V7.6	NA	NA	NA
Antenna Tower inn-co GmbH	MA 4000	013303	NA	NA
Antenna Tower Controller inn-co GmbH	CO2000	017303	NA	NA
Turn Table ADT.	TT100.	TT93021703	NA	NA
Turn Table Controller ADT.	SC100.	SC93021703	NA	NA

- NOTE:**
1. The calibration interval of the above test instruments is 12 months and the calibrations are traceable to NML/ROC and NIST/USA.
 2. The test was performed in HwaYa Chamber 3.
 3. The horn antenna and HP preamplifier (model: 8449B) are used only for the measurement of emission frequency above 1GHz if tested.
 4. The FCC Site Registration No. is 988962.
 5. The IC Site Registration No. is IC3789B-3.



4.6.3 TEST PROCEDURE

- a. The EUT was placed on the top of a rotating table 0.8 meters above the ground at a 3 meter semi-anechoic chamber. The table was rotated 360 degrees to determine the position of the highest radiation.
- b. The EUT was set 3 meters away from the interference-receiving antenna, which was mounted on the top of a variable-height antenna tower.
- c. The antenna is a broadband antenna, and its height is varied from one meter to four meters above the ground to determine the maximum value of the field strength. Both horizontal and vertical polarizations of the antenna are set to make the measurement.
- d. For each suspected emission, the EUT was arranged to its worst case and then the antenna was tuned to heights from 1 meter to 4 meters and the rotatable table was turned from 0 degrees to 360 degrees to find the maximum reading.
- e. Set both RBW and VBW of spectrum analyzer to 100kHz and 300kHz with suitable frequency span including 100MHz bandwidth from band edge. The band edges was measured and recorded.

The spectrum plots (Peak RBW = 100kHz, VBW = 300kHz) are attached on the following pages.

NOTE: The resolution bandwidth of test receiver/spectrum analyzer is 1MHz and the video bandwidth is 10Hz for Average detection (AV) at frequency above 1GHz.



A D T

4.6.4 DEVIATION FROM TEST STANDARD

No deviation.

4.6.5 EUT OPERATING CONDITION

Same as Item 4.3.6.

4.6.6 TEST RESULTS

The spectrum plots are attached on the following pages. D1 line indicates the highest level, and D2 line indicates the 20dB offset below D1. It shows compliance with the requirement in part 15.247(d).

802.11b DSSS MODULATION

NOTE 1: The band edge emission plot on the next page shows 47.29dBc between carrier maximum power and local maximum emission in restrict band (2.3500GHz). The emission of carrier strength list in the test result of channel 1 at the item 4.1.7 is 104.84dBuV/m (Peak), so the maximum field strength in restrict band is $104.84 - 47.29 = 57.55$ dBuV/m which is under 74dBuV/m limit.

The band edge emission plot of on the next page shows 54.71dBc between carrier maximum power and local maximum emission in restrict band (2.3502GHz). The emission of carrier strength list in the test result of channel 1 at the item 4.1.7 is 100.26dBuV/m (Average), so the maximum field strength in restrict band is $100.26 - 54.71 = 45.55$ dBuV/m which is under 54dBuV/m limit.

NOTE 2: The band edge emission plot on the next second page shows 47.55dBc between carrier maximum power and local maximum emission in restrict band (2.5000GHz). The emission of carrier strength list in the test result of channel 11 at the item 4.1.7 is 104.67dBuV/m (Peak), so the maximum field strength in restrict band is $104.67 - 47.55 = 57.12$ dBuV/m which is under 74dBuV/m limit.

The band edge emission plot on the next third page shows 57.98dBc between carrier maximum power and local maximum emission in restrict band (2.5000GHz). The emission of carrier strength list in the test result of channel 11 at the item 4.1.7 is 99.34dBuV/m (Average), so the maximum field strength in restrict band is $99.34 - 57.98 = 41.36$ dBuV/m which is under 54dBuV/m limit.



A D T

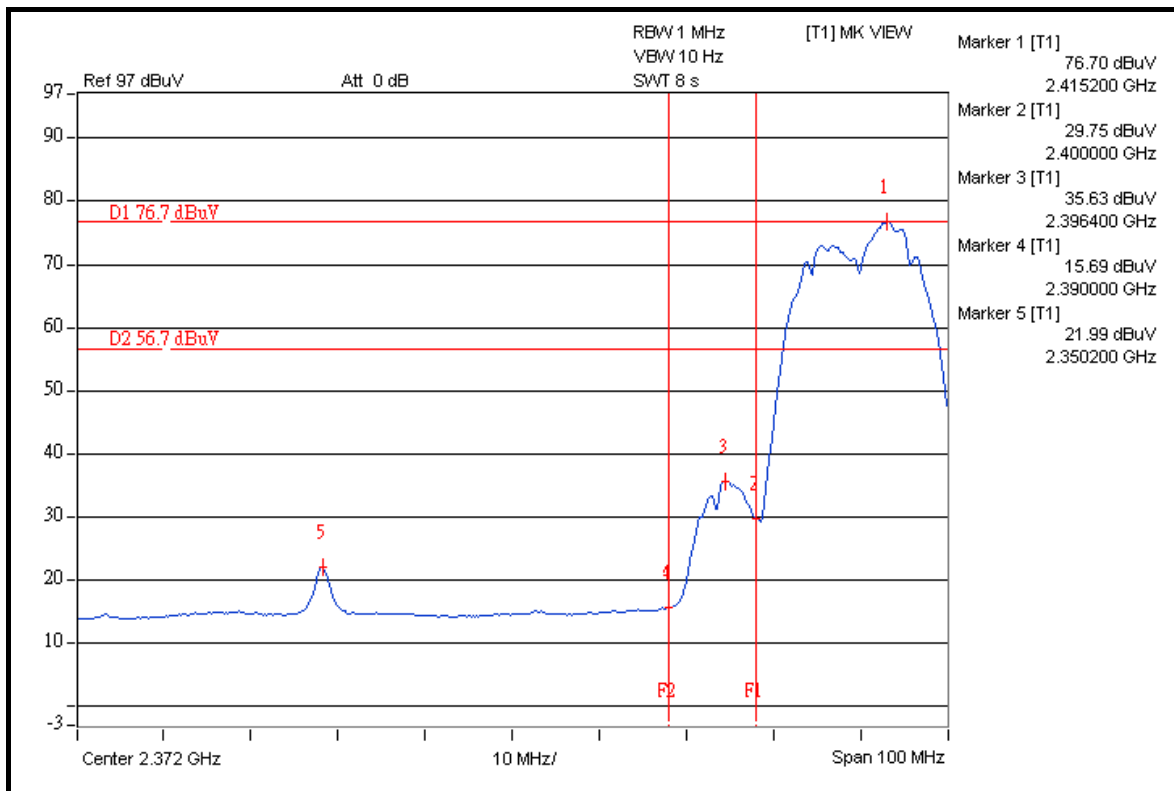
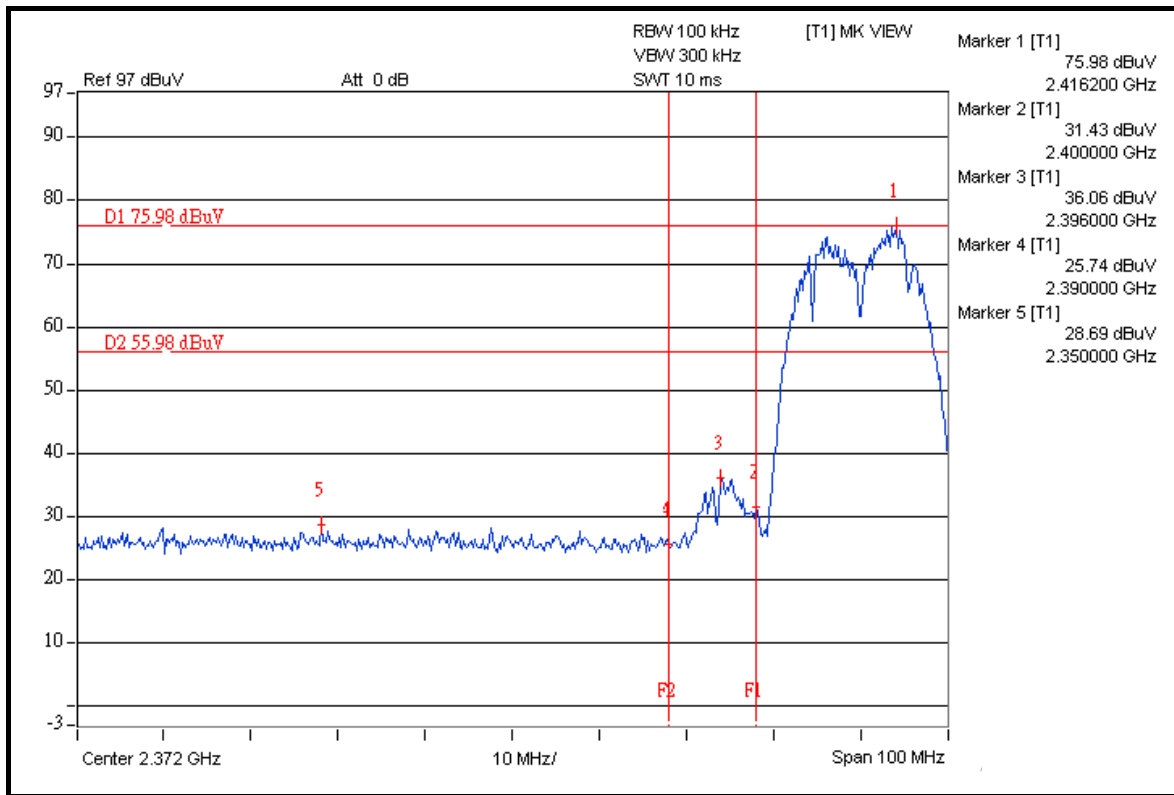



A D T

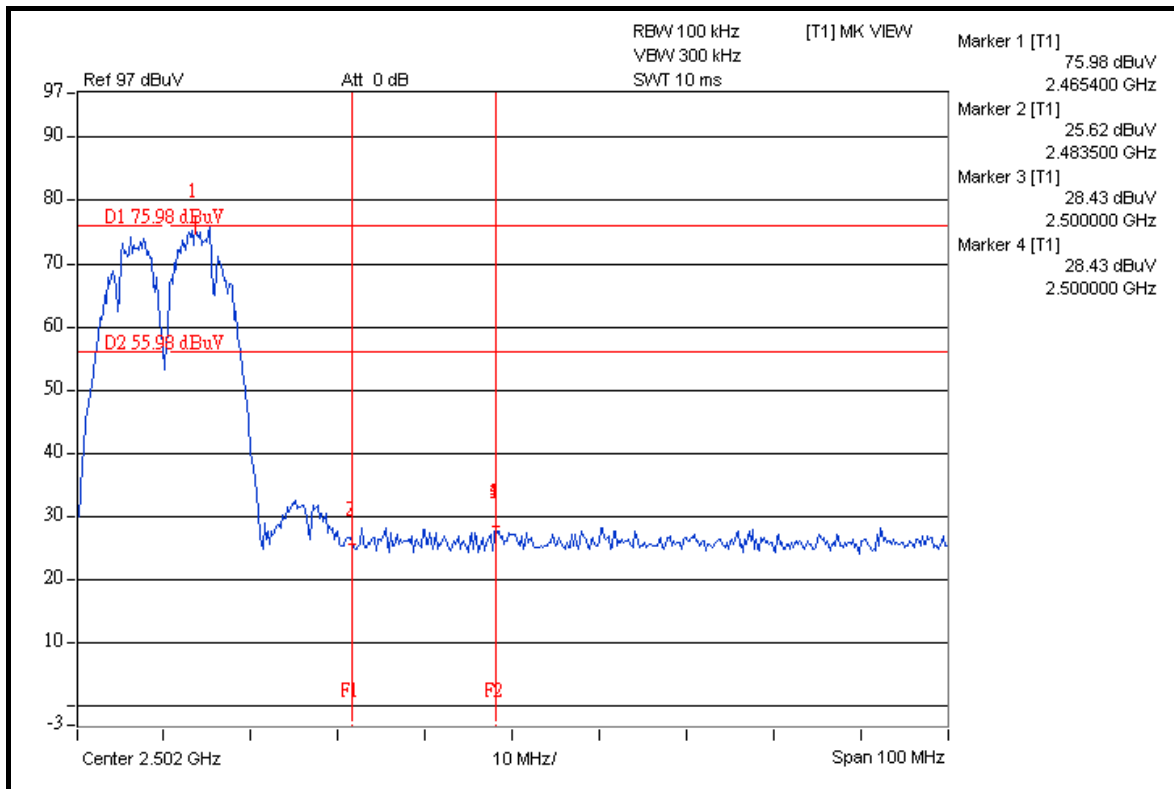
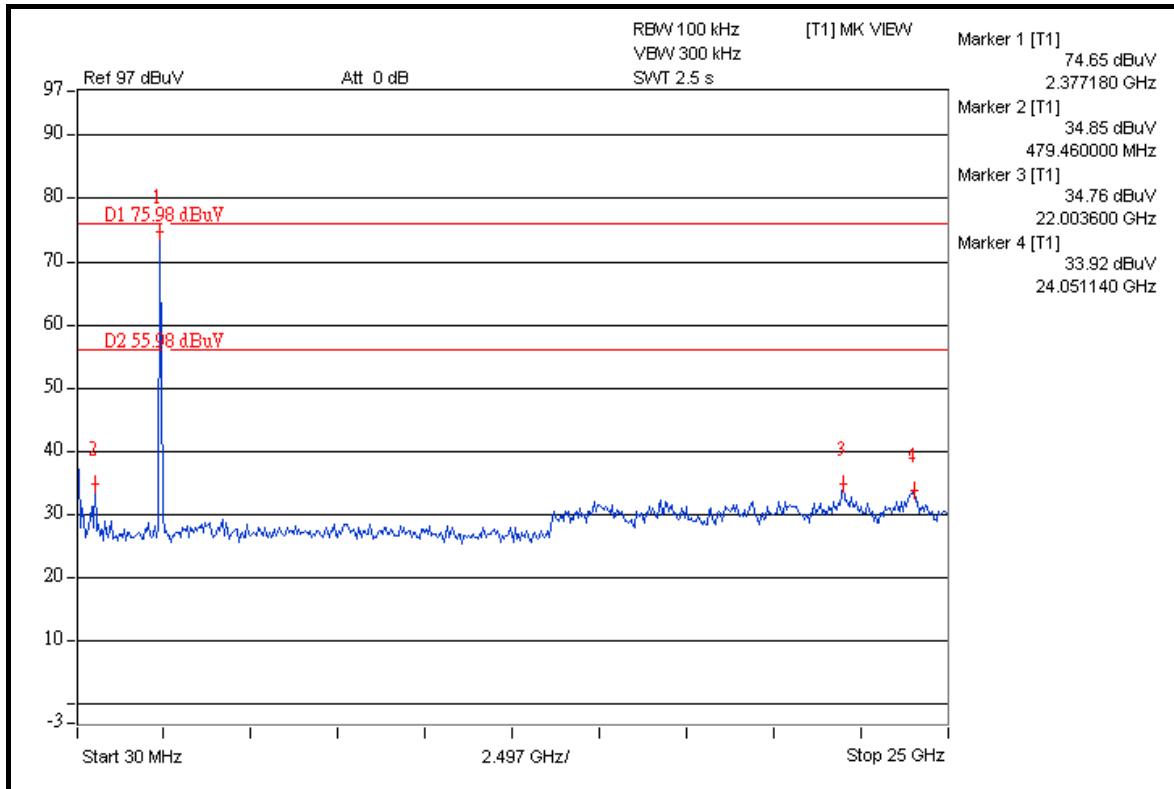



A D T

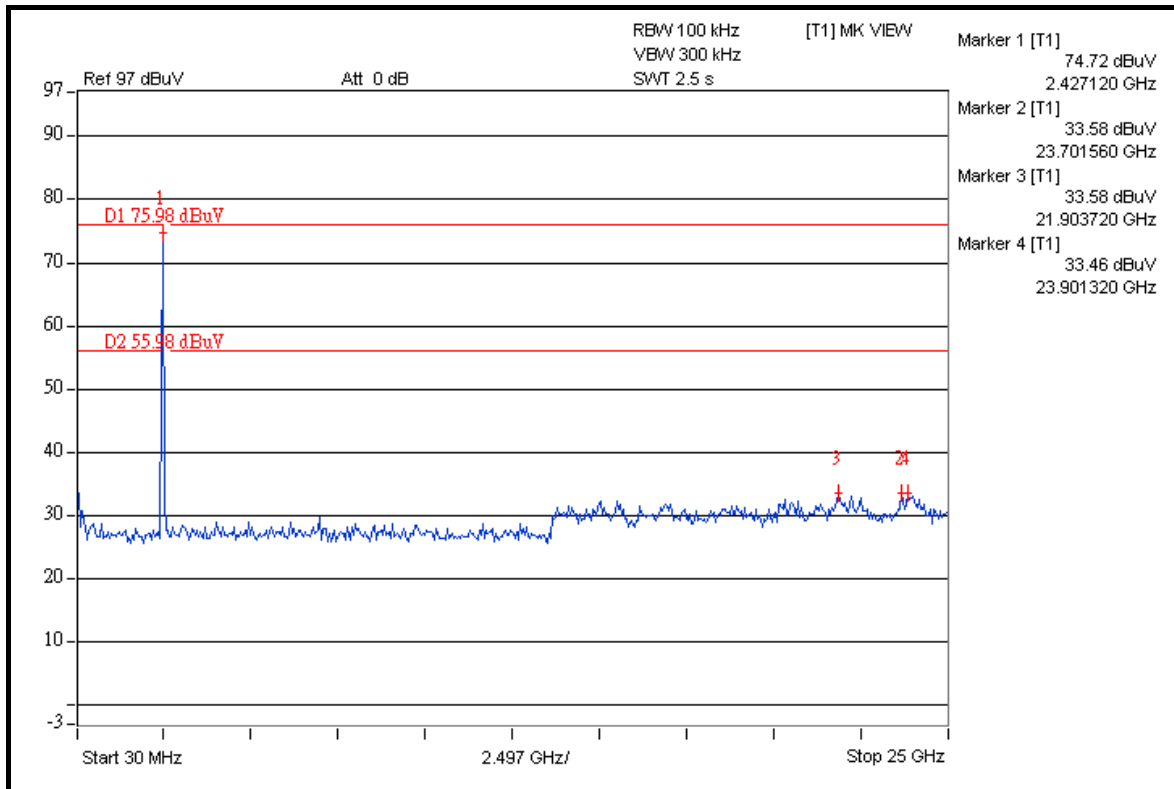
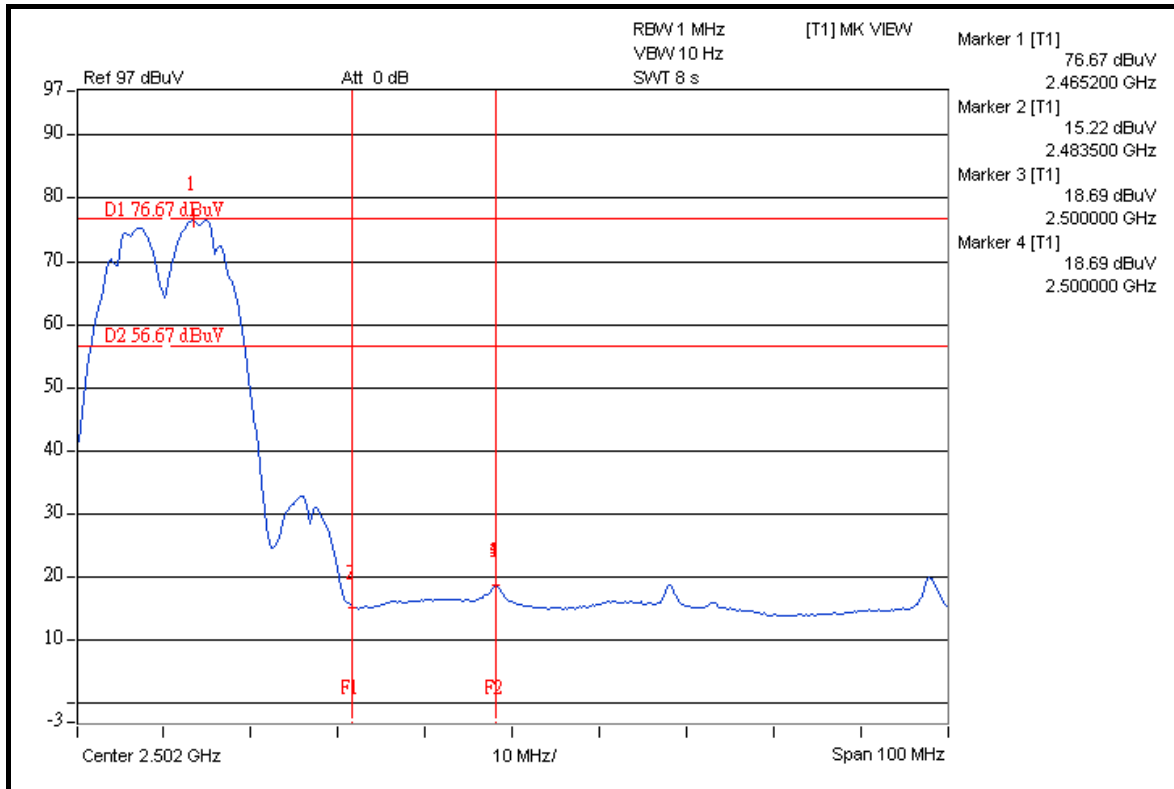



A D T

802.11g OFDM MODULATION

NOTE 1: The band edge emission plot on the next page shows 43.23dBc between carrier maximum power and local maximum emission in restrict band (2.3322GHz). The emission of carrier strength list in the test result of channel 1 at the item 4.1.7 is 108.11dBuV/m (Peak), so the maximum field strength in restrict band is $108.11 - 43.23 = 64.88$ dBuV/m which is under 74dBuV/m limit.

The band edge emission plot of on the next page shows 53.14dBc between carrier maximum power and local maximum emission in restrict band (2.3900GHz). The emission of carrier strength list in the test result of channel 1 at the item 4.1.7 is 96.11dBuV/m (Average), so the maximum field strength in restrict band is $96.11 - 53.14 = 42.97$ dBuV/m which is under 54dBuV/m limit.

NOTE 2: The band edge emission plot on the next second page shows 41.42dBc between carrier maximum power and local maximum emission in restrict band (2.5000GHz). The emission of carrier strength list in the test result of channel 11 at the item 4.1.7 is 107.56dBuV/m (Peak), so the maximum field strength in restrict band is $107.56 - 41.42 = 66.14$ dBuV/m which is under 74dBuV/m limit.

The band edge emission plot on the next third page shows 49.82dBc between carrier maximum power and local maximum emission in restrict band (2.5000GHz). The emission of carrier strength list in the test result of channel 11 at the item 4.1.7 is 96.47dBuV/m (Average), so the maximum field strength in restrict band is $96.47 - 49.82 = 46.65$ dBuV/m which is under 54dBuV/m limit.



A D T

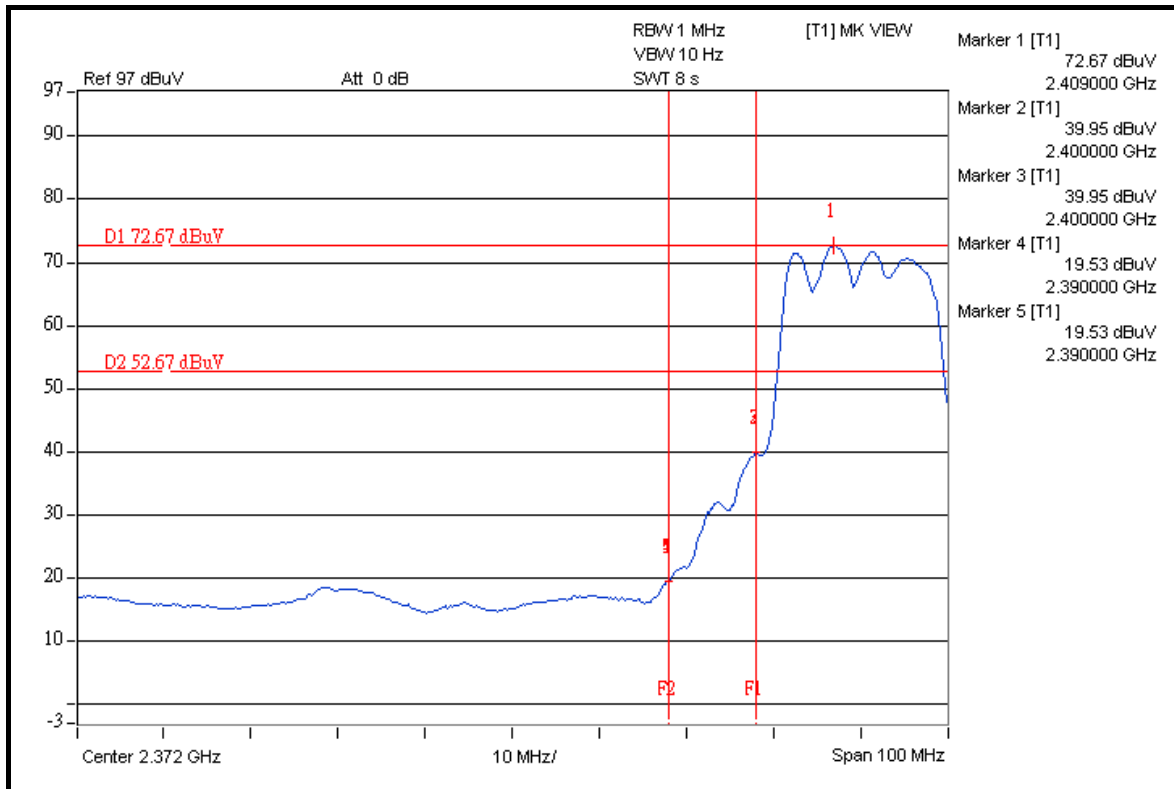
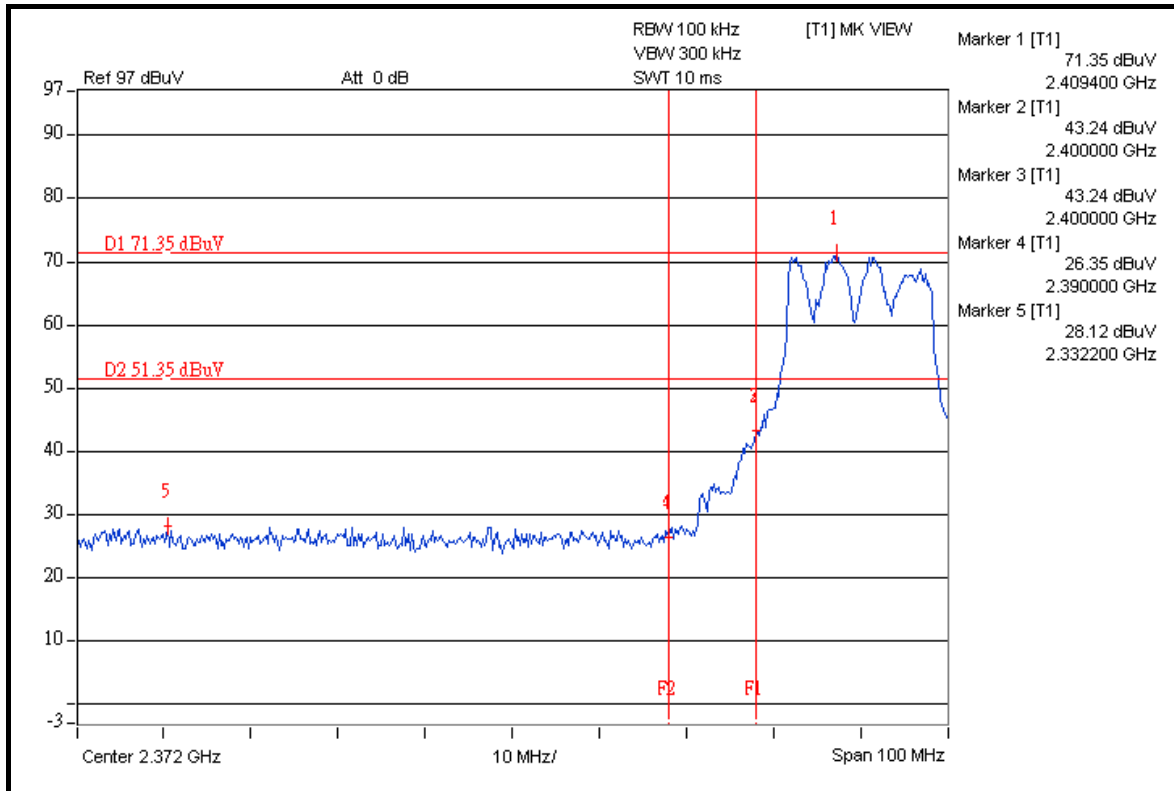



A D T

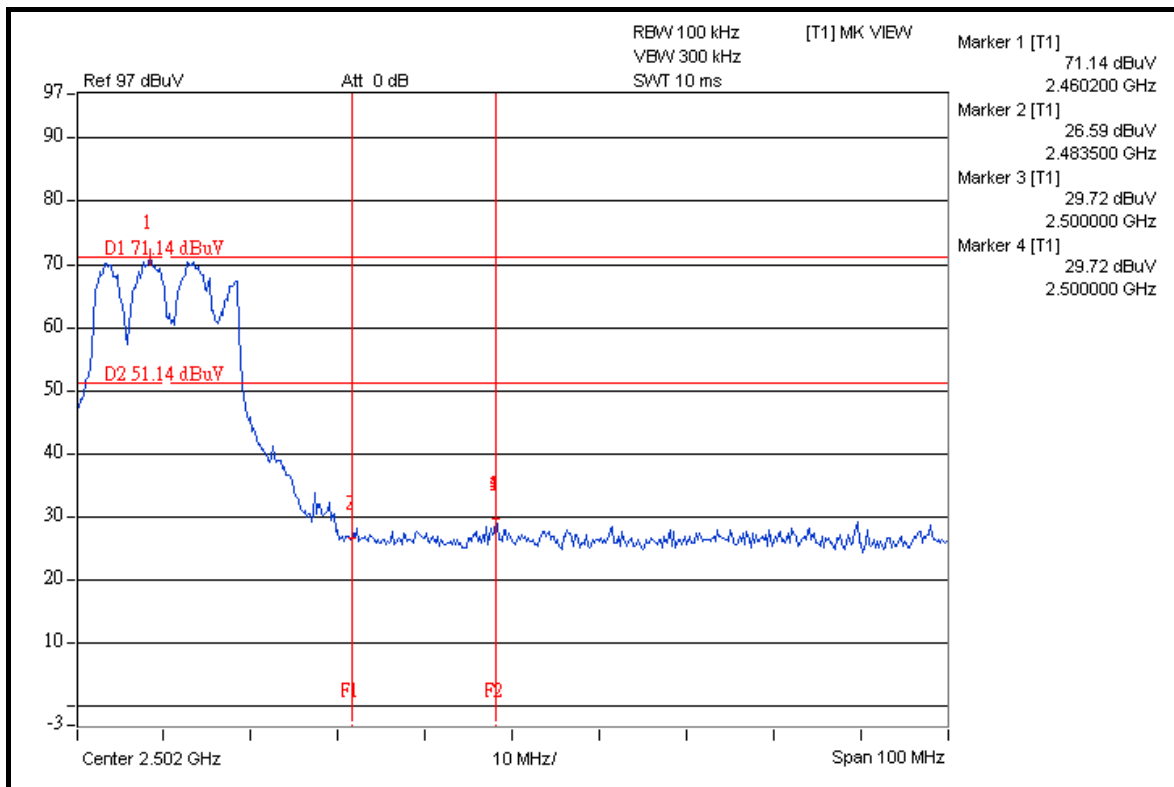
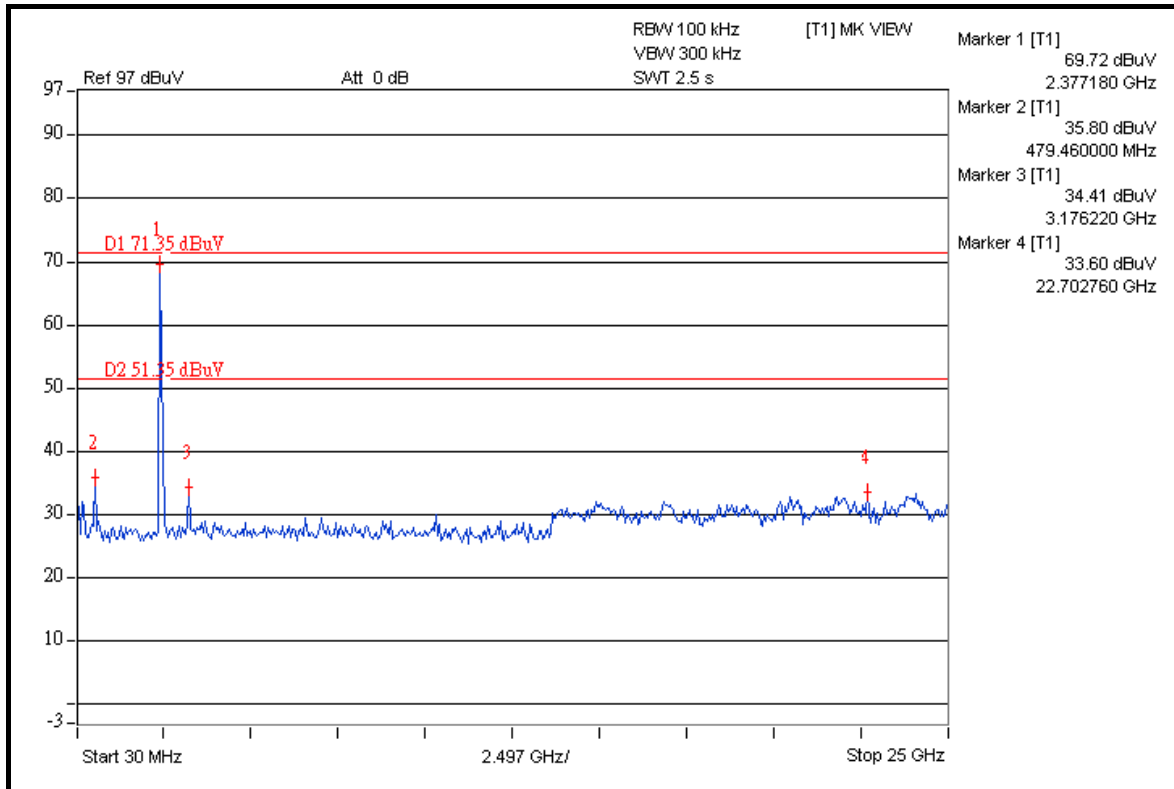



A D T

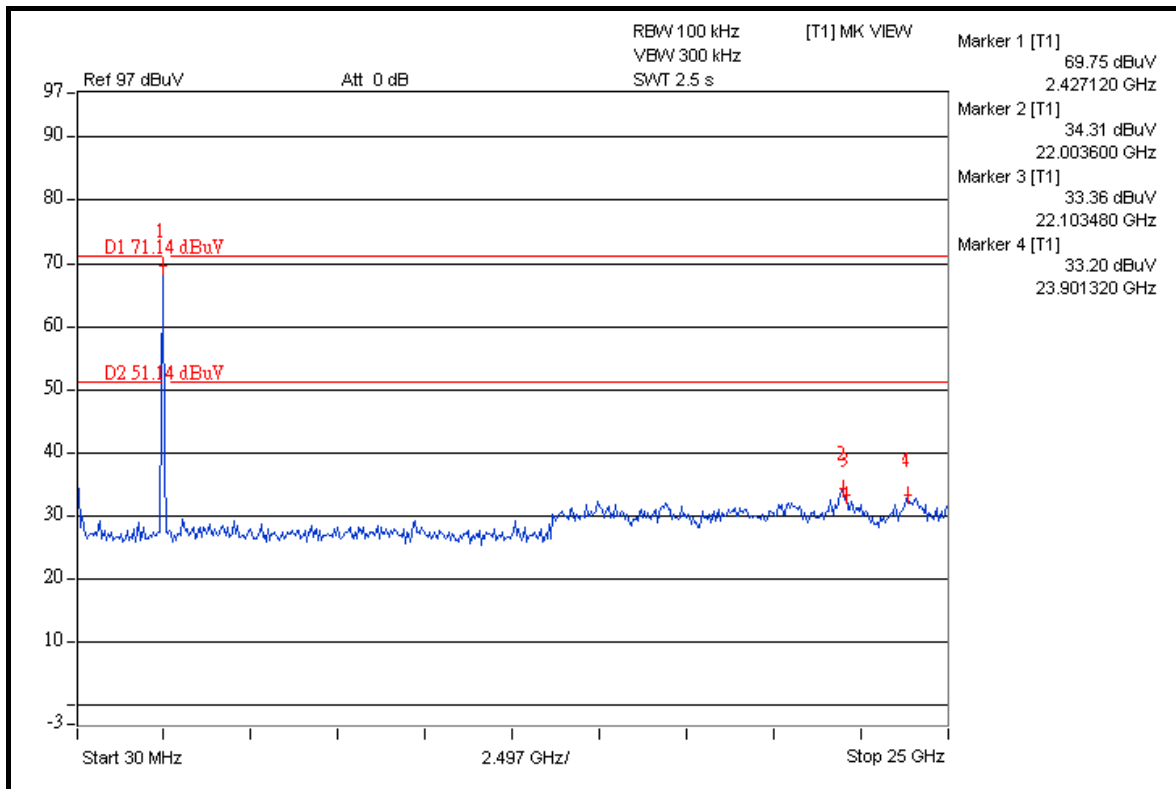
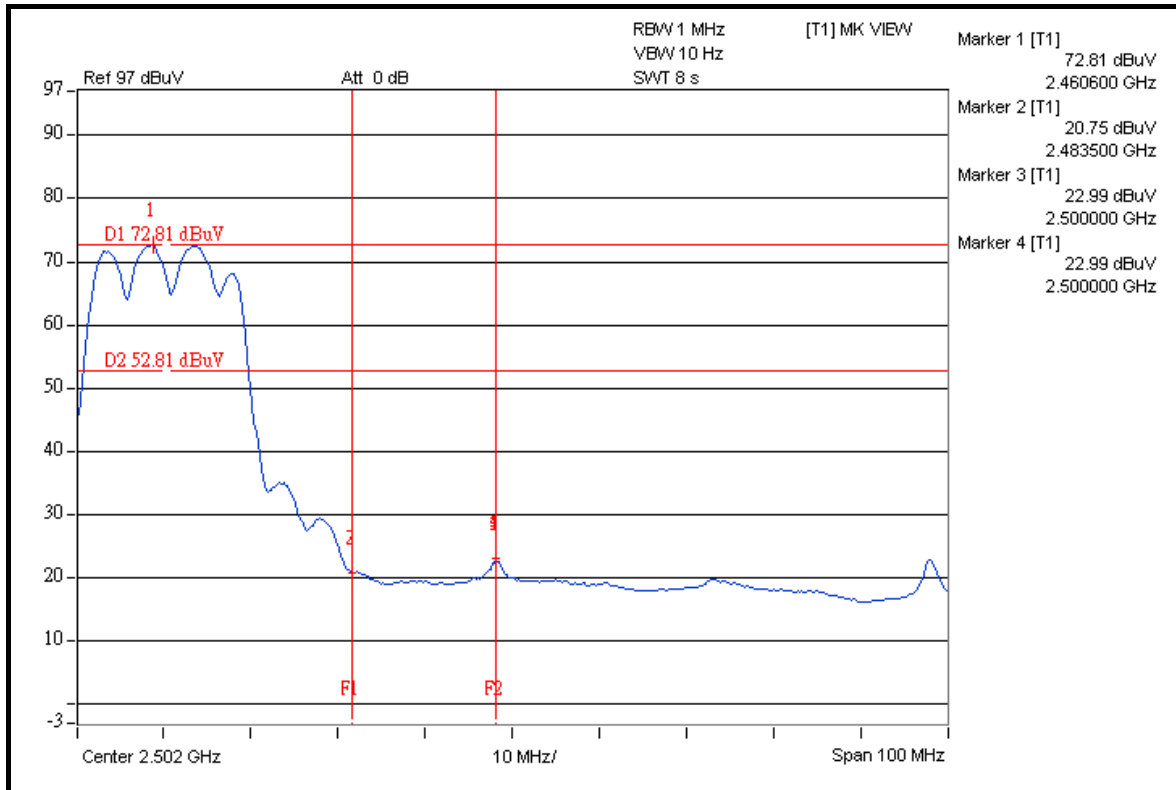



DRAFT 802.11n (20MHz) OFDM MODULATION

NOTE 1: The band edge emission plot on the next page shows 42.70dBc between carrier maximum power and local maximum emission in restrict band (2.3900GHz). The emission of carrier strength list in the test result of channel 1 at the item 4.1.7 is 107.94dBuV/m (Peak), so the maximum field strength in restrict band is $107.94 - 42.70 = 65.24$ dBuV/m which is under 74dBuV/m limit.

The band edge emission plot of on the next page shows 45.79dBc between carrier maximum power and local maximum emission in restrict band (2.3900GHz). The emission of carrier strength list in the test result of channel 1 at the item 4.1.7 is 96.53dBuV/m (Average), so the maximum field strength in restrict band is $96.53 - 45.79 = 50.74$ dBuV/m which is under 54dBuV/m limit.

NOTE 2: The band edge emission plot on the next second page shows 42.81dBc between carrier maximum power and local maximum emission in restrict band (2.4848GHz). The emission of carrier strength list in the test result of channel 11 at the item 4.1.7 is 107.79dBuV/m (Peak), so the maximum field strength in restrict band is $107.79 - 42.81 = 64.98$ dBuV/m which is under 74dBuV/m limit.

The band edge emission plot on the next third page shows 44.26dBc between carrier maximum power and local maximum emission in restrict band (2.4835GHz). The emission of carrier strength list in the test result of channel 11 at the item 4.1.7 is 96.39dBuV/m (Average), so the maximum field strength in restrict band is $96.39 - 44.26 = 52.13$ dBuV/m which is under 54dBuV/m limit.



A D T

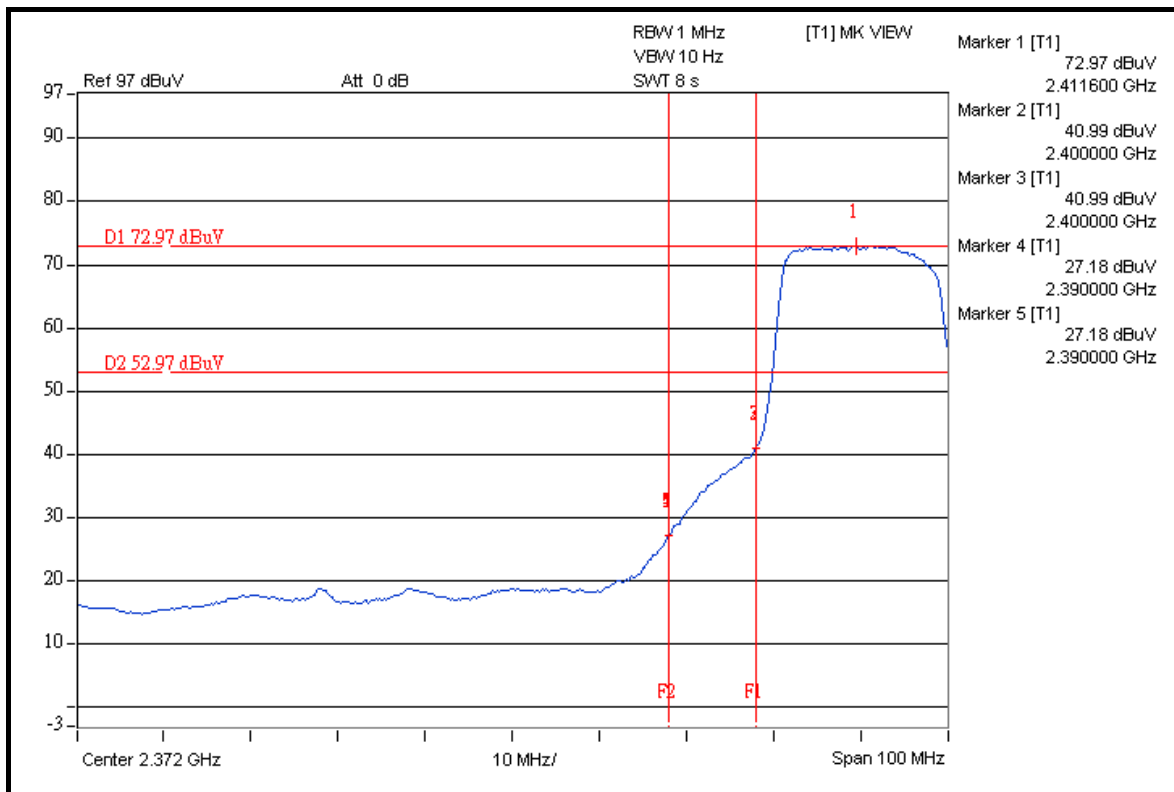
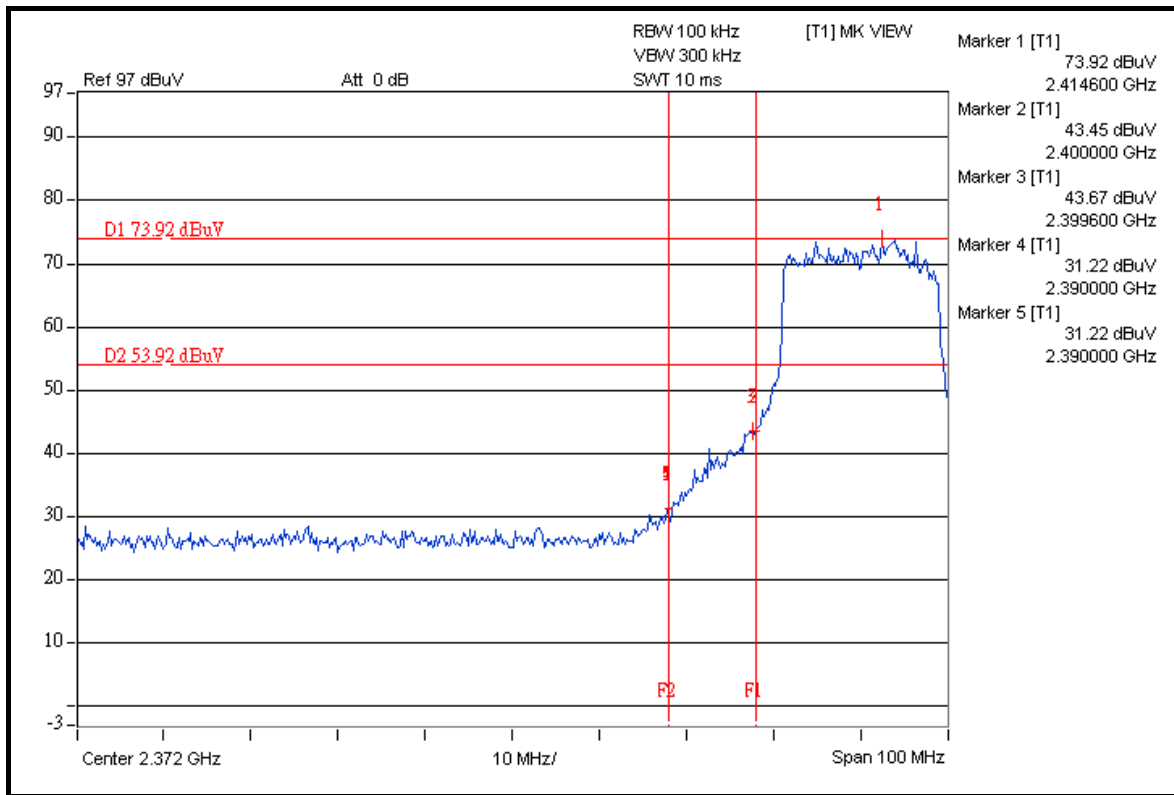



A D T

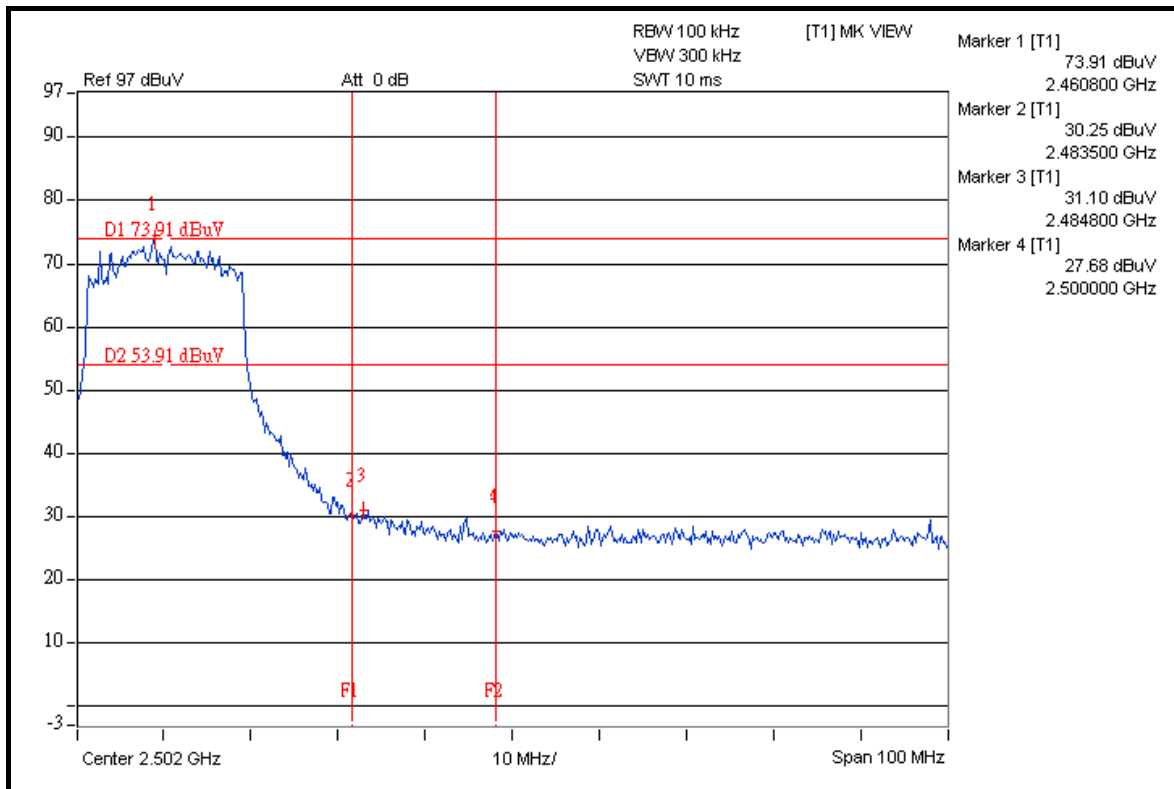
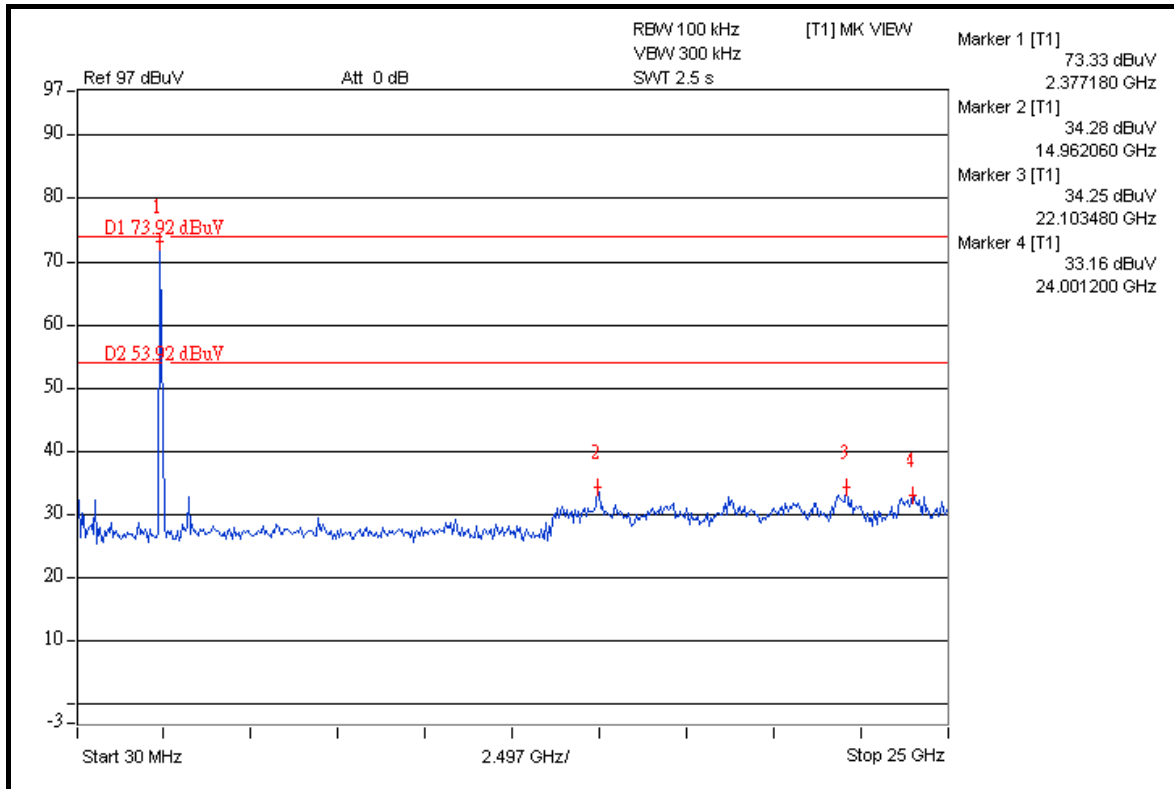



A D T

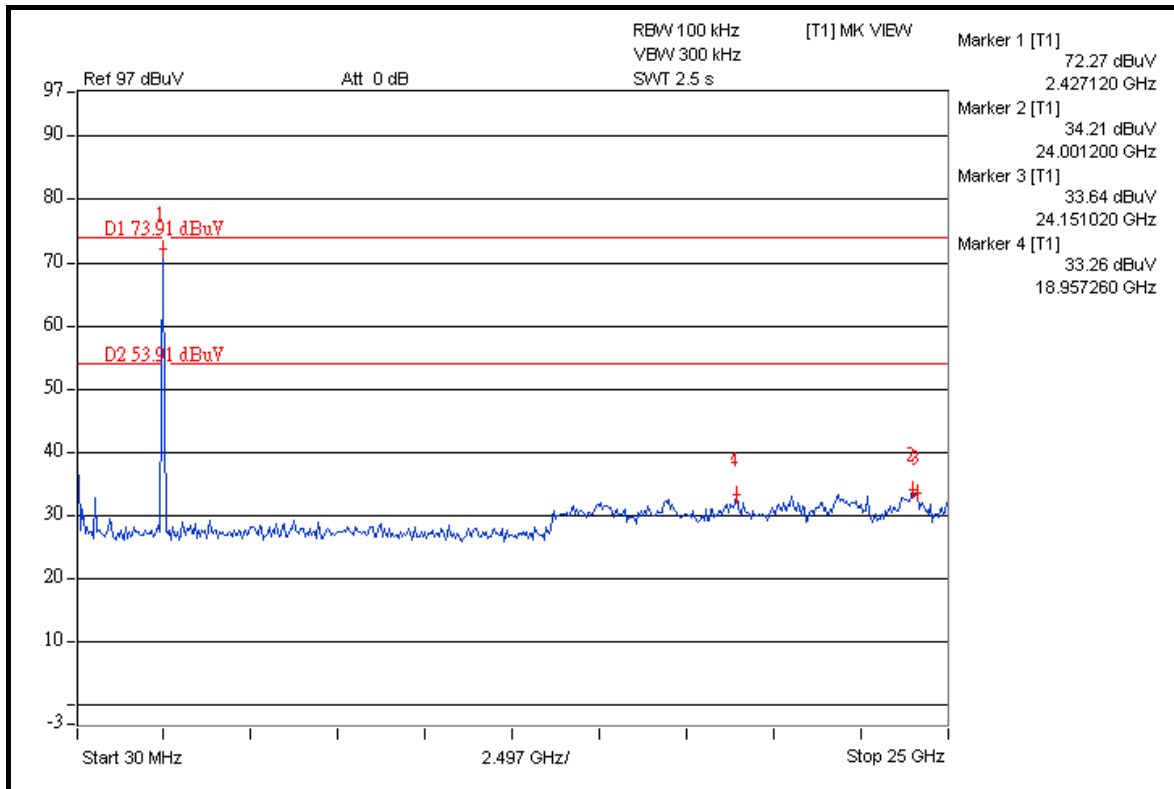
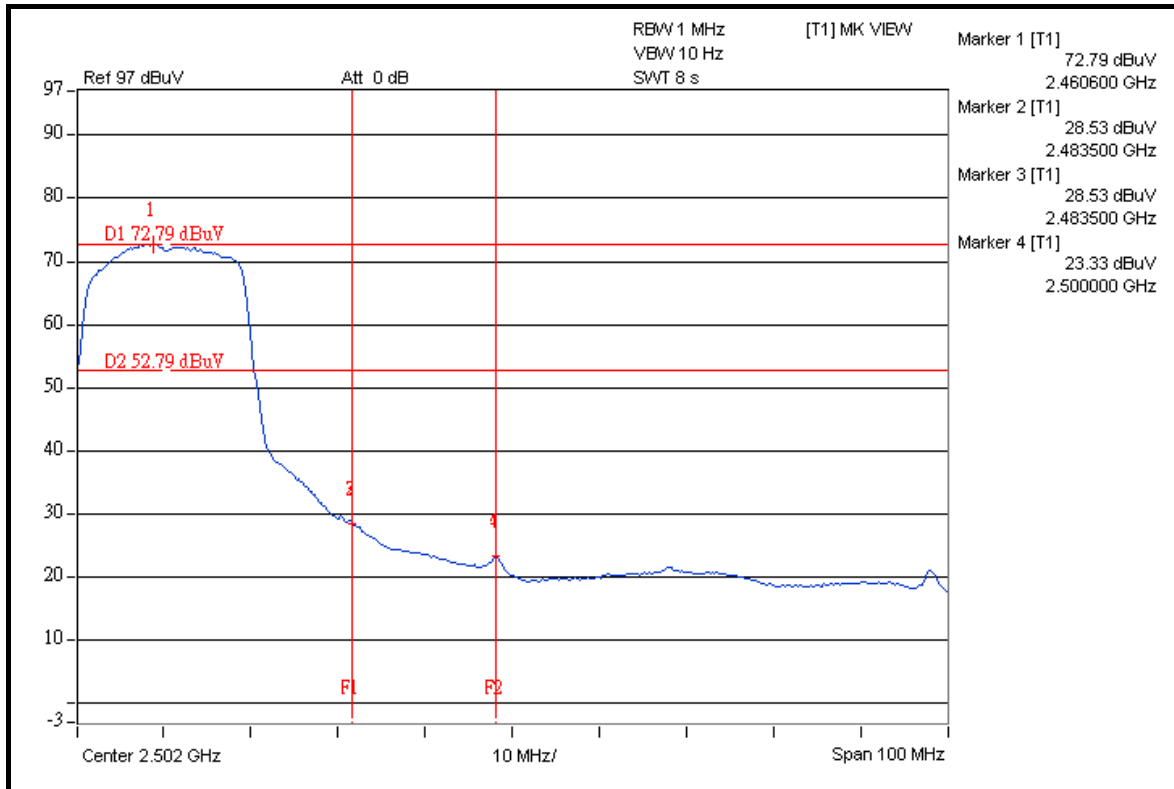



DRAFT 802.11n (40MHz) OFDM MODULATION

NOTE 1: The band edge emission plot on the next page shows 40.08dBc between carrier maximum power and local maximum emission in restrict band (2.3844GHz). The emission of carrier strength list in the test result of channel 1 at the item 4.1.7 is 104.10dBuV/m (Peak), so the maximum field strength in restrict band is $104.10 - 40.08 = 64.02$ dBuV/m which is under 74dBuV/m limit.

The band edge emission plot of on the next page shows 40.49dBc between carrier maximum power and local maximum emission in restrict band (2.3900GHz). The emission of carrier strength list in the test result of channel 1 at the item 4.1.7 is 91.96dBuV/m (Average), so the maximum field strength in restrict band is $91.96 - 40.49 = 51.47$ dBuV/m which is under 54dBuV/m limit.

NOTE 2: The band edge emission plot on the next second page shows 36.46dBc between carrier maximum power and local maximum emission in restrict band (2.4884GHz). The emission of carrier strength list in the test result of channel 7 at the item 4.1.7 is 103.15dBuV/m (Peak), so the maximum field strength in restrict band is $103.15 - 36.46 = 66.69$ dBuV/m which is under 74dBuV/m limit.

The band edge emission plot on the next third page shows 39.12dBc between carrier maximum power and local maximum emission in restrict band (2.4844GHz). The emission of carrier strength list in the test result of channel 7 at the item 4.1.7 is 91.89dBuV/m (Average), so the maximum field strength in restrict band is $91.89 - 39.12 = 52.77$ dBuV/m which is under 54dBuV/m limit.



A D T

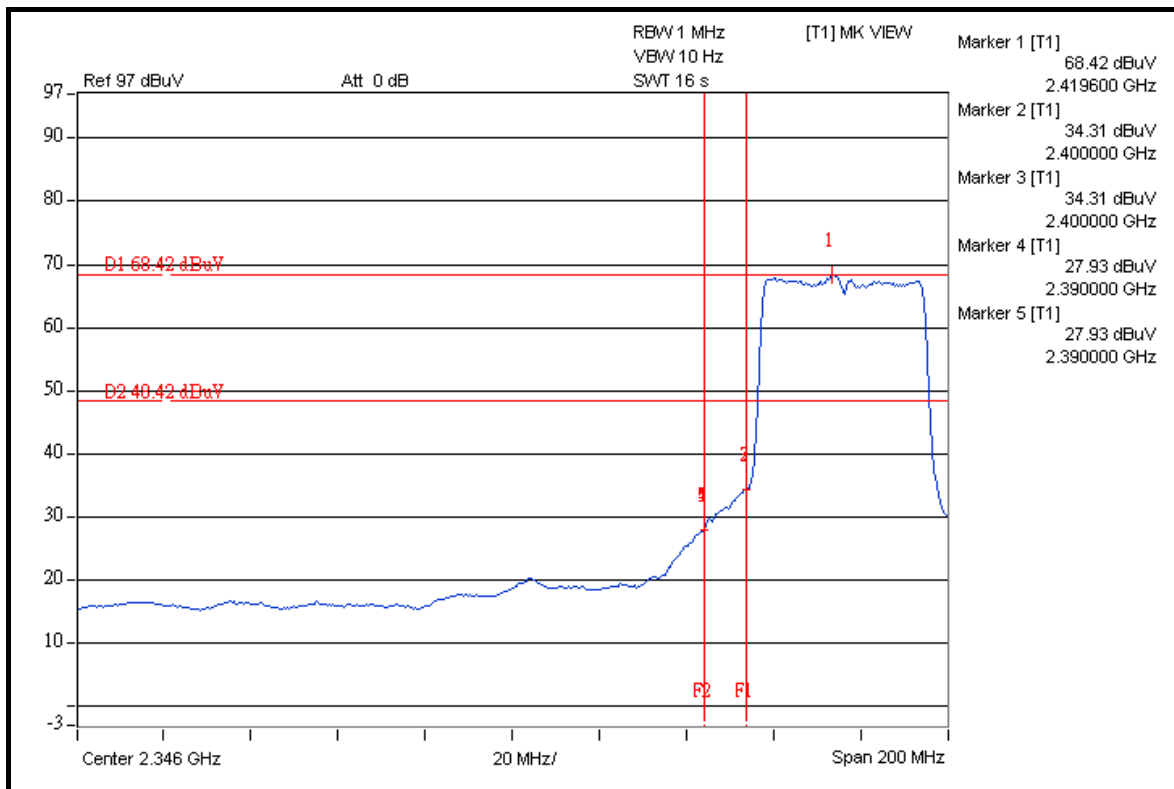
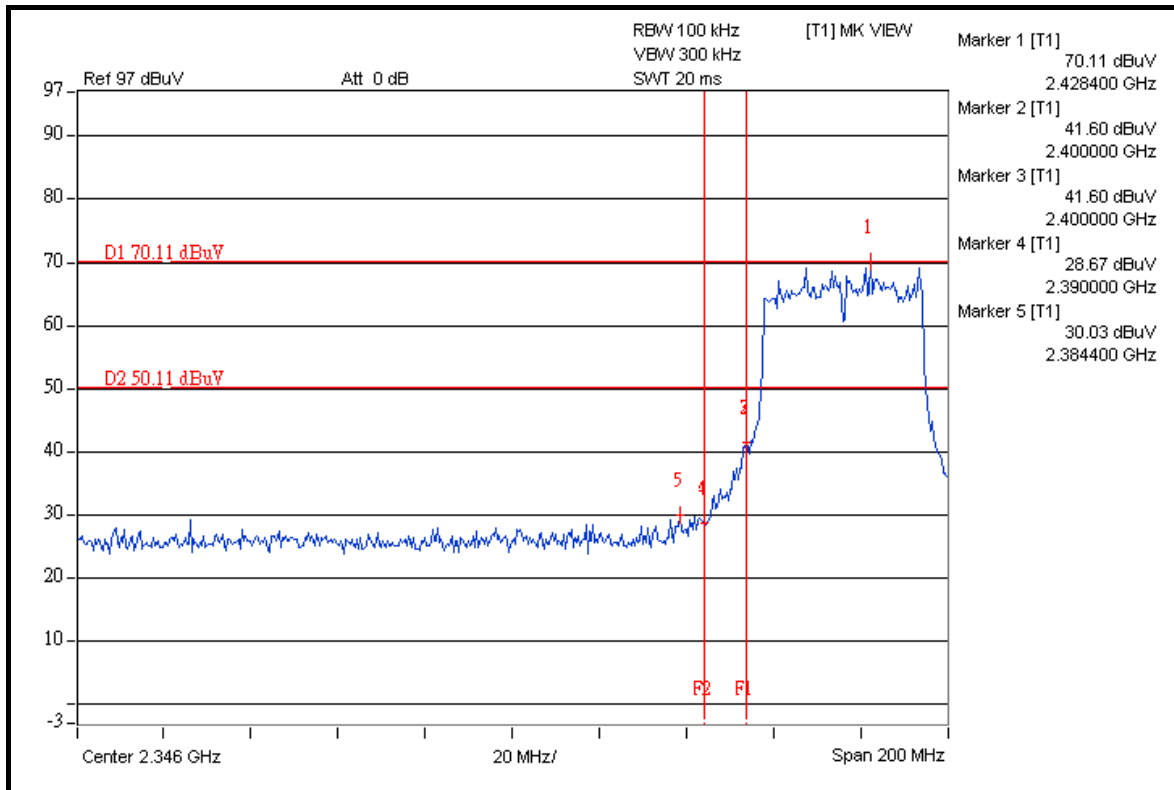



A D T

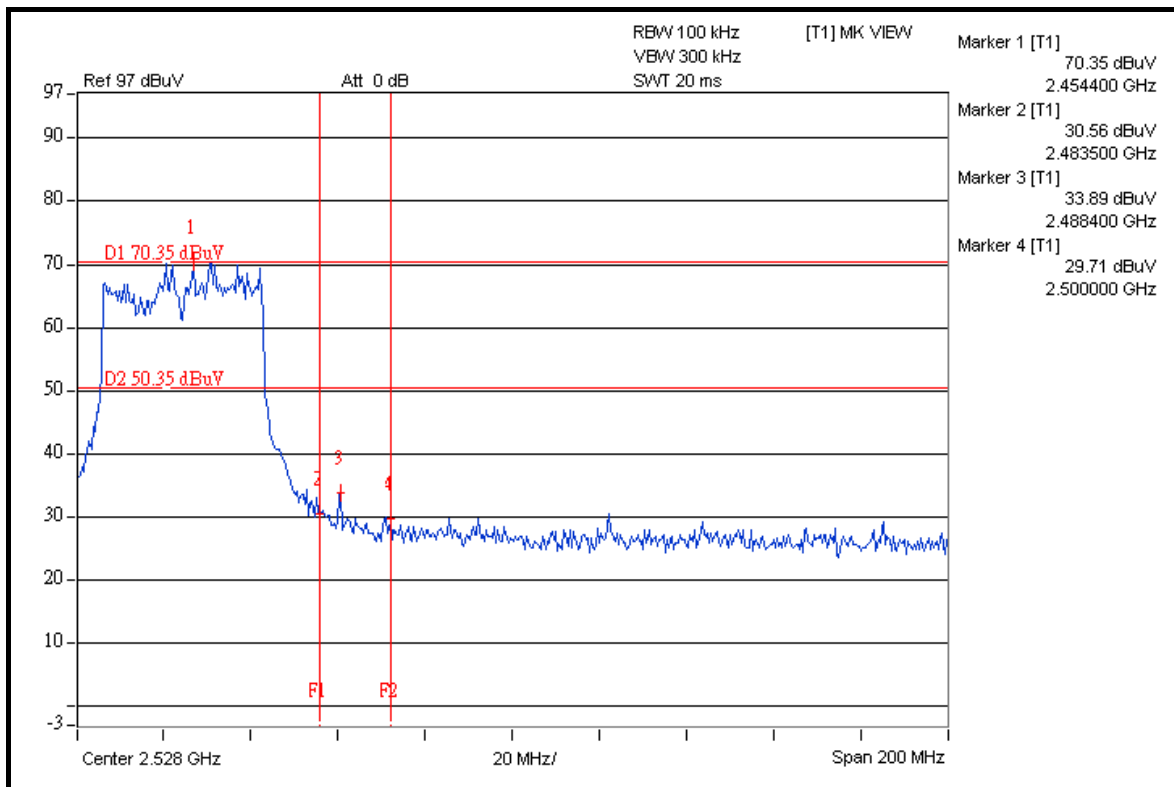
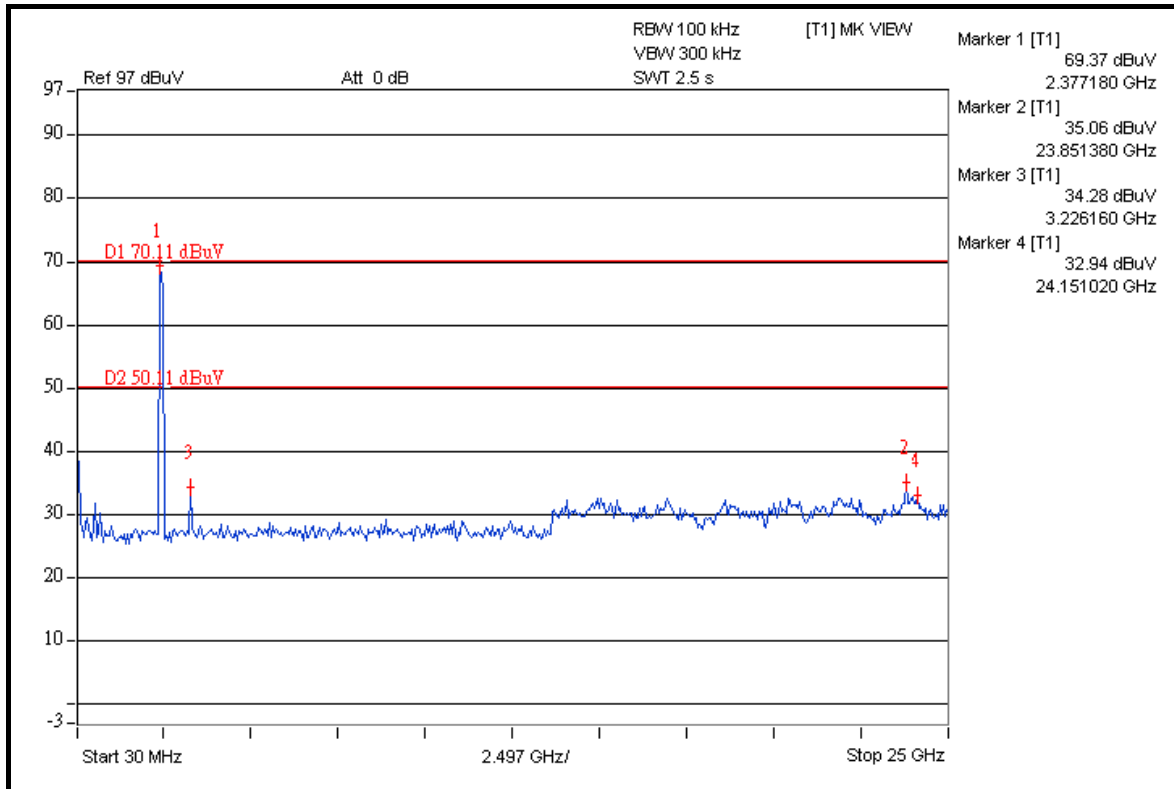



A D T

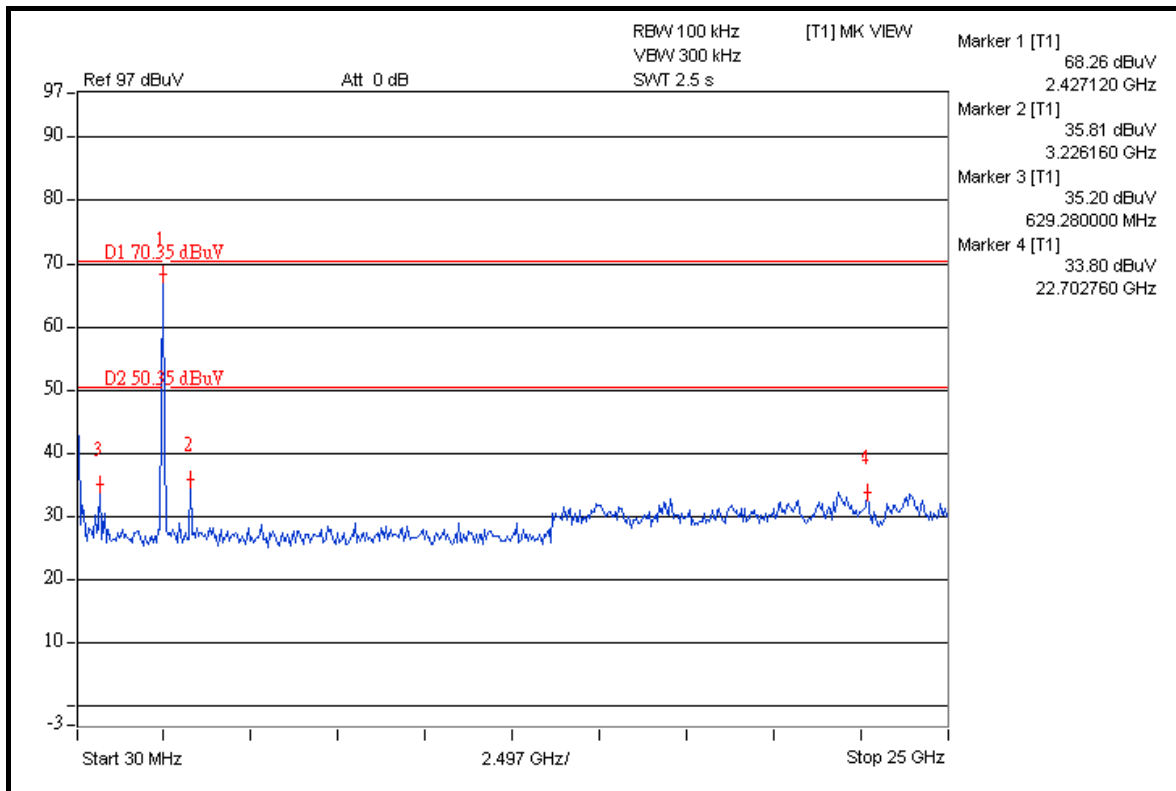
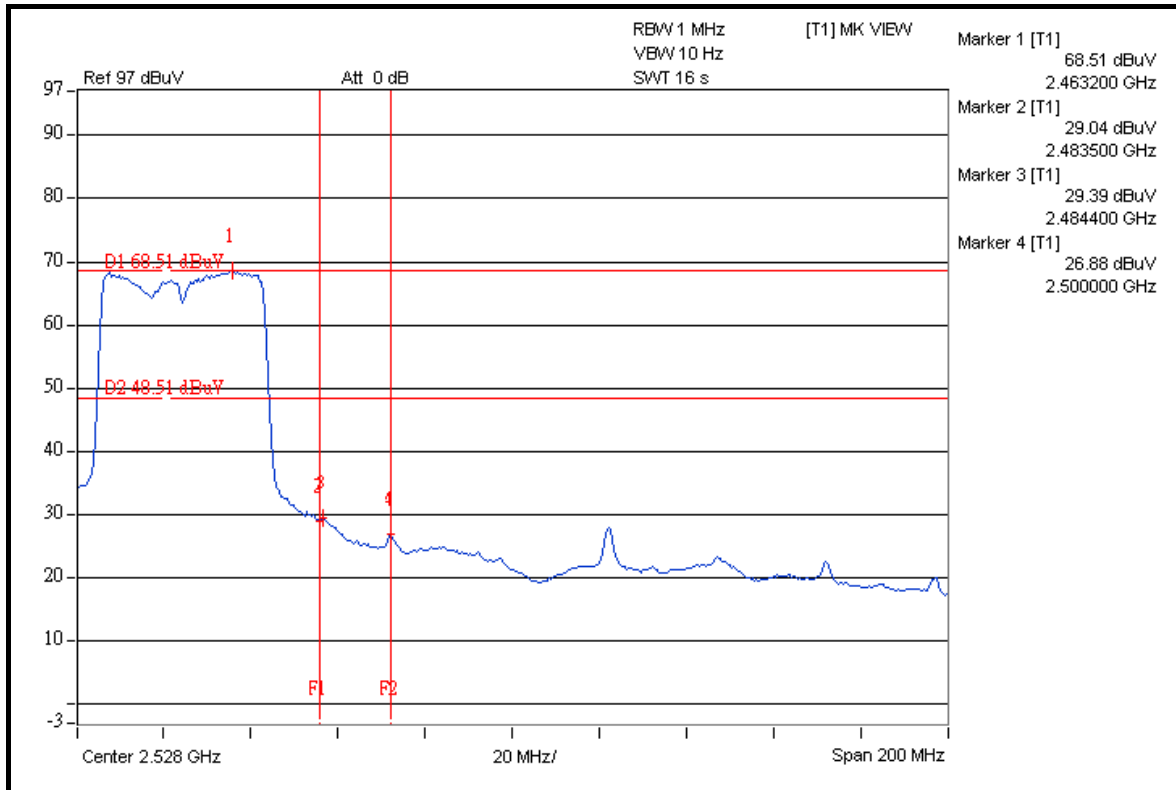



A D T

4.7 ANTENNA REQUIREMENT

4.7.1 STANDARD APPLICABLE

For intentional device, according to FCC 47 CFR Section 15.203, an intentional radiator shall be designed to ensure that no antenna other than that furnished by the responsible party shall be used with the device.

And according to FCC 47 CFR Section 15.247 (b), if transmitting antennas of directional gain greater than 6dBi are used, the power shall be reduced by the amount in dB that the directional gain of the antenna exceeds 6dBi.

4.7.2 ANTENNA CONNECTED CONSTRUCTION

The antenna used in this product is Dipole antenna with R-SMA connector. The maximum gain of the antenna is 2dBi.



5. TEST TYPES AND RESULTS (FOR 5.0GHz BAND)

5.1 RADIATED EMISSION MEASUREMENT

5.1.1 LIMITS OF RADIATED EMISSION MEASUREMENT

Emissions radiated outside of the specified bands, shall be according to the general radiated limits in 15.209 as following:

FREQUENCIES (MHz)	FIELD STRENGTH (microvolts/meter)	MEASUREMENT DISTANCE (meters)
0.009 ~ 0.490	2400/F(kHz)	300
0.490 ~ 1.705	24000/F(kHz)	30
1.705 ~ 30.0	30	30
30 ~ 88	100	3
88 ~ 216	150	3
216 ~ 960	200	3
Above 960	500	3

NOTE:

1. The lower limit shall apply at the transition frequencies.
2. Emission level (dBuV/m) = 20 log Emission level (uV/m).
3. As shown in 15.35(b), for frequencies above 1000MHz, the field strength limits are based on average detector, however, the peak field strength of any emission shall not exceed the maximum permitted average limits, specified above by more than 20dB under any condition of modulation.



A D T

5.1.2 TEST INSTRUMENTS

DESCRIPTION & MANUFACTURER	MODEL NO.	SERIAL NO.	DATE OF CALIBRATION	DUE DATE OF CALIBRATION
Test Receiver ROHDE & SCHWARZ	ESI7	100033	Jun. 30, 2008	Jun. 29, 2009
Spectrum Analyzer ROHDE & SCHWARZ	FSP40	100041	Apr. 22, 2008	Apr. 21, 2009
BILOG Antenna SCHWARZBECK	VULB9168	9168-160	May 02, 2008	May 01, 2009
HORN Antenna SCHWARZBECK	9120D	9120D-209	Jun. 24, 2008	Jun. 23, 2009
HORN Antenna SCHWARZBECK	BBHA 9170	BBHA9170243	Dec. 25, 2007	Dec. 24, 2008
Preamplifier Agilent	8447D	2944A10633	Nov. 03, 2008	Nov. 02, 2009
Preamplifier Agilent	8449B	3008A01964	Oct. 23, 2008	Oct. 22, 2009
RF signal cable HUBER+SUHNNER	SUCOFLEX 104	238141/4	May 20, 2008	May 19, 2009
RF signal cable HUBER+SUHNNER	SUCOFLEX 104	12738/6	May 20, 2008	May 19, 2009
Software ADT.	ADT_Radiated_V7.6	NA	NA	NA
Antenna Tower inn-co GmbH	MA 4000	013303	NA	NA
Antenna Tower Controller inn-co GmbH	CO2000	017303	NA	NA
Turn Table ADT.	TT100.	TT93021703	NA	NA
Turn Table Controller ADT.	SC100.	SC93021703	NA	NA

- NOTE:**
1. The calibration interval of the above test instruments is 12 months and the calibrations are traceable to NML/ROC and NIST/USA.
 2. The test was performed in HwaYa Chamber 3.
 3. The horn antenna and HP preamplifier (model: 8449B) are used only for the measurement of emission frequency above 1GHz if tested.
 4. The FCC Site Registration No. is 988962.
 5. The IC Site Registration No. is IC3450F-3.



5.1.3 TEST PROCEDURES

- a. The EUT was placed on the top of a rotating table 0.8 meters above the ground at a 3 meters semi-anechoic chamber. The table was rotated 360 degrees to determine the position of the highest radiation.
- b. The EUT was set 3 meters away from the interference-receiving antenna, which was mounted on the top of a variable-height antenna tower.
- c. The antenna is a broadband antenna, and its height is varied from one meter to four meters above the ground to determine the maximum value of the field strength. Both horizontal and vertical polarizations of the antenna are set to make the measurement.
- d. For each suspected emission, the EUT was arranged to its worst case and then the antenna was tuned to heights from 1 meter to 4 meters and the rotatable table was turned from 0 degrees to 360 degrees to find the maximum reading.
- e. The test-receiver system was set to Peak Detect Function and Specified Bandwidth with Maximum Hold Mode.
- f. If the emission level of the EUT in peak mode was lower than the limit specified, then testing could be stopped and the peak values of the EUT would be reported. Otherwise the emissions would be re-tested one by one using peak, quasi-peak or average method as specified and then reported in a data sheet.

NOTE:

1. The resolution bandwidth and video bandwidth of test receiver/spectrum analyzer is 120kHz for Quasi-peak detection at frequency below 1GHz.
2. The resolution bandwidth of test receiver/spectrum analyzer is 1MHz and video bandwidth is 3MHz for Peak detection at frequency above 1GHz.
3. The resolution bandwidth of test receiver/spectrum analyzer is 1MHz and the video bandwidth is 10Hz for Average detection (AV) at frequency above 1GHz.
4. All modes of operation were investigated and the worst-case emissions are reported.

5.1.4 DEVIATION FROM TEST STANDARD

No deviation.

5.1.5 TEST SETUP

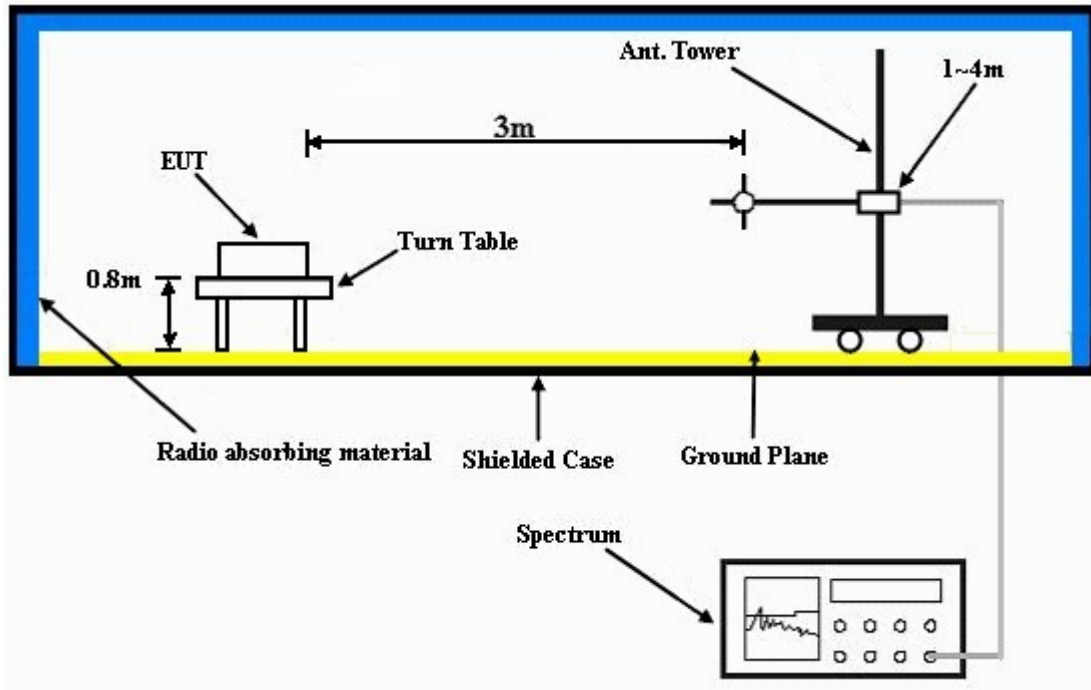

For the actual test configuration, please refer to the attached file (Test Setup Photo).

5.1.6 EUT OPERATING CONDITIONS

Same as 4.1.6.



5.1.7 TEST RESULTS

802.11a OFDM MODULATION

EUT TEST CONDITION		MEASUREMENT DETAIL	
CHANNEL	Channel 149	FREQUENCY RANGE	1 ~ 40GHz
INPUT POWER (SYSTEM)	120Vac, 60 Hz	DETECTOR FUNCTION	Peak (PK) Average (AV)
ENVIRONMENTAL CONDITIONS	24deg. C, 62%RH 1000hPa	TESTED BY	Kevin Liang

ANTENNA POLARITY & TEST DISTANCE: HORIZONTAL AT 3 M								
NO.	FREQ. (MHz)	EMISSION LEVEL (dBuV/m)	LIMIT (dBuV/m)	MARGIN (dB)	ANTENNA HEIGHT (m)	TABLE ANGLE (Degree)	RAW VALUE (dBuV)	CORRECTION FACTOR (dB/m)
1	#5725.00	53.68 PK	77.56	-23.88	1.05 H	178	12.16	41.52
2	#5725.00	37.45 AV	66.13	-28.68	1.05 H	178	-4.06	41.52
3	*5745.00	97.56 PK			1.05 H	178	56.00	41.56
4	*5745.00	86.13 AV			1.05 H	178	44.57	41.56
5	11490.00	61.28 PK	74.00	-12.72	1.24 H	172	7.98	53.30
6	11490.00	48.33 AV	54.00	-5.67	1.24 H	172	-4.98	53.30
ANTENNA POLARITY & TEST DISTANCE: VERTICAL AT 3 M								
NO.	FREQ. (MHz)	EMISSION LEVEL (dBuV/m)	LIMIT (dBuV/m)	MARGIN (dB)	ANTENNA HEIGHT (m)	TABLE ANGLE (Degree)	RAW VALUE (dBuV)	CORRECTION FACTOR (dB/m)
1	#5725.00	71.09 PK	91.61	-20.52	1.04 V	184	29.57	41.52
2	#5725.00	48.78 AV	79.53	-30.75	1.04 V	184	7.27	41.52
3	*5745.00	111.61 PK			1.04 V	184	70.05	41.56
4	*5745.00	99.53 AV			1.04 V	184	57.97	41.56
5	11490.00	63.84 PK	74.00	-10.16	1.11 V	191	10.53	53.30
6	11490.00	49.95 AV	54.00	-4.05	1.11 V	191	-3.36	53.30

- REMARKS:**
1. Emission level (dBuV/m) = Raw Value (dBuV) + Correction Factor (dB/m).
 2. Correction Factor (dB/m) = Antenna Factor (dB/m) + Cable Factor (dB).
 3. The other emission levels were very low against the limit.
 4. Margin value = Emission level – Limit value.
 5. “ * “: Fundamental frequency.
 6. The limit value is defined as per 15.247.
 7. "#":The radiated frequency is out the restricted band.



A D T

EUT TEST CONDITION		MEASUREMENT DETAIL	
CHANNEL	Channel 157	FREQUENCY RANGE	1 ~ 40GHz
INPUT POWER (SYSTEM)	120Vac, 60 Hz	DETECTOR FUNCTION	Peak (PK) Average (AV)
ENVIRONMENTAL CONDITIONS	24deg. C, 62%RH 1000hPa	TESTED BY	Kevin Liang

ANTENNA POLARITY & TEST DISTANCE: HORIZONTAL AT 3 M								
NO.	FREQ. (MHz)	EMISSION LEVEL (dBuV/m)	LIMIT (dBuV/m)	MARGIN (dB)	ANTENNA HEIGHT (m)	TABLE ANGLE (Degree)	RAW VALUE (dBuV)	CORRECTION FACTOR (dB/m)
1	*5785.00	96.46 PK			1.03 H	176	54.82	41.64
2	*5785.00	85.34 AV			1.03 H	176	43.70	41.64
3	11570.00	61.33 PK	74.00	-12.67	1.00 H	180	8.17	53.16
4	11570.00	48.42 AV	54.00	-5.58	1.00 H	180	-4.74	53.16
ANTENNA POLARITY & TEST DISTANCE: VERTICAL AT 3 M								
NO.	FREQ. (MHz)	EMISSION LEVEL (dBuV/m)	LIMIT (dBuV/m)	MARGIN (dB)	ANTENNA HEIGHT (m)	TABLE ANGLE (Degree)	RAW VALUE (dBuV)	CORRECTION FACTOR (dB/m)
1	*5785.00	112.58 PK			1.04 V	184	70.94	41.64
2	*5785.00	101.47 AV			1.04 V	184	59.83	41.64
3	11570.00	63.91 PK	74.00	-10.09	1.12 V	193	10.75	53.16
4	11570.00	50.07 AV	54.00	-3.93	1.12 V	193	-3.09	53.16

- REMARKS:**
1. Emission level (dBuV/m) = Raw Value (dBuV) + Correction Factor (dB/m).
 2. Correction Factor (dB/m) = Antenna Factor (dB/m) + Cable Factor (dB).
 3. The other emission levels were very low against the limit.
 4. Margin value = Emission level – Limit value.
 5. “ * “: Fundamental frequency.
 6. The limit value is defined as per 15.247.



A D T

EUT TEST CONDITION		MEASUREMENT DETAIL	
CHANNEL	Channel 165	FREQUENCY RANGE	1 ~ 40GHz
INPUT POWER (SYSTEM)	120Vac, 60 Hz	DETECTOR FUNCTION	Peak (PK) Average (AV)
ENVIRONMENTAL CONDITIONS	24deg. C, 62%RH 1000hPa	TESTED BY	Kevin Liang

ANTENNA POLARITY & TEST DISTANCE: HORIZONTAL AT 3 M								
NO.	FREQ. (MHz)	EMISSION LEVEL (dBuV/m)	LIMIT (dBuV/m)	MARGIN (dB)	ANTENNA HEIGHT (m)	TABLE ANGLE (Degree)	RAW VALUE (dBuV)	CORRECTION FACTOR (dB/m)
1	*5825.00	97.91 PK			1.00 H	241	56.17	41.74
2	*5825.00	86.66 AV			1.00 H	241	44.92	41.74
3	#5850.00	49.37 PK	77.91	-28.54	1.00 H	241	7.57	41.80
4	#5850.00	35.36 AV	66.66	-31.30	1.00 H	241	-6.45	41.80
5	11650.00	61.37 PK	74.00	-12.62	1.09 H	104	8.32	53.05
6	11650.00	48.93 AV	54.00	-5.07	1.09 H	104	-4.13	53.05
ANTENNA POLARITY & TEST DISTANCE: VERTICAL AT 3 M								
NO.	FREQ. (MHz)	EMISSION LEVEL (dBuV/m)	LIMIT (dBuV/m)	MARGIN (dB)	ANTENNA HEIGHT (m)	TABLE ANGLE (Degree)	RAW VALUE (dBuV)	CORRECTION FACTOR (dB/m)
1	*5825.00	113.04 PK			1.03 V	198	71.30	41.74
2	*5825.00	101.88 AV			1.03 V	198	60.14	41.74
3	#5850.00	62.33 PK	93.04	-30.71	1.03 V	198	20.52	41.80
4	#5850.00	40.11 AV	81.88	-41.77	1.03 V	198	-1.70	41.80
5	11650.00	65.12 PK	74.00	-8.88	1.20 V	127	12.06	53.05
6	11650.00	52.43 AV	54.00	-1.57	1.20 V	127	-0.63	53.05

- REMARKS:**
1. Emission level (dBuV/m) = Raw Value (dBuV) + Correction Factor (dB/m).
 2. Correction Factor (dB/m) = Antenna Factor (dB/m) + Cable Factor (dB).
 3. The other emission levels were very low against the limit.
 4. Margin value = Emission level – Limit value.
 5. “ * “: Fundamental frequency.
 6. The limit value is defined as per 15.247.
 7. "#":The radiated frequency is out the restricted band.



A D T

DRAFT 802.11n (20MHz) OFDM MODULATION

EUT TEST CONDITION		MEASUREMENT DETAIL	
CHANNEL	Channel 149	FREQUENCY RANGE	1 ~ 40GHz
INPUT POWER (SYSTEM)	120Vac, 60 Hz	DETECTOR FUNCTION	Peak (PK) Average (AV)
ENVIRONMENTAL CONDITIONS	24deg. C, 62%RH 1000hPa	TESTED BY	Match Tsui

ANTENNA POLARITY & TEST DISTANCE: HORIZONTAL AT 3 M								
NO.	FREQ. (MHz)	EMISSION LEVEL (dBuV/m)	LIMIT (dBuV/m)	MARGIN (dB)	ANTENNA HEIGHT (m)	TABLE ANGLE (Degree)	RAW VALUE (dBuV)	CORRECTION FACTOR (dB/m)
1	#5725.00	59.91 PK	78.80	-18.89	1.46 H	224	18.40	41.52
2	#5725.00	41.21 AV	66.79	-25.58	1.46 H	224	-0.30	41.52
3	*5745.00	98.80 PK			1.46 H	224	57.24	41.56
4	*5745.00	86.79 AV			1.46 H	224	45.23	41.56
5	11490.00	62.87 PK	74.00	-11.12	1.45 H	302	9.57	53.30
6	11490.00	49.15 AV	54.00	-4.85	1.45 H	302	-4.16	53.30
ANTENNA POLARITY & TEST DISTANCE: VERTICAL AT 3 M								
NO.	FREQ. (MHz)	EMISSION LEVEL (dBuV/m)	LIMIT (dBuV/m)	MARGIN (dB)	ANTENNA HEIGHT (m)	TABLE ANGLE (Degree)	RAW VALUE (dBuV)	CORRECTION FACTOR (dB/m)
1	#5725.00	69.56 PK	92.50	-22.94	1.20 V	328	28.04	41.52
2	#5725.00	54.40 AV	80.27	-25.87	1.20 V	328	12.88	41.52
3	*5745.00	112.50 PK			1.19 V	328	70.94	41.56
4	*5745.00	100.27 AV			1.19 V	328	58.71	41.56
5	11490.00	67.05 PK	74.00	-6.95	1.42 V	80	13.74	53.30
6	11490.00	52.55 AV	54.00	-1.45	1.42 V	80	-0.76	53.30

- REMARKS:**
1. Emission level (dBuV/m) = Raw Value (dBuV) + Correction Factor (dB/m).
 2. Correction Factor (dB/m) = Antenna Factor (dB/m) + Cable Factor (dB).
 3. The other emission levels were very low against the limit.
 4. Margin value = Emission level – Limit value.
 5. “ * “: Fundamental frequency.
 6. The limit value is defined as per 15.247.
 7. "#":The radiated frequency is out the restricted band.



A D T

EUT TEST CONDITION		MEASUREMENT DETAIL	
CHANNEL	Channel 157	FREQUENCY RANGE	1 ~ 40GHz
INPUT POWER (SYSTEM)	120Vac, 60 Hz	DETECTOR FUNCTION	Peak (PK) Average (AV)
ENVIRONMENTAL CONDITIONS	24deg. C, 62%RH 1000hPa	TESTED BY	Match Tsui

ANTENNA POLARITY & TEST DISTANCE: HORIZONTAL AT 3 M								
NO.	FREQ. (MHz)	EMISSION LEVEL (dBuV/m)	LIMIT (dBuV/m)	MARGIN (dB)	ANTENNA HEIGHT (m)	TABLE ANGLE (Degree)	RAW VALUE (dBuV)	CORRECTION FACTOR (dB/m)
1	*5785.00	98.01 PK			1.02 H	234	56.37	41.64
2	*5785.00	86.01 AV			1.02 H	234	44.37	41.64
3	11570.00	61.79 PK	74.00	-12.21	1.64 H	284	8.62	53.16
4	11570.00	49.29 AV	54.00	-4.71	1.64 H	284	-3.88	53.16
ANTENNA POLARITY & TEST DISTANCE: VERTICAL AT 3 M								
NO.	FREQ. (MHz)	EMISSION LEVEL (dBuV/m)	LIMIT (dBuV/m)	MARGIN (dB)	ANTENNA HEIGHT (m)	TABLE ANGLE (Degree)	RAW VALUE (dBuV)	CORRECTION FACTOR (dB/m)
1	*5785.00	113.88 PK			1.14 V	180	72.24	41.64
2	*5785.00	102.02 AV			1.14 V	180	60.38	41.64
3	11570.00	67.75 PK	74.00	-6.25	1.64 V	261	14.58	53.16
4	11570.00	52.19 AV	54.00	-1.81	1.64 V	261	-0.98	53.16

- REMARKS:**
1. Emission level (dBuV/m) = Raw Value (dBuV) + Correction Factor (dB/m).
 2. Correction Factor (dB/m) = Antenna Factor (dB/m) + Cable Factor (dB).
 3. The other emission levels were very low against the limit.
 4. Margin value = Emission level – Limit value.
 5. “ * “: Fundamental frequency.
 6. The limit value is defined as per 15.247.



A D T

EUT TEST CONDITION		MEASUREMENT DETAIL	
CHANNEL	Channel 165	FREQUENCY RANGE	1 ~ 40GHz
INPUT POWER (SYSTEM)	120Vac, 60 Hz	DETECTOR FUNCTION	Peak (PK) Average (AV)
ENVIRONMENTAL CONDITIONS	24deg. C, 62%RH 1000hPa	TESTED BY	Match Tsui

ANTENNA POLARITY & TEST DISTANCE: HORIZONTAL AT 3 M								
NO.	FREQ. (MHz)	EMISSION LEVEL (dBuV/m)	LIMIT (dBuV/m)	MARGIN (dB)	ANTENNA HEIGHT (m)	TABLE ANGLE (Degree)	RAW VALUE (dBuV)	CORRECTION FACTOR (dB/m)
1	*5825.00	99.03 PK			1.22 H	171	57.29	41.74
2	*5825.00	87.15 AV			1.22 H	171	45.41	41.74
3	#5850.00	48.20 PK	79.03	-30.83	1.22 H	171	6.39	41.80
4	#5850.00	35.61 AV	67.15	-31.54	1.22 H	171	-6.20	41.80
5	11650.00	60.75 PK	74.00	-13.25	1.26 H	354	7.69	53.05
6	11650.00	48.12 AV	54.00	-5.88	1.26 H	354	-4.94	53.05
ANTENNA POLARITY & TEST DISTANCE: VERTICAL AT 3 M								
NO.	FREQ. (MHz)	EMISSION LEVEL (dBuV/m)	LIMIT (dBuV/m)	MARGIN (dB)	ANTENNA HEIGHT (m)	TABLE ANGLE (Degree)	RAW VALUE (dBuV)	CORRECTION FACTOR (dB/m)
1	*5825.00	113.48 PK			1.13 V	181	71.74	41.74
2	*5825.00	102.02 AV			1.13 V	181	60.28	41.74
3	#5850.00	59.65 PK	93.48	-33.83	1.13 V	181	17.84	41.80
4	#5850.00	41.77 AV	82.02	-40.25	1.13 V	181	-0.04	41.80
5	11650.00	67.25 PK	74.00	-6.75	1.27 V	75	14.20	53.05
6	11650.00	52.07 AV	54.00	-1.93	1.27 V	75	-0.98	53.05

- REMARKS:**
1. Emission level (dBuV/m) = Raw Value (dBuV) + Correction Factor (dB/m).
 2. Correction Factor (dB/m) = Antenna Factor (dB/m) + Cable Factor (dB).
 3. The other emission levels were very low against the limit.
 4. Margin value = Emission level – Limit value.
 5. “ * “: Fundamental frequency.
 6. The limit value is defined as per 15.247.
 7. "#":The radiated frequency is out the restricted band.



A D T

DRAFT 802.11n (40MHz) OFDM MODULATION

EUT TEST CONDITION		MEASUREMENT DETAIL	
CHANNEL	Channel 151	FREQUENCY RANGE	1 ~ 40GHz
INPUT POWER (SYSTEM)	120Vac, 60 Hz	DETECTOR FUNCTION	Peak (PK) Average (AV)
ENVIRONMENTAL CONDITIONS	24deg. C, 62%RH 1000hPa	TESTED BY	Match Tsui

ANTENNA POLARITY & TEST DISTANCE: HORIZONTAL AT 3 M								
NO.	FREQ. (MHz)	EMISSION LEVEL (dBuV/m)	LIMIT (dBuV/m)	MARGIN (dB)	ANTENNA HEIGHT (m)	TABLE ANGLE (Degree)	RAW VALUE (dBuV)	CORRECTION FACTOR (dB/m)
1	#5725.00	60.27 PK	75.94	-15.67	1.37 H	170	18.76	41.52
2	#5725.00	39.52 AV	64.47	-24.95	1.37 H	170	-1.99	41.52
3	*5755.00	95.94 PK			1.05 H	215	54.36	41.58
4	*5755.00	84.47 AV			1.05 H	215	42.89	41.58
5	11510.00	60.91 PK	74.00	-13.09	1.14 H	0	7.60	53.31
6	11510.00	48.24 AV	54.00	-5.76	1.14 H	0	-5.07	53.31
ANTENNA POLARITY & TEST DISTANCE: VERTICAL AT 3 M								
NO.	FREQ. (MHz)	EMISSION LEVEL (dBuV/m)	LIMIT (dBuV/m)	MARGIN (dB)	ANTENNA HEIGHT (m)	TABLE ANGLE (Degree)	RAW VALUE (dBuV)	CORRECTION FACTOR (dB/m)
1	#5725.00	77.66 PK	90.07	-12.41	1.04 V	170	36.14	41.52
2	#5725.00	54.74 AV	78.16	-23.42	1.04 V	170	13.23	41.52
3	*5755.00	110.07 PK			1.04 V	170	68.49	41.58
4	*5755.00	98.16 AV			1.04 V	170	56.58	41.58
5	11510.00	63.93 PK	74.00	-10.07	1.62 V	257	10.62	53.31
6	11510.00	49.84 AV	54.00	-4.16	1.62 V	257	-3.47	53.31

- REMARKS:**
1. Emission level (dBuV/m) = Raw Value (dBuV) + Correction Factor (dB/m).
 2. Correction Factor (dB/m) = Antenna Factor (dB/m) + Cable Factor (dB).
 3. The other emission levels were very low against the limit.
 4. Margin value = Emission level – Limit value.
 5. “ * “: Fundamental frequency.
 6. The limit value is defined as per 15.247.
 7. "#":The radiated frequency is out the restricted band.



A D T

EUT TEST CONDITION		MEASUREMENT DETAIL	
CHANNEL	Channel 159	FREQUENCY RANGE	1 ~ 40GHz
INPUT POWER (SYSTEM)	120Vac, 60 Hz	DETECTOR FUNCTION	Peak (PK) Average (AV)
ENVIRONMENTAL CONDITIONS	24deg. C, 62%RH 1000hPa	TESTED BY	Match Tsui

ANTENNA POLARITY & TEST DISTANCE: HORIZONTAL AT 3 M								
NO.	FREQ. (MHz)	EMISSION LEVEL (dBuV/m)	LIMIT (dBuV/m)	MARGIN (dB)	ANTENNA HEIGHT (m)	TABLE ANGLE (Degree)	RAW VALUE (dBuV)	CORRECTION FACTOR (dB/m)
1	*5795.00	96.20 PK			1.19 H	229	54.54	41.66
2	*5795.00	85.98 AV			1.19 H	229	44.32	41.66
3	#5850.00	46.52 PK	76.20	-29.68	1.19 H	229	4.72	41.80
4	#5850.00	36.37 AV	65.98	-29.61	1.19 H	229	-5.44	41.80
5	11590.00	61.68 PK	74.00	-12.32	1.57 H	162	8.57	53.11
6	11590.00	47.96 AV	54.00	-6.04	1.57 H	162	-5.15	53.11
ANTENNA POLARITY & TEST DISTANCE: VERTICAL AT 3 M								
NO.	FREQ. (MHz)	EMISSION LEVEL (dBuV/m)	LIMIT (dBuV/m)	MARGIN (dB)	ANTENNA HEIGHT (m)	TABLE ANGLE (Degree)	RAW VALUE (dBuV)	CORRECTION FACTOR (dB/m)
1	*5795.00	111.54 PK			1.03 V	181	69.88	41.66
2	*5795.00	99.74 AV			1.03 V	181	58.08	41.66
3	#5850.00	59.83 PK	91.54	-31.71	1.03 V	181	18.02	41.80
4	#5850.00	38.19 AV	79.74	-41.55	1.03 V	181	-3.62	41.80
5	11590.00	65.27 PK	74.00	-8.73	1.72 V	243	12.16	53.11
6	11590.00	50.73 AV	54.00	-3.27	1.72 V	243	-2.38	53.11

- REMARKS:**
1. Emission level (dBuV/m) = Raw Value (dBuV) + Correction Factor (dB/m).
 2. Correction Factor (dB/m) = Antenna Factor (dB/m) + Cable Factor (dB).
 3. The other emission levels were very low against the limit.
 4. Margin value = Emission level – Limit value.
 5. “ * “: Fundamental frequency.
 6. The limit value is defined as per 15.247.
 7. "#":The radiated frequency is out the restricted band.



A D T

BELOW 1GHz WORST-CASE DATA : 802.11a OFDM MODULATION

EUT TEST CONDITION		MEASUREMENT DETAIL	
CHANNEL	Channel 165	FREQUENCY RANGE	Below 1000MHz
INPUT POWER (SYSTEM)	120Vac, 60 Hz	DETECTOR FUNCTION	Quasi-Peak
ENVIRONMENTAL CONDITIONS	24deg. C, 64%RH 999hPa	TEST MODE	A
TESTED BY	Match Tsui		

ANTENNA POLARITY & TEST DISTANCE: HORIZONTAL AT 3 M								
NO.	FREQ. (MHz)	EMISSION LEVEL (dBuV/m)	LIMIT (dBuV/m)	MARGIN (dB)	ANTENNA HEIGHT (m)	TABLE ANGLE (Degree)	RAW VALUE (dBuV)	CORRECTION FACTOR (dB/m)
1	97.95	37.15 QP	43.50	-6.35	2.00 H	316	25.93	11.22
2	160.17	33.15 QP	43.50	-10.35	1.50 H	13	18.32	14.83
3	175.72	34.31 QP	43.50	-9.19	1.50 H	106	20.64	13.67
4	249.60	38.11 QP	46.00	-7.89	1.25 H	235	23.71	14.40
5	399.31	42.11 QP	46.00	-3.89	1.00 H	10	23.20	18.91
6	500.42	37.54 QP	46.00	-8.46	1.50 H	196	16.07	21.48
7	550.97	34.12 QP	46.00	-11.88	1.50 H	160	11.52	22.60
8	751.23	33.73 QP	46.00	-12.27	1.00 H	52	6.68	27.06
9	799.84	34.75 QP	46.00	-11.25	1.00 H	7	7.21	27.54
10	951.49	33.60 QP	46.00	-12.40	1.50 H	319	3.14	30.46
ANTENNA POLARITY & TEST DISTANCE: VERTICAL AT 3 M								
NO.	FREQ. (MHz)	EMISSION LEVEL (dBuV/m)	LIMIT (dBuV/m)	MARGIN (dB)	ANTENNA HEIGHT (m)	TABLE ANGLE (Degree)	RAW VALUE (dBuV)	CORRECTION FACTOR (dB/m)
1	55.18	30.64 QP	40.00	-9.36	1.25 V	181	17.30	13.34
2	97.95	33.96 QP	43.50	-9.54	1.00 V	241	22.74	11.22
3	399.31	38.91 QP	46.00	-7.09	1.00 V	307	20.00	18.91
4	500.42	37.05 QP	46.00	-8.95	1.00 V	52	15.57	21.48
5	751.23	33.14 QP	46.00	-12.86	1.25 V	10	6.08	27.06
6	799.84	34.56 QP	46.00	-11.44	1.50 V	304	7.02	27.54
7	875.67	33.50 QP	46.00	-12.50	1.00 V	352	4.17	29.33
8	951.49	34.44 QP	46.00	-11.56	1.00 V	73	3.98	30.46

- REMARKS:**
1. Emission level (dBuV/m) = Raw Value (dBuV) + Correction Factor (dB/m).
 2. Correction Factor (dB/m) = Antenna Factor (dB/m) + Cable Factor (dB).
 3. The other emission levels were very low against the limit.
 4. Margin value = Emission level – Limit value.



A D T

EUT TEST CONDITION		MEASUREMENT DETAIL	
CHANNEL	Channel 165	FREQUENCY RANGE	Below 1000MHz
INPUT POWER (SYSTEM)	120Vac, 60 Hz	DETECTOR FUNCTION	Quasi-Peak
ENVIRONMENTAL CONDITIONS	24deg. C, 64%RH 999hPa	TEST MODE	B
TESTED BY	Match Tsui		

ANTENNA POLARITY & TEST DISTANCE: HORIZONTAL AT 3 M								
NO.	FREQ. (MHz)	EMISSION LEVEL (dBuV/m)	LIMIT (dBuV/m)	MARGIN (dB)	ANTENNA HEIGHT (m)	TABLE ANGLE (Degree)	RAW VALUE (dBuV)	CORRECTION FACTOR (dB/m)
1	101.84	33.03 QP	43.50	-10.47	2.00 H	337	21.07	11.96
2	160.17	38.35 QP	43.50	-5.15	2.00 H	94	23.52	14.83
3	173.78	39.75 QP	43.50	-3.75	2.00 H	70	25.74	14.01
4	249.60	38.46 QP	46.00	-7.54	1.00 H	256	24.06	14.40
5	399.31	41.13 QP	46.00	-4.87	1.00 H	151	22.22	18.91
6	599.58	39.29 QP	46.00	-6.71	1.25 H	247	15.64	23.65
7	751.23	35.22 QP	46.00	-10.78	1.00 H	10	8.16	27.06
8	799.84	36.82 QP	46.00	-9.18	1.00 H	10	9.28	27.54
9	875.67	36.58 QP	46.00	-9.42	1.50 H	16	7.25	29.33
ANTENNA POLARITY & TEST DISTANCE: VERTICAL AT 3 M								
NO.	FREQ. (MHz)	EMISSION LEVEL (dBuV/m)	LIMIT (dBuV/m)	MARGIN (dB)	ANTENNA HEIGHT (m)	TABLE ANGLE (Degree)	RAW VALUE (dBuV)	CORRECTION FACTOR (dB/m)
1	55.18	34.26 QP	40.00	-5.74	1.50 V	172	20.92	13.34
2	68.79	32.49 QP	40.00	-7.51	1.50 V	142	18.91	13.58
3	101.84	39.22 QP	43.50	-4.28	1.50 V	259	27.26	11.96
4	158.22	33.49 QP	43.50	-10.01	1.50 V	235	18.70	14.78
5	399.31	38.58 QP	46.00	-7.42	1.25 V	34	19.67	18.91
6	751.23	35.88 QP	46.00	-10.12	1.50 V	340	8.82	27.06
7	951.49	35.17 QP	46.00	-10.83	1.00 V	115	4.71	30.46

- REMARKS:**
1. Emission level (dBuV/m) = Raw Value (dBuV) + Correction Factor (dB/m).
 2. Correction Factor (dB/m) = Antenna Factor (dB/m) + Cable Factor (dB).
 3. The other emission levels were very low against the limit.
 4. Margin value = Emission level – Limit value.



5.2 CONDUCTED EMISSION MEASUREMENT

5.2.1 LIMITS OF CONDUCTED EMISSION MEASUREMENT

FREQUENCY OF EMISSION (MHz)	CONDUCTED LIMIT (dB μ V)	
	Quasi-peak	Average
0.15 ~ 0.5	66 to 56	56 to 46
0.5 ~ 5	56	46
5 ~ 30	60	50

- NOTE:** 1. The lower limit shall apply at the transition frequencies.
2. The limit decreases in line with the logarithm of the frequency in the range of 0.15 to 0.50MHz.
3. All emanations from a class A/B digital device or system, including any network of conductors and apparatus connected thereto, shall not exceed the level of field strengths specified above.

5.2.2 TEST INSTRUMENTS

DESCRIPTION & MANUFACTURER	MODEL NO.	SERIAL NO.	DATE OF CALIBRATION	DUE DATE OF CALIBRATION
Test Receiver ROHDE & SCHWARZ	ESCS30	100291	Nov. 19, 2008	Nov. 18, 2009
RF signal cable Woken	5D-FB	Cable-HYC01-01	Jan. 04, 2008	Jan. 03, 2009
LISN ROHDE & SCHWARZ	ESH3-Z5	100312	Jun. 13, 2008	Jun. 12, 2009
V-LISN SCHWARZBECK	NNBL 8226-2	8226-142	Jun. 10, 2008	Jun. 09, 2009
Software ADT	ADT_Cond_V3	NA	NA	NA

- NOTE:** 1. The calibration interval of the above test instruments is 12 months and the calibrations are traceable to NML/ROC and NIST/USA.
2. The test was performed in HwaYa Shielded Room 1.
3. The VCCI Site Registration No. is C-2040.



A D T

5.2.3 TEST PROCEDURES

- a. The EUT was placed 0.4 meters from the conducting wall of the shielded room with EUT being connected to the power mains through a line impedance stabilization network (LISN). Other support units were connected to the power mains through another LISN. The two LISNs provide 50 ohm/ 50uH of coupling impedance for the measuring instrument.
- b. Both lines of the power mains connected to the EUT were checked for maximum conducted interference.
- c. The frequency range from 150kHz to 30MHz was searched. Emission levels under (Limit - 20dB) was not recorded.

5.2.4 DEVIATION FROM TEST STANDARD

No deviation.

5.2.5 TEST SETUP

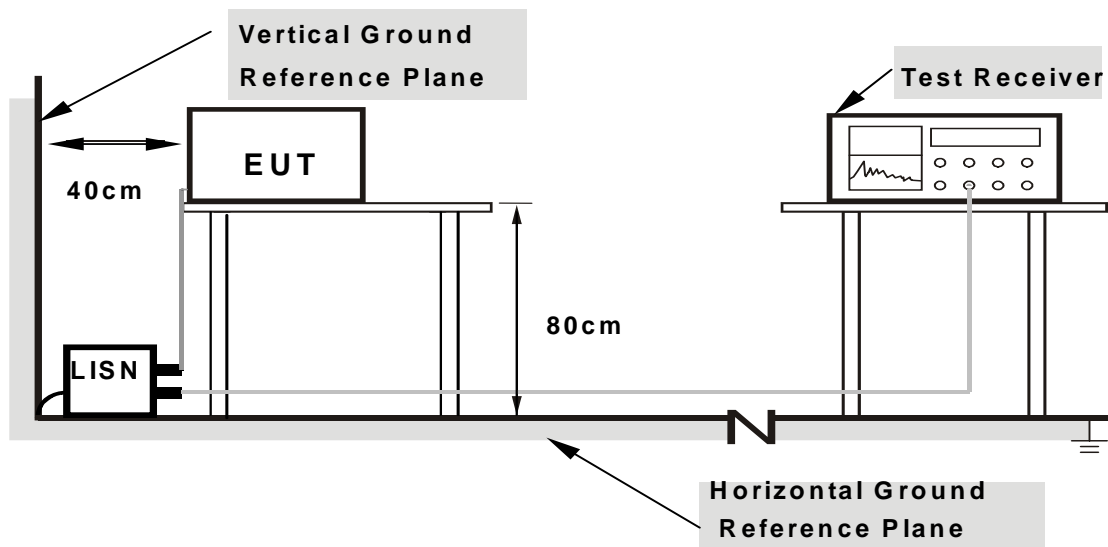

Note: 1. Support units were connected to second LISN.

2. Both of LISNs (AMN) are 80 cm from EUT and at least 80 from other units and other metal planes

For the actual test configuration, please refer to the attached file (Test Setup Photo).

5.2.6 EUT OPERATING CONDITIONS

Same as 4.1.6



A D T

5.2.7 TEST RESULTS

CONDUCTED WORST-CASE DATA : 802.11a OFDM MODULATION

EUT TEST CONDITION		MEASUREMENT DETAIL	
CHANNEL	Channel 165	PHASE	Line 1
MODULATION TYPE	BPSK	INPUT POWER	120Vac, 60Hz
TRANSFER RATE	6Mbps	6dB BANDWIDTH	9kHz
ENVIRONMENTAL CONDITIONS	22deg. C, 60%RH, 1021hPa	TEST MODE	A
TESTED BY	Kevin Liang		

No	Freq. [MHz]	Corr. Factor [dB]	Reading Value [dB (uV)]		Emission Level [dB (uV)]		Limit [dB (uV)]		Margin (dB)	
			Q.P.	AV.	Q.P.	AV.	Q.P.	AV.	Q.P.	AV.
			1	0.179	0.20	44.19	-	44.39	-	64.55
2	0.232	0.20	37.07	-	37.27	-	62.38	52.38	-25.11	-
3	0.505	0.20	38.21	-	38.41	-	56.00	46.00	-17.59	-
4	0.845	0.20	32.36	-	32.56	-	56.00	46.00	-23.44	-
5	2.582	0.26	35.10	-	35.36	-	56.00	46.00	-20.64	-
6	19.051	0.97	35.46	-	36.43	-	60.00	50.00	-23.57	-

- REMARKS:**
1. Q.P. and AV. are abbreviations of quasi-peak and average individually.
 2. "-": The Quasi-peak reading value also meets average limit and measurement with the average detector is unnecessary.
 3. The emission levels of other frequencies were very low against the limit.
 4. Margin value = Emission level - Limit value
 5. Correction factor = Insertion loss + Cable loss
 6. Emission Level = Correction Factor + Reading Value.

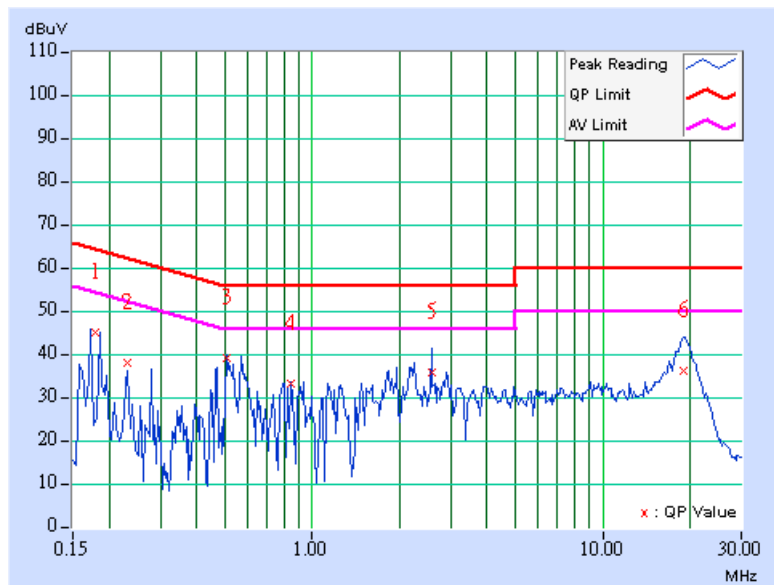



A D T

EUT TEST CONDITION		MEASUREMENT DETAIL	
CHANNEL	Channel 165	PHASE	Line 2
MODULATION TYPE	BPSK	INPUT POWER	120Vac, 60Hz
TRANSFER RATE	6Mbps	6dB BANDWIDTH	9kHz
ENVIRONMENTAL CONDITIONS	22deg. C, 60%RH, 1021hPa	TEST MODE	A
TESTED BY	Kevin Liang		

No	Freq. [MHz]	Corr. Factor (dB)	Reading Value [dB (uV)]		Emission Level [dB (uV)]		Limit [dB (uV)]		Margin (dB)	
			Q.P.	AV.	Q.P.	AV.	Q.P.	AV.	Q.P.	AV.
1	0.170	0.20	48.69	-	48.89	-	64.98	54.98	-16.09	-
2	0.228	0.20	40.88	-	41.08	-	62.52	52.52	-21.44	-
3	0.502	0.20	37.77	-	37.97	-	56.00	46.00	-18.03	-
4	0.584	0.20	36.41	-	36.61	-	56.00	46.00	-19.39	-
5	2.566	0.26	36.21	-	36.47	-	56.00	46.00	-19.53	-
6	18.980	0.51	36.39	-	36.90	-	60.00	50.00	-23.10	-

- REMARKS:**
1. Q.P. and AV. are abbreviations of quasi-peak and average individually.
 2. "-": The Quasi-peak reading value also meets average limit and measurement with the average detector is unnecessary.
 3. The emission levels of other frequencies were very low against the limit.
 4. Margin value = Emission level - Limit value
 5. Correction factor = Insertion loss + Cable loss
 6. Emission Level = Correction Factor + Reading Value.

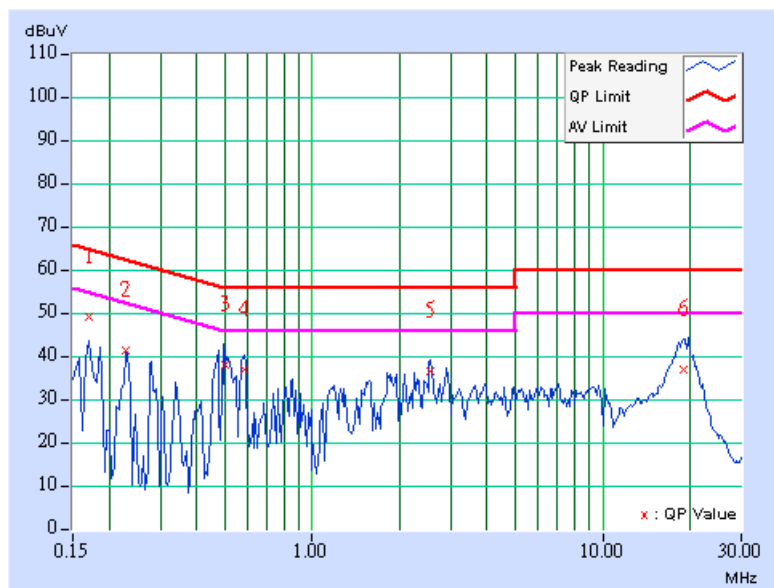

EUT TEST CONDITION		MEASUREMENT DETAIL	
CHANNEL	Channel 165	PHASE	Line 1
MODULATION TYPE	BPSK	INPUT POWER	120Vac, 60Hz
TRANSFER RATE	6Mbps	6dB BANDWIDTH	9kHz
ENVIRONMENTAL CONDITIONS	22deg. C, 60%RH, 1021hPa	TEST MODE	B
TESTED BY	Kevin Liang		

No	Freq. [MHz]	Corr. Factor (dB)	Reading Value [dB (uV)]		Emission Level [dB (uV)]		Limit [dB (uV)]		Margin (dB)	
			Q.P.	AV.	Q.P.	AV.	Q.P.	AV.	Q.P.	AV.
1	0.353	0.20	42.07	-	42.27	-	58.89	48.89	-16.62	-
2	0.646	0.20	42.05	-	42.25	-	56.00	46.00	-13.75	-
3	3.535	0.35	37.76	-	38.11	-	56.00	46.00	-17.89	-
4	4.711	0.42	39.96	-	40.38	-	56.00	46.00	-15.62	-
5	9.738	0.52	47.39	-	47.91	-	60.00	50.00	-12.09	-
6	17.563	0.91	47.94	-	48.85	-	60.00	50.00	-11.15	-

- REMARKS:**
1. Q.P. and AV. are abbreviations of quasi-peak and average individually.
 2. "-": The Quasi-peak reading value also meets average limit and measurement with the average detector is unnecessary.
 3. The emission levels of other frequencies were very low against the limit.
 4. Margin value = Emission level - Limit value
 5. Correction factor = Insertion loss + Cable loss
 6. Emission Level = Correction Factor + Reading Value.

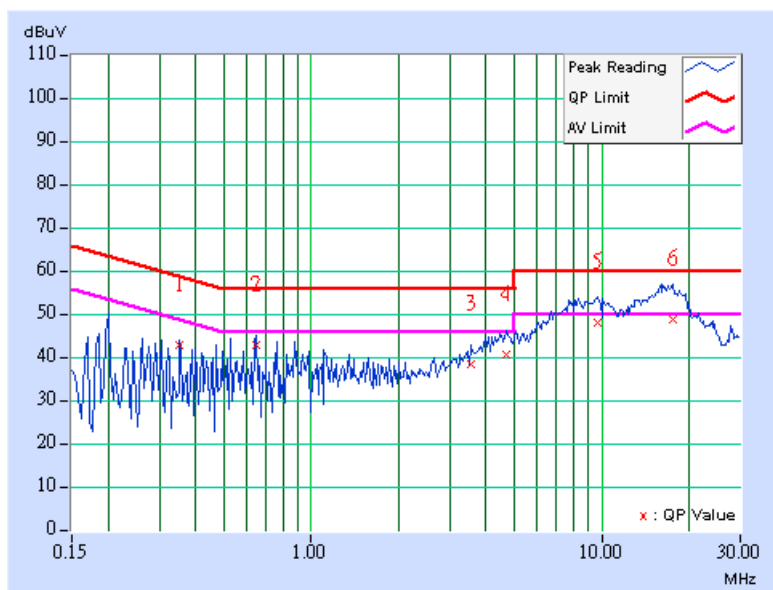



A D T

EUT TEST CONDITION		MEASUREMENT DETAIL	
CHANNEL	Channel 165	PHASE	Line 2
MODULATION TYPE	BPSK	INPUT POWER	120Vac, 60Hz
TRANSFER RATE	6Mbps	6dB BANDWIDTH	9kHz
ENVIRONMENTAL CONDITIONS	22deg. C, 60%RH, 1021hPa	TEST MODE	B
TESTED BY	Kevin Liang		

No	Freq. [MHz]	Corr. Factor (dB)	Reading Value [dB (uV)]		Emission Level [dB (uV)]		Limit [dB (uV)]		Margin (dB)	
			Q.P.	AV.	Q.P.	AV.	Q.P.	AV.	Q.P.	AV.
1	0.413	0.20	43.41	-	43.61	-	57.60	47.60	-13.99	-
2	0.648	0.20	42.19	-	42.39	-	56.00	46.00	-13.61	-
3	2.804	0.28	36.57	-	36.85	-	56.00	46.00	-19.15	-
4	5.580	0.43	40.82	-	41.25	-	60.00	50.00	-18.75	-
5	8.270	0.49	48.14	-	48.63	-	60.00	50.00	-11.37	-
6	17.299	0.50	51.51	38.87	52.01	39.37	60.00	50.00	-7.99	-10.63

- REMARKS:**
1. Q.P. and AV. are abbreviations of quasi-peak and average individually.
 2. "-": The Quasi-peak reading value also meets average limit and measurement with the average detector is unnecessary.
 3. The emission levels of other frequencies were very low against the limit.
 4. Margin value = Emission level - Limit value
 5. Correction factor = Insertion loss + Cable loss
 6. Emission Level = Correction Factor + Reading Value.

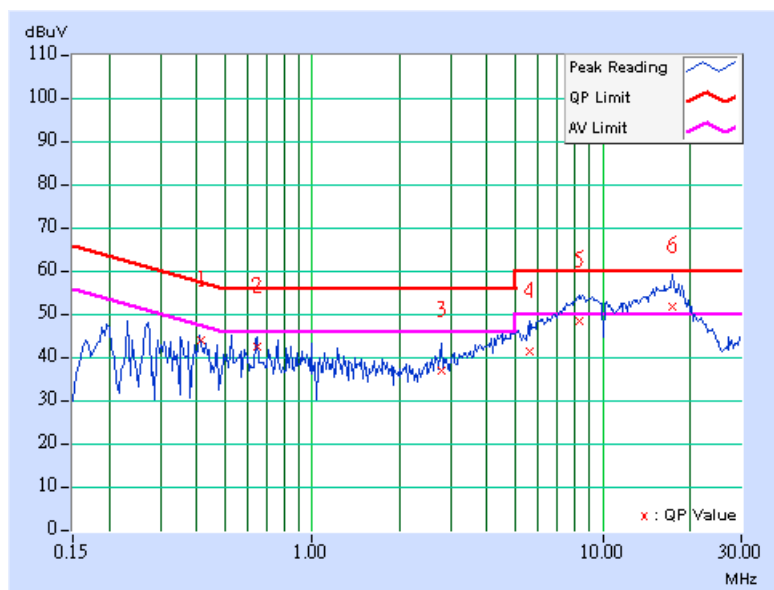



5.3 6dB BANDWIDTH MEASUREMENT

5.3.1 LIMITS OF 6dB BANDWIDTH MEASUREMENT

The minimum of 6dB Bandwidth Measurement is 0.5MHz.

5.3.2 TEST INSTRUMENTS

DESCRIPTION & MANUFACTURER	MODEL NO.	SERIAL NO.	DATE OF CALIBRATION	CALIBRATED UNTIL
R&S SPECTRUM ANALYZER	FSP40	100041	Apr. 22, 2008	Apr. 21, 2009

NOTE: The calibration interval of the above test instruments is 12 months and the calibrations are traceable to NML/ROC and NIST/USA.

5.3.3 TEST PROCEDURE

The transmitter output was connected to the spectrum analyzer through an attenuator. The bandwidth of the fundamental frequency was measured by spectrum analyzer with 100kHz RBW and 300kHz VBW. The 6dB bandwidth is defined as the total spectrum the power of which is higher than peak power minus 6dB.

5.3.4 DEVIATION FROM TEST STANDARD

No deviation

5.3.5 TEST SETUP

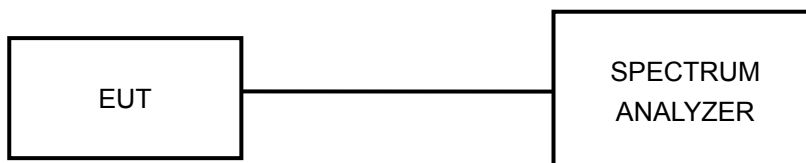

5.3.6 EUT OPERATING CONDITIONS

The software provided by client to enable the EUT under transmission condition continuously at lowest, middle and highest channel frequencies individually.



A D T

5.3.7 TEST RESULTS

802.11a OFDM MODULATION

MODULATION TYPE	BPSK	TRANSFER RATE	6.0Mbps
INPUT POWER	120Vac, 60Hz	ENVIRONMENTAL CONDITIONS	24 deg.C, 64%RH, 1021hPa
TESTED BY	Match Tsui		

CHANNEL	CHANNEL FREQUENCY (MHz)	6dB BANDWIDTH (MHz)		MINIMUM LIMIT (MHz)	PASS / FAIL
		CHAIN 0	CHAIN 1		
149	5745	16.39	16.42	0.5	PASS
157	5785	16.41	16.41	0.5	PASS
165	5825	16.40	16.44	0.5	PASS



A D T

FOR CHAIN 0: CH 149

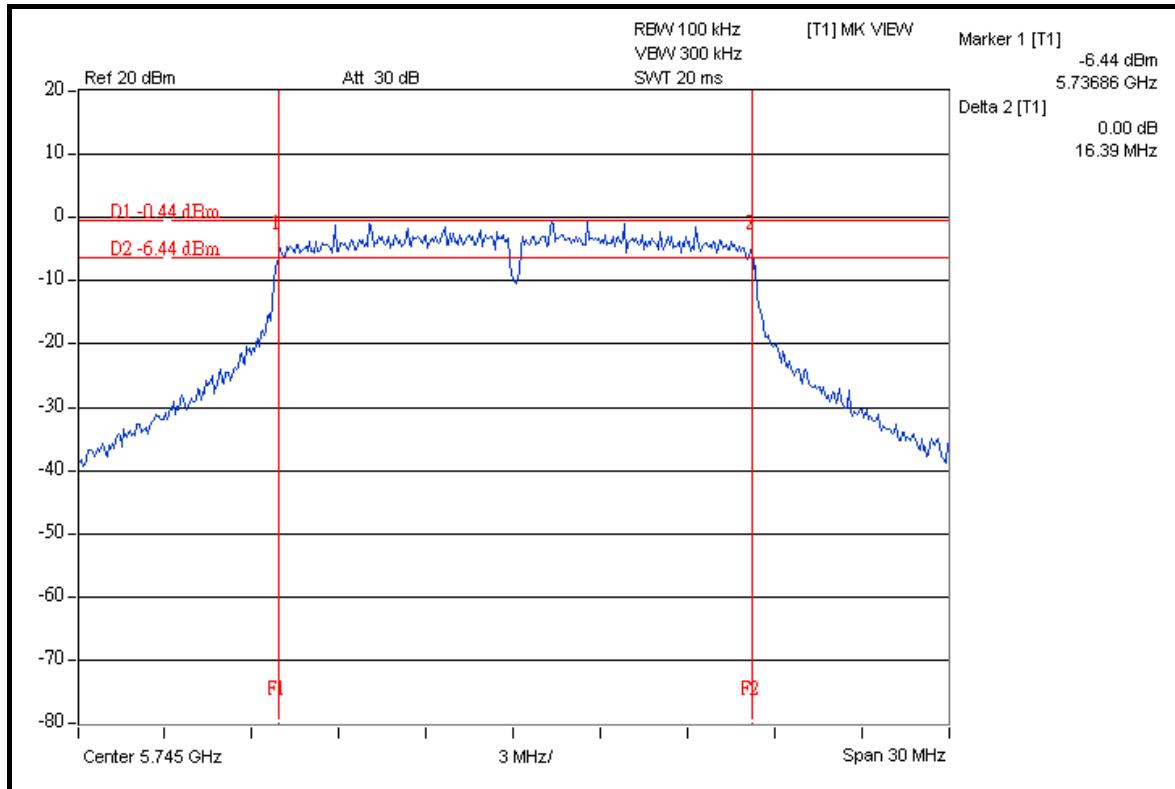

CH 157

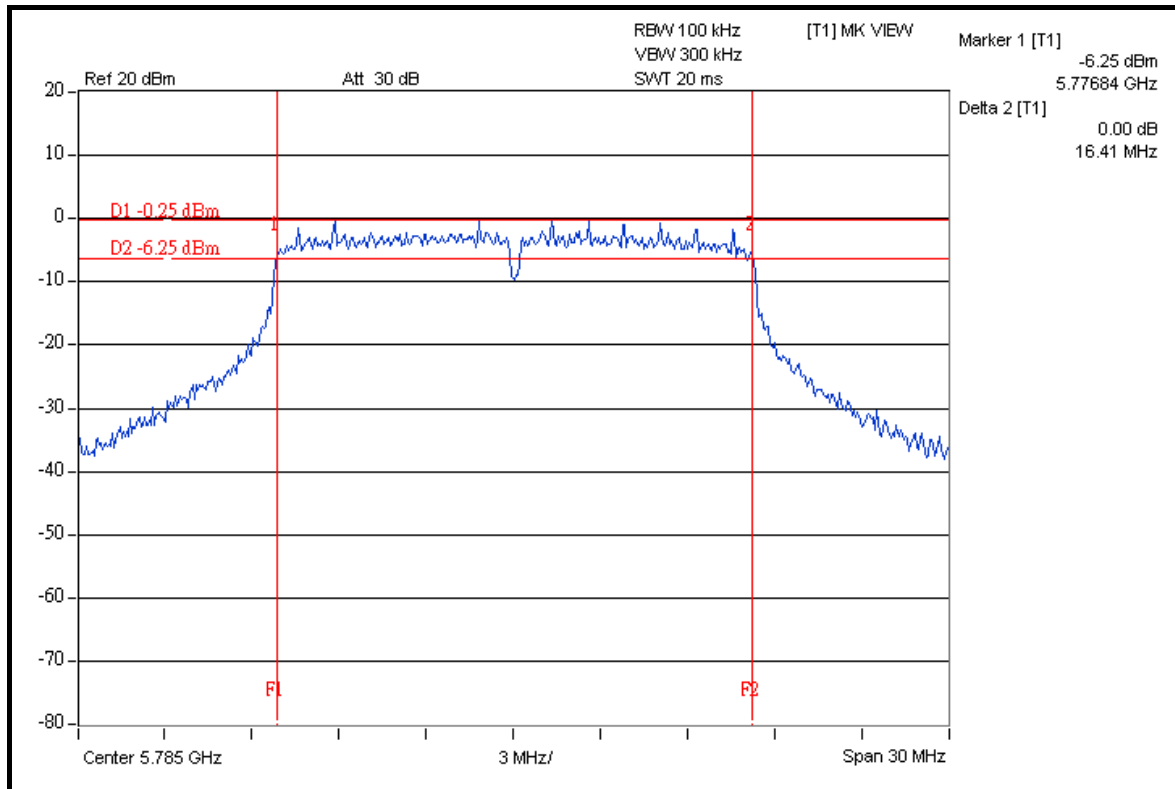



A D T

CH 165

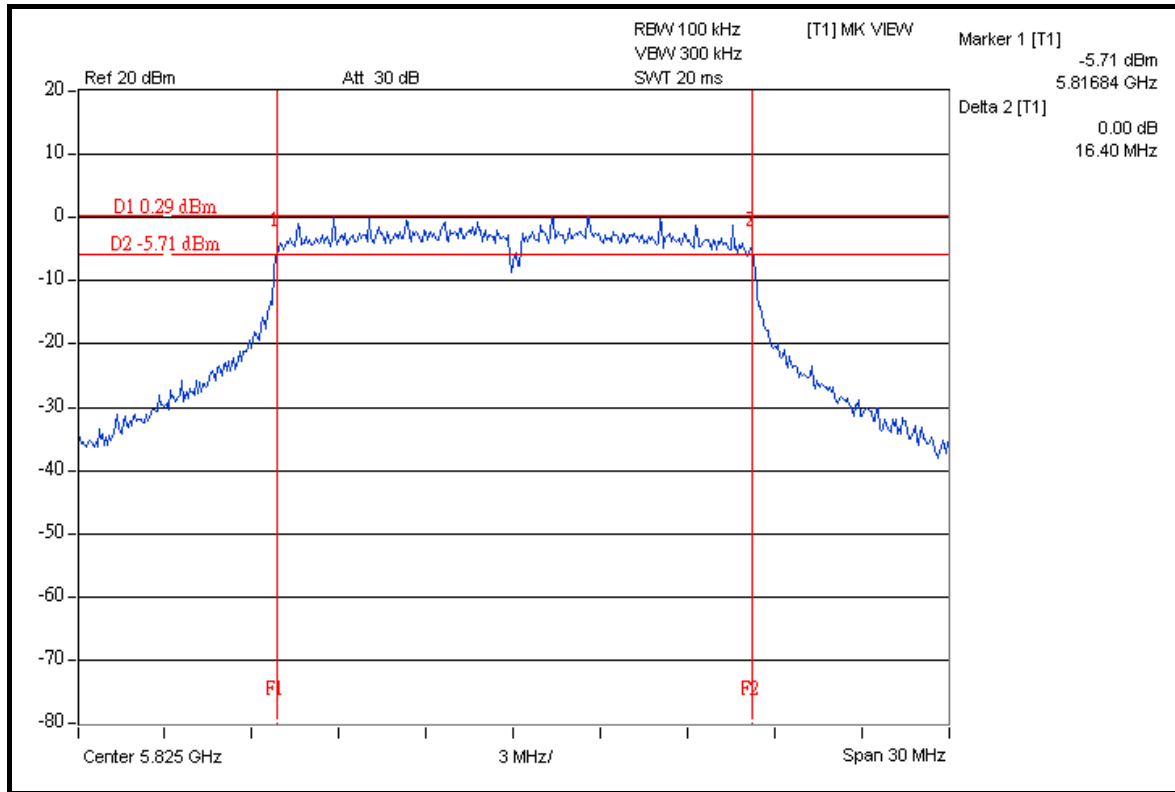

FOR CHAIN 1: CH 149

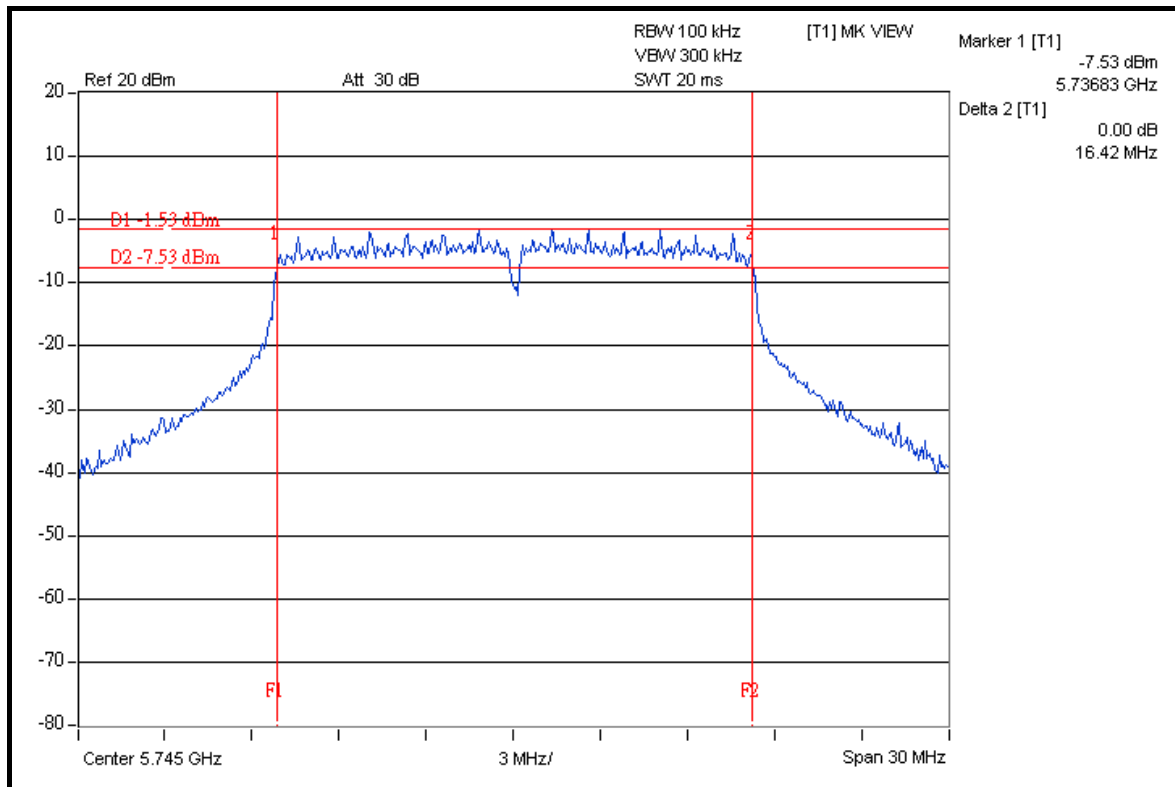



A D T

CH 157

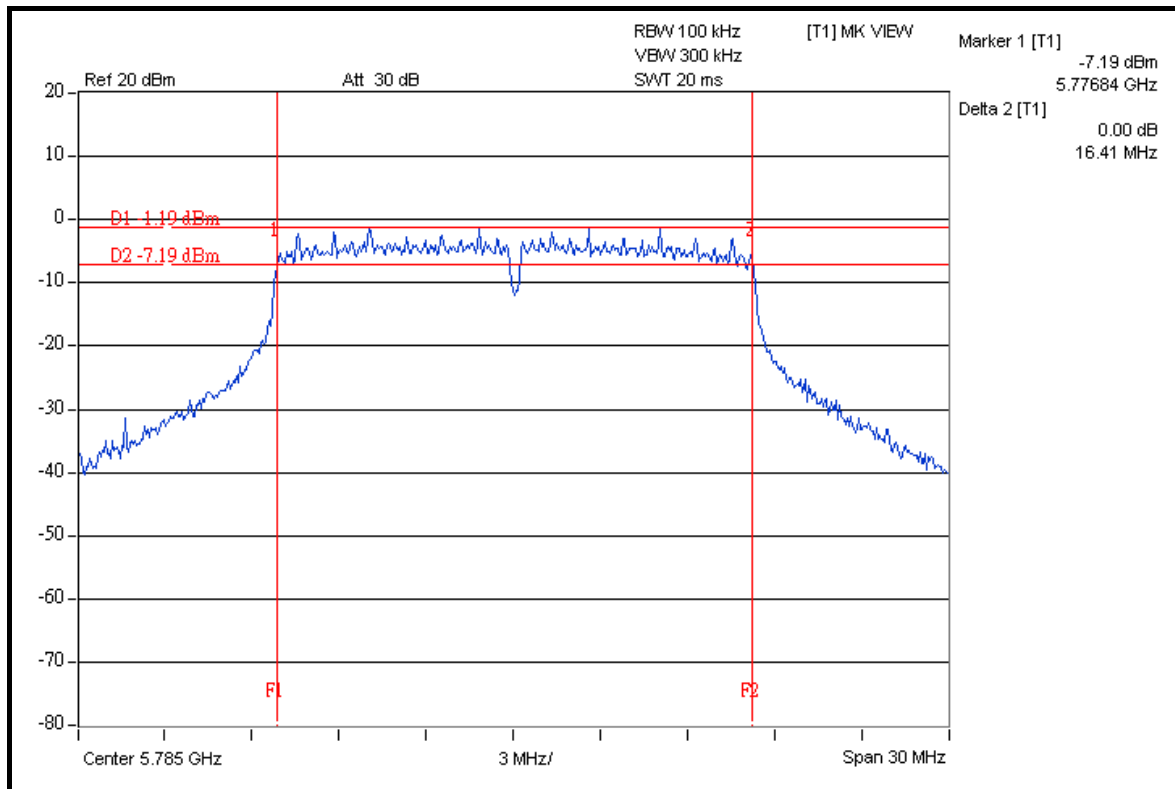

CH 165

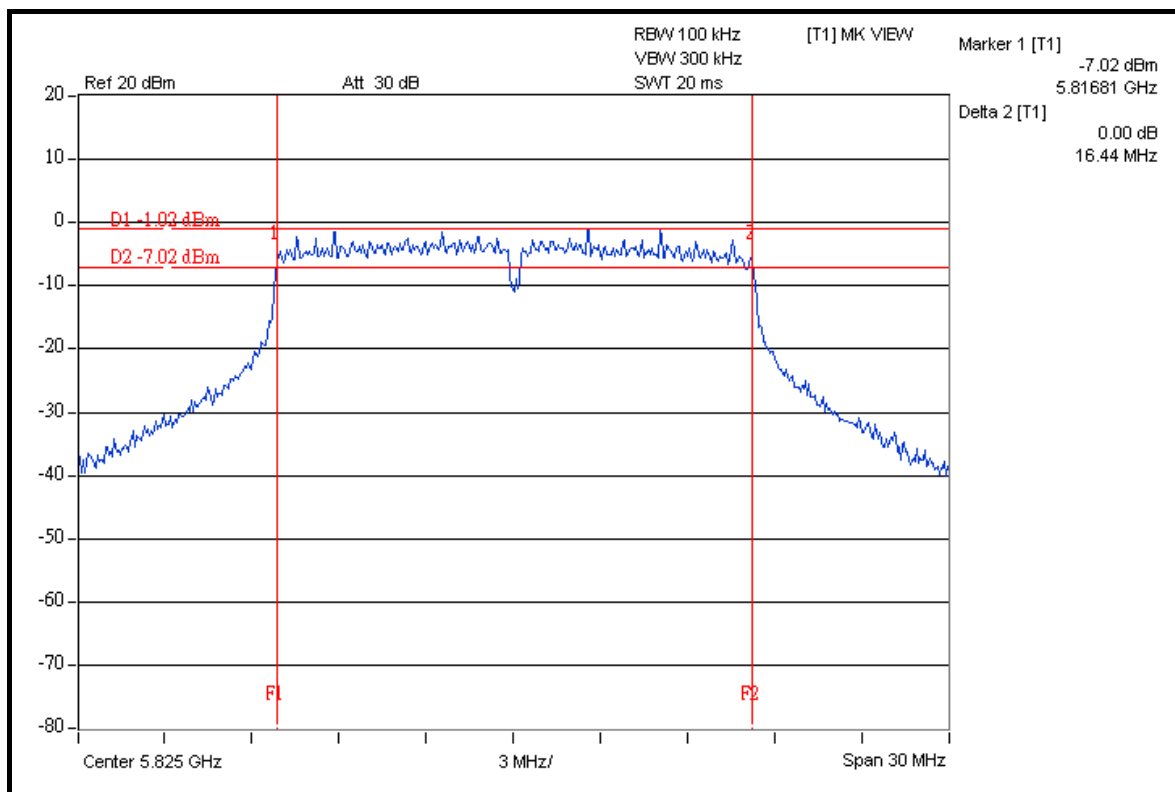



A D T

DRAFT 802.11n (20MHz) OFDM MODULATION

MODULATION TYPE	BPSK	TRANSFER RATE	7.2Mbps
INPUT POWER	120Vac, 60Hz	ENVIRONMENTAL CONDITIONS	24 deg.C, 64%RH, 1021hPa
TESTED BY	Match Tsui		

CHANNEL	CHANNEL FREQUENCY (MHz)	6dB BANDWIDTH (MHz)		MINIMUM LIMIT (MHz)	PASS / FAIL
		CHAIN 0	CHAIN 1		
149	5745	16.39	17.67	0.5	PASS
157	5785	16.41	17.63	0.5	PASS
165	5825	16.40	17.64	0.5	PASS



A D T

FOR CHAIN 0: CH 149

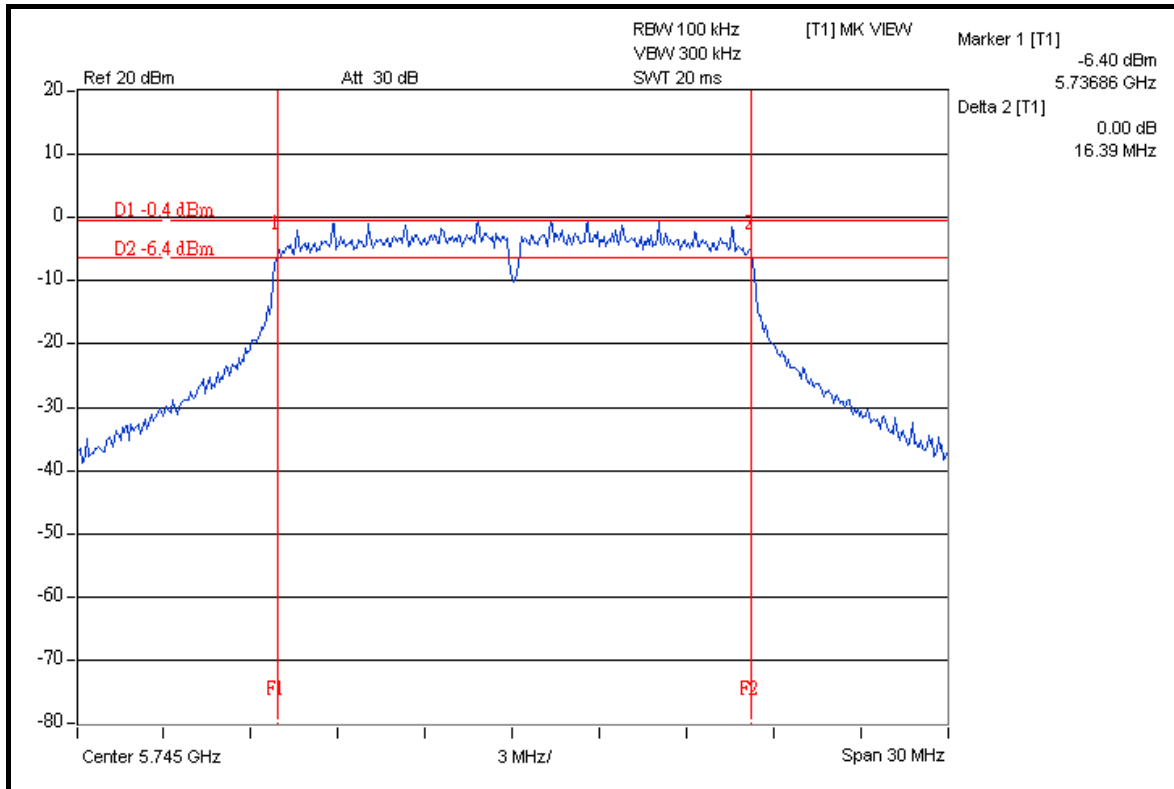

CH 157

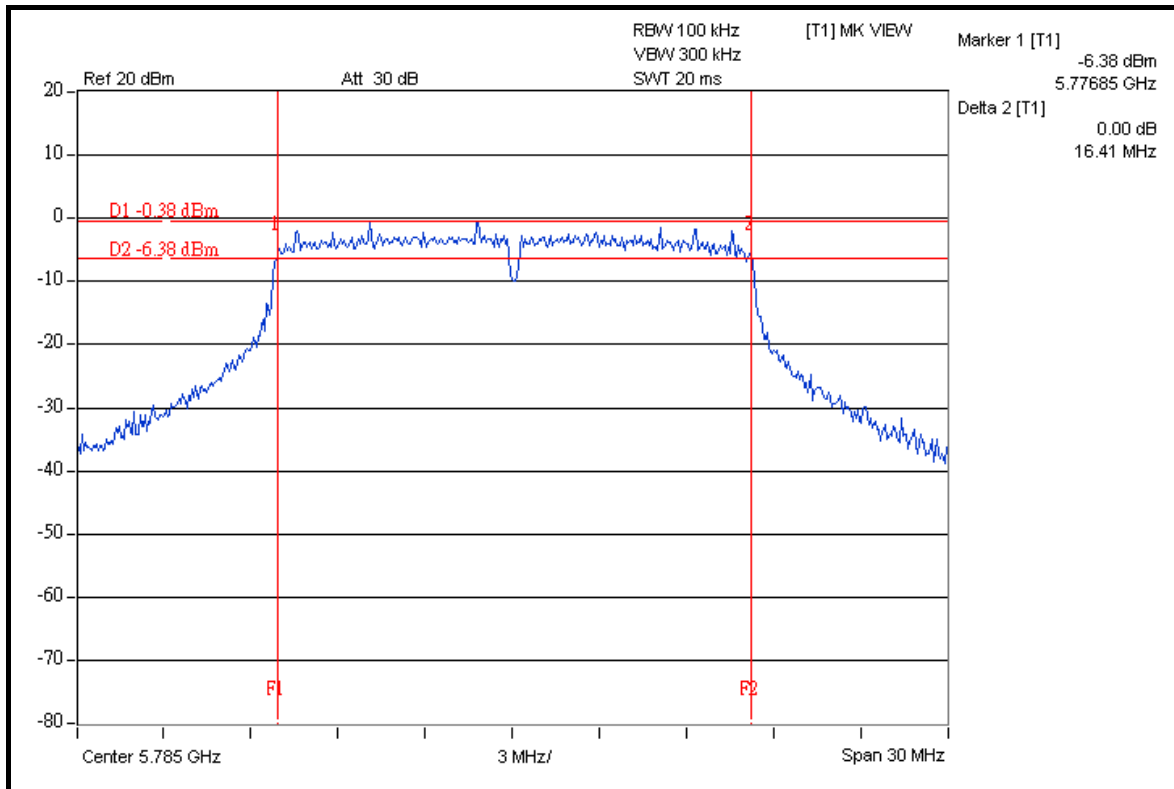



A D T

CH 165

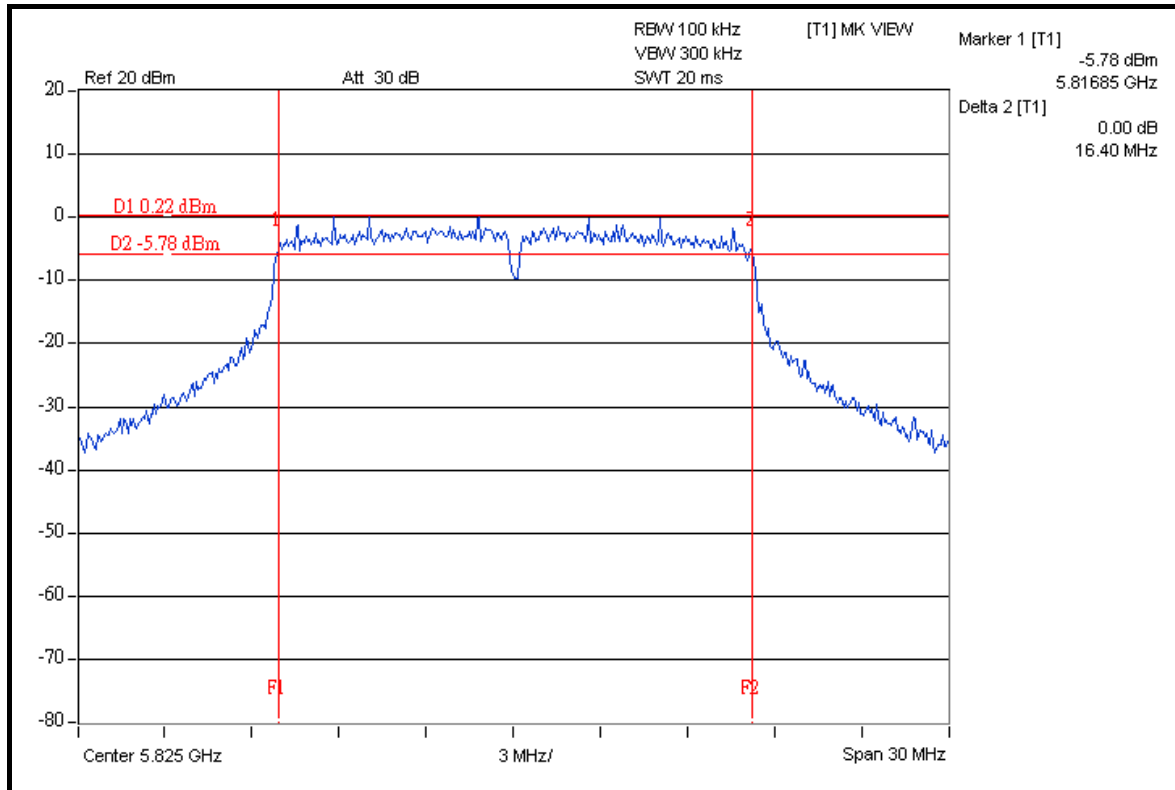

FOR CHAIN 1: CH 149

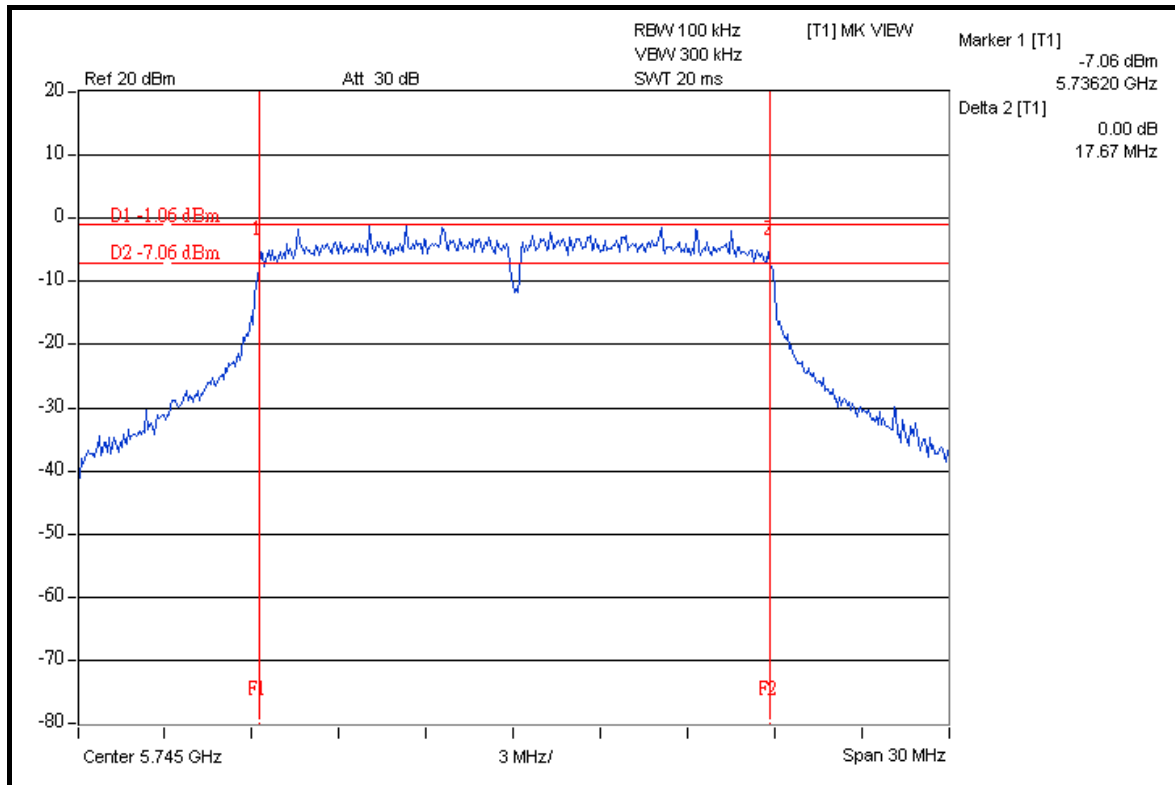



A D T

CH 157

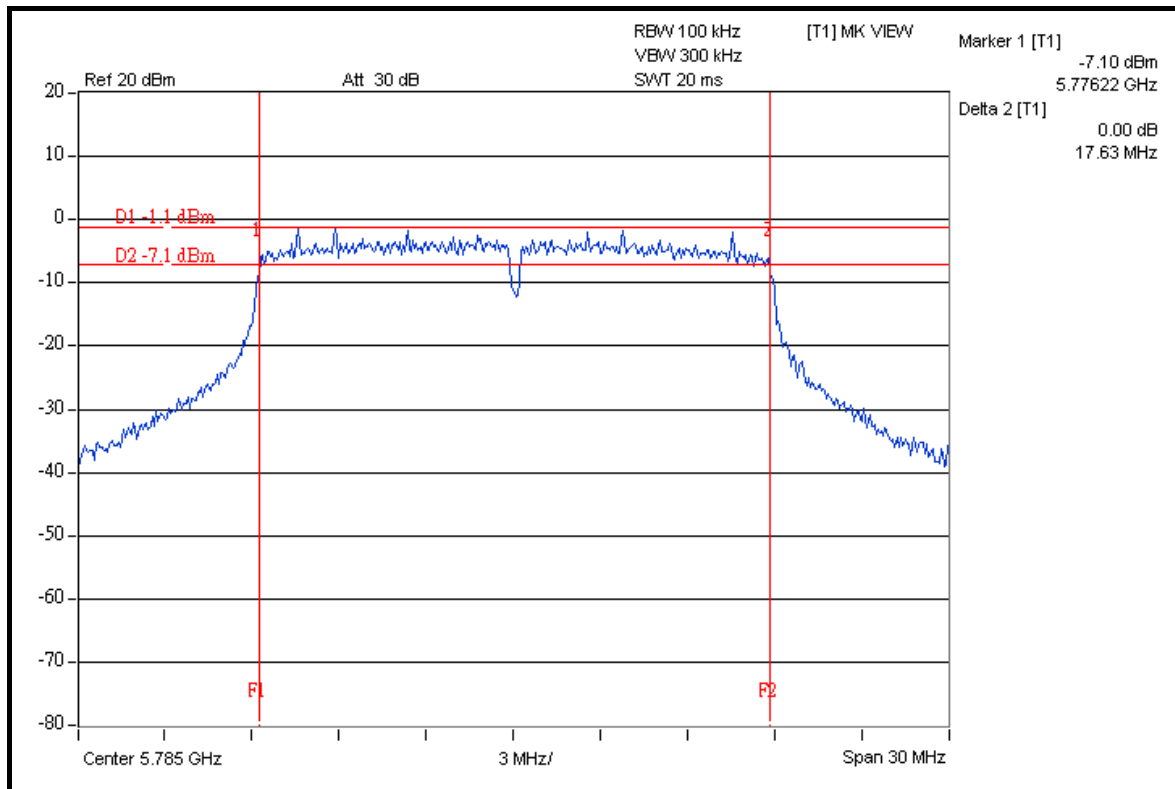

CH 165

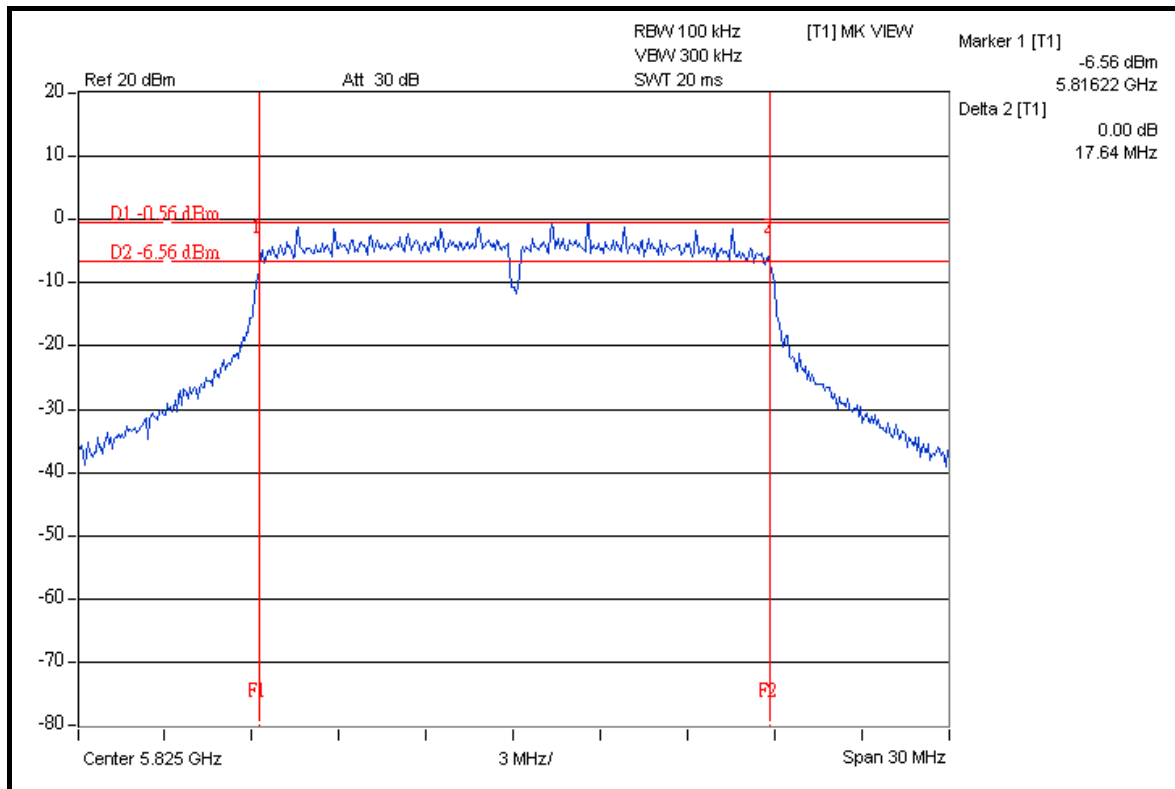



A D T

DRAFT 802.11n (40MHz) OFDM MODULATION

MODULATION TYPE	BPSK	TRANSFER RATE	15.0Mbps
INPUT POWER	120Vac, 60Hz	ENVIRONMENTAL CONDITIONS	24 deg.C, 64%RH, 1021hPa
TESTED BY	Match Tsui		

CHANNEL	CHANNEL FREQUENCY (MHz)	6dB BANDWIDTH (MHz)		MINIMUM LIMIT (MHz)	PASS / FAIL
		CHAIN 0	CHAIN 1		
151	5755	36.50	36.49	0.5	PASS
159	5795	36.54	36.55	0.5	PASS



A D T

FOR CHAIN 0: CH 151

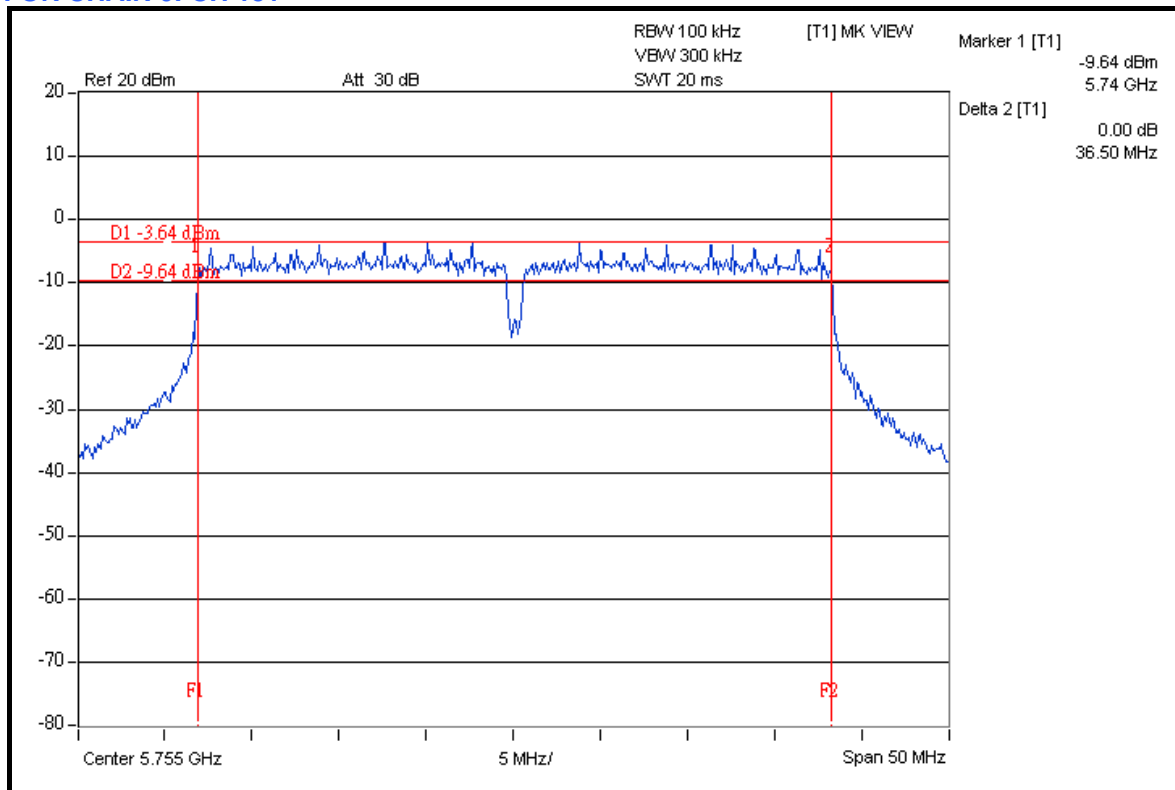

CH 159

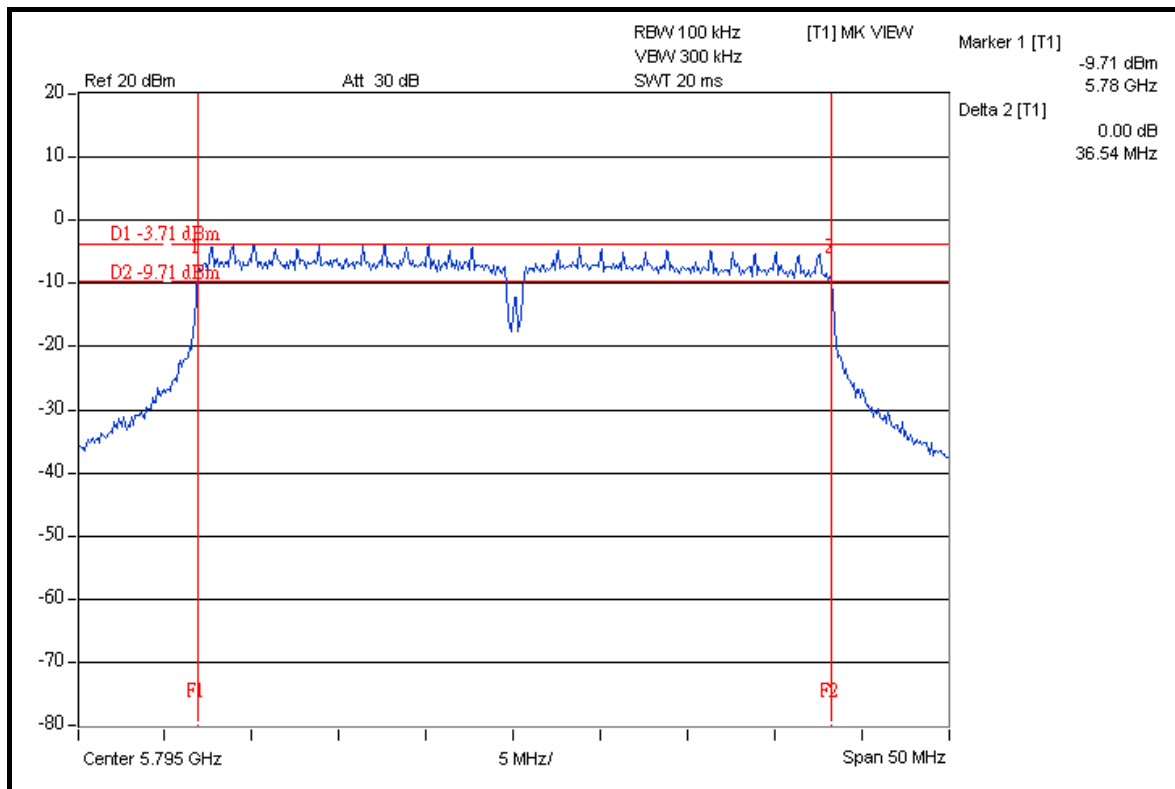



A D T

FOR CHAIN 1: CH 151

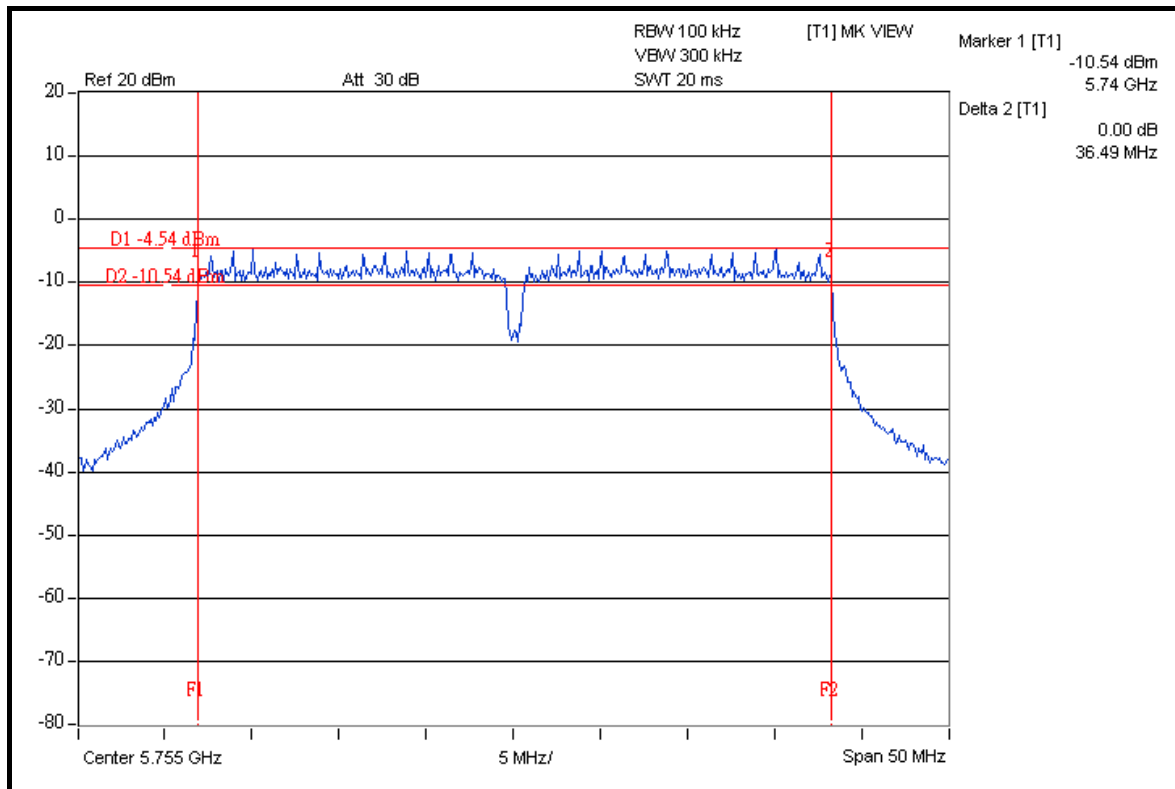

CH 159

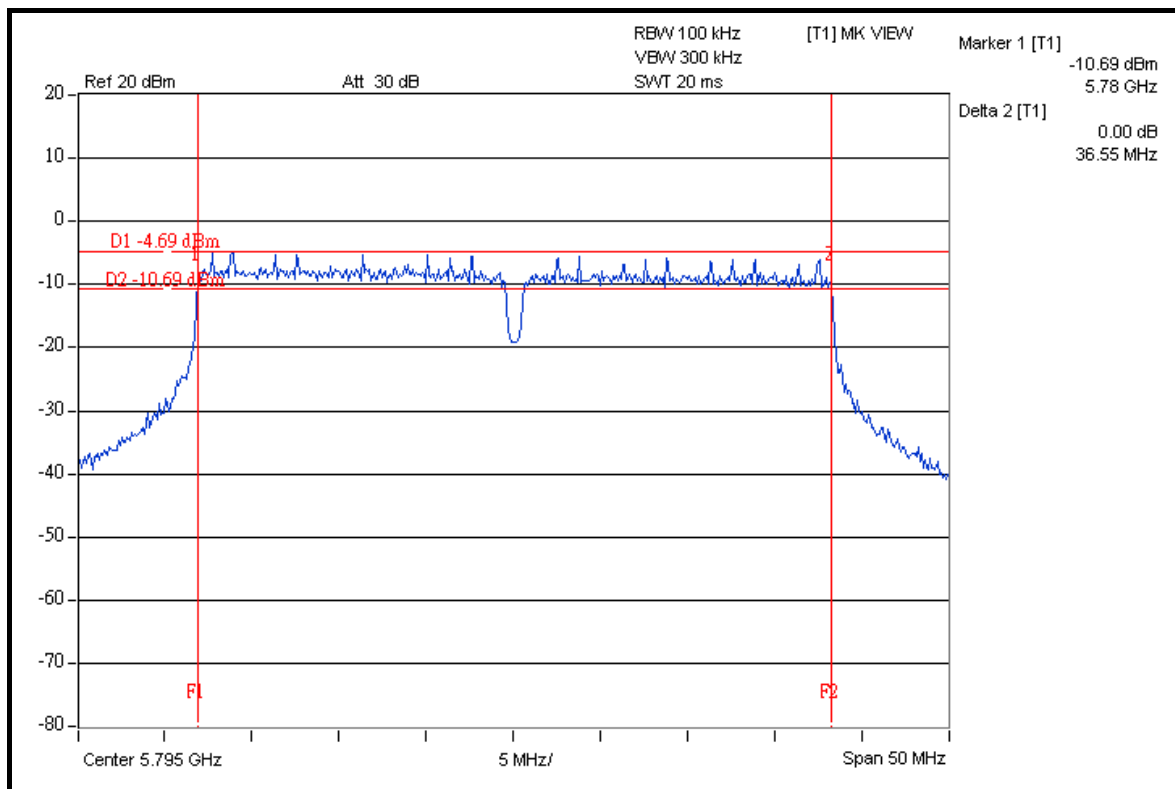



A D T

5.4 MAXIMUM PEAK OUTPUT POWER

5.4.1 LIMITS OF MAXIMUM PEAK OUTPUT POWER MEASUREMENT

The Maximum Peak Output Power Measurement is 30dBm.

5.4.2 INSTRUMENTS

DESCRIPTION & MANUFACTURER	MODEL NO.	SERIAL NO.	DATE OF CALIBRATION	CALIBRATED UNTIL
High Speed Peak Power Meter	ML2495A	0824012	Aug. 04, 2008	Aug. 03, 2009
Power Sensor	MA2444B	0738138	Aug. 04, 2008	Aug. 03, 2009

- Note:** 1. The calibration interval of the above test instruments is 12 months and the calibrations are traceable to NML/ROC and NIST/USA.
2. Measurement Bandwidth of ML2495A is 65MHz greater than 6dB bandwidth of emission.

5.4.3 TEST PROCEDURES

A power sensor was used on the output port of the EUT. A power meter was used to read the response of the power sensor. Record the power level.

5.4.4 DEVIATION FROM TEST STANDARD

No deviation.

5.4.5 TEST SETUP

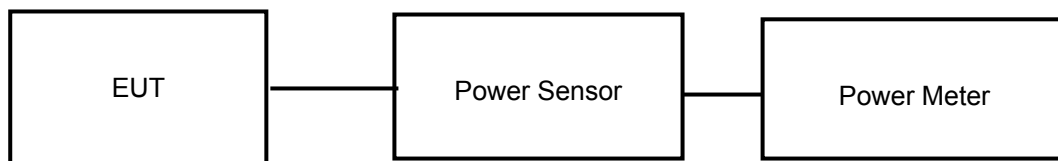

5.4.6 EUT OPERATING CONDITIONS

Same as Item 5.3.6



5.4.7 TEST RESULTS

802.11a OFDM MODULATION

MODULATION TYPE	BPSK	TRANSFER RATE	6.0Mbps
INPUT POWER	120Vac, 60Hz	ENVIRONMENTAL CONDITIONS	24 deg.C, 64%RH, 1021hPa
TESTED BY	Match Tsui		

CHAN.	CHAN. FREQ. (MHz)	PEAK POWER OUTPUT (dBm)		TOTAL PEAK POWER (mW)	TOTAL PEAK POWER (dBm)	PEAK POWER LIMIT (dBm)	PASS / FAIL
		CHAIN 0	CHAIN 1				
149	5745	22.03	21.09	288.117	24.60	30	PASS
157	5785	22.07	21.56	304.283	24.83	30	PASS
165	5825	22.52	21.53	320.882	25.06	30	PASS

DRAFT 802.11n (20MHz) OFDM MODULATION

MODULATION TYPE	BPSK	TRANSFER RATE	7.2Mbps
INPUT POWER	120Vac, 60Hz	ENVIRONMENTAL CONDITIONS	24 deg.C, 64%RH, 1021hPa
TESTED BY	Match Tsui		

CHAN.	CHAN. FREQ. (MHz)	PEAK POWER OUTPUT (dBm)		TOTAL PEAK POWER (mW)	TOTAL PEAK POWER (dBm)	PEAK POWER LIMIT (dBm)	PASS / FAIL
		CHAIN 0	CHAIN 1				
149	5745	21.53	20.08	244.092	23.88	30	PASS
157	5785	21.56	20.06	244.610	23.88	30	PASS
165	5825	22.03	20.53	272.568	24.35	30	PASS



A D T

DRAFT 802.11n (40MHz) OFDM MODULATION

MODULATION TYPE	BPSK	TRANSFER RATE	15.0Mbps
INPUT POWER	120Vac, 60Hz	ENVIRONMENTAL CONDITIONS	24 deg.C, 64%RH, 1021hPa
TESTED BY	Match Tsui		

CHAN.	CHAN. FREQ. (MHz)	PEAK POWER OUTPUT (dBm)		TOTAL PEAK POWER (mW)	TOTAL PEAK POWER (dBm)	PEAK POWER LIMIT (dBm)	PASS / FAIL
		CHAIN 0	CHAIN 1				
151	5755	22.08	21.07	289.374	24.61	30	PASS
159	5795	22.04	21.05	287.306	24.58	30	PASS



5.5 POWER SPECTRAL DENSITY MEASUREMENT

5.5.1 LIMITS OF POWER SPECTRAL DENSITY MEASUREMENT

The Maximum of Power Spectral Density Measurement is 8dBm.

5.5.2 TEST INSTRUMENTS

DESCRIPTION & MANUFACTURER	MODEL NO.	SERIAL NO.	DATE OF CALIBRATION	CALIBRATED UNTIL
R&S SPECTRUM ANALYZER	FSP40	100041	Apr. 22, 2008	Apr. 21, 2009

NOTE: The calibration interval of the above test instruments is 12 months and the calibrations are traceable to NML/ROC and NIST/USA.

5.5.3 TEST PROCEDURE

The transmitter output was connected to the spectrum analyzer through an attenuator, the bandwidth of the fundamental frequency was measured with the spectrum analyzer using 3kHz RBW and 30kHz VBW, set sweep time = span/3kHz. The power spectral density was measured and recorded.

The sweep time is allowed to be longer than span/3kHz for a full response of the mixer in the spectrum analyzer.

5.5.4 DEVIATION FROM TEST STANDARD

No deviation.

5.5.5 TEST SETUP

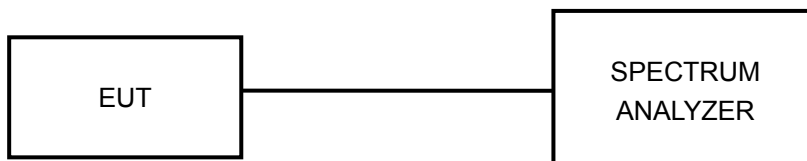

5.5.6 EUT OPERATING CONDITION

Same as Item 5.3.6.



A D T

5.5.7 TEST RESULTS

802.11a OFDM MODULATION

MODULATION TYPE	BPSK	TRANSFER RATE	6.0Mbps
INPUT POWER	120Vac, 60Hz	ENVIRONMENTAL CONDITIONS	24 deg.C, 64%RH, 1021hPa
TESTED BY	Match Tsui		

CHAN.	CHAN. FREQ. (MHz)	RF POWER LEVEL IN 3kHz BW (dBm)		TOTAL POWER DENSITY (mW)	TOTAL POWER DENSITY (dBm)	MAX. LIMIT (dBm)	PASS / FAIL
		CHAIN 0	CHAIN 1				
149	5745	-14.16	-15.33	0.068	-11.70	8	PASS
157	5785	-14.07	-14.67	0.073	-11.35	8	PASS
165	5825	-13.57	-14.68	0.078	-11.08	8	PASS



A D T

FOR CHAIN 0: CH 149

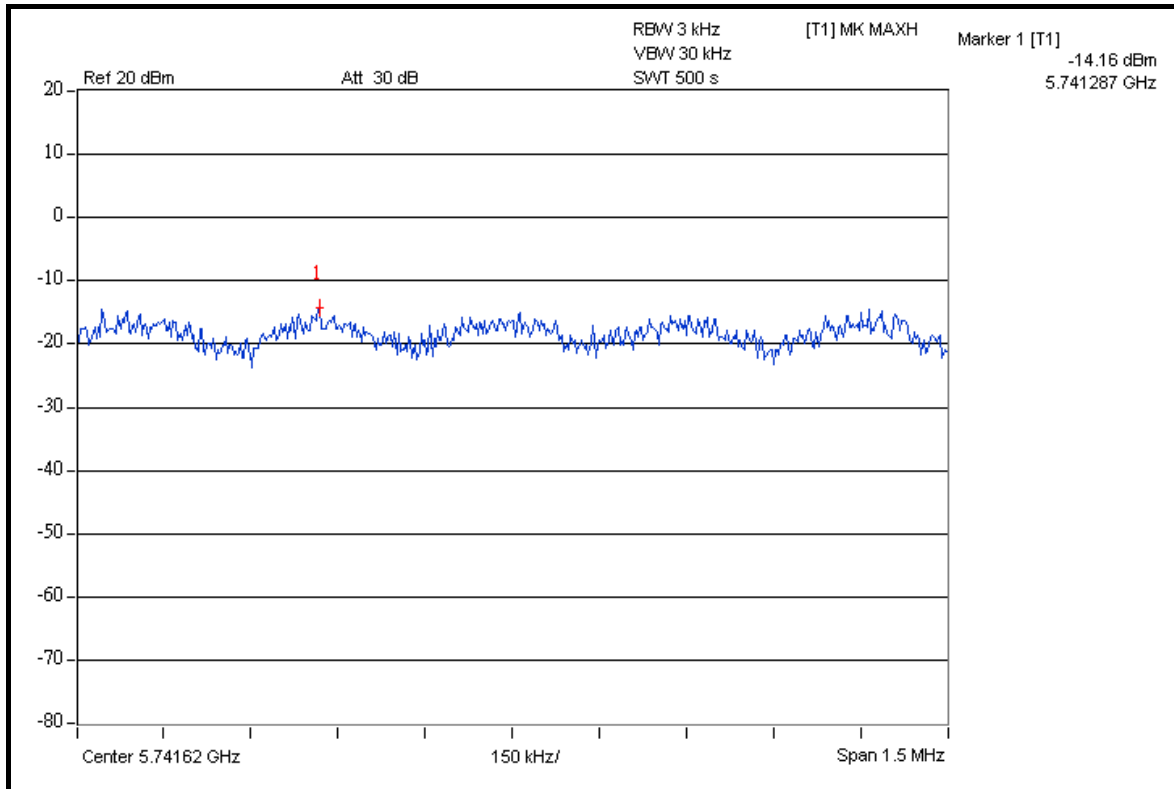

CH 157

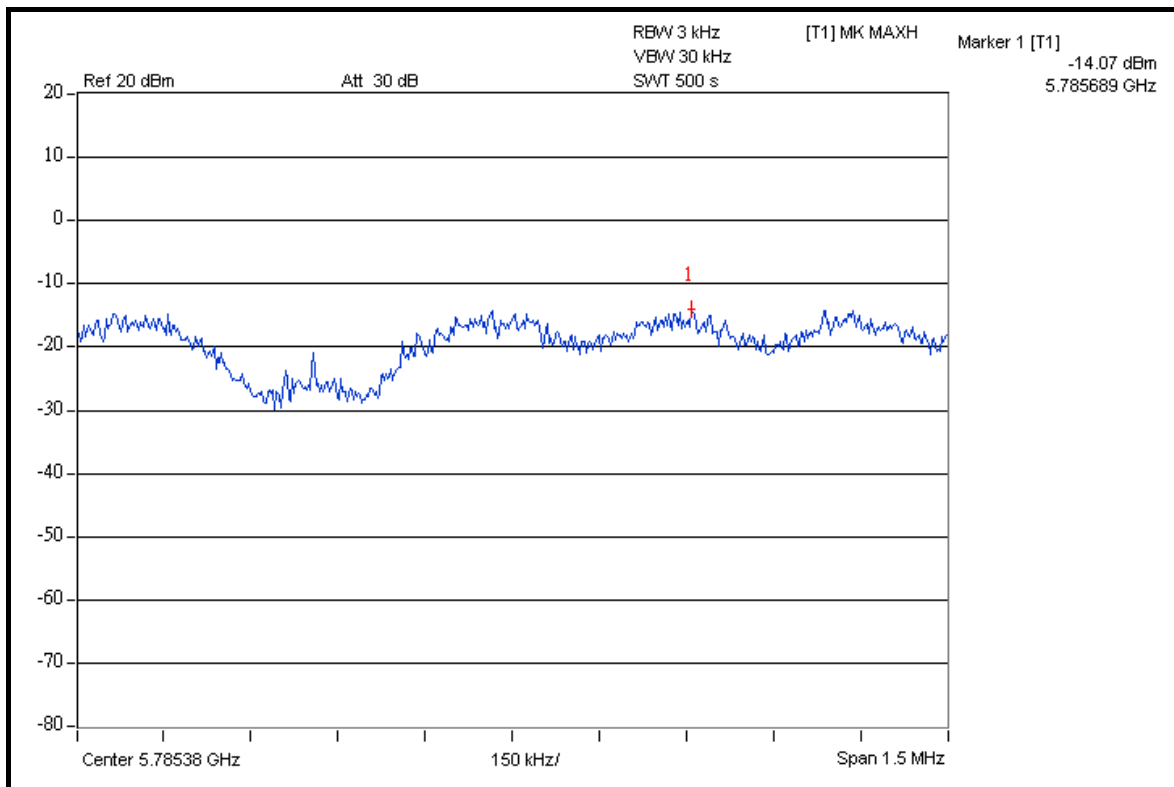



A D T

CH 165

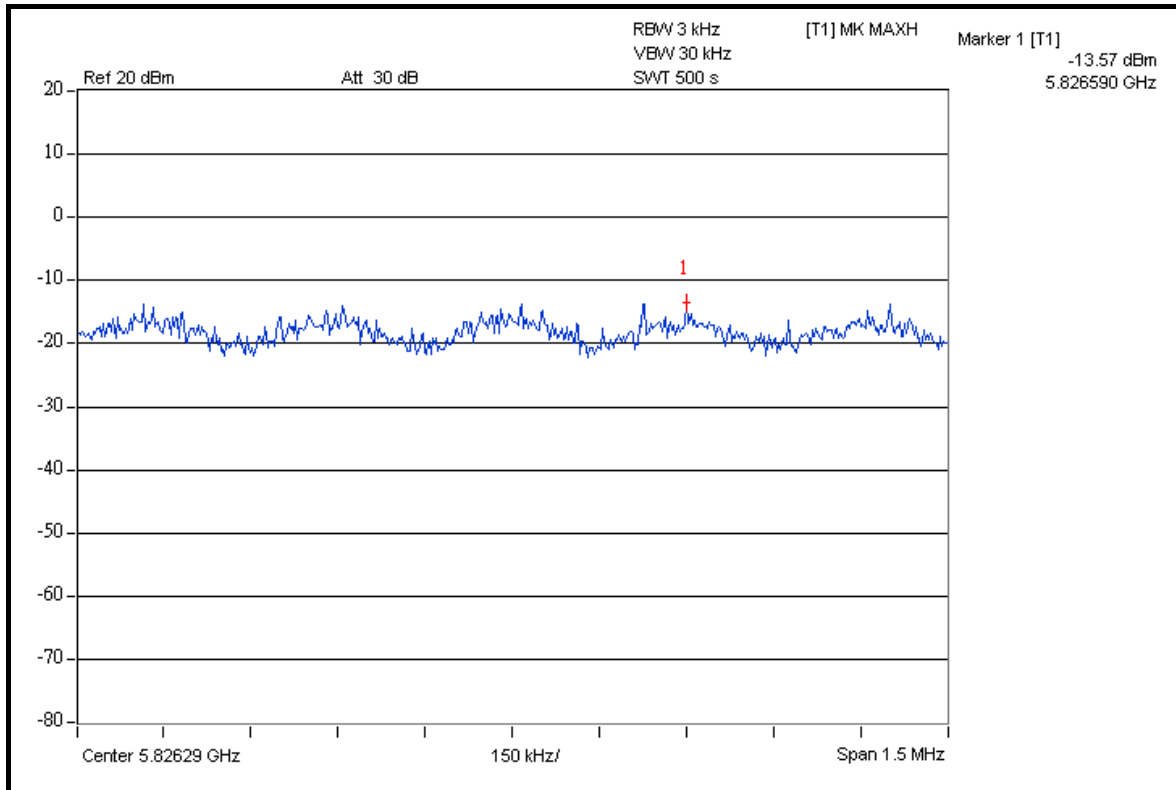

FOR CHAIN 1: CH 149

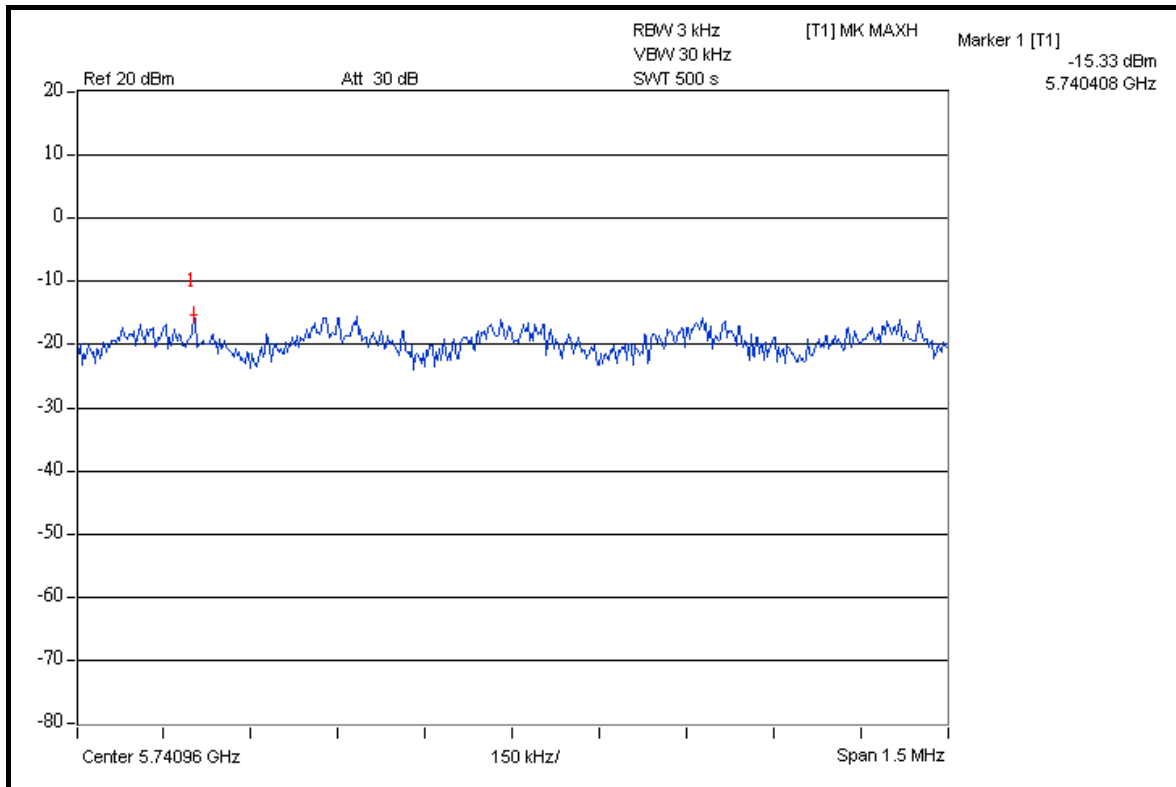



A D T

CH 157

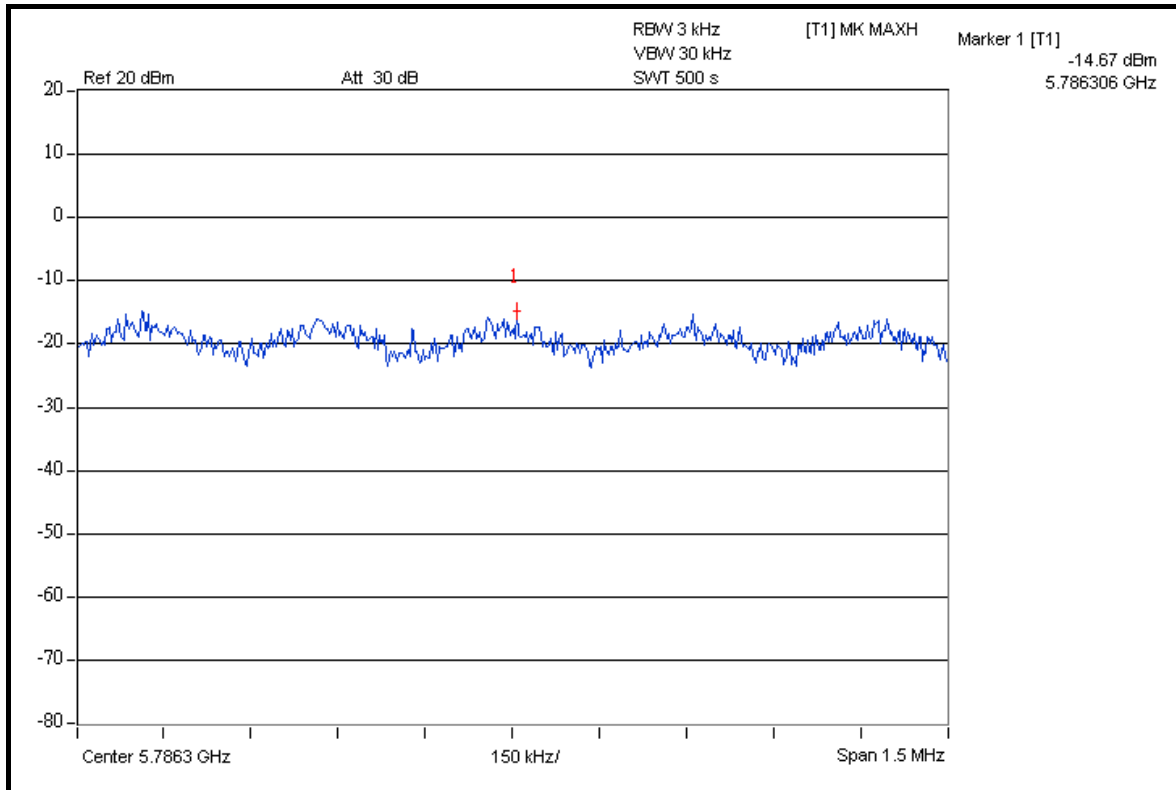

CH 165

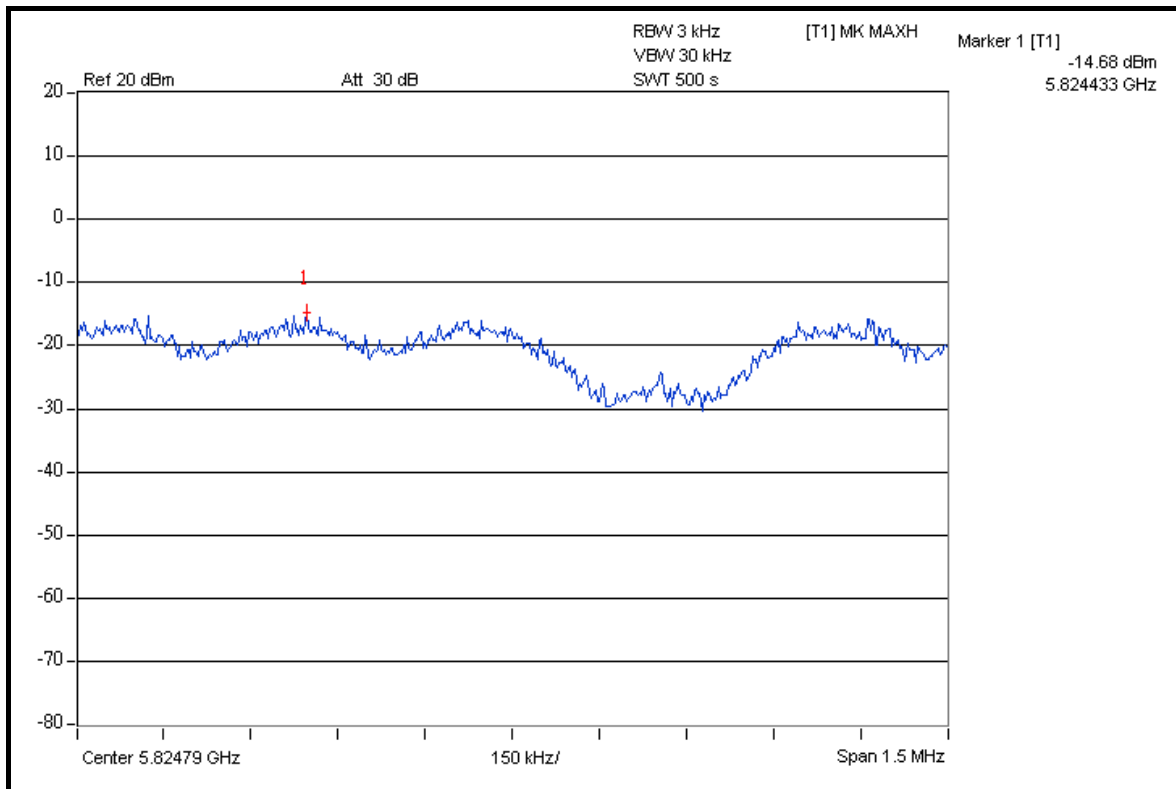



A D T

DRAFT 802.11n (20MHz) OFDM MODULATION

MODULATION TYPE	BPSK	TRANSFER RATE	7.2Mbps
INPUT POWER	120Vac, 60Hz	ENVIRONMENTAL CONDITIONS	24 deg.C, 64%RH, 991hPa
TESTED BY	Match Tsui		

CHAN.	CHAN. FREQ. (MHz)	RF POWER LEVEL IN 3kHz BW (dBm)		TOTAL POWER DENSITY (mW)	TOTAL POWER DENSITY (dBm)	MAX. LIMIT (dBm)	PASS / FAIL
		CHAIN 0	CHAIN 1				
149	5745	-12.72	-14.05	0.093	-10.32	8	PASS
157	5785	-12.71	-13.94	0.094	-10.27	8	PASS
165	5825	-12.24	-13.53	0.104	-9.83	8	PASS



A D T

FOR CHAIN 0: CH 149

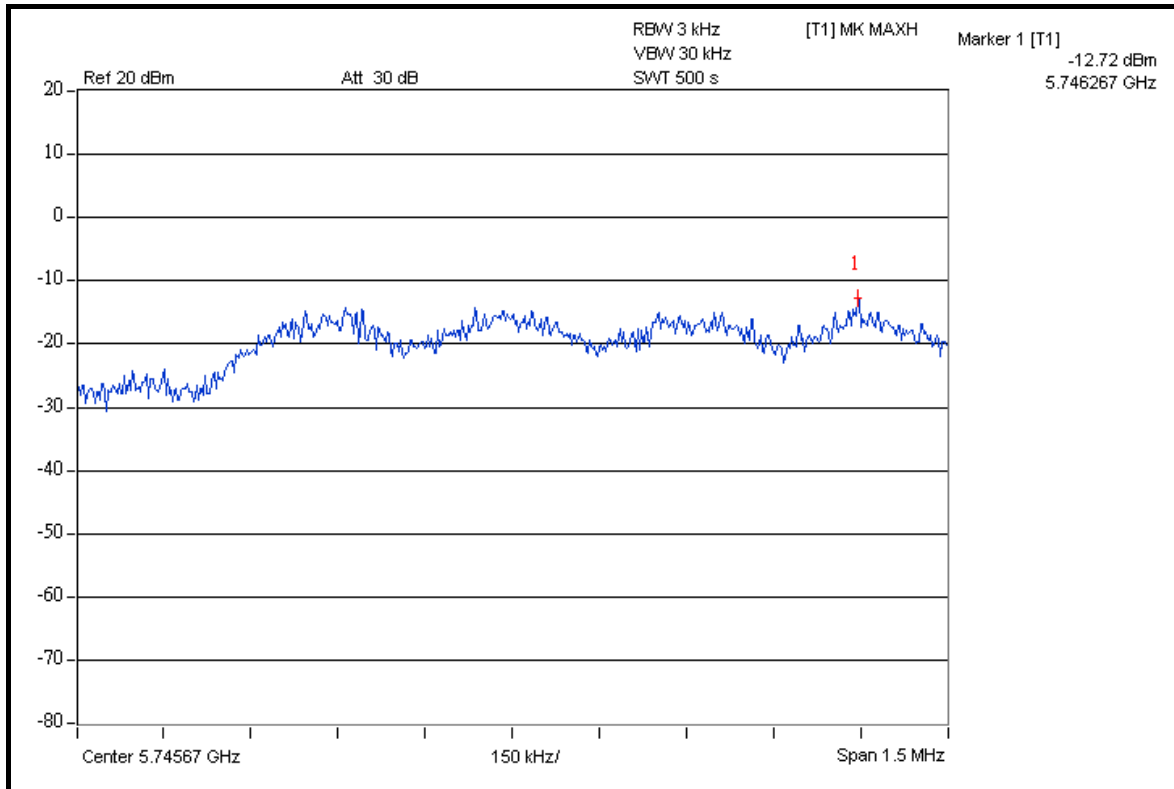

CH 157

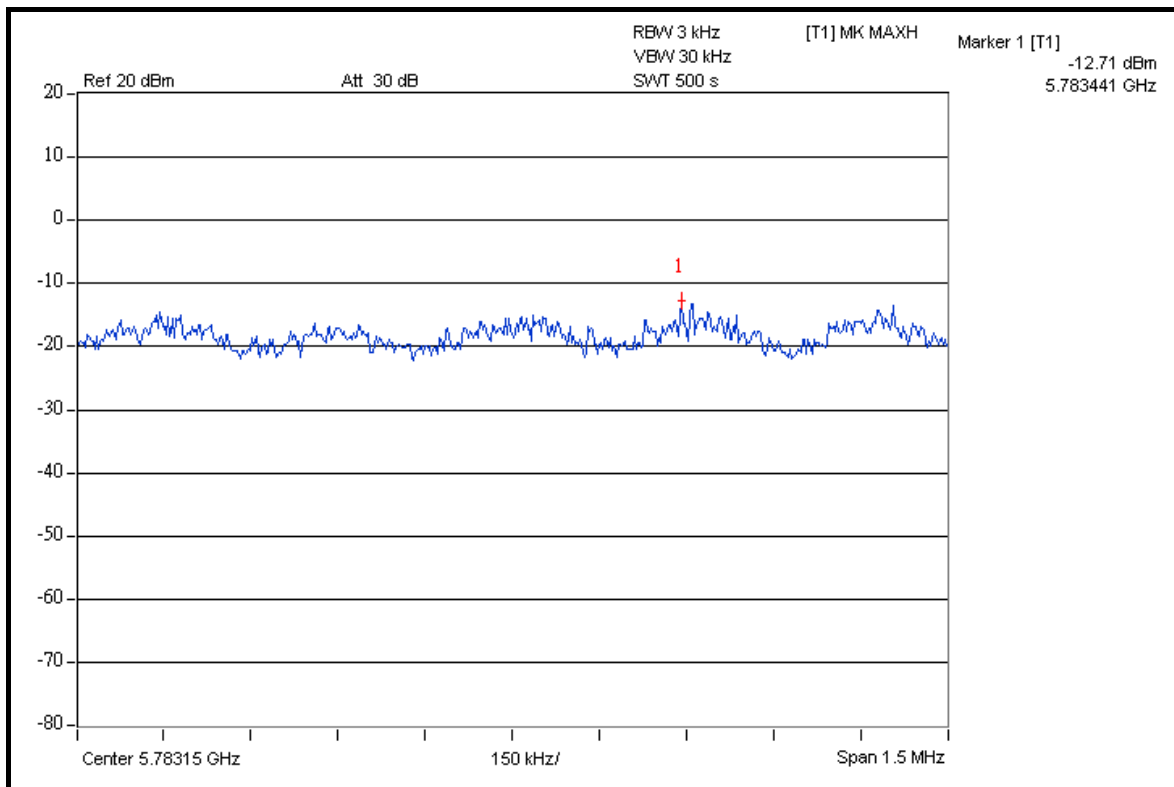



A D T

CH 165

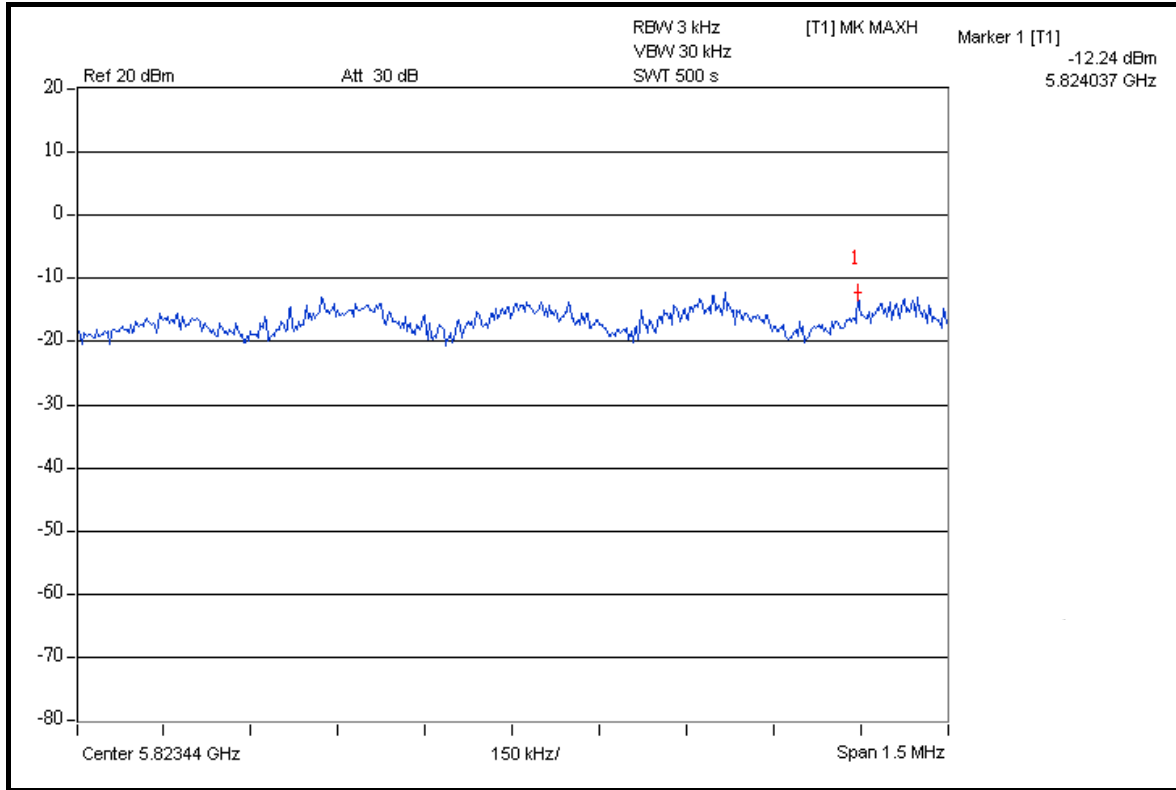

FOR CHAIN 1: CH 149

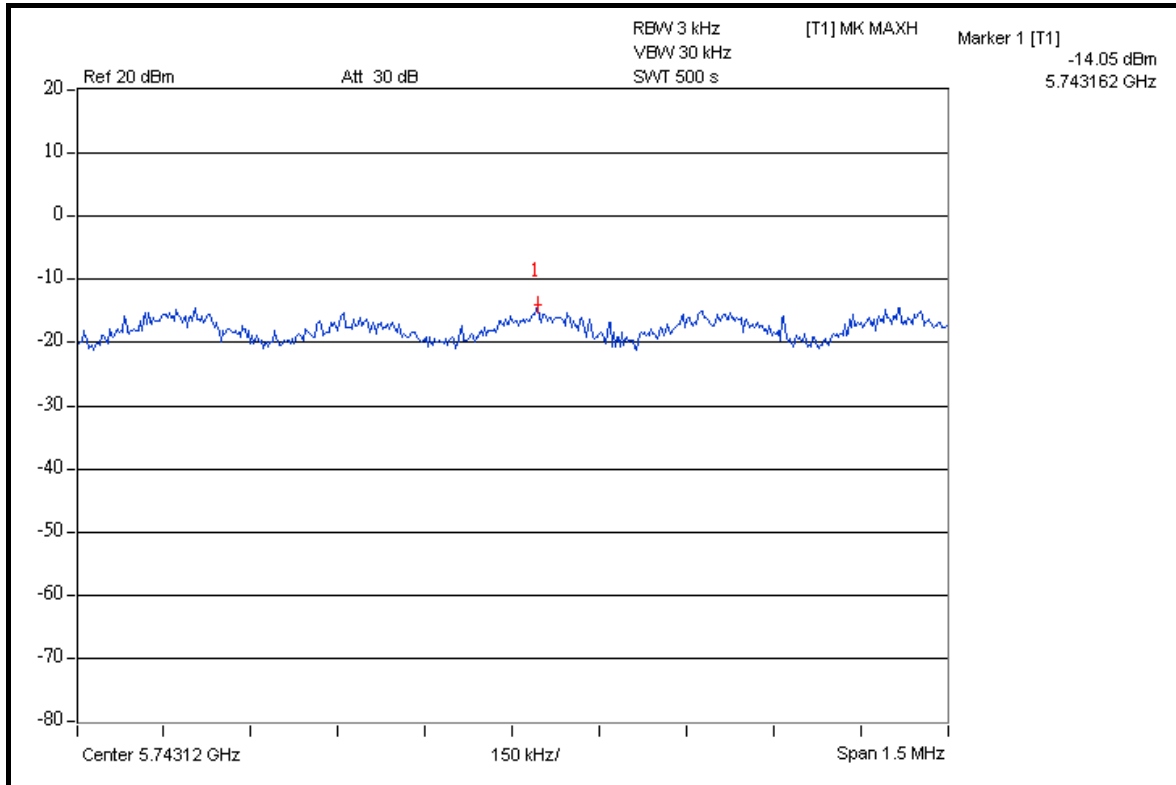



A D T

CH 157

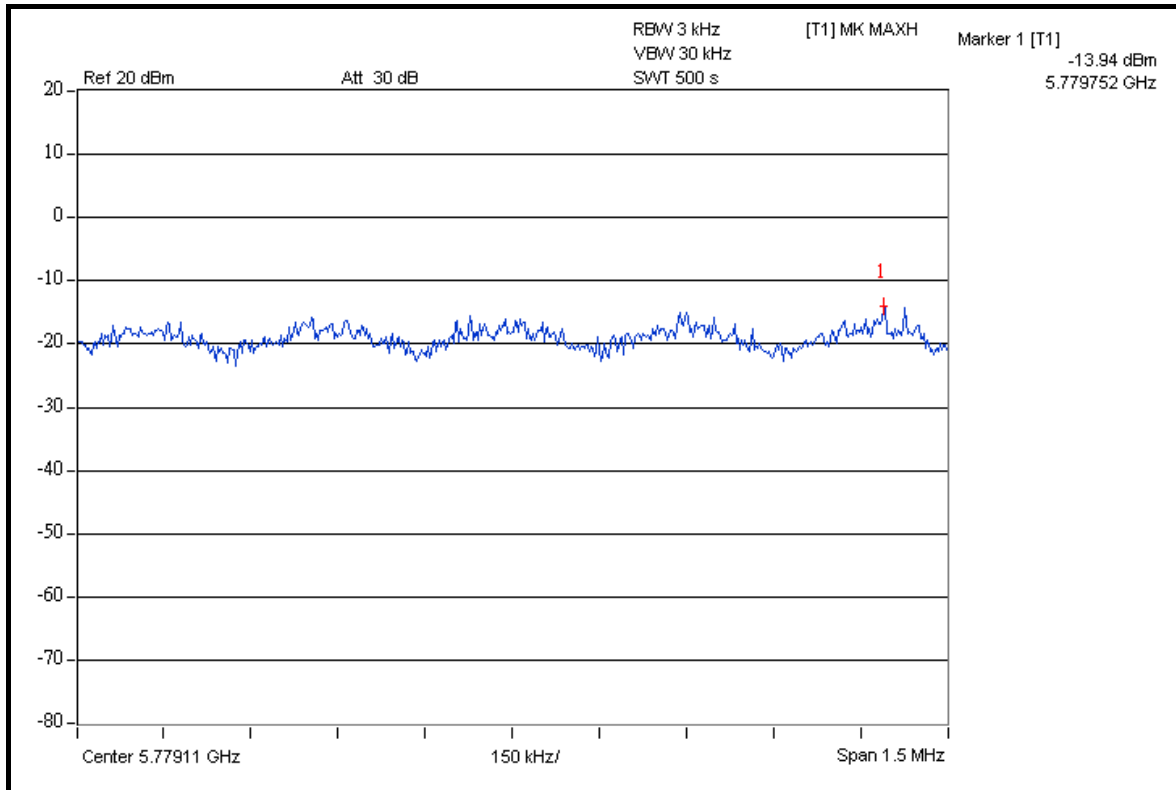

CH 165

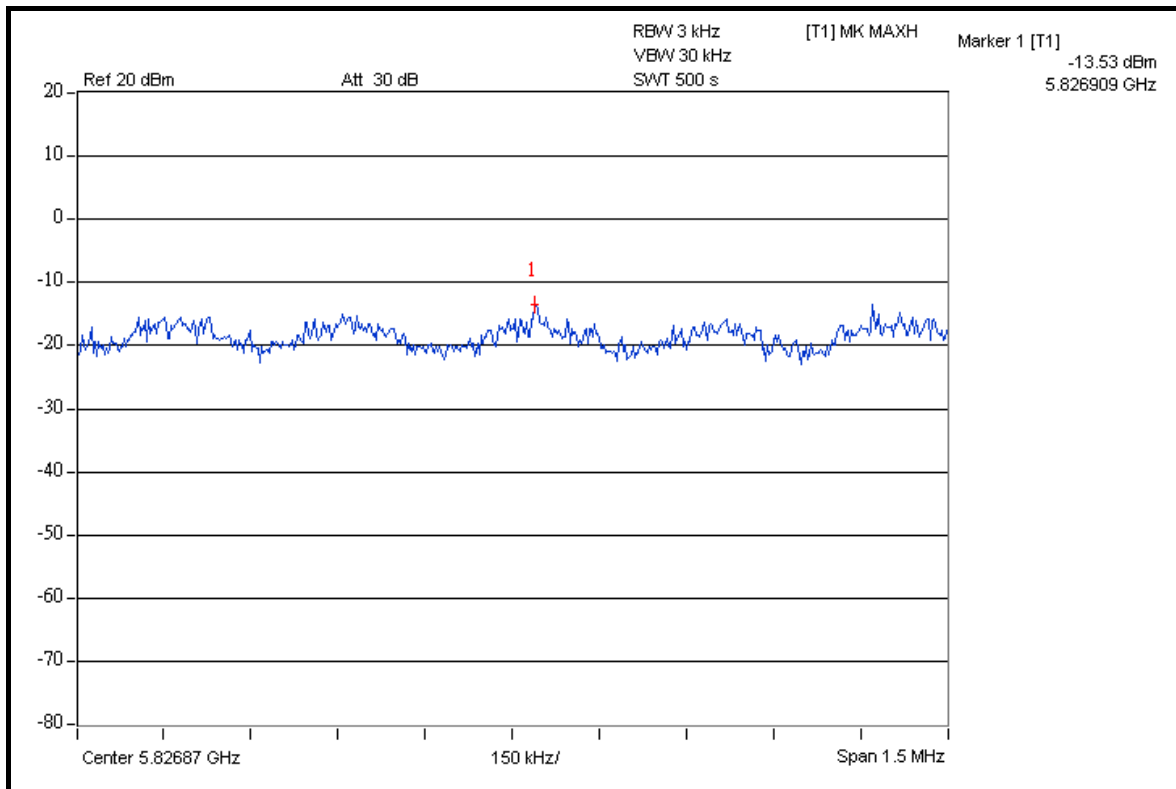



A D T

DRAFT 802.11n (40MHz) OFDM MODULATION

MODULATION TYPE	BPSK	TRANSFER RATE	15.0Mbps
INPUT POWER	120Vac, 60Hz	ENVIRONMENTAL CONDITIONS	24 deg.C, 64%RH, 1021hPa
TESTED BY	Match Tsui		

CHAN.	CHAN. FREQ. (MHz)	RF POWER LEVEL IN 3kHz BW (dBm)		TOTAL POWER DENSITY (mW)	TOTAL POWER DENSITY (dBm)	MAX. LIMIT (dBm)	PASS / FAIL
		CHAIN 0	CHAIN 1				
151	5755	-17.39	-18.77	0.032	-15.02	8	PASS
159	5795	-17.21	-18.66	0.033	-14.86	8	PASS



A D T

FOR CHAIN 0: CH 151

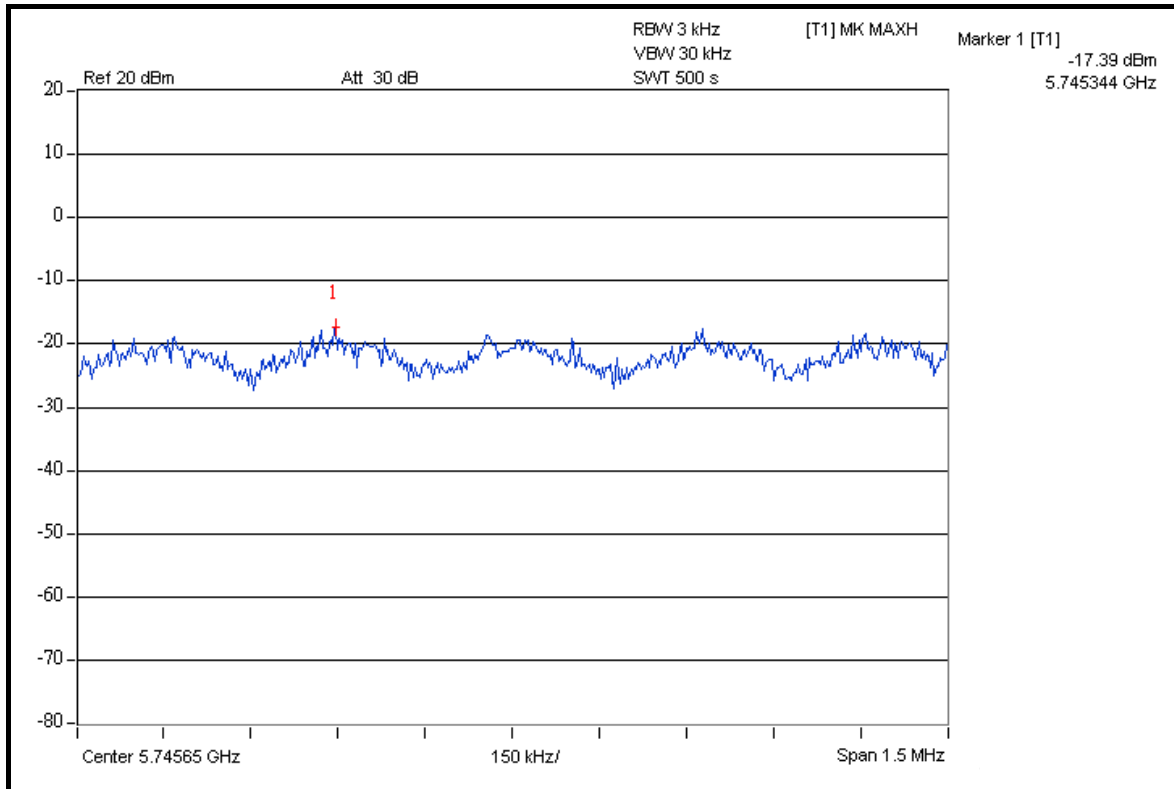

CH 159

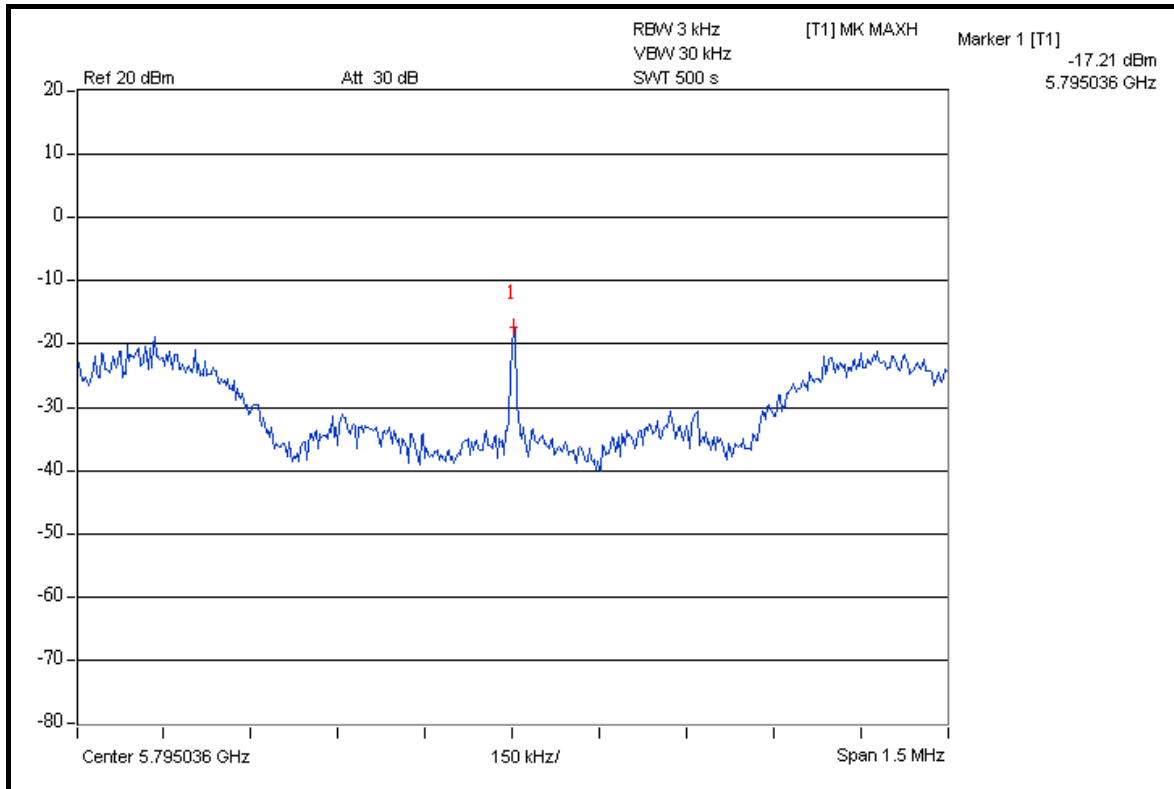



A D T

FOR CHAIN 1: CH 151

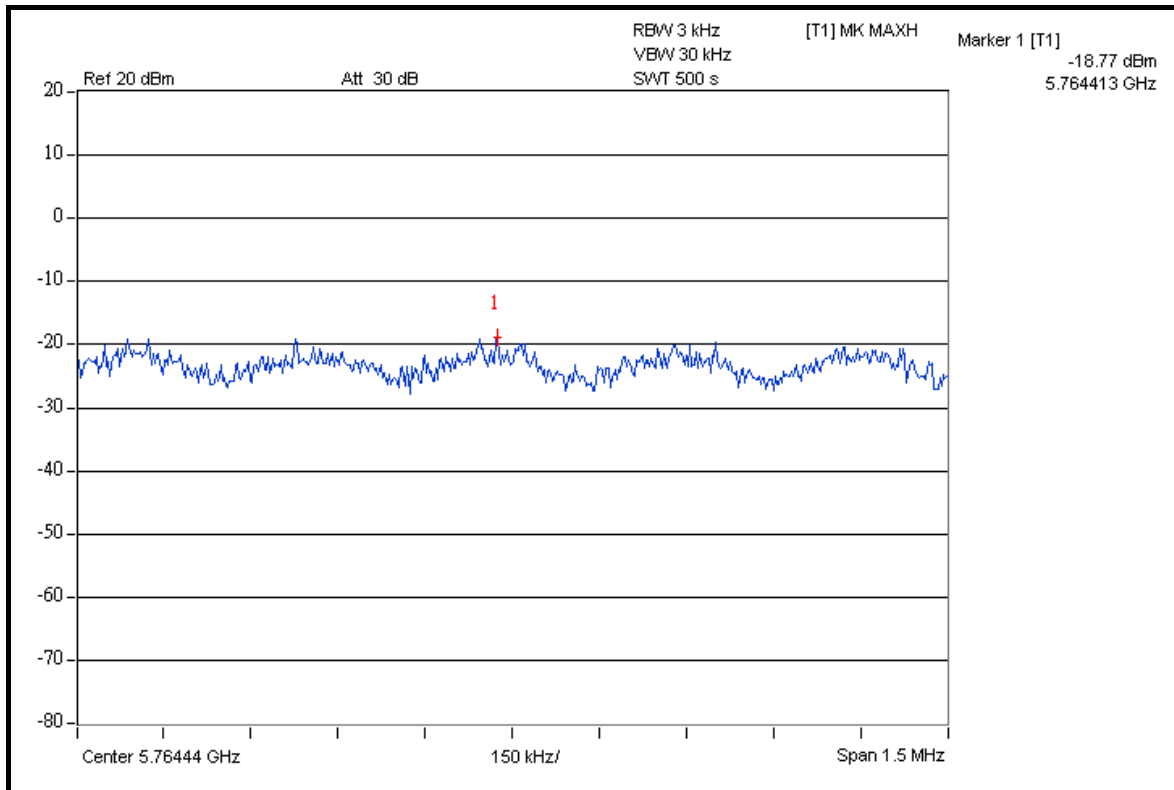

CH 159

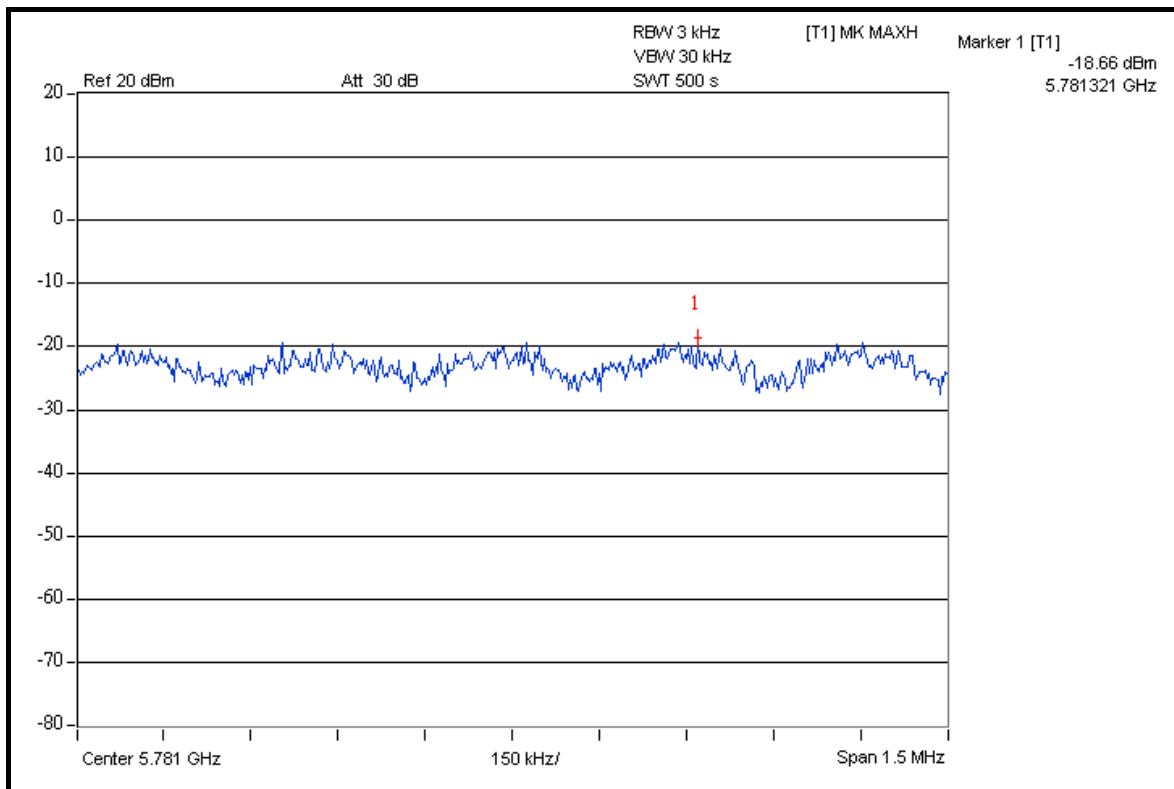



A D T

5.6 BAND EDGES MEASUREMENT

5.6.1 LIMITS OF BAND EDGES MEASUREMENT

Below -20dB of the highest emission level of operating band (in 100kHz Resolution Bandwidth).

5.6.2 TEST INSTRUMENTS

DESCRIPTION & MANUFACTURER	MODEL NO.	SERIAL NO.	DATE OF CALIBRATION	DUE DATE OF CALIBRATION
Test Receiver ROHDE & SCHWARZ	ESI7	100033	Jun. 30, 2008	Jun. 29, 2009
Spectrum Analyzer ROHDE & SCHWARZ	FSP40	100041	Apr. 22, 2008	Apr. 21, 2009
BILOG Antenna SCHWARZBECK	VULB9168	9168-160	May 02, 2008	May 01, 2009
HORN Antenna SCHWARZBECK	9120D	9120D-209	Jun. 24, 2008	Jun. 23, 2009
HORN Antenna SCHWARZBECK	BBHA 9170	BBHA9170243	Dec. 25, 2007	Dec. 24, 2008
Preamplifier Agilent	8447D	2944A10633	Nov. 03, 2008	Nov. 02, 2009
Preamplifier Agilent	8449B	3008A01964	Oct. 23, 2008	Oct. 22, 2009
RF signal cable HUBER+SUHNNER	SUCOFLEX 104	238141/4	May 20, 2008	May 19, 2009
RF signal cable HUBER+SUHNNER	SUCOFLEX 104	12738/6	May 20, 2008	May 19, 2009
Software ADT.	ADT_Radiated_V7.6	NA	NA	NA
Antenna Tower inn-co GmbH	MA 4000	013303	NA	NA
Antenna Tower Controller inn-co GmbH	CO2000	017303	NA	NA
Turn Table ADT.	TT100.	TT93021703	NA	NA
Turn Table Controller ADT.	SC100.	SC93021703	NA	NA

- NOTE:** 1. The calibration interval of the above test instruments is 12 months and the calibrations are traceable to NML/ROC and NIST/USA.
2. The test was performed in HwaYa Chamber 3.
3. The horn antenna and HP preamplifier (model: 8449B) are used only for the measurement of emission frequency above 1GHz if tested.
4. The FCC Site Registration No. is 988962.
5. The IC Site Registration No. is IC3789B-3.



A D T

5.6.3 TEST PROCEDURE

- a. The EUT was placed on the top of a rotating table 0.8 meters above the ground at a 3 meter semi-anechoic chamber. The table was rotated 360 degrees to determine the position of the highest radiation.
- b. The EUT was set 3 meters away from the interference-receiving antenna, which was mounted on the top of a variable-height antenna tower.
- c. The antenna is a broadband antenna, and its height is varied from one meter to four meters above the ground to determine the maximum value of the field strength. Both horizontal and vertical polarizations of the antenna are set to make the measurement.
- d. For each suspected emission, the EUT was arranged to its worst case and then the antenna was tuned to heights from 1 meter to 4 meters and the rotatable table was turned from 0 degrees to 360 degrees to find the maximum reading.
- e. Set both RBW and VBW of spectrum analyzer to 100kHz and 300kHz with suitable frequency span including 100MHz bandwidth from band edge. The band edges was measured and recorded.

NOTE: The resolution bandwidth of test receiver/spectrum analyzer is 1MHz and the video bandwidth is 10Hz for Average detection (AV) at frequency above 1GHz.



A D T

5.6.4 DEVIATION FROM TEST STANDARD

No deviation.

5.6.5 EUT OPERATING CONDITION

Same as Item 5.3.6.

5.6.6 TEST RESULTS

The spectrum plots are attached on the following pages. D1 line indicates the highest level, D2 line indicates the 20dB offset below D1. It shows compliance with the requirement in part 15.247(d).



A D T

802.11a OFDM MODULATION

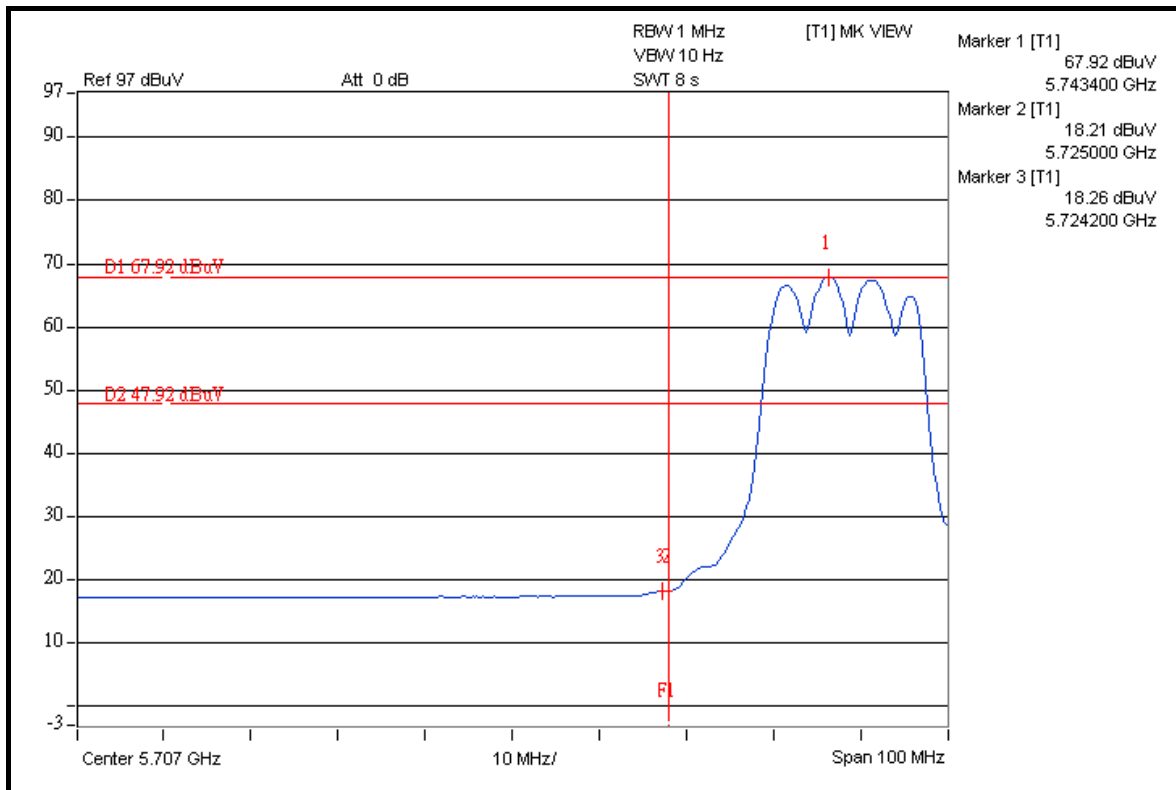
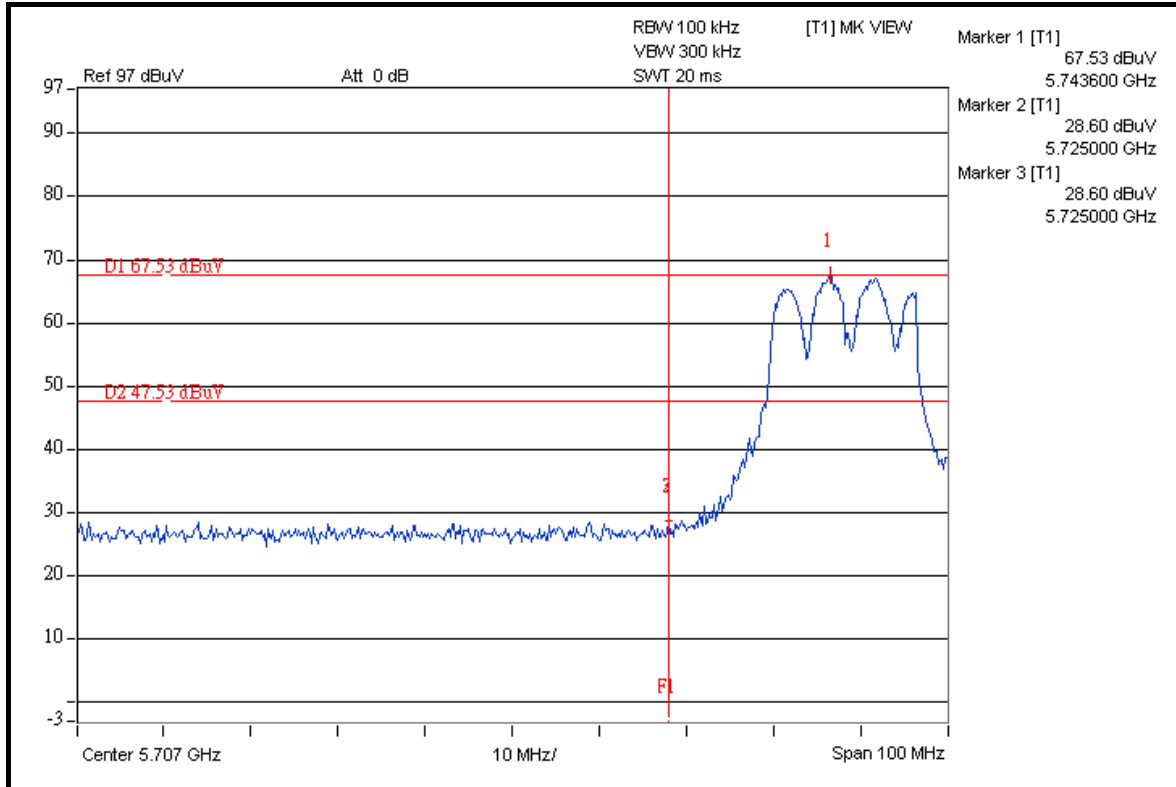



A D T

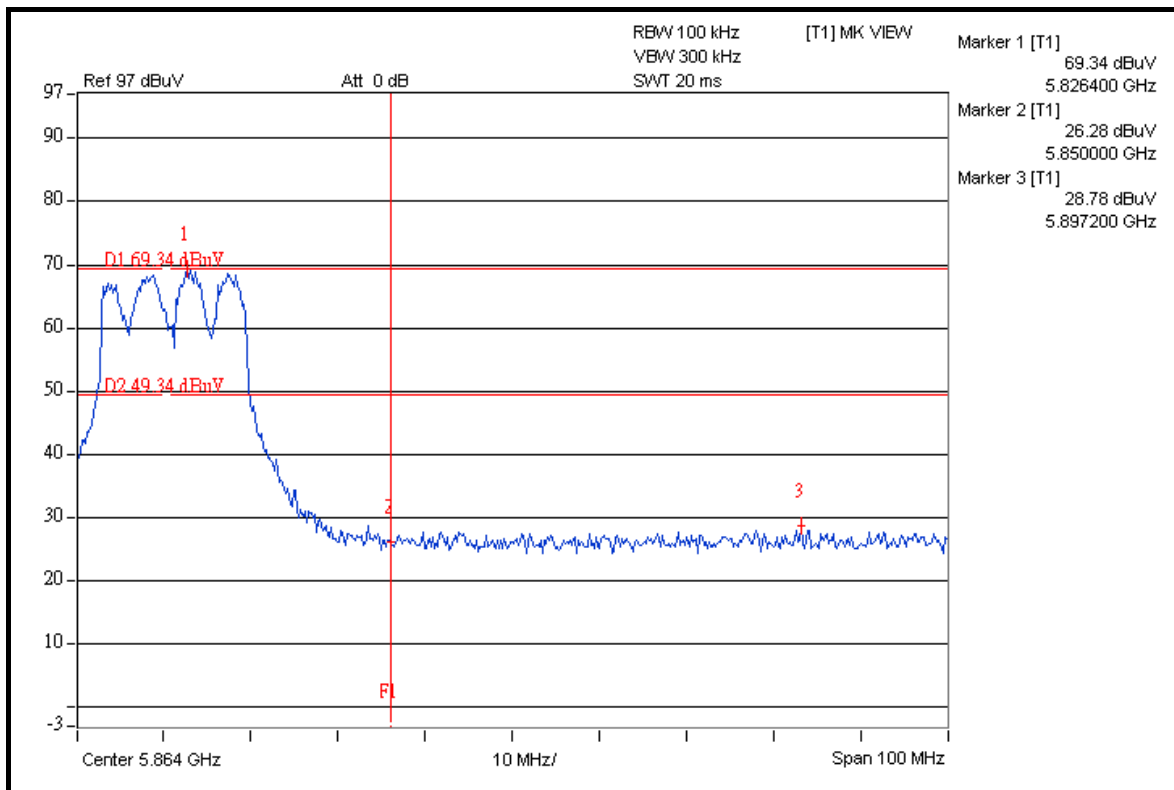
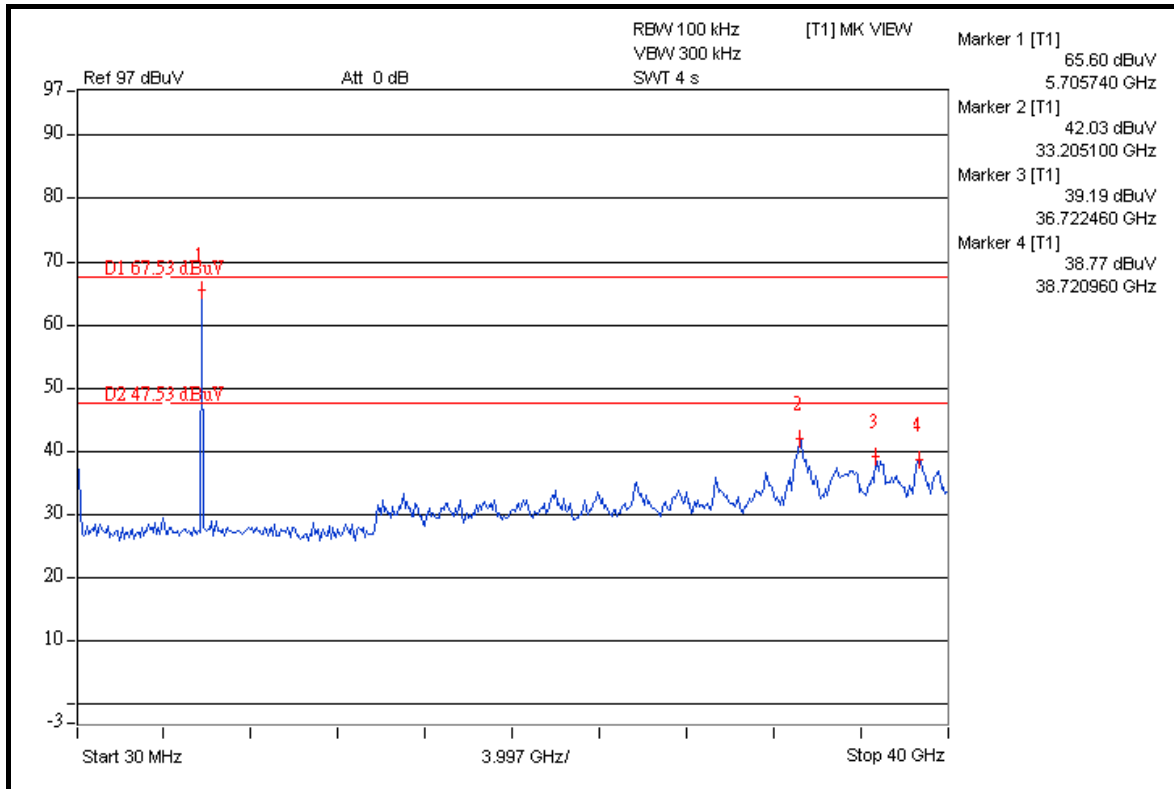



A D T

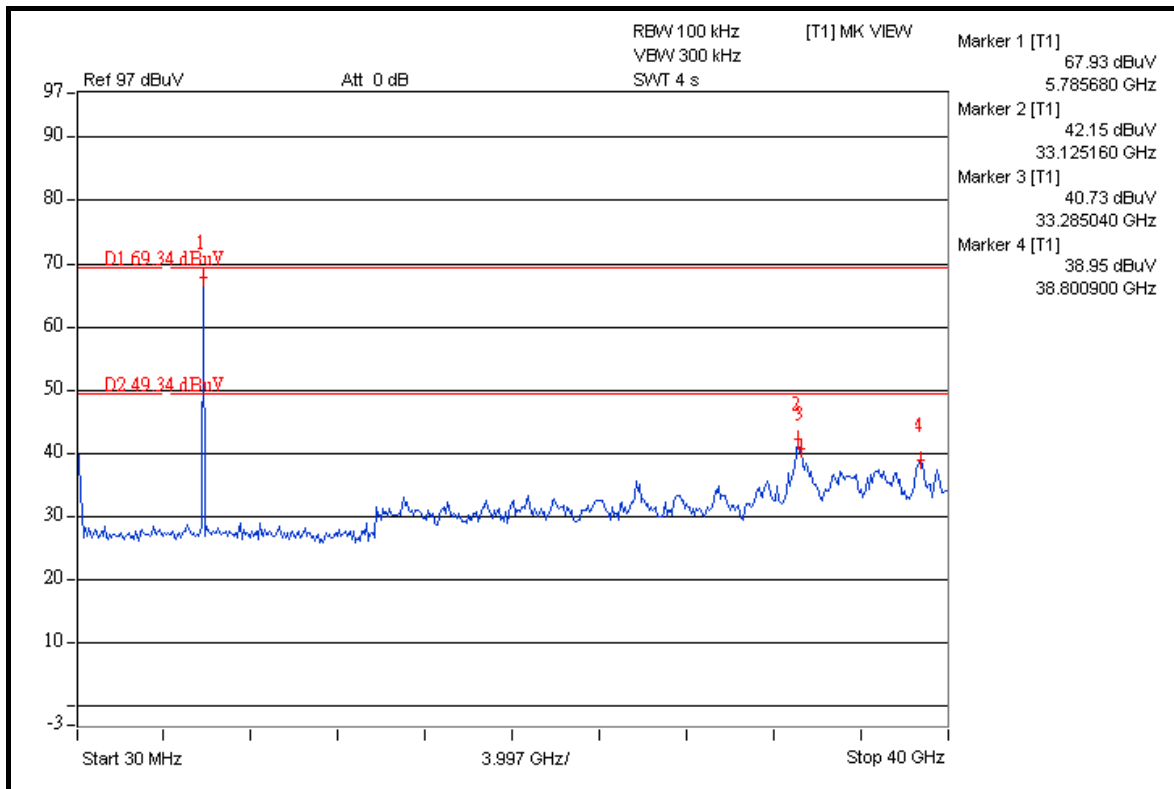
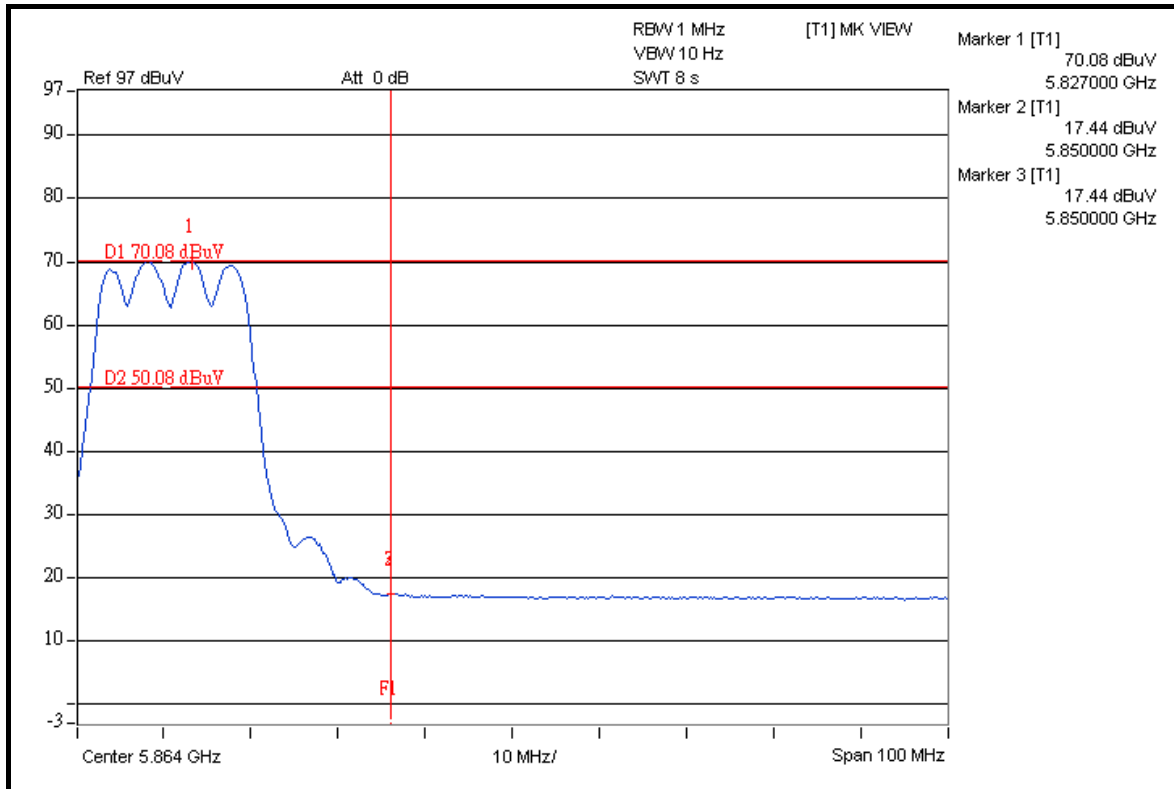



A D T

DRAFT 802.11n (20MHz) OFDM MODULATION

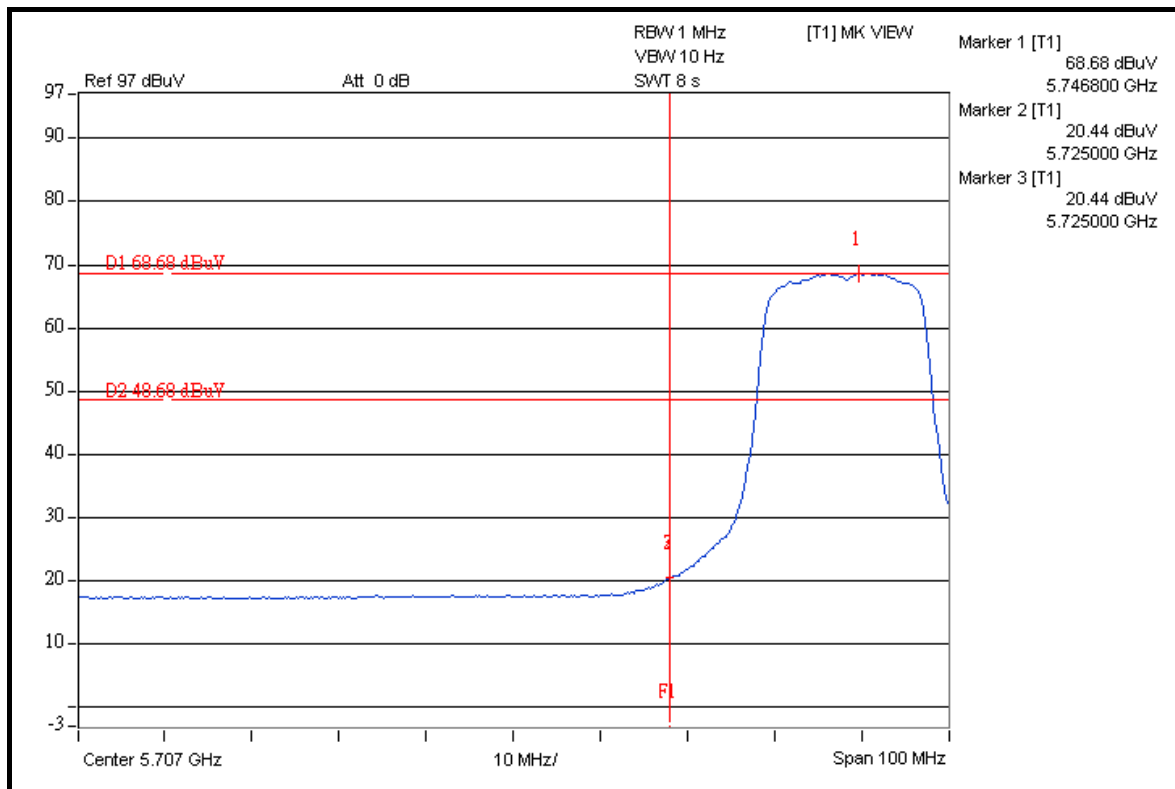
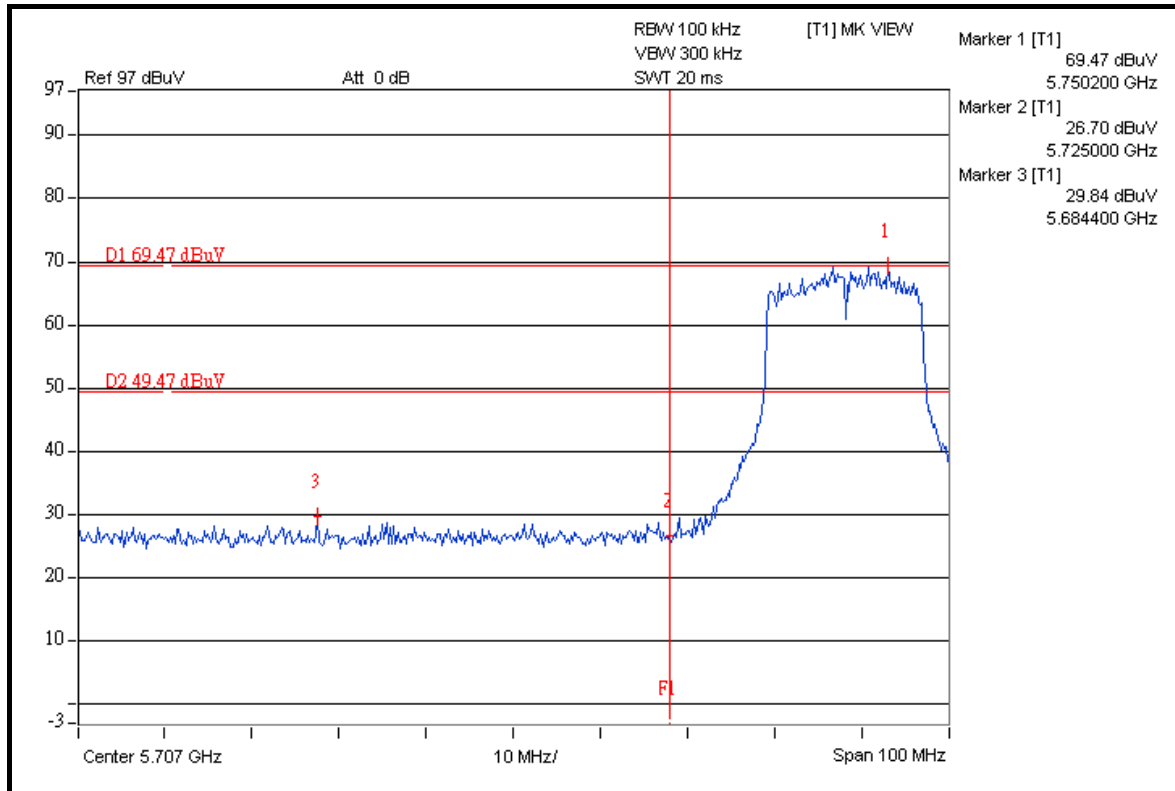



A D T

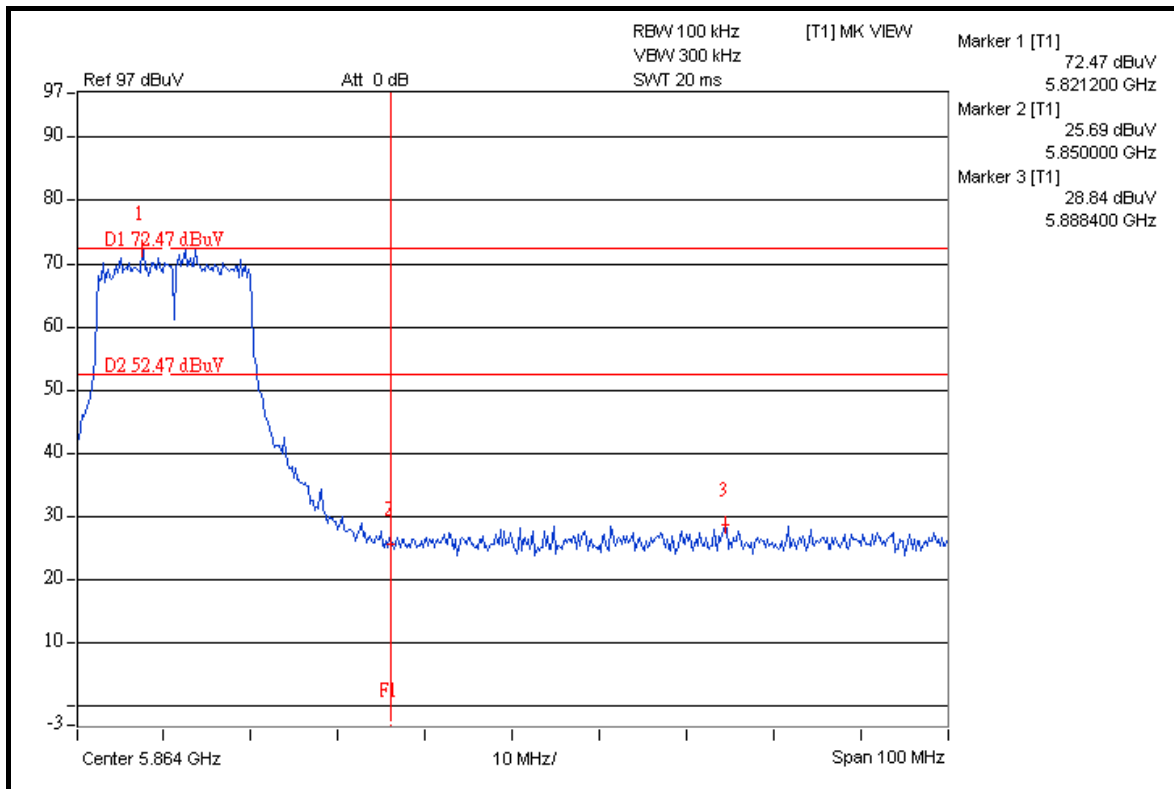
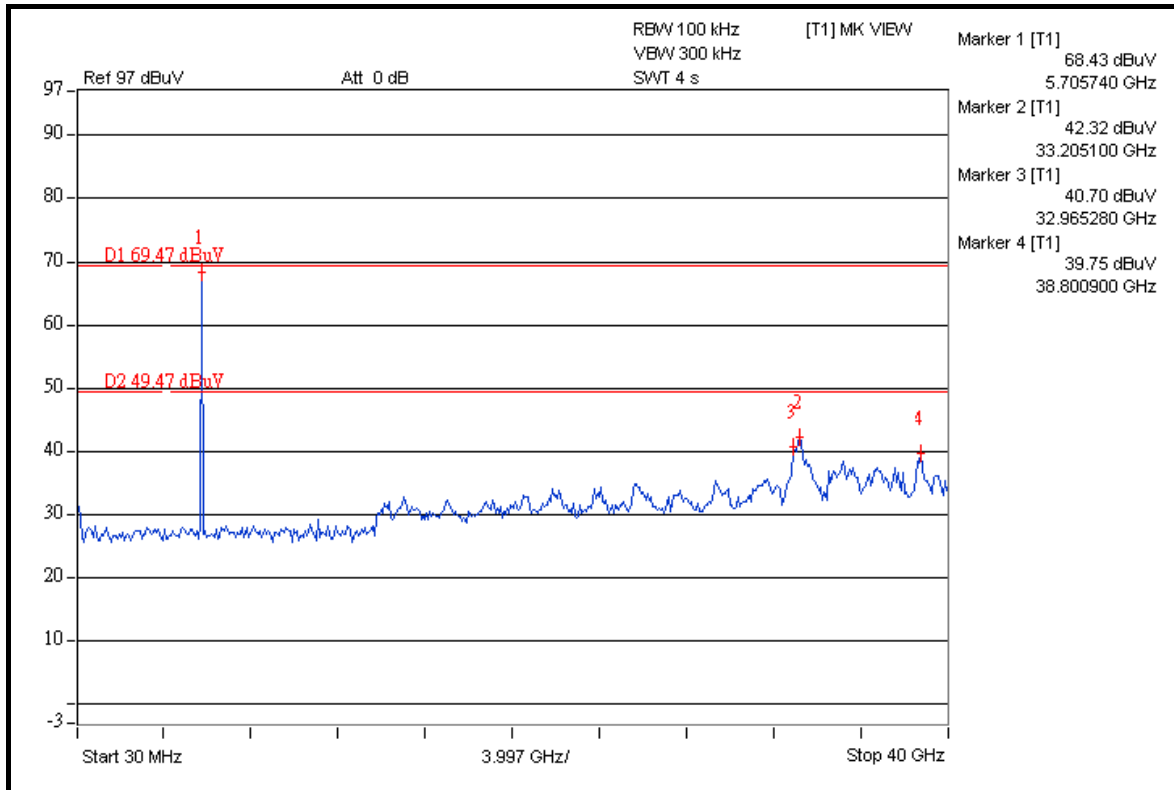



A D T

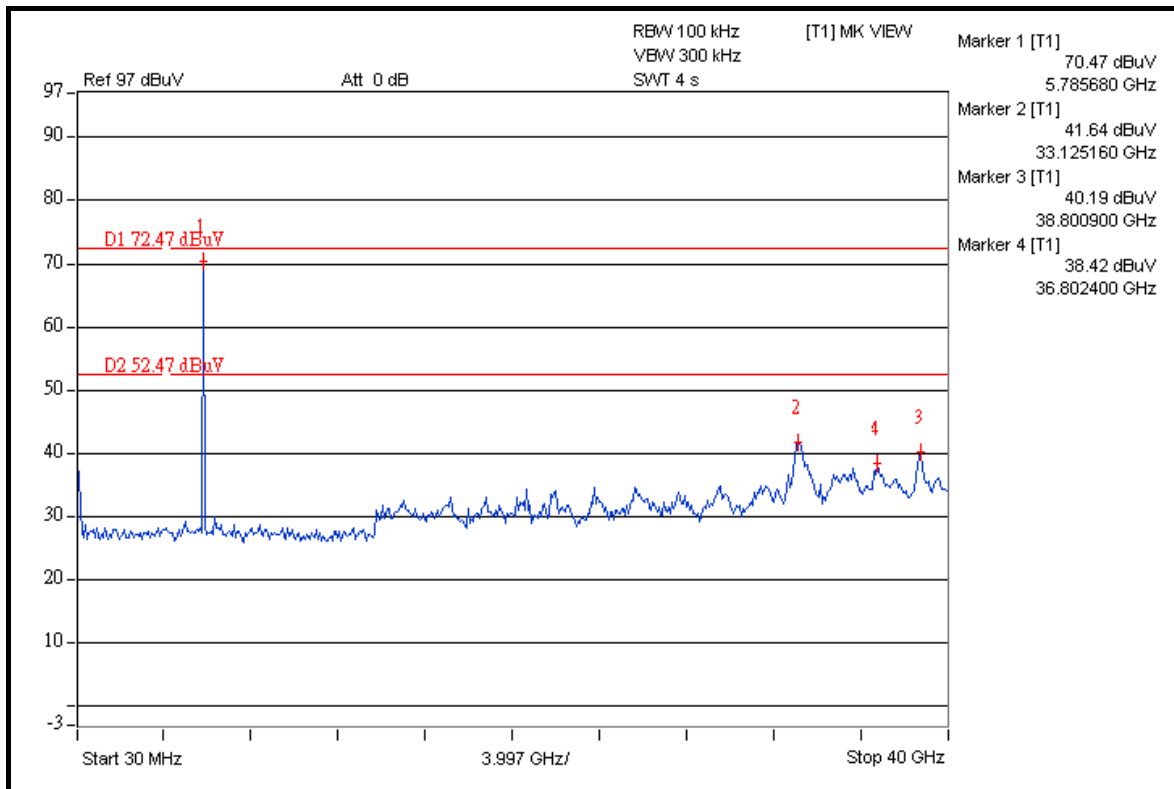
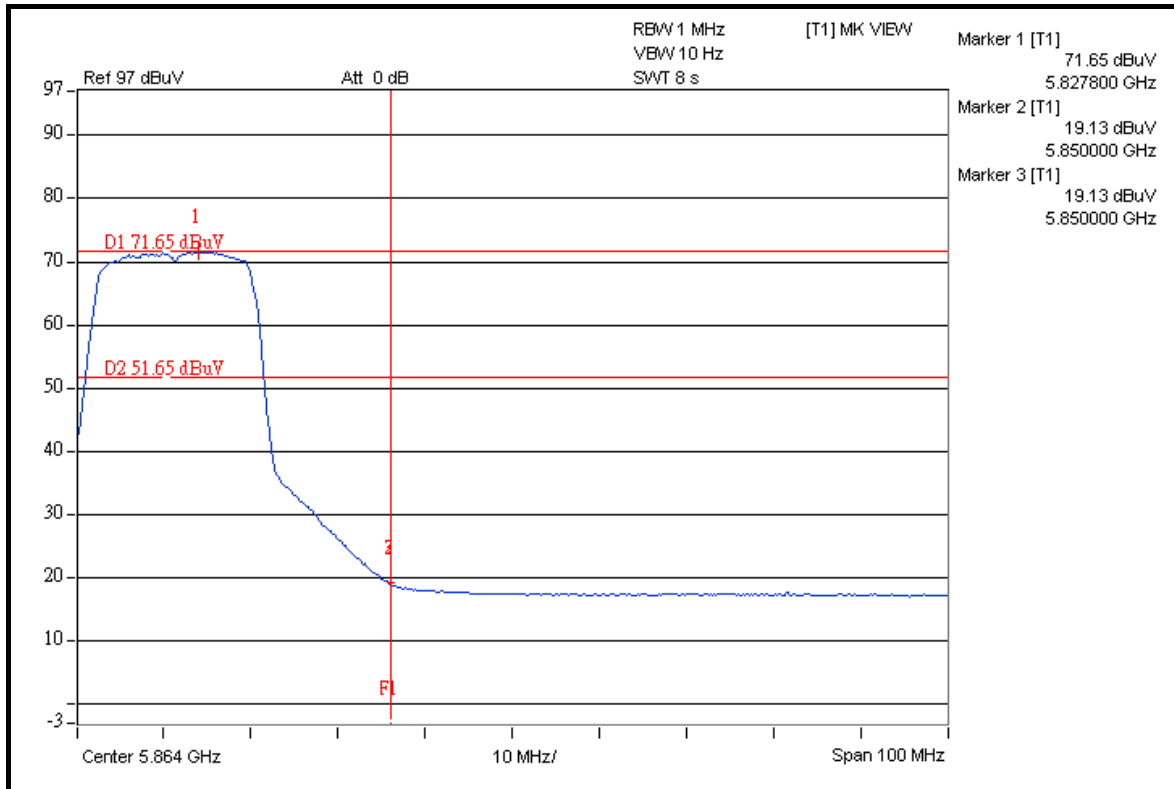



A D T

DRAFT 802.11n (40MHz) OFDM MODULATION

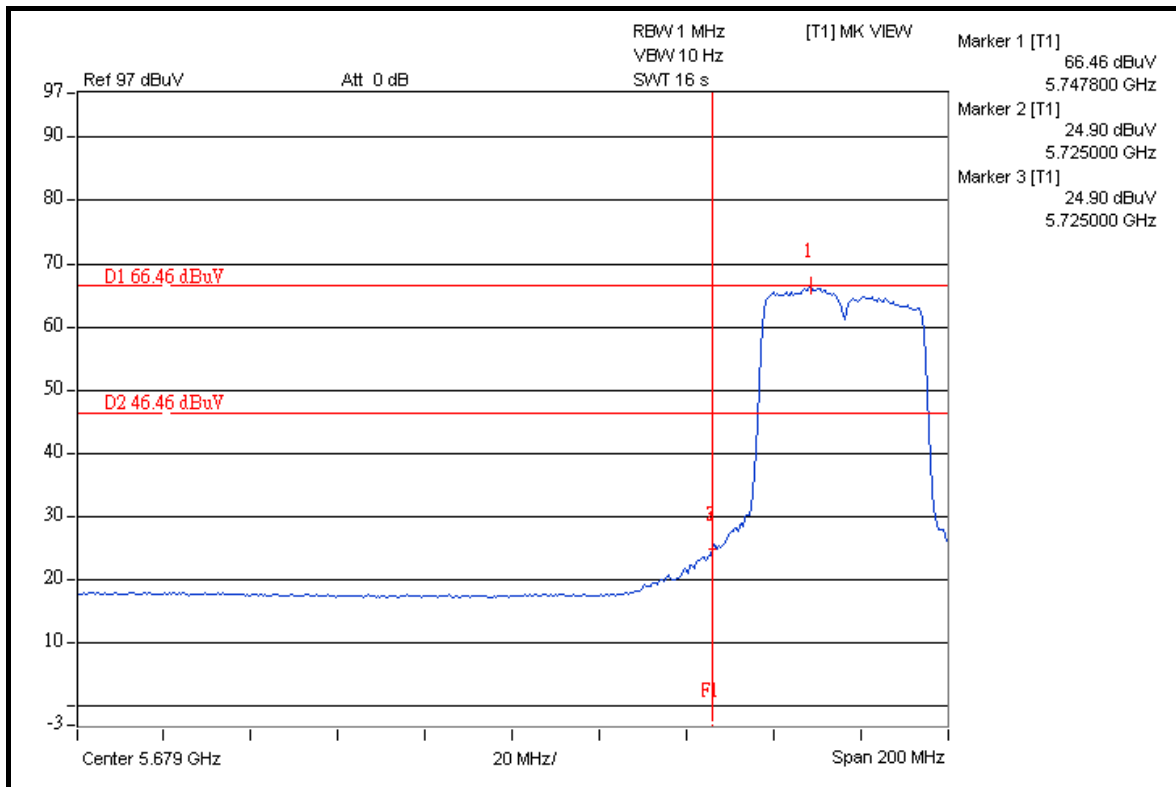
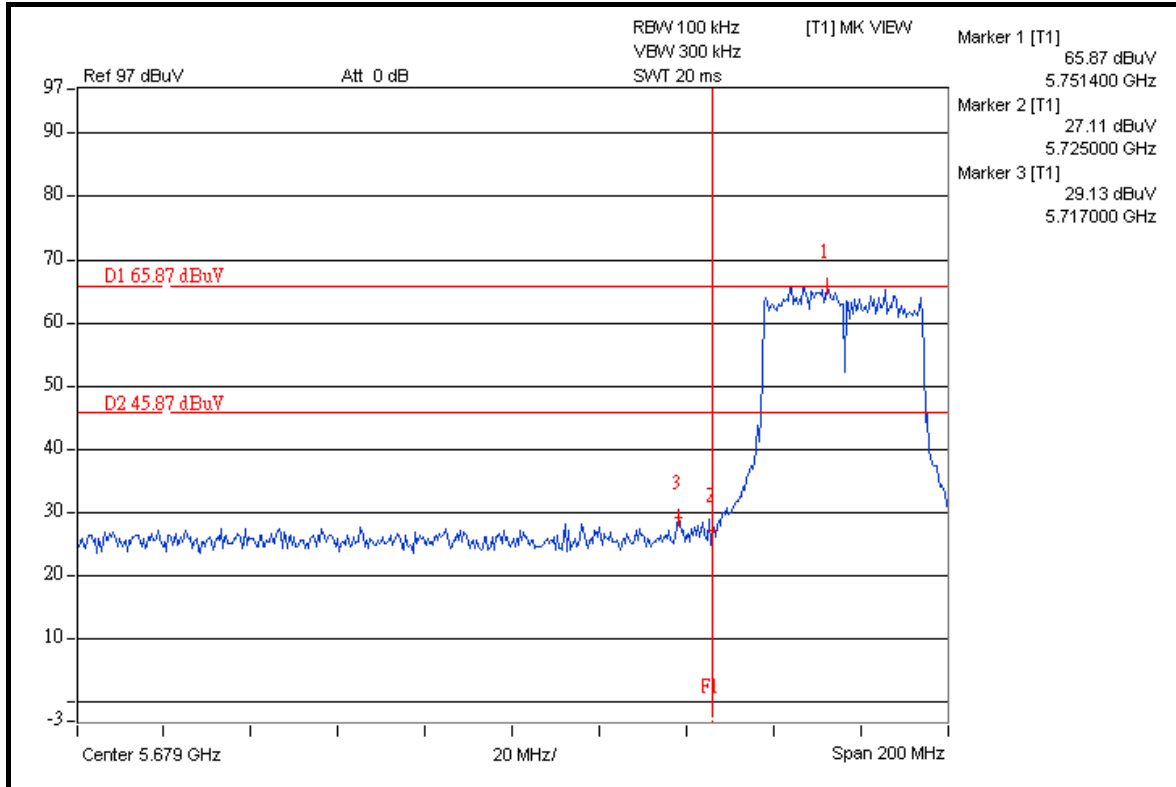



A D T

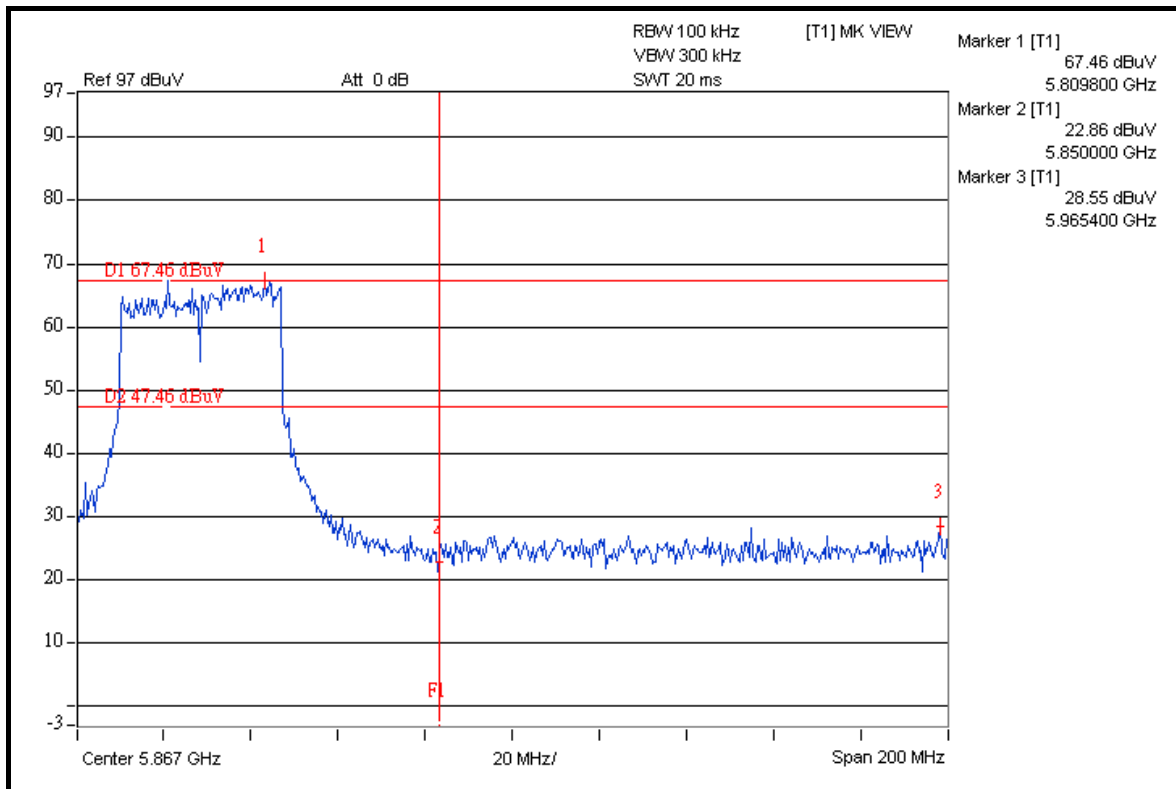
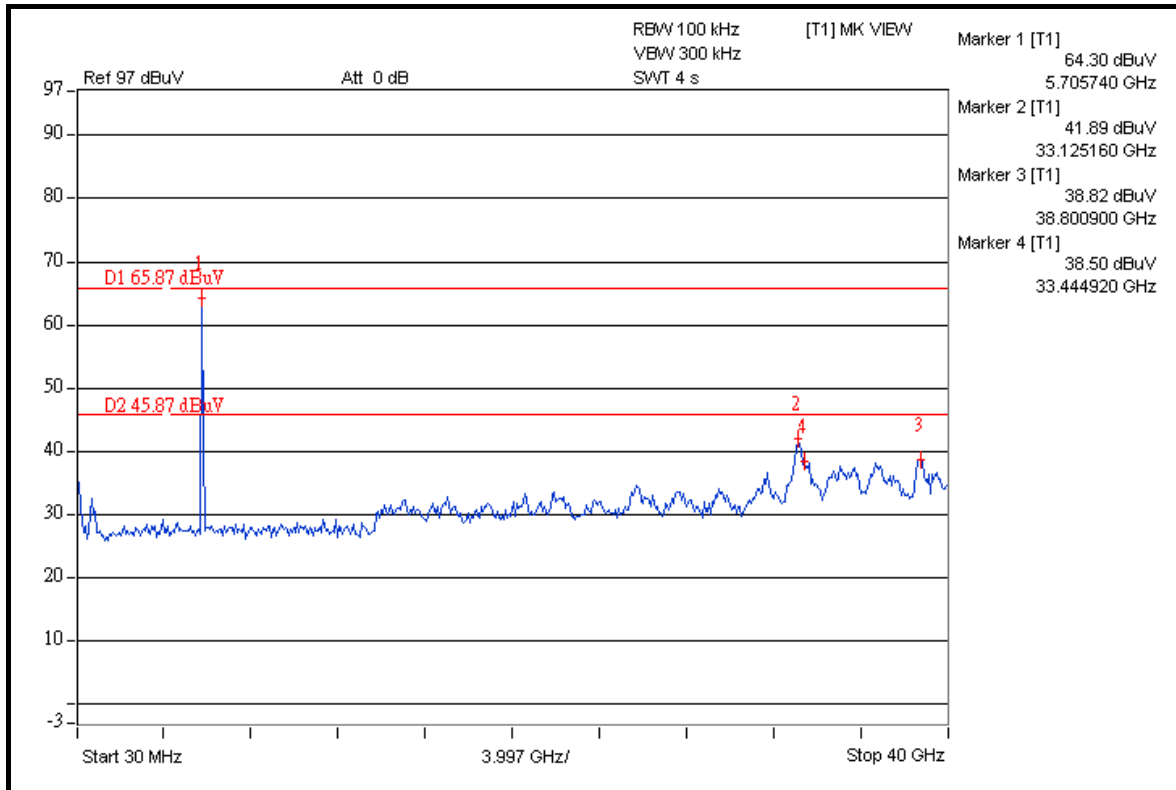



A D T

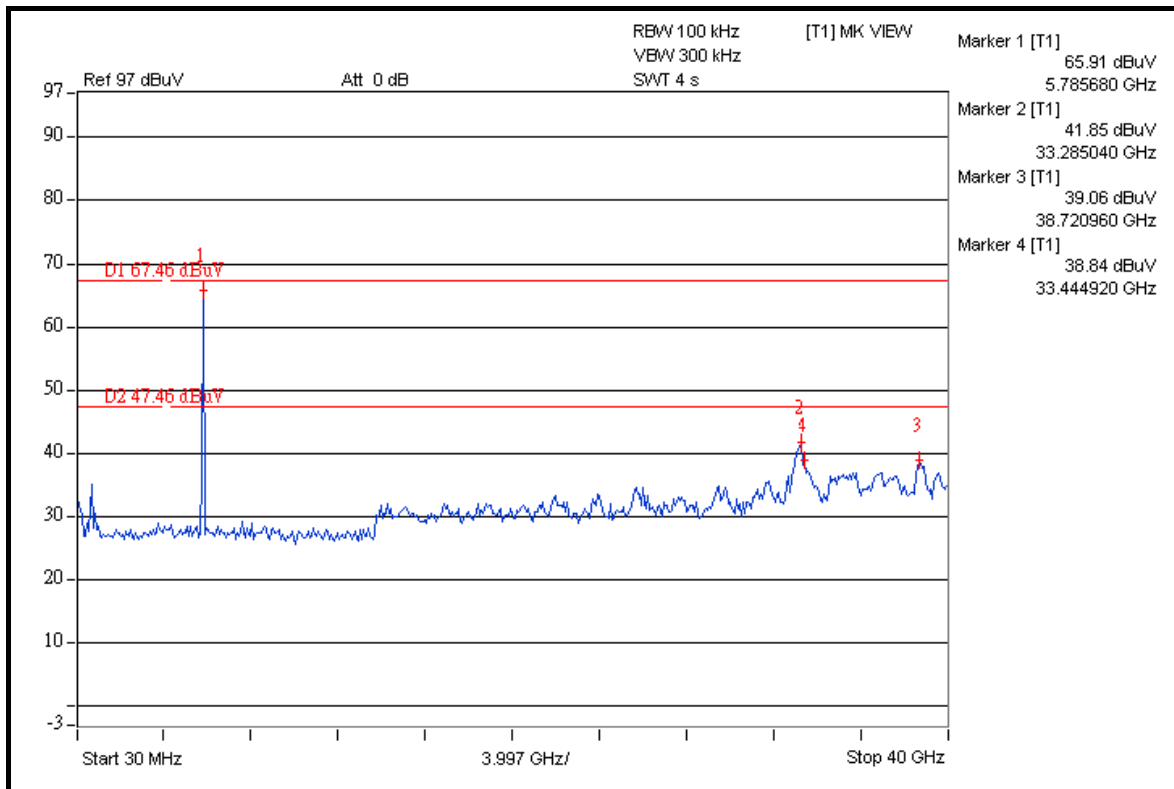
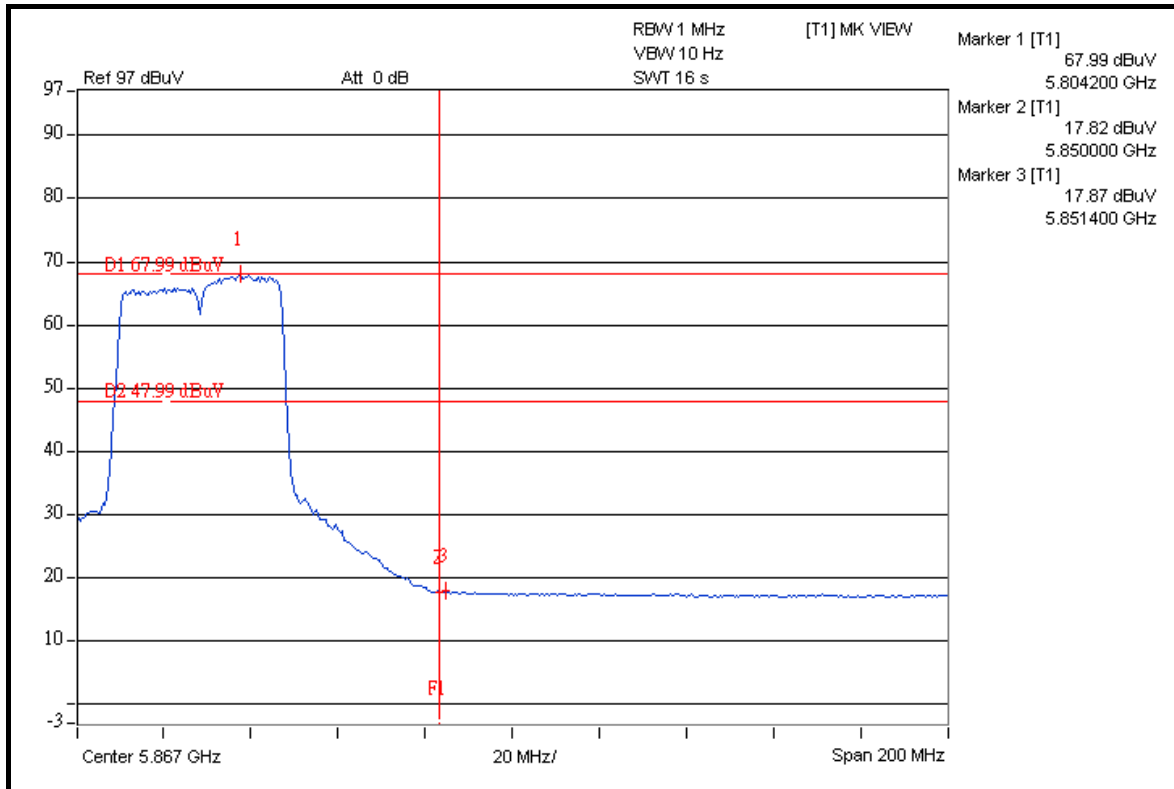



A D T

5.7 ANTENNA REQUIREMENT

5.7.1 STANDARD APPLICABLE

For intentional device, according to FCC 47 CFR Section 15.203, an intentional radiator shall be designed to ensure that no antenna other than that furnished by the responsible party shall be used with the device.

And according to FCC 47 CFR Section 15.247(a), if transmitting antennas of directional gain greater than 6dBi are used, the power shall be reduced by the amount in dB that the directional gain of the antenna exceeds 6dBi.

5.7.2 ANTENNA CONNECTED CONSTRUCTION

The antenna used in this product is Dipole antenna with R-SMA connector. The maximum gain of the antenna is 3dBi.



A D T

6. PHOTOGRAPHS OF THE TEST CONFIGURATION

Please refer to the attached file (Test Setup Photo).



A D T

7. INFORMATION ON THE TESTING LABORATORIES

We, Bureau Veritas Consumer Products Services (H.K.) Ltd., Taoyuan Branch, were founded in 1988 to provide our best service in EMC, Radio, Telecom and Safety consultation. Our laboratories are accredited and approved by the following approval agencies according to ISO/IEC 17025.

USA	FCC, UL, NVLAP
Germany	TUV Rheinland
Japan	VCCI
Norway	NEMKO
Canada	INDUSTRY CANADA , CSA
R.O.C.	TAF, BSMI, NCC
Netherlands	Telefication
Singapore	GOST-ASIA(MOU)
Russia	CERTIS(MOU)

Copies of accreditation certificates of our laboratories obtained from approval agencies can be downloaded from our web site:

www.adt.com.tw/index.5/phtml. If you have any comments, please feel free to contact us at the following:

Linko EMC/RF Lab:

Tel: 886-2-26052180

Fax: 886-2-26051924

Hsin Chu EMC/RF Lab:

Tel: 886-3-5935343

Fax: 886-3-5935342

Hwa Ya EMC/RF/Safety Telecom Lab:

Tel: 886-3-3183232

Fax: 886-3-3185050

Web Site: www.adt.com.tw

The address and road map of all our labs can be found in our web site also.



A D T

8. APPENDIX A - MODIFICATIONS RECORDERS FOR ENGINEERING CHANGES TO THE EUT BY THE LAB

No any modifications are made to the EUT by the lab during the test.

---END---