



# FCC TEST REPORT

**REPORT NO.:** RF980831L03

**MODEL NO.:** DSLR-2000G (refer to item 3.1 for more details)

**RECEIVED:** Aug. 26, 2009

**TESTED:** Sep. 01 ~ Sep. 02, 2009

**ISSUED:** Sep. 07, 2009

**APPLICANT:** CAMEO COMMUNICATIONS, INC.

**ADDRESS:** No. 42, Sec. 6, Mincyuan E. Rd., Neihu District,  
Taipei City 114, Taiwan

**ISSUED BY:** Bureau Veritas Consumer Products Services (H.K.)  
Ltd., Taoyuan Branch

**LAB ADDRESS:** No. 47, 14th Ling, Chia Pau Tsuen, Lin Kou Hsiang,  
Taipei Hsien 244, Taiwan, R.O.C.

**TEST LOCATION:** No. 19, Hwa Ya 2nd Rd, Wen Hwa Tsuen, Kwei Shan  
Hsiang, Taoyuan Hsien 333, Taiwan, R.O.C.

This test report consists of 54 pages in total. It may be duplicated completely for legal use with the approval of the applicant. It should not be reproduced except in full, without the written approval of our laboratory. The client should not use it to claim product endorsement by TAF or any government agencies. The test results in the report only apply to the tested sample.





## TABLE OF CONTENTS

1.	CERTIFICATION .....	4
2.	SUMMARY OF TEST RESULTS .....	5
2.1	MEASUREMENT UNCERTAINTY .....	5
3.	GENERAL INFORMATION .....	6
3.1	GENERAL DESCRIPTION OF EUT .....	6
3.2	DESCRIPTION OF TEST MODES .....	7
3.2.1	CONFIGURATION OF SYSTEM UNDER TEST .....	7
3.2.2	TEST MODE APPLICABILITY AND TESTED CHANNEL DETAIL .....	8
3.3	GENERAL DESCRIPTION OF APPLIED STANDARDS .....	10
3.4	DESCRIPTION OF SUPPORT UNITS .....	10
4.	TEST TYPES AND RESULTS .....	11
4.1	RADIATED EMISSION MEASUREMENT .....	11
4.1.1	LIMITS OF RADIATED EMISSION MEASUREMENT .....	11
4.1.2	TEST INSTRUMENTS .....	12
4.1.3	TEST PROCEDURES .....	13
4.1.4	DEVIATION FROM TEST STANDARD .....	13
4.1.5	TEST SETUP .....	14
4.1.6	EUT OPERATING CONDITIONS .....	14
4.1.7	TEST RESULTS .....	15
4.2	CONDUCTED EMISSION MEASUREMENT .....	22
4.2.1	LIMITS OF CONDUCTED EMISSION MEASUREMENT .....	22
4.2.2	TEST INSTRUMENTS .....	22
4.2.3	TEST PROCEDURES .....	23
4.2.4	DEVIATION FROM TEST STANDARD .....	23
4.2.5	TEST SETUP .....	24
4.2.6	EUT OPERATING CONDITIONS .....	24
4.2.7	TEST RESULTS .....	25
4.3	6dB BANDWIDTH MEASUREMENT .....	27
4.3.1	LIMITS OF 6dB BANDWIDTH MEASUREMENT .....	27
4.3.2	TEST INSTRUMENTS .....	27
4.3.3	TEST PROCEDURE .....	27
4.3.4	DEVIATION FROM TEST STANDARD .....	27
4.3.5	TEST SETUP .....	28
4.3.6	EUT OPERATING CONDITIONS .....	28
4.3.7	TEST RESULTS .....	29



4.4	MAXIMUM PEAK OUTPUT POWER .....	33
4.4.1	LIMITS OF MAXIMUM PEAK OUTPUT POWER MEASUREMENT.....	33
4.4.2	INSTRUMENTS .....	33
4.4.3	TEST PROCEDURES.....	33
4.4.4	DEVIATION FROM TEST STANDARD .....	33
4.4.5	TEST SETUP .....	34
4.4.6	EUT OPERATING CONDITIONS.....	34
4.4.7	TEST RESULTS .....	35
4.5	POWER SPECTRAL DENSITY MEASUREMENT .....	36
4.5.1	LIMITS OF POWER SPECTRAL DENSITY MEASUREMENT .....	36
4.5.2	TEST INSTRUMENTS .....	36
4.5.3	TEST PROCEDURE .....	36
4.5.4	DEVIATION FROM TEST STANDARD .....	36
4.5.5	TEST SETUP .....	37
4.5.6	EUT OPERATING CONDITION .....	37
4.5.7	TEST RESULTS .....	38
4.6	BAND EDGES MEASUREMENT .....	42
4.6.1	LIMITS OF BAND EDGES MEASUREMENT .....	42
4.6.2	TEST INSTRUMENTS .....	42
4.6.3	TEST PROCEDURE .....	42
4.6.4	DEVIATION FROM TEST STANDARD .....	42
4.6.5	EUT OPERATING CONDITION .....	42
4.6.6	TEST RESULTS .....	43
4.7	ANTENNA REQUIREMENT .....	51
4.7.1	STANDARD APPLICABLE .....	51
4.7.2	ANTENNA CONNECTED CONSTRUCTION.....	51
5.	PHOTOGRAPHS OF THE TEST CONFIGURATION .....	52
6.	INFORMATION ON THE TESTING LABORATORIES.....	53
7.	APPENDIX A - MODIFICATIONS RECORDERS FOR ENGINEERING CHANGES TO THE EUT BY THE LAB.....	54



# 1. CERTIFICATION

**PRODUCT:** 802.11g WLAN ADSL2+ Router  
**MODEL:** DSLR-2000G (refer to item 3.1 for more details)  
**BRAND:** CAMEO (refer to item 3.1 for more details)  
**APPLICANT:** CAMEO COMMUNICATIONS, INC.  
**TESTED:** Sep. 01 ~ Sep. 02, 2009  
**TEST SAMPLE:** ENGINEERING SAMPLE  
**STANDARDS:** **FCC Part 15, Subpart C (Section 15.247)**  
ANSI C63.4-2003

The above equipment (model: DSLR-2000G) has been tested by **Bureau Veritas Consumer Products Services (H.K.) Ltd., Taoyuan Branch**, and found compliance with the requirement of the above standards. The test record, data evaluation & Equipment Under Test (EUT) configurations represented herein are true and accurate accounts of the measurements of the sample's EMC characteristics under the conditions specified in this report.

**PREPARED BY** :  , **DATE** : Sep. 07, 2009  
Joanna Wang / Senior Specialist

**TECHNICAL ACCEPTANCE** :  , **DATE** : Sep. 07, 2009  
Responsible for RF Long Chen / Senior Engineer

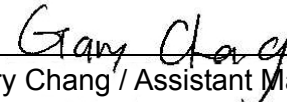
**APPROVED BY** :  , **DATE** : Sep. 07, 2009  
Gary Chang / Assistant Manager

## 2. SUMMARY OF TEST RESULTS

The EUT has been tested according to the following specifications:

APPLIED STANDARD: FCC Part 15, Subpart C			
Standard Section	Test Type and Limit	Result	Remark
15.207	AC Power Conducted Emission	PASS	Meet the requirement of limit. Minimum passing margin is -14.78dB at 0.154MHz.
15.247(a)(2)	Spectrum Bandwidth of a Direct Sequence Spread Spectrum System Limit: min. 500kHz	PASS	Meet the requirement of limit.
15.247(b)	Maximum Peak Output Power Limit: max. 30dBm	PASS	Meet the requirement of limit.
15.247(d)	Radiated Emissions Limit: Table 15.209	PASS	Meet the requirement of limit. Minimum passing margin is -2.11dB at 424.59MHz.
15.247(e)	Power Spectral Density Limit: max. 8dBm	PASS	Meet the requirement of limit.
15.247(d)	Band Edge Measurement Limit: 20dB less than the peak value of fundamental frequency	PASS	Meet the requirement of limit.

### 2.1 MEASUREMENT UNCERTAINTY

Where relevant, the following measurement uncertainty levels have been estimated for tests performed on the EUT as specified in CISPR 16-4-2:

MEASUREMENT	FREQUENCY	UNCERTAINTY
Conducted emissions	150kHz~30MHz	2.44dB
Radiated emissions	30MHz ~ 200MHz	3.34dB
	200MHz ~1000MHz	3.35dB
	1GHz ~ 18GHz	2.26dB
	18GHz ~ 40GHz	1.94dB

This uncertainty represents an expanded uncertainty expressed at approximately the 95% confidence level using a coverage factor of k=2.

### 3. GENERAL INFORMATION

#### 3.1 GENERAL DESCRIPTION OF EUT

<b>PRODUCT</b>	802.11g WLAN ADSL2+ Router
<b>MODEL NO.</b>	DSLRL-2000G (refer to NOTE 1 for more details)
<b>FCC ID</b>	NHPDSLRL2000G
<b>POWER SUPPLY</b>	12Vdc from adapter
<b>MODULATION TYPE</b>	CCK, DQPSK, DBPSK for DSSS 64QAM, 16QAM, QPSK, BPSK for OFDM
<b>MODULATION TECHNOLOGY</b>	DSSS, OFDM
<b>TRANSFER RATE</b>	802.11b: 11.0/ 5.5/ 2.0/ 1.0Mbps 802.11g: 54.0/ 48.0/ 36.0/ 24.0/ 18.0/ 12.0/ 9.0/ 6.0Mbps
<b>OPRTAING FREQUENCY</b>	2412MHz ~ 2462MHz
<b>NUMBER OF CHANNEL</b>	11
<b>MAXIMUM OUTPUT POWER</b>	163.31mW
<b>ANTENNA TYPE</b>	Dipole antenna with 2dBi gain
<b>DATA CABLE</b>	NA
<b>I/O PORTS</b>	RJ45, RJ11
<b>ACCESSORY DEVICES</b>	Adapter

**NOTE:**

1. The following models are provided to this EUT.

BRAND	MODEL	DESCRIPTION
CAMEO	DSLRL-2000G	All models are electrically identical, different model names and brand names are for marketing purpose.
TRENDnet	TEW-436BRM	

2. The EUT was powered by the following adapter:

<b>BRAND:</b>	LEADER ELECTRONICS INC.
<b>MODEL:</b>	MU12-N120100-A1
<b>INPUT:</b>	100-240Vac, 50/60Hz, 0.5A
<b>OUTPUT:</b>	12Vdc, 1A
<b>POWER LINE:</b>	1.5m non-shielded cable without core

3. The EUT, operates in the 2.4GHz frequency range, lets you connect IEEE 802.11g or IEEE 802.11b devices to the network. With its high-speed data transmissions of up to 54Mbps.
4. The above EUT information was declared by manufacturer and for more detailed features description, please refer to the manufacturer's specifications or User's Manual.

### 3.2 DESCRIPTION OF TEST MODES

Eleven channels are provided to this EUT:

CHANNEL	FREQUENCY	CHANNEL	FREQUENCY
1	2412MHz	7	2442MHz
2	2417MHz	8	2447MHz
3	2422MHz	9	2452MHz
4	2427MHz	10	2457MHz
5	2432MHz	11	2462MHz
6	2437MHz		

#### 3.2.1 CONFIGURATION OF SYSTEM UNDER TEST

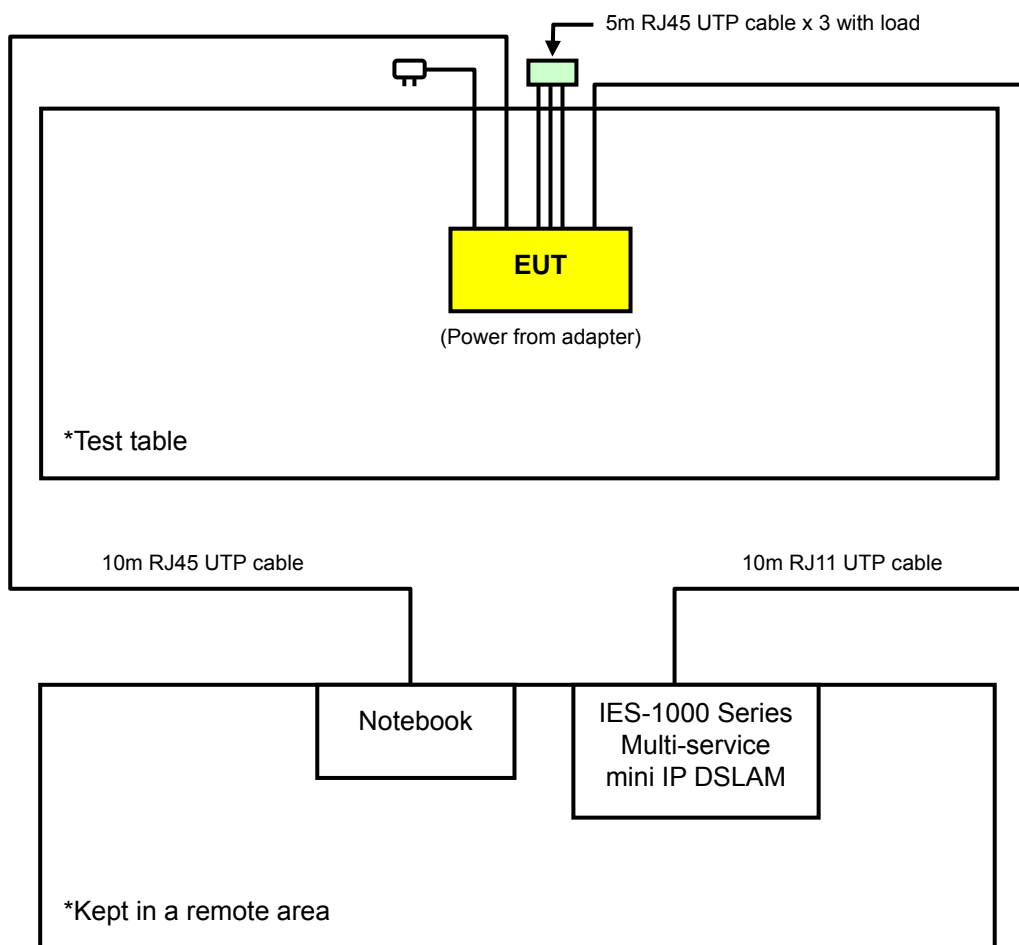

### 3.2.2 TEST MODE APPLICABILITY AND TESTED CHANNEL DETAIL

EUT CONFIGURE MODE	APPLICABLE TO				DESCRIPTION
	RE $\geq$ 1G	RE<1G	PLC	APCM	
-	√	√	√	√	-

Where **PLC**: Power Line Conducted Emission      **RE<1G**: Radiated Emission below 1GHz  
**RE $\geq$ 1G**: Radiated Emission above 1GHz      **APCM**: Antenna Port Conducted Measurement

#### RADIATED EMISSION TEST (ABOVE 1 GHz):

- Pre-Scan has been conducted to determine the worst-case mode from all possible combinations between available modulations, data rates, XYZ axis and antenna ports (if EUT with antenna diversity architecture).
- Following channel(s) was (were) selected for the final test as listed below.

MODE	AVAILABLE CHANNEL	TESTED CHANNEL	MODULATION TECHNOLOGY	MODULATION TYPE	DATA RATE (Mbps)	AXIS
802.11b	1 to 11	1, 6, 11	DSSS	DBPSK	1.0	X
802.11g	1 to 11	1, 6, 11	OFDM	BPSK	6.0	X

#### RADIATED EMISSION TEST (BELOW 1 GHz):

- Pre-Scan has been conducted to determine the worst-case mode from all possible combinations between available modulations, data rates, XYZ axis and antenna ports (if EUT with antenna diversity architecture).
- Following channel(s) was (were) selected for the final test as listed below.

MODE	AVAILABLE CHANNEL	TESTED CHANNEL	MODULATION TECHNOLOGY	MODULATION TYPE	DATA RATE (Mbps)	AXIS
802.11g	1 to 11	6	OFDM	BPSK	6.0	X

#### POWER LINE CONDUCTED EMISSION TEST:

- Pre-Scan has been conducted to determine the worst-case mode from all possible combinations between available modulations, data rates and antenna ports (if EUT with antenna diversity architecture).
- Following channel(s) was (were) selected for the final test as listed below.

MODE	AVAILABLE CHANNEL	TESTED CHANNEL	MODULATION TECHNOLOGY	MODULATION TYPE	DATA RATE (Mbps)
802.11g	1 to 11	6	OFDM	BPSK	6.0



**BANDEDGE MEASUREMENT:**

- Pre-Scan has been conducted to determine the worst-case mode from all possible combinations between available modulations, data rates and antenna ports (if EUT with antenna diversity architecture).
- Following channel(s) was (were) selected for the final test as listed below.

MODE	AVAILABLE CHANNEL	TESTED CHANNEL	MODULATION TECHNOLOGY	MODULATION TYPE	DATA RATE (Mbps)
802.11b	1 to 11	1, 11	DSSS	DBPSK	1.0
802.11g	1 to 11	1, 11	OFDM	BPSK	6.0

**ANTENNA PORT CONDUCTED MEASUREMENT:**

- Pre-Scan has been conducted to determine the worst-case mode from all possible combinations between available modulations, data rates and antenna ports (if EUT with antenna diversity architecture).
- Following channel(s) was (were) selected for the final test as listed below.

MODE	AVAILABLE CHANNEL	TESTED CHANNEL	MODULATION TECHNOLOGY	MODULATION TYPE	DATA RATE (Mbps)
802.11b	1 to 11	1, 6, 11	DSSS	DBPSK	1.0
802.11g	1 to 11	1, 6, 11	OFDM	BPSK	6.0

### 3.3 GENERAL DESCRIPTION OF APPLIED STANDARDS

The EUT is a RF product. According to the specifications of the manufacturer, it must comply with the requirements of the following standards:

#### **FCC Part 15, Subpart C (15.247)**

#### **ANSI C63.4-2003**

All test items have been performed and recorded as per the above standards.

**NOTE:** The EUT is also considered as a kind of computer peripheral, because the connection to computer is necessary for typical use. It has been verified to comply with the requirements of FCC Part 15, Subpart B, Class B (DoC). The test report has been issued separately.

### 3.4 DESCRIPTION OF SUPPORT UNITS

The EUT has been tested as an independent unit together with other necessary accessories or support units. The following support units or accessories were used to form a representative test configuration during the tests.

NO.	PRODUCT	BRAND	MODEL NO.	SERIAL NO.	FCC ID
1	NOTEBOOK	DELL	PP05L	16484462992	E2K24CLNS
2	IES-1000 SERIES MULTI-SERVICE MINI IP DSLAM	ZyXEL	IES-1000	S0700Z21012913	NA

NO.	SIGNAL CABLE DESCRIPTION OF THE ABOVE SUPPORT UNITS
1	10m RJ45 UTP cable.
2	10m RJ11 UTP cable.

**NOTE:**

1. All power cords of the above support units are non shielded (1.8m).
2. Item 1~2 acted as communication partners to transfer data.

## 4. TEST TYPES AND RESULTS

### 4.1 RADIATED EMISSION MEASUREMENT

#### 4.1.1 LIMITS OF RADIATED EMISSION MEASUREMENT

Emissions radiated outside of the specified bands, shall be according to the general radiated limits in 15.209 as following:

FREQUENCIES (MHz)	FIELD STRENGTH (microvolts/meter)	MEASUREMENT DISTANCE (meters)
0.009 ~ 0.490	2400 / F(kHz)	300
0.490 ~ 1.705	24000 / F(kHz)	30
1.705 ~ 30.0	30	30
30 ~ 88	100	3
88 ~ 216	150	3
216 ~ 960	200	3
Above 960	500	3

**NOTE:**

1. The lower limit shall apply at the transition frequencies.
2. Emission level (dBuV/m) = 20 log Emission level (uV/m).
3. As shown in 15.35(b), for frequencies above 1000MHz, the field strength limits are based on average detector, however, the peak field strength of any emission shall not exceed the maximum permitted average limits, specified above by more than 20dB under any condition of modulation.



#### 4.1.2 TEST INSTRUMENTS

DESCRIPTION & MANUFACTURER	MODEL NO.	SERIAL NO.	DATE OF CALIBRATION	DUE DATE OF CALIBRATION
Test Receiver ROHDE & SCHWARZ	ESI7	100033	Jul. 06, 2009	Jul. 05, 2010
Spectrum Analyzer ROHDE & SCHWARZ	FSP40	100076	May 26, 2009	May 25, 2010
BILOG Antenna SCHWARZBECK	VULB9168	9168-160	Apr. 27, 2009	Apr. 26, 2010
HORN Antenna SCHWARZBECK	9120D	9120D-209	Jul. 01, 2009	Jun. 30, 2010
HORN Antenna SCHWARZBECK	BBHA 9170	BBHA9170243	Dec. 25, 2008	Dec. 24, 2009
Preamplifier Agilent	8447D	2944A10633	Nov. 03, 2008	Nov. 02, 2009
Preamplifier Agilent	8449B	3008A01964	Oct. 23, 2008	Oct. 22, 2009
RF signal cable HUBER+SUHNNER	SUCOFLEX 104	238141/4	May 13, 2009	May 12, 2010
RF signal cable HUBER+SUHNNER	SUCOFLEX 104	12738/6	May 13, 2009	May 12, 2010
Software ADT.	ADT_Radiated_ V7.6.15.9.2	NA	NA	NA
Antenna Tower inn-co GmbH	MA 4000	013303	NA	NA
Antenna Tower Controller inn-co GmbH	CO2000	017303	NA	NA
Turn Table ADT.	TT100.	TT93021703	NA	NA
Turn Table Controller ADT.	SC100.	SC93021703	NA	NA

- NOTE:**
1. The calibration interval of the above test instruments is 12 months and the calibrations are traceable to NML/ROC and NIST/USA.
  2. The test was performed in HwaYa Chamber 3.
  3. The horn antenna and HP preamplifier (model: 8449B) are used only for the measurement of emission frequency above 1GHz if tested.
  4. The FCC Site Registration No. is 988962.
  5. The IC Site Registration No. is IC 7450F-3.

#### 4.1.3 TEST PROCEDURES

- a. The EUT was placed on the top of a rotating table 0.8 meters above the ground at a 3 meters semi-anechoic chamber. The table was rotated 360 degrees to determine the position of the highest radiation.
- b. The EUT was set 3 meters away from the interference-receiving antenna, which was mounted on the top of a variable-height antenna tower.
- c. The antenna is a broadband antenna, and its height is varied from one meter to four meters above the ground to determine the maximum value of the field strength. Both horizontal and vertical polarizations of the antenna are set to make the measurement.
- d. For each suspected emission, the EUT was arranged to its worst case and then the antenna was tuned to heights from 1 meter to 4 meters and the rotatable table was turned from 0 degrees to 360 degrees to find the maximum reading.
- e. The test-receiver system was set to Peak Detect Function and Specified Bandwidth with Maximum Hold Mode.
- f. If the emission level of the EUT in peak mode was lower than the limit specified, then testing could be stopped and the peak values of the EUT would be reported. Otherwise the emissions would be re-tested one by one using peak, quasi-peak or average method as specified and then reported in a data sheet.

**NOTE:**

1. The resolution bandwidth and video bandwidth of test receiver/spectrum analyzer is 120kHz for Peak detection (PK) and Quasi-peak detection (QP) at frequency below 1GHz.
2. The resolution bandwidth of test receiver/spectrum analyzer is 1 MHz and video bandwidth is 3MHz for Peak detection at frequency above 1GHz.
3. The resolution bandwidth of test receiver/spectrum analyzer is 1MHz and the video bandwidth is 10Hz for Average detection (AV) at frequency above 1GHz.
4. All modes of operation were investigated and the worst-case emissions are reported.

#### 4.1.4 DEVIATION FROM TEST STANDARD

No deviation.

#### 4.1.5 TEST SETUP

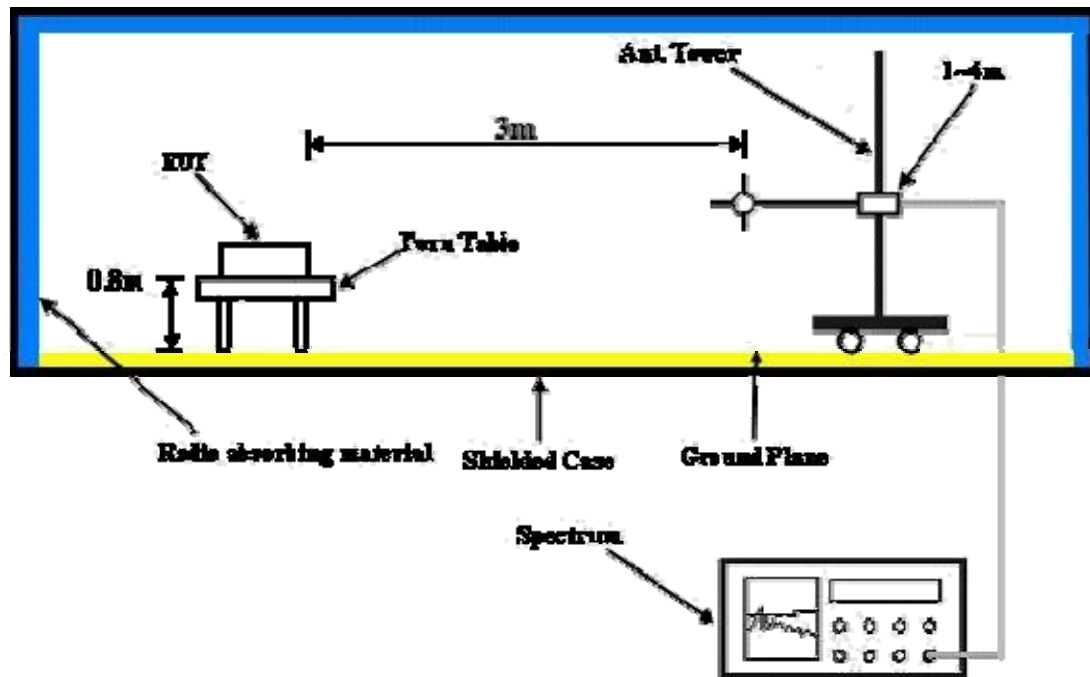

For the actual test configuration, please refer to the attached file (Test Setup Photo)

#### 4.1.6 EUT OPERATING CONDITIONS

- Placed the EUT on the testing table.
- Prepared a notebook and IES-1000 Series Multi-service mini IP DSLAM outside of testing area to act as communication partners.
- The notebook ran a test program (provided by manufacturer) to enable EUT under transmission condition continuously at specific channel frequency.
- The notebook sent data to EUT by command "PING".
- The IES-1000 Series Multi-service mini IP DSLAM made a communication to the EUT via RJ11 cable.

#### 4.1.7 TEST RESULTS

##### 802.11b DSSS MODULATION

EUT TEST CONDITION		MEASUREMENT DETAIL	
CHANNEL	Channel 1	FREQUENCY RANGE	1 ~ 25GHz
INPUT POWER	120Vac, 60 Hz	DETECTOR FUNCTION	Peak (PK) Average (AV)
ENVIRONMENTAL CONDITIONS	25deg. C, 65%RH 1008 hPa	TESTED BY	Lori Chiu

ANTENNA POLARITY & TEST DISTANCE: HORIZONTAL AT 3 M								
NO.	FREQ. (MHz)	EMISSION LEVEL (dBuV/m)	LIMIT (dBuV/m)	MARGIN (dB)	ANTENNA HEIGHT (m)	TABLE ANGLE (Degree)	RAW VALUE (dBuV)	CORRECTION FACTOR (dB/m)
1	2386.00	56.00 PK	74.00	-18.00	1.28 H	38	25.36	30.64
2	2386.00	45.70 AV	54.00	-8.30	1.28 H	38	15.06	30.64
3	*2412.00	103.01 PK			1.28 H	38	72.28	30.73
4	*2412.00	98.55 AV			1.28 H	38	67.82	30.73
5	4824.00	46.72 PK	74.00	-27.28	1.16 H	36	10.30	36.42
6	4824.00	35.33 AV	54.00	-18.67	1.16 H	36	-1.09	36.42

ANTENNA POLARITY & TEST DISTANCE: VERTICAL AT 3 M								
NO.	FREQ. (MHz)	EMISSION LEVEL (dBuV/m)	LIMIT (dBuV/m)	MARGIN (dB)	ANTENNA HEIGHT (m)	TABLE ANGLE (Degree)	RAW VALUE (dBuV)	CORRECTION FACTOR (dB/m)
1	2386.00	59.29 PK	74.00	-14.71	1.12 V	13	28.65	30.64
2	2386.00	49.17 AV	54.00	-4.83	1.12 V	13	18.53	30.64
3	*2412.00	111.36 PK			1.10 V	82	80.63	30.73
4	*2412.00	106.93 AV			1.10 V	82	76.20	30.73
5	4824.00	49.23 PK	74.00	-24.77	1.12 V	19	12.81	36.42
6	4824.00	38.59 AV	54.00	-15.41	1.12 V	19	2.17	36.42

- REMARKS:**
1. Emission level (dBuV/m) = Raw Value (dBuV) + Correction Factor (dB/m).
  2. Correction Factor (dB/m) = Antenna Factor (dB/m) + Cable Factor (dB).
  3. The other emission levels were very low against the limit.
  4. Margin value = Emission level – Limit value.
  5. “ \* “: Fundamental frequency.



A D T

EUT TEST CONDITION		MEASUREMENT DETAIL	
CHANNEL	Channel 6	FREQUENCY RANGE	1 ~ 25GHz
INPUT POWER	120Vac, 60 Hz	DETECTOR FUNCTION	Peak (PK) Average (AV)
ENVIRONMENTAL CONDITIONS	25deg. C, 65%RH 1008 hPa	TESTED BY	Lori Chiu

ANTENNA POLARITY & TEST DISTANCE: HORIZONTAL AT 3 M								
NO.	FREQ. (MHz)	EMISSION LEVEL (dBuV/m)	LIMIT (dBuV/m)	MARGIN (dB)	ANTENNA HEIGHT (m)	TABLE ANGLE (Degree)	RAW VALUE (dBuV)	CORRECTION FACTOR (dB/m)
1	*2437.00	102.94 PK			1.24 H	40	72.13	30.81
2	*2437.00	98.43 AV			1.24 H	40	67.62	30.81
3	4874.00	47.10 PK	74.00	-26.90	1.00 H	169	10.63	36.47
4	4874.00	35.01 AV	54.00	-18.99	1.00 H	169	-1.46	36.47
ANTENNA POLARITY & TEST DISTANCE: VERTICAL AT 3 M								
NO.	FREQ. (MHz)	EMISSION LEVEL (dBuV/m)	LIMIT (dBuV/m)	MARGIN (dB)	ANTENNA HEIGHT (m)	TABLE ANGLE (Degree)	RAW VALUE (dBuV)	CORRECTION FACTOR (dB/m)
1	*2437.00	111.31 PK			1.11 V	210	80.50	30.81
2	*2437.00	106.75 AV			1.11 V	210	75.94	30.81
3	4874.00	48.44 PK	74.00	-25.56	1.10 V	19	11.97	36.47
4	4874.00	38.08 AV	54.00	-15.92	1.10 V	19	1.61	36.47

- REMARKS:**
1. Emission level (dBuV/m) = Raw Value (dBuV) + Correction Factor (dB/m).
  2. Correction Factor (dB/m) = Antenna Factor (dB/m) + Cable Factor (dB).
  3. The other emission levels were very low against the limit.
  4. Margin value = Emission level – Limit value.
  5. “ \* “: Fundamental frequency.





A D T

EUT TEST CONDITION		MEASUREMENT DETAIL	
CHANNEL	Channel 11	FREQUENCY RANGE	1 ~ 25GHz
INPUT POWER	120Vac, 60 Hz	DETECTOR FUNCTION	Peak (PK) Average (AV)
ENVIRONMENTAL CONDITIONS	25deg. C, 65%RH 1008 hPa	TESTED BY	Lori Chiu

ANTENNA POLARITY & TEST DISTANCE: HORIZONTAL AT 3 M								
NO.	FREQ. (MHz)	EMISSION LEVEL (dBuV/m)	LIMIT (dBuV/m)	MARGIN (dB)	ANTENNA HEIGHT (m)	TABLE ANGLE (Degree)	RAW VALUE (dBuV)	CORRECTION FACTOR (dB/m)
1	*2462.00	102.88 PK			1.30 H	40	71.99	30.89
2	*2462.00	98.34 AV			1.30 H	40	67.45	30.89
3	2483.50	55.37 PK	74.00	-18.63	1.30 H	40	24.41	30.96
4	2483.50	45.46 AV	54.00	-8.54	1.30 H	40	14.50	30.96
5	4924.00	47.27 PK	74.00	-26.73	1.23 H	202	10.69	36.58
6	4924.00	34.24 AV	54.00	-19.76	1.23 H	202	-2.34	36.58
ANTENNA POLARITY & TEST DISTANCE: VERTICAL AT 3 M								
NO.	FREQ. (MHz)	EMISSION LEVEL (dBuV/m)	LIMIT (dBuV/m)	MARGIN (dB)	ANTENNA HEIGHT (m)	TABLE ANGLE (Degree)	RAW VALUE (dBuV)	CORRECTION FACTOR (dB/m)
1	*2462.00	111.29 PK			1.08 V	83	80.40	30.89
2	*2462.00	106.86 AV			1.08 V	83	75.97	30.89
3	2483.50	56.55 PK	74.00	-17.45	1.08 V	83	25.59	30.96
4	2483.50	46.56 AV	54.00	-7.44	1.08 V	83	15.60	30.96
5	4924.00	46.84 PK	74.00	-27.16	1.01 V	180	10.26	36.58
6	4924.00	35.40 AV	54.00	-18.60	1.01 V	180	-1.18	36.58

- REMARKS:**
1. Emission level (dBuV/m) = Raw Value (dBuV) + Correction Factor (dB/m).
  2. Correction Factor (dB/m) = Antenna Factor (dB/m) + Cable Factor (dB).
  3. The other emission levels were very low against the limit.
  4. Margin value = Emission level – Limit value.
  5. “ \* “: Fundamental frequency.

### 802.11g OFDM MODULATION

EUT TEST CONDITION		MEASUREMENT DETAIL	
CHANNEL	Channel 1	FREQUENCY RANGE	1 ~ 25GHz
INPUT POWER	120Vac, 60 Hz	DETECTOR FUNCTION	Peak (PK) Average (AV)
ENVIRONMENTAL CONDITIONS	25deg. C, 65%RH 1008 hPa	TESTED BY	Lori Chiu

ANTENNA POLARITY & TEST DISTANCE: HORIZONTAL AT 3 M								
NO.	FREQ. (MHz)	EMISSION LEVEL (dBuV/m)	LIMIT (dBuV/m)	MARGIN (dB)	ANTENNA HEIGHT (m)	TABLE ANGLE (Degree)	RAW VALUE (dBuV)	CORRECTION FACTOR (dB/m)
1	2390.00	57.07 PK	74.00	-16.93	1.08 H	180	26.42	30.65
2	2390.00	45.25 AV	54.00	-8.75	1.08 H	180	14.60	30.65
3	*2412.00	98.79 PK			1.08 H	180	68.06	30.73
4	*2412.00	89.93 AV			1.08 H	180	59.20	30.73
5	4824.00	47.19 PK	74.00	-26.81	1.00 H	316	10.77	36.42
6	4824.00	34.10 AV	54.00	-19.90	1.00 H	316	-2.32	36.42
ANTENNA POLARITY & TEST DISTANCE: VERTICAL AT 3 M								
NO.	FREQ. (MHz)	EMISSION LEVEL (dBuV/m)	LIMIT (dBuV/m)	MARGIN (dB)	ANTENNA HEIGHT (m)	TABLE ANGLE (Degree)	RAW VALUE (dBuV)	CORRECTION FACTOR (dB/m)
1	2390.00	60.74 PK	74.00	-13.26	1.10 V	36	30.09	30.65
2	2390.00	47.07 AV	54.00	-6.93	1.10 V	36	16.42	30.65
3	*2412.00	109.10 PK			1.10 V	36	78.37	30.73
4	*2412.00	99.14 AV			1.10 V	36	68.41	30.73
5	4824.00	47.12 PK	74.00	-26.88	1.01 V	115	10.70	36.42
6	4824.00	34.33 AV	54.00	-19.67	1.01 V	115	-2.09	36.42

- REMARKS:**
1. Emission level (dBuV/m) = Raw Value (dBuV) + Correction Factor (dB/m).
  2. Correction Factor (dB/m) = Antenna Factor (dB/m) + Cable Factor (dB).
  3. The other emission levels were very low against the limit.
  4. Margin value = Emission level – Limit value.
  5. “ \* “: Fundamental frequency.



A D T

EUT TEST CONDITION		MEASUREMENT DETAIL	
CHANNEL	Channel 6	FREQUENCY RANGE	1 ~ 25GHz
INPUT POWER	120Vac, 60 Hz	DETECTOR FUNCTION	Peak (PK) Average (AV)
ENVIRONMENTAL CONDITIONS	25deg. C, 65%RH 1008 hPa	TESTED BY	Lori Chiu

ANTENNA POLARITY & TEST DISTANCE: HORIZONTAL AT 3 M								
NO.	FREQ. (MHz)	EMISSION LEVEL (dBuV/m)	LIMIT (dBuV/m)	MARGIN (dB)	ANTENNA HEIGHT (m)	TABLE ANGLE (Degree)	RAW VALUE (dBuV)	CORRECTION FACTOR (dB/m)
1	*2437.00	99.38 PK			1.21 H	193	68.57	30.81
2	*2437.00	90.00 AV			1.21 H	193	59.19	30.81
3	4874.00	47.36 PK	74.00	-26.64	1.33 H	258	10.89	36.47
4	4874.00	34.20 AV	54.00	-19.80	1.33 H	258	-2.27	36.47
ANTENNA POLARITY & TEST DISTANCE: VERTICAL AT 3 M								
NO.	FREQ. (MHz)	EMISSION LEVEL (dBuV/m)	LIMIT (dBuV/m)	MARGIN (dB)	ANTENNA HEIGHT (m)	TABLE ANGLE (Degree)	RAW VALUE (dBuV)	CORRECTION FACTOR (dB/m)
1	*2437.00	109.55 PK			1.11 V	35	78.74	30.81
2	*2437.00	99.83 AV			1.11 V	35	69.02	30.81
3	4874.00	47.25 PK	74.00	-26.75	1.22 V	200	10.78	36.47
4	4874.00	34.15 AV	54.00	-19.85	1.22 V	200	-2.32	36.47

- REMARKS:**
1. Emission level (dBuV/m) = Raw Value (dBuV) + Correction Factor (dB/m).
  2. Correction Factor (dB/m) = Antenna Factor (dB/m) + Cable Factor (dB).
  3. The other emission levels were very low against the limit.
  4. Margin value = Emission level – Limit value.
  5. “ \* “: Fundamental frequency.



A D T

EUT TEST CONDITION		MEASUREMENT DETAIL	
CHANNEL	Channel 11	FREQUENCY RANGE	1 ~ 25GHz
INPUT POWER	120Vac, 60 Hz	DETECTOR FUNCTION	Peak (PK) Average (AV)
ENVIRONMENTAL CONDITIONS	25deg. C, 65%RH 1008 hPa	TESTED BY	Lori Chiu

ANTENNA POLARITY & TEST DISTANCE: HORIZONTAL AT 3 M								
NO.	FREQ. (MHz)	EMISSION LEVEL (dBuV/m)	LIMIT (dBuV/m)	MARGIN (dB)	ANTENNA HEIGHT (m)	TABLE ANGLE (Degree)	RAW VALUE (dBuV)	CORRECTION FACTOR (dB/m)
1	*2462.00	99.07 PK			1.07 H	182	68.18	30.89
2	*2462.00	90.09 AV			1.07 H	182	59.20	30.89
3	2483.50	57.35 PK	74.00	-16.65	1.07 H	182	26.39	30.96
4	2483.50	45.54 AV	54.00	-8.46	1.07 H	182	14.58	30.96
5	4924.00	47.05 PK	74.00	-26.95	1.01 H	112	10.47	36.58
6	4924.00	34.07 AV	54.00	-19.93	1.01 H	112	-2.51	36.58
ANTENNA POLARITY & TEST DISTANCE: VERTICAL AT 3 M								
NO.	FREQ. (MHz)	EMISSION LEVEL (dBuV/m)	LIMIT (dBuV/m)	MARGIN (dB)	ANTENNA HEIGHT (m)	TABLE ANGLE (Degree)	RAW VALUE (dBuV)	CORRECTION FACTOR (dB/m)
1	*2462.00	109.34 PK			1.08 V	35	78.45	30.89
2	*2462.00	99.41 AV			1.08 V	35	68.52	30.89
3	2483.50	66.82 PK	74.00	-7.18	1.04 V	33	35.86	30.96
4	2483.50	49.13 AV	54.00	-4.87	1.04 V	33	18.17	30.96
5	4924.00	47.04 PK	74.00	-26.96	1.05 V	100	10.46	36.58
6	4924.00	34.32 AV	54.00	-19.68	1.05 V	100	-2.26	36.58

- REMARKS:**
1. Emission level (dBuV/m) = Raw Value (dBuV) + Correction Factor (dB/m).
  2. Correction Factor (dB/m) = Antenna Factor (dB/m) + Cable Factor (dB).
  3. The other emission levels were very low against the limit.
  4. Margin value = Emission level – Limit value.
  5. “ \* “: Fundamental frequency.

**BELOW 1GHz WORST-CASE DATA : 802.11g OFDM MODULATION**

EUT TEST CONDITION		MEASUREMENT DETAIL	
CHANNEL	Channel 6	FREQUENCY RANGE	Below 1000MHz
INPUT POWER	120Vac, 60 Hz	DETECTOR FUNCTION	Quasi-Peak
ENVIRONMENTAL CONDITIONS	25deg. C, 65%RH 1008 hPa	TESTED BY	Lori Chiu

ANTENNA POLARITY & TEST DISTANCE: HORIZONTAL AT 3 M								
NO.	FREQ. (MHz)	EMISSION LEVEL (dBuV/m)	LIMIT (dBuV/m)	MARGIN (dB)	ANTENNA HEIGHT (m)	TABLE ANGLE (Degree)	RAW VALUE (dBuV)	CORRECTION FACTOR (dB/m)
1	249.60	42.54 QP	46.00	-3.46	1.00 H	250	28.74	13.80
2	352.65	40.33 QP	46.00	-5.67	1.00 H	277	24.28	16.06
3	<b>424.59</b>	<b>43.89 QP</b>	<b>46.00</b>	<b>-2.11</b>	<b>2.00 H</b>	<b>184</b>	<b>25.23</b>	<b>18.66</b>
4	500.42	38.49 QP	46.00	-7.51	1.50 H	328	18.05	20.44
5	601.52	37.30 QP	46.00	-8.70	1.50 H	10	14.86	22.44
6	725.96	37.24 QP	46.00	-8.76	1.00 H	340	11.97	25.28
ANTENNA POLARITY & TEST DISTANCE: VERTICAL AT 3 M								
NO.	FREQ. (MHz)	EMISSION LEVEL (dBuV/m)	LIMIT (dBuV/m)	MARGIN (dB)	ANTENNA HEIGHT (m)	TABLE ANGLE (Degree)	RAW VALUE (dBuV)	CORRECTION FACTOR (dB/m)
1	55.18	31.30 QP	40.00	-8.70	1.25 V	151	18.28	13.03
2	68.79	31.94 QP	40.00	-8.06	1.00 V	55	18.72	13.22
3	249.60	37.96 QP	46.00	-8.04	1.00 V	88	24.16	13.80
4	352.65	39.64 QP	46.00	-6.36	1.50 V	253	23.58	16.06
5	424.59	41.54 QP	46.00	-4.46	1.25 V	244	22.88	18.66
6	500.42	37.43 QP	46.00	-8.57	1.00 V	73	16.99	20.44
7	875.67	37.26 QP	46.00	-8.74	1.00 V	13	9.83	27.43

- REMARKS:**
1. Emission level (dBuV/m) = Raw Value (dBuV) + Correction Factor (dB/m).
  2. Correction Factor (dB/m) = Antenna Factor (dB/m) + Cable Factor (dB).
  3. The other emission levels were very low against the limit.
  4. Margin value = Emission level – Limit value.

## 4.2 CONDUCTED EMISSION MEASUREMENT

### 4.2.1 LIMITS OF CONDUCTED EMISSION MEASUREMENT

FREQUENCY OF EMISSION (MHz)	CONDUCTED LIMIT (dB $\mu$ V)	
	Quasi-peak	Average
0.15-0.5	66 to 56	56 to 46
0.5-5	56	46
5-30	60	50

- NOTE:**
1. The lower limit shall apply at the transition frequencies.
  2. The limit decreases in line with the logarithm of the frequency in the range of 0.15 to 0.50 MHz.
  3. All emanations from a class A/B digital device or system, including any network of conductors and apparatus connected thereto, shall not exceed the level of field strengths specified above.

### 4.2.2 TEST INSTRUMENTS

DESCRIPTION & MANUFACTURER	MODEL NO.	SERIAL NO.	DATE OF CALIBRATION	DUE DATE OF CALIBRATION
Test Receiver ROHDE & SCHWARZ	ESCS30	100288	Sep. 22, 2008	Sep. 21, 2009
RF signal cable Woken	5D-FB	Cable-HYCO2-01	Dec. 31, 2008	Dec. 30, 2009
LISN ROHDE & SCHWARZ	ESH2-Z5	100100	Dec. 29, 2008	Dec. 28, 2009
LISN ROHDE & SCHWARZ	ESH3-Z5	100311	Jul. 29, 2009	Jul. 28, 2010
Software ADT	ADT_Cond_ V7.3.7	NA	NA	NA

- NOTE:**
1. The calibration interval of the above test instruments is 12 months and the calibrations are traceable to NML/ROC and NIST/USA.
  2. The test was performed in HwaYa Shielded Room 2.
  3. The VCCI Site Registration No. is C-2047.

#### 4.2.3 TEST PROCEDURES

- a. The EUT was placed 0.4 meters from the conducting wall of the shielded room with EUT being connected to the power mains through a line impedance stabilization network (LISN). Other support units were connected to the power mains through another LISN. The two LISNs provide 50 ohm/ 50uH of coupling impedance for the measuring instrument.
- b. Both lines of the power mains connected to the EUT were checked for maximum conducted interference.
- c. The frequency range from 150kHz to 30MHz was searched. Emission levels under (Limit - 20dB) was not recorded.

**NOTE:** All modes of operation were investigated and the worst-case emissions are reported.

#### 4.2.4 DEVIATION FROM TEST STANDARD

No deviation.

#### 4.2.5 TEST SETUP

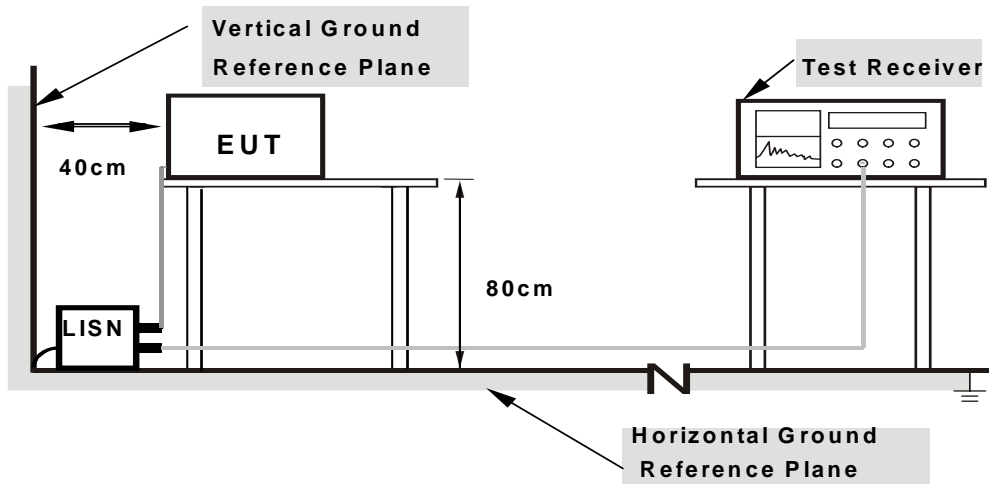

- Note:**
1. Support units were connected to second LISN.
  2. Both of LISNs (AMN) are 80 cm from EUT and at least 80 from other units and other metal planes

For the actual test configuration, please refer to the attached file (Test Setup Photo).

#### 4.2.6 EUT OPERATING CONDITIONS

Same as 4.1.6.



#### 4.2.7 TEST RESULTS

##### CONDUCTED WORST-CASE DATA: 802.11g OFDM MODULATION

EUT TEST CONDITION		MEASUREMENT DETAIL	
CHANNEL	Channel 6	PHASE	Line 1
MODULATION TYPE	BPSK	INPUT POWER	120Vac, 60Hz
TRANSFER RATE	6.0Mbps	6dB BANDWIDTH	9kHz
ENVIRONMENTAL CONDITIONS	25deg. C, 65%RH, 1008hPa	TESTED BY	Lori Chiu

No	Freq. [MHz]	Corr. Factor (dB)	Reading Value [dB (uV)]		Emission Level [dB (uV)]		Limit [dB (uV)]		Margin (dB)	
			Q.P.	AV.	Q.P.	AV.	Q.P.	AV.	Q.P.	AV.
1	0.154	0.13	50.76	-	50.89	-	65.79	55.79	-14.90	-
2	0.201	0.13	44.47	-	44.60	-	63.58	53.58	-18.98	-
3	0.271	0.13	39.31	-	39.44	-	61.08	51.08	-21.64	-
4	0.373	0.14	32.87	-	33.01	-	58.44	48.44	-25.43	-
5	0.474	0.14	26.79	-	26.93	-	56.44	46.44	-29.51	-
6	16.512	0.59	36.07	-	36.66	-	60.00	50.00	-23.34	-

- REMARKS:**
1. Q.P. and AV. are abbreviations of quasi-peak and average individually.
  2. "-": The Quasi-peak reading value also meets average limit and measurement with the average detector is unnecessary.
  3. The emission levels of other frequencies were very low against the limit.
  4. Margin value = Emission level - Limit value
  5. Correction factor = Insertion loss + Cable loss
  6. Emission Level = Correction Factor + Reading Value.

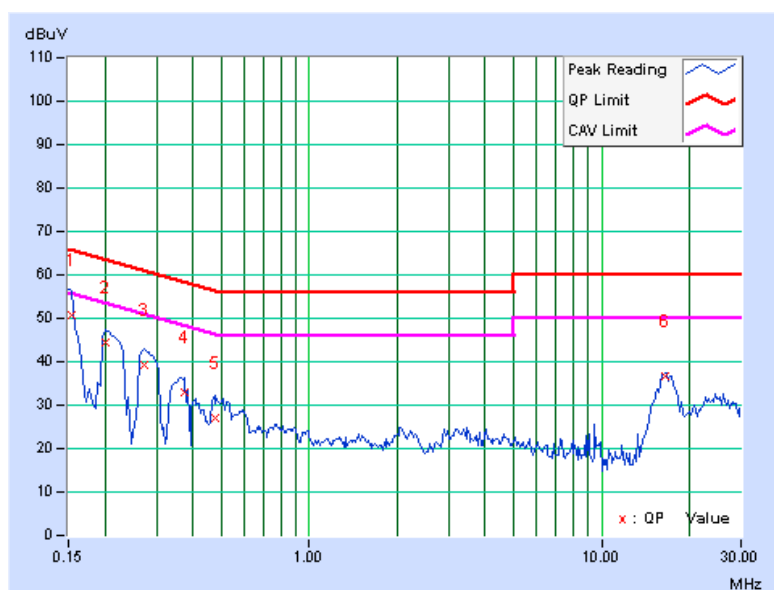

EUT TEST CONDITION		MEASUREMENT DETAIL	
CHANNEL	Channel 6	PHASE	Line 2
MODULATION TYPE	BPSK	INPUT POWER	120Vac, 60Hz
TRANSFER RATE	6.0Mbps	6dB BANDWIDTH	9kHz
ENVIRONMENTAL CONDITIONS	25deg. C, 65%RH, 1008hPa	TESTED BY	Lori Chiu

No	Freq. [MHz]	Corr. Factor (dB)	Reading Value [dB (uV)]		Emission Level [dB (uV)]		Limit [dB (uV)]		Margin (dB)	
			Q.P.	AV.	Q.P.	AV.	Q.P.	AV.	Q.P.	AV.
1	0.154	0.13	50.88	-	51.01	-	65.79	55.79	-14.78	-
2	0.201	0.13	44.06	-	44.19	-	63.58	53.58	-19.39	-
3	0.267	0.14	38.64	-	38.78	-	61.20	51.20	-22.43	-
4	0.373	0.15	32.06	-	32.21	-	58.44	48.44	-26.23	-
5	0.494	0.15	27.35	-	27.50	-	56.10	46.10	-28.60	-
6	16.305	0.71	32.74	-	33.45	-	60.00	50.00	-26.55	-

- REMARKS:**
1. Q.P. and AV. are abbreviations of quasi-peak and average individually.
  2. "-": The Quasi-peak reading value also meets average limit and measurement with the average detector is unnecessary.
  3. The emission levels of other frequencies were very low against the limit.
  4. Margin value = Emission level - Limit value
  5. Correction factor = Insertion loss + Cable loss
  6. Emission Level = Correction Factor + Reading Value.

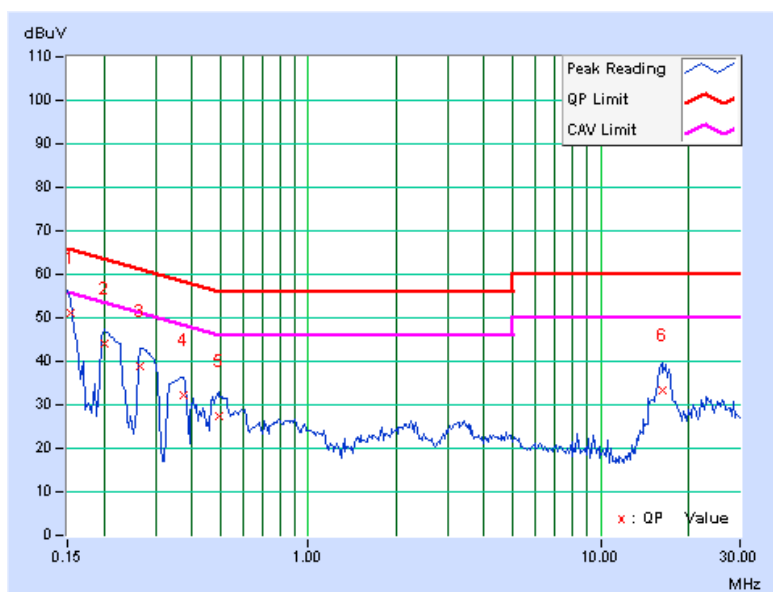

### 4.3 6dB BANDWIDTH MEASUREMENT

#### 4.3.1 LIMITS OF 6dB BANDWIDTH MEASUREMENT

The minimum of 6dB Bandwidth Measurement is 0.5 MHz.

#### 4.3.2 TEST INSTRUMENTS

DESCRIPTION & MANUFACTURER	MODEL NO.	SERIAL NO.	DATE OF CALIBRATION	DUE DATE OF CALIBRATION
SPECTRUM ANALYZER R&S	FSP40	100040	Jul. 07, 2009	Jul. 06, 2010

**NOTE:** The calibration interval of the above test instruments is 12 months and the calibrations are traceable to NML/ROC and NIST/USA.

#### 4.3.3 TEST PROCEDURE

The transmitter output was connected to the spectrum analyzer through an attenuator. The bandwidth of the fundamental frequency was measured by spectrum analyzer with 100kHz RBW and 300kHz VBW. The 6dB bandwidth is defined as the total spectrum the power of which is higher than peak power minus 6dB.

#### 4.3.4 DEVIATION FROM TEST STANDARD

No deviation.

#### 4.3.5 TEST SETUP

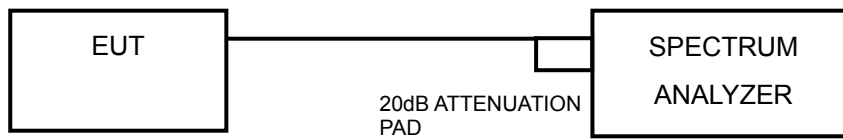

#### 4.3.6 EUT OPERATING CONDITIONS

The software provided by client to enable the EUT under transmission condition continuously at lowest, middle and highest channel frequencies individually.



A D T

### 4.3.7 TEST RESULTS

#### 802.11b DSSS MODULATION

<b>MODULATION TYPE</b>	DBPSK	<b>TRANSFER RATE</b>	1.0Mbps
<b>INPUT POWER</b>	120Vac, 60 Hz	<b>ENVIRONMENTAL CONDITIONS</b>	23deg. C, 70%RH, 1007hPa
<b>TESTED BY</b>	Dean Wang		

CHANNEL	CHANNEL FREQUENCY (MHz)	6dB BANDWIDTH (MHz)	MINIMUM LIMIT (MHz)	PASS / FAIL
1	2412	10.09	0.5	PASS
6	2437	10.09	0.5	PASS
11	2462	10.10	0.5	PASS

#### CH 1

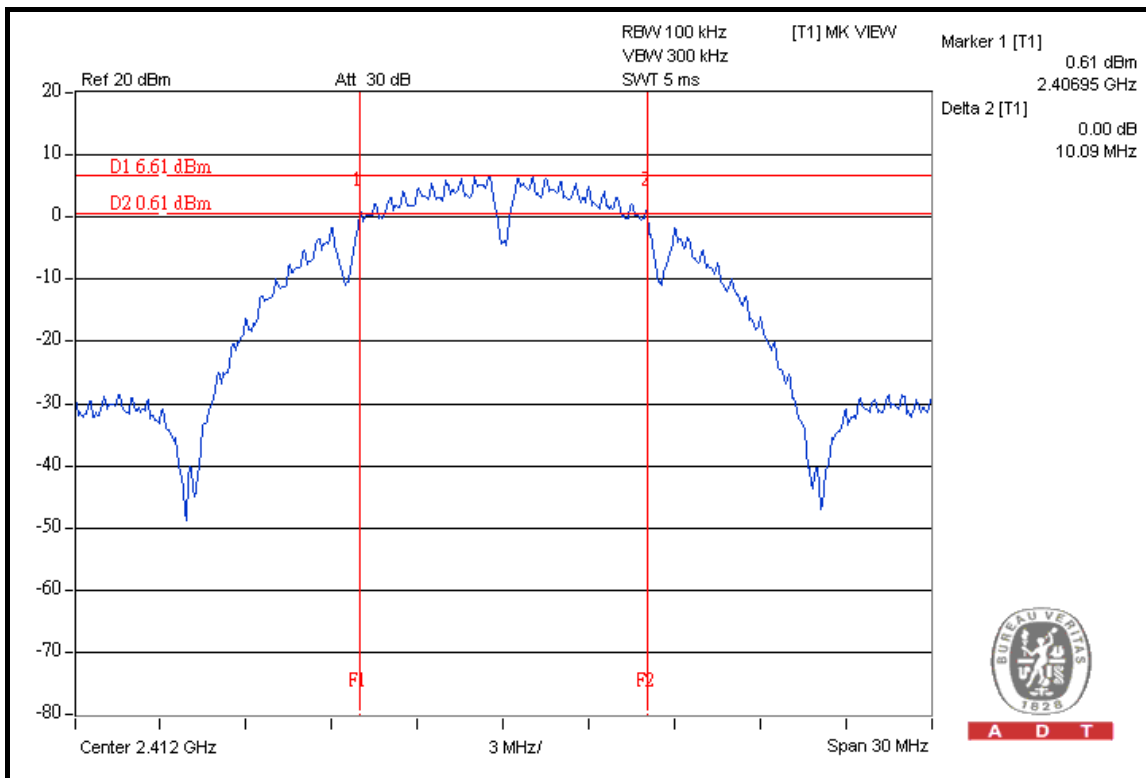



A D T

### CH 6

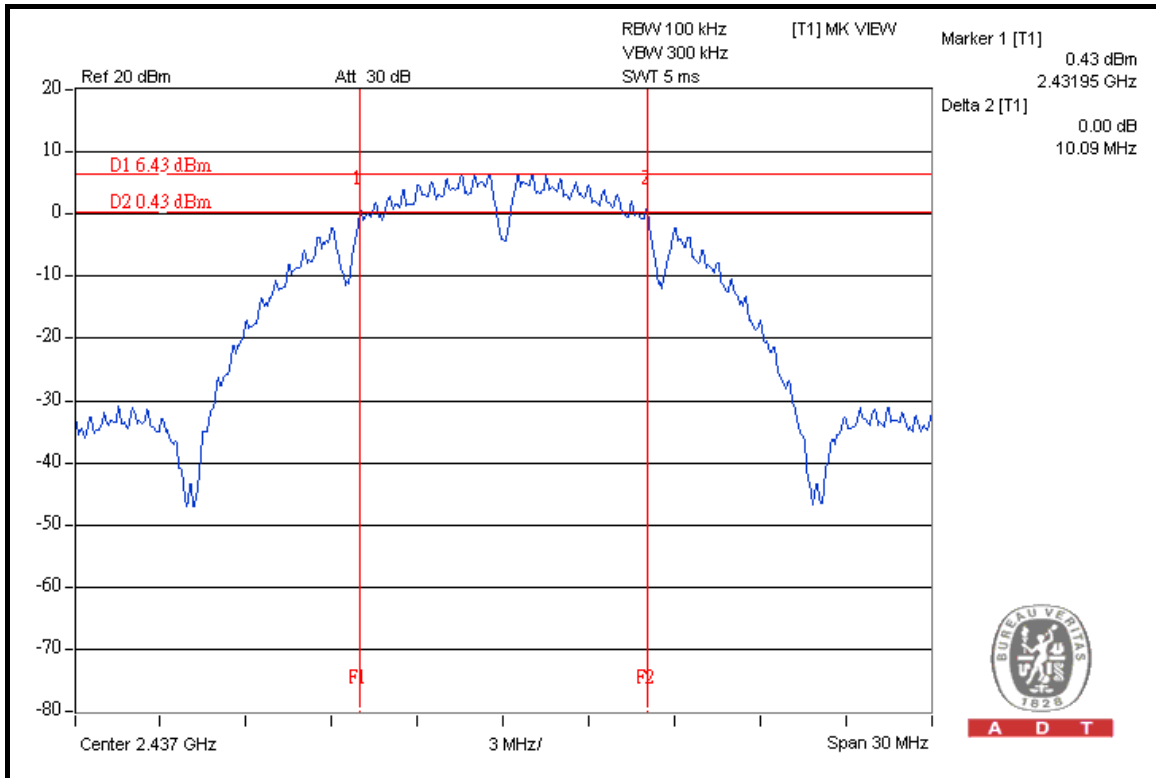

### CH 11

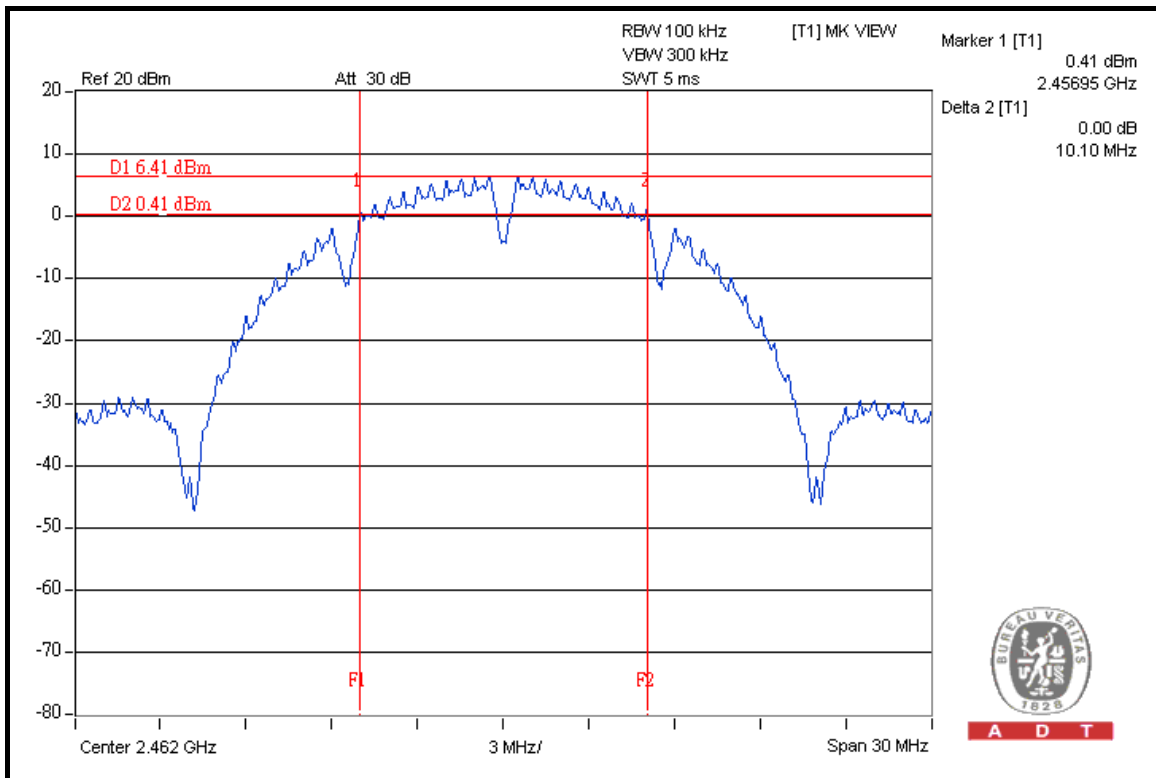



A D T

### 802.11g OFDM MODULATION

<b>MODULATION TYPE</b>	BPSK	<b>TRANSFER RATE</b>	6.0Mbps
<b>INPUT POWER</b>	120Vac, 60 Hz	<b>ENVIRONMENTAL CONDITIONS</b>	23deg. C, 70%RH, 1007hPa
<b>TESTED BY</b>	Dean Wang		

CHANNEL	CHANNEL FREQUENCY (MHz)	6dB BANDWIDTH (MHz)	MINIMUM LIMIT (MHz)	PASS / FAIL
1	2412	16.56	0.5	PASS
6	2437	16.49	0.5	PASS
11	2462	16.51	0.5	PASS

### CH 1

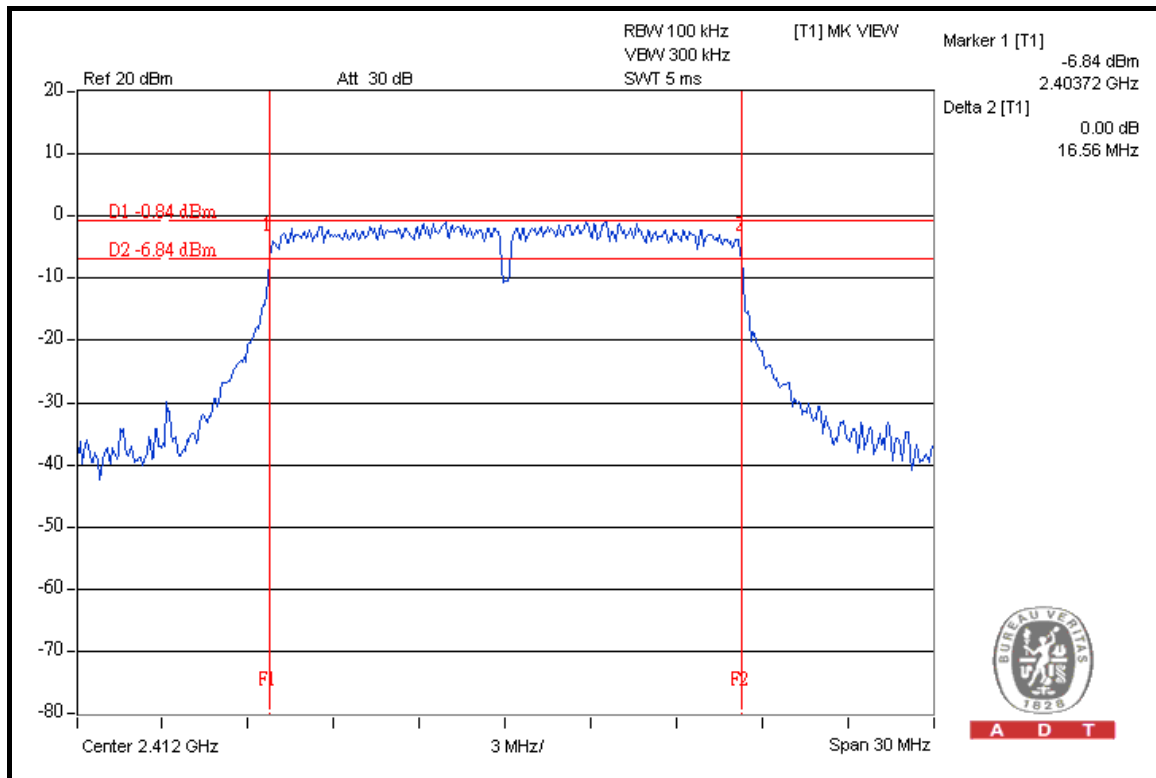



A D T

### CH 6

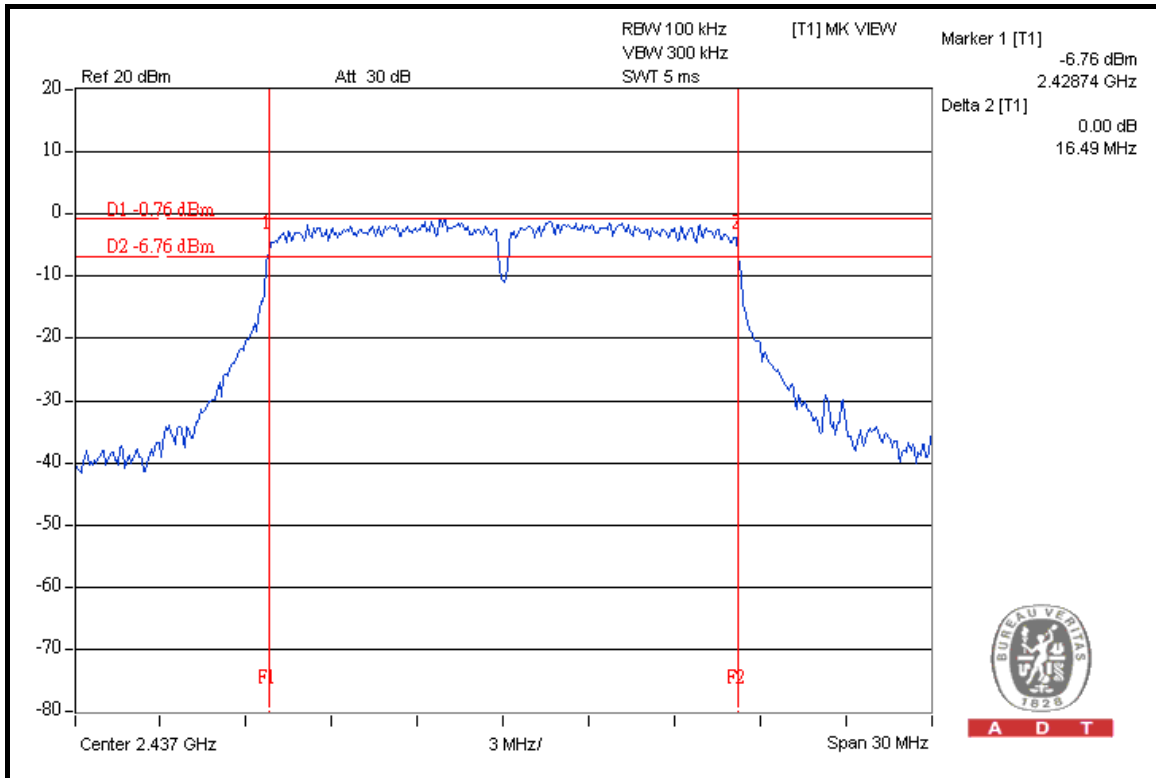

### CH 11

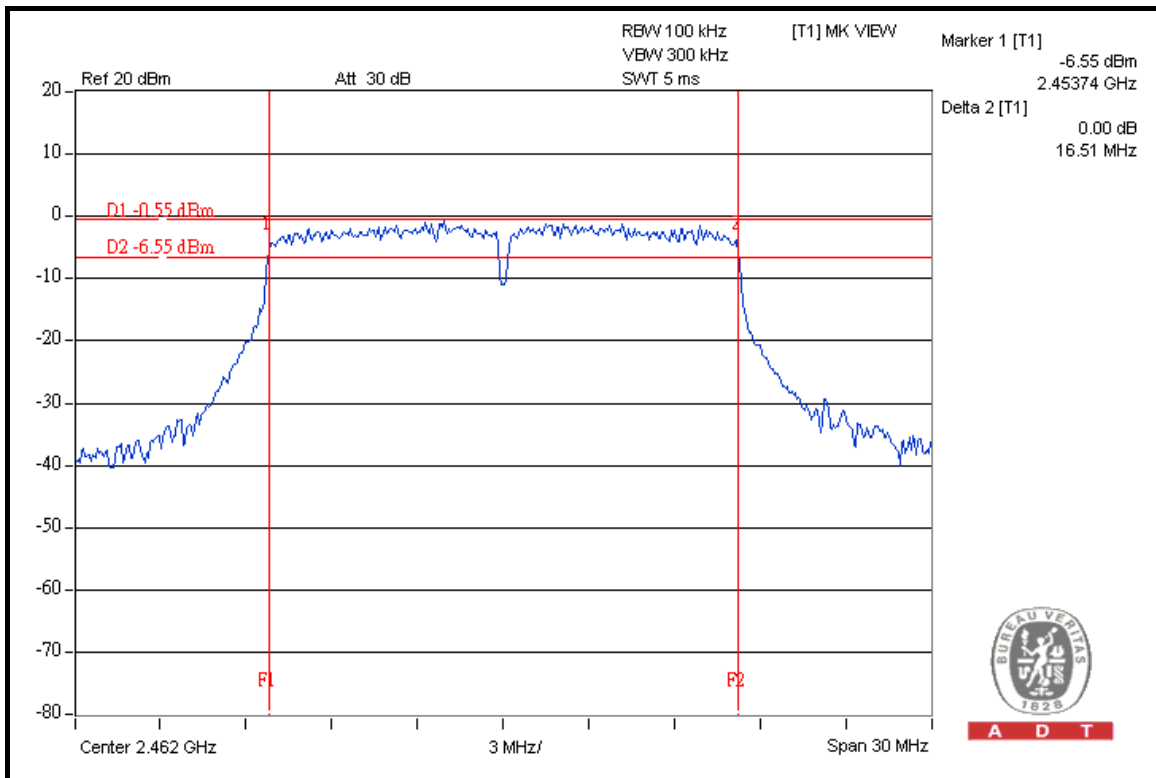



#### 4.4 MAXIMUM PEAK OUTPUT POWER

##### 4.4.1 LIMITS OF MAXIMUM PEAK OUTPUT POWER MEASUREMENT

The Maximum Peak Output Power Measurement is 30dBm.

##### 4.4.2 INSTRUMENTS

DESCRIPTION & MANUFACTURER	MODEL NO.	SERIAL NO.	DATE OF CALIBRATION	DUE DATE OF CALIBRATION
High Speed Peak Power Meter	ML2495A	0824012	Aug. 03, 2009	Aug. 02, 2010
Power Sensor	MA2411B	0738138	Aug. 03, 2009	Aug. 02, 2010

**NOTE:**

1. The calibration interval of the above test instruments is 12 months and the calibrations are traceable to NML/ROC and NIST/USA.
2. Measurement Bandwidth of ML2495A is 65MHz greater than 6dB bandwidth of emission.

##### 4.4.3 TEST PROCEDURES

A power sensor was used on the output port of the EUT. A power meter was used to read the response of the power sensor. Record the power level.

##### 4.4.4 DEVIATION FROM TEST STANDARD

No deviation.

#### 4.4.5 TEST SETUP

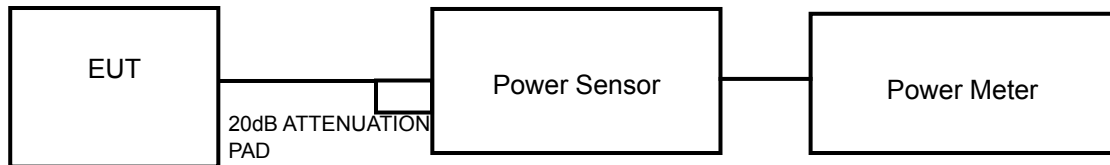

#### 4.4.6 EUT OPERATING CONDITIONS

Same as Item 4.3.6.

#### 4.4.7 TEST RESULTS

##### 802.11b DSSS MODULATION

<b>MODULATION TYPE</b>	DBPSK	<b>TRANSFER RATE</b>	1.0Mbps
<b>INPUT POWER</b>	120Vac, 60 Hz	<b>ENVIRONMENTAL CONDITIONS</b>	23deg. C, 70%RH, 1007hPa
<b>TESTED BY</b>	Dean Wang		

CHAN	CHANNEL FREQUENCY (MHz)	PEAK POWER OUTPUT (mW)	PEAK POWER OUTPUT (dBm)	PEAK POWER LIMIT (dBm)	PASS/FAIL
1	2412	89.74	19.53	30	PASS
6	2437	87.30	19.41	30	PASS
11	2462	86.90	19.39	30	PASS

##### 802.11g OFDM MODULATION

<b>MODULATION TYPE</b>	BPSK	<b>TRANSFER RATE</b>	6.0Mbps
<b>INPUT POWER</b>	120Vac, 60 Hz	<b>ENVIRONMENTAL CONDITIONS</b>	23deg. C, 70%RH, 1007hPa
<b>TESTED BY</b>	Dean Wang		

CHAN	CHANNEL FREQUENCY (MHz)	PEAK POWER OUTPUT (mW)	PEAK POWER OUTPUT (dBm)	PEAK POWER LIMIT (dBm)	PASS/FAIL
1	2412	159.96	22.04	30	PASS
6	2437	163.31	22.13	30	PASS
11	2462	161.44	22.08	30	PASS



## 4.5 POWER SPECTRAL DENSITY MEASUREMENT

### 4.5.1 LIMITS OF POWER SPECTRAL DENSITY MEASUREMENT

The Maximum of Power Spectral Density Measurement is 8dBm.

### 4.5.2 TEST INSTRUMENTS

DESCRIPTION & MANUFACTURER	MODEL NO.	SERIAL NO.	DATE OF CALIBRATION	DUE DATE OF CALIBRATION
SPECTRUM ANALYZER R&S	FSP40	100040	Jul. 07, 2009	Jul. 06, 2010

**NOTE:** The calibration interval of the above test instruments is 12 months and the calibrations are traceable to NML/ROC and NIST/USA.

### 4.5.3 TEST PROCEDURE

The transmitter output was connected to the spectrum analyzer through an attenuator, the bandwidth of the fundamental frequency was measured with the spectrum analyzer using 3kHz RBW and 30kHz VBW, set sweep time = span/3kHz. The power spectral density was measured and recorded.

The sweep time is allowed to be longer than span/3kHz for a full response of the mixer in the spectrum analyzer.

### 4.5.4 DEVIATION FROM TEST STANDARD

No deviation.

#### 4.5.5 TEST SETUP

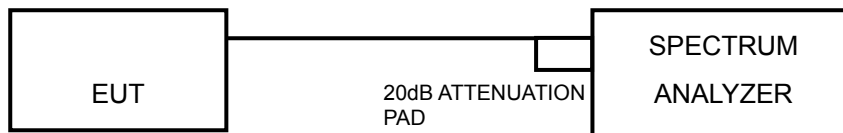

#### 4.5.6 EUT OPERATING CONDITION

Same as Item 4.3.6.



A D T

### 4.5.7 TEST RESULTS

#### 802.11b DSSS MODULATION

<b>MODULATION TYPE</b>	DBPSK	<b>TRANSFER RATE</b>	1.0Mbps
<b>INPUT POWER</b>	120Vac, 60 Hz	<b>ENVIRONMENTAL CONDITIONS</b>	23deg. C, 70%RH, 1007hPa
<b>TESTED BY</b>	Dean Wang		

CHANNEL	CHANNEL FREQUENCY (MHz)	RF POWER LEVEL IN 3 kHz BW (dBm)	MAXIMUM LIMIT (dBm)	PASS/FAIL
1	2412	-13.43	8	PASS
6	2437	-13.39	8	PASS
11	2462	-13.36	8	PASS

#### CH 1

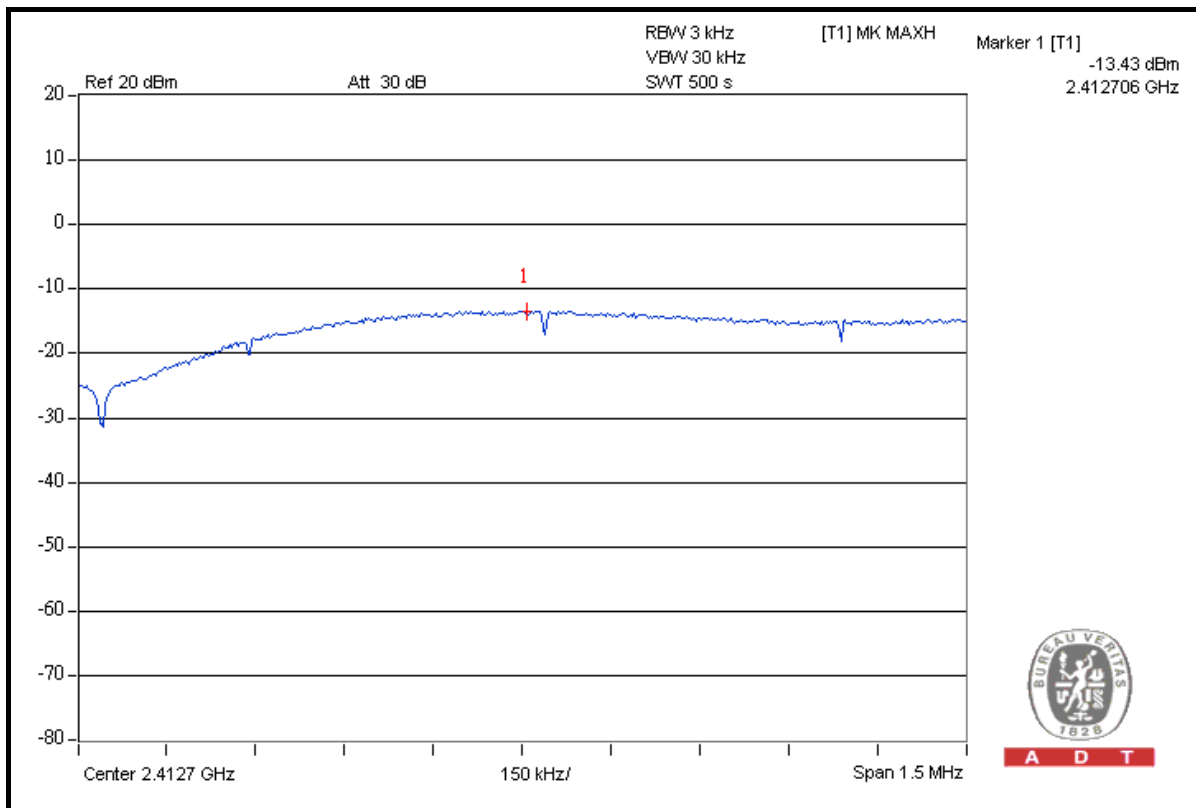

A D T



A D T

### CH 6

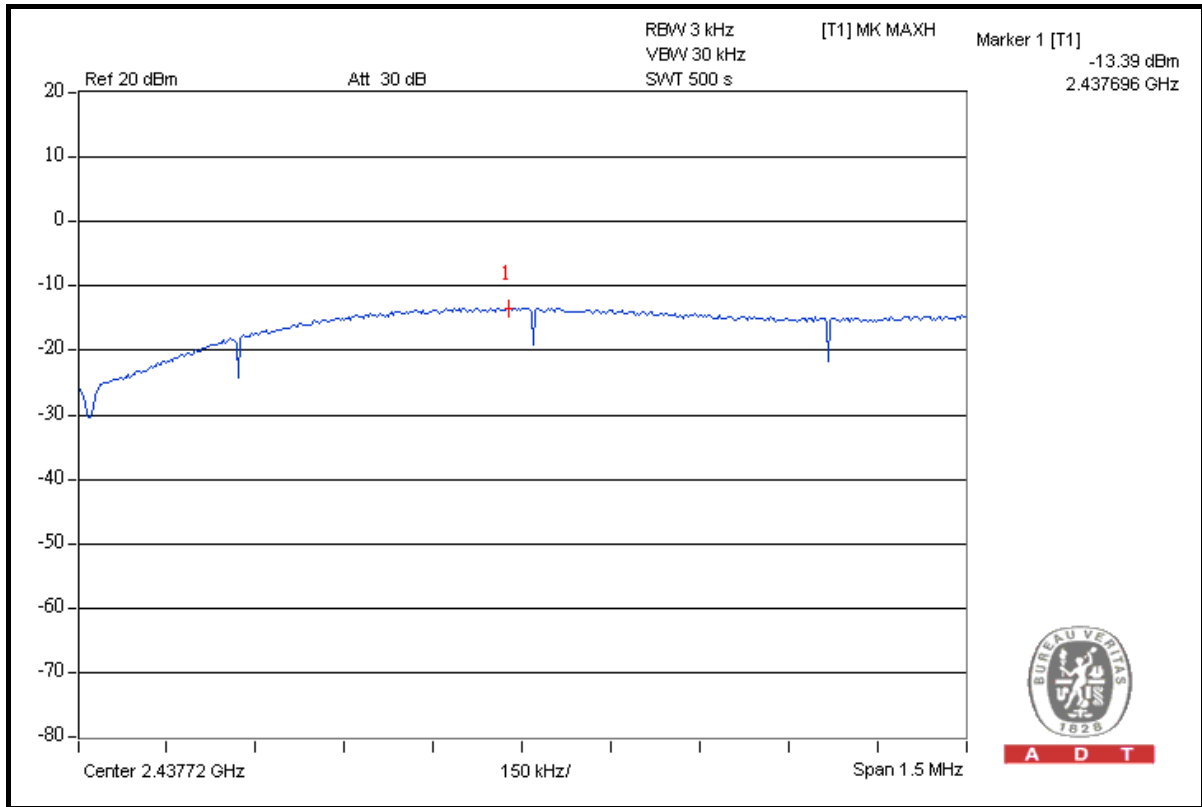

### CH 11

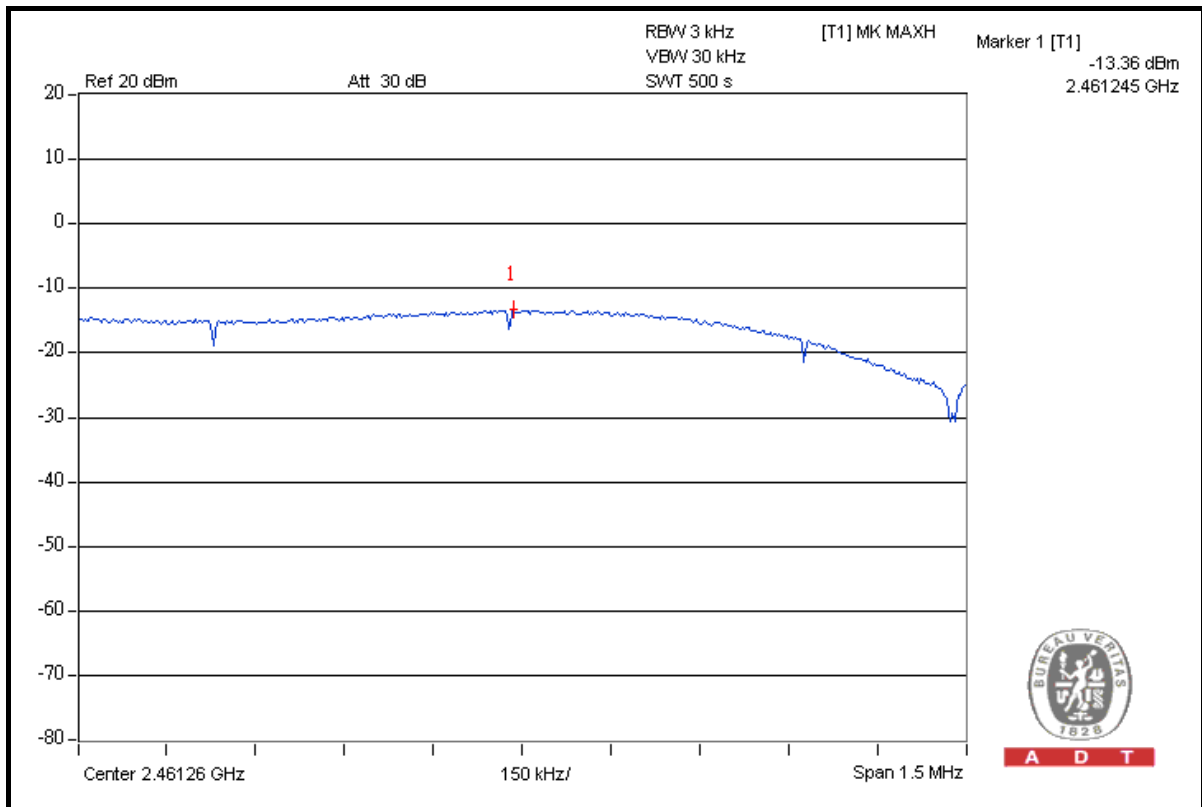



A D T

### 802.11g OFDM MODULATION

<b>MODULATION TYPE</b>	BPSK	<b>TRANSFER RATE</b>	6.0Mbps
<b>INPUT POWER</b>	120Vac, 60 Hz	<b>ENVIRONMENTAL CONDITIONS</b>	23deg. C, 70%RH, 1007hPa
<b>TESTED BY</b>	Dean Wang		

CHANNEL	CHANNEL FREQUENCY (MHz)	RF POWER LEVEL IN 3 kHz BW (dBm)	MAXIMUM LIMIT (dBm)	PASS/FAIL
1	2412	-14.96	8	PASS
6	2437	-14.83	8	PASS
11	2462	-15.03	8	PASS

### CH 1

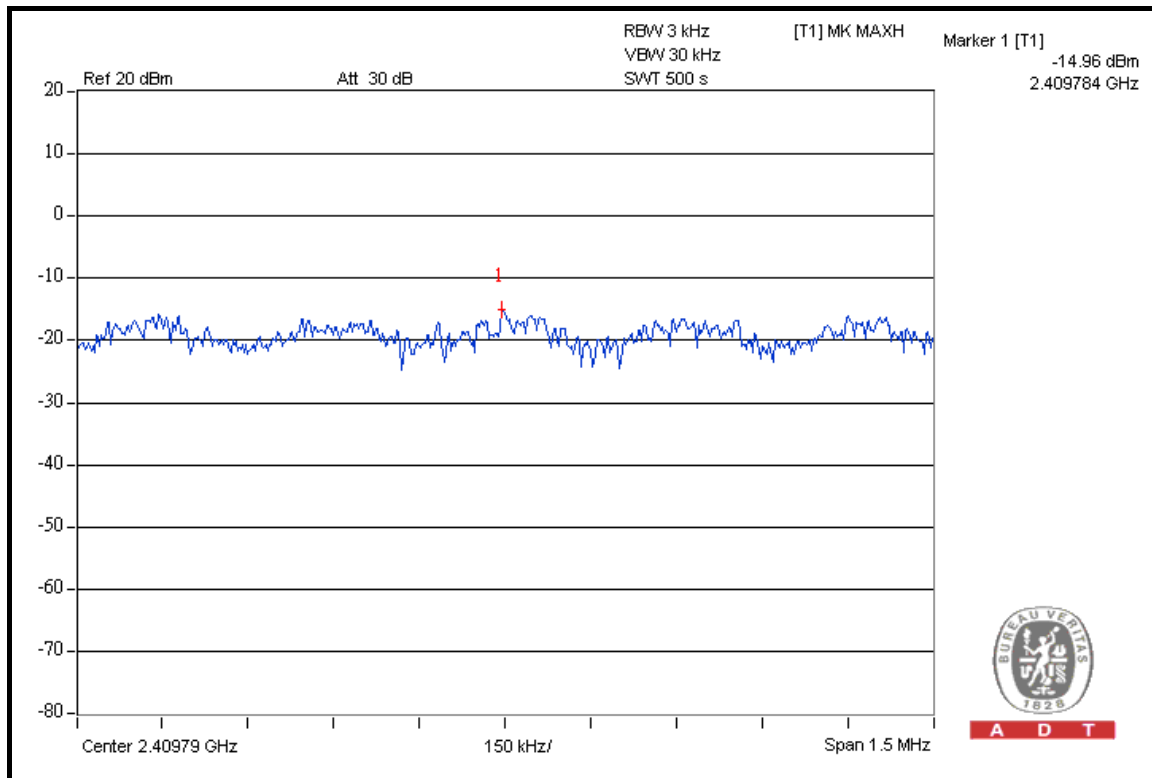

A D T





A D T

### CH 6

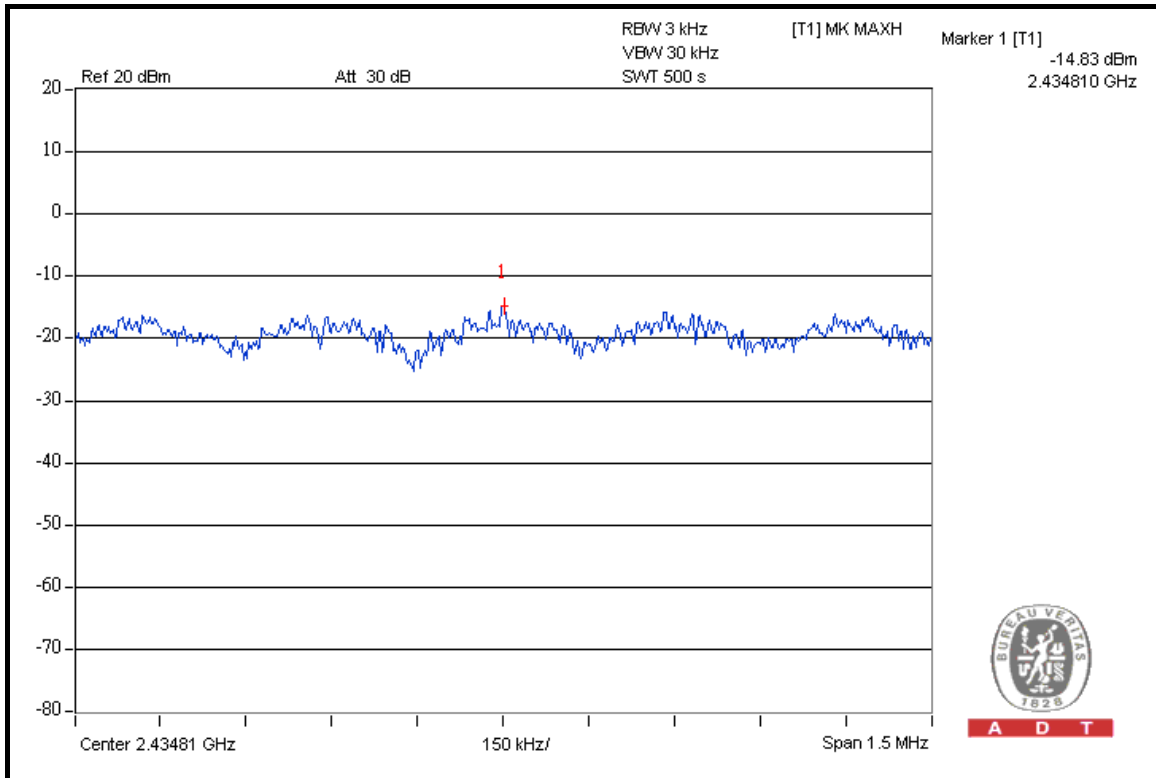

### CH 11

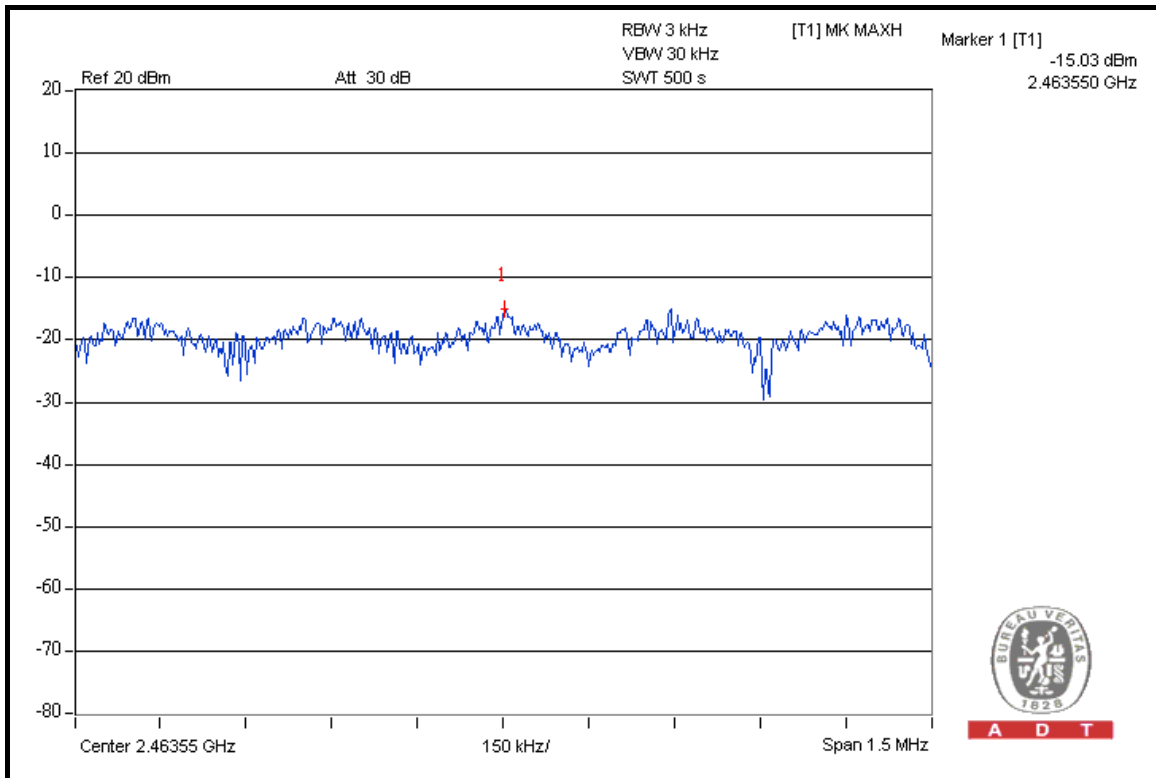

## 4.6 BAND EDGES MEASUREMENT

### 4.6.1 LIMITS OF BAND EDGES MEASUREMENT

Below  $-20\text{dB}$  of the highest emission level of operating band (in 100kHz Resolution Bandwidth).

### 4.6.2 TEST INSTRUMENTS

DESCRIPTION & MANUFACTURER	MODEL NO.	SERIAL NO.	DATE OF CALIBRATION	DUE DATE OF CALIBRATION
SPECTRUM ANALYZER R&S	FSP40	100040	Jul. 07, 2009	Jul. 06, 2010

**NOTE:** The calibration interval of the above test instruments is 12 months and the calibrations are traceable to NML/ROC and NIST/USA.

### 4.6.3 TEST PROCEDURE

The transmitter output was connected to the spectrum analyzer via a low lose cable. Set both RBW and VBW of spectrum analyzer to 100kHz and 300kHz with suitable frequency span including 100MHz bandwidth from band edge. The band edges was measured and recorded.

The spectrum plots (Peak RBW = 100kHz, VBW = 300kHz; Average RBW = 1MHz, VBW = 10Hz) are attached on the following pages.

### 4.6.4 DEVIATION FROM TEST STANDARD

No deviation.

### 4.6.5 EUT OPERATING CONDITION

Same as Item 4.3.6.

#### 4.6.6 TEST RESULTS

The spectrum plots are attached on the following 12 images. D1 line indicates the highest level, and D2 line indicates the 20dB offset below D1. It shows compliance with the requirement in part 15.247(d).

##### 802.11b DSSS MODULATION

**NOTE 1:** The band edge emission plot on the next page shows 53.86dBc between carrier maximum power and local maximum emission in restrict band (2.38520GHz). The emission of carrier strength list in the test result of channel 1 at the item 4.1.7 is 111.36dBuV/m (Peak), so the maximum field strength in restrict band is  $111.36 - 53.86 = 57.50$ dBuV/m which is under 74dBuV/m limit.

The band edge emission plot on the next page shows 59.59dBc between carrier maximum power and local maximum emission in restrict band (2.38640GHz). The emission of carrier strength list in the test result of channel 1 at the item 4.1.7 is 106.93dBuV/m (Average), so the maximum field strength in restrict band is  $106.93 - 59.59 = 47.34$ dBuV/m which is under 54dBuV/m limit.

**NOTE 2:** The band edge emission plot on the next second page shows 54.39dBc between carrier maximum power and local maximum emission in restrict band (2.48860GHz). The emission of carrier strength list in the test result of channel 11 at the item 4.1.7 is 111.29dBuV/m (Peak), so the maximum field strength in restrict band is  $111.29 - 54.39 = 56.90$ dBuV/m which is under 74dBuV/m limit.

The band edge emission plot on the next third page shows 65.76dBc between carrier maximum power and local maximum emission in restrict band (2.48480GHz). The emission of carrier strength list in the test result of channel 11 at the item 4.1.7 is 106.86dBuV/m (Average), so the maximum field strength in restrict band is  $106.86 - 65.76 = 41.10$ dBuV/m which is under 54dBuV/m limit.



A D T

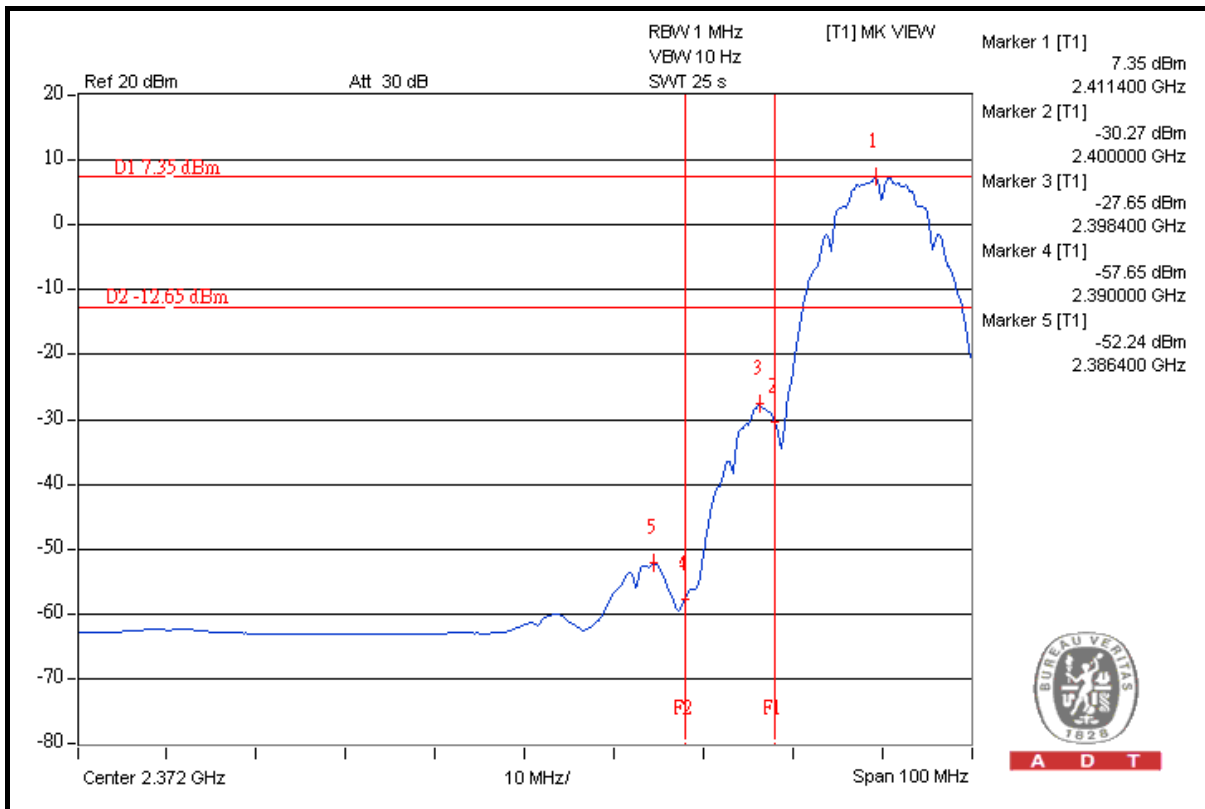
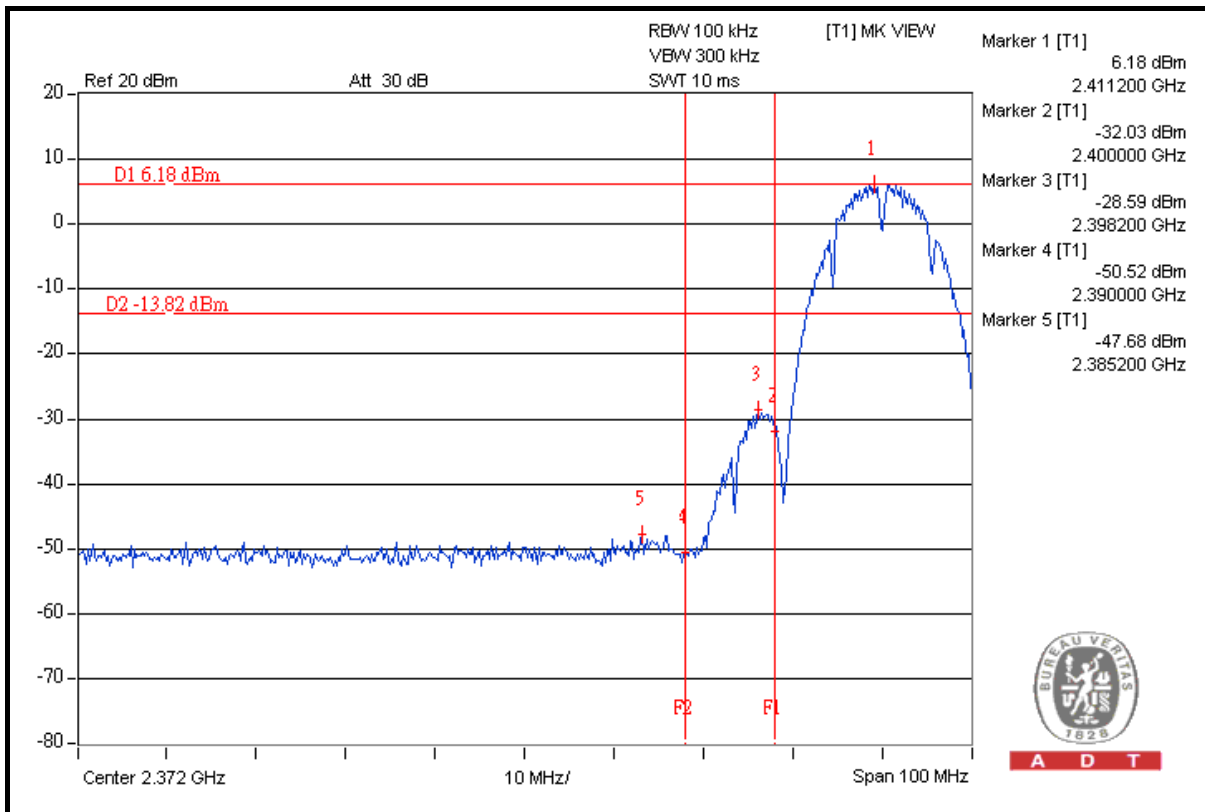



A D T

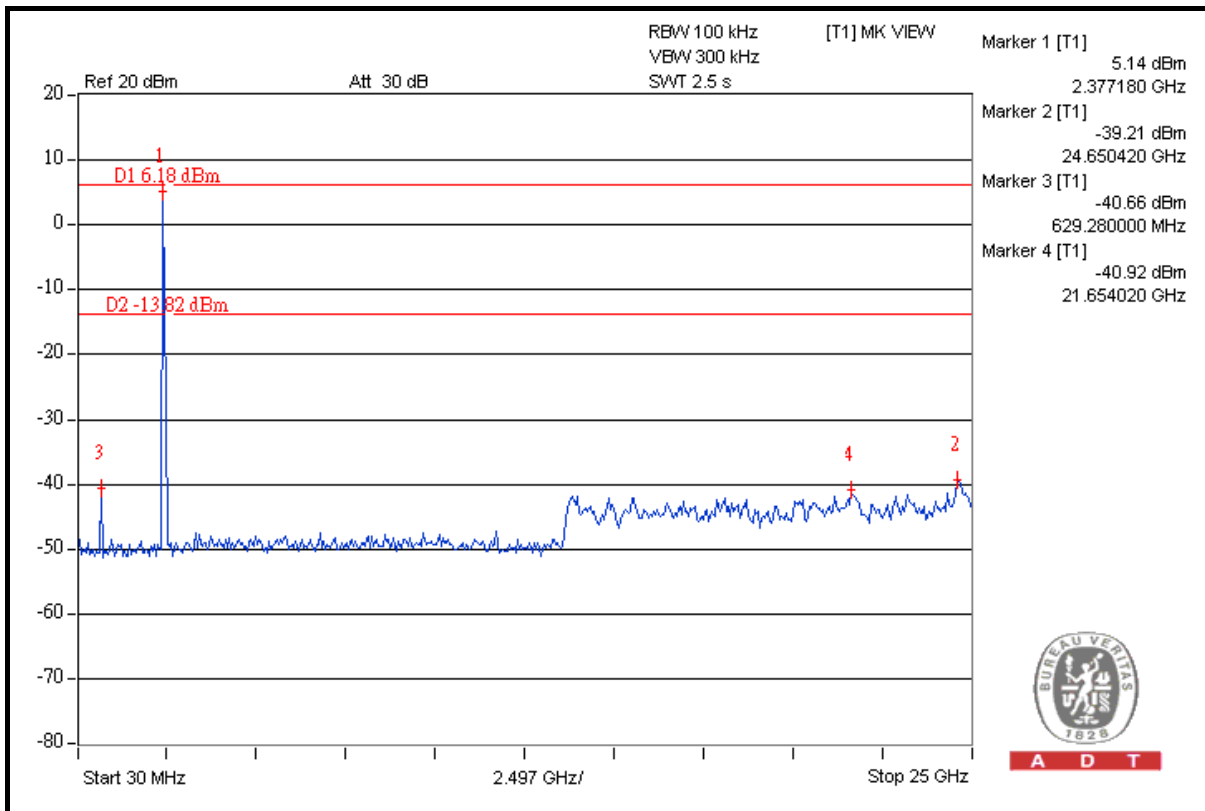

A D T

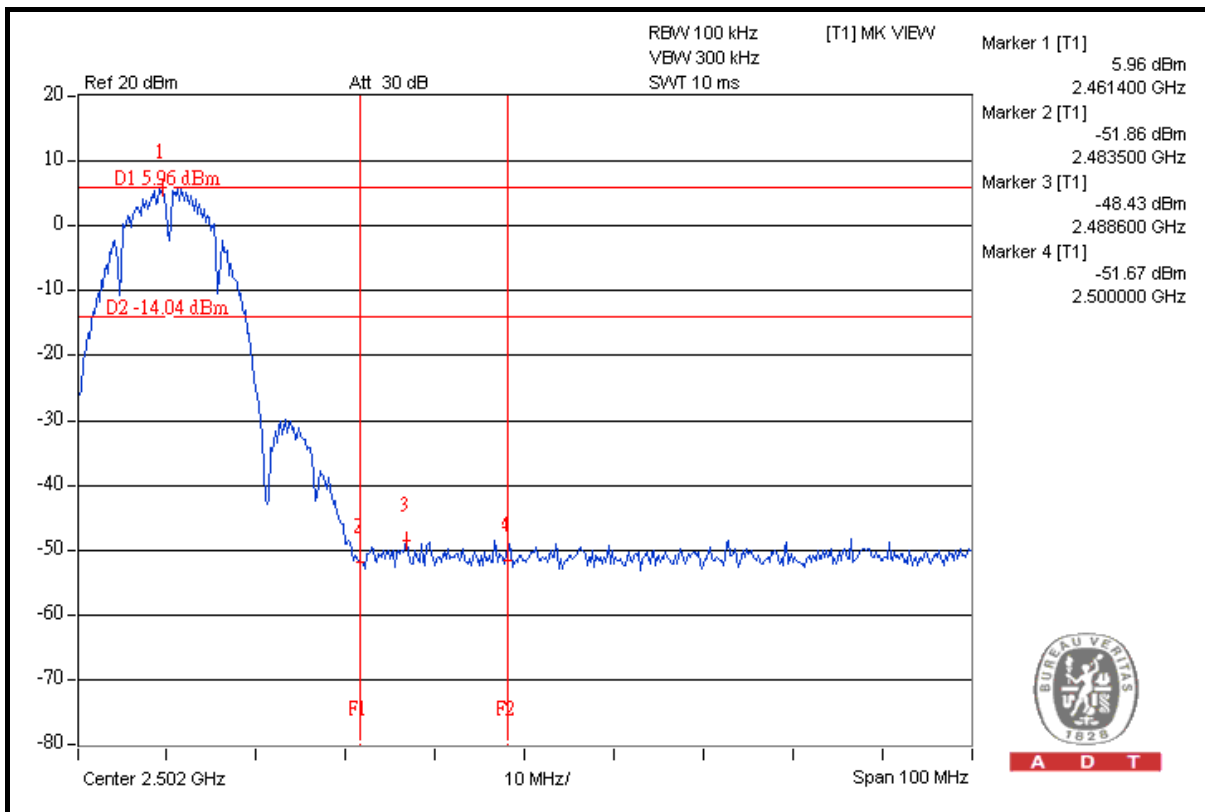

A D T



A D T

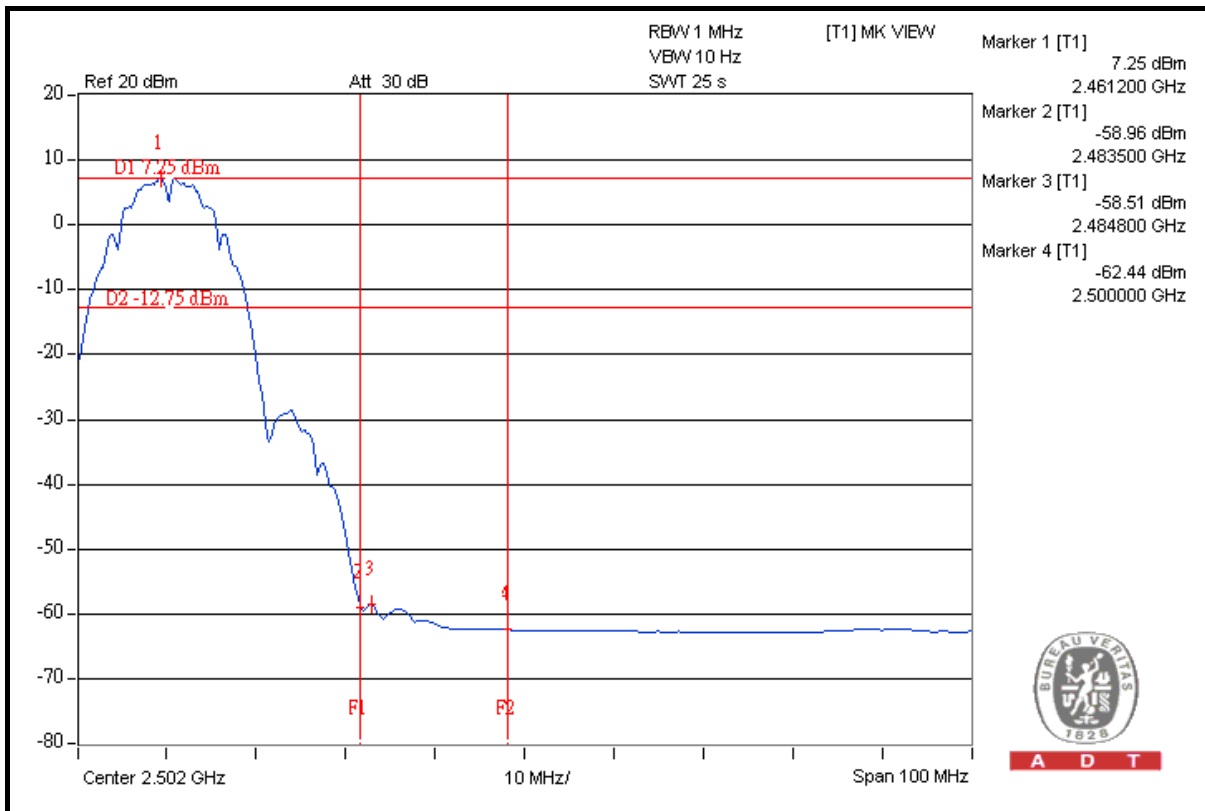

A D T

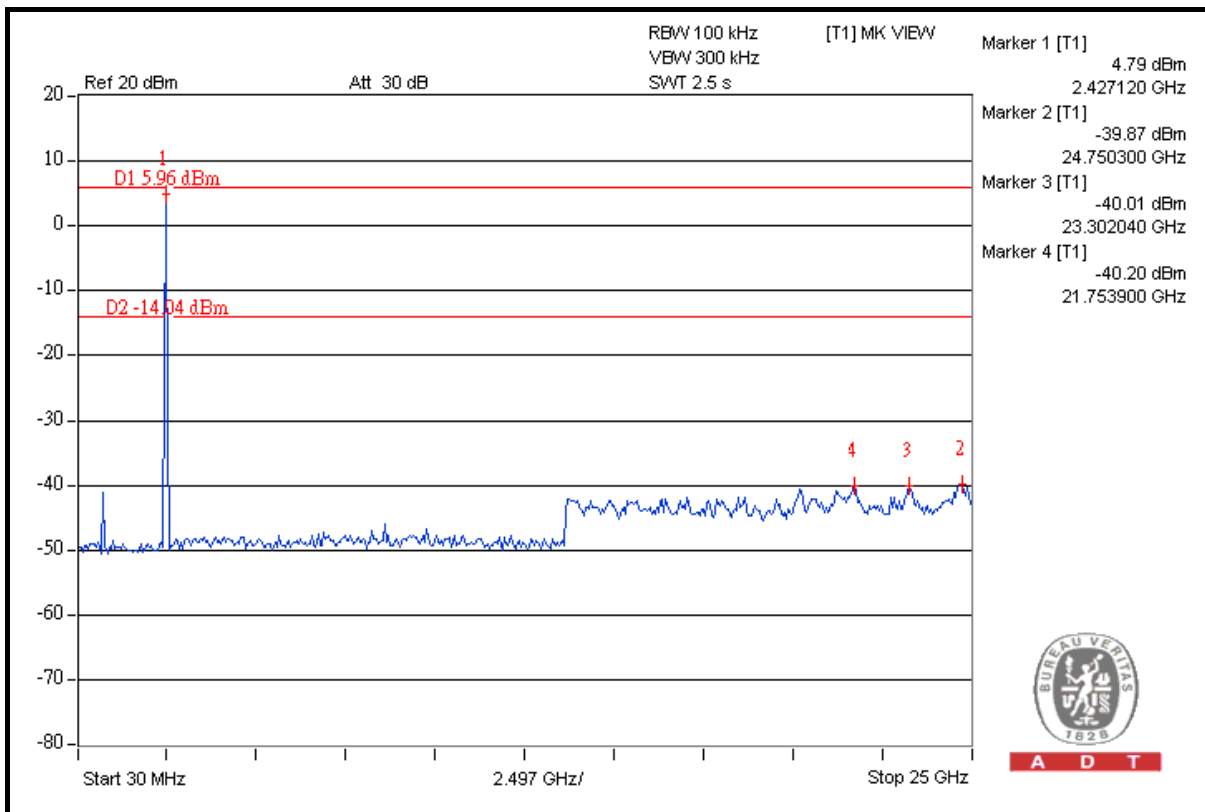

A D T

### 802.11g OFDM MODULATION

**NOTE 1:** The band edge emission plot on the next page shows 43.89dBc between carrier maximum power and local maximum emission in restrict band (2.39000GHz). The emission of carrier strength list in the test result of channel 1 at the item 4.1.7 is 109.10dBuV/m (Peak), so the maximum field strength in restrict band is  $109.10 - 43.89 = 65.21$ dBuV/m which is under 74dBuV/m limit.

The band edge emission plot on the next page shows 49.87dBc between carrier maximum power and local maximum emission in restrict band (2.39000GHz). The emission of carrier strength list in the test result of channel 1 at the item 4.1.7 is 99.14dBuV/m (Average), so the maximum field strength in restrict band is  $99.14 - 49.87 = 49.27$ dBuV/m which is under 54dBuV/m limit.

**NOTE 2:** The band edge emission plot on the next second page shows 43.15dBc between carrier maximum power and local maximum emission in restrict band (2.48360GHz). The emission of carrier strength list in the test result of channel 11 at the item 4.1.7 is 109.34dBuV/m (Peak), so the maximum field strength in restrict band is  $109.34 - 43.15 = 66.19$ dBuV/m which is under 74dBuV/m limit.

The band edge emission plot on the next third page shows 48.28dBc between carrier maximum power and local maximum emission in restrict band (2.48350GHz). The emission of carrier strength list in the test result of channel 11 at the item 4.1.7 is 99.41dBuV/m (Average), so the maximum field strength in restrict band is  $99.41 - 48.28 = 51.13$ dBuV/m which is under 54dBuV/m limit.



A D T

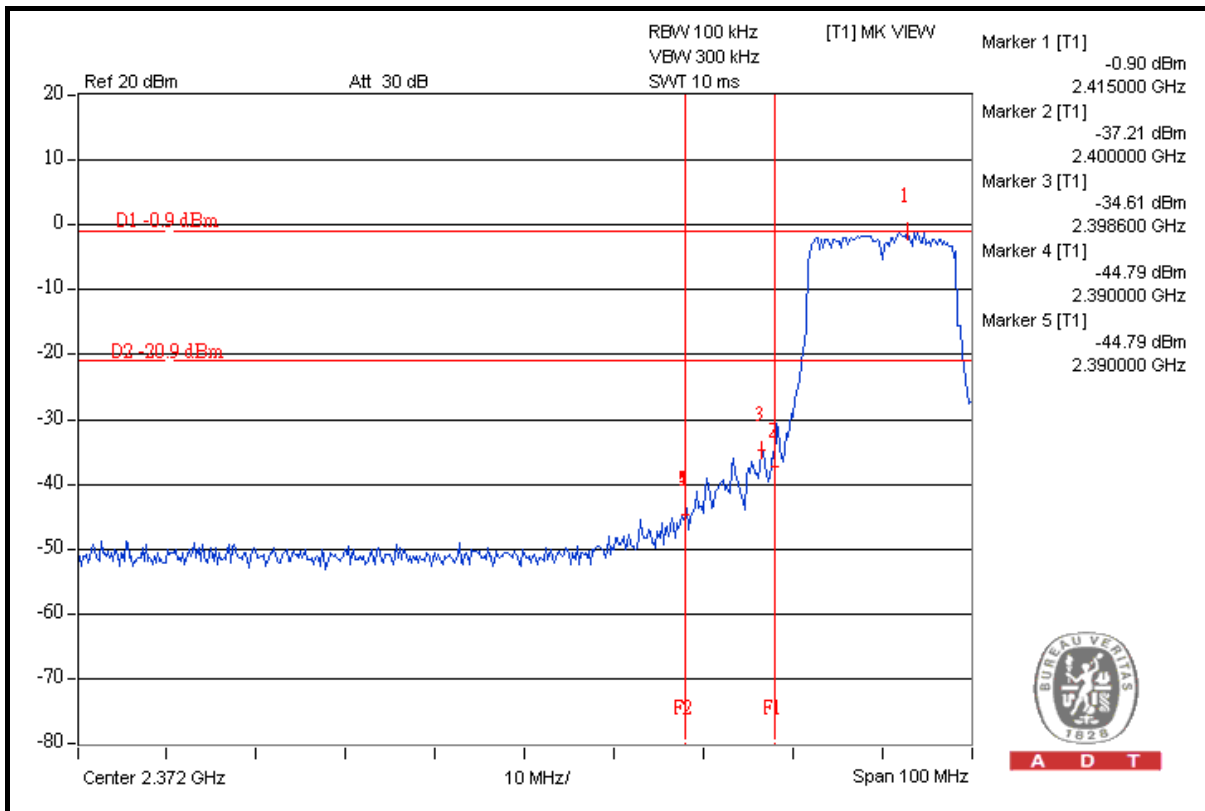

A D T

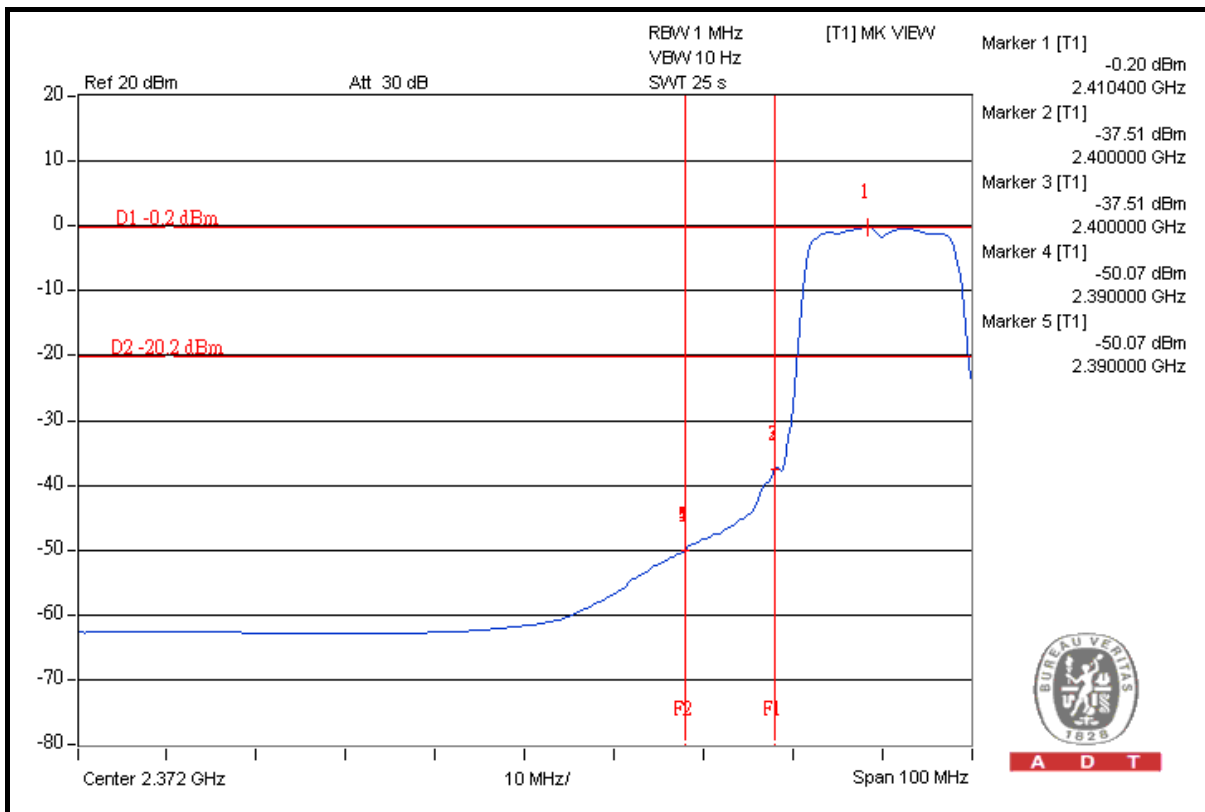

A D T





A D T

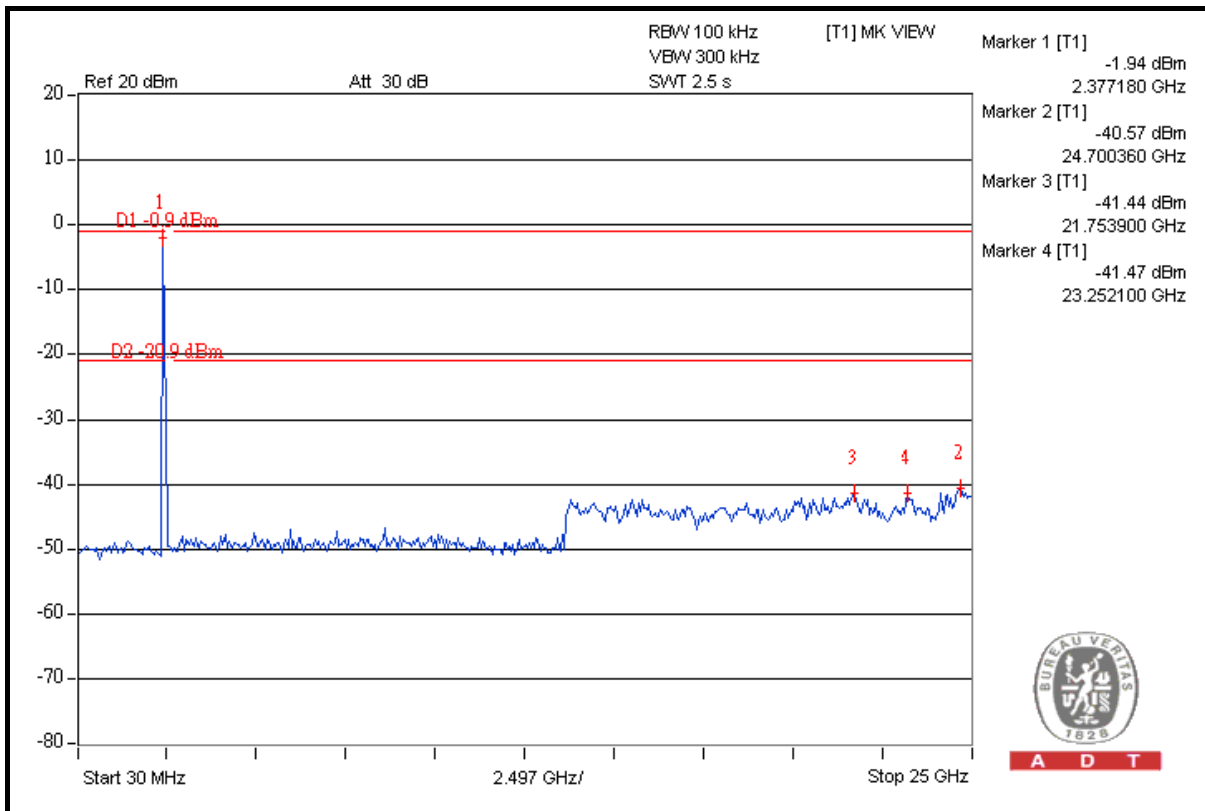

A D T

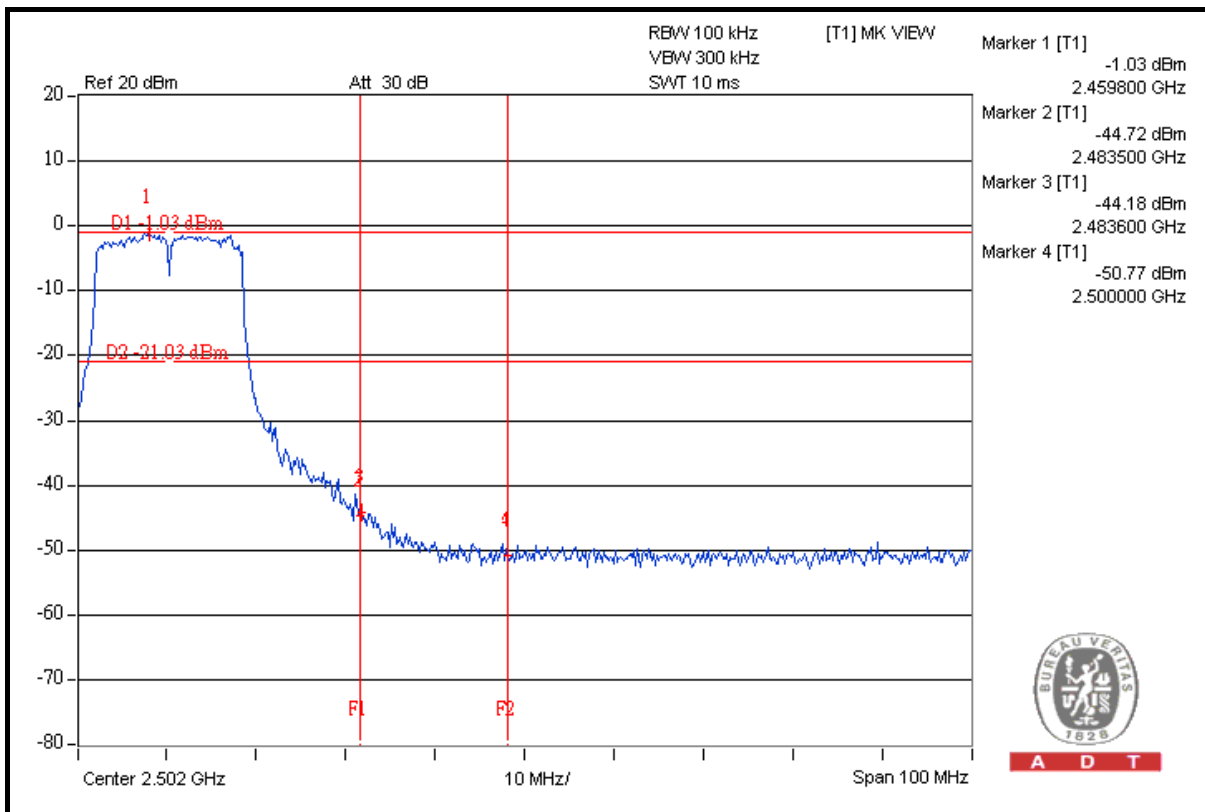

A D T



A D T

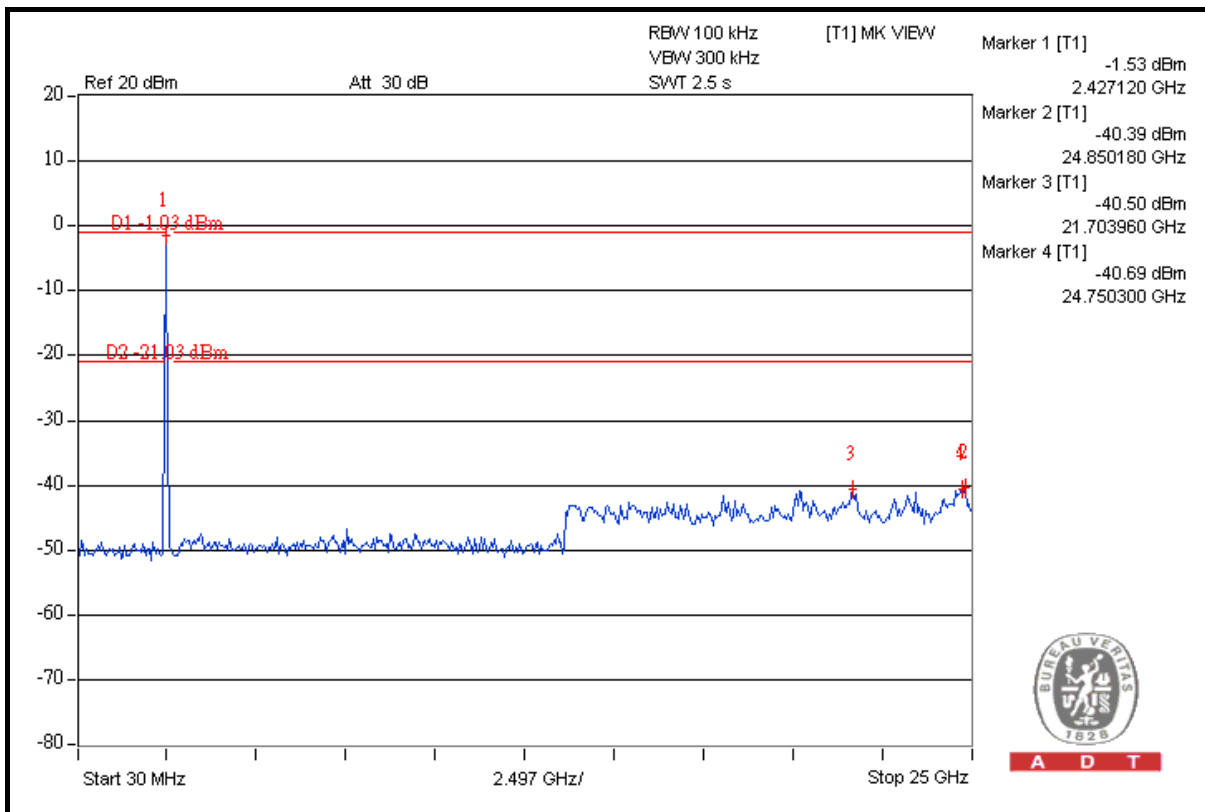
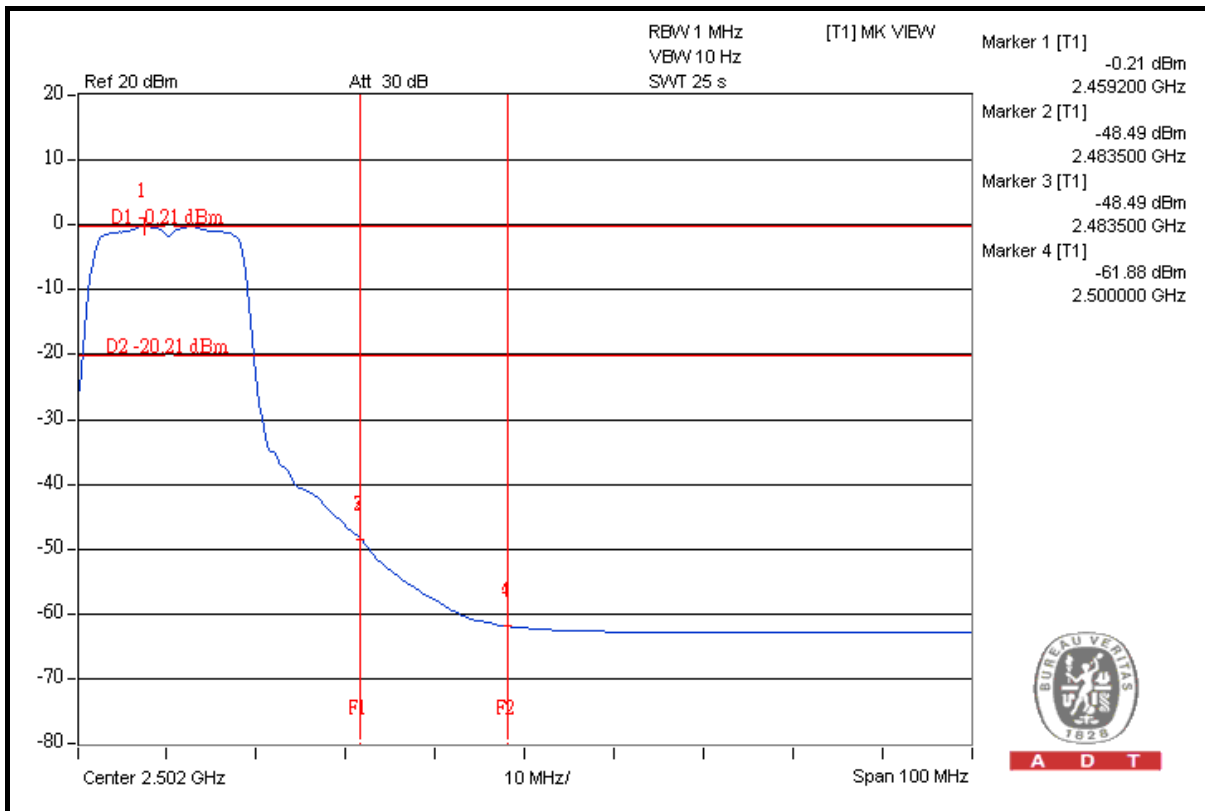

## 4.7 ANTENNA REQUIREMENT

### 4.7.1 STANDARD APPLICABLE

For intentional device, according to FCC 47 CFR Section 15.203, an intentional radiator shall be designed to ensure that no antenna other than that furnished by the responsible party shall be used with the device. And according to FCC 47 CFR Section 15.247 (b), if transmitting antennas of directional gain greater than 6dBi are used, the power shall be reduced by the amount in dB that the directional gain of the antenna exceeds 6dBi.

### 4.7.2 ANTENNA CONNECTED CONSTRUCTION

The antenna used in this product is dipole antenna without antenna connector. The maximum Gain of the antenna is 2dBi.

## 5. PHOTOGRAPHS OF THE TEST CONFIGURATION

Please refer to the attached file (Test Setup Photo).

## 6. INFORMATION ON THE TESTING LABORATORIES

We, Bureau Veritas Consumer Products Services (H.K.) Ltd., Taoyuan Branch, were founded in 1988 to provide our best service in EMC, Radio, Telecom and Safety consultation. Our laboratories are accredited and approved by the following approval agencies according to ISO/IEC 17025.

<b>USA</b>	FCC, NVLAP
<b>Germany</b>	TUV Rheinland
<b>Japan</b>	VCCI
<b>Norway</b>	NEMKO
<b>Canada</b>	INDUSTRY CANADA , CSA
<b>R.O.C.</b>	TAF, BSMI, NCC
<b>Netherlands</b>	Telefication
<b>Singapore</b>	GOST-ASIA(MOU)
<b>Russia</b>	CERTIS(MOU)

Copies of accreditation certificates of our laboratories obtained from approval agencies can be downloaded from our web site:

[www.adt.com.tw/index.5/phtml](http://www.adt.com.tw/index.5/phtml). If you have any comments, please feel free to contact us at the following:

**Linko EMC/RF Lab:**

Tel: 886-2-26052180

Fax: 886-2-26051924

**Hsin Chu EMC/RF Lab:**

Tel: 886-3-5935343

Fax: 886-3-5935342

**Hwa Ya EMC/RF/Safety Telecom Lab:**

Tel: 886-3-3183232

Fax: 886-3-3185050

**Web Site:** [www.adt.com.tw](http://www.adt.com.tw)

The address and road map of all our labs can be found in our web site also.

## **7. APPENDIX A - MODIFICATIONS RECORDERS FOR ENGINEERING CHANGES TO THE EUT BY THE LAB**

No any modifications are made to the EUT by the lab during the test.

**--- END ---**