

TEST REPORT

Test report no.: 1-6938/13-01-03-A



Testing laboratory

CETECOM ICT Services GmbH
 Untertuerkheimer Strasse 6 – 10
 66117 Saarbruecken / Germany
 Phone: + 49 681 5 98 - 0
 Fax: + 49 681 5 98 - 9075
 Internet: <http://www.cetecom.com>
 e-mail: ict@cetecom.com

Accredited Testing Laboratory:

The testing laboratory (area of testing) is accredited according to DIN EN ISO/IEC 17025 (2005) by the Deutsche Akkreditierungsstelle GmbH (DAkkS). The accreditation is valid for the scope of testing procedures as stated in the accreditation certificate with the registration number: D-PL-12076-01-01
 Area of Testing: Radio/Satellite Communications

Applicant

ROBERT BOSCH GmbH
 Daimlerstr. 6
 71229 Leonberg / Germany
 Phone: +49 (711) 811 37855
 Fax: +49 (711) 811 47548
 Contact: Frank Ernst
 e-mail: Frank.Ernst@de.bosch.com
 Phone: +49 (711) 811 37855

Manufacturer

ROBERT BOSCH GmbH
 Daimlerstr. 6
 71229 Leonberg / Germany

Test standard/s

47 CFR Part 15	Title 47 of the Code of Federal Regulations; Chapter I Part 15 - Radio frequency devices
RSS – 210 Issue 8	Low Power Licence-exempt Radiocommunication Devices Annex 13, Section A13.1 Vehicle -Mounted Field Disturbance Sensors in the Band 76.0 - 77.0 GHz

For further applied test standards please refer to section 3 of this test report.

Test Item

Kind of test item:	SRD; Motion Detector for RTTT application
Model name:	MRRevo14F
FCC ID:	NF3-MRRevo14F
IC:	3887A-MRRevo14F
Frequency:	76.0 - 77.0 GHz
Antenna:	integrated patch antenna
Power Supply:	12.0 V DC from power supply
Temperature Range:	-20°C to +55 °C



This test report is electronically signed and valid without handwriting signature. For verification of the electronic signatures, the public keys can be requested at the testing laboratory.

Test report authorised:

Meheza Walla



Test performed:

Karsten Gerald

1 Table of contents

1 Table of contents2

2 General information3

 2.1 Notes and disclaimer3

 2.2 Application details.....3

3 Test standard/s3

4 Test environment.....4

5 Test item4

 5.1 Additional information4

6 Test laboratories sub-contracted4

7 Summary of measurement results5

8 Test setup.....6

 8.1 Radiated measurements6

 8.2 Conducted measurements7

 8.3 Additional comments7

9 Measurement results.....8

 9.1 Power density8

 9.2 Not in Motion.....21

 9.3 Maximum Permissible Exposure (MPE)22

 9.4 Occupied bandwidth24

 9.5 Field strength of emissions (radiated spurious).....27

 9.6 Frequency stability42

 9.7 Conducted spurious emissions < 30 MHz43

10 Test equipment and ancillaries used for tests45

11 Observations46

Annex A Photographs of the test setup47

Annex B External photographs of the EUT.....49

Annex C Internal photographs of the EUT50

Annex D Document history53

Annex E Further information.....53

Annex F Accreditation Certificate54

2 General information

2.1 Notes and disclaimer

The test results of this test report relate exclusively to the test item specified in this test report. CETECOM ICT Services GmbH does not assume responsibility for any conclusions and generalizations drawn from the test results with regard to other specimens or samples of the type of the equipment represented by the test item.

The test report may only be reproduced or published in full. Reproduction or publication of extracts from the report requires the prior written approval of CETECOM ICT Services GmbH.

The testing service provided by CETECOM ICT Services GmbH has been rendered under the current "General Terms and Conditions for CETECOM ICT Services GmbH".

CETECOM ICT Services GmbH will not be liable for any loss or damage resulting from false, inaccurate, inappropriate or incomplete product information provided by the customer.

Under no circumstances does the CETECOM ICT Services GmbH test report include any endorsement or warranty regarding the functionality, quality or performance of any other product or service provided.

Under no circumstances does the CETECOM ICT Services GmbH test report include or imply any product or service warranties from CETECOM ICT Services GmbH, including, without limitation, any implied warranties of merchantability, fitness for purpose, or non-infringement, all of which are expressly disclaimed by CETECOM ICT Services GmbH.

All rights and remedies regarding vendor's products and services for which CETECOM ICT Services GmbH has prepared this test report shall be provided by the party offering such products or services and not by CETECOM ICT Services GmbH.

In no case this test report can be considered as a Letter of Approval.

This test report is electronically signed and valid without handwritten signature. For verification of the electronic signatures, the public keys can be requested at the testing laboratory.

2.2 Application details

Date of receipt of order:	2013-10-21
Date of receipt of test item:	2013-11-11
Start of test:	2013-11-11
End of test:	2013-11-15
Person(s) present during the test:	Mr. Frank Ernst

3 Test standard/s

Test standard	Date	Test standard description
47 CFR Part 15	2013-10	Title 47 of the Code of Federal Regulations; Chapter I Part 15 - Radio frequency devices
RSS – 210 Issue 8	2010-12	Low Power Licence-exempt Radiocommunication Devices Annex 13, Section A13.1 Vehicle -Mounted Field Disturbance Sensors in the Band 76.0 - 77.0 GHz
FCC 12-72	2012-07-05	Report and Order Amendment of Sections 15.35 and 15.253 of the Commission's Rules Regarding Operation of Radar Systems in the 76-77 GHz Band Amendment of Section 15.253 of the Commission's Rules to Permit Fixed Use of Radar in the 76-77 GHz Band

4 Test environment

Temperature:	T_{nom}	+22 °C during room temperature tests
	T_{max}	+55 °C during high temperature tests
	T_{min}	-20 °C during low temperature tests
Relative humidity:		55 %
Barometric pressure:		not relevant for this kind of testing
Power supply:	V_{nom}	12.0 V DC from power supply
	V_{min}	10.2 V DC
	V_{max}	13.8 V DC

5 Test item

Kind of test item	:	SRD; Motion Detector for RTTT application
Type identification	:	MRRevo14F
S/N serial number	:	65B60484
HW hardware status	:	-/-
SW software status	:	-/-
Frequency band	:	76.0 - 77.0 GHz
Type of modulation	:	FMCW
Number of channels	:	1
Antenna	:	integrated patch antenna
Power supply	:	12.0 V DC from power supply
Temperature range	:	-20°C to +55 °C

5.1 Additional information

Special test software was used to change from normal operation mode to stopped mode (bottom / middle / top) as required by CFR 47 Part 15.31 (c).

6 Test laboratories sub-contracted

None

7 Summary of measurement results

<input checked="" type="checkbox"/>	No deviations from the technical specifications were ascertained
<input type="checkbox"/>	There were deviations from the technical specifications ascertained

TC Identifier	Description	Verdict	Date	Remark
RF-Testing	47 CFR Part 15 / RSS- 210 Issue 8, Annex 13	Passed	2013-12-09	-/-

Test specification clause	Test case	Temperature conditions	Power source voltages	Pass	Fail	NA	NP	Results (max.)
§15.253 (d)(1)(2) RSS210 Issue 8 A13.1.3	Power density	Nominal and Extreme	Nominal and Extreme	<input checked="" type="checkbox"/>	<input type="checkbox"/>	<input type="checkbox"/>	<input type="checkbox"/>	Peak: 29.05 dBm AVG: 8.27 dBm (normal op. mode)
RSS210 Issue 8 A13.1.2 (1)(a)	Not in Motion	Nominal and Extreme	Nominal and Extreme	<input checked="" type="checkbox"/>	<input type="checkbox"/>	<input type="checkbox"/>	<input type="checkbox"/>	AVG: 8.27 dBm (normal op. mode)
§1.1310	MPE Calculation	Nominal and Extreme	Nominal and Extreme	<input checked="" type="checkbox"/>	<input type="checkbox"/>	<input type="checkbox"/>	<input type="checkbox"/>	0.16 mW/cm ²
§2.1049 RSS210 Issue 8 A13.1.1	Occupied bandwidth (99% bandwidth)	Nominal and Extreme	Nominal and Extreme	<input checked="" type="checkbox"/>	<input type="checkbox"/>	<input type="checkbox"/>	<input type="checkbox"/>	461.6 MHz
§15.253 (d) §15.253 (e) §15.209 (a) RSS210 Issue 8 A13.1.2 (2)a/b/c	Field strength of emissions (radiated spurious)	Nominal	Nominal	<input checked="" type="checkbox"/>	<input type="checkbox"/>	<input type="checkbox"/>	<input type="checkbox"/>	complies
§§15.253 (f) RSS210 Issue 8 A13.1.5	Frequency stability	Nominal and Extreme	Nominal and Extreme	<input checked="" type="checkbox"/>	<input type="checkbox"/>	<input type="checkbox"/>	<input type="checkbox"/>	complies
§15.207 (a) ICES-003	Conducted emissions < 30 MHz	Nominal	Nominal	<input checked="" type="checkbox"/>	<input type="checkbox"/>	<input type="checkbox"/>	<input type="checkbox"/>	complies

Note: NA = Not Applicable; NP = Not Performed

8 Test setup

8.1 Radiated measurements

The radiated measurements are performed in vertical and horizontal plane in the frequency range from 9 kHz to 25 GHz in semi-anechoic chambers. The EUT is positioned on a non-conductive support with a height of 0.80 m above a conductive ground plane that covers the whole chamber. The receiving antennas are confirmed with specifications ANSI C63.2-1996 clause 15 and ANSI C63.4-2009 clause 4.1.5. These antennas can be moved over the height range between 1.0 m and 4.0 m in order to search for maximum field strength emitted from EUT. The measurement distances between EUT and receiving antennas are indicated in the test setups for the various frequency ranges. For each measurement, the EUT is rotated in all three axes until the maximum field strength is received. The wanted and unwanted emissions are received by spectrum analyzers where the detector modes and resolution bandwidths over various frequency ranges are set according to requirement ANSI C63-4-2009 clause 4.2.

Antennas are confirmed with ANSI C63.2-1996 item 15.

Semi anechoic chamber

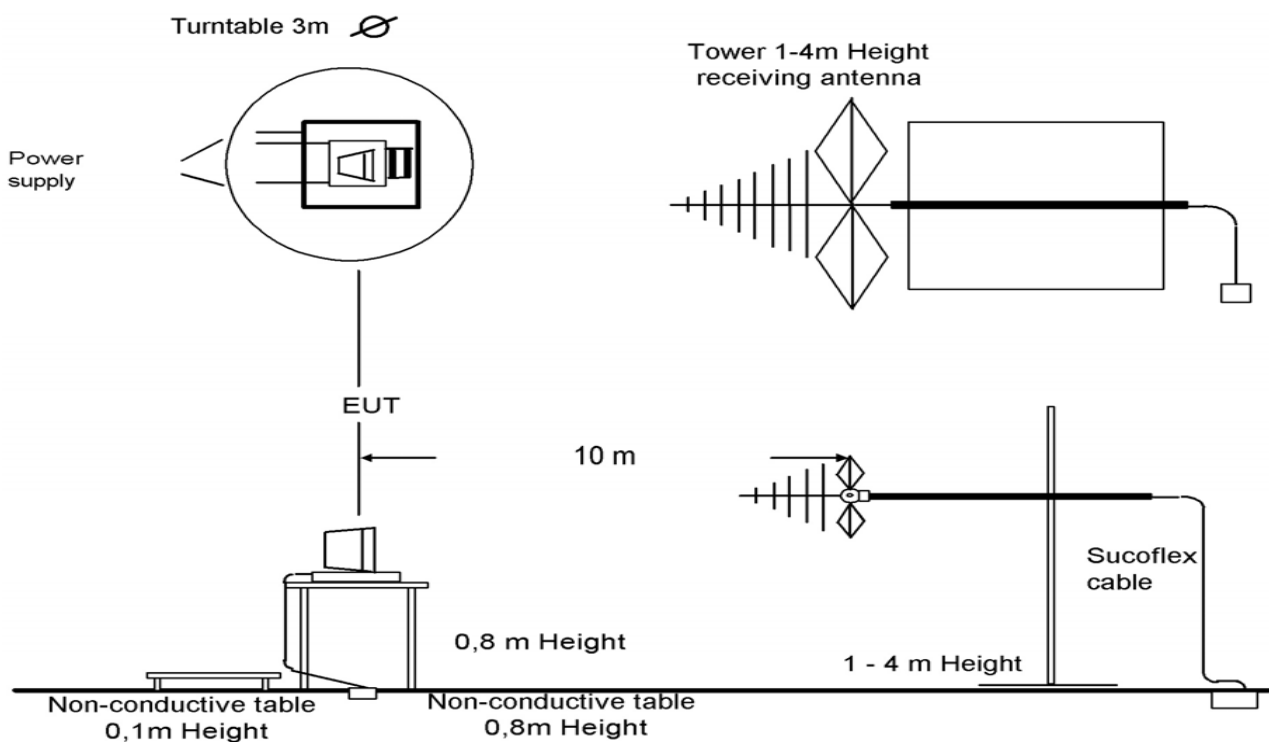

Picture 1: Diagram radiated measurements (Up to 12 GHz)

Test set-up for the measurement of spurious radiation in the frequency range 12 GHz to 50 GHz:

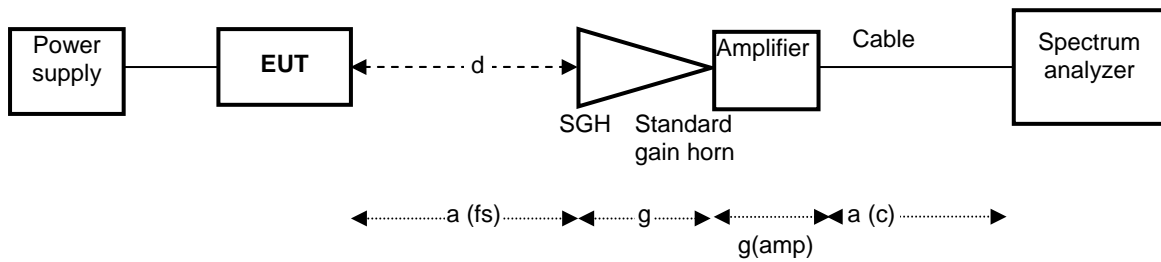

Picture 2: Diagram radiated measurements (12 GHz – 50 GHz)

Test set-up for the measurement of spurious radiation and EIRP in the frequency range 50 GHz to 325 GHz:

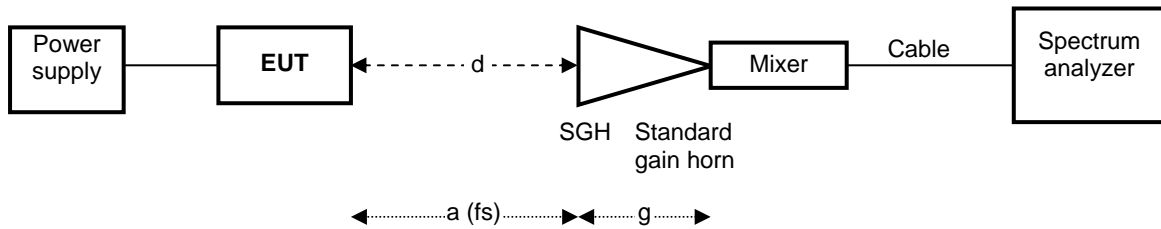

Picture 3: Diagram radiated measurements (50 GHz – 330 GHz)

8.2 Conducted measurements

Not applicable!

8.3 Additional comments

Special test software was used to change from normal operation mode to stopped mode (low / middle / high) as required by CFR 47 Part 15.31 (c).

9 Measurement results

9.1 Power density

Measurement results:

TEST CONDITIONS (T_{nom} / V_{nom})	TRANSMITTER Power Density	
	Peak EIRP [dBm]	AVG EIRP [dBm]
normal operation mode	28.24	6.95
CW, low frequency	23.98	20.55
CW, mid frequency	25.68	23.65
CW, high frequency	28.20	24.39

TEST CONDITIONS ($T_{min} / V_{min}-V_{max}$)	TRANSMITTER Power Density	
	Peak EIRP [dBm]	AVG EIRP [dBm]
normal operation mode	29.05	8.27
CW, low frequency	24.90	22.52
CW, mid frequency	26.99	23.69
CW, high frequency	27.29	24.97

TEST CONDITIONS ($T_{max} / V_{min}-V_{max}$)	TRANSMITTER Power Density	
	Peak EIRP [dBm]	AVG EIRP [dBm]
normal operation mode	28.01	6.52
CW, low frequency	23.93	21.77
CW, mid frequency	25.58	23.37
CW, high frequency	28.22	24.35

Limits:

FCC §15.253 (d) (1) (2)

Frequency	Measurement distance	Power Density → EIRP
76.0 - 77.0 GHz	3.0 m	88 $\mu\text{W}/\text{cm}^2$ → 50 dBm (Average) 279 $\mu\text{W}/\text{cm}^2$ → 55 dBm (PEAK)

Limits:

RSS 210 Issue 8, Annex 13.1.3

There is no limit on peak transmitter output power

Result: The measurement is passed.

Plot 1: EIRP (Peak detector), T_{nom} / V_{nom} , normal operation mode

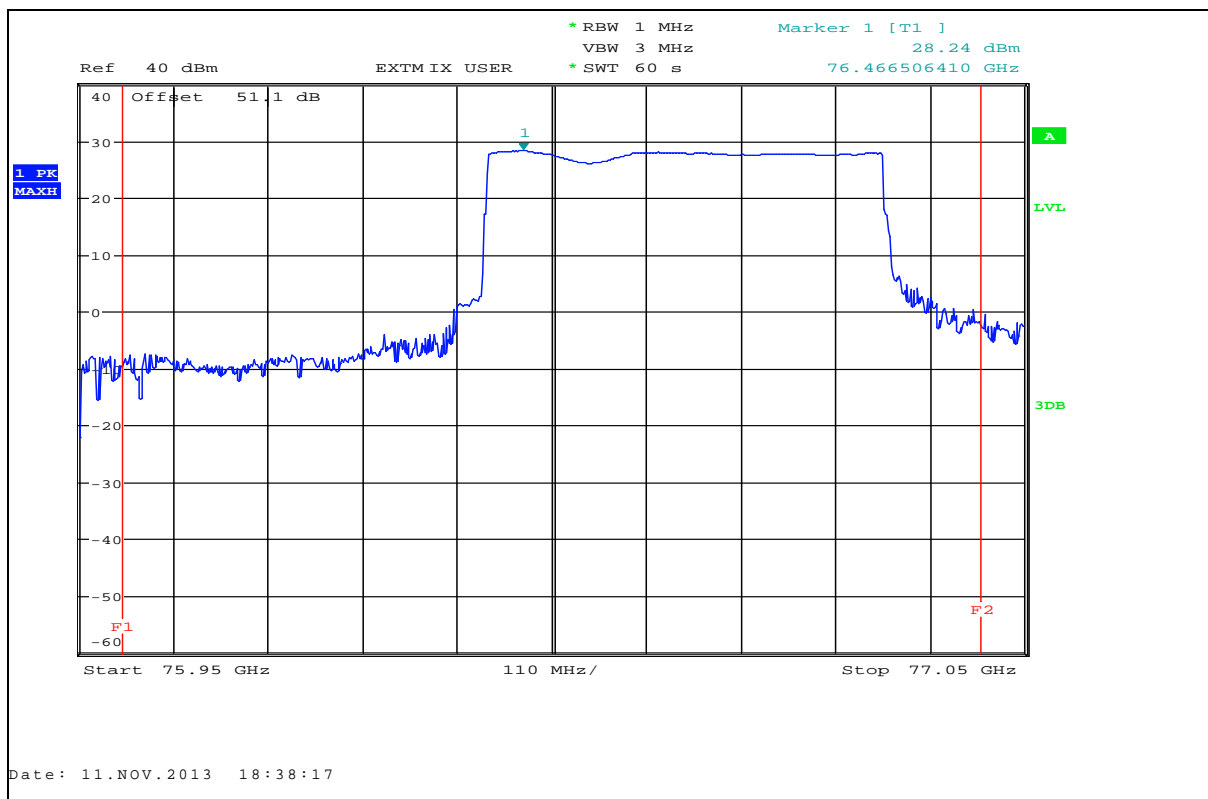

Plot 2: EIRP (RMS detector), T_{nom} / V_{nom} , normal operation mode

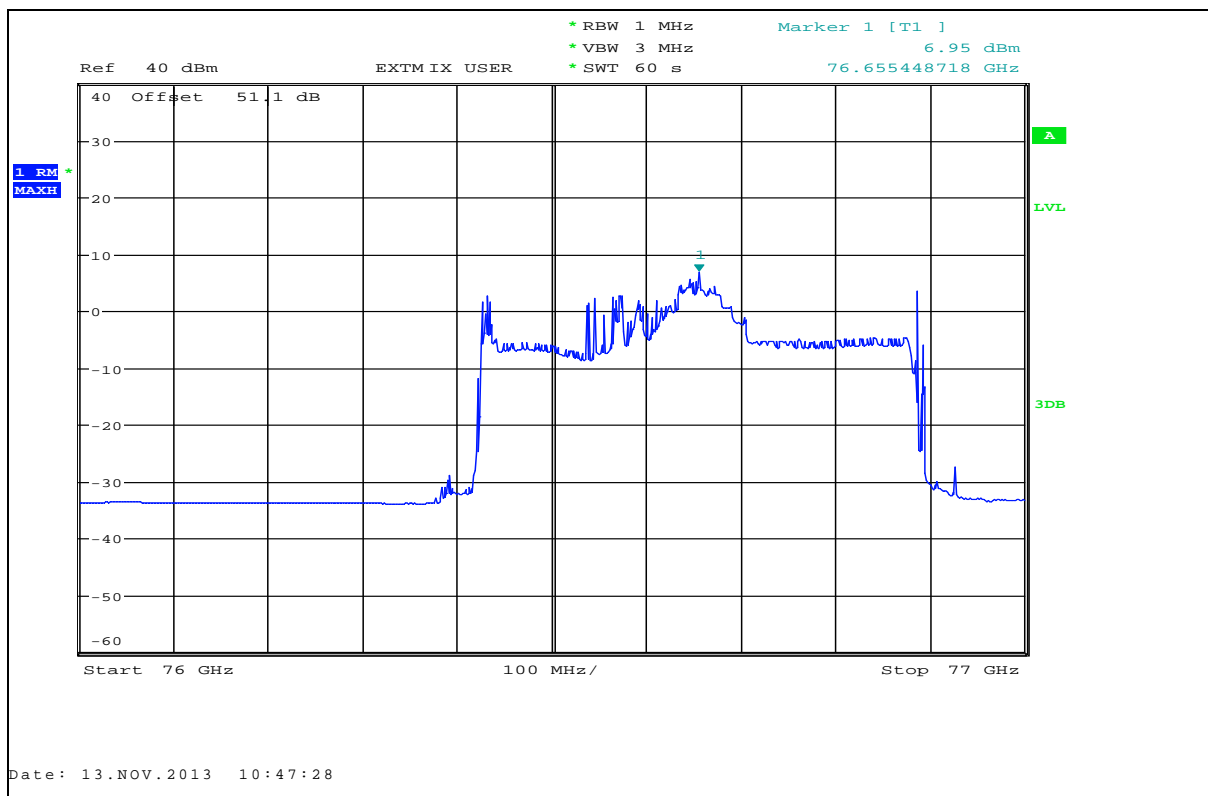

Plot 3: EIRP (Peak detector), T_{nom} / V_{nom} , CW-Test mode, low frequency

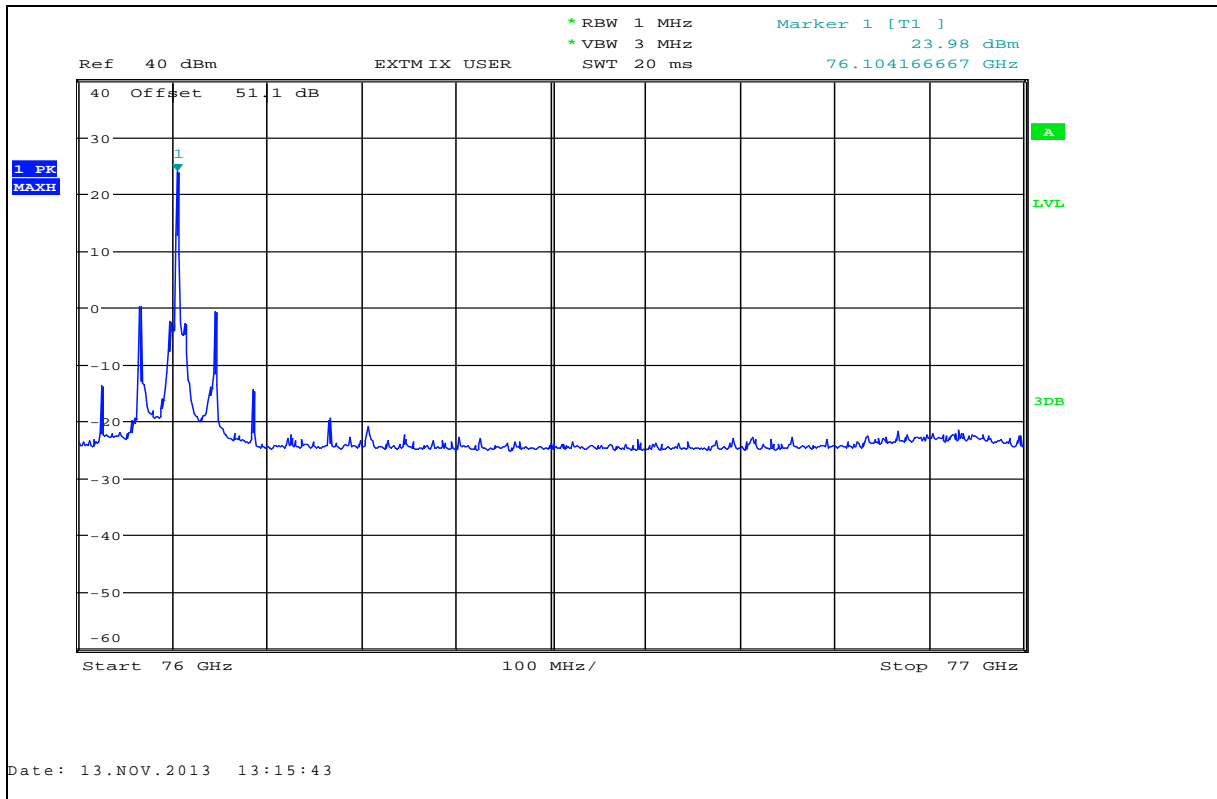

Plot 4: EIRP (RMS detector), T_{nom} / V_{nom} , CW-Test mode, low frequency

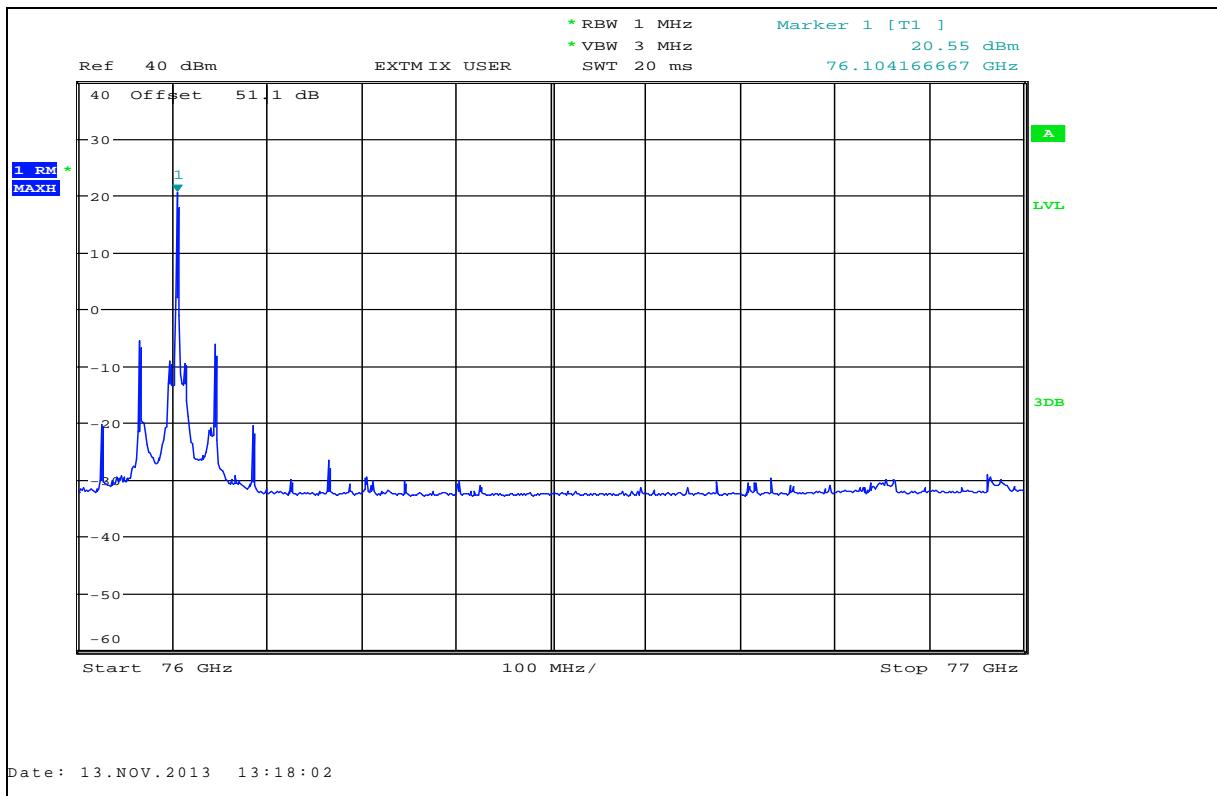

Plot 5: EIRP (Peak detector), T_{nom} / V_{nom} , CW-Test mode, mid frequency

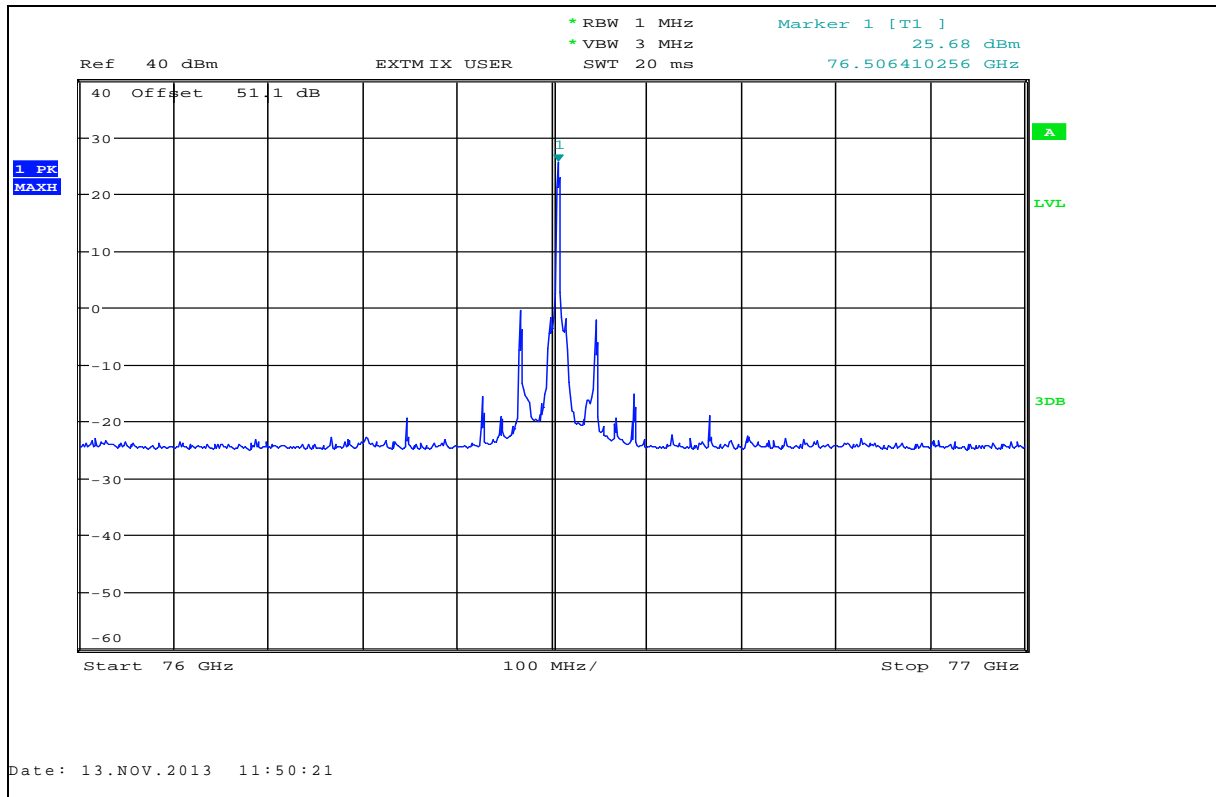

Plot 6: EIRP (RMS detector), T_{nom} / V_{nom} , CW-Test mode, mid frequency

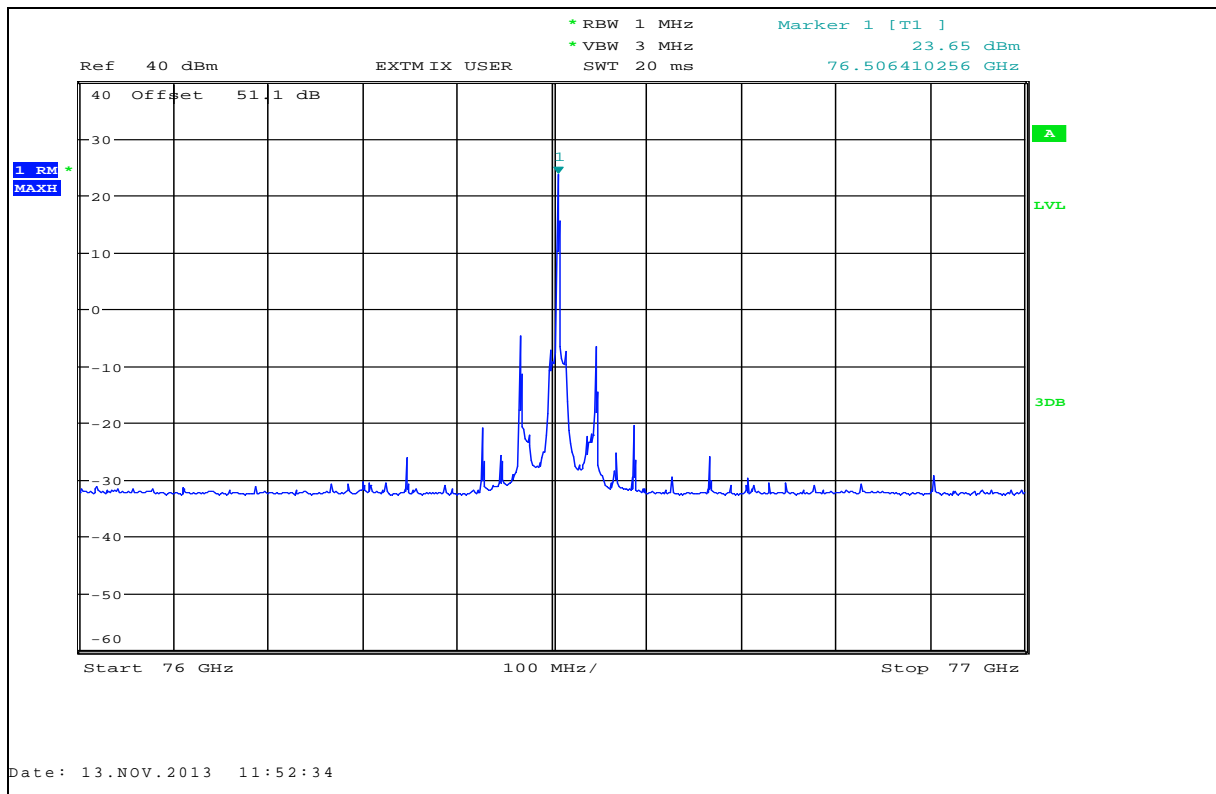

Plot 7: EIRP (Peak detector), T_{nom} / V_{nom} , CW-Test mode, high frequency

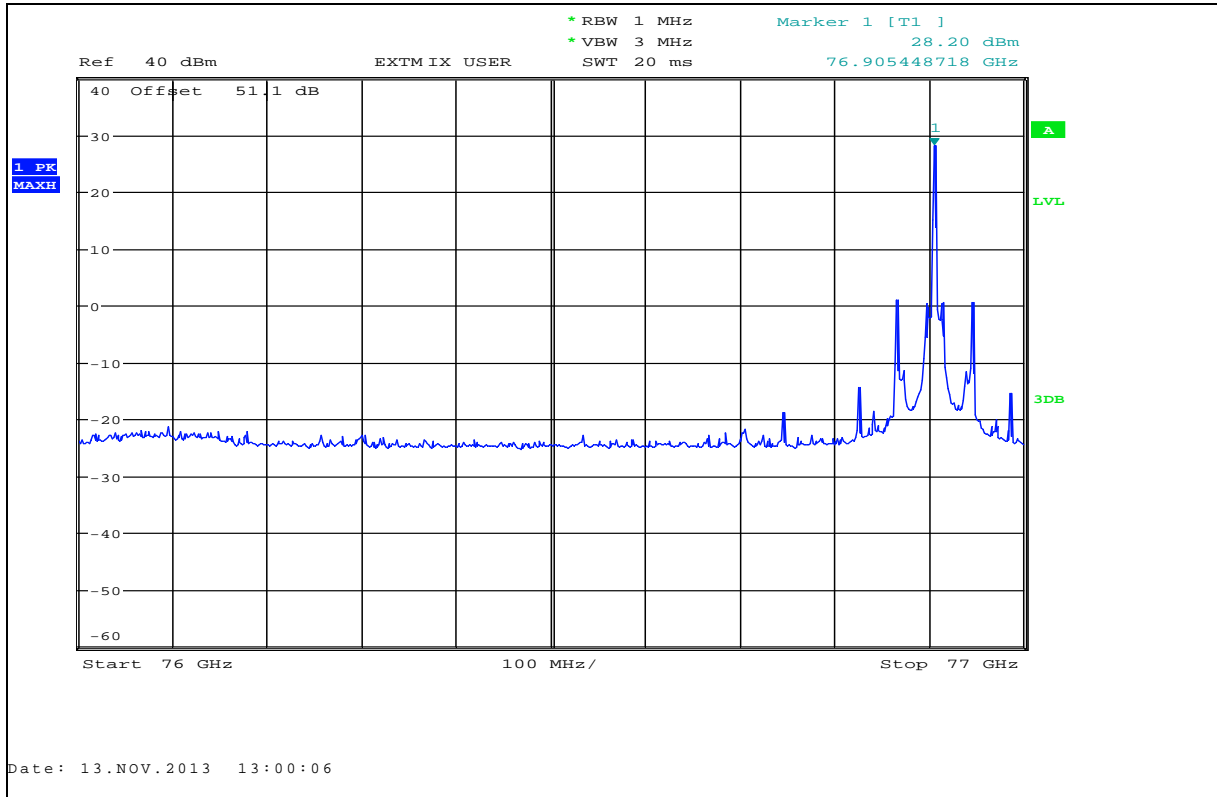

Plot 8: EIRP (RMS detector), T_{nom} / V_{nom} , CW-Test mode, high frequency

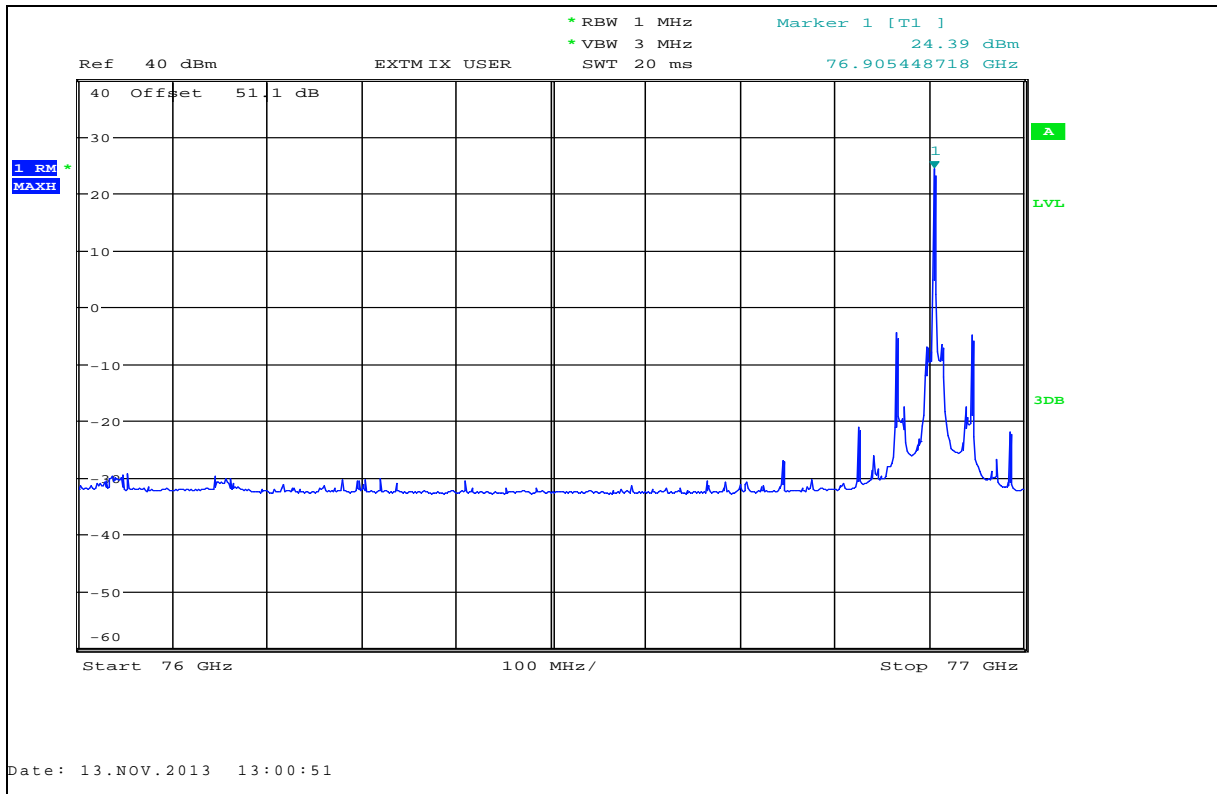

Plot 9: EIRP (Peak detector), $T_{min} / V_{min} - V_{max}$, normal operation mode

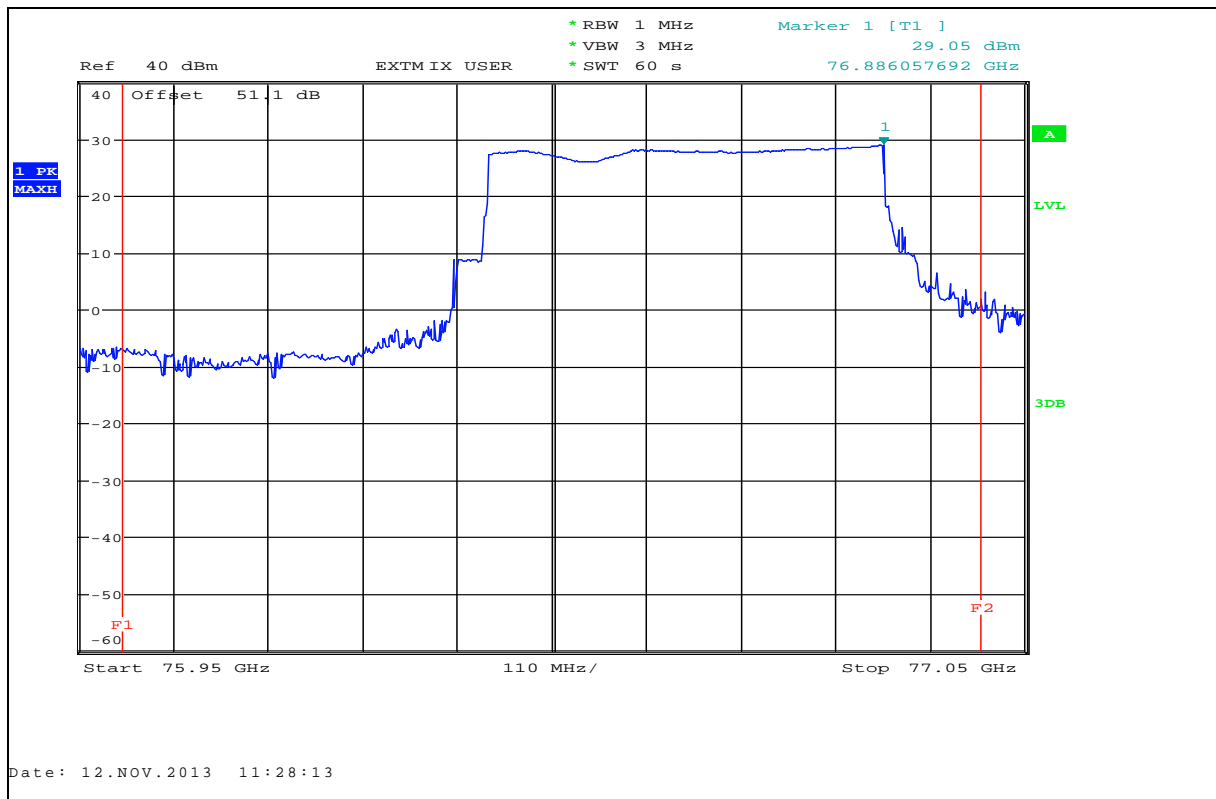

Plot 10: EIRP (RMS detector), $T_{min} / V_{min} - V_{max}$, normal operation mode

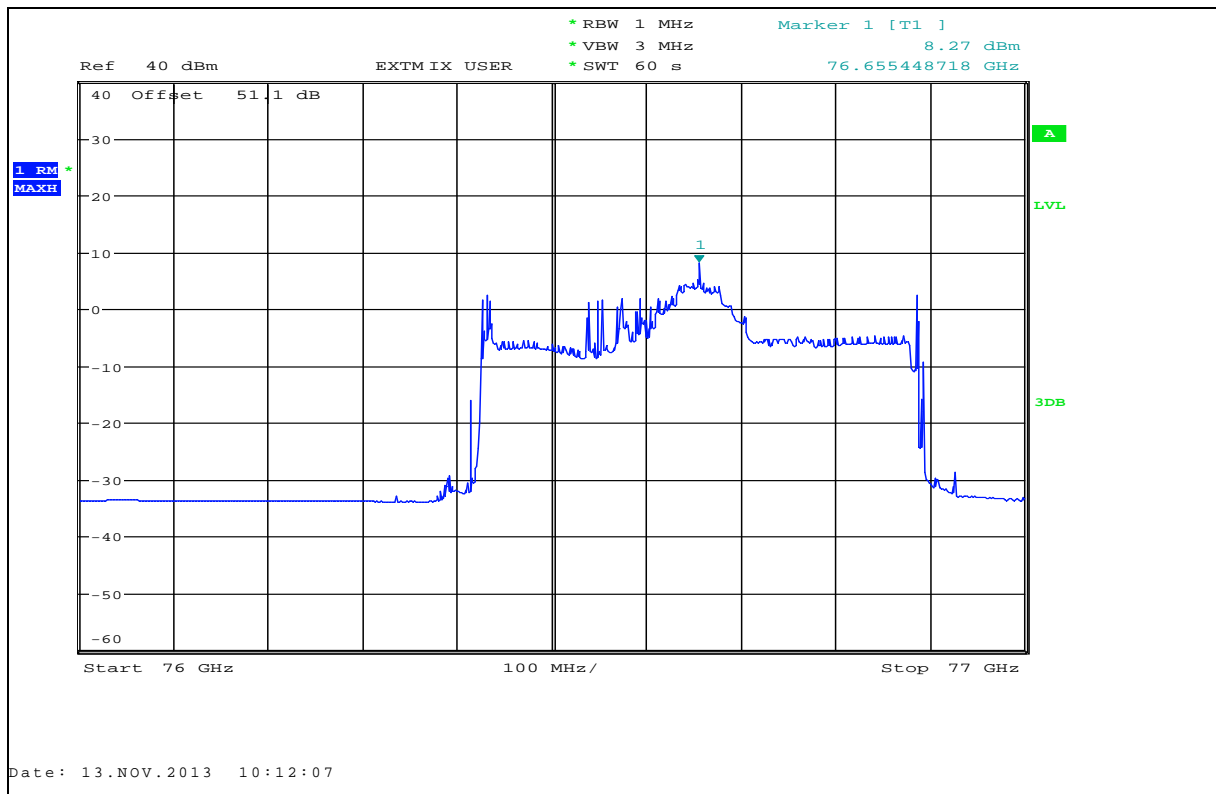

Plot 11: EIRP (Peak detector), $T_{min} / V_{min} - V_{max}$, CW-Test mode, low frequency

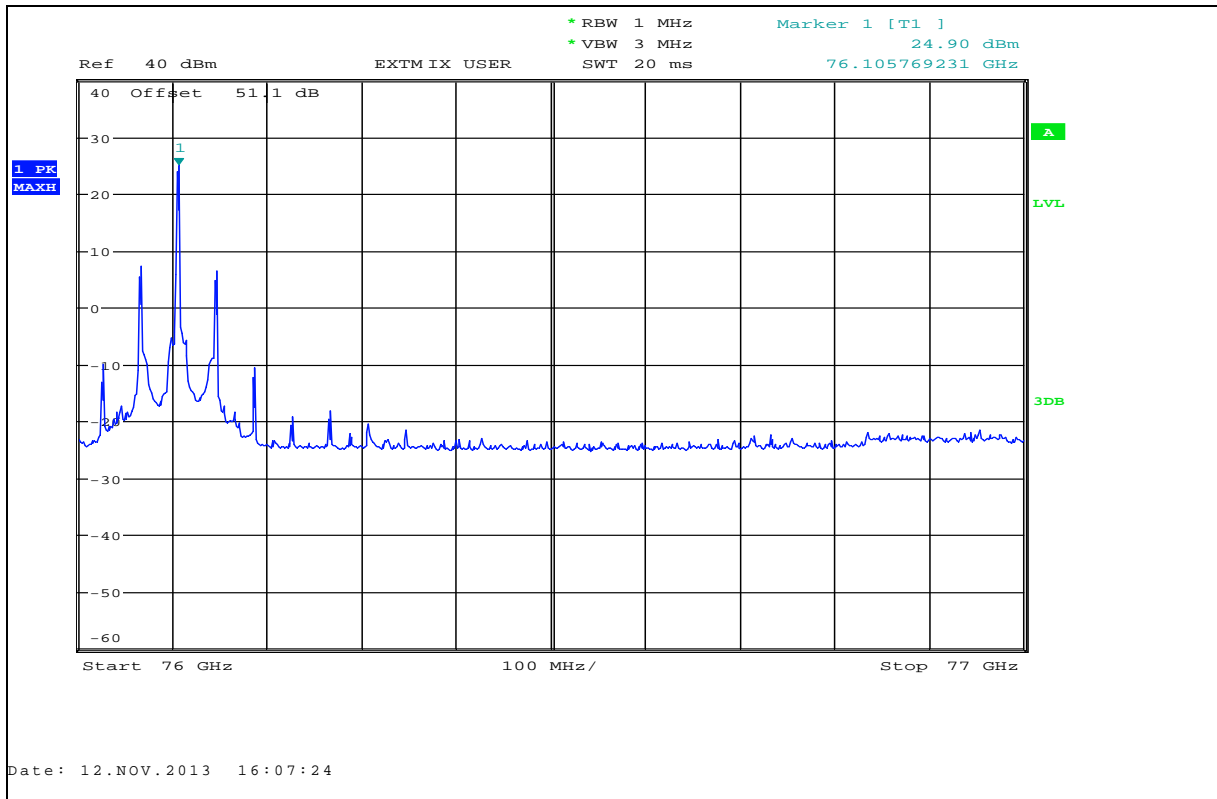

Plot 12: EIRP (RMS detector), $T_{min} / V_{min} - V_{max}$, CW-Test mode, low frequency

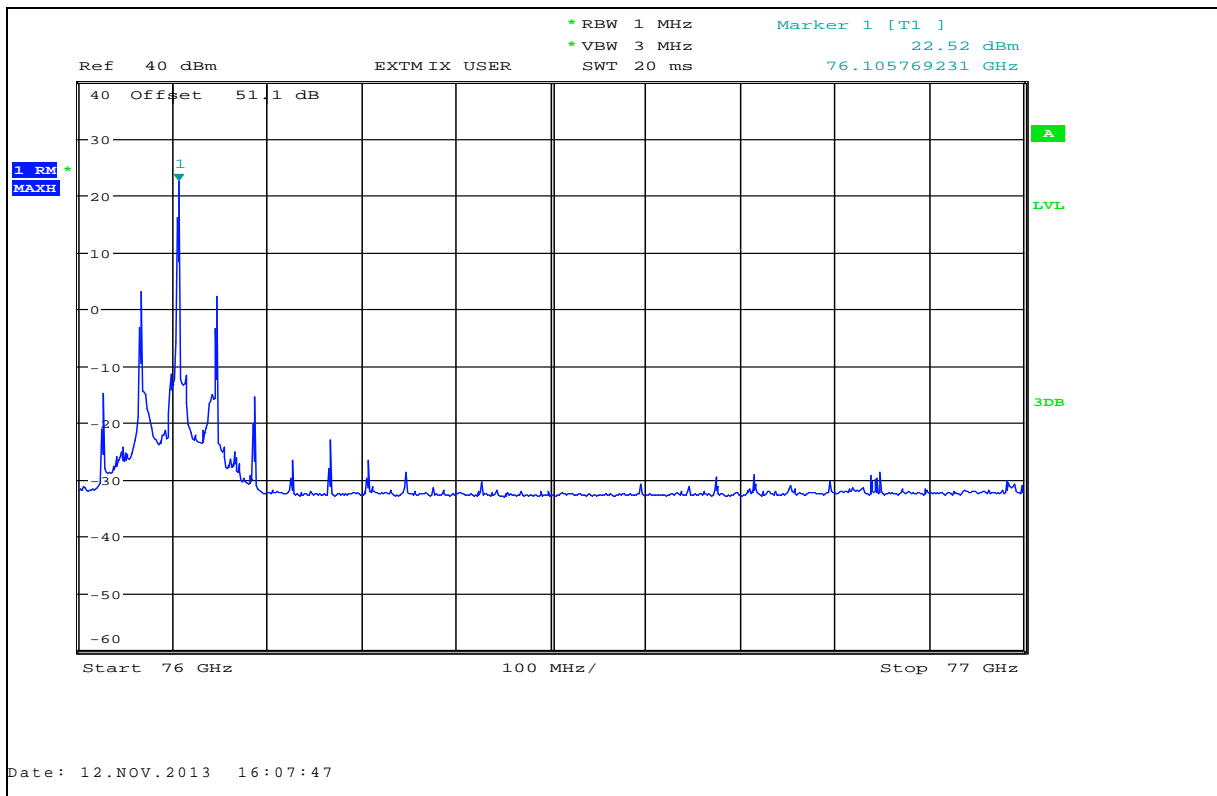

Plot 13: EIRP (Peak detector), $T_{min} / V_{min} - V_{max}$, CW-Test mode, mid frequency

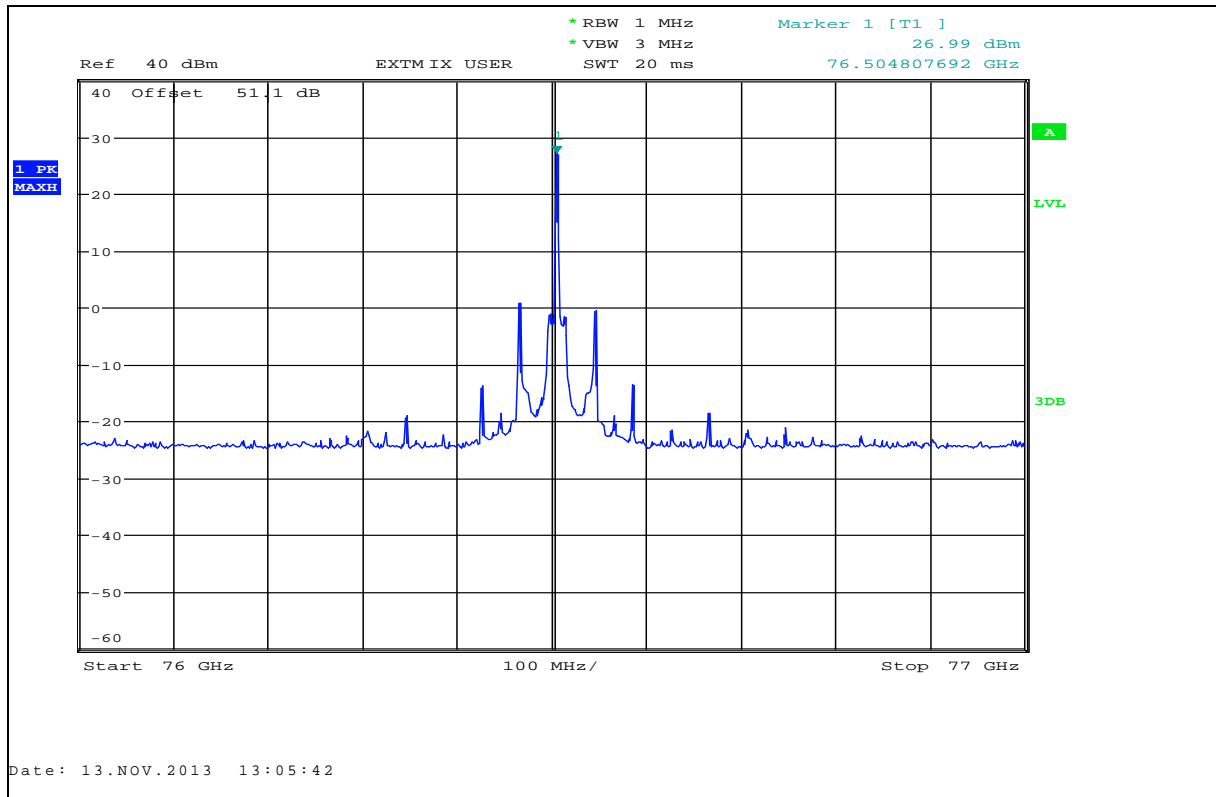

Plot 14: EIRP (RMS detector), $T_{min} / V_{min} - V_{max}$, CW-Test mode, mid frequency

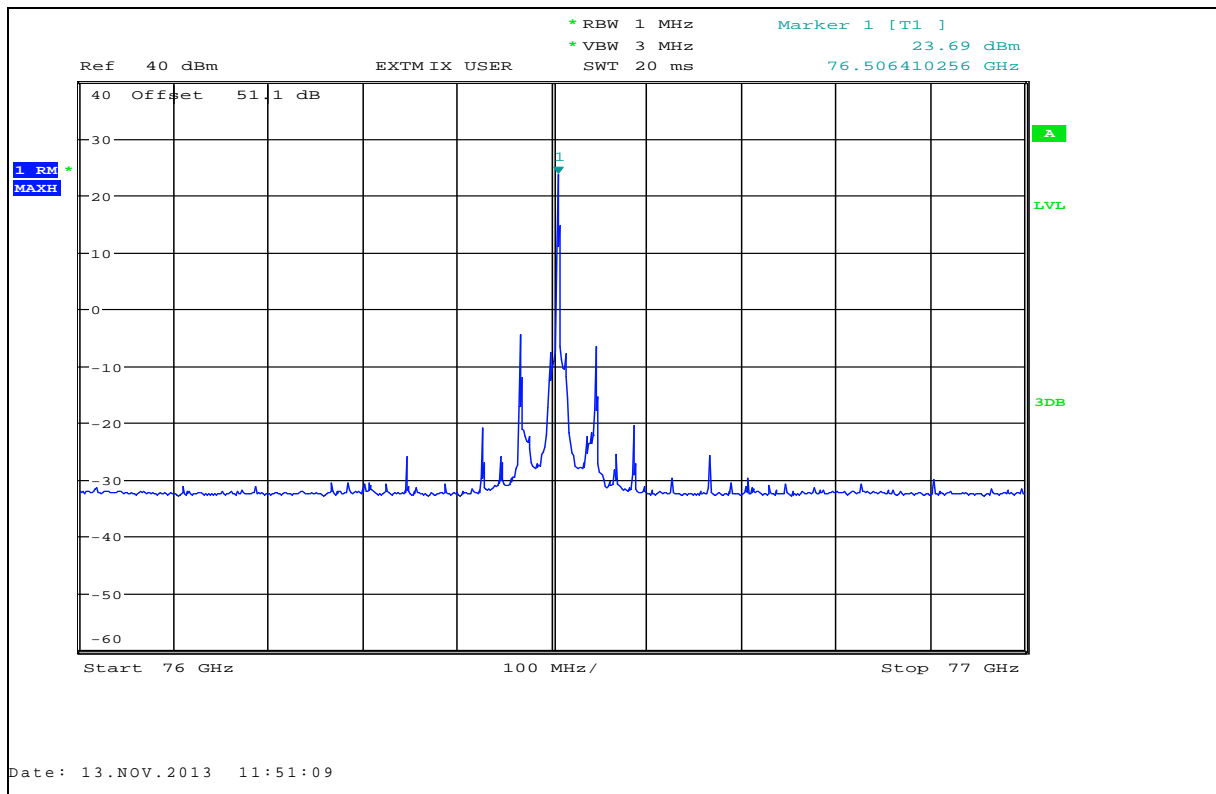

Plot 15: EIRP (Peak detector), $T_{min} / V_{min} - V_{max}$, CW-Test mode, high frequency

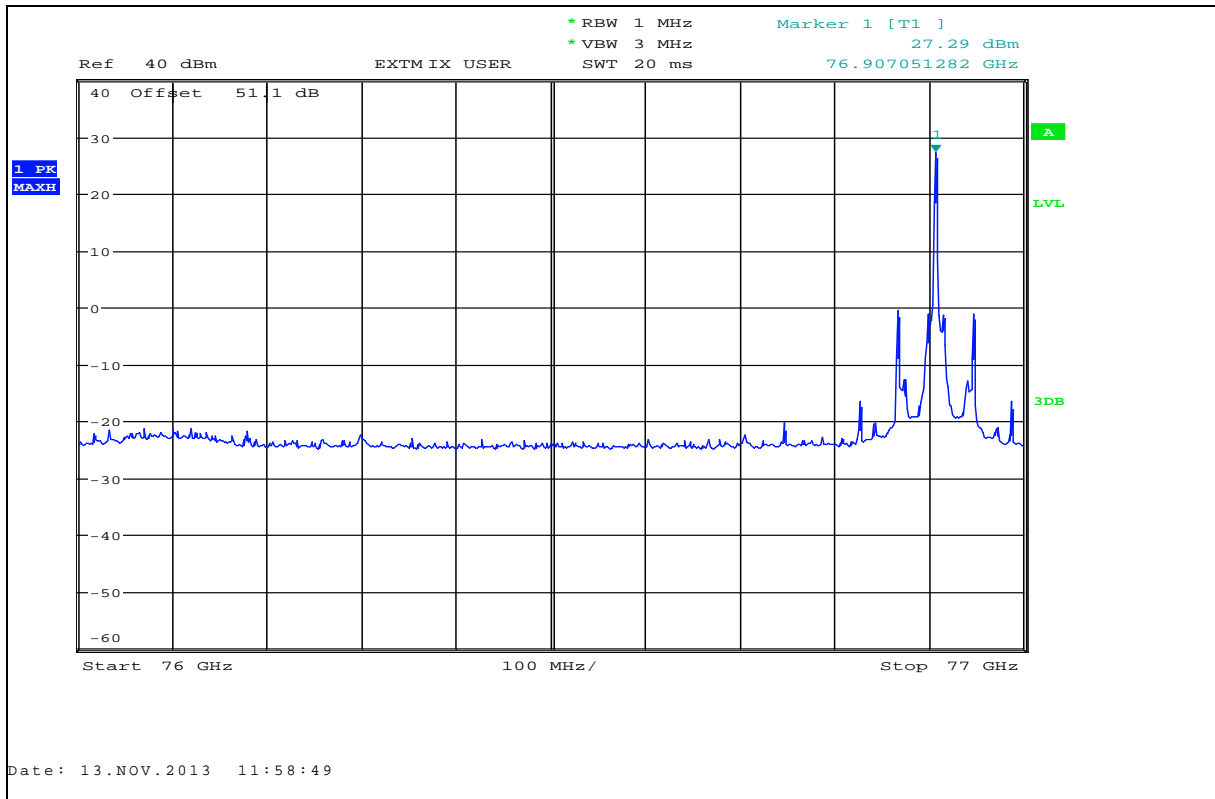

Plot 16: EIRP (RMS detector), $T_{min} / V_{min} - V_{max}$, CW-Test mode, high frequency

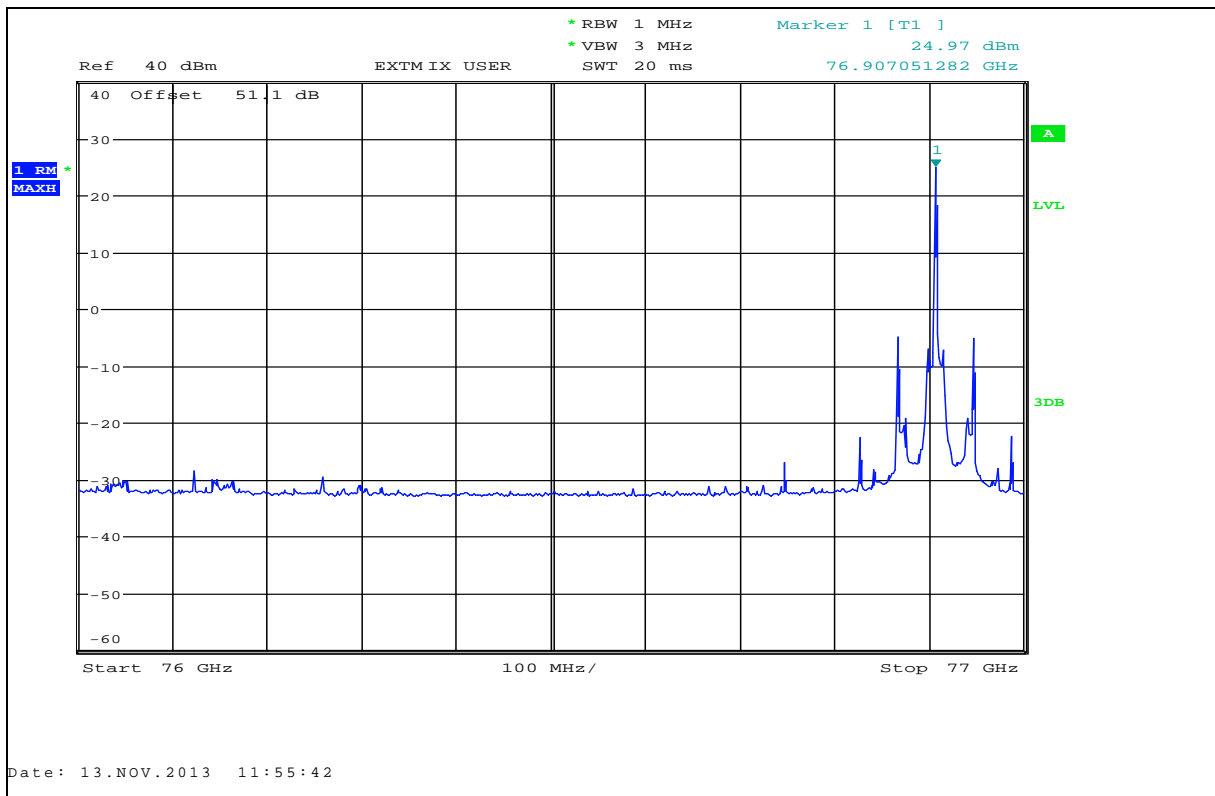

Plot 17: EIRP (Peak detector), $T_{max} / V_{min} - V_{max}$, normal operation mode

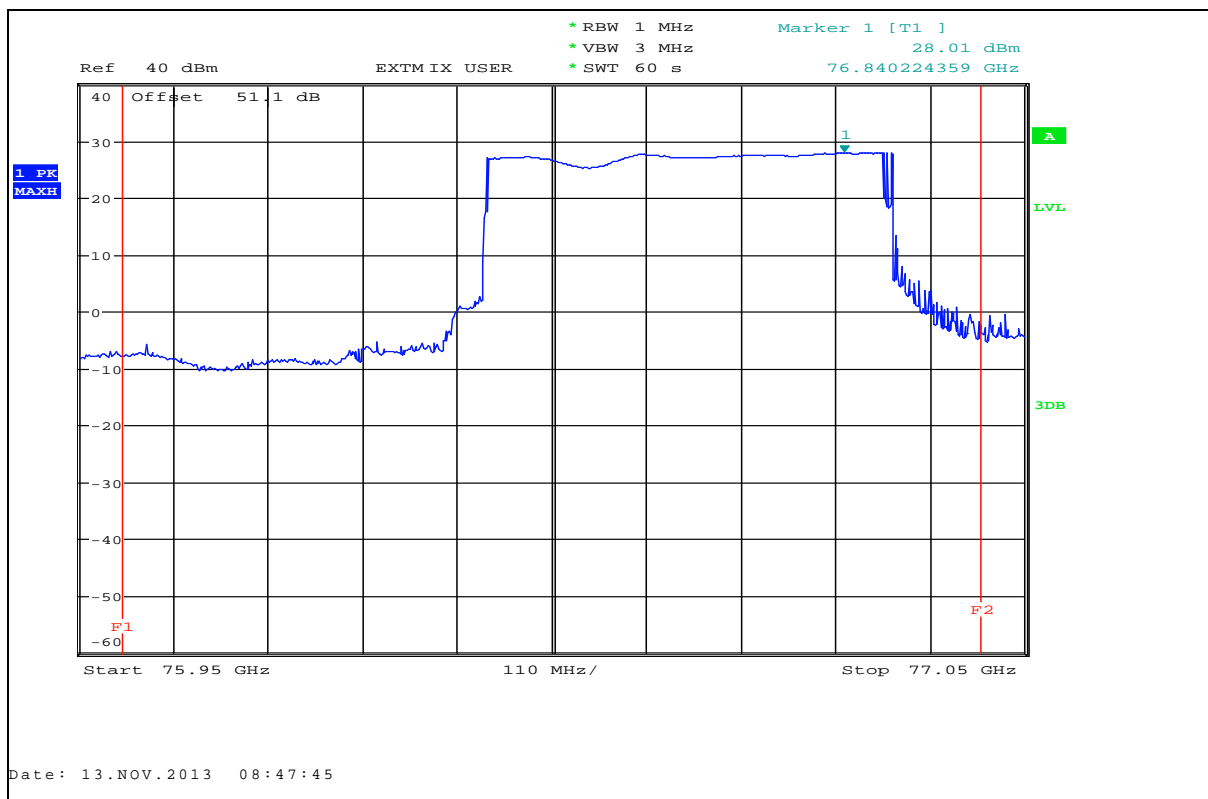

Plot 18: EIRP (RMS detector), $T_{max} / V_{min} - V_{max}$, normal operation mode

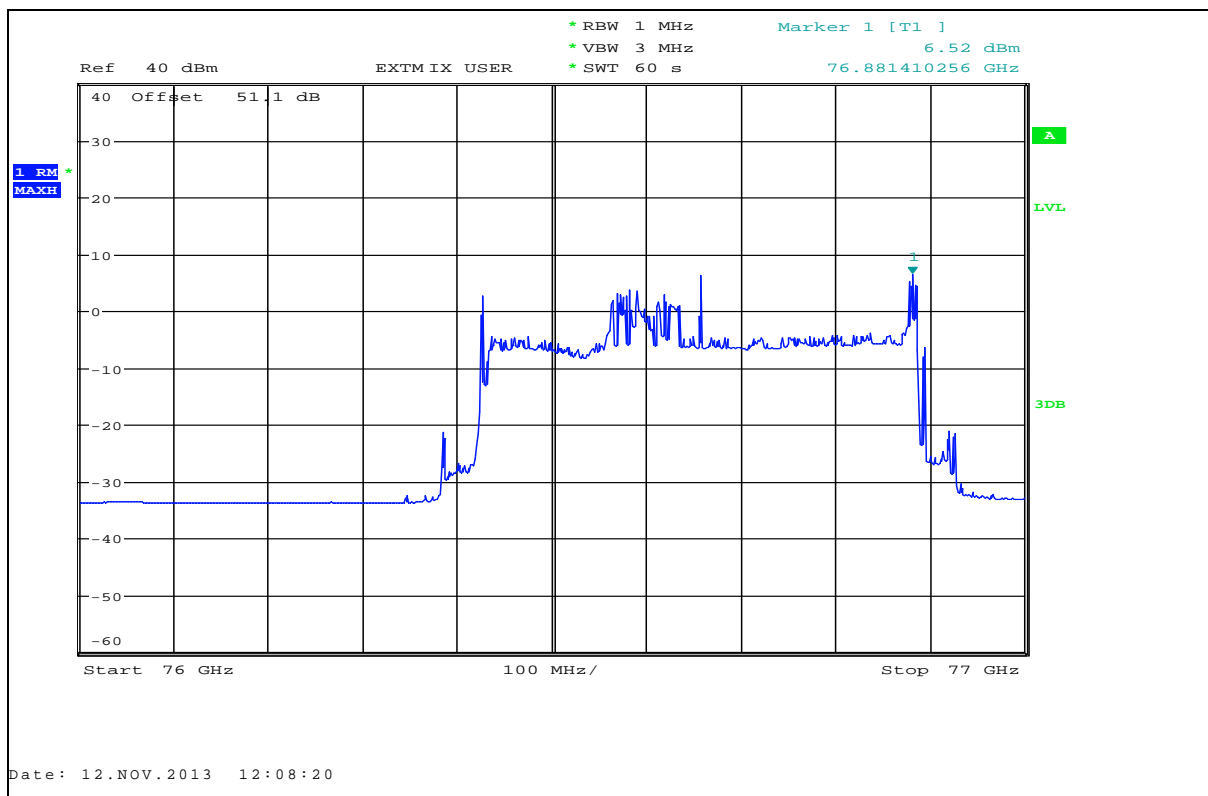

Plot 19: EIRP (Peak detector), $T_{max} / V_{min} - V_{max}$, CW-Test mode, low frequency

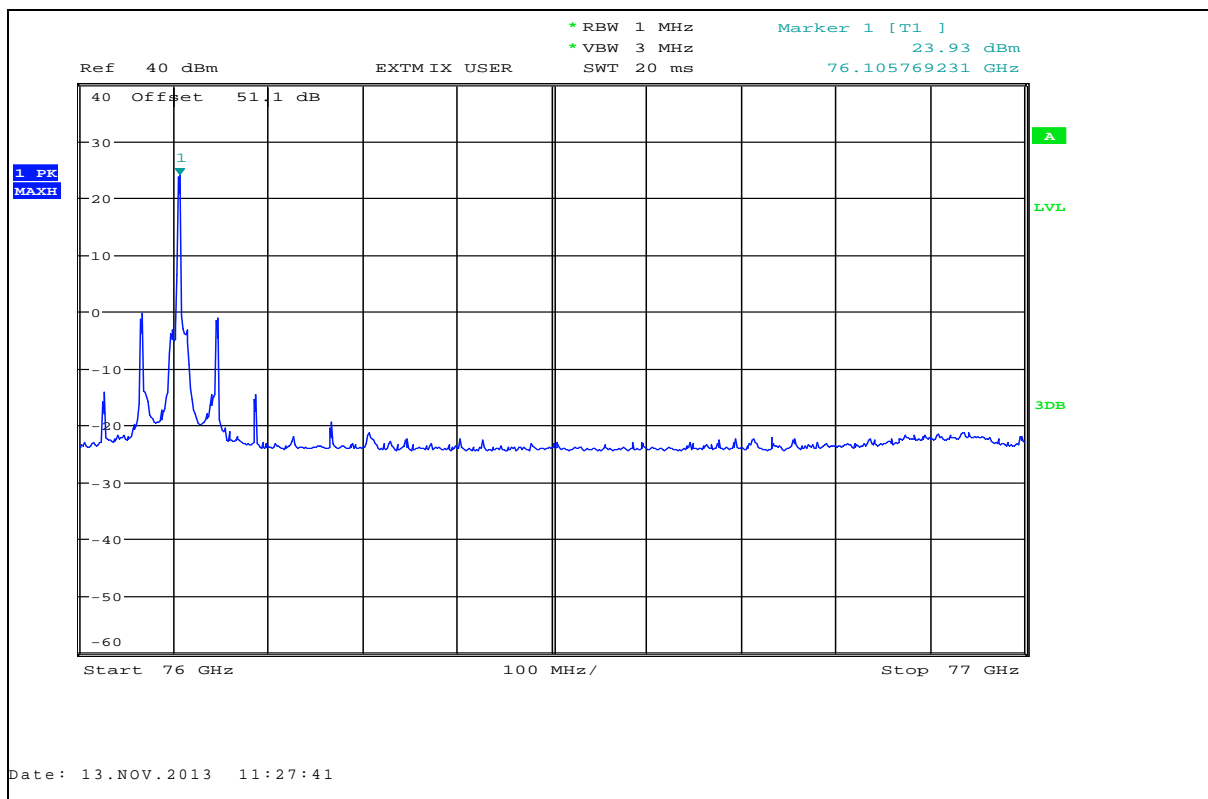

Plot 20: EIRP (RMS detector), $T_{max} / V_{min} - V_{max}$, CW-Test mode, low frequency

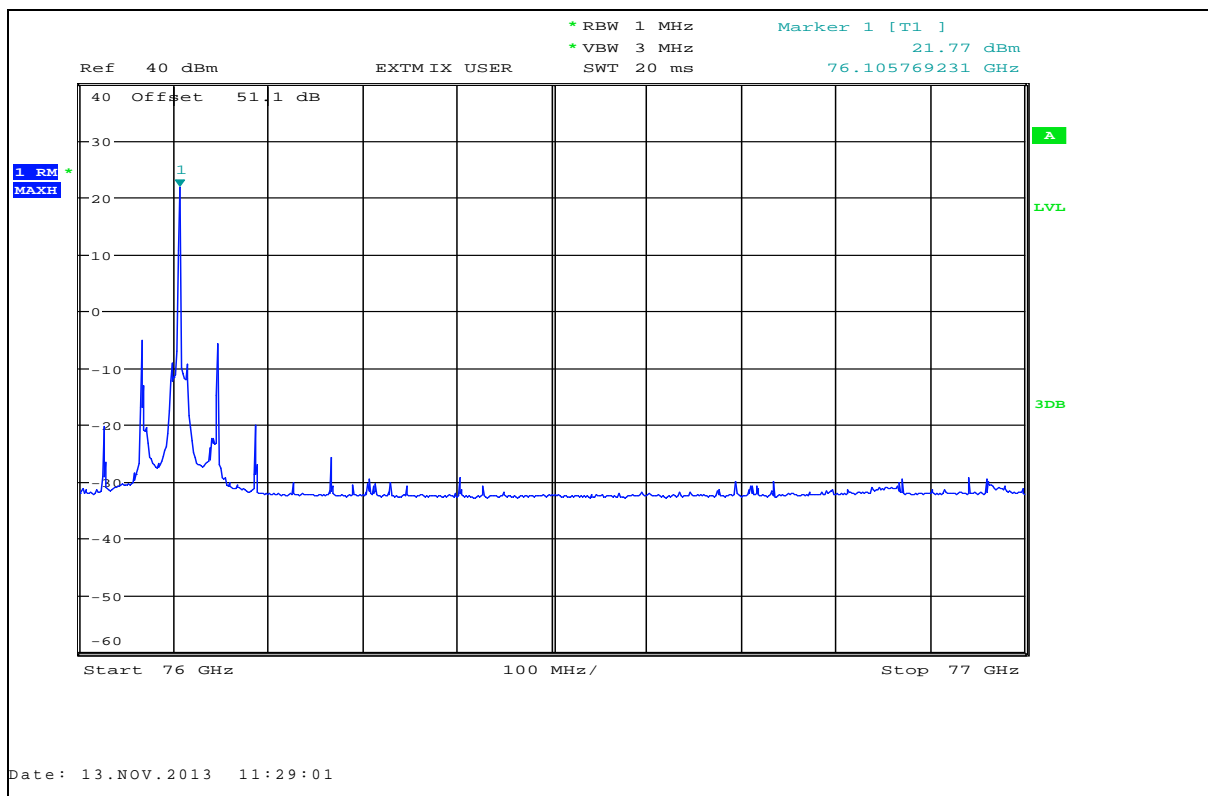

Plot 21: EIRP (Peak detector), $T_{max} / V_{min} - V_{max}$, CW-Test mode, mid frequency

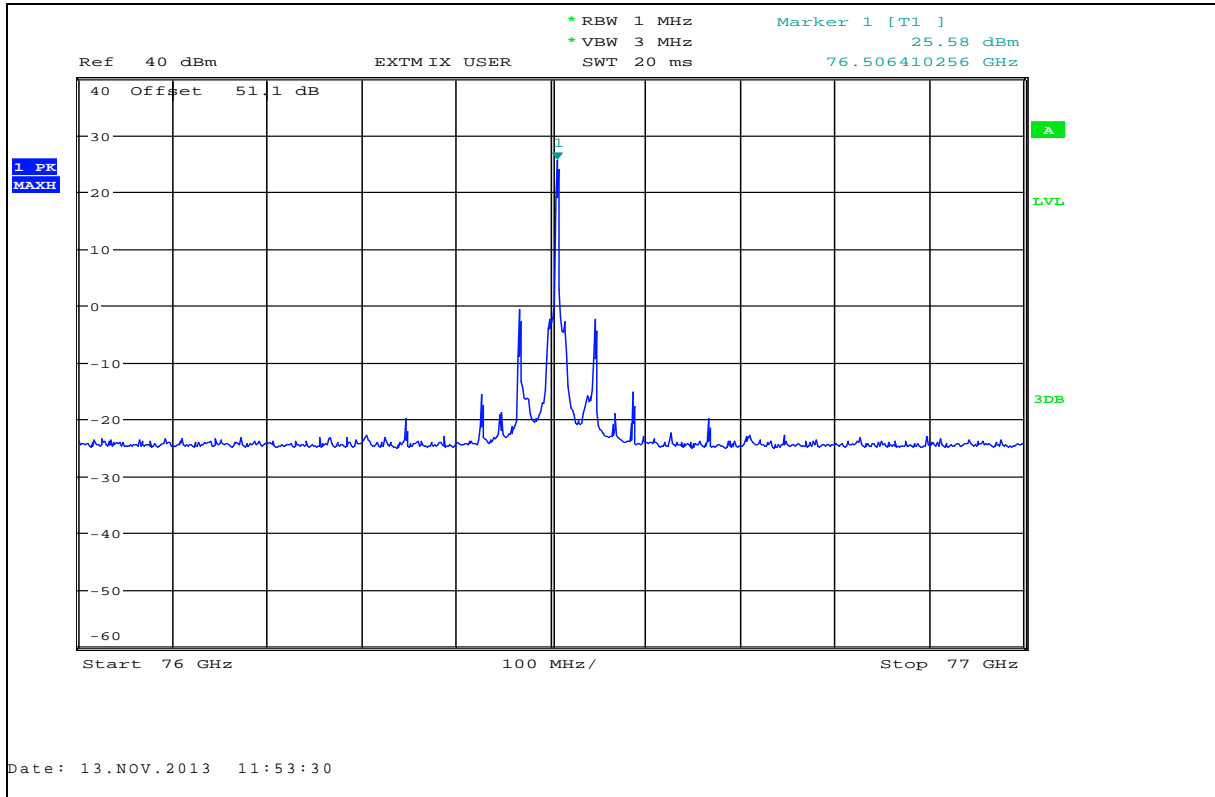

Plot 22: EIRP (RMS detector), $T_{max} / V_{min} - V_{max}$, CW-Test mode, mid frequency

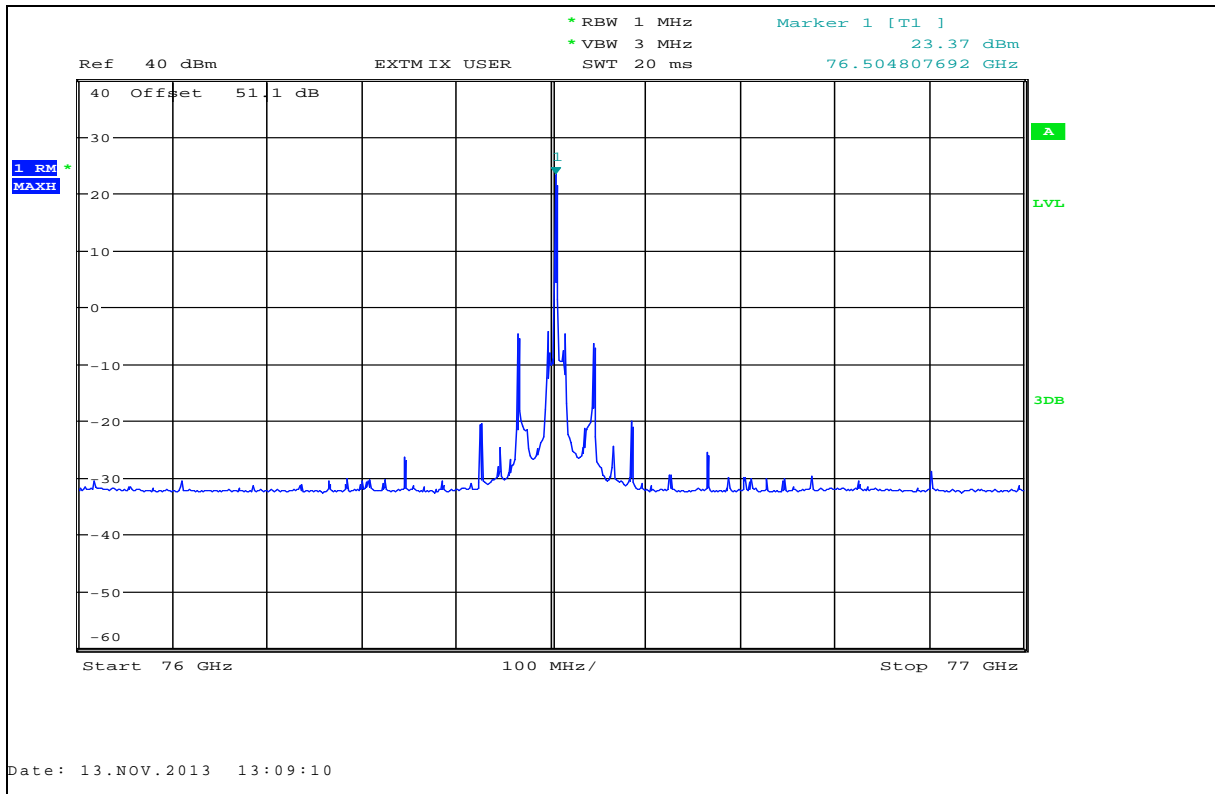

Plot 23: EIRP (Peak detector), $T_{max} / V_{min} - V_{max}$, CW-Test mode, high frequency

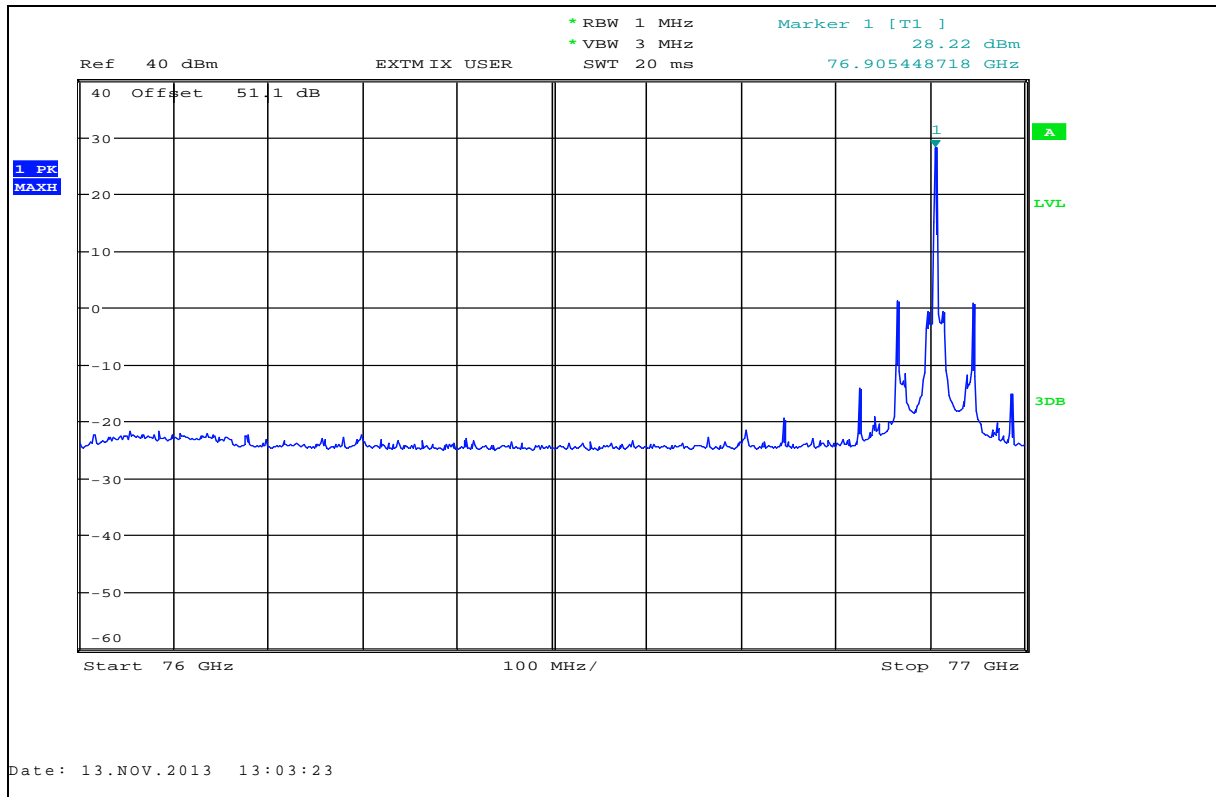

Plot 24: EIRP (RMS detector), $T_{max} / V_{min} - V_{max}$, CW-Test mode, high frequency

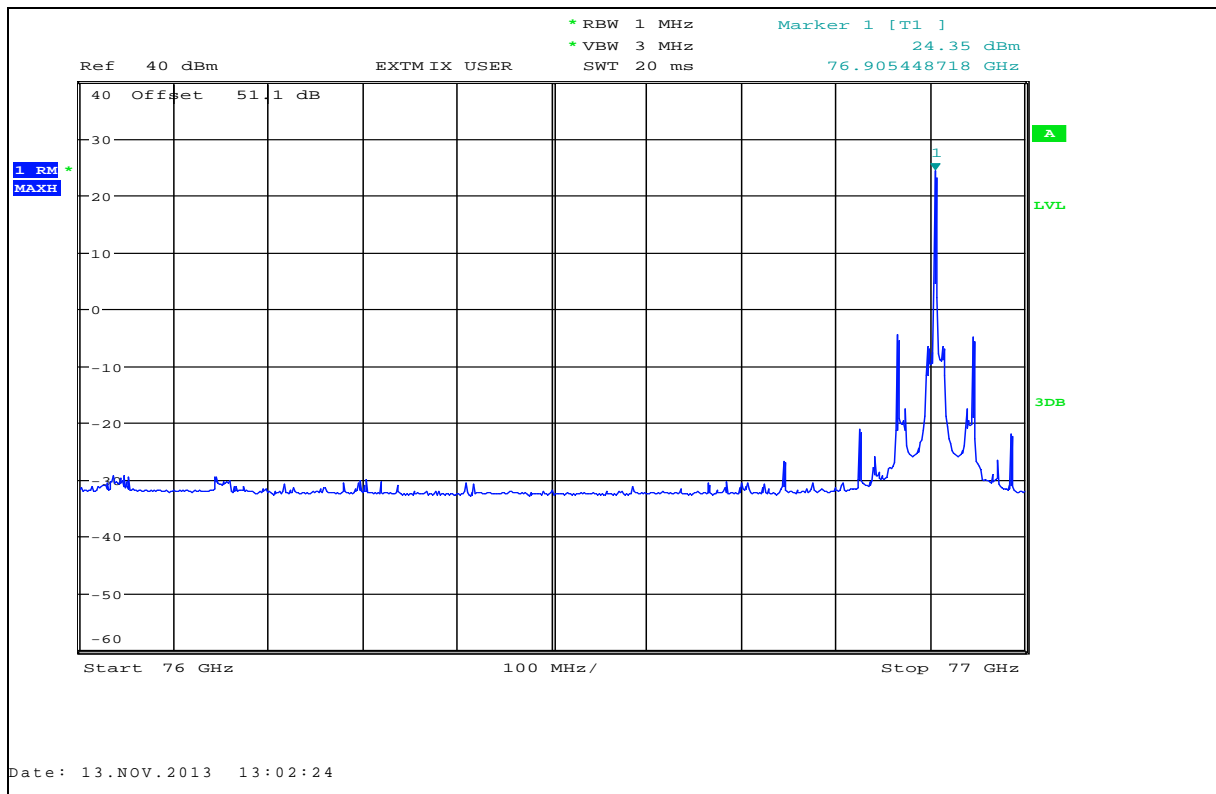

9.2 Not in Motion

Refer to 9.1, the maximum average radiated power is 8.27 dBm = 6.71 mW (normal operation mode at $T_{\min} / V_{\min} - V_{\max}$)

Limits:

RSS 210 Issue 8, Annex 13.1.2 (1)(a)

200 nW/cm ² (approximately 23.5 dBm) if the vehicle is moving slower than 1 km/hour
--

Result: The measurement is passed.

9.3 Maximum Permissible Exposure (MPE)

MPE Calculation:

$$PD = \frac{OP + AG}{(4 \times \pi \times d^2)}$$

- PD = Power Density (mW/cm²)
- OP = DUT Output Power (dBm)
- AG = DUT Antenna Gain (dBi)
- d = MPE Distance (cm)

Note: OP [mW], AG as lin.factor

§ 1.1310 Radiofrequency radiation exposure limits.

The criteria listed in table 1 shall be used to evaluate the environmental impact of human exposure to radiofrequency (RF) radiation as specified in § 1.1307(b), except in the case of portable devices which shall be evaluated according to the provisions of § 2.1093 of this chapter. Further information on evaluating compliance with these limits can be found in the FCC’s OST/OET Bulletin Number 65, “Evaluating Compliance with FCC-Specified Guidelines for Human Exposure to Radiofrequency Radiation.”

NOTE TO INTRODUCTORY PARAGRAPH: These limits are generally based on recommended exposure guidelines published by the National Council on Radiation Protection and Measurements (NCRP) in “Biological Effects and Exposure Criteria for Radiofrequency Electromagnetic Fields,” NCRP Report No. 86, Sections 17.4.1, 17.4.1.1, 17.4.2 and 17.4.3.

Copyright NCRP, 1986, Bethesda, Maryland 20814. In the frequency range from 100 MHz to 1500 MHz, exposure limits for field strength and power density are also generally based on guidelines recommended by the American National Standards Institute (ANSI) in Section 4.1 of “IEEE Standard for Safety Levels with Respect to Human Exposure to Radio Frequency Electromagnetic Fields, 3 kHz to 300 GHz,” ANSI/IEEE C95.1–1992, Copyright 1992 by the Institute of Electrical and Electronics Engineers, Inc., New York, New York 10017.

TABLE 1—LIMITS FOR MAXIMUM PERMISSIBLE EXPOSURE (MPE)

Frequency range (MHz)	Electric field strength (V/m)	Magnetic field strength (A/m)	Power density (mW/cm ²)	Averaging time (minutes)
(A) Limits for Occupational/Controlled Exposures				
0.3–3.0	614	1.63	*(100)	6
3.0–30	1842/f	4.89/f	*(900/f ²)	6
30–300	61.4	0.163	1.0	6
300–1500	f/300	6
1500–100,000	5	6
(B) Limits for General Population/Uncontrolled Exposure				
0.3–1.34	614	1.63	*(100)	30
1.34–30	824/f	2.19/f	*(180/f ²)	30
30–300	27.5	0.073	0.2	30
300–1500	f/1500	30
1500–100,000	1.0	30

f = frequency in MHz
 * = Plane-wave equivalent power density

NOTE 1 TO TABLE 1: Occupational/controlled limits apply in situations in which persons are exposed as a consequence of their employment provided those persons are fully aware of the potential for exposure and can exercise control over their exposure. Limits for occupational/controlled exposure also apply in situations when an individual is transient through a location where occupational/controlled limits apply provided he or she is made aware of the potential for exposure.

NOTE 2 TO TABLE 1: General population/uncontrolled exposures apply in situations in which the general public may be exposed, or in which persons that are exposed as a consequence of their employment may not be fully aware of the potential for exposure or can not exercise control over their exposure.

[61 FR 41016, Aug. 7, 1996]

Results:

Refer to 9.1 Power density, max. EIRP (normal mode @ $T_{min} / V_{min} - V_{max}$) measured = 29.05 dBm = 803.53 mW

d = 20 cm

The manufacturer declared an antenna gain of 19.8 dBi

→ PD = 0.16 mW/cm²

Limits:

FCC §1.1310 (B)

Frequency [GHz]	Power Density [mW / cm ²]
1.500 GHz – 100.000 GHz	1 mW / cm ²

Result: The measurement is passed.

9.4 Occupied bandwidth

Definition:

The width of the frequency band which is just sufficient such that, below the lower and above the upper frequency limits, the mean powers emitted are each equal to 0.5% of the total mean power of a given emission.

Measurement results:

Test conditions	99 % Occupied bandwidth [MHz]
T_{nom} / V_{nom}	461.6
$T_{min} / V_{min} - V_{max}$	461.6
$T_{max} / V_{min} - V_{max}$	461.6

Limits:

FCC §2.1049

Frequency range	$f(\text{lowest}) > 76.0 \text{ GHz}$	$f(\text{highest}) < 77.0 \text{ GHz}$
-----------------	---------------------------------------	--

Limits:

RSS 210 Issue 8, Annex 13.1.1

Frequency range	$f(\text{lowest}) > 76.0 \text{ GHz}$	$f(\text{highest}) < 77.0 \text{ GHz}$
-----------------	---------------------------------------	--

Result: The measurement is passed.

Plot 25: Occupied bandwidth (99%), $T_{nom} / V_{min-max}$, normal operation mode

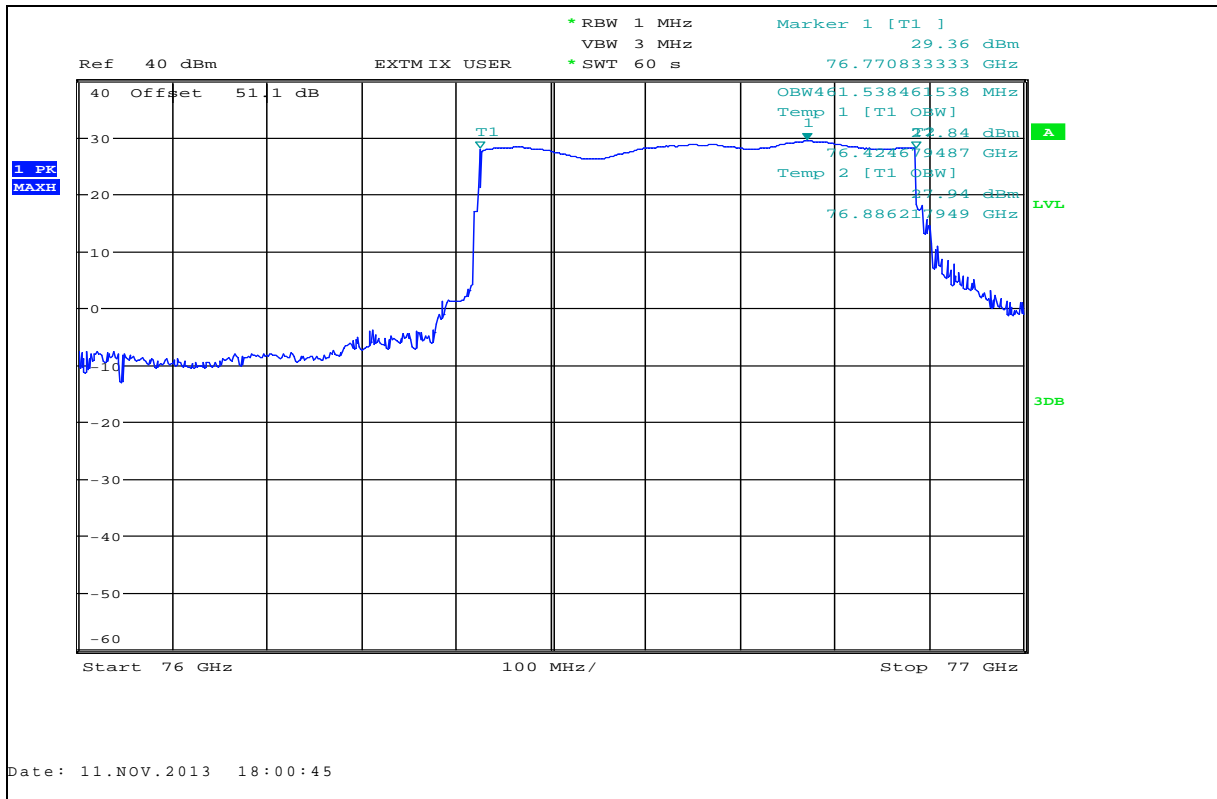

Plot 26: Occupied bandwidth (99%), $T_{min} / V_{min-max}$, normal operation mode

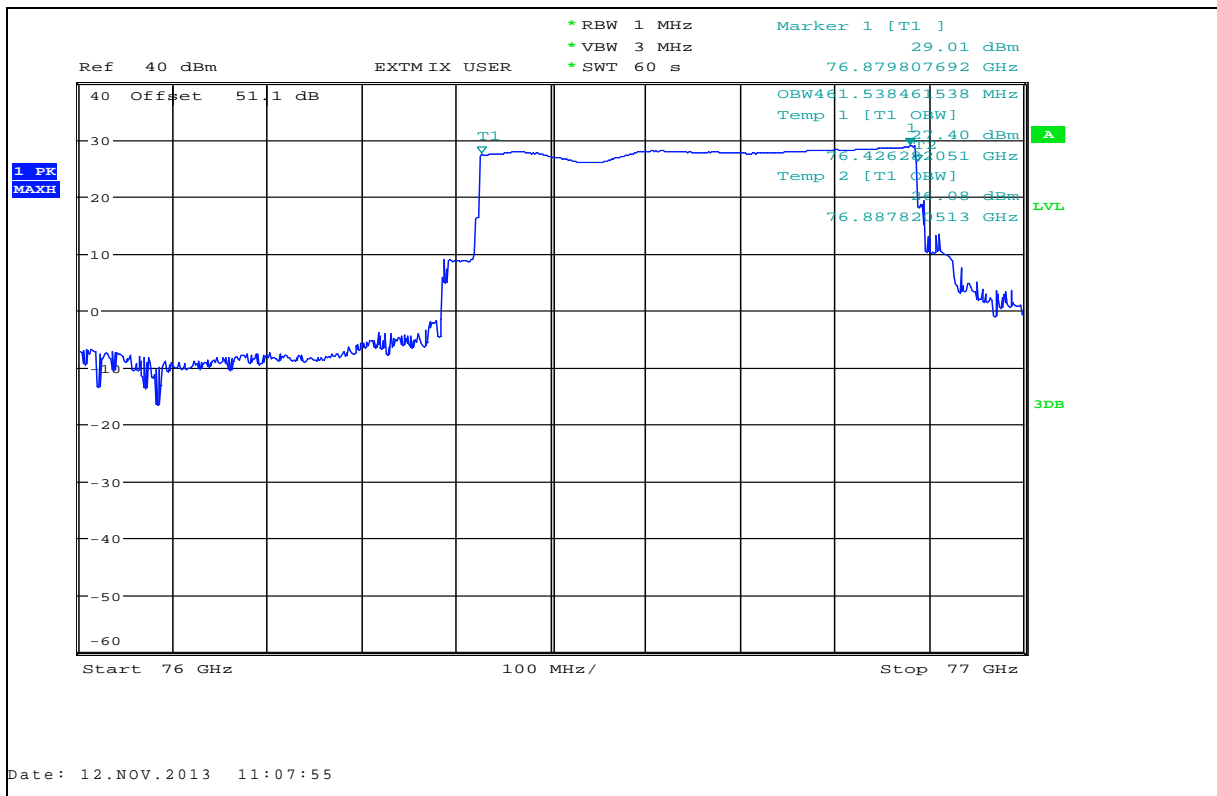

Plot 27: Occupied bandwidth (99%), $T_{max} / V_{min} - V_{max}$, normal operation mode

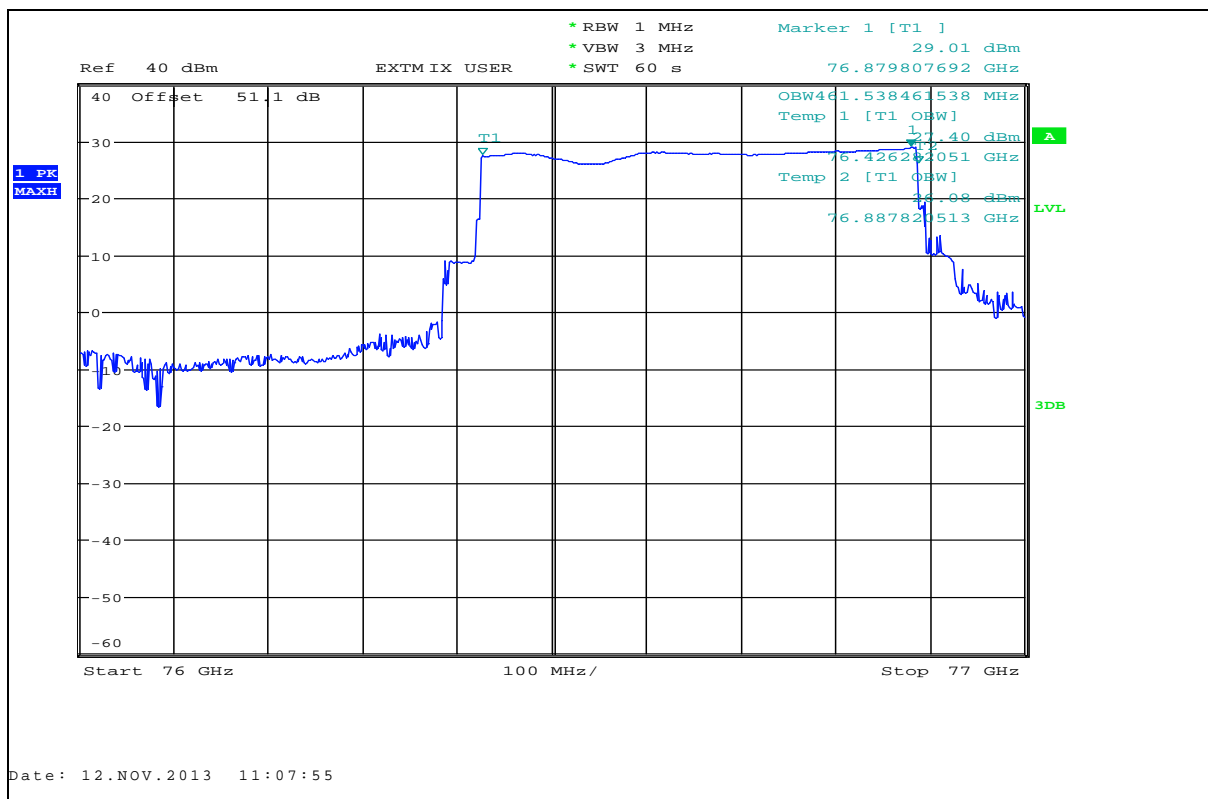

9.5 Field strength of emissions (radiated spurious)

Description:

Measurement of the radiated spurious emissions in transmit mode.

Measurement:

Measurement parameter	
Detector:	Peak / Quasi Peak
Sweep time:	Auto
Video bandwidth:	Auto
Resolution bandwidth:	F < 1 GHz: 100 kHz F > 1 GHz: 1 MHz
Frequency range:	30 MHz to 235 GHz
Trace-Mode:	Max Hold

Plot 28: 9 kHz – 30 MHz, magnetic loop antenna, RX-Mode

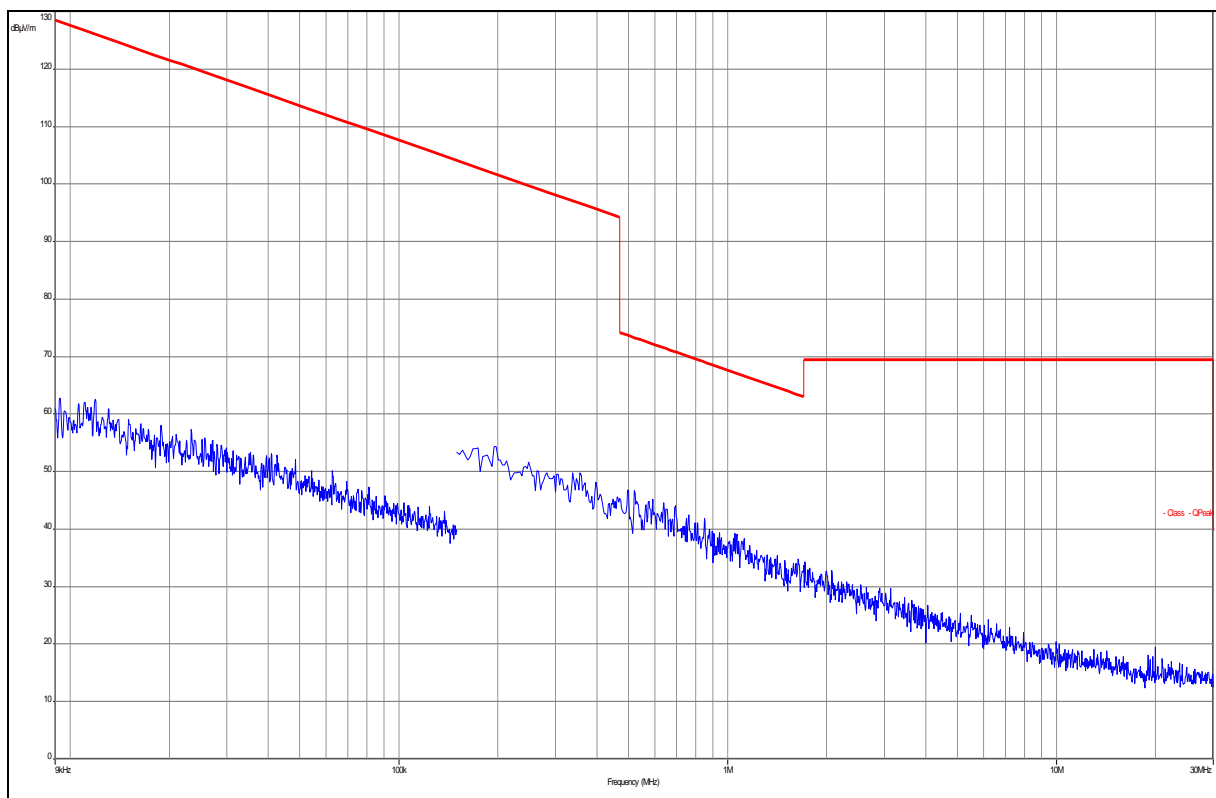

Plot 29: 9 kHz – 30 MHz, magnetic loop antenna, TX-Mode, low frequency

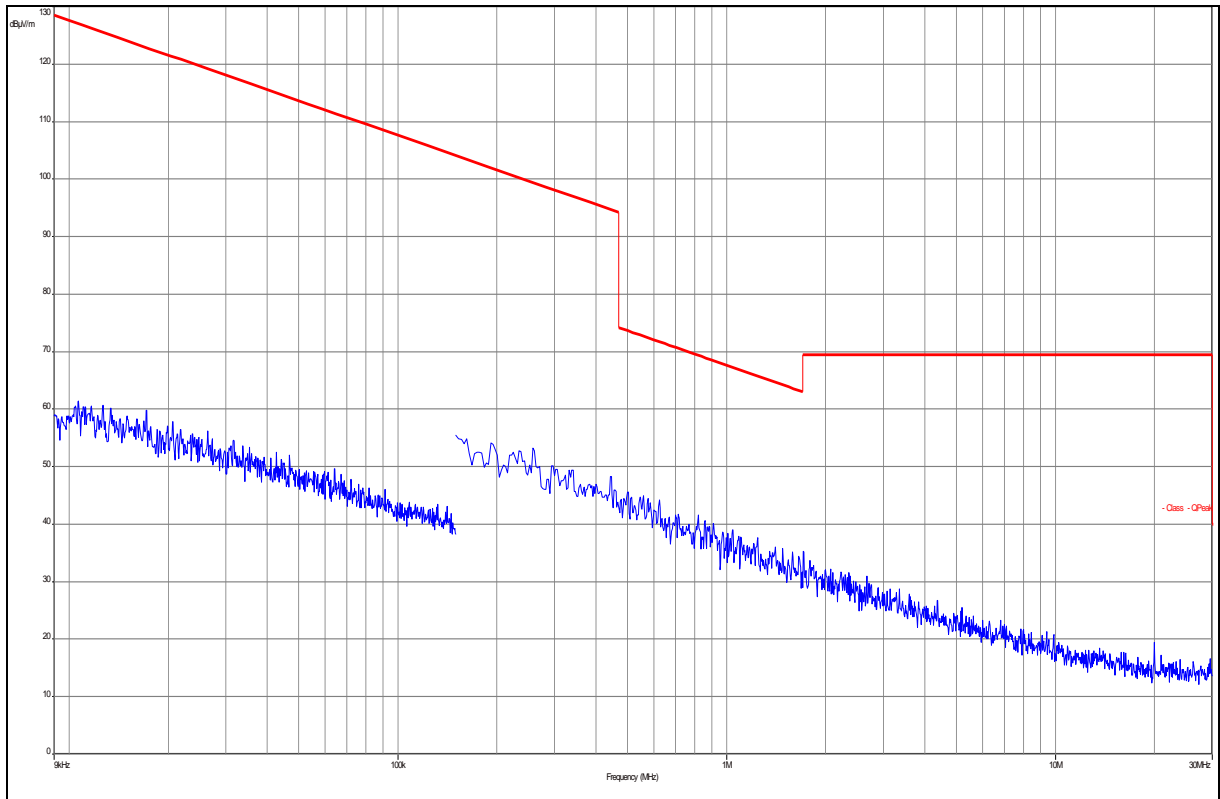

Plot 30: 9 kHz – 30 MHz, magnetic loop antenna, TX-Mode, middle frequency

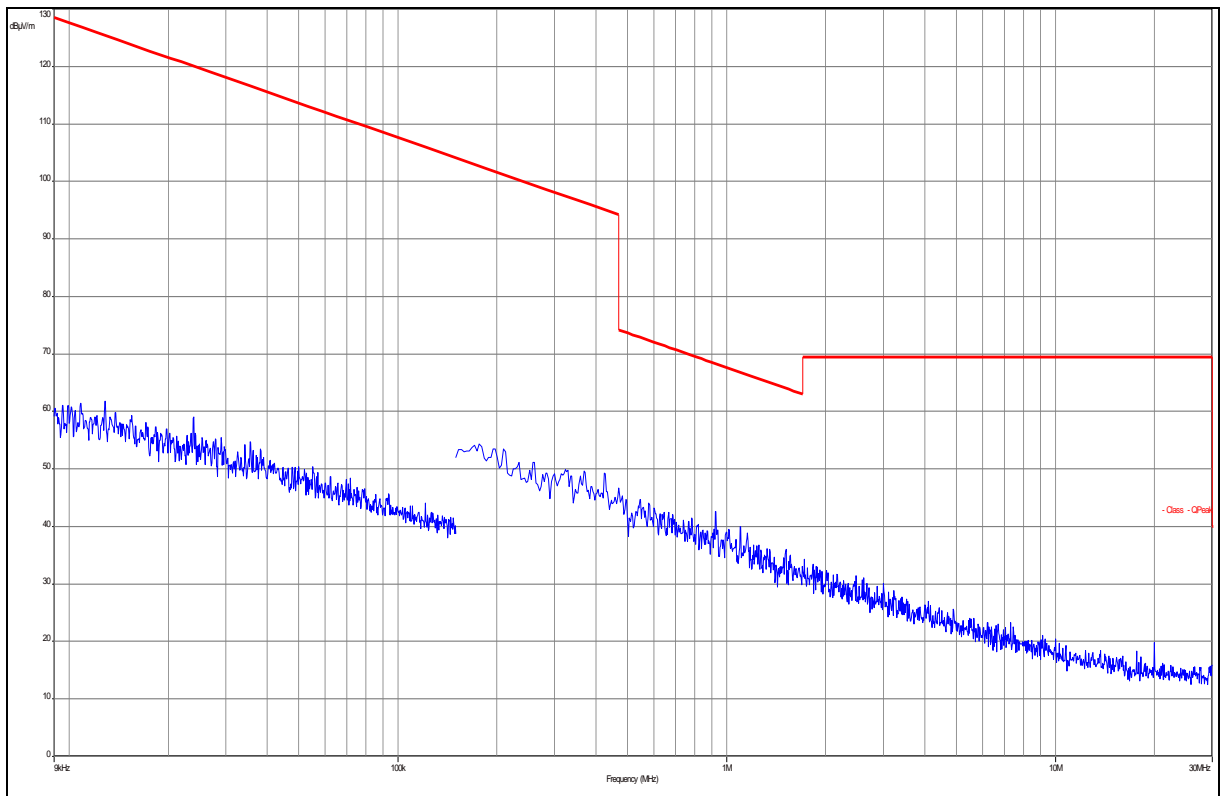

Plot 31: 9 kHz – 30 MHz, magnetic loop antenna, TX-Mode, high frequency

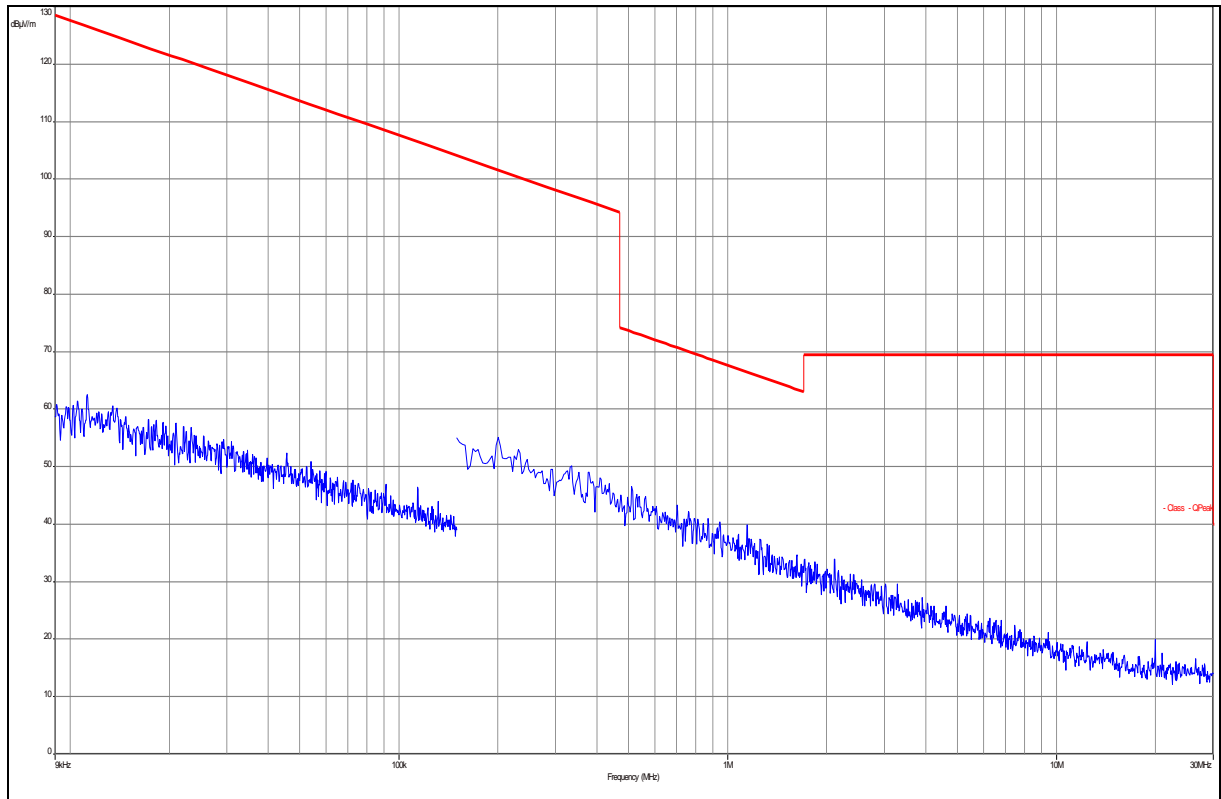

Plot 32: 30 MHz – 1 GHz, antenna horizontal / vertical, RX-Mode

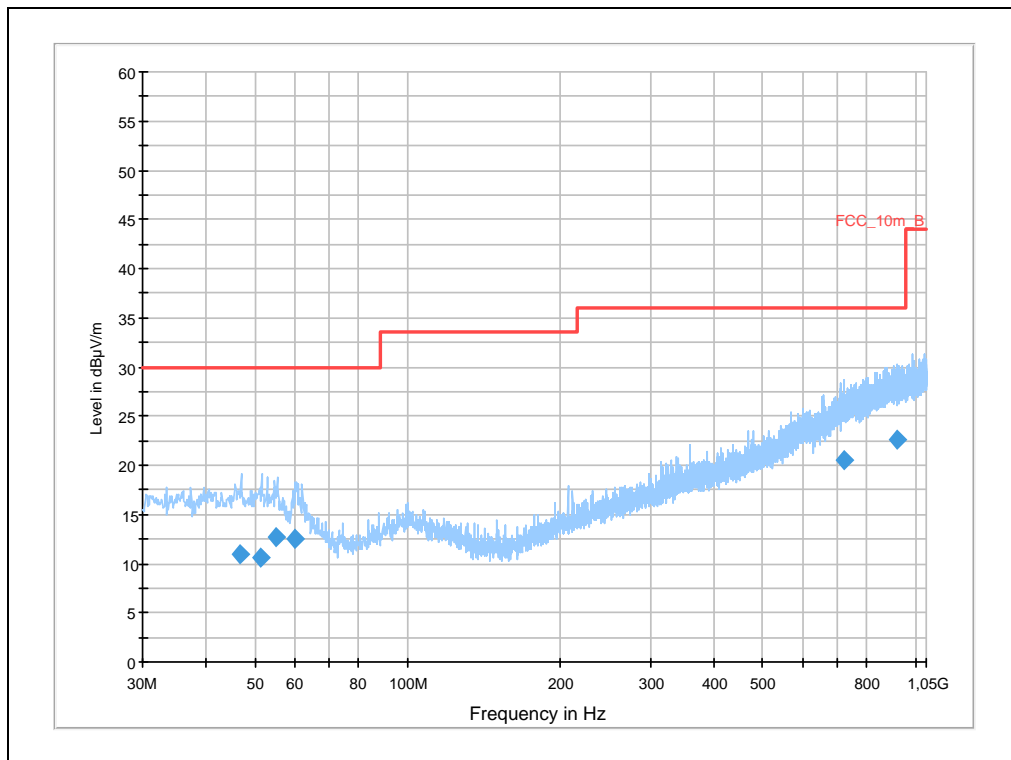

Frequency (MHz)	QuasiPeak (dBµV/m)	Bandwidth (kHz)	Height (cm)	Polarization	Azimuth (deg)	Corr. (dB)	Margin (dB)	Limit (dBµV/m)
46.876200	11.0	1000.0	120.000	188.0	V	-4.0	13.3	19.0
51.325950	10.6	1000.0	120.000	400.0	V	99.0	13.2	19.4
54.998850	12.7	1000.0	120.000	354.0	V	89.0	12.9	17.3
60.041400	12.6	1000.0	120.000	200.0	V	-24.0	11.6	17.4
722.495850	20.5	1000.0	120.000	200.0	H	128.0	23.0	15.5
921.380100	22.5	1000.0	120.000	264.0	H	-6.0	25.3	13.5

Plot 33: 30 MHz – 1 GHz, antenna horizontal / vertical, TX-Mode, low frequency

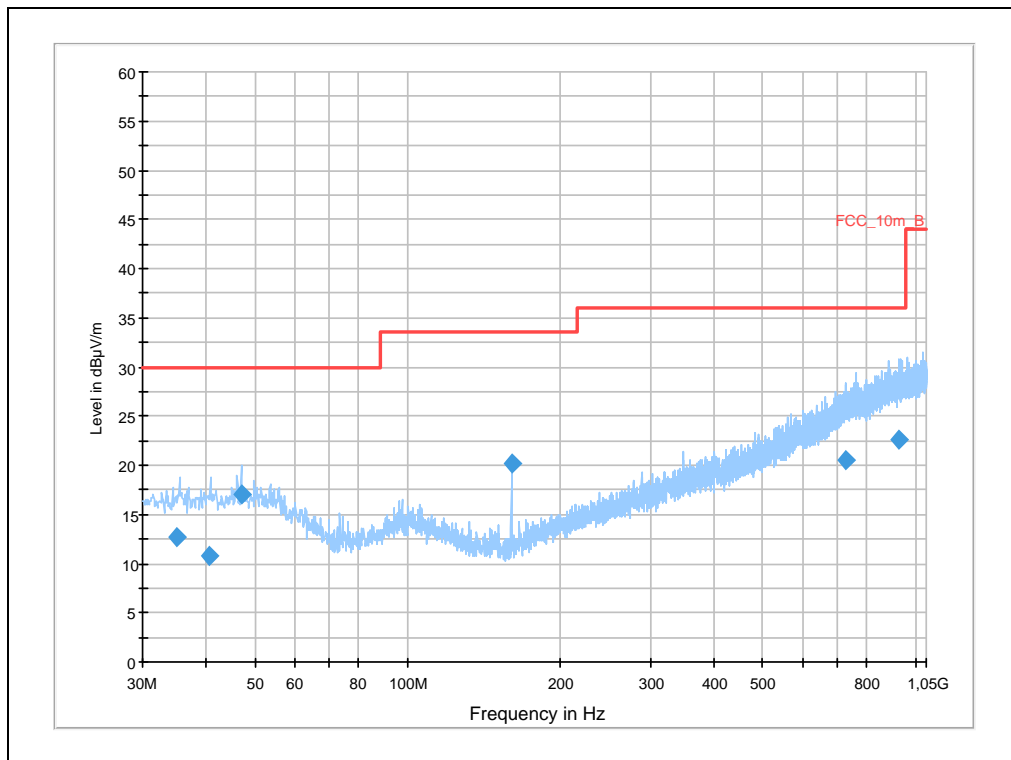

Frequency (MHz)	QuasiPeak (dBµV/m)	Bandwidth (kHz)	Height (cm)	Polarization	Azimuth (deg)	Corr. (dB)	Margin (dB)	Limit (dBµV/m)
34.991550	12.7	1000.0	120.000	177.0	V	286.0	13.0	17.3
40.576050	10.8	1000.0	120.000	308.0	H	177.0	13.4	19.2
46.994400	17.0	1000.0	120.000	100.0	V	242.0	13.3	13.0
160.010700	20.1	1000.0	120.000	100.0	V	62.0	9.2	13.4
727.910250	20.6	1000.0	120.000	400.0	H	131.0	23.2	15.4
929.300250	22.6	1000.0	120.000	200.0	H	357.0	25.3	13.4

Plot 34: 30 MHz – 1 GHz, antenna horizontal / vertical, TX-Mode, middle frequency

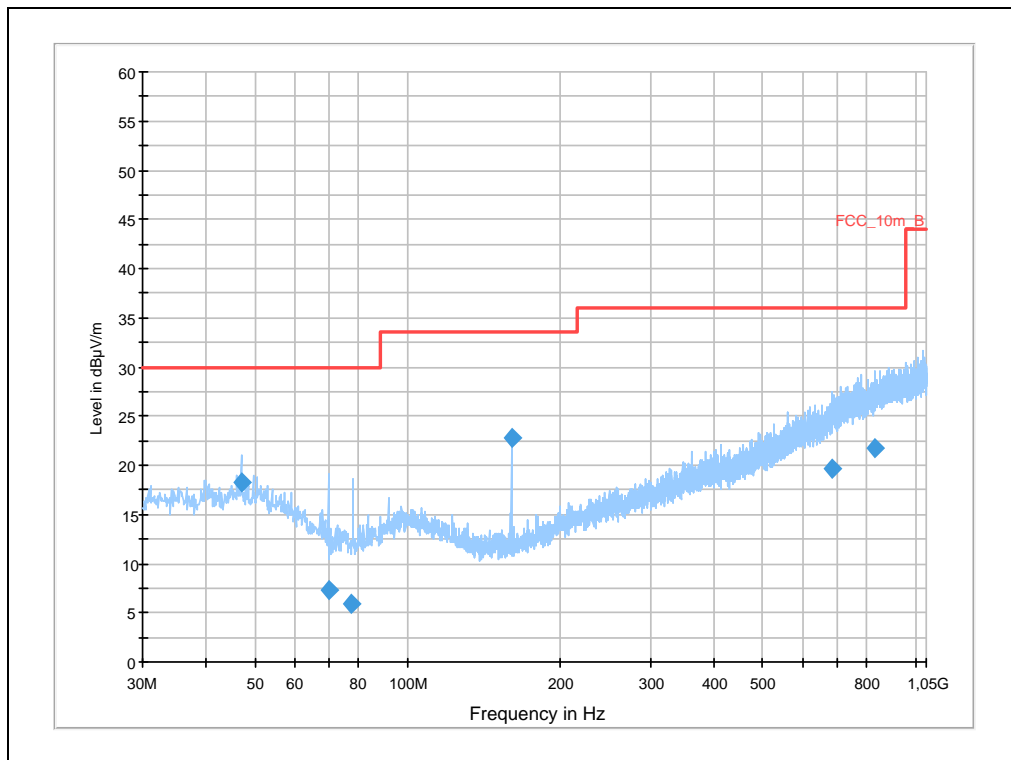

Frequency (MHz)	QuasiPeak (dBµV/m)	Bandwidth (kHz)	Height (cm)	Polarization	Azimuth (deg)	Corr. (dB)	Margin (dB)	Limit (dBµV/m)
46.999800	18.2	1000.0	120.000	106.0	V	265.0	13.3	11.8
69.990600	7.3	1000.0	120.000	368.0	V	273.0	9.3	22.7
77.509800	5.9	1000.0	120.000	400.0	V	310.0	9.1	24.1
160.009050	22.8	1000.0	120.000	105.0	V	346.0	9.2	10.7
686.932650	19.7	1000.0	120.000	200.0	H	2.0	22.1	16.3
829.482900	21.7	1000.0	120.000	178.0	H	136.0	24.2	14.3

Plot 35: 30 MHz – 1 GHz, antenna horizontal / vertical, TX-Mode, high frequency

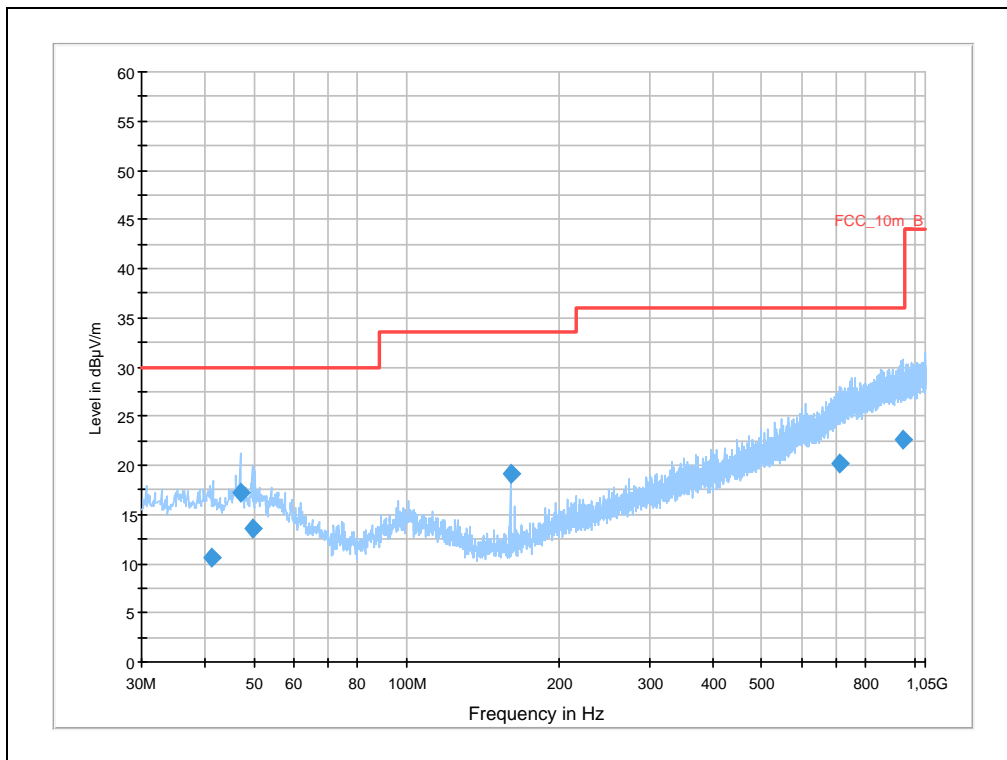

Frequency (MHz)	QuasiPeak (dBµV/m)	Bandwidth (kHz)	Height (cm)	Polarization	Azimuth (deg)	Corr. (dB)	Margin (dB)	Limit (dBµV/m)
41.124150	10.7	1000.0	120.000	200.0	V	251.0	13.4	19.3
47.020500	17.2	1000.0	120.000	100.0	V	229.0	13.3	12.8
49.508250	13.6	1000.0	120.000	200.0	V	0.0	13.4	16.4
160.006500	19.2	1000.0	120.000	122.0	V	-35.0	9.2	14.3
714.289050	20.2	1000.0	120.000	400.0	V	176.0	22.8	15.8
952.630050	22.7	1000.0	120.000	134.0	H	5.0	25.4	13.3

Plot 36: 1 GHz – 12 GHz, antenna horizontal / vertical, RX-Mode

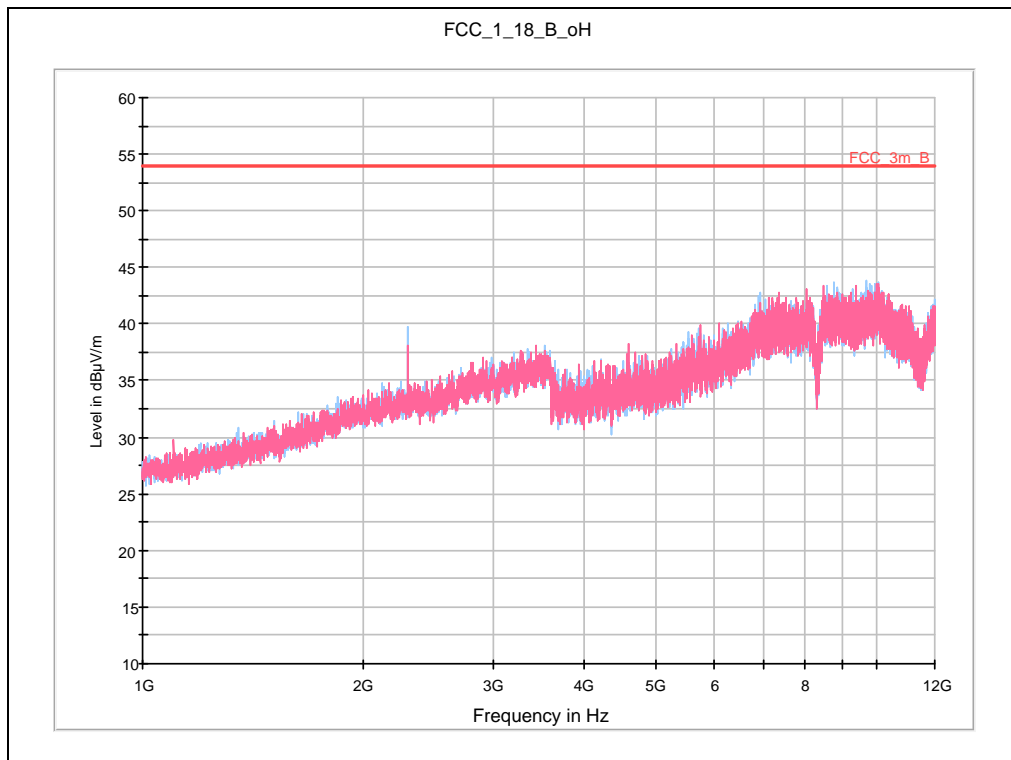

Plot 37: 1 GHz – 12 GHz, antenna horizontal / vertical, TX-Mode, low frequency

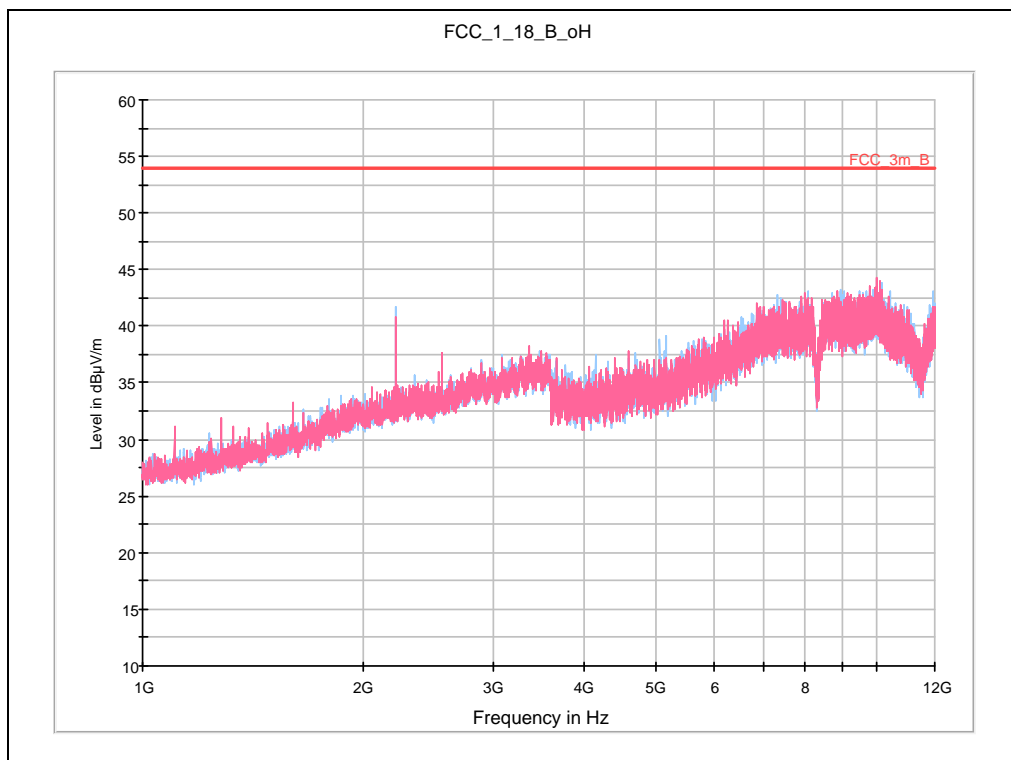

Plot 38: 1 GHz – 12 GHz, antenna horizontal / vertical, TX-Mode, middle frequency

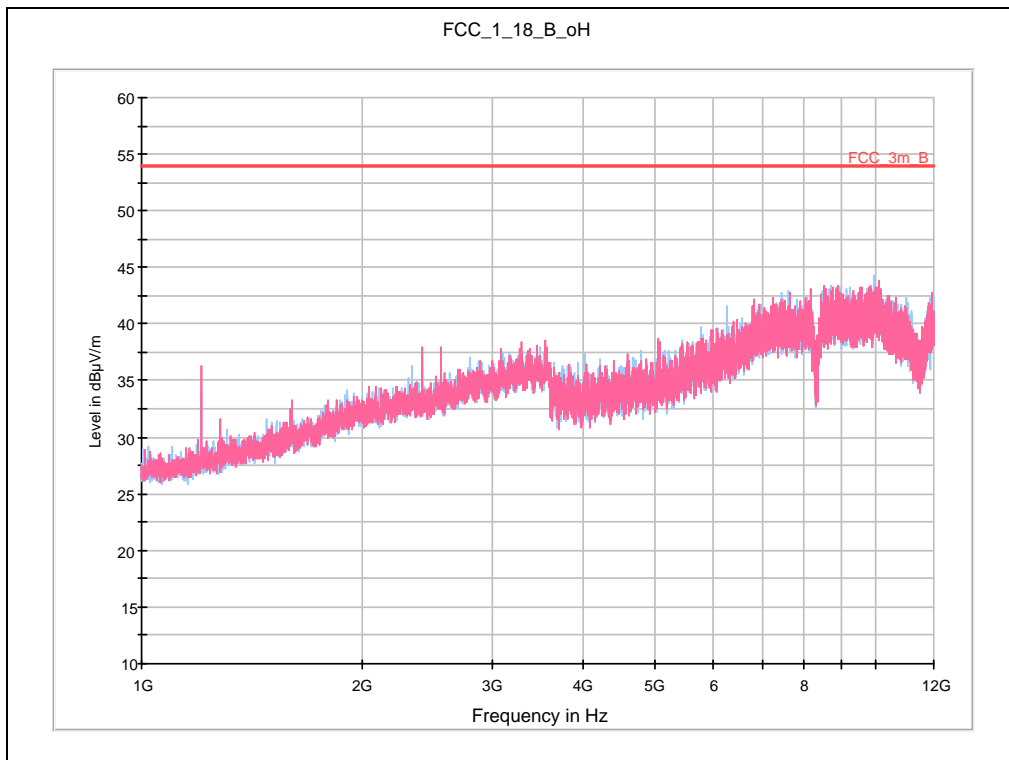

Plot 39: 1 GHz – 12 GHz, antenna horizontal / vertical, TX-Mode, high frequency

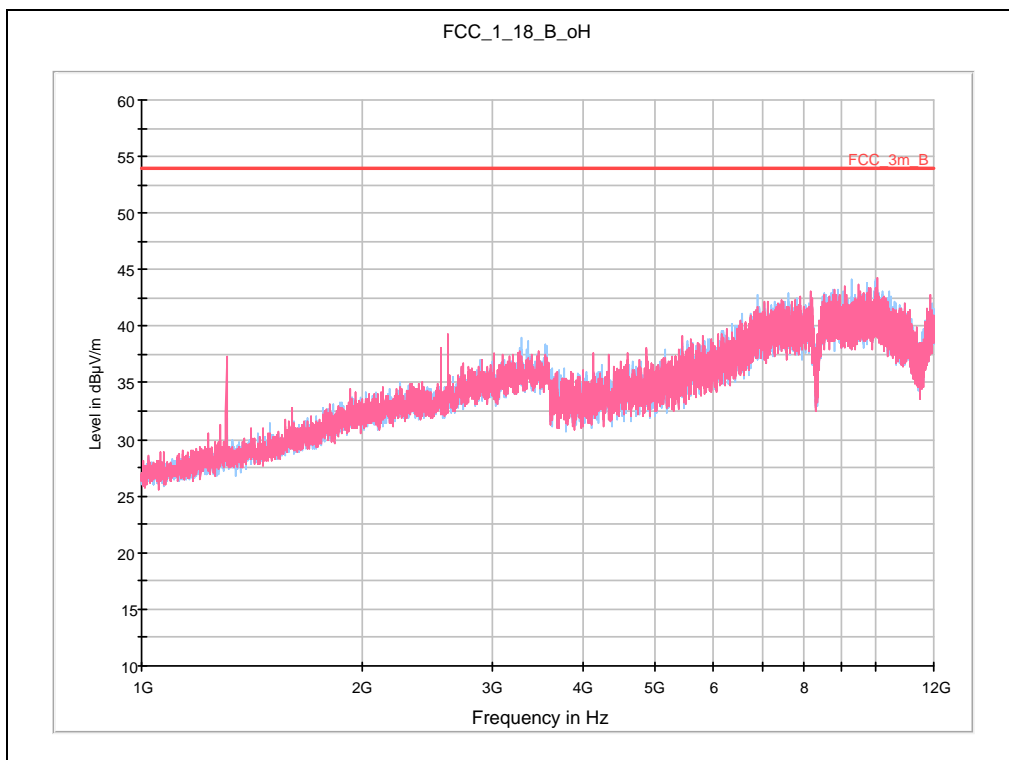

Plot 40: 12 GHz – 18 GHz, antenna horizontal / vertical, TX-Mode, low / mid / high frequency

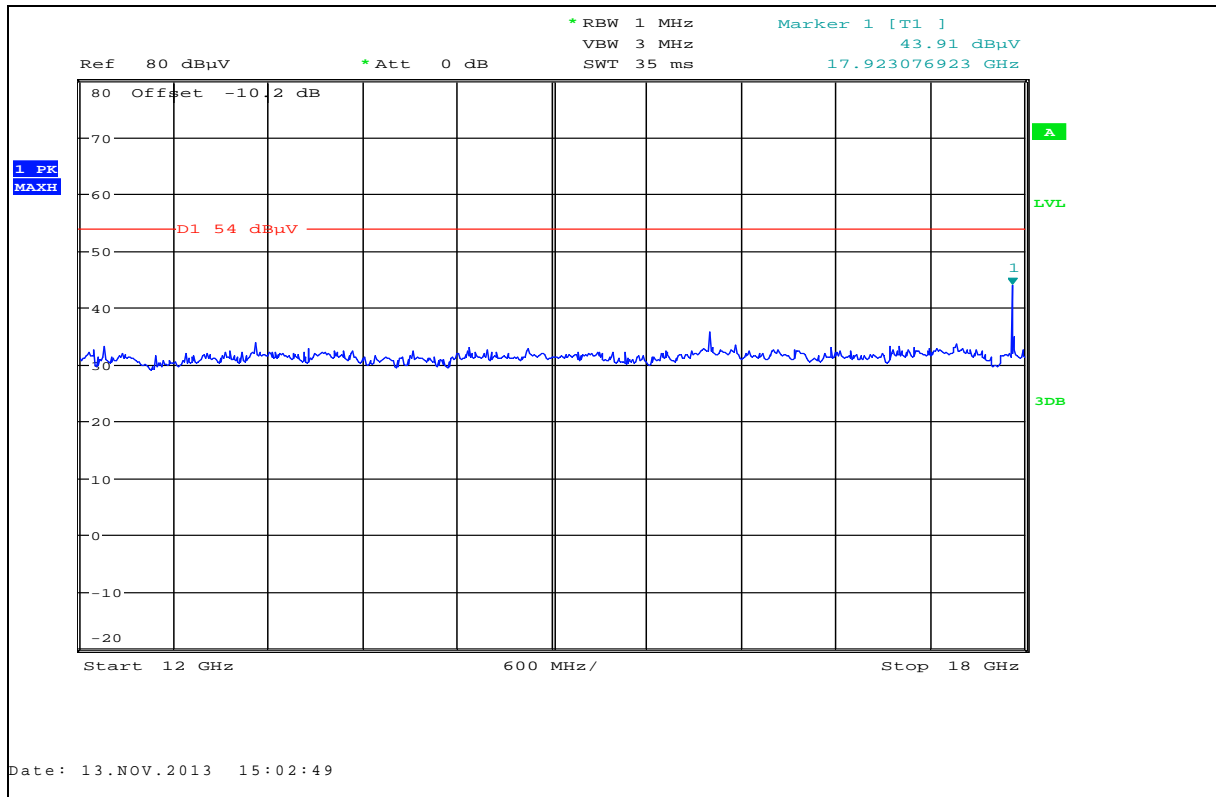

Plot 41: 18 GHz – 26 GHz, antenna horizontal / vertical, TX-Mode, low / mid / high frequency

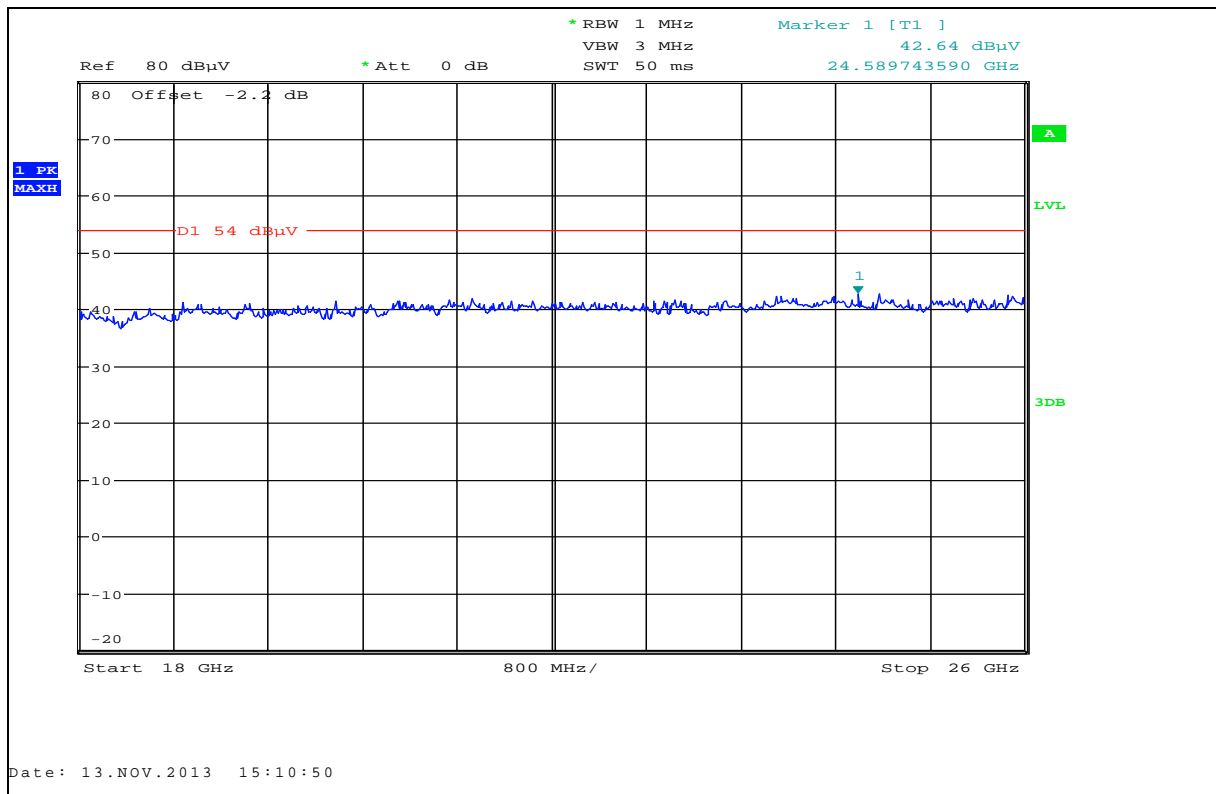

Plot 42: 26 GHz – 40 GHz, Pos-Peak, antenna horizontal / vertical, TX-Mode, low / mid / high frequency

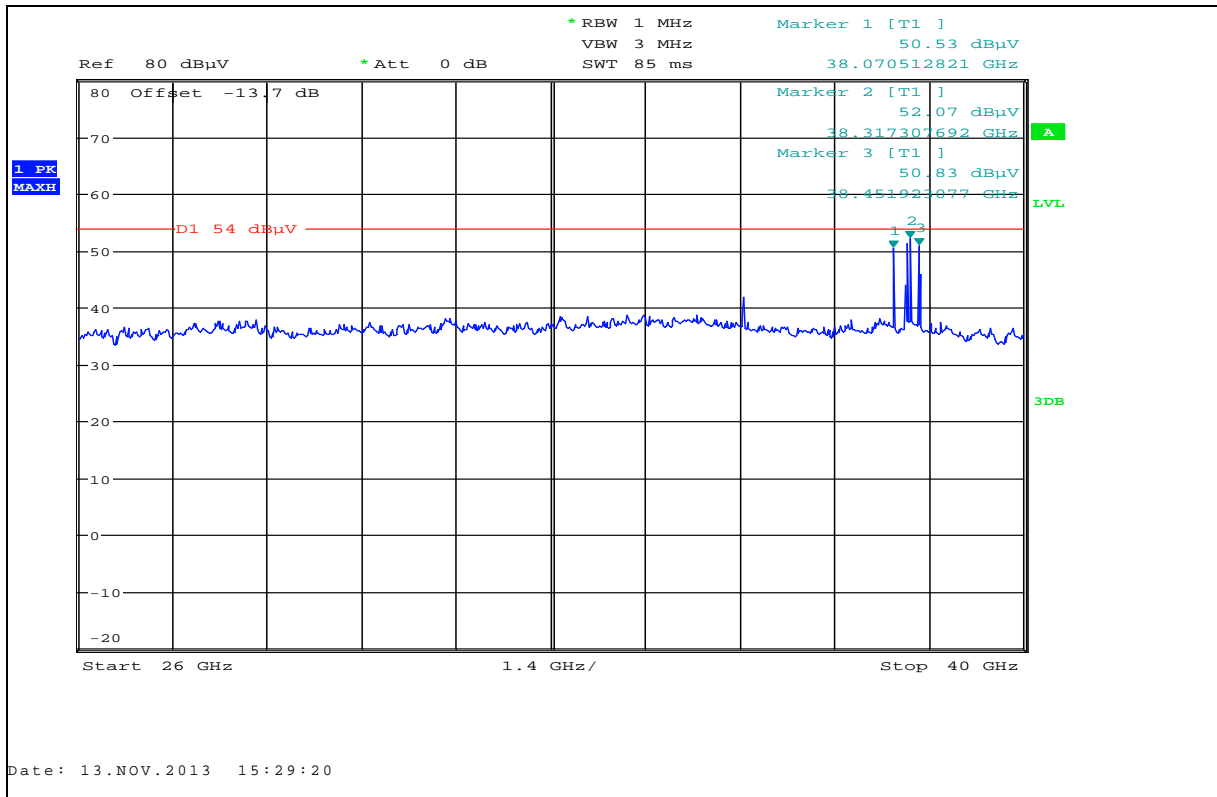

Plot 43: 38.45 GHz, RMS, antenna horizontal / vertical, TX-Mode, low / mid / high frequency (worst case)

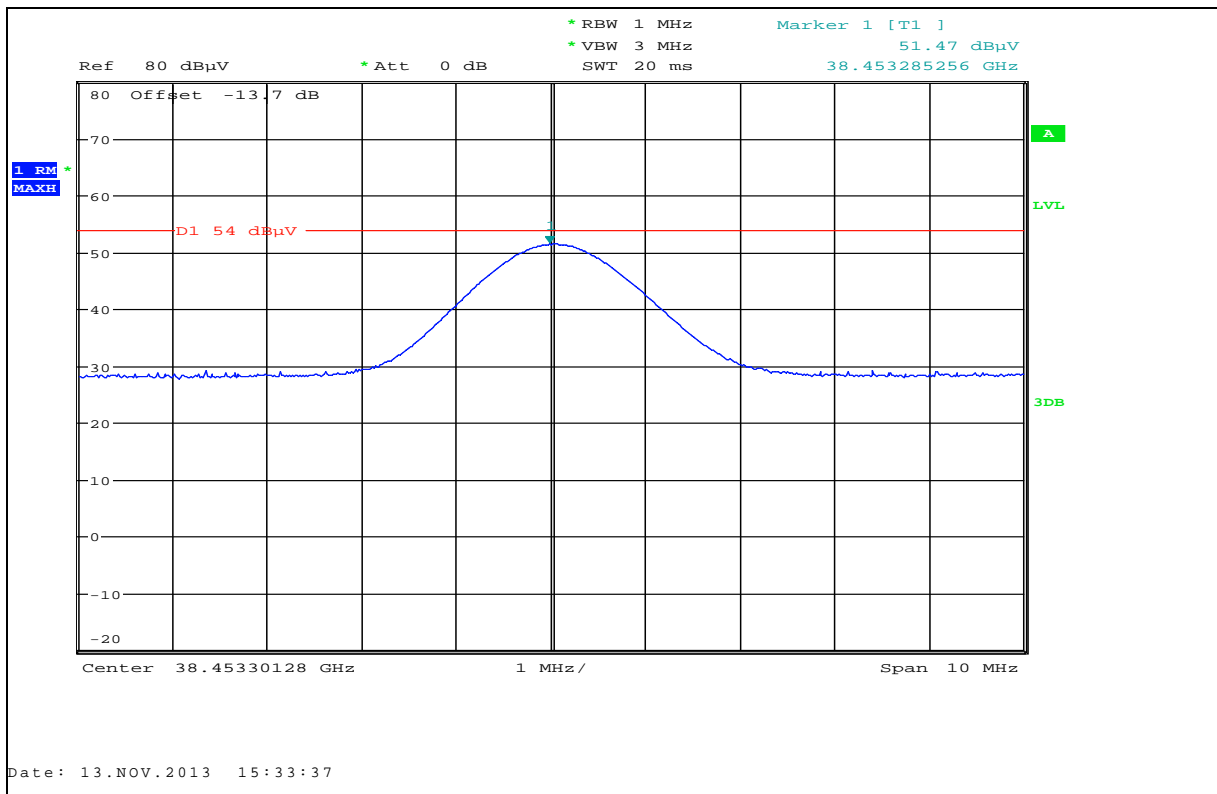

Plot 44: 40 GHz – 50 GHz, antenna horizontal / vertical, TX-Mode, low / mid / high frequency

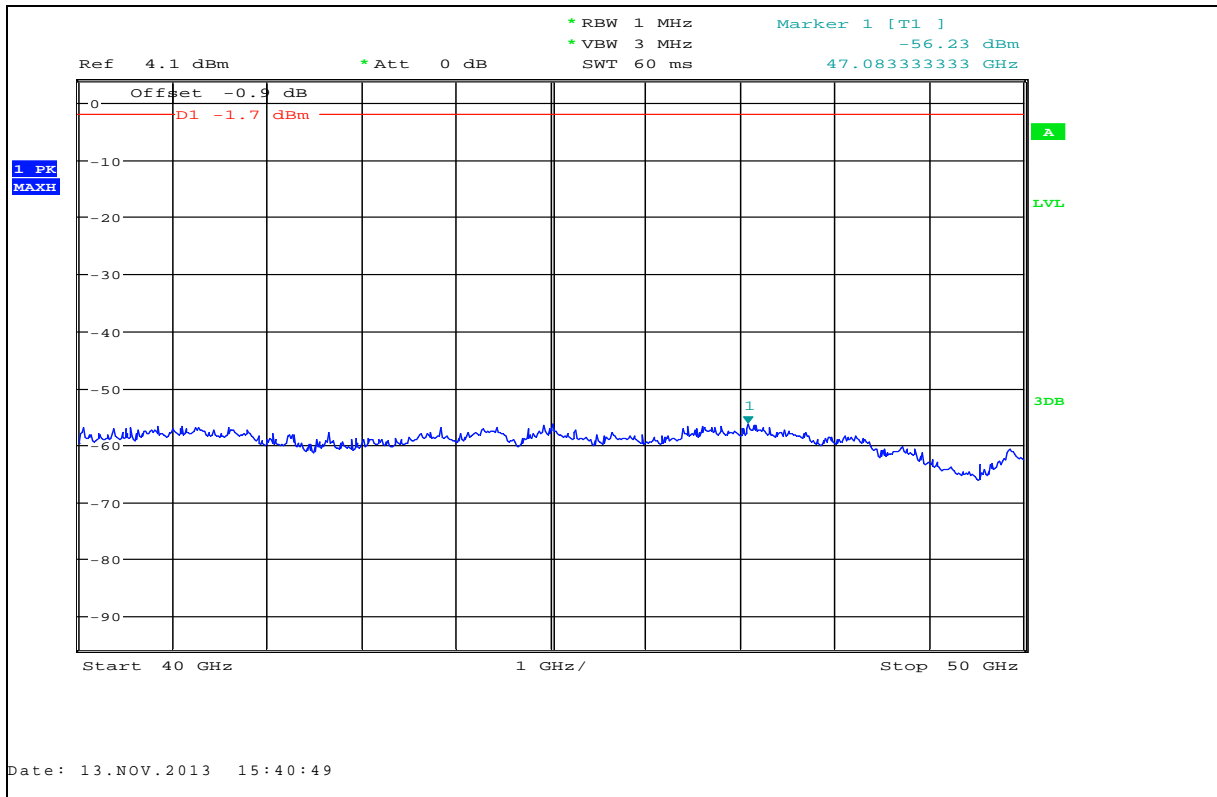

Plot 45: 50 GHz – 75 GHz, antenna horizontal / vertical, TX-Mode, low / mid / high frequency

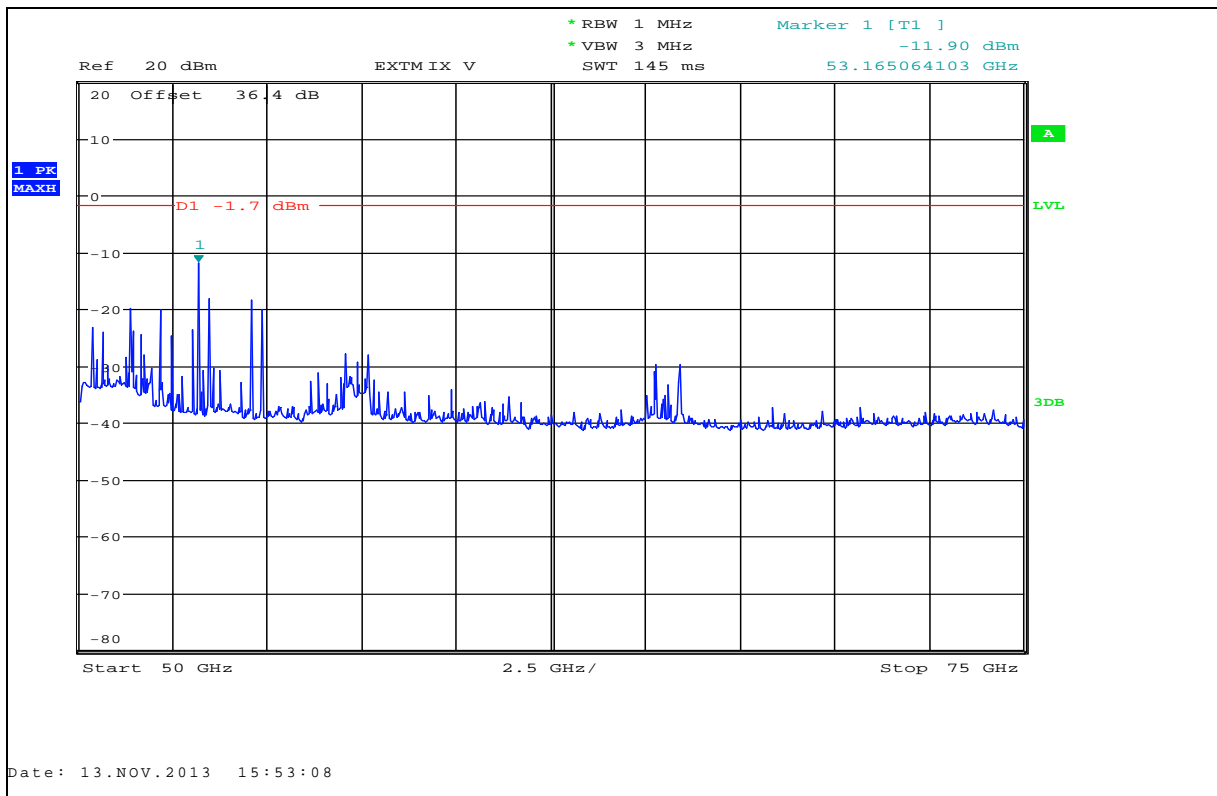

Plot 46: 75 GHz – 110 GHz, antenna horizontal / vertical, TX-Mode, low / mid / high frequency

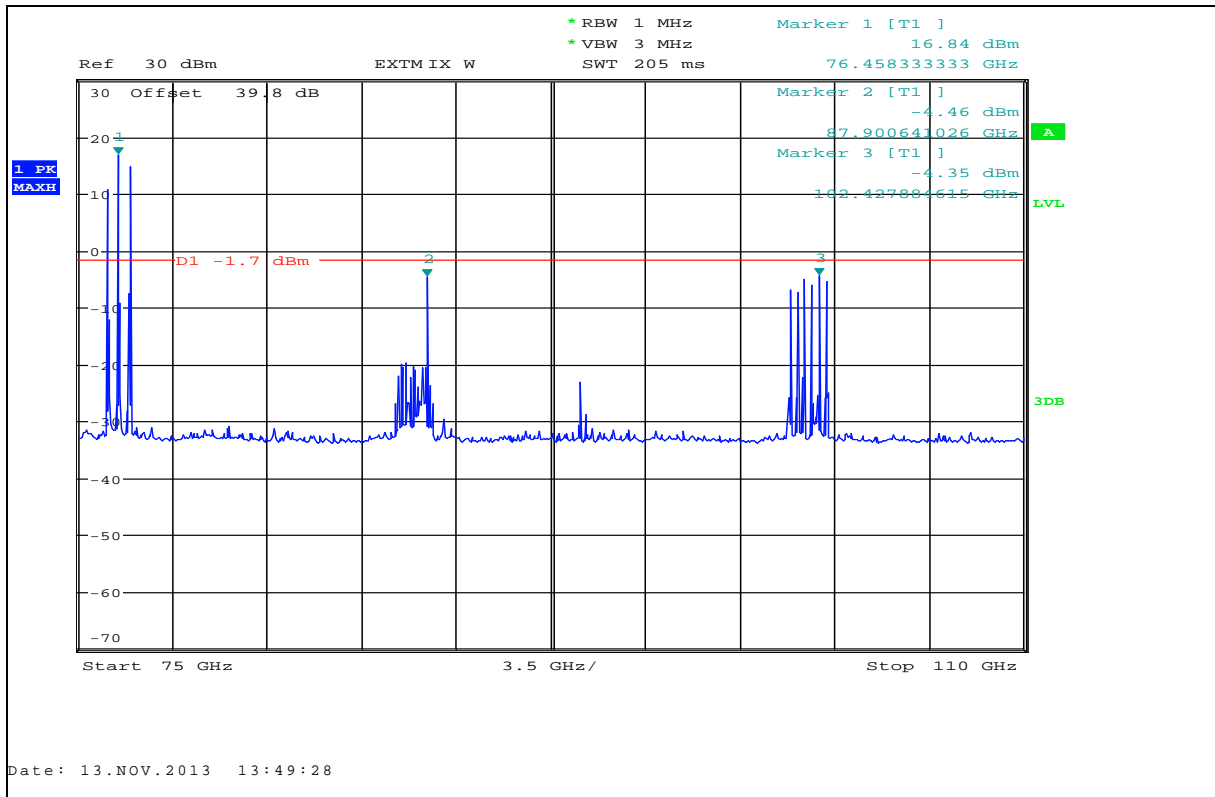

Note: Marker 1 shows the wanted signals, marker 2 and 3 show peaks produced by the harmonic mixer!

Plot 47: 110 GHz – 170 GHz, antenna horizontal / vertical, TX-Mode, low / mid / high frequency

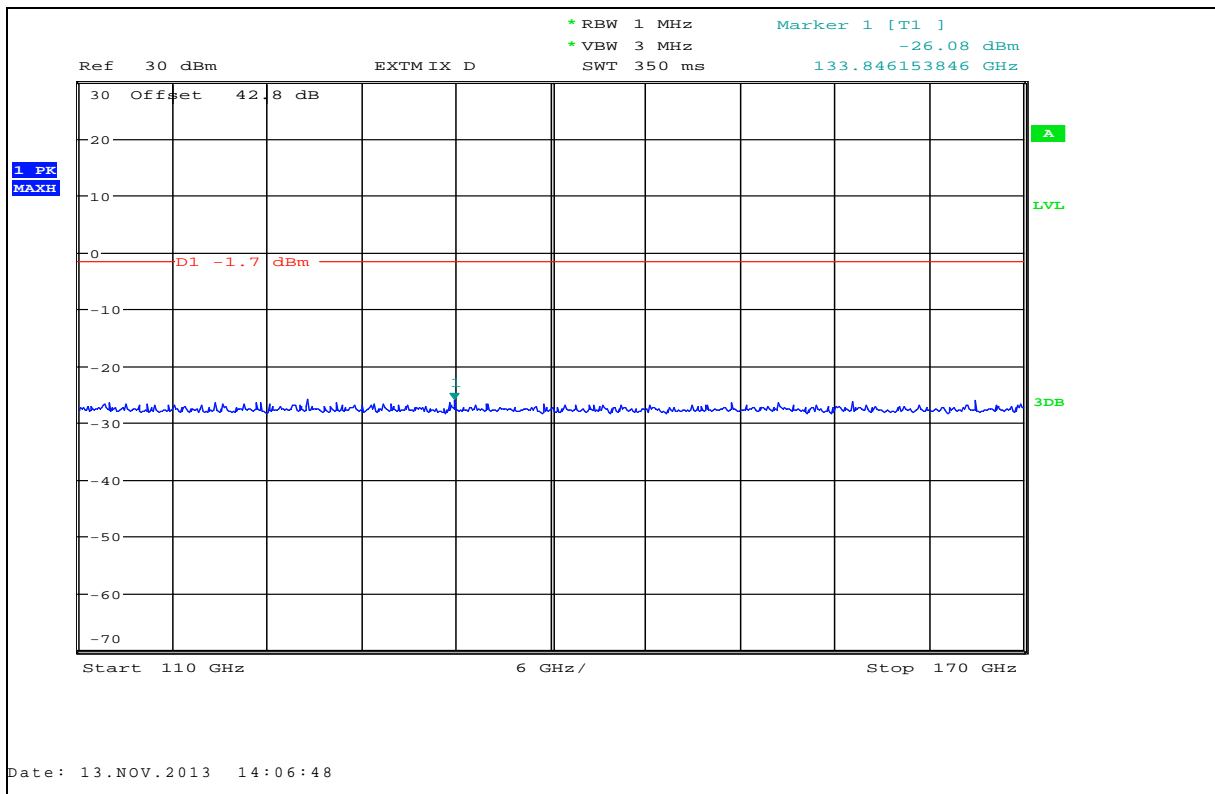

Plot 48: 170 GHz – 220 GHz, antenna horizontal / vertical, TX-Mode, low / mid / high frequency

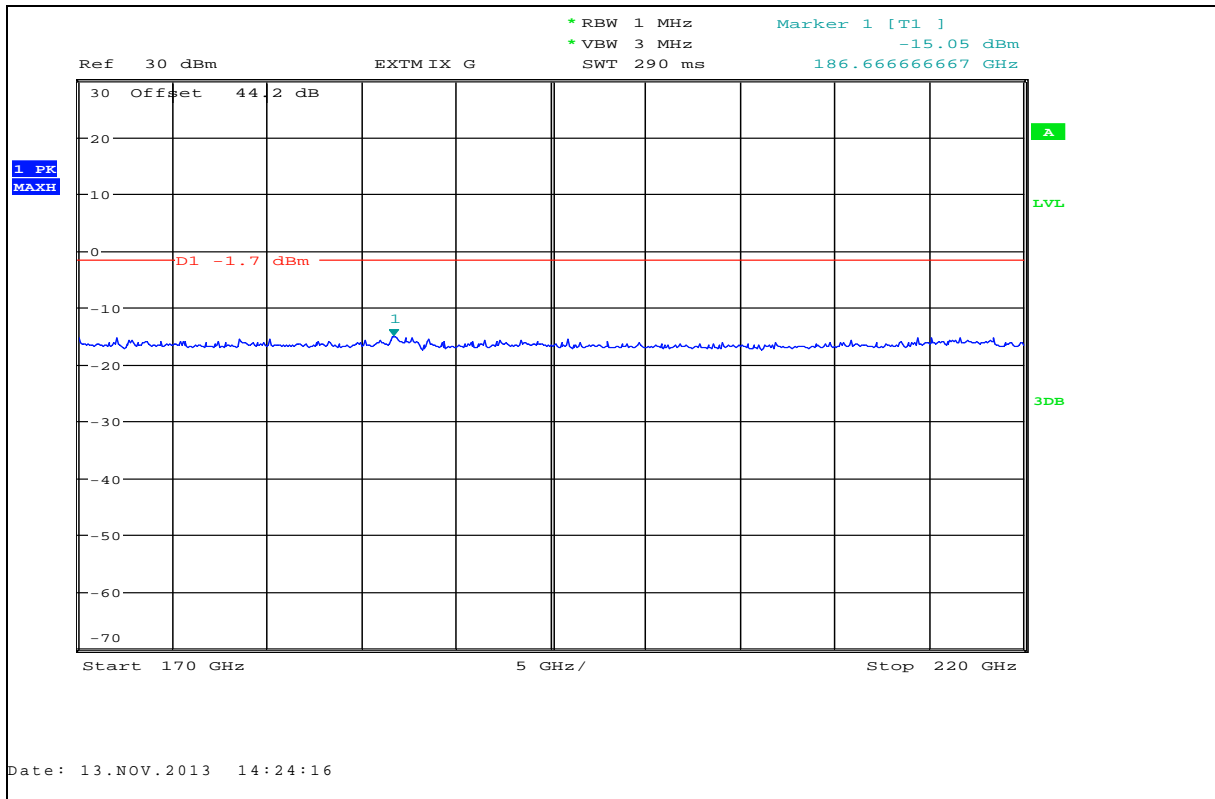

Plot 49: 220 GHz – 330 GHz, antenna horizontal / vertical, TX-Mode, low / mid / high frequency

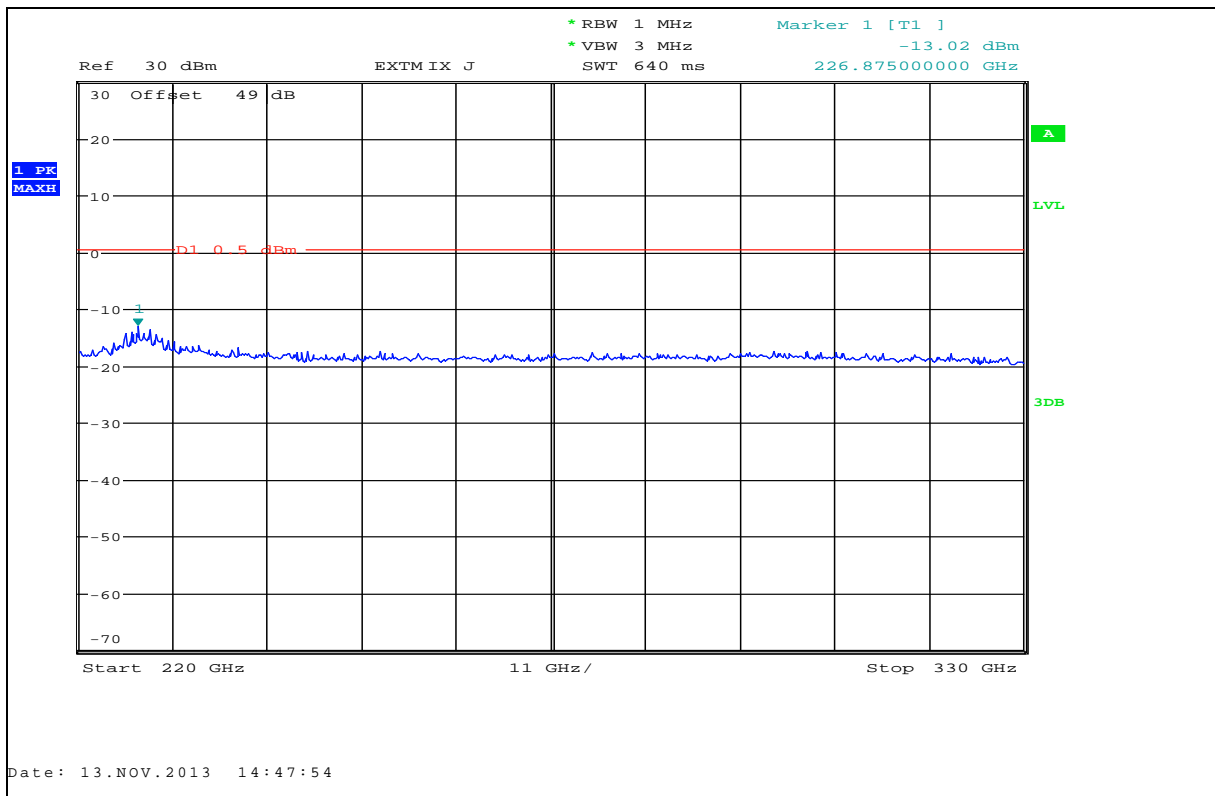

Results:

TX Spurious Emissions Radiated [dBµV/m]								
Low frequency			Mid frequency			High frequency		
F [GHz]	Detector	Level [dBµV/m]	F [GHz]	Detector	Level [dBµV/m]	F [GHz]	Detector	Level [dBµV/m]
No critical peaks found!			No critical peaks found!			35.8	RMS	51.47
Measurement uncertainty			± 3 dB					

Limits:

FCC §15.253 / 15.209 / 15.205

FCC		
CFR Part 15.253 (d) (e) / CFR Part 15.209 (a) / CFR Part 15.205		
Radiated Spurious Emissions		
Emissions radiated outside of the specified frequency bands, except for harmonics, shall be attenuated by at least 50 dB below the level of the fundamental or to the general radiated emission limits in § 15.209, whichever is the lesser attenuation.		
Frequency [MHz]	Field Strength [dBµV/m]	Measurement distance
0.009 – 0.490	2400/F[kHz]	300
0.490 – 1.705	24000/F[kHz]	30
1.705 – 30.0	30	30
30 – 88	30.0	10
88 – 216	33.5	10
216 – 960	36.0	10
960 – 40 000	54.0	3

Limits:

FCC §15.253 (e) (2) (ii) + (3)

Frequency Range [GHz]	Measurement distance	Power Density
40 – 200	3.0 m	600 pW/cm ² → -1.7 dBm
200 – 231	3.0 m	1000 pW/cm ² → +0.5 dBm

Limits:

RSS 210 Issue 8, Annex 13.1.2 (2) (a) / (b) / (c)

Frequency Range [GHz]	Measurement distance	Power Density
40 – 200	3.0 m	600 pW/cm ² → -1.7 dBm
200 – 231	3.0 m	1000 pW/cm ² → +0.5 dBm

Result: The measurement is passed.

9.6 Frequency stability

- Low frequency

TEST CONDITIONS	Carrier Frequency
($T_{nom} / V_{min-max}$)	76.105240
($T_{min} / V_{min-max}$)	76.106009
($T_{max} / V_{min-max}$)	76.106506

- Middle frequency

TEST CONDITIONS	Carrier Frequency
($T_{nom} / V_{min-max}$)	76.505417
($T_{min} / V_{min-max}$)	76.505978
($T_{max} / V_{min-max}$)	76.506138

- High frequency

TEST CONDITIONS	Carrier Frequency
($T_{nom} / V_{min-max}$)	76.905401
($T_{min} / V_{min-max}$)	76.905946
($T_{max} / V_{min-max}$)	76.906730

Limits:

FCC §15.253 (f)

Frequency range	f(lowest) > 76.0 GHz	f(highest) < 77.0 GHz
-----------------	----------------------	-----------------------

Limits:

RSS 210 Issue 8, Annex 13.1.5

Frequency range	f(lowest) > 76.0 GHz	f(highest) < 77.0 GHz
-----------------	----------------------	-----------------------

Result: The measurement is passed.

9.7 Conducted spurious emissions < 30 MHz

Description:

Measurement of the conducted spurious emissions in transmit mode below 30 MHz. Both power lines, phase and neutral line, are measured. Found peaks are re-measured with average and quasi peak detection to show compliance to the limits.

Measurement:

Measurement parameter	
Detector:	Peak - Quasi Peak / Average
Sweep time:	Auto
Video bandwidth:	F < 150 kHz: 200 Hz F > 150 kHz: 9 kHz
Resolution bandwidth:	F < 150 kHz: 1 kHz F > 150 kHz: 100 kHz
Span:	9 kHz to 30 MHz
Trace-Mode:	Max Hold

Limits:

FCC		IC	
CFR Part 15.207(a)		ICES-003, Issue 4	
Conducted Spurious Emissions < 30 MHz			
Frequency (MHz)	Quasi-Peak (dB μ V/m)	Average (dB μ V/m)	
0.15 – 0.5	66 to 56*	56 to 46*	
0.5 – 5	56	46	
5 – 30.0	60	50	

*Decreases with the logarithm of the frequency

Result: The measurement is passed.

Plot 50: TX-Mode (valid for all frequencies)

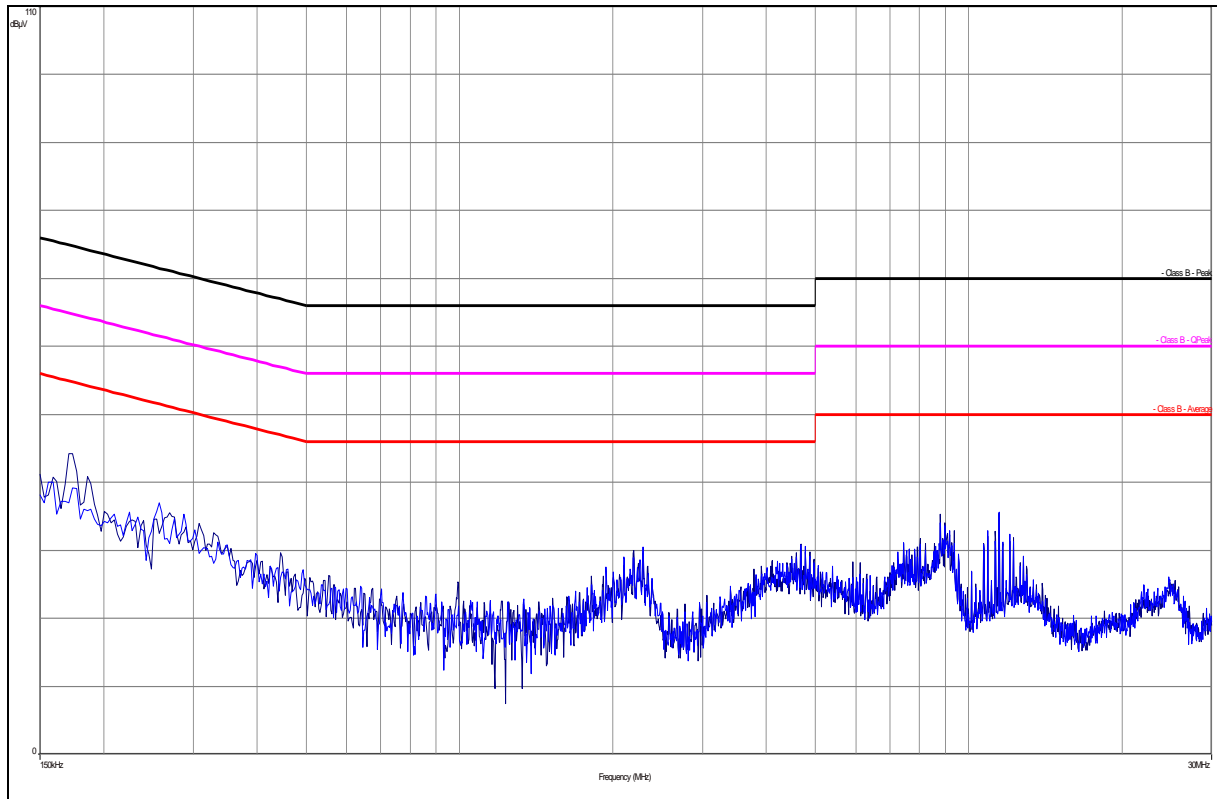

Plot 51: RX-Mode

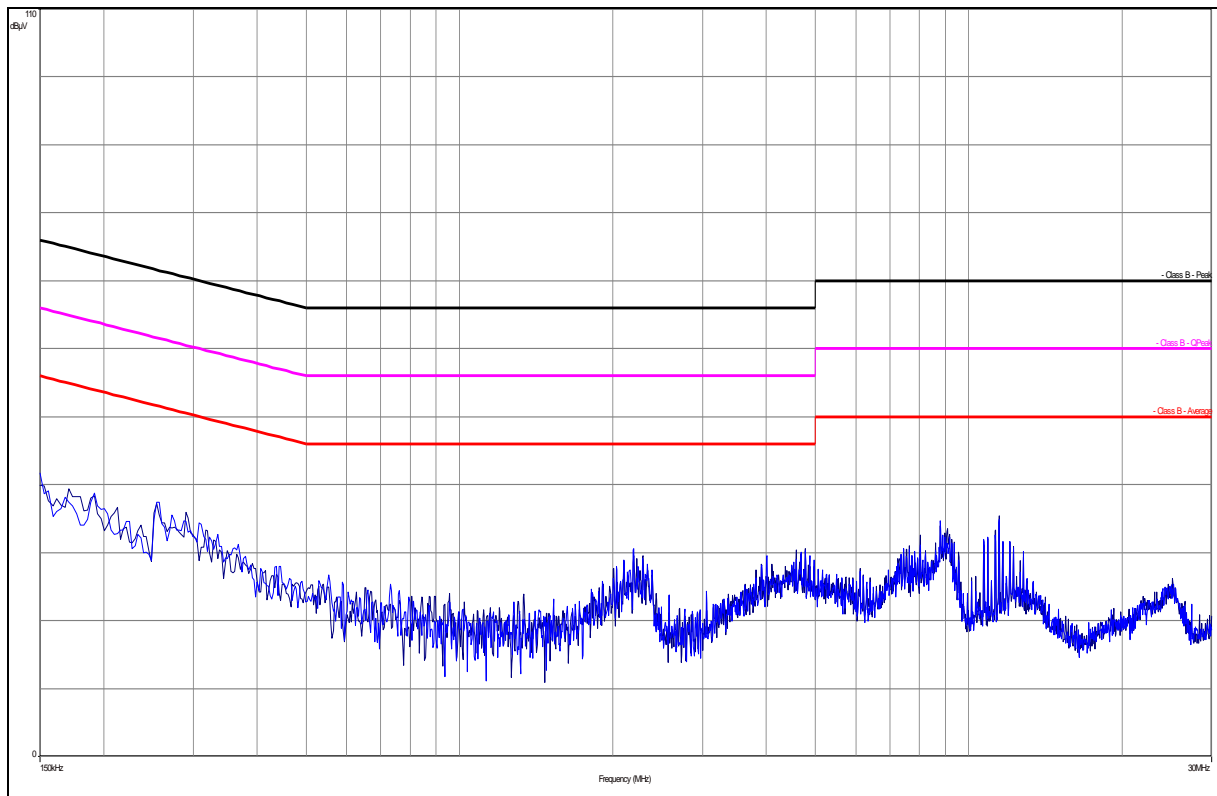

10 Test equipment and ancillaries used for tests

Typically, the calibrations of the test apparatus are commissioned to and performed by an accredited calibration laboratory. The calibration intervals are determined in accordance with the DIN EN ISO/IEC 17025. In addition to the external calibrations, the laboratory executes comparison measurements with other calibrated test systems or effective verifications. Weekly chamber inspections and range calibrations are performed. Where possible, rf-generating and signalling equipment as well as measuring receivers and analyzers are connected to an external high-precision 10 MHz reference (GPS-based or rubidium frequency standard).

In order to simplify the identification of the equipment used at some special tests, some items of test equipment and ancillaries can be provided with an identifier or number in the equipment list below (Labor/Item).

No.	Lab / Item	Equipment	Type	Manufact.	Serial No.	INV. No Cetecom	Kind of Calibration	Last Calibration	Next Calibration
1	CR 79	Std. Gain Horn Antenna 26.5-40.0 GHz	V637	Narda	7911	300001751	ne		
2	11b	Microwave System Amplifier, 0.5-26.5 GHz	83017A	HP Meßtechnik	00419	300002268	ev		
3	A022	Std. Gain Horn Antenna 26.4-40.1 GHz	2224-20	Flann	235	300001976	ne		
4	A023	Std. Gain Horn Antenna 39.3-59.7 GHz	2424-20	Flann	75	300001979	ne		
5	A025	Std. Gain Horn Antenna 49.9-75.8 GHz	2524-20	Flann	*	300001983	ne		
6	A028	Std. Gain Horn Antenna 73.8-112 GHz	2724-20	Flann	*	300001991	ne		
7	A032	Std. Gain Horn Antenna 114-173 GHz	2924-20	Flann	*	300001999	ne		
8	A033	Std. Gain Horn Antenna 145-220 GHz	3024-20	Flann	*	300002000	ne		
9	A035	Std. Gain Horn Antenna 220-330 GHz	3224-20	Flann	*	300002002	ne		
10	A026	Std. Gain Horn Antenna 12.4 to 18.0 GHz	639	Narda		300000787	ne		
11	A029	Std. Gain Horn Antenna 18.0 to 26.5 GHz	638	Narda		300002442	ne		
12	n. a.	Power Supply	LA30/5GA	Zentro Elektronik	2046	300000711	NK!		
13	n. a.	Spectrum Analyzer 20 Hz - 50 GHz	FSU50	R&S	200012	300003443	ve	30.08.2012	30.08.2014
14	n. a.	Spectrum Analyzer Mixer 2-Port	SAM-110-7	Radiometer Physics GmbH	002	300004155	k		
15	n. a.	Spectrum Analyzer Mixer 3-Port	SAM-170	Radiometer Physics GmbH	100014	300004156	k		
16	n. a.	Spectrum Analyzer Mixer 3-Port	SAM-220	Radiometer Physics GmbH	200001	300004157	k		
17	n. a.	Spectrum Analyzer Mixer 3-Port ohne Isolator	SAM-325	Radiometer Physics GmbH	100002	300004158	k		
18	n. a.	Broadband Low Noise Amplifier 18-50 GHz	CBL19503 070-XX	CERNEX	19338	300004273	ne		
19	n. a.	DC power supply, 60Vdc, 50A, 1200 W	6032A	HP Meßtechnik	2818A03450	300001040	Ve	12.01.2012	12.01.2015
20	n. a.	Double-Ridged Waveguide Horn Antenna 1-18.0GHz	3115	EMCO	8812-3088	300001032	vIKI!	08.05.2013	08.05.2015
21	n. a.	Active Loop Antenna	6502	EMCO	2210	300001015	ne		
22	n. a.	Anechoic chamber	FAC 3/5m	MWB / TDK	87400/02	300000996	ev		
23	Spec.A. 2_2e	System rack for EMI measurement solution	85900	HP I.V.	*	300000222	ne		
24	9	Artificial Mains 9 kHz to 30 MHz	ESH3-Z5	R&S	828576/020	300001210	Ve	06.01.2012	06.01.2014
25	n. a.	Relais Matrix	3488A	HP Meßtechnik	2719A15013	300001156	ne		
26	n. a.	Relais Matrix	PSU	R&S	890167/024	300001168	ne		
27	n. a.	Isolating Transformer	RT5A	Grundig	9242	300001263	ne		
28	n. a.	Three-Way Power Splitter, 50 Ohm	11850C	HP Meßtechnik		300000997	ne		
29	n. a.	Switch / Control Unit	3488A	HP	2605e08770	300001443	ne		
30	n. a.	Amplifier	js42-00502650-28-5a	Parzich GMBH	928979	300003143	ne		

31	n. a.	Band Reject filter	WRCG185 5/1910- 1835/1925- 40/8SS	Wainwright	7	300003350	ev		
32	n. a.	Band Reject filter	WRCG240 0/2483- 2375/2505- 50/10SS	Wainwright	11	300003351	ev		
33	n. a.	Highpass Filter	WHKX2.9/1 8G-12SS	Wainwright	1	300003492	ev		
34	n. a.	Highpass Filter	WHK1.1/15 G-10SS	Wainwright	3	300003255	ev		
35	n. a.	Highpass Filter	WHKX7.0/1 8G-8SS	Wainwright	18	300003789	ne		
36	n. a.	TRILOG Broadband Test-Antenna 30 MHz - 3 GHz	VULB9163	Schwarzbeck	371	300003854	vlk!	14.10.2011	14.10.2014
37	n. a.	MXE EMI Receiver 20 Hz bis 26,5 GHz	N9038A	Agilent Technologies	MY51210197	300004405	k	21.02.2013	21.02.2014
38	45	Switch-Unit	3488A	HP Meßtechnik	2719A14505	300000368	g		
39	50	DC power supply, 60Vdc, 50A, 1200 W	6032A	HP Meßtechnik	2920A04466	300000580	ne		
40	n. a.	software	SPS_PHE 1.4f	Spitzberger & Spieß	B5981; 5D1081;B597 9	300000210	ne		
41	n. a.	EMI Test Receiver	ESCI 1166.5950. 03	R&S	100083	300003312	k	09.01.2013	09.01.2014
42	n. a.	Analyzer-Reference-System (Harmonics and Flicker)	ARS 16/1	SPS	A3509 07/0 0205	300003314	k		
43	n. a.	Amplifier	JS42- 00502650- 28-5A	MITEQ	1084532	300003379	ev		
44	n. a.	Antenna Tower	Model 2175	ETS- LINDGREN	64762	300003745	izw		
45	n. a.	Positioning Controller	Model 2090	ETS- LINDGREN	64672	300003746	izw		
46	n. a.	Turntable Interface-Box	Model 105637	ETS- LINDGREN	44583	300003747	izw		
47	n. a.	TRILOG Broadband Test-Antenna 30 MHz - 3 GHz	VULB9163	Schwarzbeck	295	300003787	k		
48	n. a.	Spectrum-Analyzer	FSU26	R&S	200809	300003874	k	06.01.2012	06.01.2014

Agenda: Kind of Calibration

k	calibration / calibrated		EK	limited calibration
ne	not required (k, ev, izw, zw not required)		zw	cyclical maintenance (external cyclical maintenance)
ev	periodic self verification		izw	internal cyclical maintenance
Ve	long-term stability recognized		g	blocked for accredited testing
vlk!	Attention: extended calibration interval			
NK!	Attention: not calibrated		*)	next calibration ordered / currently in progress

11 Observations

No observations exceeding those reported with the single test cases have been made.

Annex A Photographs of the test setup

Photo No. 1:



Photo No. 2:

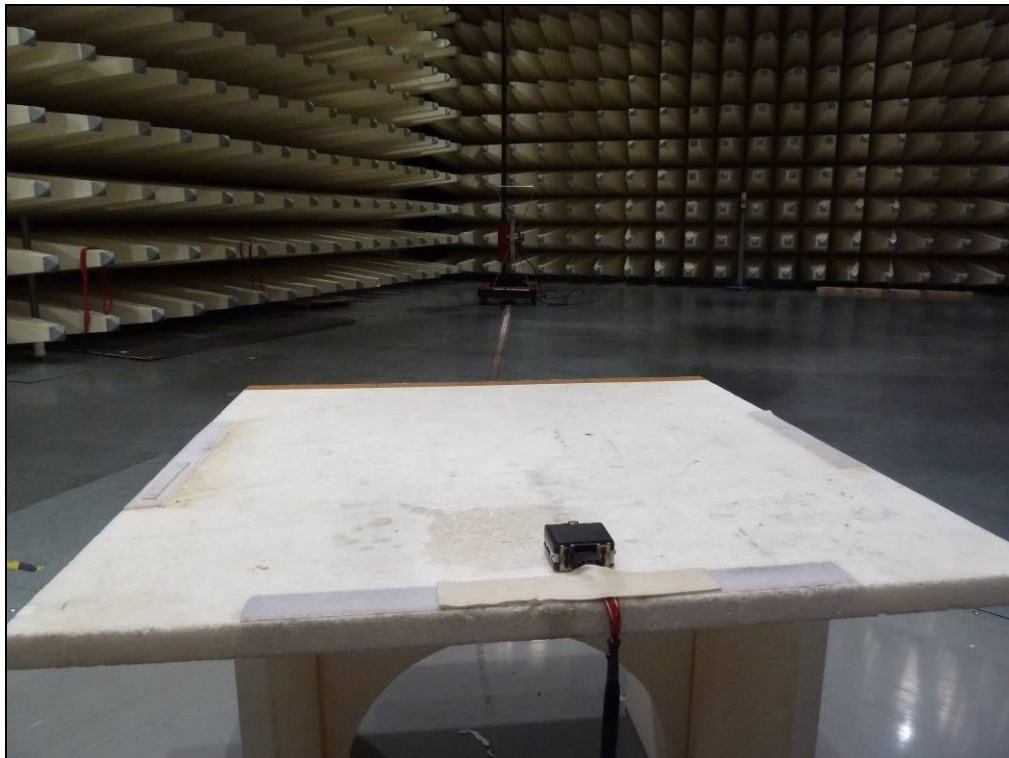

Photo No. 3:



Annex B External photographs of the EUT

Photo No. 4:



Photo No. 5:

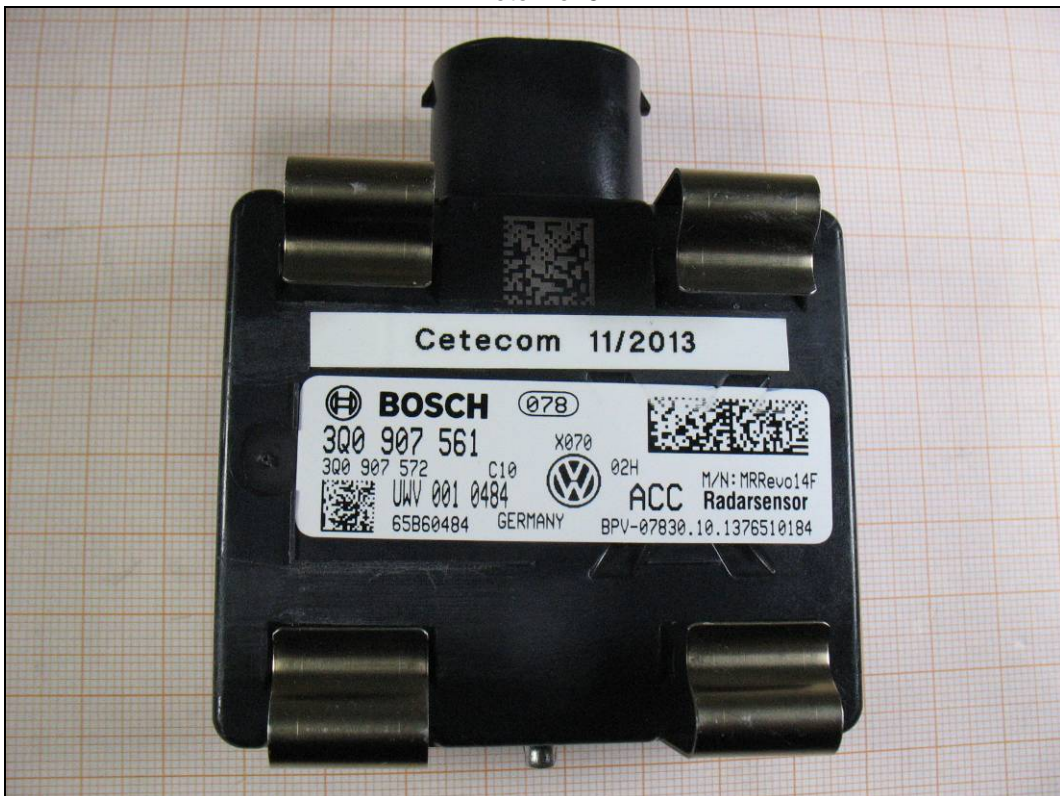

Annex C Internal photographs of the EUT

Photo No. 6:



Photo No. 7:



Photo No. 8:

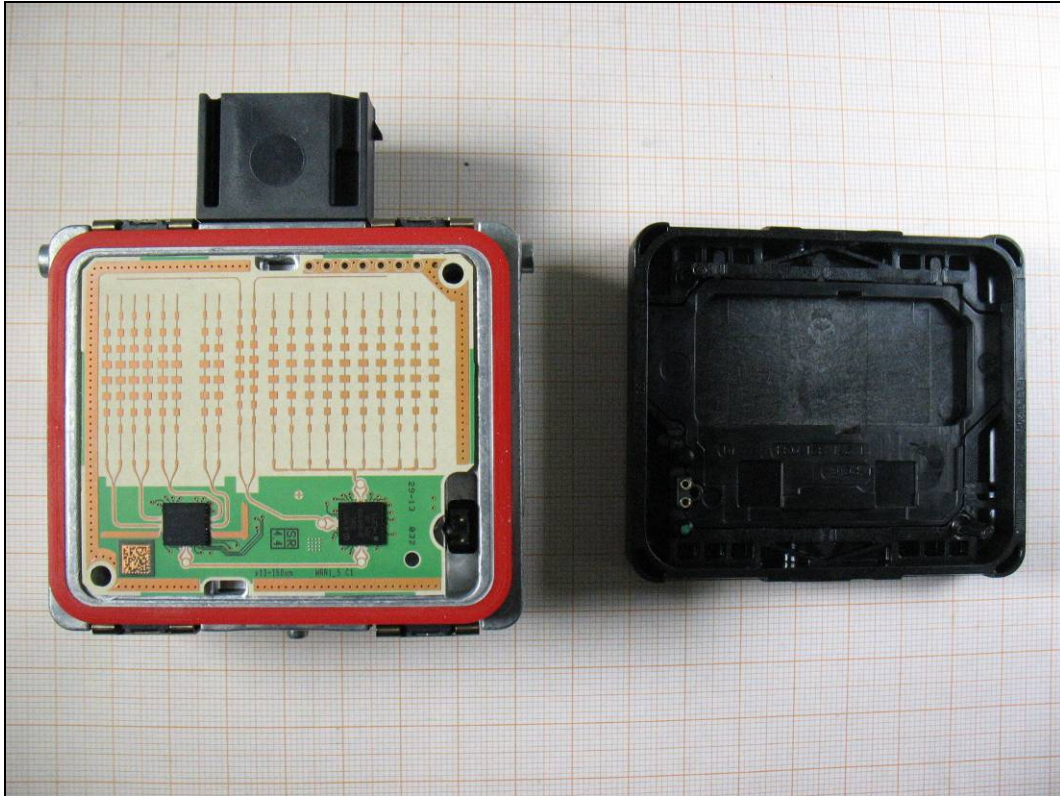

Photo No. 9:

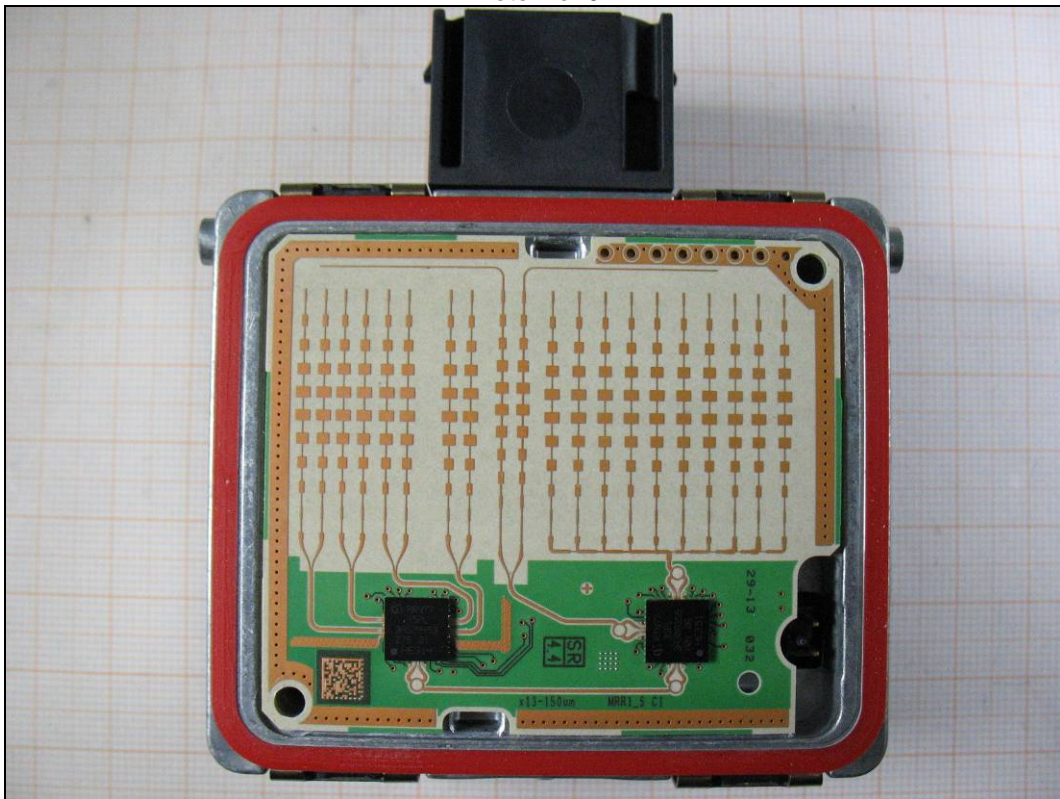

Photo No. 10:

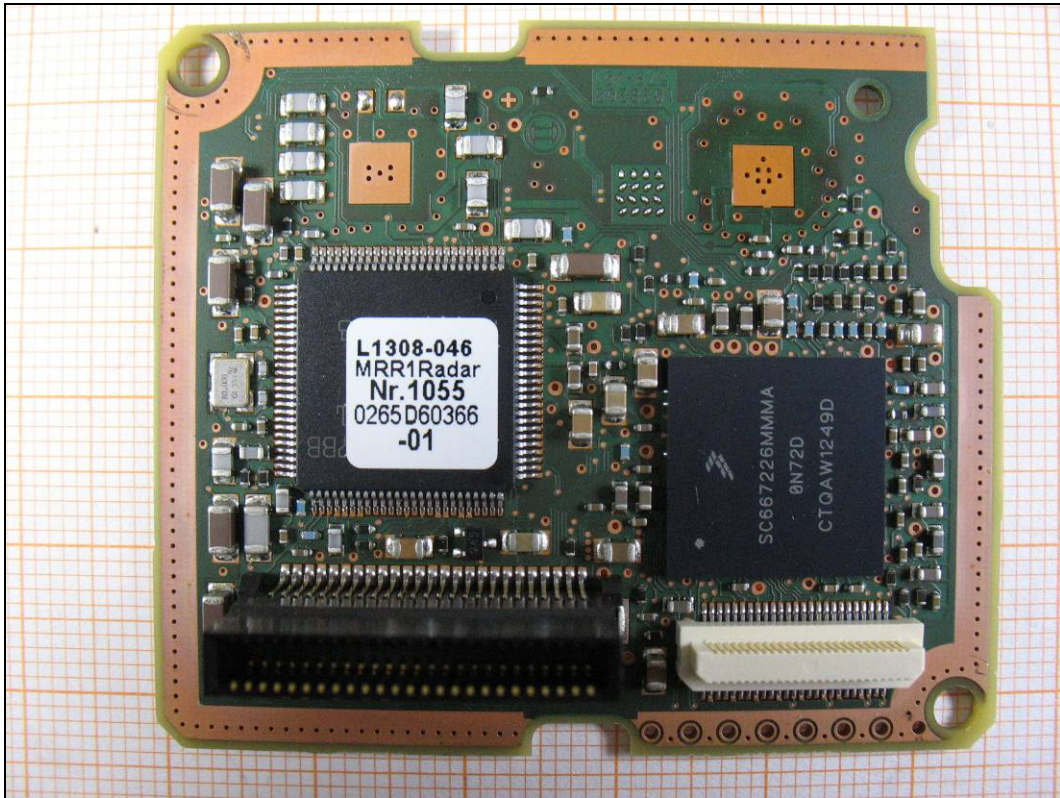

Photo No. 11:



Annex D Document history

Version	Applied changes	Date of release
1.0	Initial release	2013-12-09
-A	Not in motion included	2014-02-17

Annex E Further information**Glossary**

DUT	- Device under Test
EMC	- Electromagnetic Compatibility
EUT	- Equipment under Test
FCC	- Federal Communication Commission
FCC ID	- Company Identifier at FCC
HW	- Hardware
IC	- Industry Canada
Inv. No.	- Inventory number
N/A	- not applicable
S/N	- Serial Number
SW	- Software

Annex F Accreditation Certificate

Front side of certificate

Deutsche Akkreditierungsstelle GmbH

Bellehene gemäß § 8 Absatz 1 AkkStelleG i.V.m. § 1 Absatz 1 AkkStelleGBV
Unterzeichnerin der Multilateralen Abkommen
von EA, ILAC und IAF zur gegenseitigen Anerkennung

Akkreditierung

Die Deutsche Akkreditierungsstelle GmbH bestätigt hiermit, dass das Prüflaboratorium

CETECOM ICT Services GmbH
Untertürkheimer Straße 6-10, 66117 Saarbrücken

die Kompetenz nach DIN EN ISO/IEC 17025:2005 besitzt, Prüfungen in folgenden Bereichen durchzuführen:

- Drahtgebundene Kommunikation einschließlich xDSL
- VoIP und DECT
- Akustik
- Funk einschließlich WLAN
- Short Range Devices (SRD)
- RFID
- WiMax und Richtfunk
- Mobilfunk (GSM / DCS, Over the Air (OTA) Performance)
- Elektromagnetische Verträglichkeit (EMV) einschließlich Automotive
- Produktsicherheit
- SAR und Hearing Aid Compatibility (HAC)
- Umweltsimulation
- Smart Card Terminals
- Bluetooth
- Wi-Fi- Services

Die Akkreditierungsurkunde gilt nur in Verbindung mit dem Bescheid vom 18.01.2013 mit der Akkreditierungsnummer D-PL-12076-01 und ist gültig 17.01.2018. Sie besteht aus diesem Deckblatt, der Rückseite des Deckblatts und der folgenden Anlage mit insgesamt 80 Seiten.

Registrierungsnummer der Urkunde: D-PL-12076-01-01

Frankfurt am Main, 18.01.2013

Im Auftrag
Dirk König, PHS, Leiter
Abteilung 1001

[Signature]

Seite 11 von 16 auf der Rückseite

Back side of certificate

Deutsche Akkreditierungsstelle GmbH

Standort Berlin Spittelmarkt 10 10117 Berlin	Standort Frankfurt am Main Gartenstraße 6 60594 Frankfurt am Main	Standort Braunschweig Rundelallee 100 38116 Braunschweig
--	---	--

Die auszugsweise Veröffentlichung der Akkreditierungsurkunde bedarf der vorherigen schriftlichen Zustimmung der Deutsche Akkreditierungsstelle GmbH (DAkkS). Ausgenommen davon ist die separate Weiterverbreitung des Deckblattes durch die umseitig genannte Konformitätsbewertungsstelle in unveränderter Form.

Es darf nicht der Anschein erweckt werden, dass sich die Akkreditierung auch auf Bereiche erstreckt, die über den durch die DAkkS bestätigten Akkreditierungsbereich hinausgehen.

Die Akkreditierung erfolgte gemäß des Gesetzes über die Akkreditierungsstelle (AkkStelleG) vom 31. Juli 2009 (BGBl. I S. 2625) sowie der Verordnung (EG) Nr. 765/2008 des Europäischen Parlaments und des Rates vom 9. Juli 2008 über die Vorschriften für die Akkreditierung und Marktüberwachung im Zusammenhang mit der Vermarktung von Produkten (Abt. L 218 vom 9. Juli 2008, S. 30). Die DAkkS ist Unterzeichnerin der Multilateralen Abkommen zur gegenseitigen Anerkennung der European co-operation for Accreditation (EA), des International Accreditation Forum (IAF) und der International Laboratory Accreditation Cooperation (ILAC). Die Unterzeichner dieser Abkommen erkennen ihre Akkreditierungen gegenseitig an.

Der aktuelle Stand der Mitgliedschaft kann folgenden Webseiten entnommen werden:
EA: www.european-accreditation.org
ILAC: www.ilac.org
IAF: www.iaf.nu

Note:

The current certificate including annex is published on our website (see link below) or may be received from CETECOM ICT Services on request.

<http://www.cetecom.com/eu/de/cetecom-group/europa/deutschland-saarbruecken/akkreditierungen.html>