

TR no.: 21096300-23127-1

2021-12-20

Plot no. 57: radiated emissions 18 GHz – 26.5 GHz, Mode 4, polarization vertical / horizontal

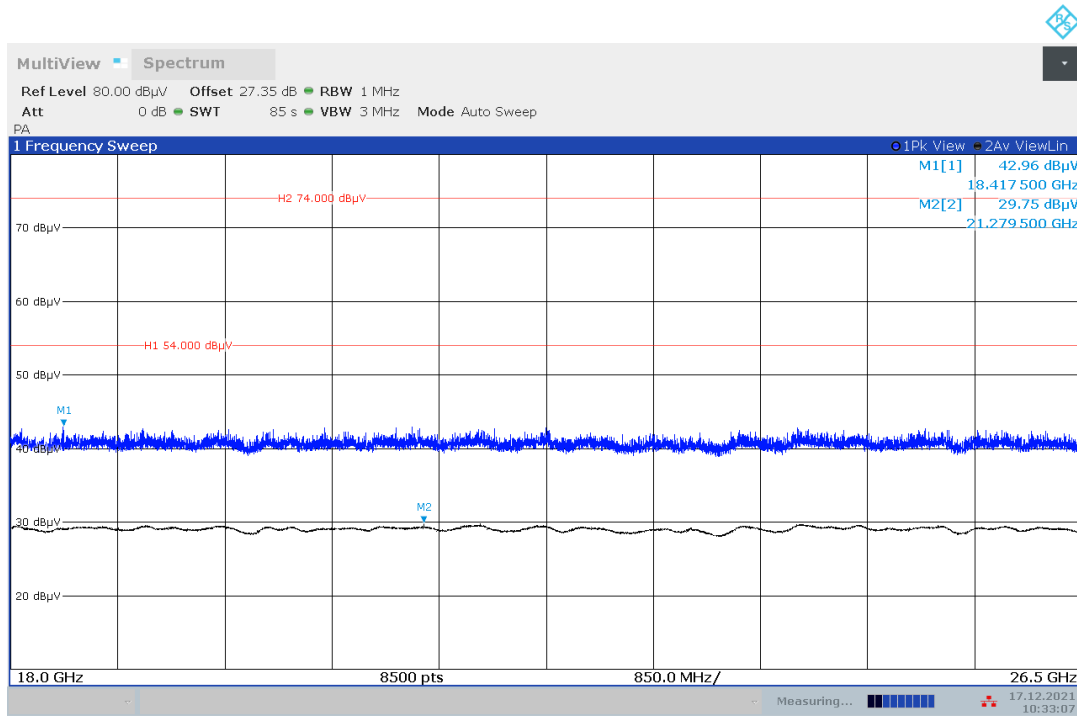

Plot no. 58: radiated emissions 26.5 GHz – 40 GHz, Mode 1, polarization vertical / horizontal

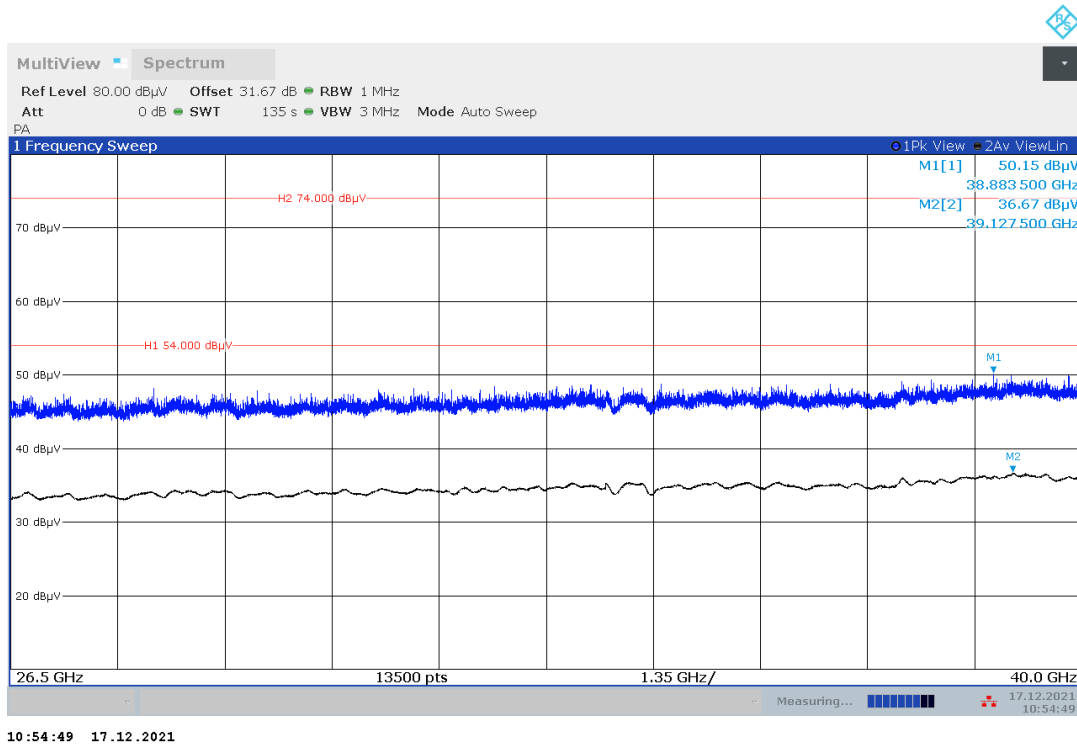

TR no.: 21096300-23127-1

2021-12-20

Plot no. 59: radiated emissions 26.5 GHz – 40 GHz, Mode 2, polarization vertical / horizontal

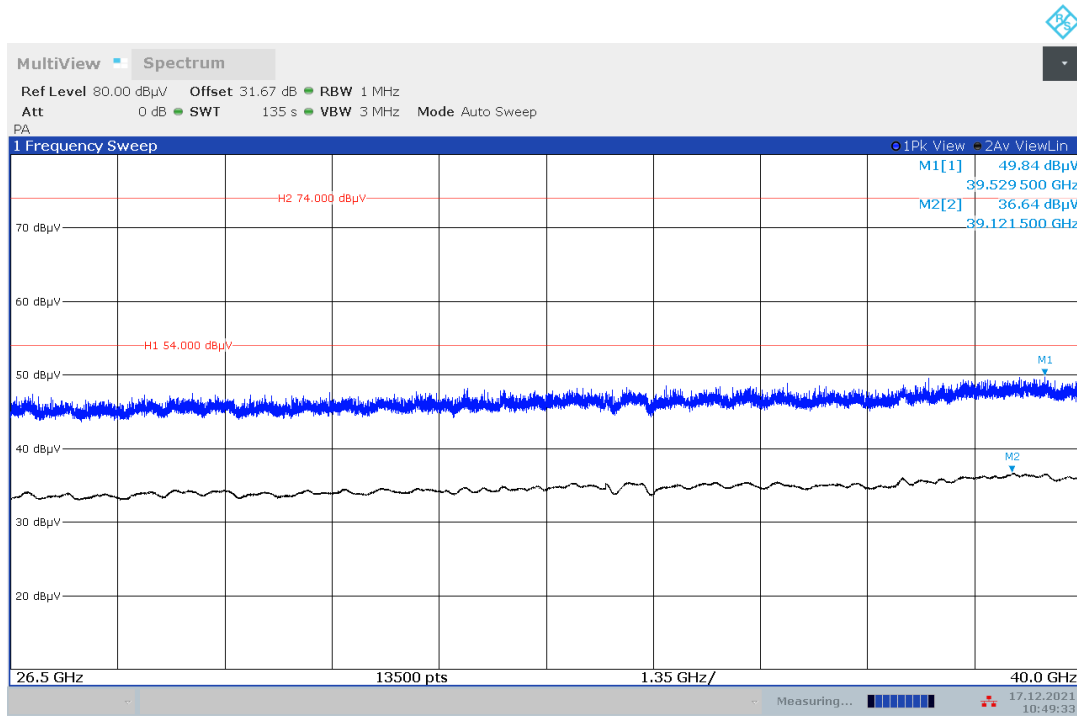

Plot no. 60: radiated emissions 26.5 GHz – 40 GHz, Mode 4, polarization vertical / horizontal

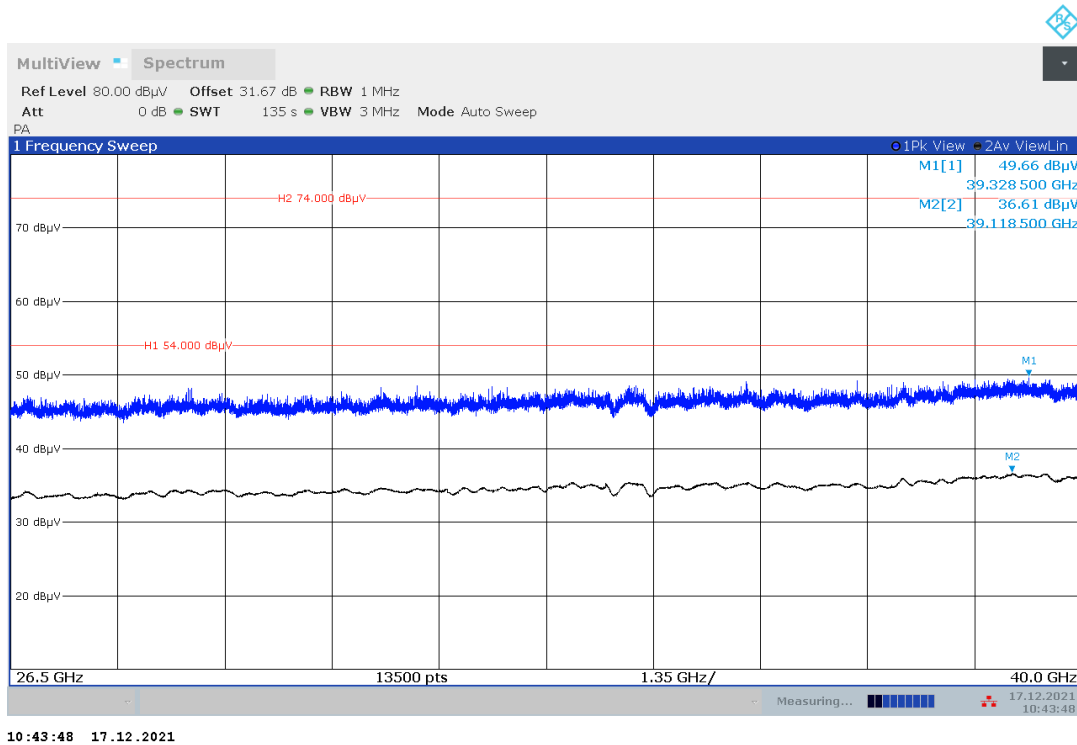

TR no.: 21096300-23127-1

2021-12-20

Plot no. 61: radiated emissions 40 GHz – 60 GHz, Mode 1, polarization vertical / horizontal

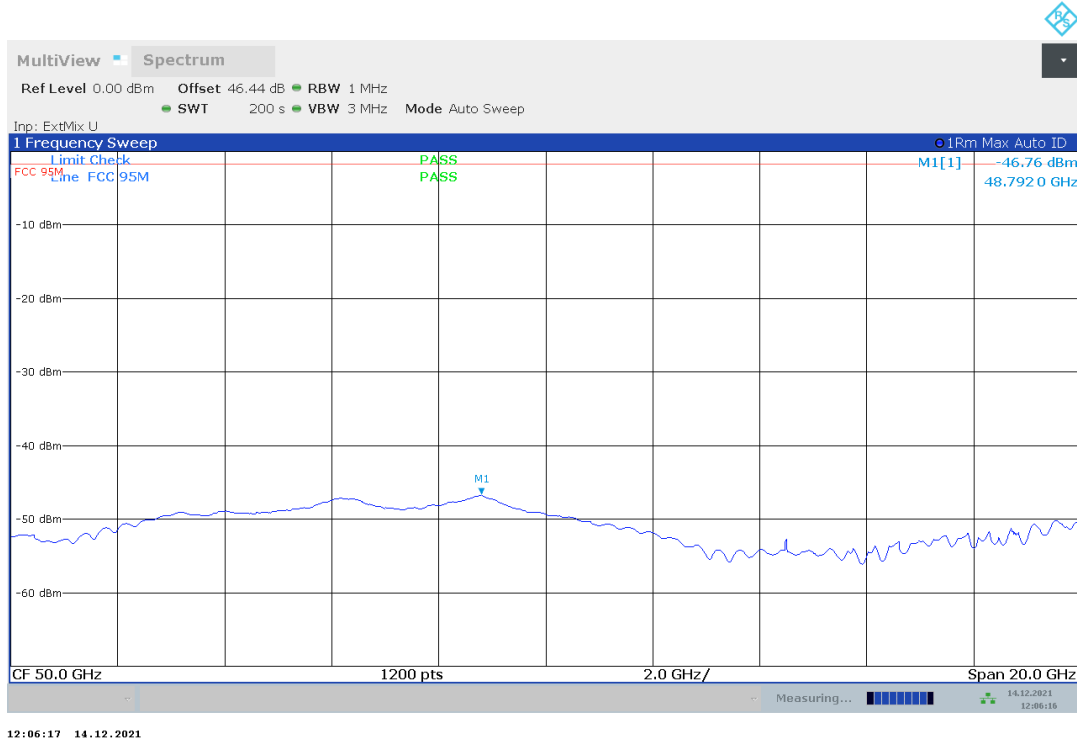

Plot no. 62: radiated emissions 40 GHz – 60 GHz, Mode 2, polarization vertical / horizontal

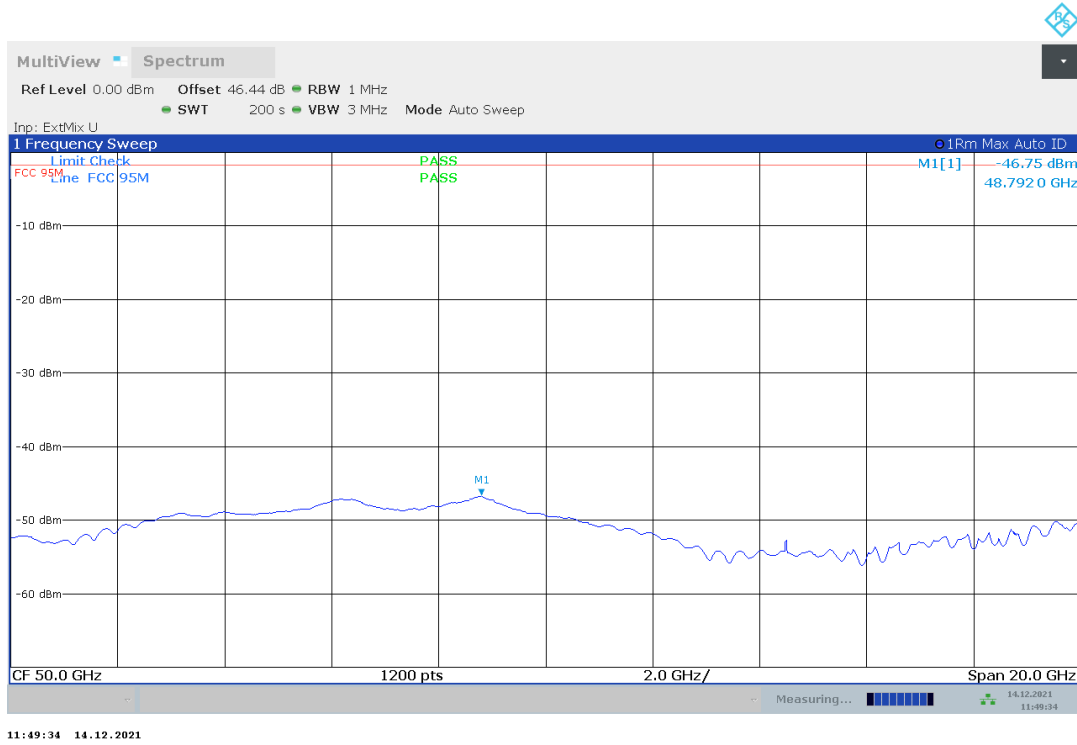

TR no.: 21096300-23127-1

2021-12-20

Plot no. 63: radiated emissions 40 GHz – 60 GHz, Mode 4, polarization vertical / horizontal

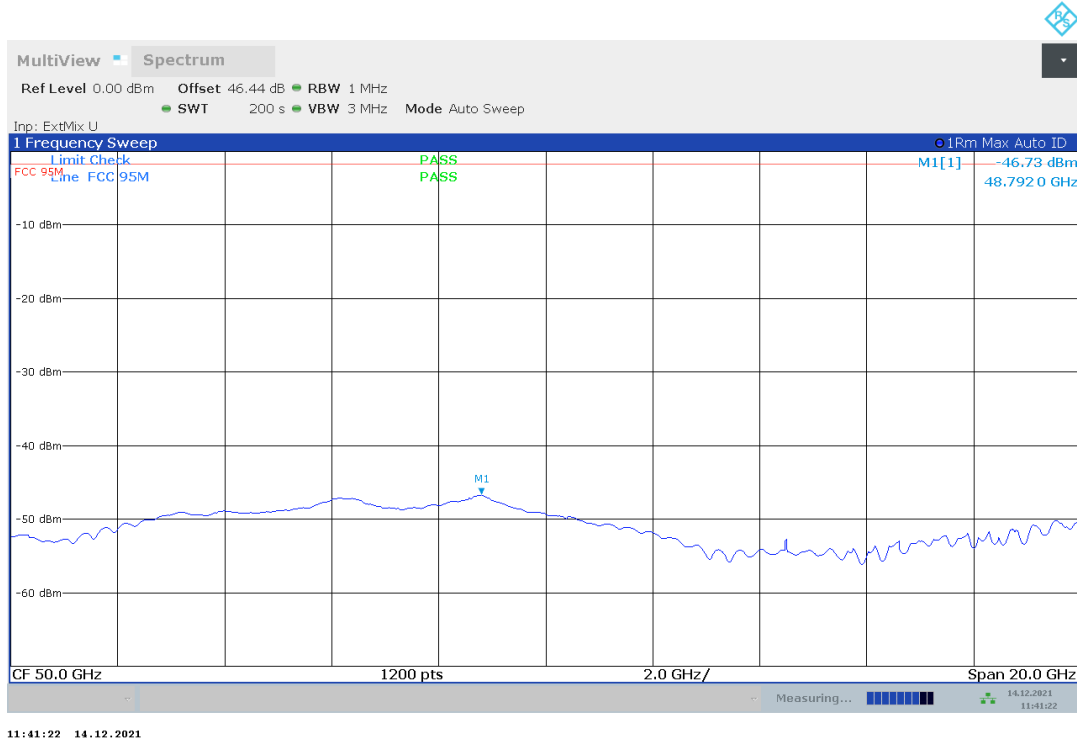

Plot no. 64: radiated emissions 60 GHz – 75 GHz, Mode 1, polarization vertical / horizontal

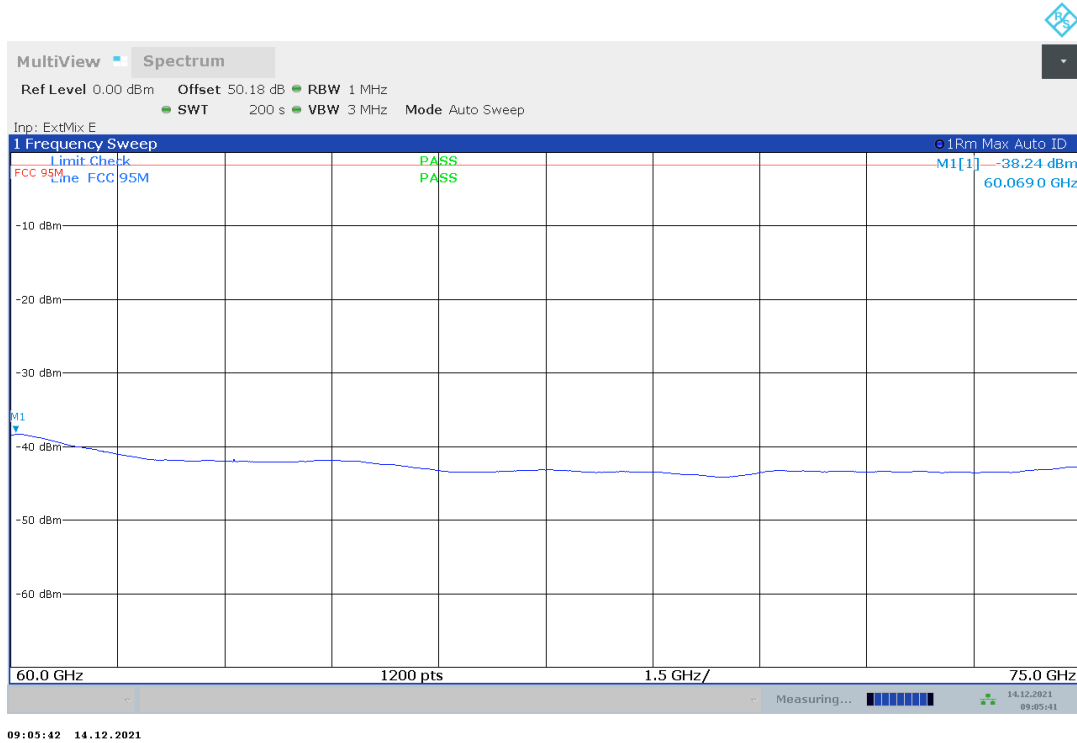

TR no.: 21096300-23127-1

2021-12-20

Plot no. 65: radiated emissions 60 GHz – 75 GHz, Mode 2, polarization vertical / horizontal

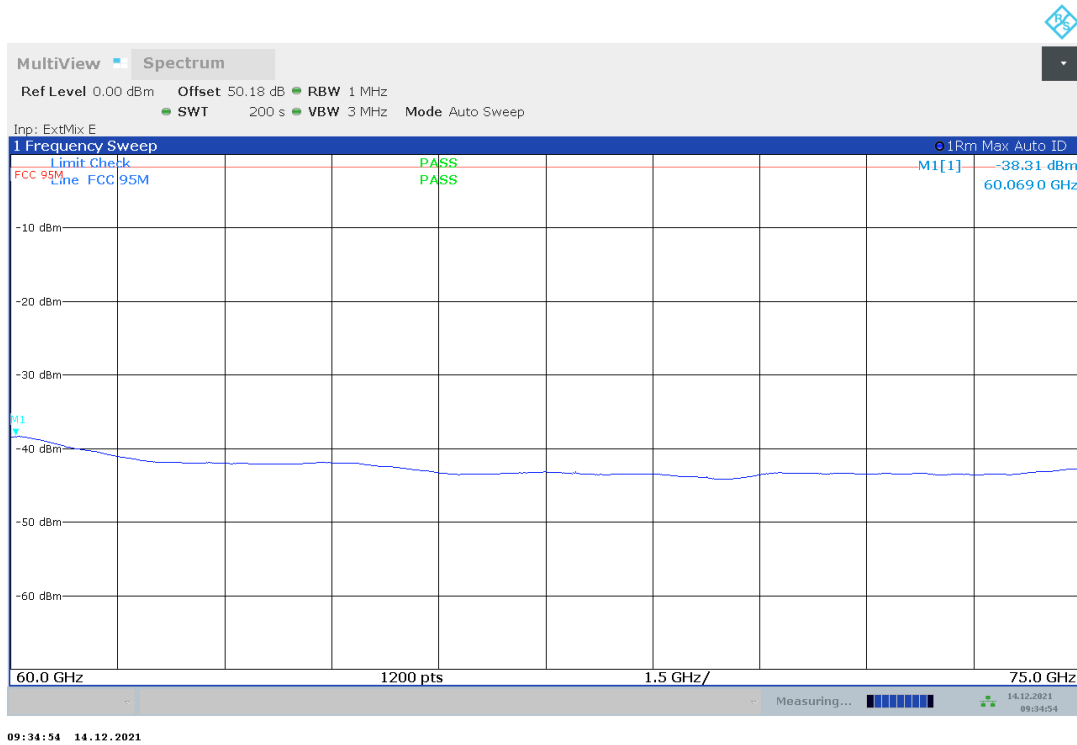

Plot no. 66: radiated emissions 60 GHz – 75 GHz, Mode 4, polarization vertical / horizontal

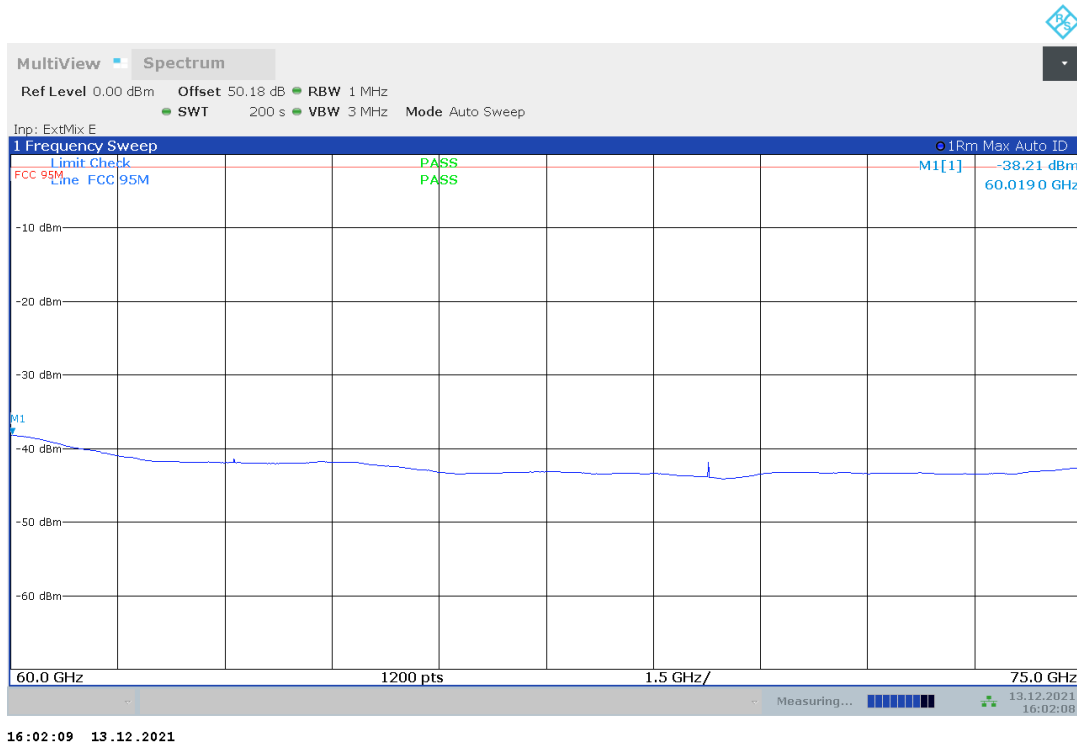

TR no.: 21096300-23127-1

2021-12-20

Plot no. 67: radiated emissions Band Edge Low, Mode 1, polarization vertical / horizontal

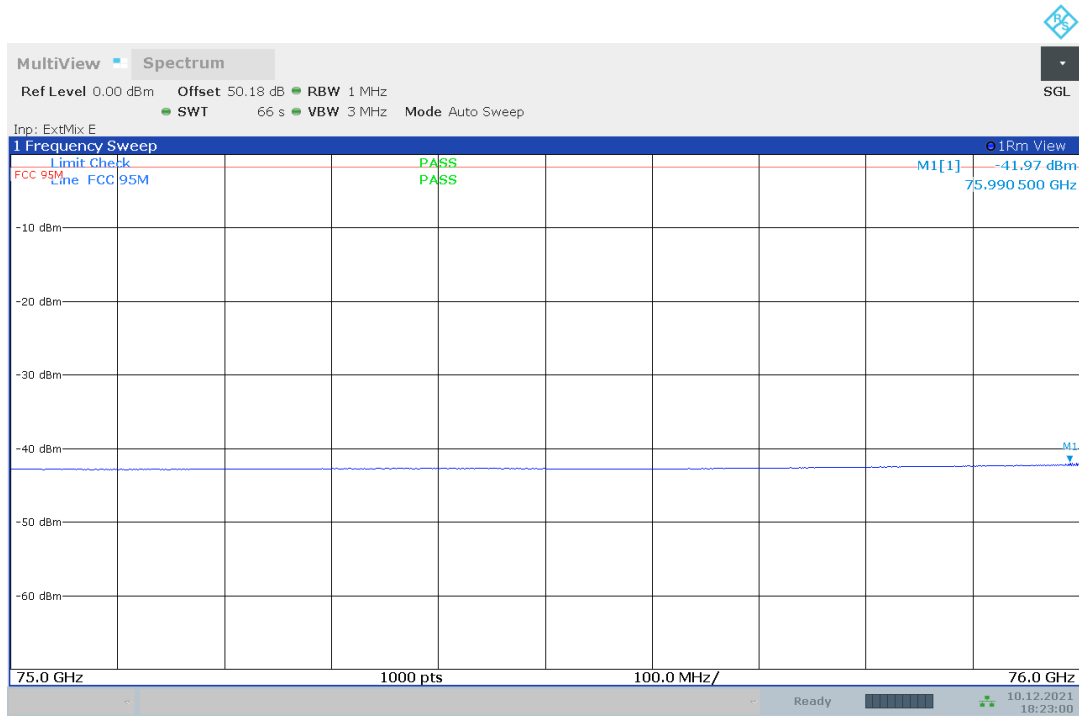

18:23:00 10.12.2021

Plot no. 68: radiated emissions Band Edge High, Mode 1, polarization vertical / horizontal

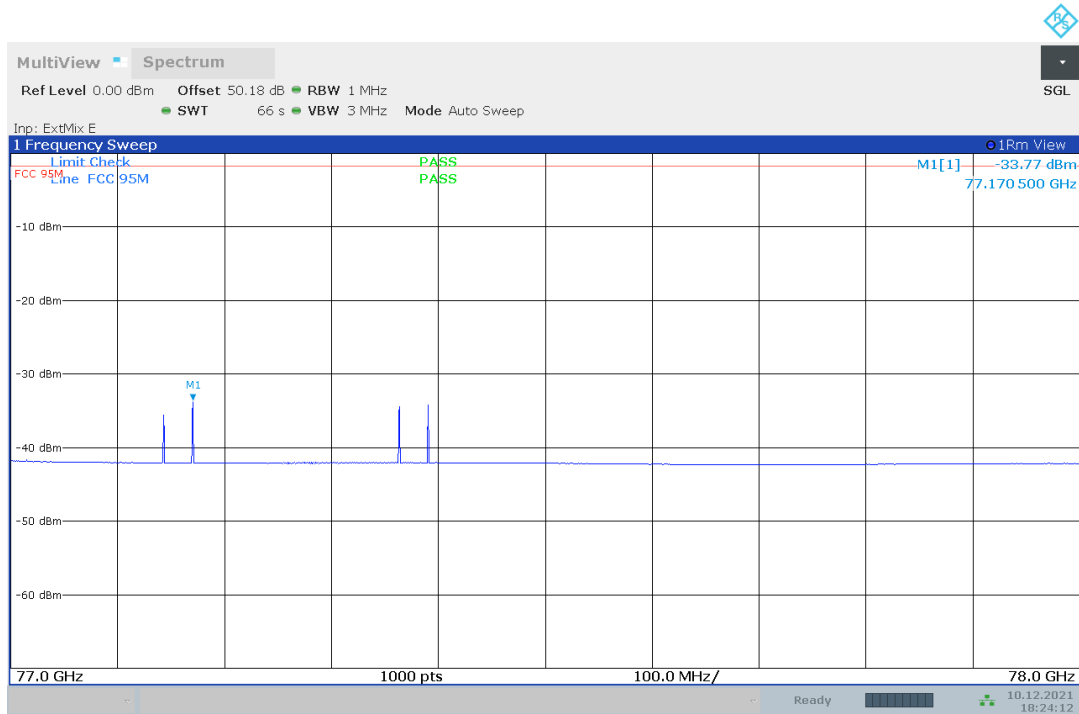

18:24:12 10.12.2021

TR no.: 21096300-23127-1

2021-12-20

Plot no. 69: radiated emissions Band Edge Low, Mode 2, polarization vertical / horizontal

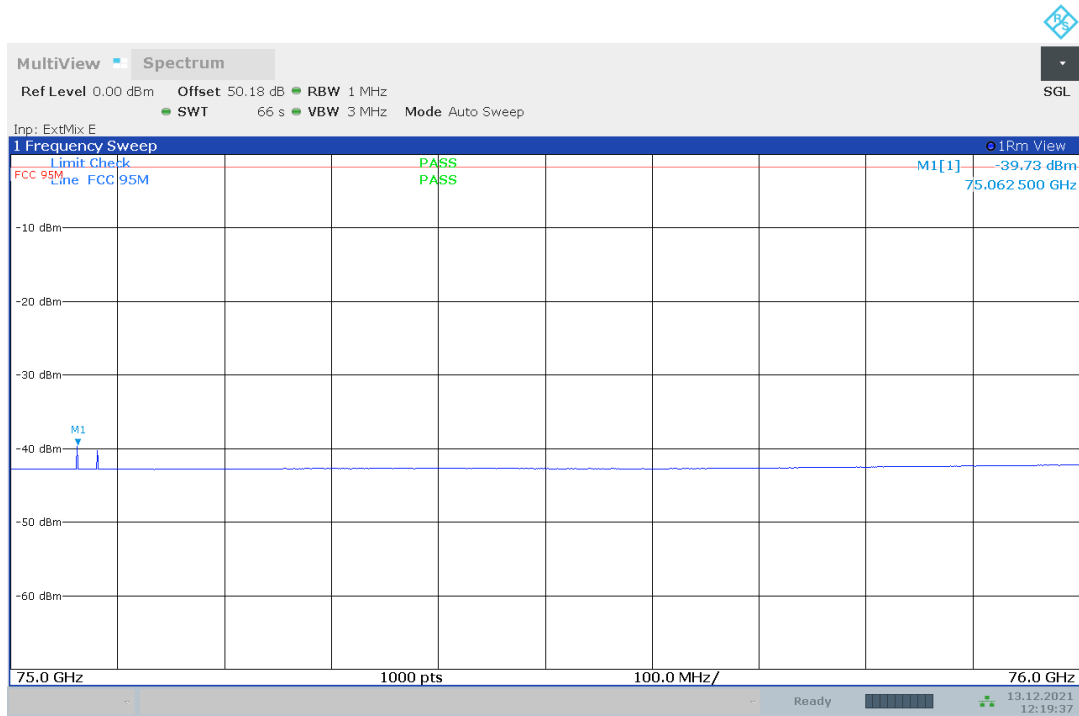

Plot no. 70: radiated emissions Band Edge High, Mode 2, polarization vertical / horizontal

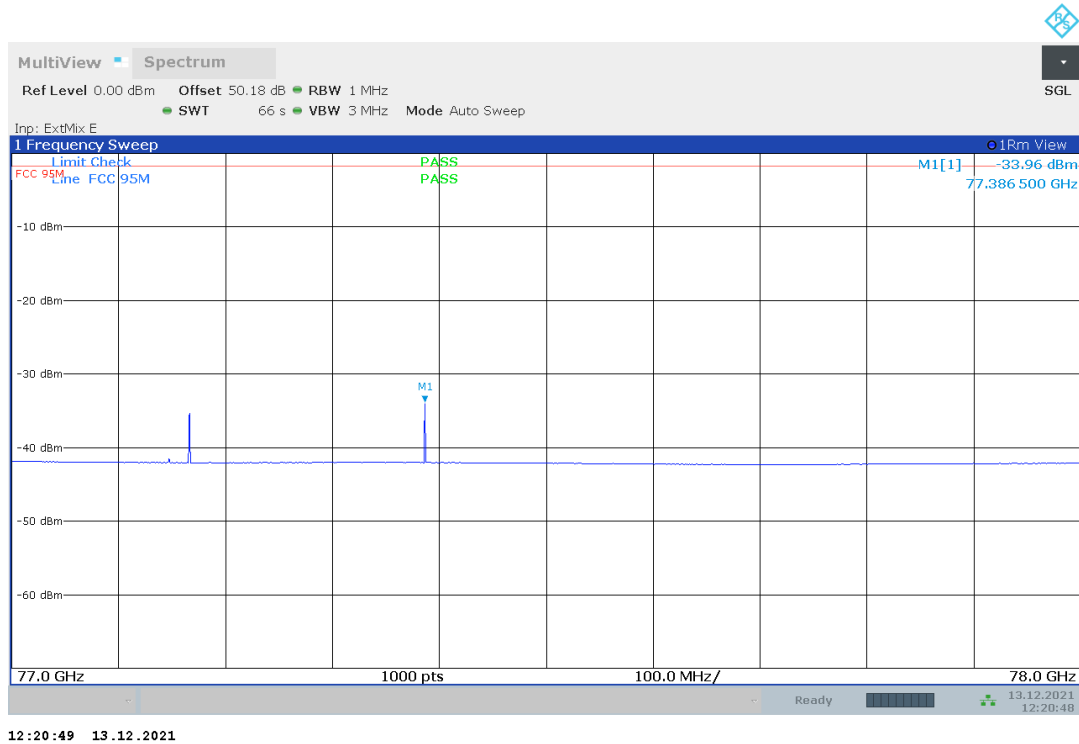

TR no.: 21096300-23127-1

2021-12-20

Plot no. 71: radiated emissions Band Edge Low, Mode 4, polarization vertical / horizontal

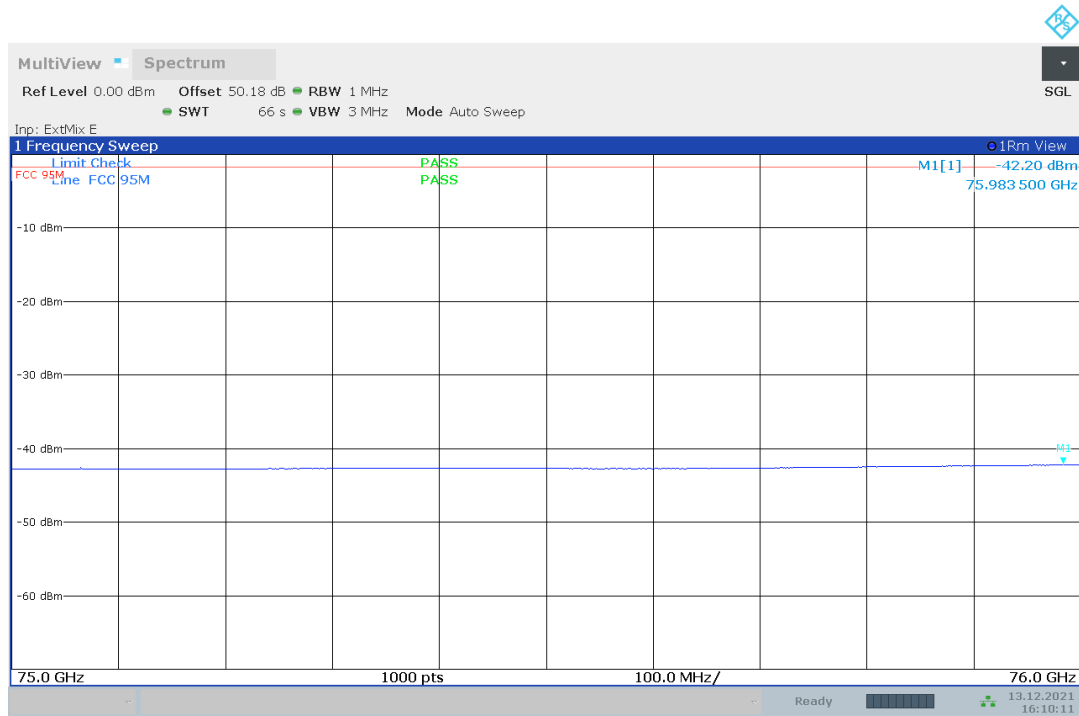

Plot no. 72: radiated emissions Band Edge High, Mode 4, polarization vertical / horizontal



TR no.: 21096300-23127-1

2021-12-20

Plot no. 73: radiated emissions 78 GHz – 84 GHz, Mode 1, polarization vertical / horizontal

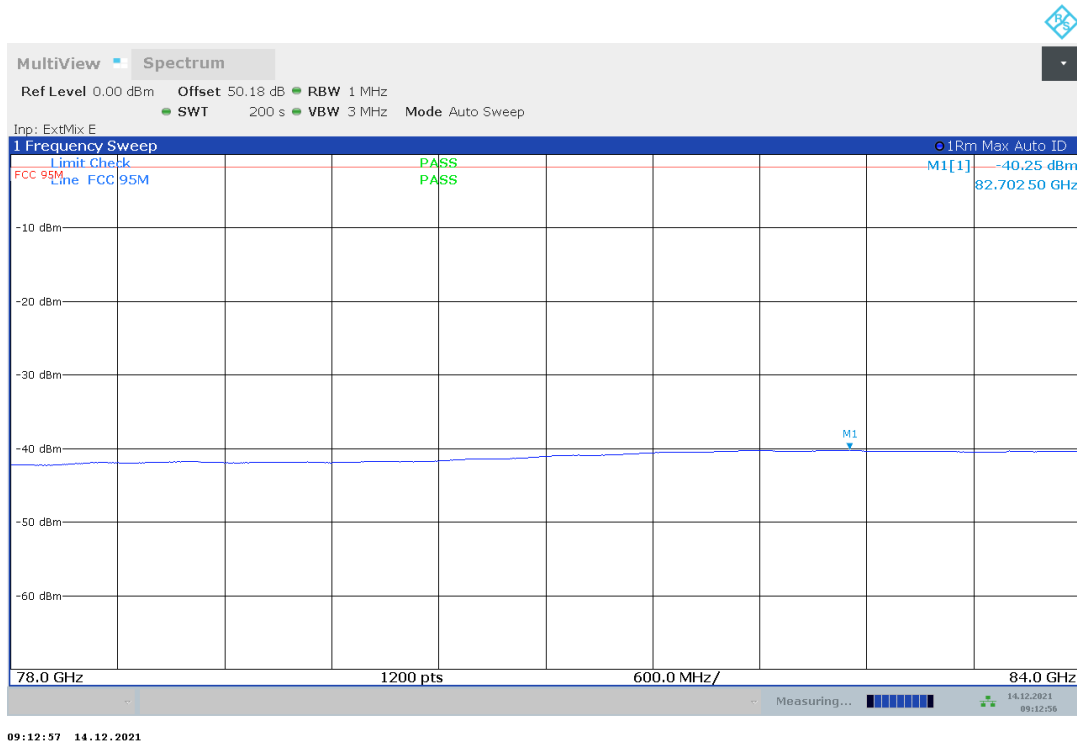

Plot no. 74: radiated emissions 78 GHz – 84 GHz, Mode 2, polarization vertical / horizontal

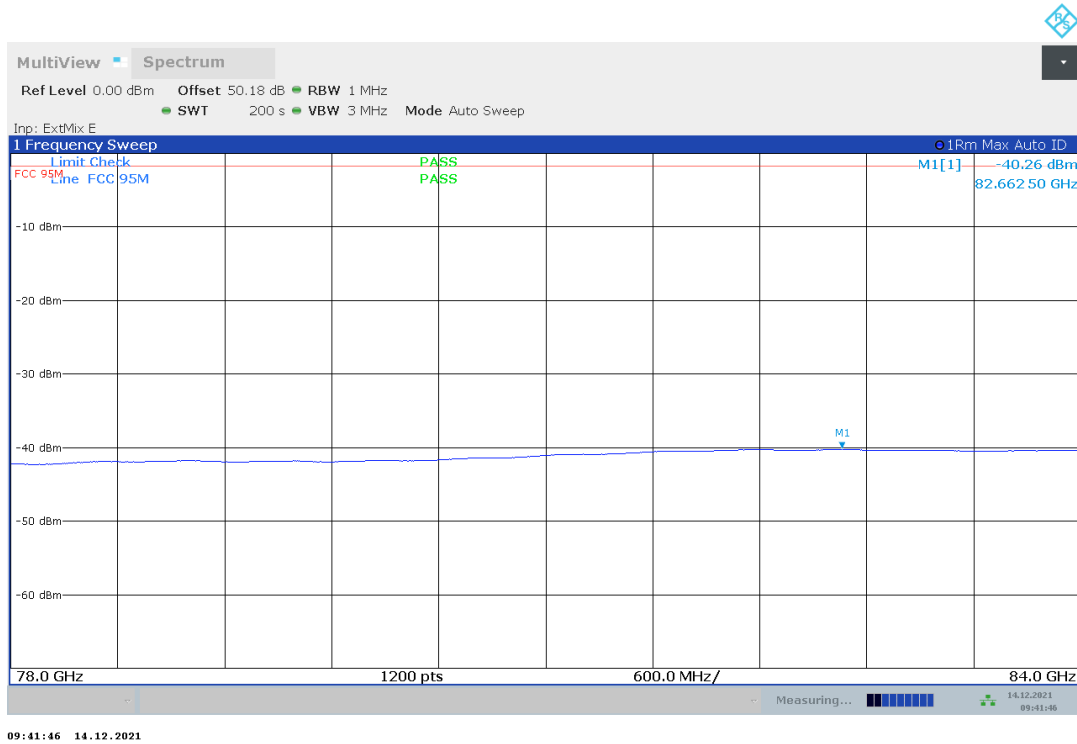

TR no.: 21096300-23127-1

2021-12-20

Plot no. 75: radiated emissions 78 GHz – 84 GHz, Mode 4, polarization vertical / horizontal

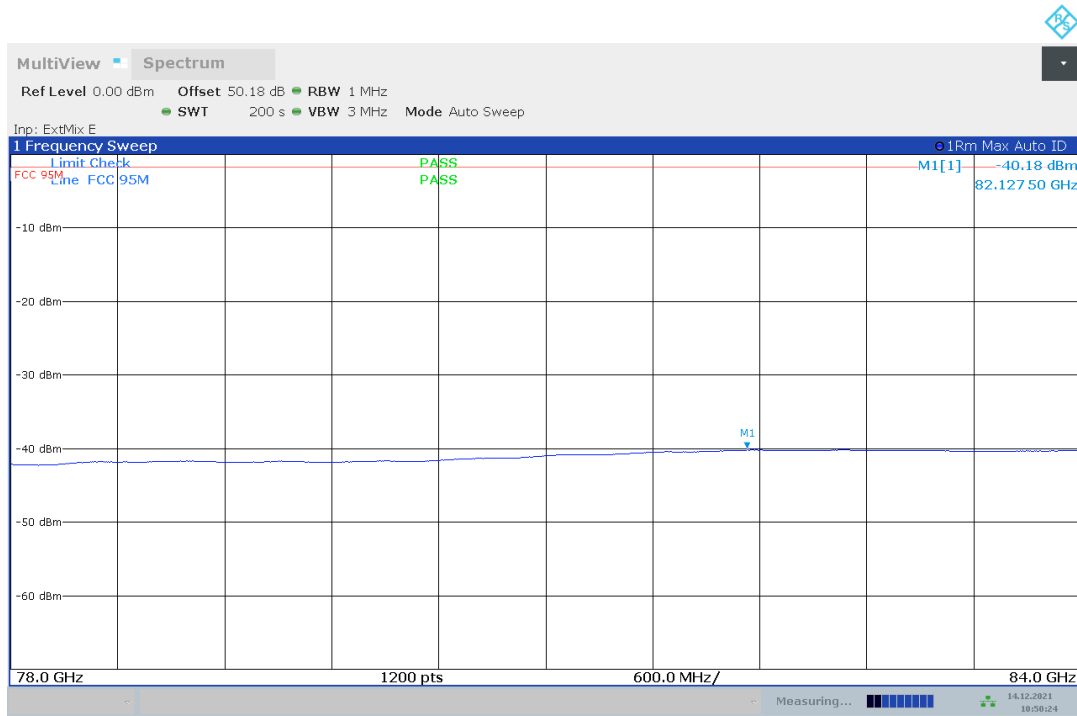

Plot no. 76: radiated emissions 84 GHz – 110 GHz, Mode 1, polarization vertical / horizontal

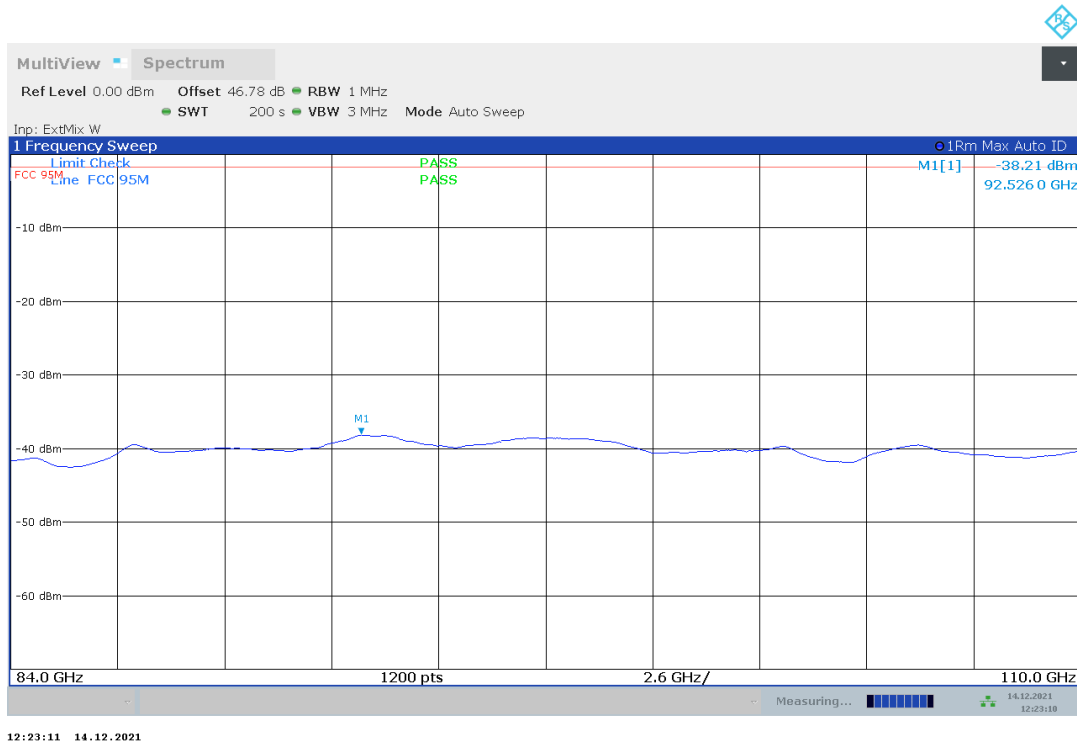

TR no.: 21096300-23127-1

2021-12-20

Plot no. 77: radiated emissions 84 GHz – 110 GHz, Mode 2, polarization vertical / horizontal

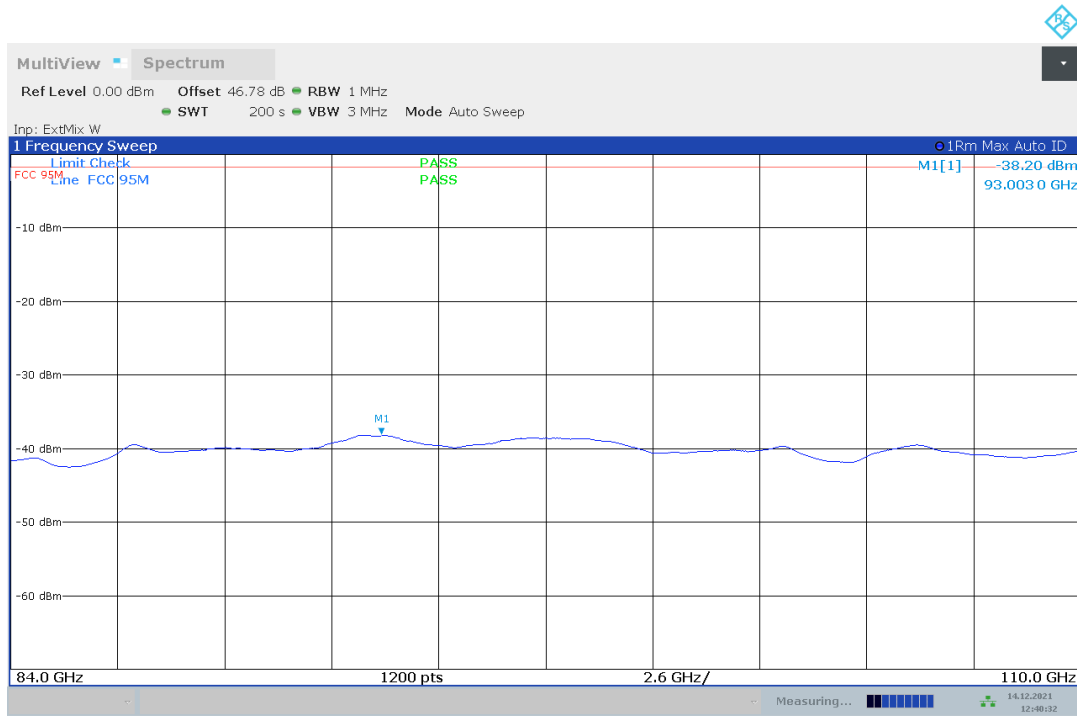

12:40:32 14.12.2021

Plot no. 78: radiated emissions 84 GHz – 110 GHz, Mode 4, polarization vertical / horizontal

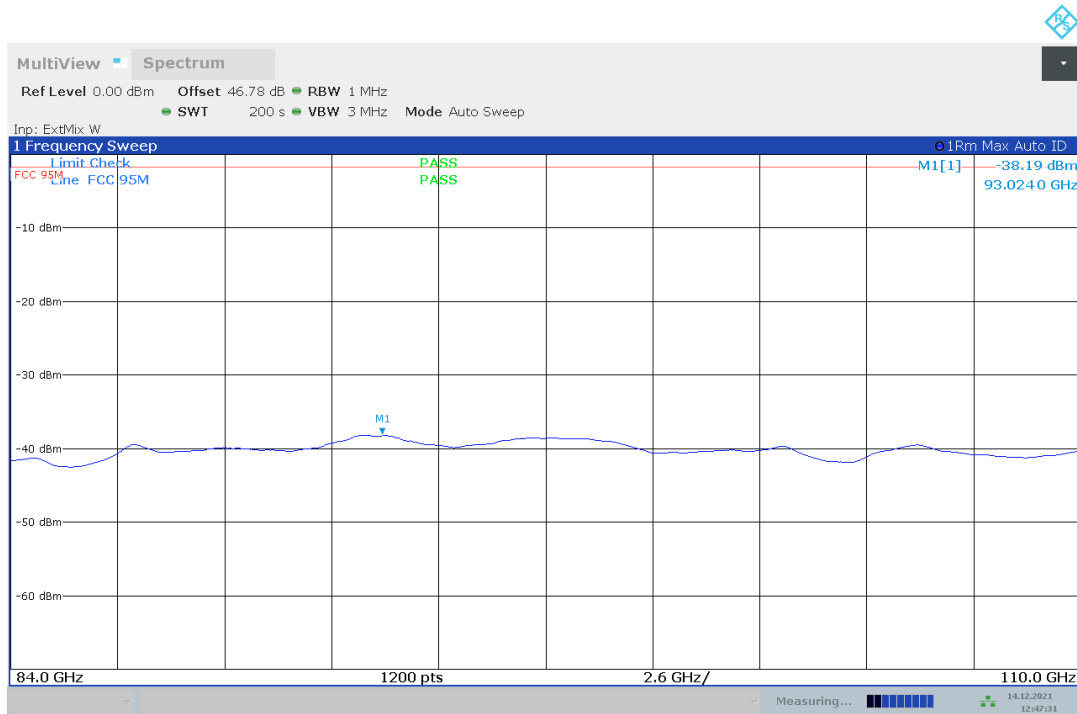

12:47:31 14.12.2021

TR no.: 21096300-23127-1

2021-12-20

Plot no. 79: radiated emissions 110 GHz – 170 GHz, Mode 1, polarization vertical / horizontal

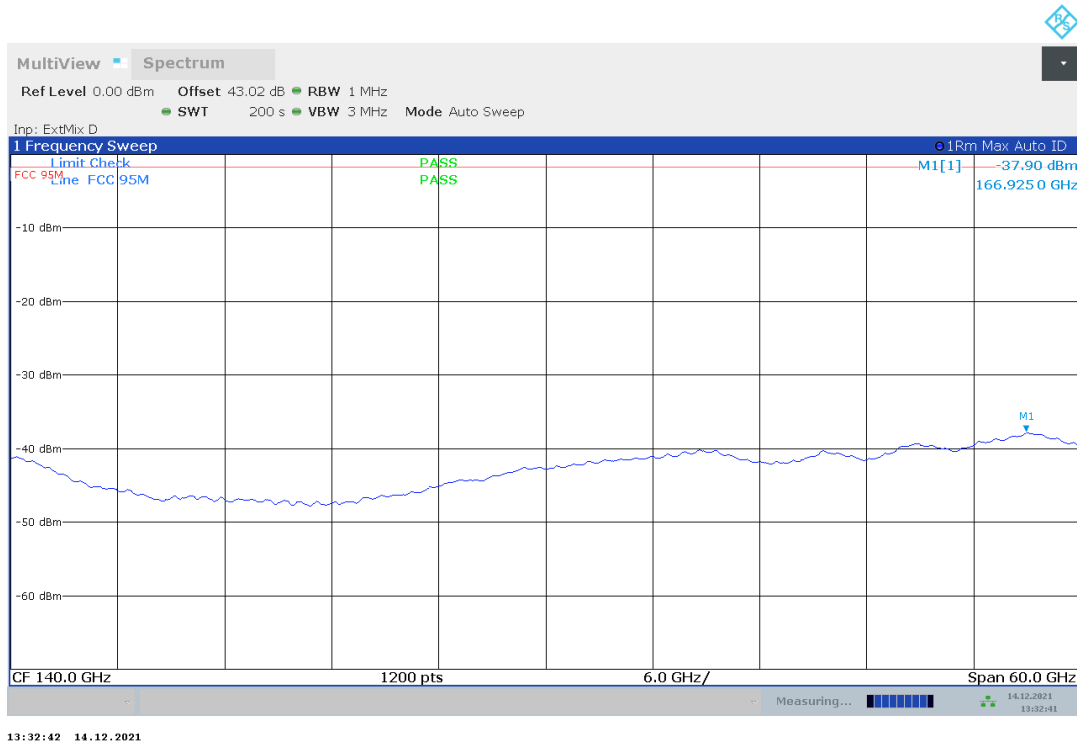

Plot no. 80: radiated emissions 110 GHz – 170 GHz, Mode 2, polarization vertical / horizontal

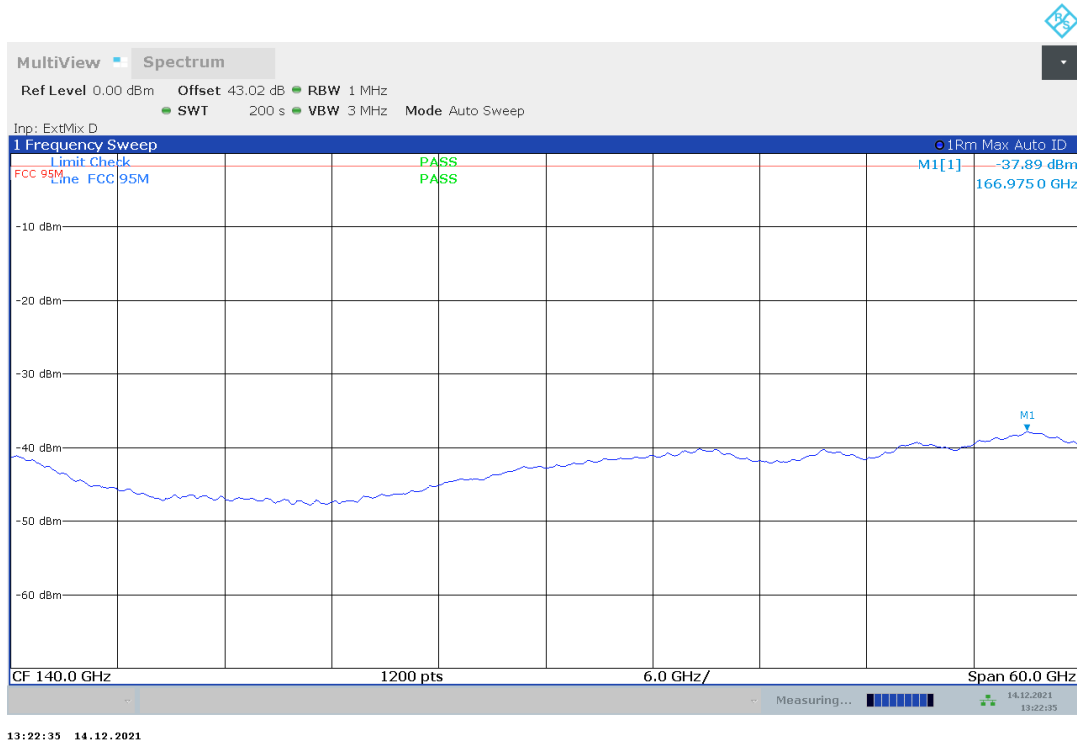

TR no.: 21096300-23127-1

2021-12-20

Plot no. 81: radiated emissions 110 GHz – 170 GHz, Mode 4, polarization vertical / horizontal

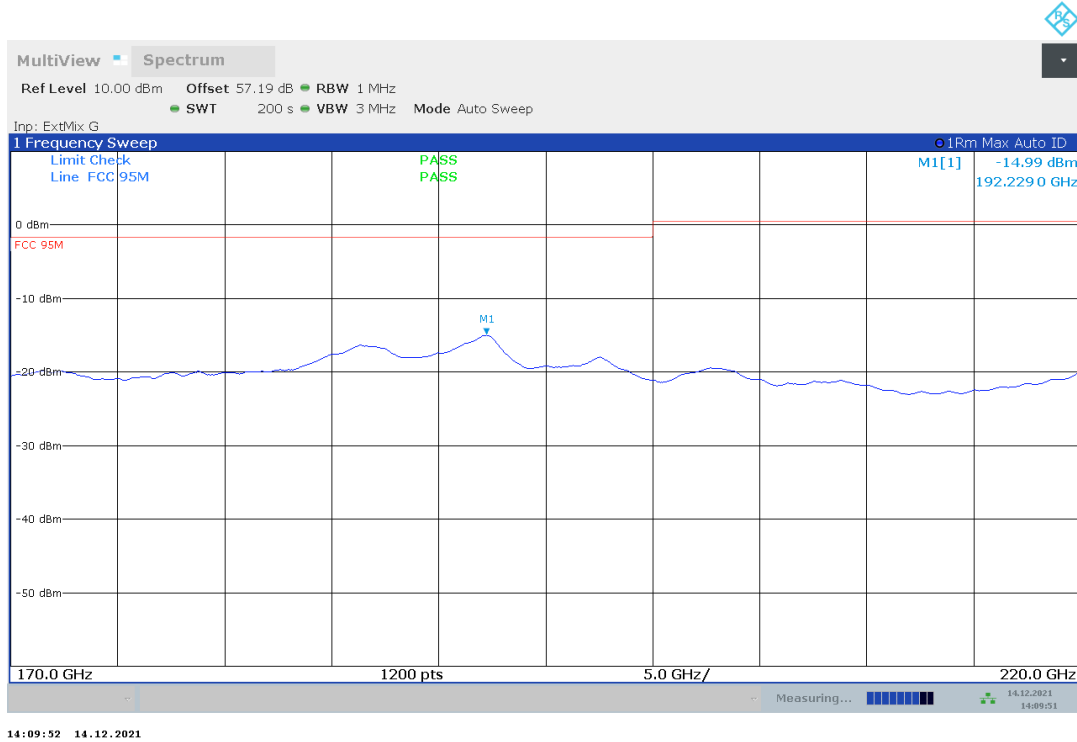

Plot no. 82: radiated emissions 170 GHz – 220 GHz, Mode 1, polarization vertical / horizontal

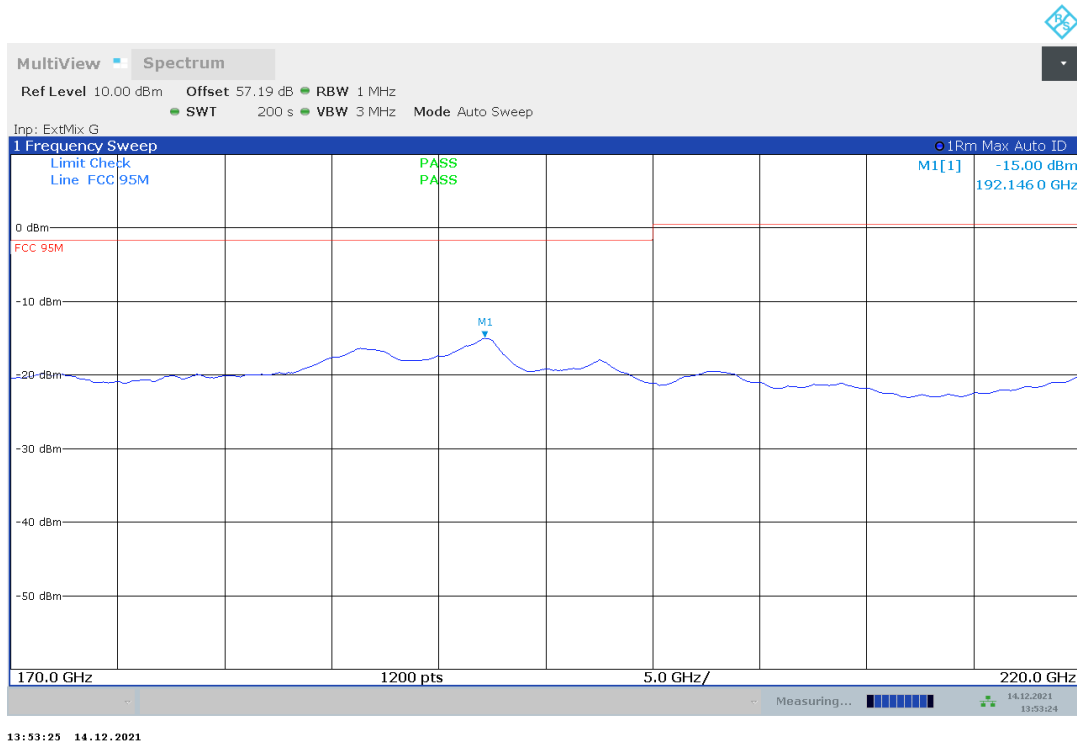

TR no.: 21096300-23127-1

2021-12-20

Plot no. 83: radiated emissions 170 GHz – 220 GHz, Mode 2, polarization vertical / horizontal

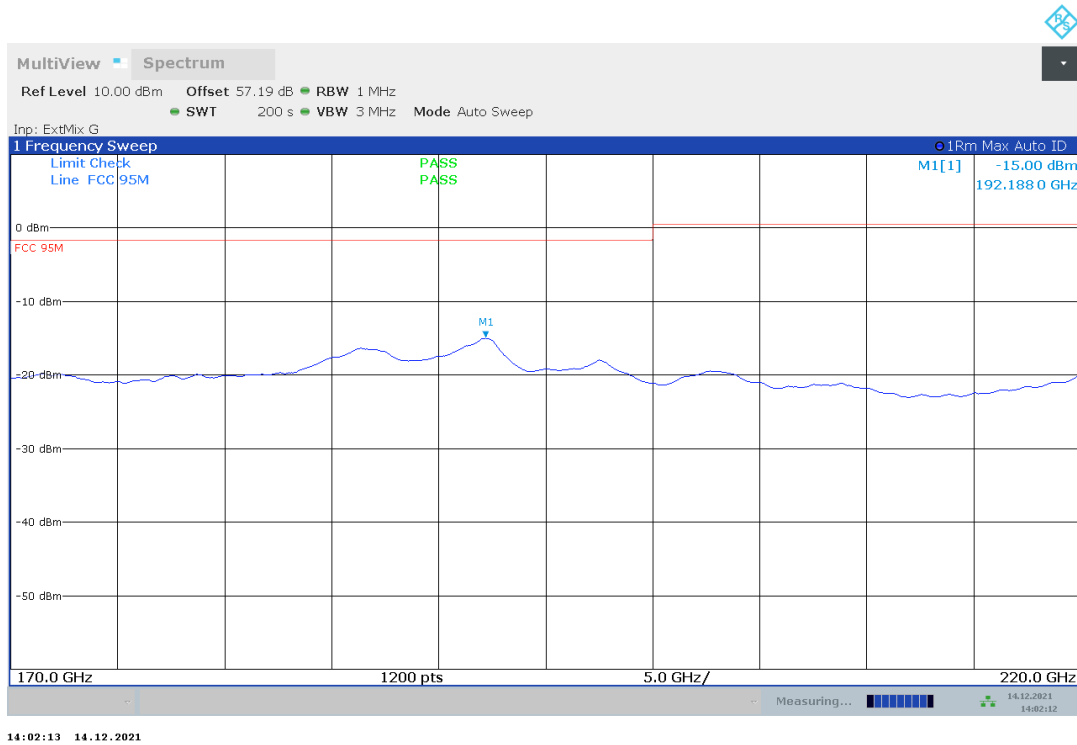

Plot no. 84: radiated emissions 170 GHz – 220 GHz, Mode 4, polarization vertical / horizontal

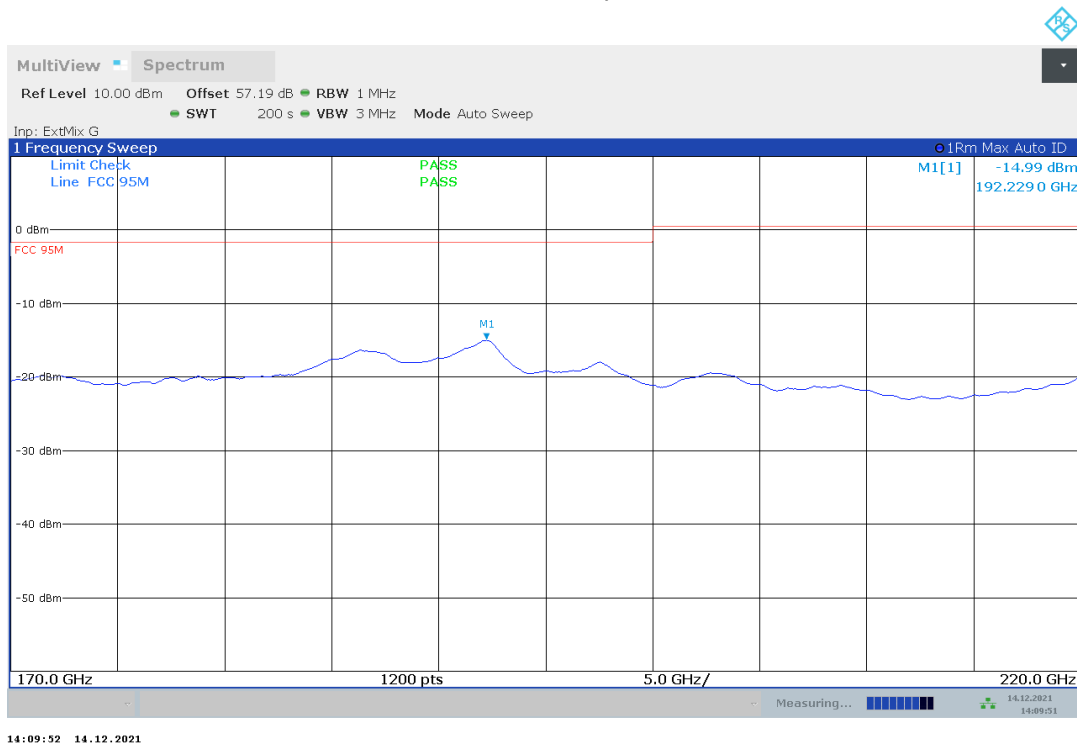

TR no.: 21096300-23127-1

2021-12-20

Plot no. 85: radiated emissions 220 GHz – 325 GHz, Mode 1, polarization vertical / horizontal

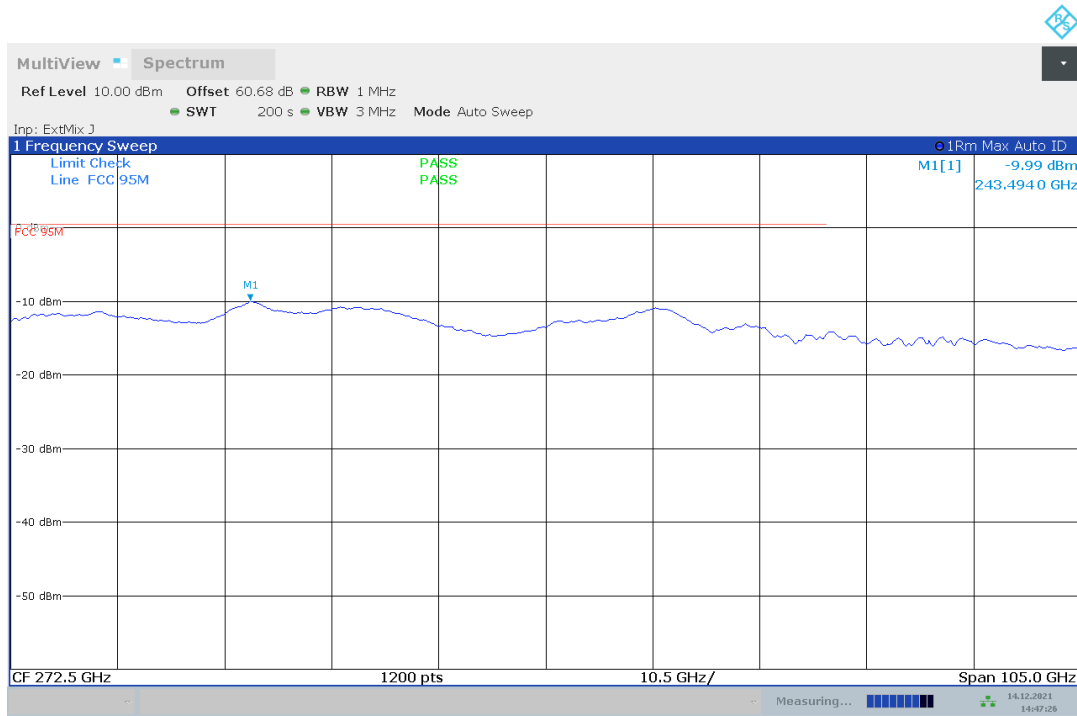

Plot no. 86: radiated emissions 220 GHz – 325 GHz, Mode 2, polarization vertical / horizontal

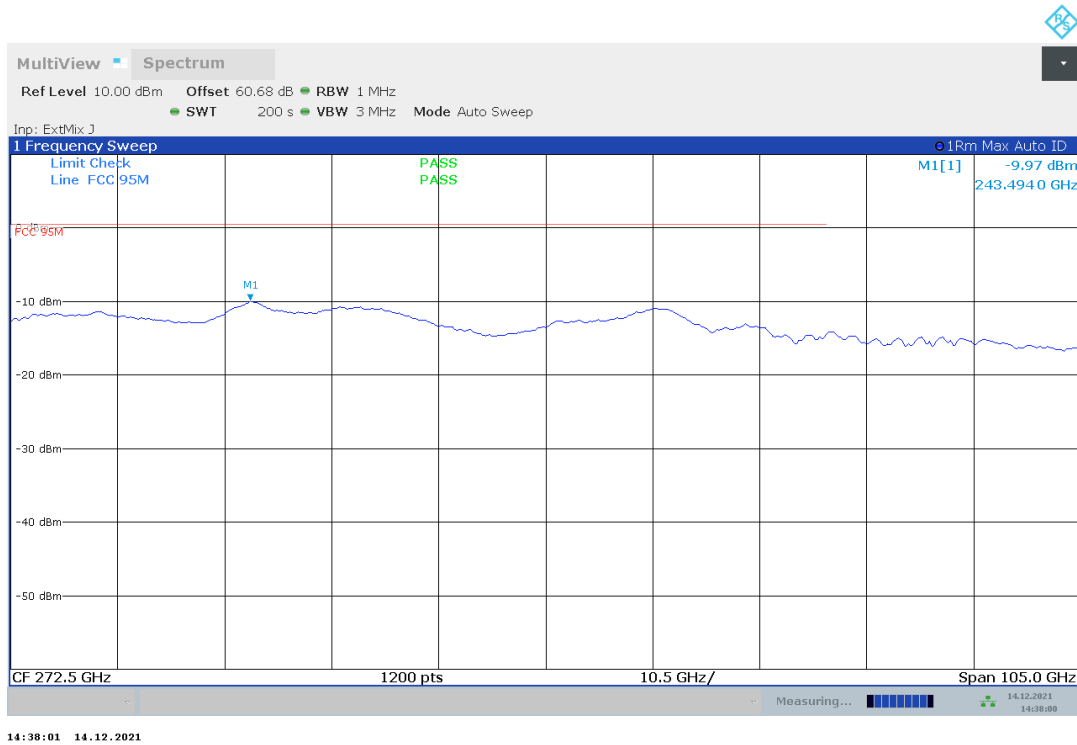

TR no.: 21096300-23127-1

2021-12-20

Plot no. 87: radiated emissions 220 GHz – 325 GHz, Mode 4, polarization vertical / horizontal

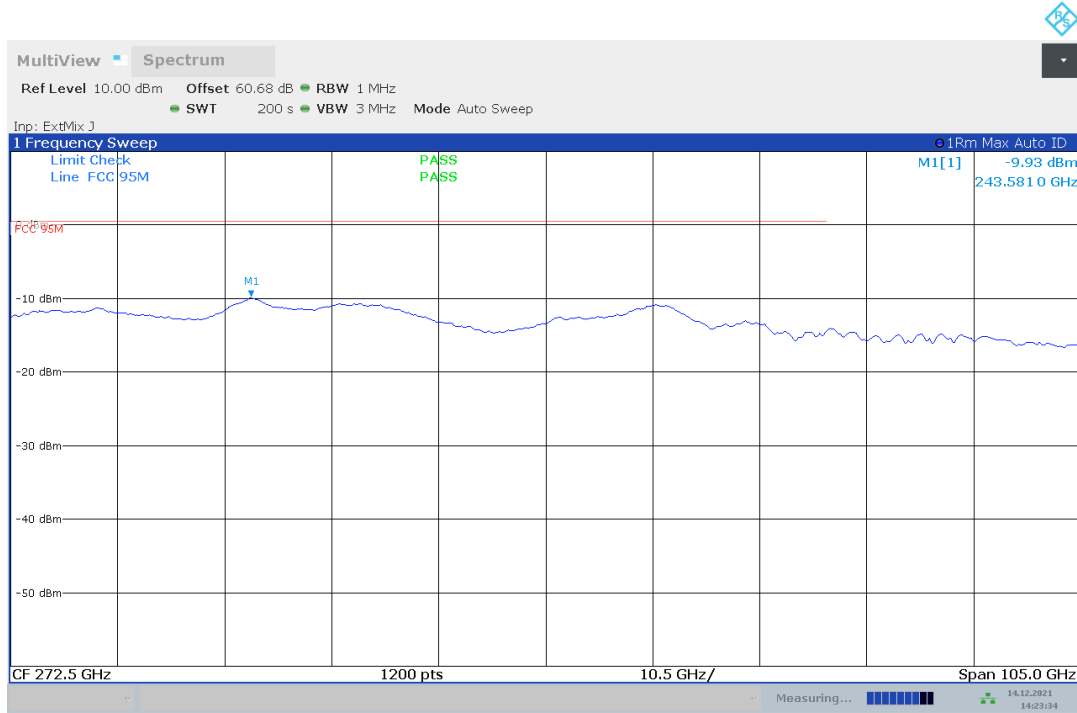

7.5 Frequency stability (§2.1055 & §95.3379(b))

Description

§2.1055 Measurements required: Frequency stability.

(a) The frequency stability shall be measured with variation of ambient temperature as follows:

- (1) From -30° to $+50^{\circ}$ centigrade for all equipment except that specified in paragraphs (a) (2) and (3) of this section.
- (b) Frequency measurements shall be made at the extremes of the specified temperature range and at intervals of not more than 10° centigrade through the range. A period of time sufficient to stabilize all of the components of the oscillator circuit at each temperature level shall be allowed prior to frequency measurement. The short term transient effects on the frequency of the transmitter due to keying (except for broadcast transmitters) and any heating element cycling normally occurring at each ambient temperature level also shall be shown. Only the portion or portions of the transmitter containing the frequency determining and stabilizing circuitry need be subjected to the temperature variation test.

(d) The frequency stability shall be measured with variation of primary supply voltage as follows:

- (1) Vary primary supply voltage from 85 to 115 percent of the nominal value for other than hand carried battery equipment.
- (2) For hand carried, battery powered equipment, reduce primary supply voltage to the battery operating end point which shall be specified by the manufacturer.
- (3) The supply voltage shall be measured at the input to the cable normally provided with the equipment, or at the power supply terminals if cables are not normally provided. Effects on frequency of transmitter keying (except for broadcast transmitters) and any heating element cycling at the nominal supply voltage and at each extreme also shall be shown.

Limits

§95.3379 76-81 GHz Band Radar Service unwanted emissions limits.

- (b) Fundamental emissions must be contained within the frequency bands specified in this section during all conditions of operation. Equipment is presumed to operate over the temperature range -20 to $+50$ degrees Celsius with an input voltage variation of 85% to 115% of rated input voltage, unless justification is presented to demonstrate otherwise.

Test procedure

ANSI C63.26, 5.4.4

The occupied bandwidth is the frequency bandwidth such that, below its lower and above its upper frequency limits, the mean powers are each equal to 0.5% of the total mean power of the given emission.

The following procedure shall be used for measuring 99% power bandwidth:

- a) The instrument center frequency is set to the nominal EUT channel center frequency. The frequency span for the spectrum analyzer shall be between 1.5 times and 5.0 times the OBW.
- b) The nominal IF filter bandwidth (3 dB RBW) shall be in the range of 1% to 5% of the OBW, and VBW shall be approximately three times the RBW, unless otherwise specified by the applicable requirement.
- c) Set the reference level of the instrument as required, keeping the signal from exceeding the maximum input mixer level for linear operation. In general, the peak of the spectral envelope shall be more than $[10 \log(\text{OBW}/\text{RBW})]$ below the reference level. Specific guidance is given in 4.1.5.2.
Note: Step a) through step c) may require iteration to adjust within the specified tolerances.
- d) Set the detection mode to peak, and the trace mode to max-hold.
- e) If the instrument does not have a 99% OBW function, recover the trace data points and sum directly in linear power terms. Place the recovered amplitude data points, beginning at the lowest frequency, in a running sum until 0.5% of the total is reached. Record that frequency as the lower OBW frequency. Repeat the process until 99.5% of the total is reached and record that frequency as the upper OBW frequency. The 99% power OBW can be determined by computing the difference these two frequencies.
- f) The OBW shall be reported and plot(s) of the measuring instrument display shall be provided with the test report. The frequency and amplitude axis and scale shall be clearly labeled. Tabular data can be reported in addition to the plot(s)

Test results / Note

Please see measurement results for occupied bandwidth.

8 Test Setup Description

Typically, the calibrations of the test apparatus are commissioned to and performed by an accredited calibration laboratory. The calibration intervals are determined in accordance with the DIN EN ISO/IEC 17025. In addition to the external calibrations, the laboratory executes comparison measurements with other calibrated test systems or effective verifications. Cyclically chamber inspections and range calibrations are performed. Where possible resp. necessary, RF generating and signaling equipment as well as measuring receivers and analyzers are connected to an external high-precision 10 MHz reference (GPS-based frequency standard).

In order to simplify the identification of the equipment used at some special tests, some items of test equipment and ancillaries can be provided with an identifier or number in the equipment list below (Lab/Item).

8.1 Semi Anechoic Chamber with Ground Plane

Radiated measurements are performed in vertical and horizontal plane in the frequency range 30 MHz to 1 GHz in a Semi Anechoic Chamber with a metallic ground plane. The EUT is positioned on a non-conductive test table with a height of 0.80 m above the metallic ground plane that covers the whole chamber. The receiving antennas conform to specification ANSI C63.26-2015, American National Standard for Compliance Testing of Transmitters Used in Licensed Radio Services. These antennas can be moved over the height range between 1.0 m and 4.5 m in order to search for maximum field strength emitted from the EUT. The measurement distances between EUT and receiving antennas are indicated in the test setups for the various frequency ranges. For each measurement, the EUT is rotated in all three axes until the maximum field strength is received. The wanted and unwanted emissions are received by a spectrum analyzer where the detector modes and resolution bandwidths over various frequency ranges are set according to requirement ANSI C63.

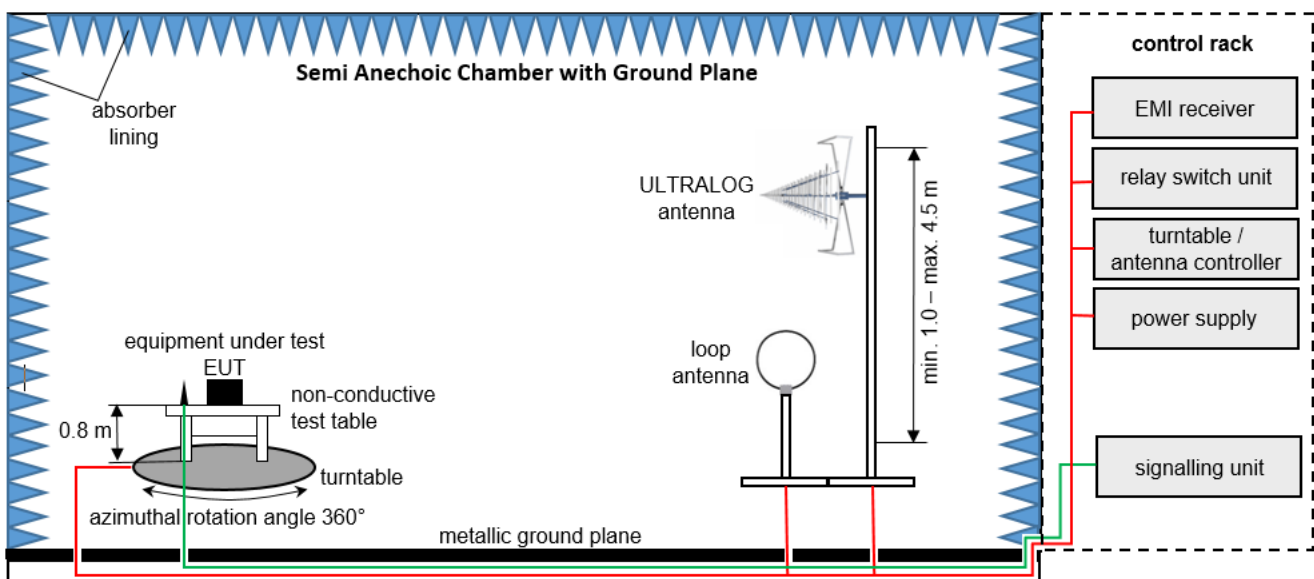

Measurement distance: ULTRALOG antenna 5 meter; loop antenna 5 meter / 3 meter / 1 meter
 EMC32 software version: 11.00.00

$$FS = UR + CL + AF$$

(FS-field strength; UR-voltage at the receiver; CL-loss of the cable; AF-antenna factor)

Example calculation:

$$FS [dB\mu V/m] = 12.35 [dB\mu V/m] + 1.90 [dB] + 16.80 [dB/m] = 31.05 [dB\mu V/m] (35.69 \mu V/m)$$

List of test equipment used:

No.	Equipment	Manufacturer	Type	Serial No.	IBL No.	Kind of Calibration	Calibration
1	EMI Test Receiver	Rohde & Schwarz	ESW26	101517	LAB000363	K	2021-02-05 → 12M → 2022-02-05
2	Power Supply	Elektro-Automatik GmbH & Co. KG	EA-PSI 9080-40 T	2000230001	LAB000313	NE	–
3	Test table	innco systems GmbH	PT1208-080-RH	-	LAB000306	NE	–
4	Power Supply	Chroma	61604	616040005416	LAB000285	NE	–
5	Antenna	TTE Europe	62-HA20-A-SMF	-	LAB000282	K	2020-09-29 → 36M → 2023-09-29
6	Positioner	matur GmbH	TD 1.5-10KG	-	LAB000258	NE	–
7	Compressed Air	Implotex	1-850-30	-	LAB000256	NE	–
8	Semi-Anechoic Chamber (SAC)	Albatross Projects GmbH	Babylon 5 (SAC 5)	20168.PRB	LAB000235	ZW	2020-08-24 → 36M → 2023-08-24
9	Measurement Software	Rohde & Schwarz	EMC32 V11.00.10	-	LAB000226	NE	–
10	Turntable	matur GmbH	TT2.0-2t	TT2.0-2t/921	LAB000225	NE	–
11	Antenna Mast	matur GmbH	CAM4.0-P	CAM4.0-P/316	LAB000224	NE	–
12	Controller	matur GmbH	FCU 3.0	10082	LAB000222	NE	–
13	Power Supply	Elektro-Automatik GmbH & Co. KG	EA-PS 2042-10 B	2878350292	LAB000191	NE	–
14	Pre-Amplifier	Schwarzbeck Mess-Elektronik OHG	BBV 9718 C	84	LAB000169	NE	–
15	Antenna	Rohde & Schwarz	HF907	102899	LAB000151	K	2020-04-23 → 36M → 2023-04-23
16	Antenna	Rohde & Schwarz	HL562E	102005	LAB000150	K	2020-07-05 → 36M → 2023-07-05
17	Open Switch and Control Platform	Rohde & Schwarz	OSP200 Base Unit 2HU	101748	LAB000149	NE	–
18	Antenna	Rohde & Schwarz	HL562E	102001	LAB000123	K	2020-07-05 → 36M → 2023-07-05
19	Antenna	Rohde & Schwarz	HFH2-Z2E - Active Loop Antenna	100954	LAB000108	K	2020-03-25 → 36M → 2023-03-25

8.2 Fully Anechoic Chamber

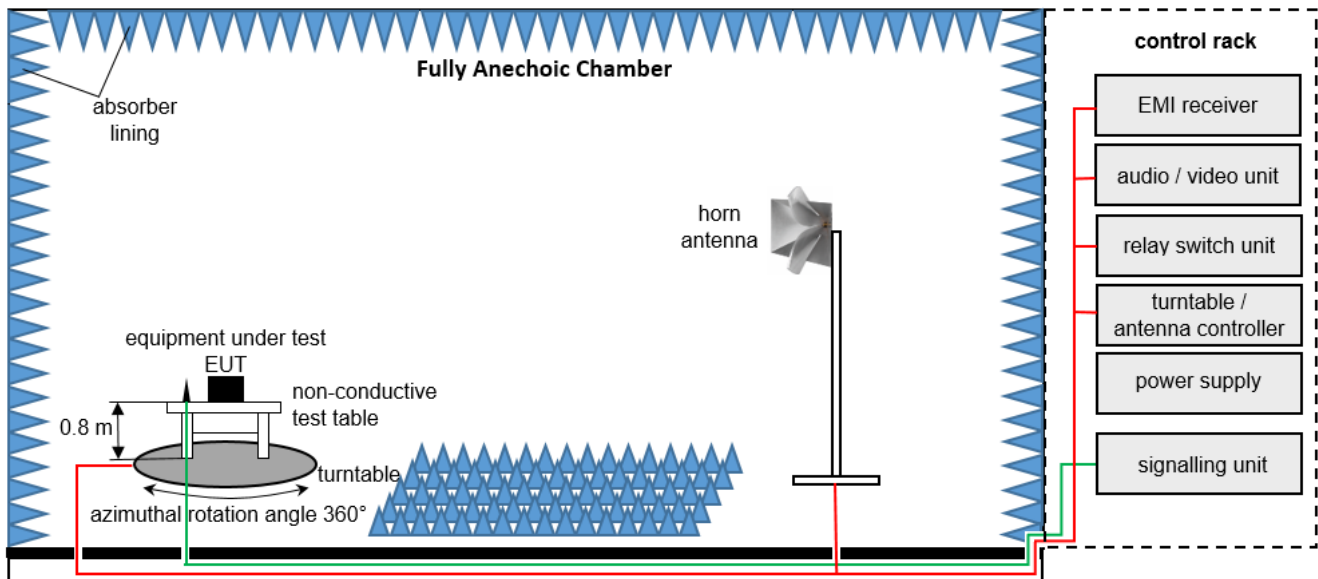

Measurement distance: tri-log antenna and horn antenna 3 meter; loop antenna 3 meter / 1 meter
EMC32 software version: 11.00.00

$$FS = UR + CA + AF$$

(FS-field strength; UR-voltage at the receiver; CA-loss of the signal path; AF-antenna factor)

Example calculation:

$$FS [dB\mu V/m] = 40.0 [dB\mu V/m] + (-35.8) [dB] + 32.9 [dB/m] = 37.1 [dB\mu V/m] (71.61 \mu V/m)$$

List of test equipment used:

No.	Equipment	Manufacturer	Type	Serial No.	IBL No.	Kind of Calibration	Calibration
1	EMI Test Receiver	Rohde & Schwarz	ESW26	101517	LAB000363	K	2021-02-05 → 12M → 2022-02-05
2	Power Supply	Elektro-Automatik GmbH & Co. KG	EA-PSI 9080-40 T	2000230001	LAB000313	NE	-
3	Test table	innco systems GmbH	PT1208-080-RH	-	LAB000306	NE	-
4	Power Supply	Chroma	61604	616040005416	LAB000285	NE	-
5	Positioner	mature GmbH	TD 1.5-10KG	-	LAB000258	NE	-
6	Compressed Air	Implotex	1-850-30	-	LAB000256	NE	-
7	Semi-Anechoic Chamber (SAC)	Albatross Projects GmbH	Babylon 5 (SAC 5)	20168.PRB	LAB000235	ZW	2020-08-24 → 36M → 2023-08-24
8	Measurement Software	Rohde & Schwarz	EMC32 V11.00.10	-	LAB000226	NE	-
9	Turntable	mature GmbH	TT2.0-2t	TT2.0-2t/921	LAB000225	NE	-
10	Antenna Mast	mature GmbH	BAM4.5-P	BAM4.5-P/272	LAB000223	NE	-
11	Controller	mature GmbH	FCU 3.0	10082	LAB000222	NE	-
12	Power Supply	Elektro-Automatik GmbH & Co. KG	EA-PS 2042-10 B	2878350292	LAB000191	NE	-
13	Pre-Amplifier	Schwarzbeck Mess-Elektronik OHG	BBV 9718 C	84	LAB000169	NE	-
14	Antenna	Rohde & Schwarz	HF907	102899	LAB000151	K	2020-04-23 → 36M → 2023-04-23
15	Open Switch and Control Platform	Rohde & Schwarz	OSP200 Base Unit 2HU	101748	LAB000149	NE	-
16	Antenna	Rohde & Schwarz	HF907	102898	LAB000124	K	2020-04-23 → 36M → 2023-04-23

8.3 Radiated measurements > 18 GHz

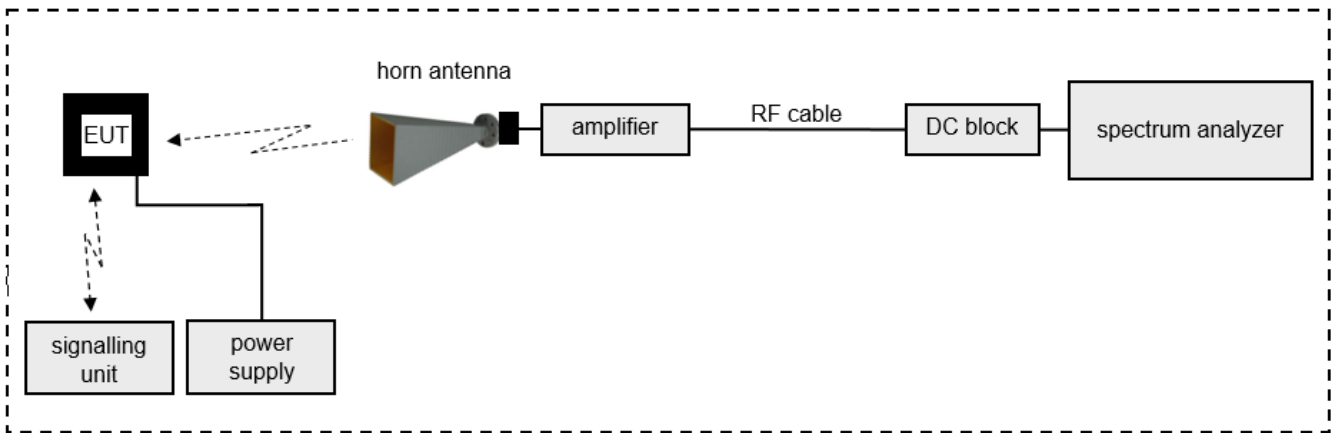

8.4 Radiated measurements > 50 GHz

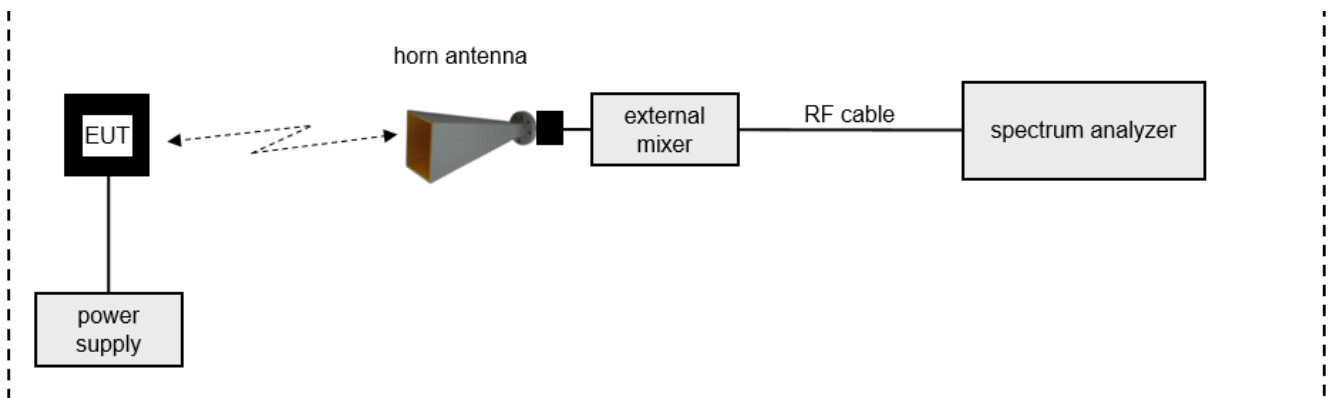

8.5 Radiated measurements under extreme conditions

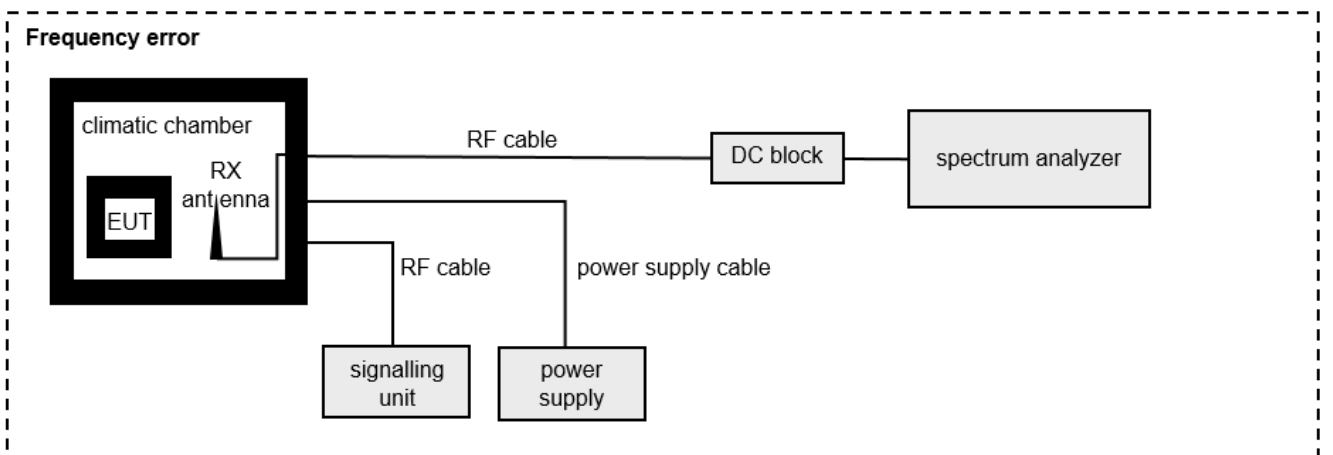

$$\text{ROP} = \text{AV} + \text{D} - \text{G}$$

(ROP-rad. output power; AV-analyzer value; D-free field attenuation of measurement distance; G-antenna gain)

Example calculation:

$$\text{ROP [dBm]} = -54.0 \text{ [dBm]} + 64.0 \text{ [dB]} - 20.0 \text{ [dBi]} = -10 \text{ [dBm]} \text{ (100 } \mu\text{W)}$$

Note: conversion loss of mixer is already included in analyzer value.

List of test equipment used:

No.	Equipment	Manufacturer	Type	Serial No.	IBL No.	Kind of Calibration	Calibration
1	Test table	innco systems GmbH	PT0707-RH light	-	LAB000303	NE	-
2	Power Supply	Elektro-Automatik GmbH & Co. KG	EA-PS 2042-10 B	2878350255	LAB000189	NE	-
3	WG-Coax-Adapter	Flann Microwave Ltd	23373-TF30 UG383/U	273385	LAB000185	ZW	2020-07-01 → 36M → 2023-07-01
4	WG-Coax-Adapter	Flann Microwave Ltd	22093-TF30 UG599/U	273263	LAB000183	ZW	2020-07-01 → 36M → 2023-07-01
5	WG-Coax-Adapter	Flann Microwave Ltd	20093-TF30 UBR220	273374	LAB000181	ZW	2020-07-01 → 36M → 2023-07-01
6	Antenna	Flann Microwave Ltd	30240-20	273390	LAB000178	ZW	2020-08-01 → 36M → 2023-08-01
7	Coaxial Cable	Huber & Suhner	SF101/1.0m	503990/1	LAB000164	ZW	2020-06-05 → 24M → 2022-06-05
8	Coaxial Cable	Rosenberger	LU7-022-1000	34	LAB000154	NE	-
9	Coaxial Cable	Rosenberger	LU7-022-1000	33	LAB000153	NE	-
10	Antenna	Flann Microwave Ltd	32240-20	273469	LAB000152	ZW	2020-08-01 → 36M → 2023-08-01
11	Antenna	Flann Microwave Ltd	29240-20	273382	LAB000139	ZW	2020-08-01 → 36M → 2023-08-01
12	Antenna	Flann Microwave Ltd	27240-20	273367	LAB000137	ZW	2020-08-01 → 36M → 2023-08-01
13	Antenna	Flann Microwave Ltd	26240-20	273417	LAB000135	ZW	2020-08-01 → 36M → 2023-08-01
14	Antenna	Flann Microwave Ltd	25240-20	272860	LAB000133	ZW	2020-07-01 → 36M → 2023-07-01
15	Antenna	Flann Microwave Ltd	23240-20	273430	LAB000132	ZW	2020-07-01 → 36M → 2023-07-01
16	Antenna	Flann Microwave Ltd	22240-20	270448	LAB000130	K	2020-06-29 → 36M → 2023-06-29
17	Antenna	Flann Microwave Ltd	20240-20	266403	LAB000128	K	2020-06-29 → 36M → 2023-06-29
18	Harmonic Mixer	Rohde & Schwarz	FS-Z170	100996	LAB000126	G	2021-05-18 → 12M → 2022-05-18
19	Harmonic Mixer	Rohde & Schwarz	FS-Z325	101015	LAB000117	K	2021-05-19 → 12M → 2022-05-19
20	Harmonic Mixer	Rohde & Schwarz	FS-Z220	101039	LAB000116	K	2021-05-18 → 12M → 2022-05-18
21	Harmonic Mixer	Rohde & Schwarz	FS-Z110	102000	LAB000114	K	2021-04-07 → 12M → 2022-04-07
22	Harmonic Mixer	Rohde & Schwarz	FS-Z090	102020	LAB000113	K	2021-03-31 → 12M → 2022-03-31
23	Harmonic Mixer	Rohde & Schwarz	FS-Z075	102015	LAB000112	K	2021-03-31 → 12M → 2022-03-31
24	Spectrum Analyser	Rohde & Schwarz	FSW50	101450	LAB000111	K	2021-07-22 → 12M → 2022-07-22
25	Climatic Chamber	CTS GmbH	T-65/50	204002	LAB000110	ZW	2021-06-18 → 12M → 2022-06-18
26	Antenna Mast	Schwarzbeck Mess-Elektronik OHG	AM 9104	99	LAB000109	NE	-

9 Measurement procedures

9.1 Radiated spurious emissions from 9 kHz to 30 MHz

Test setup

- The EUT is set up according to its intended use, as described in the user manual or as defined by the manufacturer.
- In case of floor standing equipment, it is placed in the middle of the turn table.
In case of tabletop equipment it is placed on a non-conductive table with a height of 80 cm.
- Additional equipment, cables, ... necessary for testing, are positioned like under normal operation.
- Interface cables, e.g. power supply, network, ... are connected to the connection box in the turn table.
- EUT is powered on and set into operation.

Pre-scan

- Turntable performs an azimuthal rotation from 0° to 315° in 45° steps.
- For each turntable step the EMI-receiver/spectrum analyser performs a positive-peak/max-hold sweep (=worst-case). Data is transferred to EMI-software and recorded. EMI-software will show the maximum level of all single sweeps as the final result for the pre-scan.

Final measurement

- Significant emissions found during the pre-scan will be maximized by the EMI-software by rotating the turntable from 0° to 360°.
- Loop antenna is rotated with special 3D adapter set to find maximum level of emissions.
- Plot of the pre-scan with frequencies of identified emissions including levels, correction factors, turn table position and settings of measuring equipment is recorded.

Distance correction (extrapolation)

- When performing measurements on test distances other than defined in the rules, the results shall be extrapolated to the specified distance by conservatively presuming that the field strength decays at 40 dB/decade of distance in the region closer than λ in m divided by 2π (i.e., $\lambda/2\pi$), and at 20 dB/decade of distance beyond that, using the measurement of a single point at the radial angle that produces the maximum emission.
This correction is already included in the limit line of corresponding measurement plots.

Detailed requirements can be found in e.g. ANSI C63.4 / C63.26

9.2 Radiated spurious emissions from 30 MHz to 1 GHz

Test setup

- The EUT is set up according to its intended use, as described in the user manual or as defined by the manufacturer.
- In case of floor standing equipment, it is placed in the middle of the turn table.
In case of tabletop equipment it is placed on a non-conductive table with a height of 80 cm.
- Additional equipment, cables, ... necessary for testing, are positioned like under normal operation.
- Interface cables, e.g. power supply, network, ... are connected to the connection box in the turn table.
- EUT is powered on and set into operation.

Pre-scan

- Turntable performs an azimuthal rotation from 0° to 315° in 45° steps.
- Antenna polarisation is changed (H-V / V-H) and antenna height is changed from 1 meter to 4 meters.
- For each turntable step / antenna polarisation / antenna height the EMI-receiver/spectrum analyser performs a positive-peak/max-hold sweep (=worst-case). Data is transferred to EMI-software and recorded. EMI-software will show the maximum level of all single sweeps as the final result for the pre-scan.

Final measurement

- Significant emissions found during the pre-scan will be maximized by the EMI-software based on evaluated data during the pre-scan by rotating the turntable and changing antenna height and polarisation.
- Final measurement will be performed with measuring equipment settings as defined in the applicable test standards (e.g. ANSI C6.4).
- Plot of the pre-scan with frequencies of identified emissions including levels, correction factors, turn table position, antenna polarisation and settings of measuring equipment is recorded.

Distance correction (extrapolation)

- When performing measurements on test distances other than defined in the rules, the results shall be extrapolated to the specified distance by conservatively presuming that the field strength decays at 20 dB/decade of distance beyond the region λ in m divided by 2π (i.e., $\lambda/2\pi$), using the measurement of a single point at the radial angle that produces the maximum emission.
This correction is already included in the corresponding measurement plots.

Detailed requirements can be found in e.g. ANSI C63.4 / C63.26

9.3 Radiated spurious emissions from 1 GHz to 18 GHz

Test setup

- The EUT is set up according to its intended use, as described in the user manual or as defined by the manufacturer.
- In case of floor standing equipment, it is placed in the middle of the turn table.
In case of tabletop equipment it is placed on a non-conductive table with a height of 80 cm.
- Additional equipment, cables, ... necessary for testing, are positioned like under normal operation.
- Interface cables, e.g. power supply, network, ... are connected to the connection box in the turn table.
- EUT is powered on and set into operation.

Pre-scan

- Turntable performs an azimuthal rotation from 0° to 315° in 45° steps.
- Antenna polarisation is changed (H-V / V-H) and antenna height is changed from 1 meter to 4 meters.
- For each turntable step / antenna polarisation / antenna height the EMI-receiver/spectrum analyser performs a positive-peak/max-hold sweep (=worst-case). Data is transferred to EMI-software and recorded. EMI-software will show the maximum level of all single sweeps as the final result for the pre-scan.

Final measurement

- Significant emissions found during the pre-scan will be maximized by the EMI-software based on evaluated data during the pre-scan by rotating the turntable and changing antenna height and polarisation.
- Final measurement will be performed with measuring equipment settings as defined in the applicable test standards (e.g. ANSI C6.4).
- Plot of the pre-scan with frequencies of identified emissions including levels, correction factors, turn table position, antenna polarisation and settings of measuring equipment is recorded.

Distance correction (extrapolation)

- When performing measurements on test distances other than defined in the rules, the results shall be extrapolated to the specified distance by conservatively presuming that the field strength decays at 20 dB/decade of distance beyond the region λ in m divided by 2π (i.e., $\lambda/2\pi$), using the measurement of a single point at the radial angle that produces the maximum emission.
This correction is already included in the corresponding measurement plots.

Detailed requirements can be found in e.g. ANSI C63.4 / C63.26

9.4 Radiated spurious emissions above 18 GHz

Test setup

- The EUT is set up according to its intended use, as described in the user manual or as defined by the manufacturer.
- Additional equipment, cables, ... necessary for testing, are positioned like under normal operation.
- EUT is powered on and set into operation.
- Test distance depends on EUT size and test antenna size (farfield conditions shall be met).

Pre-scan

- The test antenna is handheld and moved carefully over the EUT to cover the EUT's whole sphere and for different polarizations of the antenna.

Final measurement

- Significant emissions found during the pre-scan will be maximized, i.e. position and antenna orientation causing the highest emissions with Peak and RMS detector
- Final measurement will be performed with measuring equipment settings as defined in the applicable test standards (e.g. ANSI C63.4 / C63.26).
- Final plot showing measurement data, levels, frequency, measuring time, bandwidth, correction factor, margin to the limit and limit is recorded.

Note

- In case of measurements with external harmonic mixers (e.g. above 50 GHz) special care is taken to avoid possible overloading of the external mixer's input.
- As external harmonic mixers may generate false images, care is taken to ensure that any emission measured by the spectrum analyzer is indeed radiated from the EUT and not internally generated by the external harmonic mixer. Signal identification feature of spectrum analyzer is used to eliminate/reduce images of the external harmonic mixer.

Distance correction (extrapolation)

- When performing measurements on test distances other than defined in the rules, the results shall be extrapolated to the specified distance by conservatively presuming that the field strength decays at 20 dB/decade of distance beyond the region λ in m divided by 2π (i.e., $\lambda/2\pi$), using the measurement of a single point at the radial angle that produces the maximum emission.
This correction is already included in the corresponding measurement plots.

Detailed requirements can be found in e.g. ANSI C63.4 / C63.26

10 MEASUREMENT UNCERTAINTIES

Radio frequency	$\leq \pm 10$ ppm
Radiated emission	$\leq \pm 6$ dB
Temperature	$\leq \pm 1$ °C
Humidity	$\leq \pm 5$ %
DC and low frequency voltages	$\leq \pm 3$ %

The indicated expanded measurement uncertainty corresponds to the standard measurement uncertainty for the measurement results multiplied by the coverage factor $k = 2$. It was determined in accordance with EA-4/01 m:2013. The true value is located in the corresponding interval with a probability of 95 %.