



Hermon Laboratories Ltd.
Harakevet Industrial Zone, Binyamina 30500,
Israel
Tel. +972-4-6288001
Fax. +972-4-6288277
E-mail: mail@hermonlabs.com

TEST REPORT

ACCORDING TO: FCC CFR 47 PART 90, section 90.219

FOR:

Axell Wireless Israel Ltd.

High power repeater

Model: D-SBR4008-PS-NFPA-24-DC-CLASS-B

FCC ID:NEODSBR4008PSB

This report is in conformity with ISO/ IEC 17025. The "A2LA Accredited" symbol endorsement applies only to the tests and calibrations that are listed in the scope of Hermon Laboratories accreditation. The test results relate only to the items tested.
This test report shall not be reproduced in any form except in full with the written approval of Hermon Laboratories Ltd.

Table of contents

1	Applicant information	3
2	Equipment under test attributes	3
3	Manufacturer information	3
4	Test details	3
5	Tests summary	4
6	EUT description	5
6.1	General information	5
6.2	EUT options/configurations	5
6.3	Ports and lines	5
6.4	Support and test equipment	5
6.5	Test configuration	6
6.6	Transmitter characteristics	7
7	Transmitter tests	8
7.1	Automatic gain control (AGC) threshold test for PLMRS/PSRS	8
7.2	Input/output power and booster gain test for PLMRS/PSRS	15
7.3	Out-of-band rejection test for for PLMRS/PSRS	32
7.4	Emission mask test	35
7.5	Noise figure test	61
7.6	Radiated spurious emission measurements for PLMRS/PSRS	64
7.7	Spurious emissions at RF antenna connector test for PLMRS/PSRS	71
7.8	ERP intermodulation product test	77
8	APPENDIX A Test equipment and ancillaries used for tests	89
8.1	Test equipment and ancillaries used for tests	90
9	APPENDIX B Measurement uncertainties	91
10	APPENDIX C Test facility description	92
11	APPENDIX D Specification references	92
12	APPENDIX E Test equipment correction factors	93
13	APPENDIX F Abbreviations and acronyms	109

1 Applicant information

Client name: Axell Wireless Israel Ltd.
Address: 6 Bareket street, Petach Tikva 49002, Israel
Telephone: +972 3918 0180
Fax: +972 3918 0190
E-mail: alex.garkin@axellwireless.com
Contact name: Mr. Alexander Garkin

2 Equipment under test attributes

Product name: High power repeater
Product type: Booster
Model(s): D-SBR4008-PS-NFPA-24-DC-CLASS-B
Part number: DSBR011
Serial number: 16038001
Hardware version: DMBR024_Rev1A
Software release: File System: 24_03_15
CCD Application: 6.2.2
Receipt date 06-Mar-16

3 Manufacturer information

Manufacturer name: Axell Wireless Israel Ltd.
Address: 6 Bareket street, Petach Tikva 49002, Israel
Telephone: +972 3918 0180
Fax: +972 3918 0190
E-Mail: alex.garkin@axellwireless.com
Contact name: Mr. Alexander Garkin

4 Test details



Project ID: 28127
Location: Hermon Laboratories Ltd. Harakevet Industrial Zone, Binyamina 30500, Israel
Test started: 23-Feb-16
Test completed: 6-Jun-16
Test specification(s): 47CFR part 90, section 90.219

5 Tests summary

Test	Status
Transmitter characteristics	
Section 90.219(e)(1), Automatic gain control (AGC) threshold	Pass
Section 90.219(e)(1), Radiated output power	Pass
Section 90.219(a), Occupied bandwidth	Pass
Sections 90.210(b), 90.210(h), Emission mask	Pass
Section 90.219(e)(2) Noise figure	Pass
Section 90.219(e)(3), Radiated spurious emissions	Pass
Section 90.219(e)(3), Conducted spurious emissions	Pass
Section 2.1091, RF radiation exposure evaluation	Pass, exhibit provided in Application for certification

Testing was completed against all relevant requirements of the test standard. The results obtained indicate that the product under test complies in full with the requirements tested.
The test results relate only to the items tested. Pass/ fail decision was based on nominal values.

This test report supersedes the previously issued test report identified by Doc ID:AXERAD_FCC.28127.

	Name and Title	Date	Signature
Tested by:	Mr. S. Samokha, test engineer	June 6, 2016	
Reviewed by:	Mrs. M. Cherniavsky, certification engineer	July 10, 2016	
Approved by:	Mr. M. Nikishin, EMC and Radio group manager	October 27, 2016	

6 EUT description

6.1 General information

The EUT, D-SBR4008-PS-NFPA-24-DC-CLASS-B is a high-power digital multi-channel signal booster (DCSB) that features an array of up to 12 DSP based, softwarecontrolled, variable bandwidth filters, user-programmable across the 800 MHz bands.

The D-SBR4008-PS-NFPA-24-DC-CLASS-B supports all public safety technologies. In addition to specifying the centre frequency of each filter, the user can select a filter from a drop down list that has several choices for each pass band that vary in time delay and filter slope. This gives the engineer the unique ability to trade off the adjacent channel rejection and time delay interference for the coverage area permitting the use of the D-SBR4008-PS-NFPA-24-DC-CLASS-B in applications where no other booster solution will work.

Every parameter of D-SBR4008-PS-NFPA-24-DC-CLASS-B including filter tuning and selection, is software controlled via Web management. The patented Axell Wireless' digital RF filter not only enables simple initial setup for any channel plan, but if necessary even permits a simple reconfiguration because of re-banding.

This test report represents test results for PLMRS/PSRS booster part.

6.2 EUT options/configurations

Number	Operating mode description	Configuration
1	Transmit 851-862 MHz, Downlink	1
2	Transmit 806-817 MHz, Uplink	2

6.3 Ports and lines

Port type	Port description	Connected from	Connected to	Qty.	Cable type	Cable length, m
Power	AC	AC mains	AC/DC adapter	1	Unshielded	1.5
Power	DC	AC/DC adapter	EUT	1	Unshielded	0.3
Signal	Ethernet	EUT	PC	1	UTP	5
Signal	Antenna	EUT	Antenna	2	Coax	NA
Signal	Alarm I/O	EUT	OC	1	Unshielded	3

6.4 Support and test equipment

Description	Manufacturer	Model number	Serial number
Laptop	DELL	PP20L	5QXF83G
AC/DC adapter	DELL	LA65N80	0DF263-71615-7QF-E850
Mouse	Logitech	810-001317	NA



6.5 Test configuration

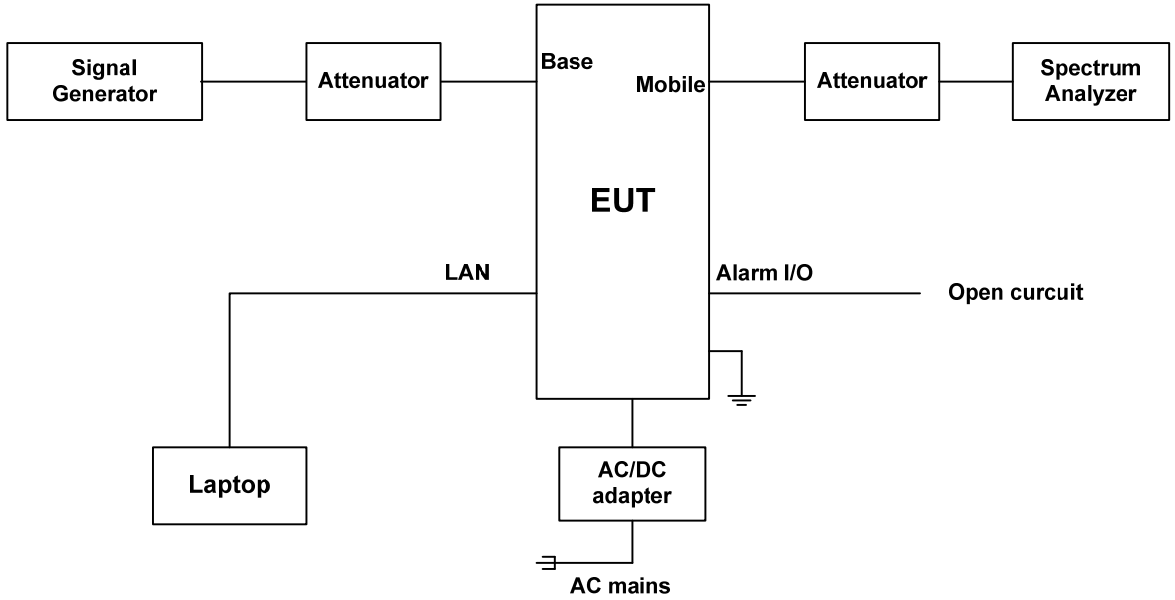



6.6 Transmitter characteristics

Type of equipment				
V	Stand-alone (Equipment with or without its own control provisions)			
	Combined equipment (Equipment where the radio part is fully integrated within another type of equipment)			
	Plug-in card (Equipment intended for a variety of host systems)			
Intended use		Condition of use		
V	fixed	Always at a distance more than 2 m from all people		
	mobile	Always at a distance more than 20 cm from all people		
	portable	May operate at a distance closer than 20 cm to human body		
Assigned frequency range		DL 851-862 MHz; UL 806 – 817 MHz		
Maximum rated output power		At maximum gain, Output port	DL: 40 dBm each band UL: 28 dBm each band	
Is transmitter output power variable?	No			
	V	Yes	continuous variable	
			V stepped variable with stepsize	1.0 dB
			minimum RF power	NA
			maximum RF power	DL: 40 dBm UL: 28 dBm
Antenna connection				
unique coupling	V	standard connector	Integral with temporary RF connector without temporary RF connector	
Antenna/s technical characteristics				
Type	Manufacturer	Model number	Antenna gain, dBi	
External (Indoor)	Galtronics	02121261-05542	1.5-3.5	
External (Indoor)	Galtronics	PEAR S4935i	1.5-2.5	
External (Outdoor)	Galtronics	PEAR S5591i	5	
Transmitter aggregate data rate/s, Mbps				
Transmitter 99% power bandwidth	Type of modulation			
	C4FM	iDEN QAM	Analog FM	
	9.6 kbps	64 kbps	9.6 kbps	
Type of multiplexing				
Modulating test signal (baseband)				
Maximum transmitter duty cycle in normal use				
Transmitter power source				
V	DC	Nominal rated voltage	From 120 VAC via AC/DC adapter	
	AC	Nominal rated voltage		
Common power source for transmitter and receiver		V	yes no	



Test specification: Section 90.219(e)(1) AGC threshold test for PLMRS/PSRS			
Test procedure: KDB 935210 D05 v01r01, section 4			
Test mode: Compliance		Verdict: PASS	
Date(s): 17-Mar-16 - 29-Mar-16			
Temperature: 23.2 °C	Relative Humidity: 48 %	Air Pressure: 1015 hPa	Power supply: 120 VAC
Remarks:			

7 Transmitter tests

7.1 Automatic gain control (AGC) threshold test for PLMRS/PSRS

7.1.1 General

This test was performed to measure the peak output power at RF antenna connector. Specification test limits are given in Table 7.1.1.

Table 7.1.1 ERP limits

Assigned frequency range, MHz	Maximum ERP	
	W	dBm
851.0 – 862.0	5.0	37.0
806.0 – 817.0	5.0	37.0

7.1.2 Test procedure

7.1.2.1 The EUT was set up as shown in Figure 7.1.1, energized and its proper operation was checked.

7.1.2.2 The EUT was adjusted to produce maximum available to the end user RF output power.

7.1.2.3 The peak output power was measured with spectrum analyzer as provided in Table 7.1.2 to Table 7.1.5 and associated plots.

Figure 7.1.1 AGC threshold test setup

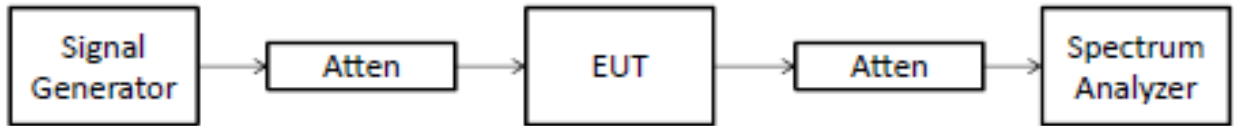



Test specification: Section 90.219(e)(1) AGC threshold test for PLMRS/PSRS			
Test procedure: KDB 935210 D05 v01r01, section 4			
Test mode: Compliance		Verdict: PASS	
Date(s): 17-Mar-16 - 29-Mar-16			
Temperature: 23.2 °C	Relative Humidity: 48 %	Air Pressure: 1015 hPa	Power supply: 120 VAC
Remarks:			

Table 7.1.2 AGC threshold test results

DETECTOR USED: Average
MEASUREMENT METHOD: Spectrum Analyzer
MODULATING SIGNAL: CW
CONFIGURATION: Single Channel

OPERATING FREQUENCY RANGE: 851 - 862 MHz (downlink)
806 - 817 MHz (uplink)

Frequency, MHz	Input port	Input level, dBm	Power meter reading, dBm*	AGC threshold level, dBm	Margin, dB	Verdict
Downlink transmit mode						
856.0	Base	-56.10	39.53	-56.10	NA	Pass
Uplink transmit mode						
811.0	Mobile	-69.82	26.72	-69.82	NA	Pass

*Note: In DAS system, we suppose a loss due to cable insertion, splitter, etc, about of 12 dB. There are no specific antennas supplied as a part of the unit that is why the maximum antenna assembly gain in dBd shall not exceed the value in -3 dB.

Table 7.1.3 AGC threshold test results

DETECTOR USED: Average
MEASUREMENT METHOD: Spectrum Analyzer
MODULATING SIGNAL: C4FM
CONFIGURATION: Single Channel

OPERATING FREQUENCY RANGE: 851 - 862 MHz (downlink)
806 - 817 MHz (uplink)

Frequency, MHz	Input port	Input level, dBm	Power meter reading, dBm*	AGC threshold level, dBm	Margin, dB	Verdict
Downlink transmit mode						
856.0	Base	-56.12	39.50	-56.12	NA	Pass
Uplink transmit mode						
811.0	Mobile	-69.85	26.37	-69.85	NA	Pass

*Note: In DAS system, we suppose a loss due to cable insertion, splitter, etc, about of 12 dB. There are no specific antennas supplied as a part of the unit that is why the maximum antenna assembly gain in dBd shall not exceed the value in -3 dB.



Test specification: Section 90.219(e)(1) AGC threshold test for PLMRS/PSRS			
Test procedure: KDB 935210 D05 v01r01, section 4			
Test mode: Compliance		Verdict: PASS	
Date(s): 17-Mar-16 - 29-Mar-16			
Temperature: 23.2 °C	Relative Humidity: 48 %	Air Pressure: 1015 hPa	Power supply: 120 VAC
Remarks:			

Table 7.1.4 AGC threshold test results

DETECTOR USED: Average
MEASUREMENT METHOD: Spectrum Analyzer
MODULATING SIGNAL: iDEN QAM
CONFIGURATION: Single Channel

OPERATING FREQUENCY RANGE: 851 - 862 MHz (downlink)
06 - 817 MHz (uplink)

Frequency, MHz	Input port	Input level, dBm	Power meter reading, dBm*	AGC threshold level, dBm	Margin, dB	Verdict
Downlink transmit mode						
856.0	Base	-56.21	37.22	-56.21	NA	Pass
Uplink transmit mode						
811.0	Mobile	-70.29	25.38	-70.29	NA	Pass

*Note: In DAS system, we suppose a loss due to cable insertion, splitter, etc, about of 12 dB. There are no specific antennas supplied as a part of the unit that is why the maximum antenna assembly gain in dBd shall not exceed the value in -3 dB.

Table 7.1.5 AGC threshold test results

DETECTOR USED: Average
MEASUREMENT METHOD: Spectrum Analyzer
MODULATING SIGNAL: Analog FM 10.0 kHz/1 kHz
CONFIGURATION: Single Channel

OPERATING FREQUENCY RANGE: 851 - 862 MHz (downlink)
806 - 817 MHz (uplink)

Frequency, MHz	Input port	Input level, dBm	Power meter reading, dBm*	AGC threshold level, dBm	Margin, dB	Verdict
Downlink transmit mode						
856.0	Base	-56.08	39.18	-56.08	NA	Pass
Uplink transmit mode						
811.0	Mobile	-69.80	26.80	-69.80	NA	Pass

*Note: In DAS system, we suppose a loss due to cable insertion, splitter, etc, about of 12 dB. There are no specific antennas supplied as a part of the unit that is why the maximum antenna assembly gain in dBd shall not exceed the value in -3 dB.

Reference numbers of test equipment used

HL 0539	HL 1876	HL 2909	HL 3779	HL 3787	HL 3903	HL 4273	HL 4275
HL 4364							

Full description is given in Appendix A.



HERMON LABORATORIES

Test specification: Section 90.219(e)(1) AGC threshold test for PLMRS/PSRS			
Test procedure: KDB 935210 D05 v01r01, section 4			
Test mode: Compliance		Verdict: PASS	
Date(s): 17-Mar-16 - 29-Mar-16			
Temperature: 23.2 °C	Relative Humidity: 48 %	Air Pressure: 1015 hPa	Power supply: 120 VAC
Remarks:			

Plot 7.1.1 AGC threshold test results at mid frequency carrier, Port 1

FREQUENCY RANGE:
OPERATIONAL MODE:
CONFIGURATION:
INPUT PORT:
INPUT POWER: -56 dBm

851 - 862 MHz
CW downlink transmit
Single Channel
Base
OUTPUT POWER:

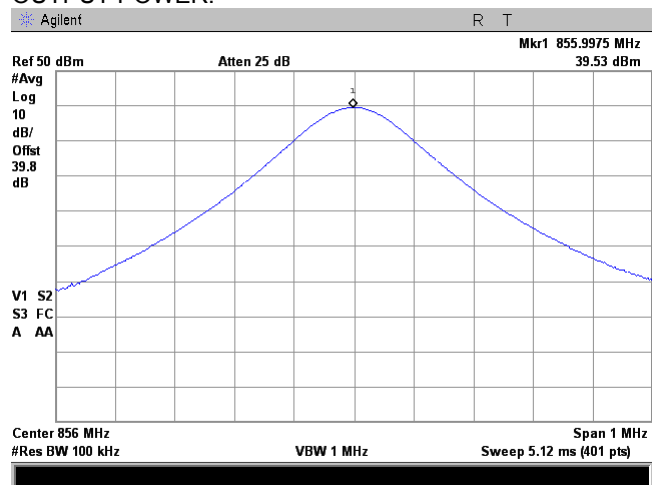
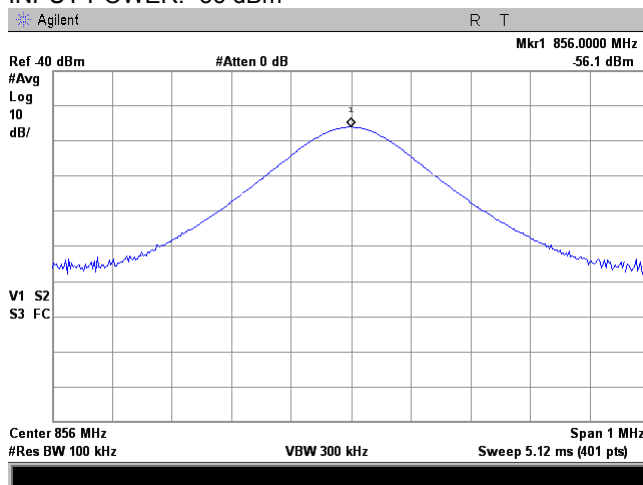

Plot 7.1.2 AGC threshold test results at mid frequency carrier, Port 1

FREQUENCY RANGE:
OPERATIONAL MODE:
CONFIGURATION:
INPUT PORT:
INPUT POWER: -56 dBm

851 - 862 MHz
C4FM downlink transmit
Single Channel
Base
OUTPUT POWER:

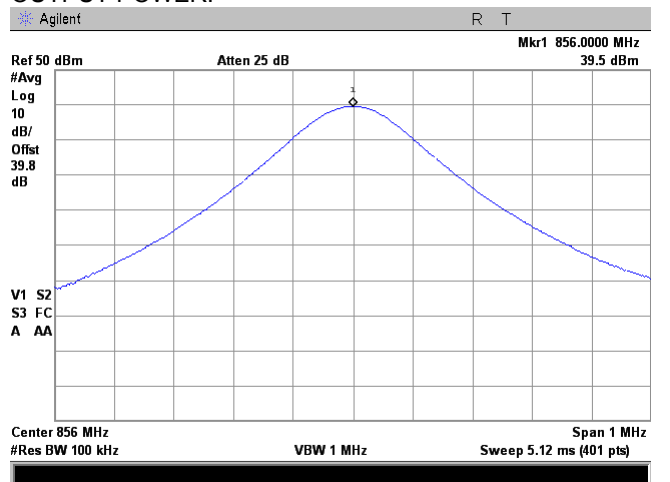
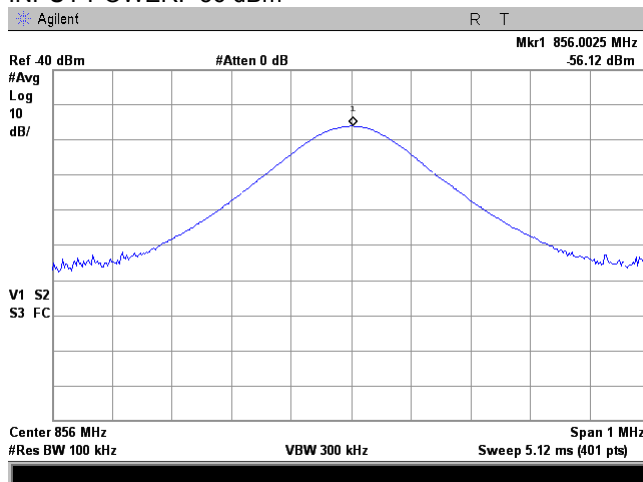



HERMON LABORATORIES

Test specification: Section 90.219(e)(1) AGC threshold test for PLMRS/PSRS			
Test procedure: KDB 935210 D05 v01r01, section 4			
Test mode: Compliance		Verdict: PASS	
Date(s): 17-Mar-16 - 29-Mar-16			
Temperature: 23.2 °C	Relative Humidity: 48 %	Air Pressure: 1015 hPa	Power supply: 120 VAC
Remarks:			

Plot 7.1.3 AGC threshold test results at mid frequency carrier, Port 1

FREQUENCY RANGE:
OPERATIONAL MODE:
CONFIGURATION:
INPUT PORT:
INPUT POWER: -56 dBm

851 - 862 MHz
iDEN QAM downlink transmit
Single Channel
Base
OUTPUT POWER:

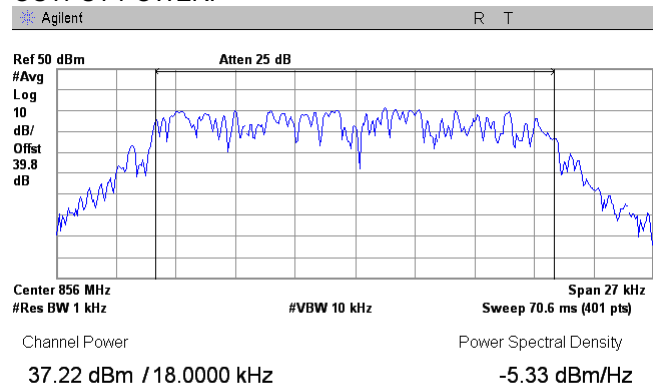
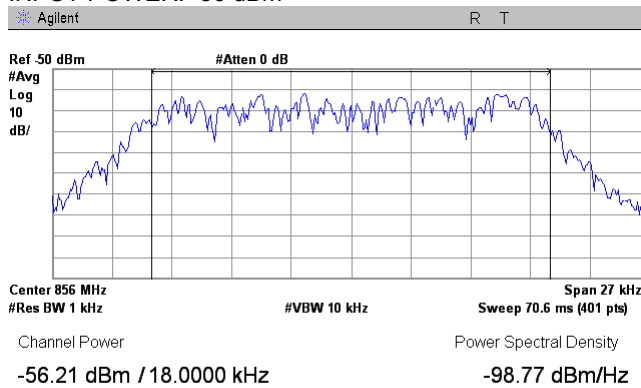

Plot 7.1.4 AGC threshold test results at mid frequency carrier, Port 2

FREQUENCY RANGE:
OPERATIONAL MODE:
CONFIGURATION:
INPUT PORT:
INPUT POWER: -56 dBm

851 - 862 MHz
Analog FM uplink transmit
Single Channel
Mobile
OUTPUT POWER:

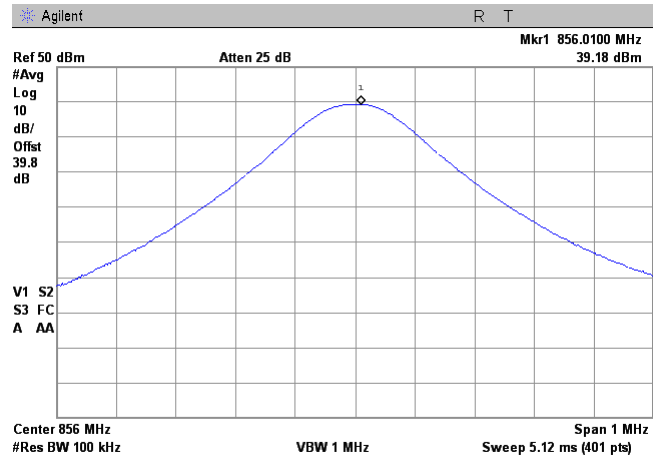
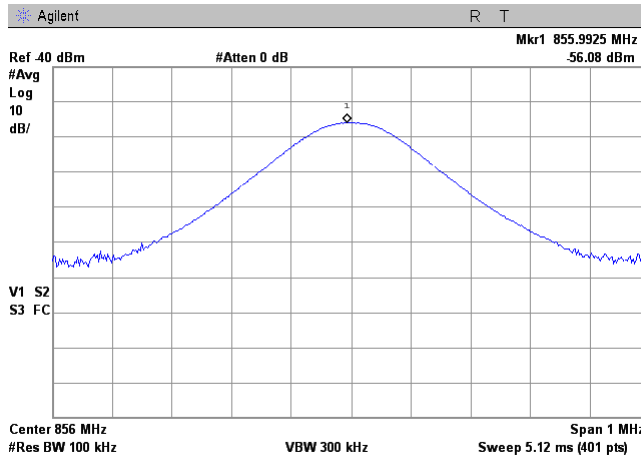



HERMON LABORATORIES

Test specification: Section 90.219(e)(1) AGC threshold test for PLMRS/PSRS			
Test procedure: KDB 935210 D05 v01r01, section 4			
Test mode: Compliance		Verdict: PASS	
Date(s): 17-Mar-16 - 29-Mar-16			
Temperature: 23.2 °C	Relative Humidity: 48 %	Air Pressure: 1015 hPa	Power supply: 120 VAC
Remarks:			

Plot 7.1.5 AGC threshold test results at mid frequency carrier, Port 2

FREQUENCY RANGE:
OPERATIONAL MODE:
CONFIGURATION:
INPUT PORT:
INPUT POWER: -70 dBm

806 - 817 MHz
CW uplink transmit
Single Channel
Mobile
OUTPUT POWER:

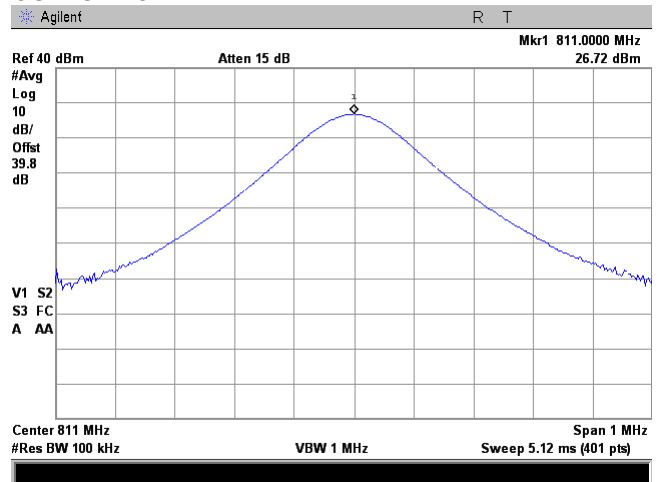
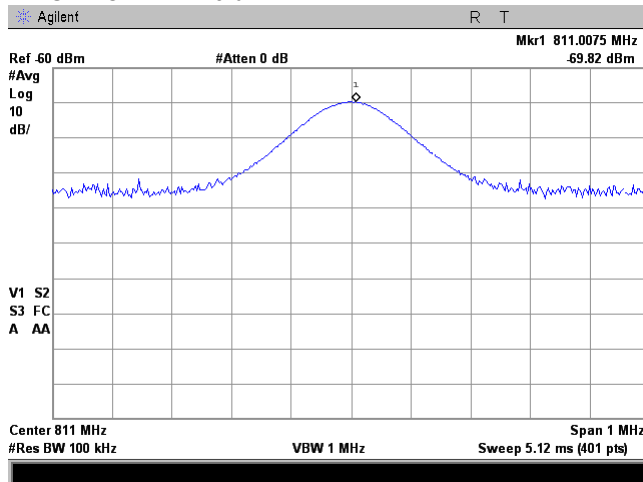

Plot 7.1.6 AGC threshold test results at mid frequency carrier, Port 2

FREQUENCY RANGE:
OPERATIONAL MODE:
CONFIGURATION:
INPUT PORT:
INPUT POWER: -70 dBm

806 - 817 MHz
C4FM uplink transmit
Single Channel
Mobile
OUTPUT POWER:

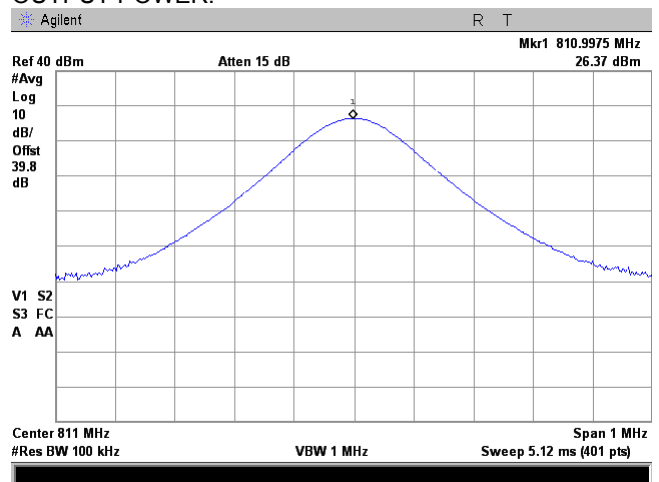
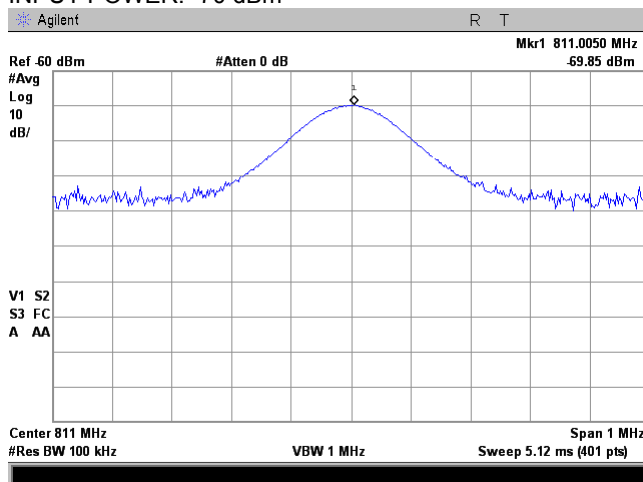



HERMON LABORATORIES

Test specification: Section 90.219(e)(1) AGC threshold test for PLMRS/PSRS			
Test procedure: KDB 935210 D05 v01r01, section 4			
Test mode: Compliance		Verdict: PASS	
Date(s): 17-Mar-16 - 29-Mar-16			
Temperature: 23.2 °C	Relative Humidity: 48 %	Air Pressure: 1015 hPa	Power supply: 120 VAC
Remarks:			

Plot 7.1.7 AGC threshold test results at mid frequency carrier, Port 2

FREQUENCY RANGE:
OPERATIONAL MODE:
CONFIGURATION:
INPUT PORT:
INPUT POWER: -70 dBm

806 - 817 MHz
iDEN QAM downlink transmit
Single Channel
Mobile
OUTPUT POWER:

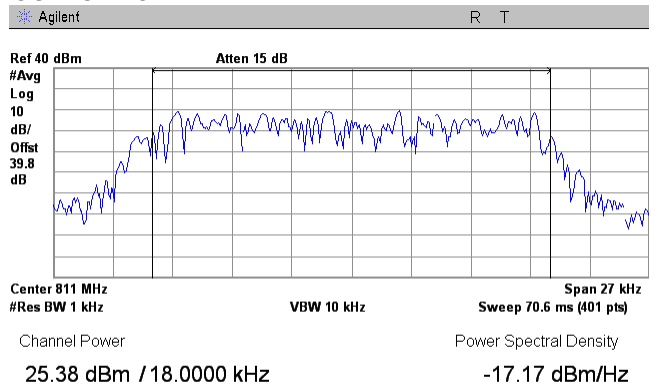
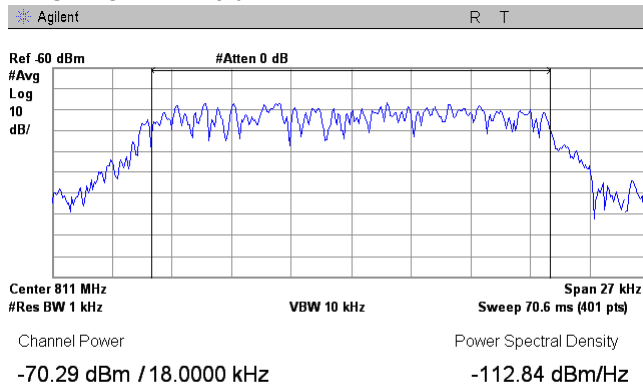

Plot 7.1.8 AGC threshold test results at mid frequency carrier, Port 2

FREQUENCY RANGE:
OPERATIONAL MODE:
CONFIGURATION:
INPUT PORT:
INPUT POWER: -70 dBm

806 - 817 MHz
Analog FM uplink transmit
Single Channel
Mobile
OUTPUT POWER:

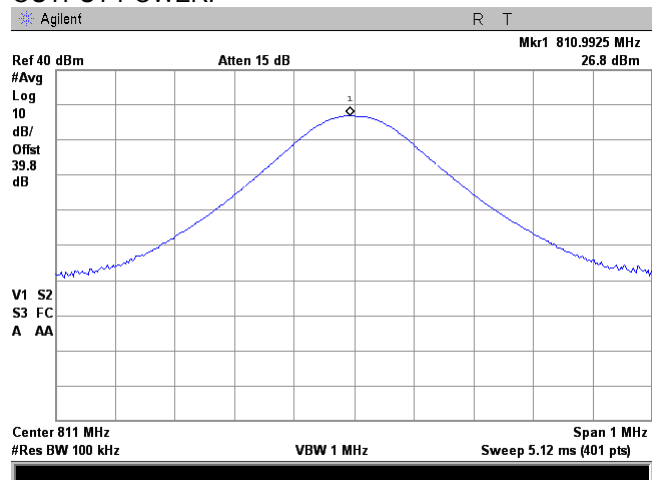
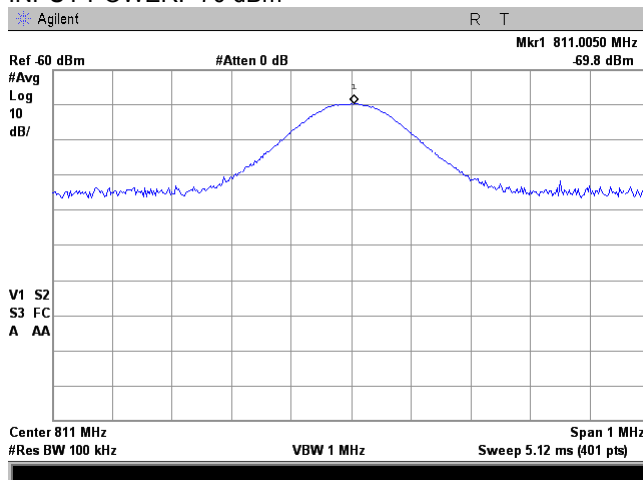



Test specification: Section 90.219(e)(1), Input/output power and booster gain test for PLMRS/PSRS			
Test procedure: KDB 935210 D05 v01r01, section 4.5			
Test mode: Compliance		Verdict: PASS	
Date(s): 17-Mar-16 - 29-Mar-16			
Temperature: 23.2 °C	Relative Humidity: 48 %	Air Pressure: 1015 hPa	Power supply: 120 VAC
Remarks:			

7.2 Input/output power and booster gain test for PLMRS/PSRS

7.2.1 General

This test was performed to measure the peak output power at RF antenna connector. Specification test limits are given in Table 7.2.1

Table 7.2.1 Input/output power and booster gain test limits

Assigned frequency range, MHz	Tested frequency range	Maximum allowed Gain versus frequency response, dB
806.0 – 817.0 851.0 – 862.0	$F_0 \pm 250\%BW$	Output power (dBm) – input power (dBm)

7.2.2 Test procedure

7.2.2.1 The EUT was set up as shown in Figure 7.2.1, energized and its proper operation was checked.

7.2.2.2 The EUT was adjusted to produce maximum available to the end user RF output power.

7.2.2.3 The peak output power was measured with spectrum analyzer as provided in Table 7.2.2 to Table 7.2.5 and the associated plots.

Figure 7.2.1 Input/output power and booster gain test setup





Test specification: Section 90.219(e)(1), Input/output power and booster gain test for PLMRS/PSRS			
Test procedure: KDB 935210 D05 v01r01, section 4.5			
Test mode: Compliance		Verdict: PASS	
Date(s): 17-Mar-16 - 29-Mar-16			
Temperature: 23.2 °C	Relative Humidity: 48 %	Air Pressure: 1015 hPa	Power supply: 120 VAC
Remarks:			

Table 7.2.2 Input/output power and booster gain test results

DETECTOR USED: Peak
 RESOLUTION BANDWIDTH: 100 kHz
 VIDEO BANDWIDTH: 300 kHz
 RF SIGNAL: CW

OPERATING FREQUENCY RANGE: 851 - 862 MHz (downlink)
 806 - 817 MHz (uplink)

Carrier frequency, MHz	Input port	SA reading, dBm		Booster gain**, dB	Antenna assembly gain***, dBd	ERP, dBm	Limit, dBm	Margin*, dB	Verdict
		Input	Output						
Downlink transmit mode									
851.0	Base	-55.62	38.95	94.57	-3.0	35.95	37.0	-1.05	Pass
856.0	Base	-55.57	39.46	95.03	-3.0	36.46	37.0	-0.54	Pass
862.0	Base	-55.50	39.19	94.69	-3.0	36.19	37.0	-0.81	Pass
Uplink transmit mode									
806.0	Mobile	-69.79	26.24	96.03	-3.0	23.24	37.0	-13.76	Pass
811.0	Mobile	-69.75	26.52	96.27	-3.0	23.52	37.0	-13.48	Pass
817.0	Mobile	-69.56	26.22	95.78	-3.0	23.22	37.0	-13.78	Pass

* - Margin = ERP – specification limit

** - Booster Gain = Output SA reading – Input SA reading

*** - ERP = Output SA reading + Gmax antenna gain (dBi) – 2.15 – Insertion loss = Pout + Antenna assembly gain (dBi) – 2.15

Where Antenna assembly gain = Gmax antenna gain (dBi) – Cable loss – Splitter loss

Note 1: In DAS system, we suppose a loss due to cable insertion, splitter, etc, about of 12 dB.

There are no specific antennas supplied as a part of the unit that is why the maximum antenna assembly gain in dBd shall not exceed the value in -3 dB.



Test specification: Section 90.219(e)(1), Input/output power and booster gain test for PLMRS/PSRS			
Test procedure: KDB 935210 D05 v01r01, section 4.5			
Test mode: Compliance		Verdict: PASS	
Date(s): 17-Mar-16 - 29-Mar-16			
Temperature: 23.2 °C	Relative Humidity: 48 %	Air Pressure: 1015 hPa	Power supply: 120 VAC
Remarks:			

Table 7.2.3 Input/output power and booster gain test results

DETECTOR USED: Average
 RESOLUTION BANDWIDTH: 100 kHz
 VIDEO BANDWIDTH: 300 kHz
 RF SIGNAL: C4FM

OPERATING FREQUENCY RANGE: 851 - 862 MHz (downlink)
 806 - 817 MHz (uplink)

Carrier frequency, MHz	Input port	SA reading, dBm		Booster gain**, dB	Antenna assembly gain***, dBd	ERP, dBm	Limit, dBm	Margin*, dB	Verdict
		Input	Output						
Downlink transmit mode									
851.0	Base	-55.70	39.00	94.70	-3.0	36.00	37.0	-1.00	Pass
856.0	Base	-55.66	39.65	95.31	-3.0	36.65	37.0	-0.35	Pass
862.0	Base	-55.51	39.19	94.70	-3.0	36.19	37.0	-0.81	Pass
Uplink transmit mode									
806.0	Mobile	-69.65	26.61	96.26	-3.0	23.61	37.0	-13.39	Pass
811.0	Mobile	-69.63	26.88	96.51	-3.0	23.88	37.0	-13.12	Pass
817.0	Mobile	-69.61	26.24	95.85	-3.0	23.24	37.0	-13.76	Pass

* - Margin = ERP – specification limit

** - Booster Gain = Output SA reading – Input SA reading

*** - ERP = Output SA reading + Gmax antenna gain (dBi) – 2.15 – Insertion loss = Pout + Antenna assembly gain (dBi) – 2.15

Where Antenna assembly gain = Gmax antenna gain (dBi) – Cable loss – Splitter loss

Note 1: In DAS system, we suppose a loss due to cable insertion, splitter, etc, about of 12 dB.

There are no specific antennas supplied as a part of the unit that is why the maximum antenna assembly gain in dBd shall not exceed the value in -3 dB.



Test specification: Section 90.219(e)(1), Input/output power and booster gain test for PLMRS/PSRS			
Test procedure: KDB 935210 D05 v01r01, section 4.5			
Test mode: Compliance		Verdict: PASS	
Date(s): 17-Mar-16 - 29-Mar-16			
Temperature: 23.2 °C	Relative Humidity: 48 %	Air Pressure: 1015 hPa	Power supply: 120 VAC
Remarks:			

Table 7.2.4 Input/output power and booster gain test results

DETECTOR USED: Average
RESOLUTION BANDWIDTH: 100 kHz
VIDEO BANDWIDTH: 300 kHz
RF SIGNAL: iDEN

OPERATING FREQUENCY RANGE: 851 - 862 MHz (downlink)
806 - 817 MHz (uplink)

Carrier frequency, MHz	Input port	SA reading, dBm		Booster gain**, dB	Antenna assembly gain***, dBd	ERP, dBm	Limit, dBm	Margin*, dB	Verdict
		Input	Output						
Downlink transmit mode									
851.0	Base	-56.63	37.35	93.98	-3.0	34.35	37.0	-2.65	Pass
856.0	Base	-56.24	37.69	93.93	-3.0	34.69	37.0	-2.31	Pass
862.0	Base	-55.80	37.57	93.37	-3.0	34.57	37.0	-2.43	Pass
Uplink transmit mode									
806.0	Mobile	-70.22	25.43	95.65	-3.0	22.43	37.0	-14.57	Pass
811.0	Mobile	-70.24	25.77	96.01	-3.0	22.77	37.0	-14.23	Pass
817.0	Mobile	-70.51	24.75	95.26	-3.0	21.75	37.0	-15.25	Pass

* - Margin = ERP – specification limit

** - Booster Gain = Output SA reading – Input SA reading

*** - ERP = Output SA reading + Gmax antenna gain (dBi) – 2.15 – Insertion loss = Pout + Antenna assembly gain (dBi) – 2.15

Where Antenna assembly gain = Gmax antenna gain (dBi) – Cable loss – Splitter loss

Note 1: In DAS system, we suppose a loss due to cable insertion, splitter, etc, about of 12 dB.

There are no specific antennas supplied as a part of the unit that is why the maximum antenna assembly gain in dBd shall not exceed the value in -3 dB.



Test specification: Section 90.219(e)(1), Input/output power and booster gain test for PLMRS/PSRS			
Test procedure: KDB 935210 D05 v01r01, section 4.5			
Test mode: Compliance		Verdict: PASS	
Date(s): 17-Mar-16 - 29-Mar-16			
Temperature: 23.2 °C	Relative Humidity: 48 %	Air Pressure: 1015 hPa	Power supply: 120 VAC
Remarks:			

Table 7.2.5 Input/output power and booster gain test results

DETECTOR USED: Average
 RESOLUTION BANDWIDTH: 100 kHz
 VIDEO BANDWIDTH: 300 kHz
 RF SIGNAL: Analog FM

OPERATING FREQUENCY RANGE: 851 - 862 MHz (downlink)
 806 - 817 MHz (uplink)

Carrier frequency, MHz	Input port	SA reading, dBm		Booster gain**, dB	Antenna assembly gain***, dBd	ERP, dBm	Limit, dBm	Margin*, dB	Verdict
		Input	Output						
Downlink transmit mode									
851.0	Base	-54.58	39.16	93.74	-3.0	36.16	37.0	-0.84	Pass
856.0	Base	-55.52	39.69	95.21	-3.0	36.69	37.0	-0.31	Pass
862.0	Base	-55.36	39.23	94.59	-3.0	36.23	37.0	-0.77	Pass
Uplink transmit mode									
806.0	Mobile	-69.68	26.35	96.03	-3.0	23.35	37.0	-13.65	Pass
811.0	Mobile	-69.56	26.72	96.28	-3.0	23.72	37.0	-13.28	Pass
817.0	Mobile	-69.44	26.25	95.69	-3.0	23.25	37.0	-13.75	Pass

* - Margin = ERP – specification limit
 ** - Booster Gain = Output SA reading – Input SA reading
 *** - ERP = Output SA reading + Gmax antenna gain (dBi) – 2.15 – Insertion loss = Pout + Antenna assembly gain (dBi) – 2.15

Where Antenna assembly gain = Gmax antenna gain (dBi) – Cable loss – Splitter loss

Note 1: In DAS system, we suppose a loss due to cable insertion, splitter, etc, about of 12dB:

There are no specific antennas supplied as a part of the unit that is why the maximum antenna assembly gain in dBd shall not exceed the value in -3 dB.

Reference numbers of test equipment used

HL 0539	HL 1876	HL 2909	HL 3779	HL 3787	HL 3903	HL 4273	HL 4275
HL 4364							

Full description is given in Appendix A.



HERMON LABORATORIES

Test specification: Section 90.219(e)(1), Input/output power and booster gain test for PLMRS/PSRS			
Test procedure: KDB 935210 D05 v01r01, section 4.5			
Test mode: Compliance	Verdict: PASS		
Date(s): 17-Mar-16 - 29-Mar-16			
Temperature: 23.2 °C	Relative Humidity: 48 %	Air Pressure: 1015 hPa	Power supply: 120 VAC
Remarks:			

Plot 7.2.1 Input/output power test results at low frequency

FREQUENCY RANGE:
RF SIGNAL:
INPUT PORT:
INPUT POWER SA READING: -56 dBm

851.0 – 862.0 MHz
CW
Base
OUTPUT POWER SA READING:

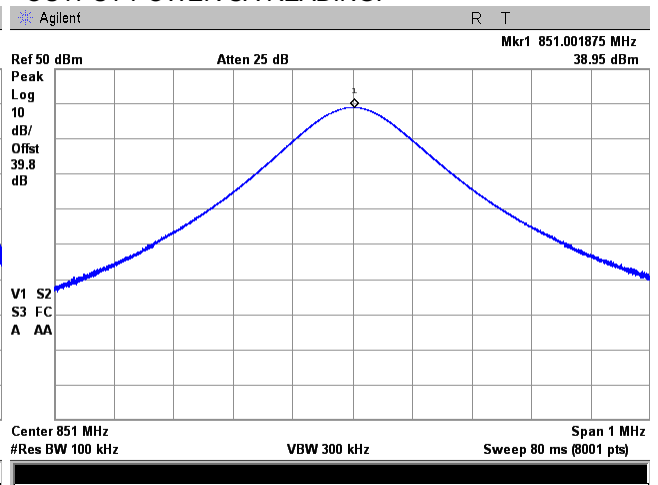
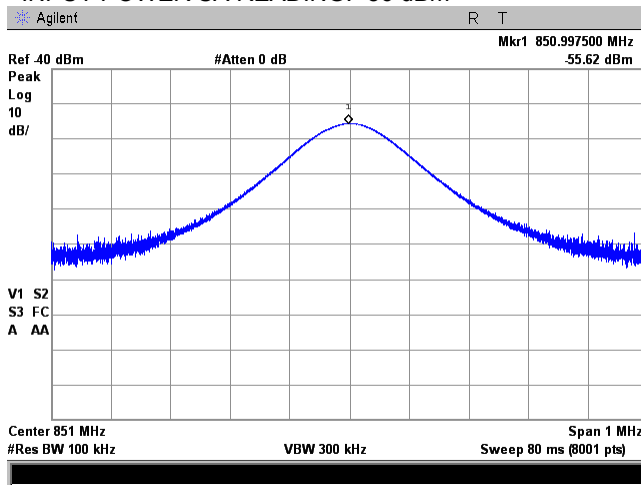

Plot 7.2.2 Input/output power test results at mid frequency

FREQUENCY RANGE:
RF SIGNAL:
INPUT PORT:
INPUT POWER SA READING: -56 dBm

851.0 – 862.0 MHz
CW
Base
OUTPUT POWER SA READING:

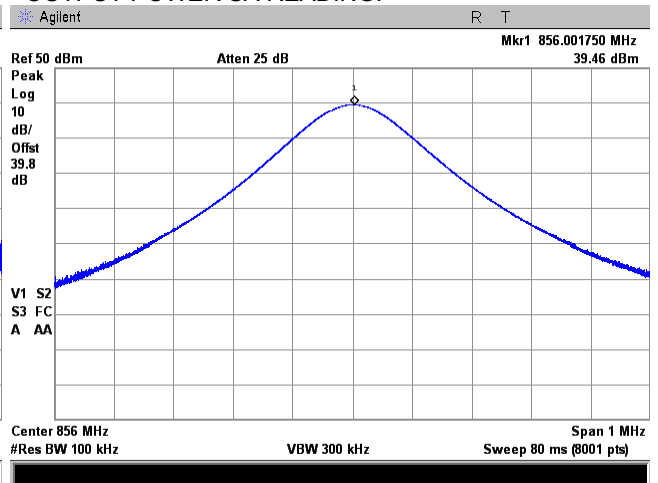
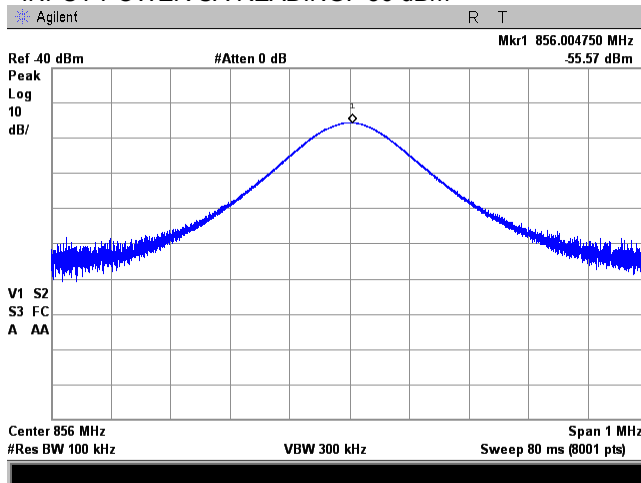



HERMON LABORATORIES

Test specification: Section 90.219(e)(1), Input/output power and booster gain test for PLMRS/PSRS	
Test procedure: KDB 935210 D05 v01r01, section 4.5	
Test mode: Compliance	Verdict: PASS
Date(s): 17-Mar-16 - 29-Mar-16	
Temperature: 23.2 °C	Relative Humidity: 48 %
Air Pressure: 1015 hPa	Power supply: 120 VAC
Remarks:	

Plot 7.2.3 Input/output power test results at high frequency

FREQUENCY RANGE:
RF SIGNAL:
INPUT PORT:
INPUT POWER SA READING: -56 dBm

851.0 – 862.0 MHz
CW
Base
OUTPUT POWER SA READING:

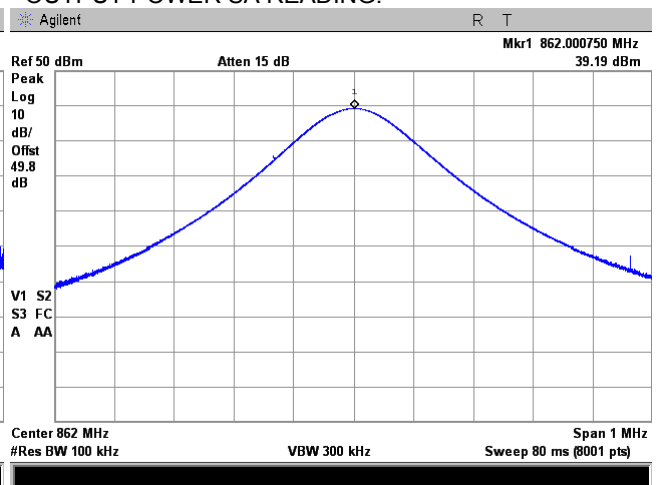
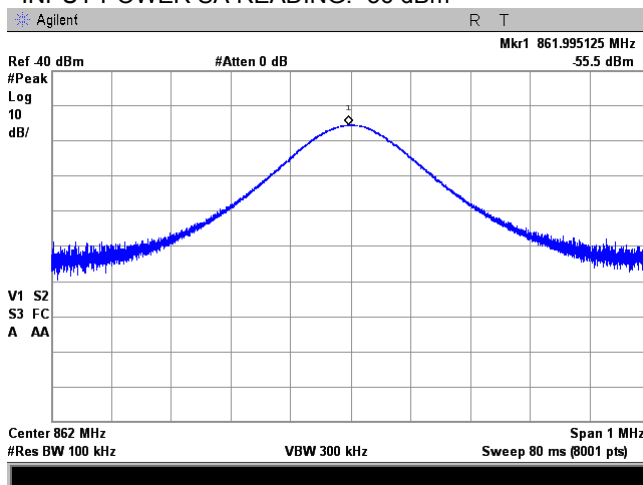

Plot 7.2.4 Input/output power test results at low frequency

FREQUENCY RANGE:
RF SIGNAL:
INPUT PORT:
INPUT POWER SA READING: -69 dBm

806.0 – 817.0 MHz
CW
Mobile
OUTPUT POWER SA READING:

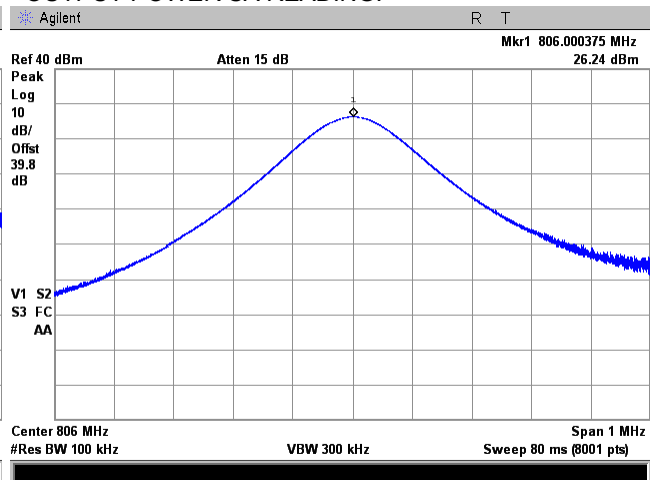
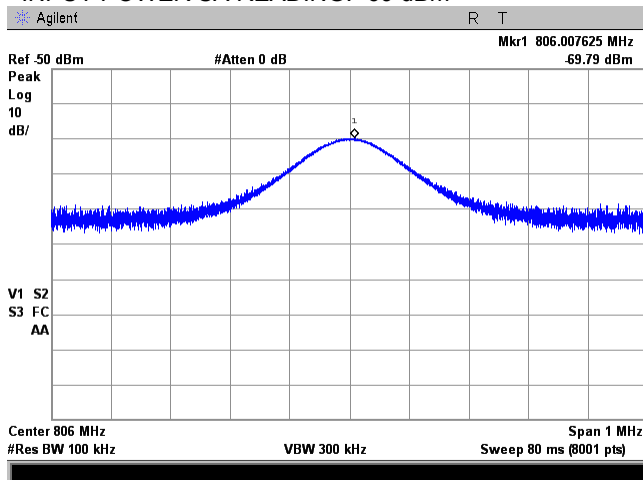



HERMON LABORATORIES

Test specification: Section 90.219(e)(1), Input/output power and booster gain test for PLMRS/PSRS			
Test procedure: KDB 935210 D05 v01r01, section 4.5			
Test mode: Compliance		Verdict: PASS	
Date(s): 17-Mar-16 - 29-Mar-16			
Temperature: 23.2 °C	Relative Humidity: 48 %	Air Pressure: 1015 hPa	Power supply: 120 VAC
Remarks:			

Plot 7.2.5 Input/output power test results at mid frequency

FREQUENCY RANGE:
RF SIGNAL:
INPUT PORT:
INPUT POWER SA READING: -69 dBm

806.0 – 817.0 MHz
CW
Mobile
OUTPUT POWER SA READING:

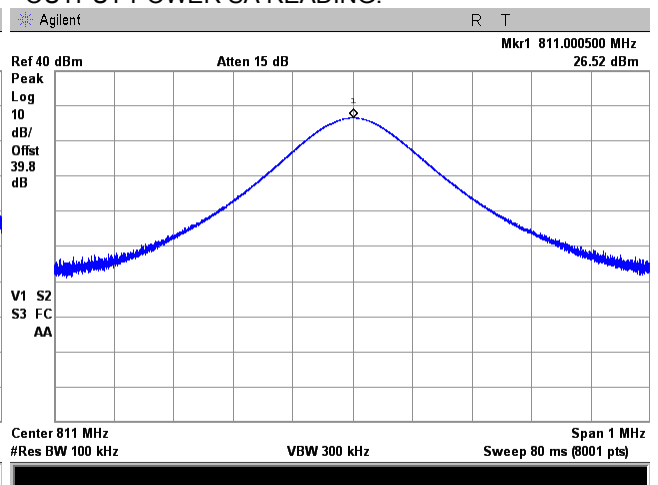
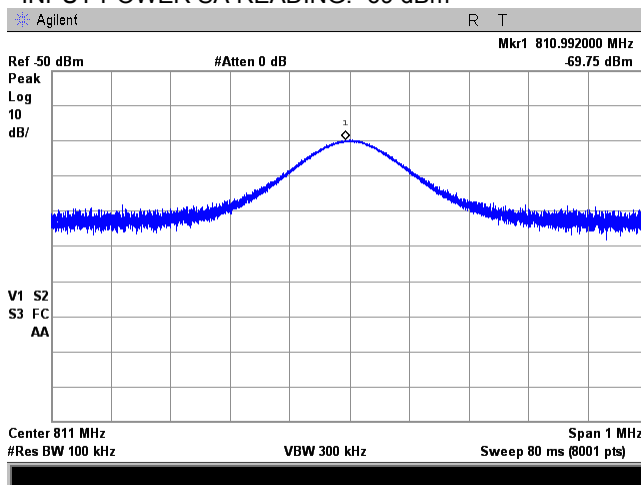

Plot 7.2.6 Input/output power test results at high frequency

FREQUENCY RANGE:
RF SIGNAL:
INPUT PORT:
INPUT POWER SA READING: -69 dBm

806.0 – 817.0 MHz
CW
Mobile
OUTPUT POWER SA READING:

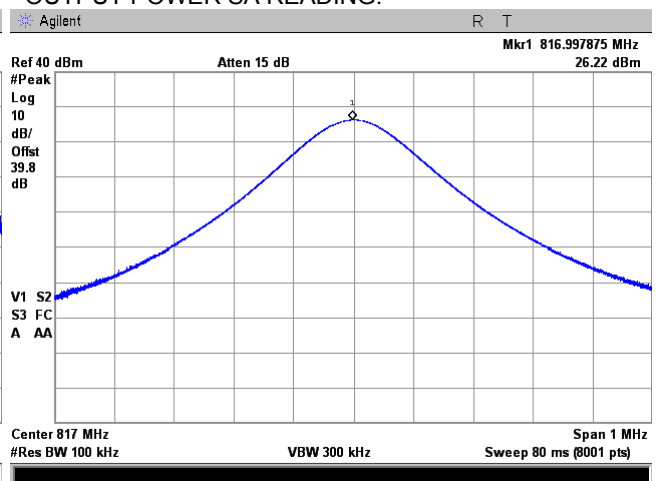
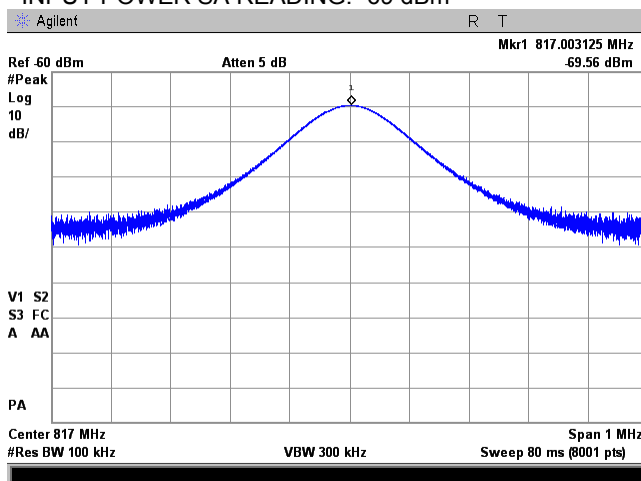



HERMON LABORATORIES

Test specification: Section 90.219(e)(1), Input/output power and booster gain test for PLMRS/PSRS			
Test procedure: KDB 935210 D05 v01r01, section 4.5			
Test mode: Compliance		Verdict: PASS	
Date(s): 17-Mar-16 - 29-Mar-16			
Temperature: 23.2 °C	Relative Humidity: 48 %	Air Pressure: 1015 hPa	Power supply: 120 VAC
Remarks:			

Plot 7.2.7 Input/output power test results at low frequency

FREQUENCY RANGE:
OPERATIONAL MODE:
INPUT PORT:
INPUT POWER SA READING: -56 dBm

851.0 – 862.0 MHz
C4FM downlink transmit
Base
OUTPUT POWER SA READING:

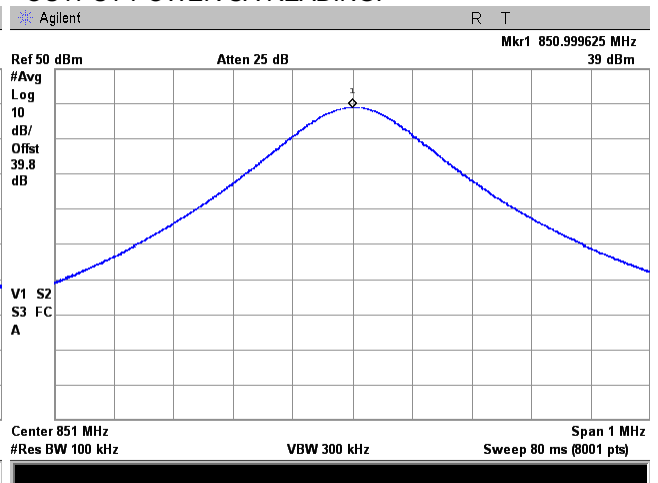
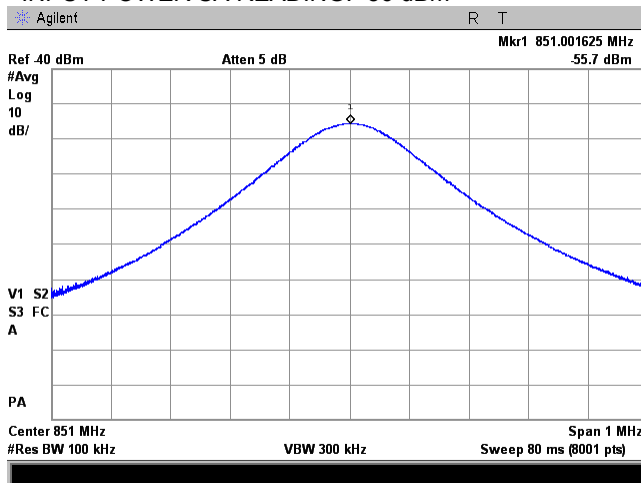

Plot 7.2.8 Input/output power test results at mid frequency

FREQUENCY RANGE:
OPERATIONAL MODE:
INPUT PORT:
INPUT POWER SA READING: -56 dBm

851.0 – 862.0 MHz
C4FM downlink transmit
Base
OUTPUT POWER SA READING:

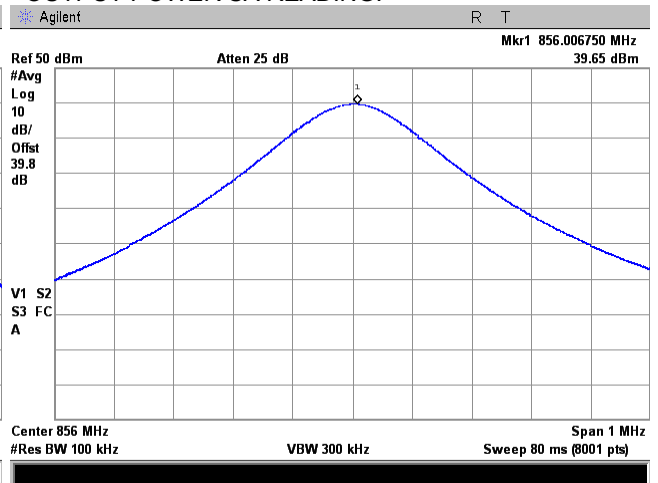
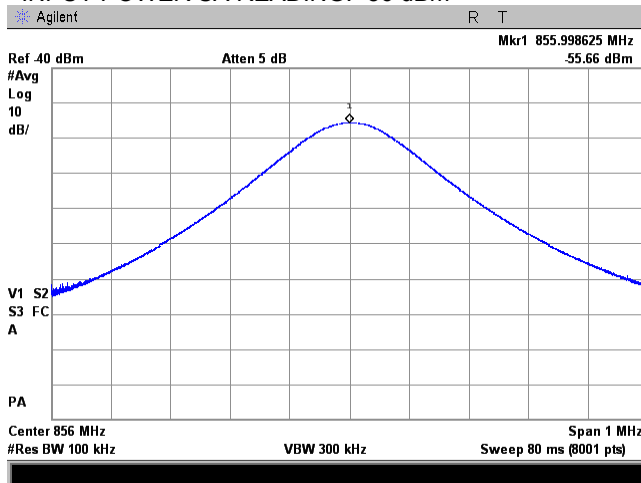



HERMON LABORATORIES

Test specification: Section 90.219(e)(1), Input/output power and booster gain test for PLMRS/PSRS			
Test procedure: KDB 935210 D05 v01r01, section 4.5			
Test mode: Compliance		Verdict: PASS	
Date(s): 17-Mar-16 - 29-Mar-16			
Temperature: 23.2 °C	Relative Humidity: 48 %	Air Pressure: 1015 hPa	Power supply: 120 VAC
Remarks:			

Plot 7.2.9 Input/output power test results at high frequency

FREQUENCY RANGE:
OPERATIONAL MODE:
INPUT PORT:
INPUT POWER SA READING: -56 dBm

851.0 – 862.0 MHz
C4FM downlink transmit
Base
OUTPUT POWER SA READING:

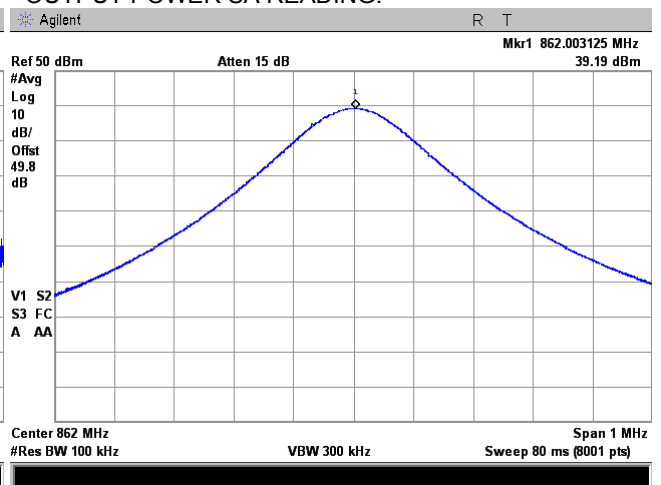
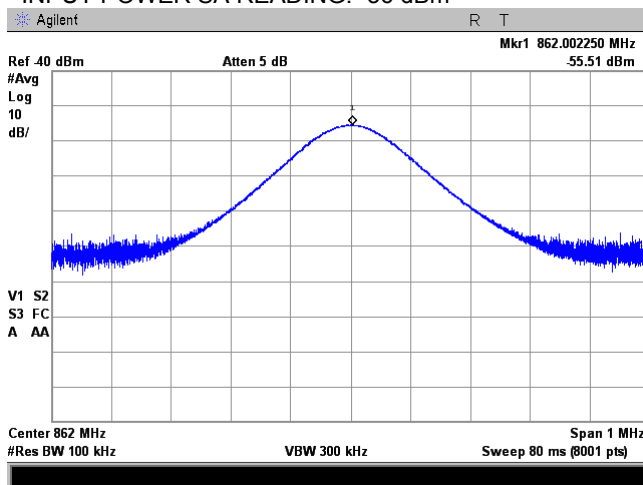

Plot 7.2.10 Input/output power test results at low frequency

FREQUENCY RANGE:
OPERATIONAL MODE:
INPUT PORT:
INPUT POWER SA READING: -71 dBm

806.0 – 817.0 MHz
C4FM downlink transmit
Mobile
OUTPUT POWER SA READING:

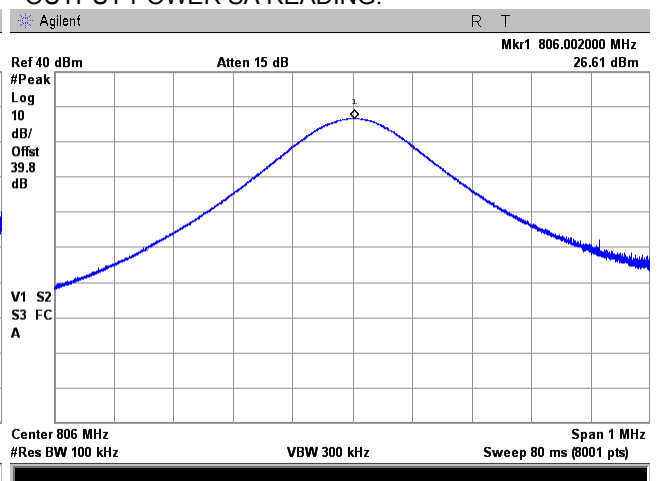
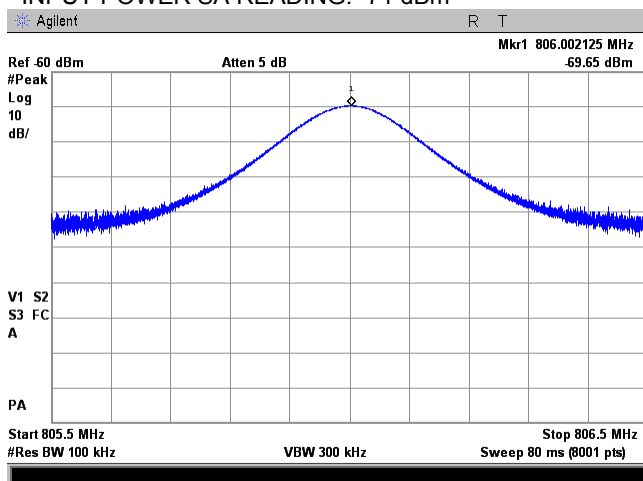



HERMON LABORATORIES

Test specification: Section 90.219(e)(1), Input/output power and booster gain test for PLMRS/PSRS			
Test procedure: KDB 935210 D05 v01r01, section 4.5			
Test mode: Compliance	Verdict: PASS		
Date(s): 17-Mar-16 - 29-Mar-16			
Temperature: 23.2 °C	Relative Humidity: 48 %	Air Pressure: 1015 hPa	Power supply: 120 VAC
Remarks:			

Plot 7.2.11 Input/output power test results at mid frequency

FREQUENCY RANGE:
OPERATIONAL MODE:
INPUT PORT:
INPUT POWER SA READING: -71 dBm

806.0 – 817.0 MHz
C4FM downlink transmit
Mobile
OUTPUT POWER SA READING:

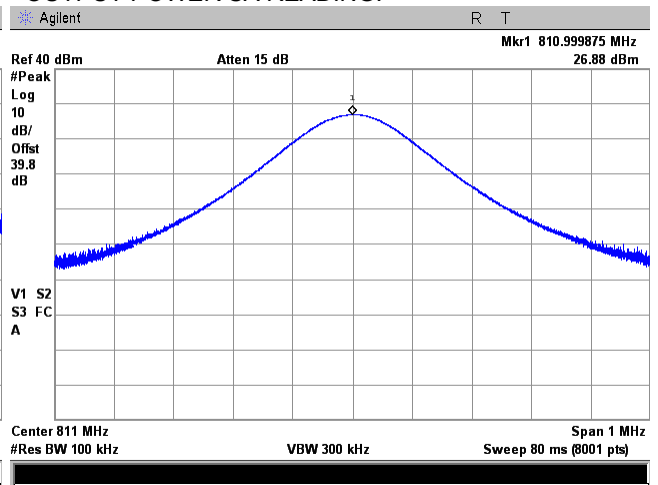
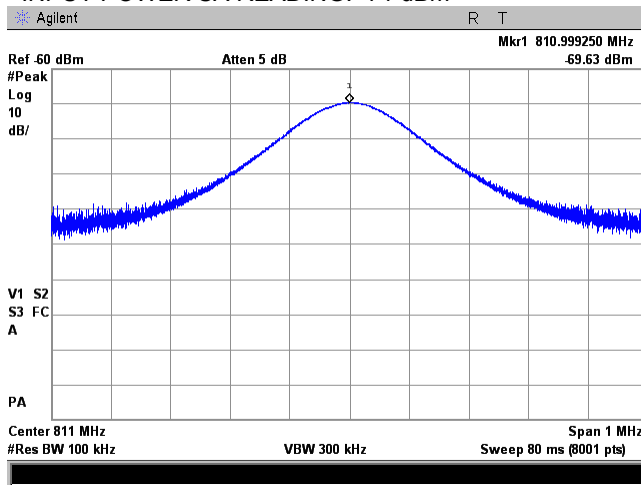

Plot 7.2.12 Input/output power test results at high frequency

FREQUENCY RANGE:
OPERATIONAL MODE:
INPUT PORT:
INPUT POWER SA READING: -69 dBm

806.0 – 817.0 MHz
C4FM downlink transmit
Mobile
OUTPUT POWER SA READING:

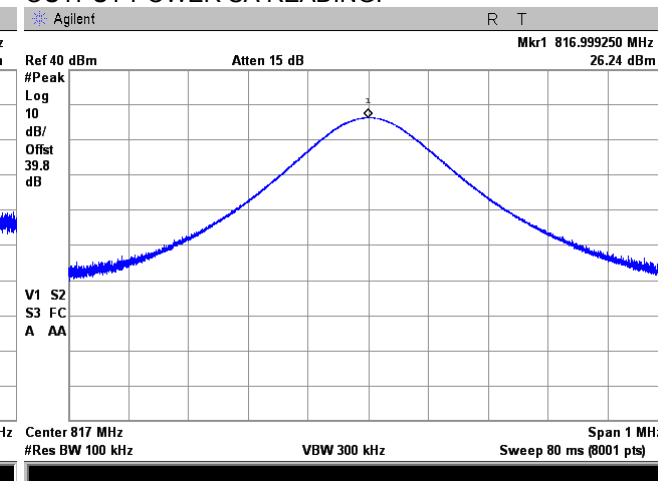
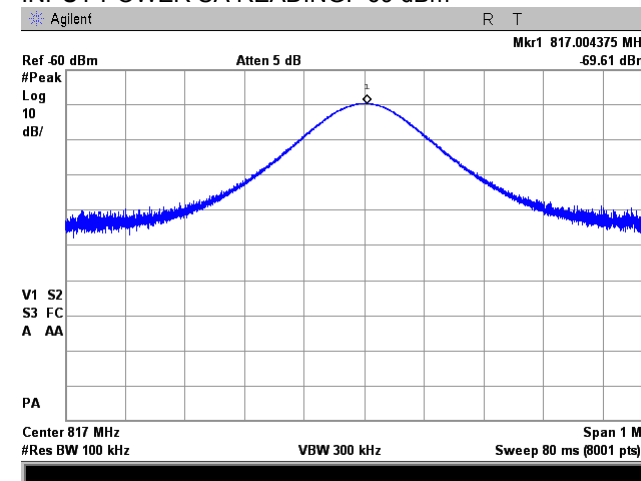



HERMON LABORATORIES

Test specification: Section 90.219(e)(1), Input/output power and booster gain test for PLMRS/PSRS			
Test procedure: KDB 935210 D05 v01r01, section 4.5			
Test mode: Compliance		Verdict: PASS	
Date(s): 17-Mar-16 - 29-Mar-16			
Temperature: 23.2 °C	Relative Humidity: 48 %	Air Pressure: 1015 hPa	Power supply: 120 VAC
Remarks:			

Plot 7.2.13 Input/output power test results at low frequency

FREQUENCY RANGE:
OPERATIONAL MODE:
INPUT PORT:
INPUT POWER SA READING: -56 dBm

851.0 – 862.0 MHz
iDEN QAM downlink transmit
Base
OUTPUT POWER SA READING:

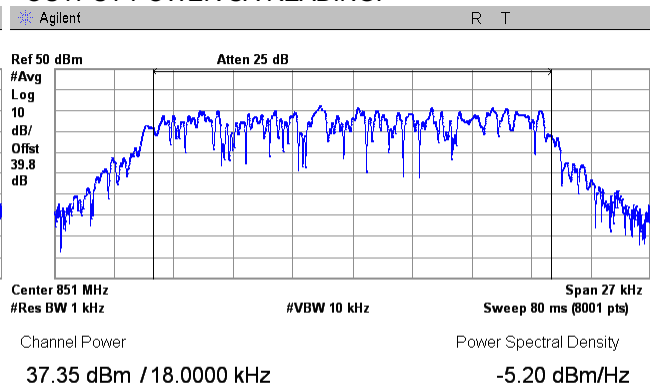
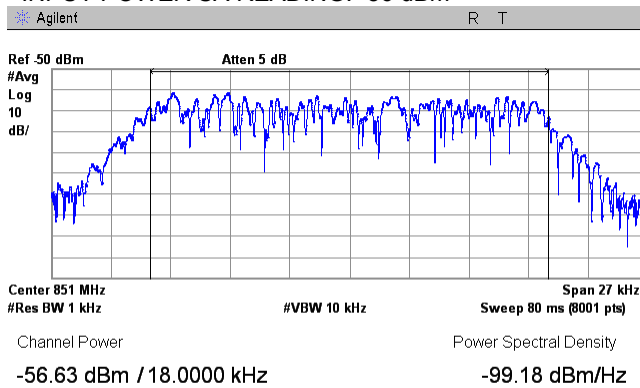

Plot 7.2.14 Input/output power test results at mid frequency

FREQUENCY RANGE:
OPERATIONAL MODE:
INPUT PORT:
INPUT POWER SA READING: -56 dBm

851.0 – 862.0 MHz
iDEN QAM downlink transmit
Base
OUTPUT POWER SA READING:

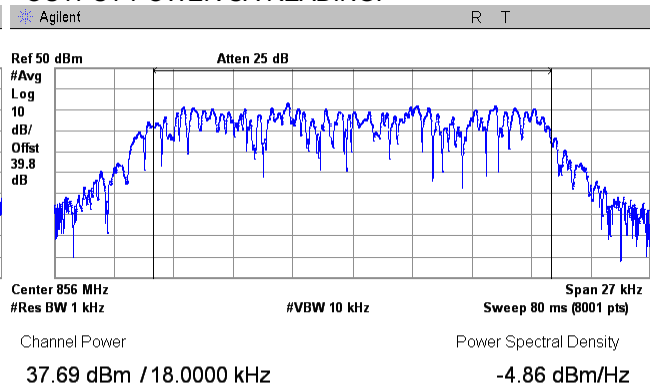
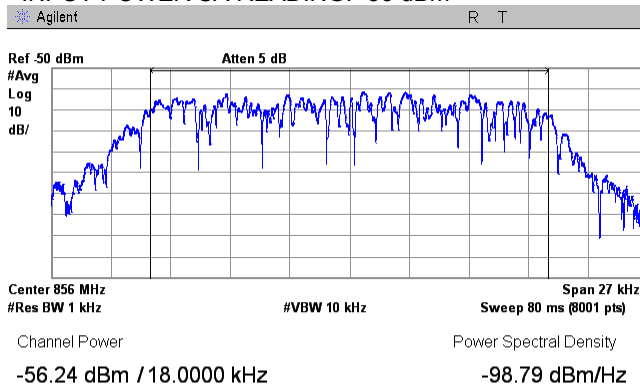



HERMON LABORATORIES

Test specification: Section 90.219(e)(1), Input/output power and booster gain test for PLMRS/PSRS			
Test procedure: KDB 935210 D05 v01r01, section 4.5			
Test mode: Compliance		Verdict: PASS	
Date(s): 17-Mar-16 - 29-Mar-16			
Temperature: 23.2 °C	Relative Humidity: 48 %	Air Pressure: 1015 hPa	Power supply: 120 VAC
Remarks:			

Plot 7.2.15 Input/output power test results at high frequency

FREQUENCY RANGE:
OPERATIONAL MODE:
INPUT PORT:
INPUT POWER SA READING: -56 dBm

851.0 – 862.0 MHz
iDEN QAM downlink transmit
Base
OUTPUT POWER SA READING:

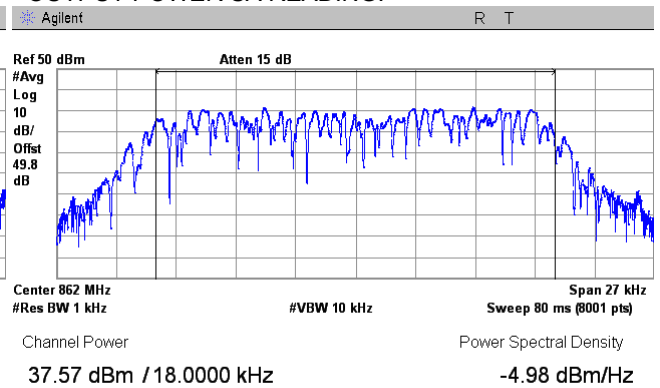
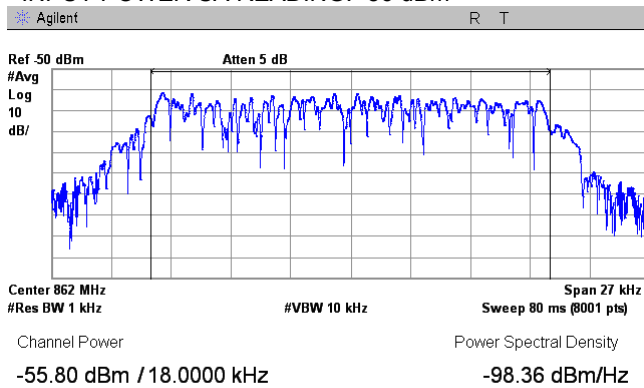

Plot 7.2.16 Input/output power test results at low frequency

FREQUENCY RANGE:
OPERATIONAL MODE:
INPUT PORT:
INPUT POWER SA READING: -71 dBm

806.0 – 817.0 MHz
iDEN QAM downlink transmit
Mobile
OUTPUT POWER SA READING:

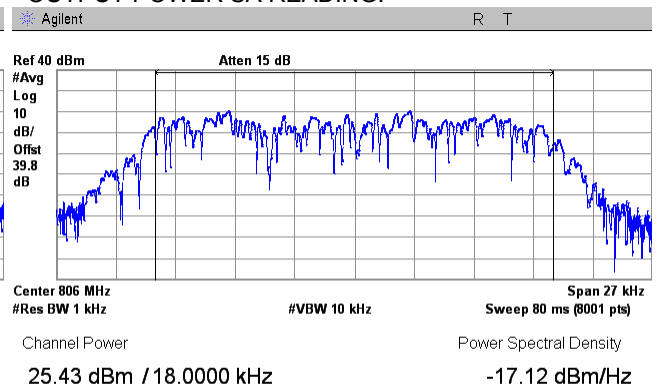
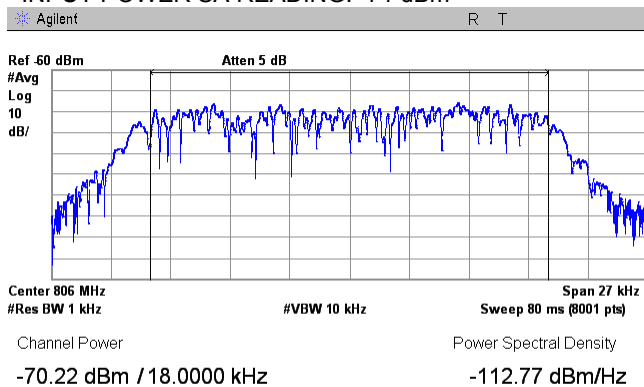



HERMON LABORATORIES

Test specification: Section 90.219(e)(1), Input/output power and booster gain test for PLMRS/PSRS	
Test procedure: KDB 935210 D05 v01r01, section 4.5	
Test mode: Compliance	Verdict: PASS
Date(s): 17-Mar-16 - 29-Mar-16	
Temperature: 23.2 °C	Relative Humidity: 48 %
Remarks:	

Plot 7.2.17 Input/output power test results at mid frequency

FREQUENCY RANGE:
OPERATIONAL MODE:
INPUT PORT:
INPUT POWER SA READING: -71 dBm

806.0 – 817.0 MHz
iDEN QAM downlink transmit
Mobile
OUTPUT POWER SA READING:

Agilent R T

Agilent R T

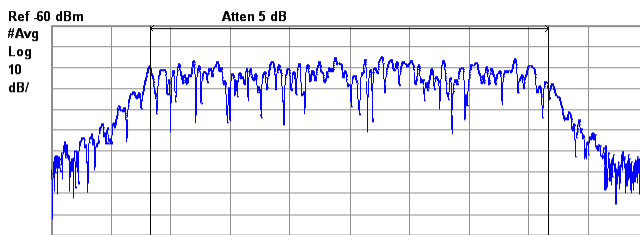

Center 811 MHz
#Res BW 1 kHz
#VBW 10 kHz
Sweep 80 ms (8001 pts)
Span 27 kHz

Channel Power
-70.24 dBm / 18.0000 kHz

Power Spectral Density
-112.80 dBm/Hz

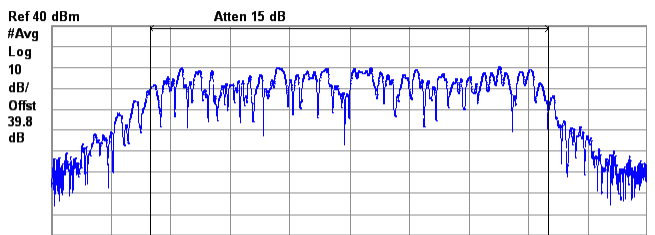

Center 811 MHz
#Res BW 1 kHz
#VBW 10 kHz
Sweep 80 ms (8001 pts)
Span 27 kHz

Channel Power
25.77 dBm / 18.0000 kHz

Power Spectral Density
-16.78 dBm/Hz

Plot 7.2.18 Input/output power test results at high frequency

FREQUENCY RANGE:
OPERATIONAL MODE:
INPUT PORT:
INPUT POWER SA READING: -69 dBm

806.0 – 817.0 MHz
iDEN QAM downlink transmit
Mobile
OUTPUT POWER SA READING:

Agilent R T

Agilent R T

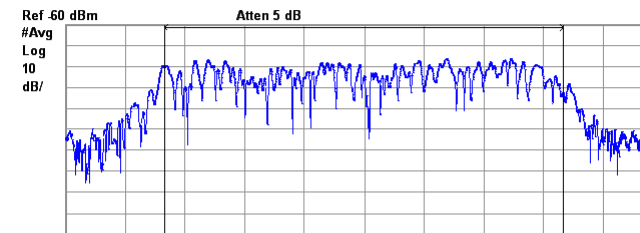

Center 817 MHz
#Res BW 1 kHz
#VBW 10 kHz
Sweep 80 ms (8001 pts)
Span 27 kHz

Channel Power
-70.51 dBm / 18.0000 kHz

Power Spectral Density
-113.06 dBm/Hz

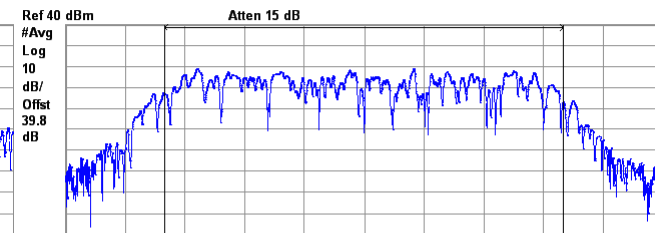

Center 817 MHz
#Res BW 1 kHz
#VBW 10 kHz
Sweep 80 ms (8001 pts)
Span 27 kHz

Channel Power
24.75 dBm / 18.0000 kHz

Power Spectral Density
-17.80 dBm/Hz



HERMON LABORATORIES

Test specification: Section 90.219(e)(1), Input/output power and booster gain test for PLMRS/PSRS			
Test procedure: KDB 935210 D05 v01r01, section 4.5			
Test mode: Compliance		Verdict: PASS	
Date(s): 17-Mar-16 - 29-Mar-16			
Temperature: 23.2 °C	Relative Humidity: 48 %	Air Pressure: 1015 hPa	Power supply: 120 VAC
Remarks:			

Plot 7.2.19 Input/output power test results at low frequency

FREQUENCY RANGE:
OPERATIONAL MODE:
INPUT PORT:
INPUT POWER SA READING: -55 dBm

851.0 – 862.0 MHz
Analog FM uplink transmit
Base
OUTPUT POWER SA READING:

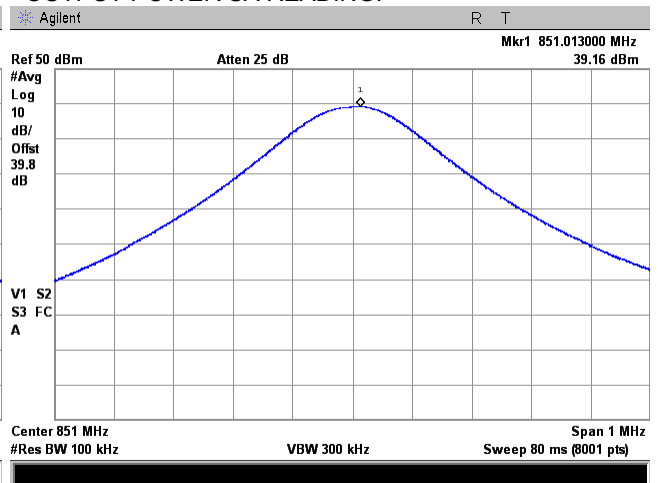
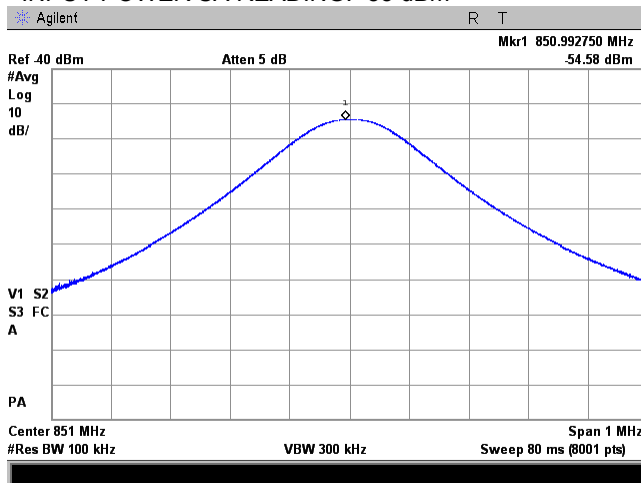

Plot 7.2.20 Input/output power test results at mid frequency

FREQUENCY RANGE:
OPERATIONAL MODE:
INPUT PORT:
INPUT POWER SA READING: -56 dBm

851.0 – 862.0 MHz
Analog FM uplink transmit
Base
OUTPUT POWER SA READING:

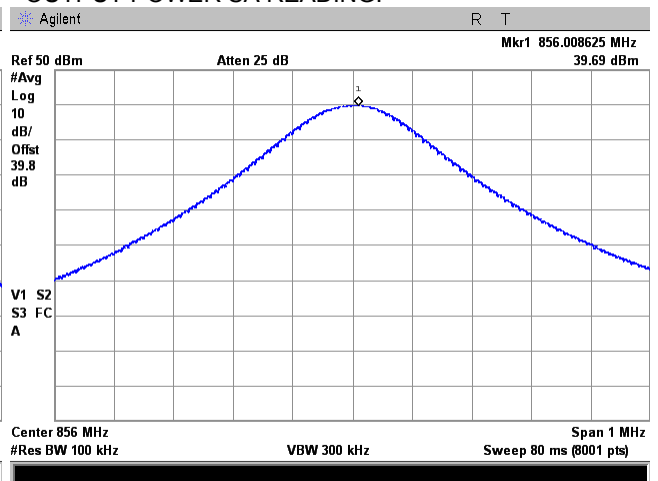
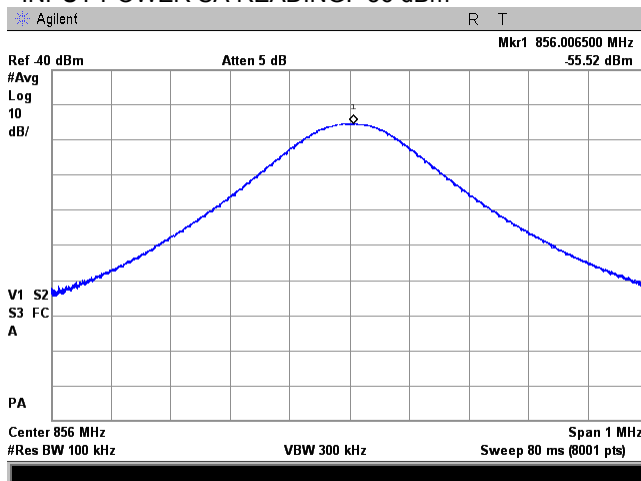



HERMON LABORATORIES

Test specification: Section 90.219(e)(1), Input/output power and booster gain test for PLMRS/PSRS			
Test procedure: KDB 935210 D05 v01r01, section 4.5			
Test mode: Compliance		Verdict: PASS	
Date(s): 17-Mar-16 - 29-Mar-16			
Temperature: 23.2 °C	Relative Humidity: 48 %	Air Pressure: 1015 hPa	Power supply: 120 VAC
Remarks:			

Plot 7.2.21 Input/output power test results at high frequency

FREQUENCY RANGE:
OPERATIONAL MODE:
INPUT PORT:
INPUT POWER SA READING: -56 dBm

851.0 – 862.0 MHz
Analog FM uplink transmit
Base
OUTPUT POWER SA READING:

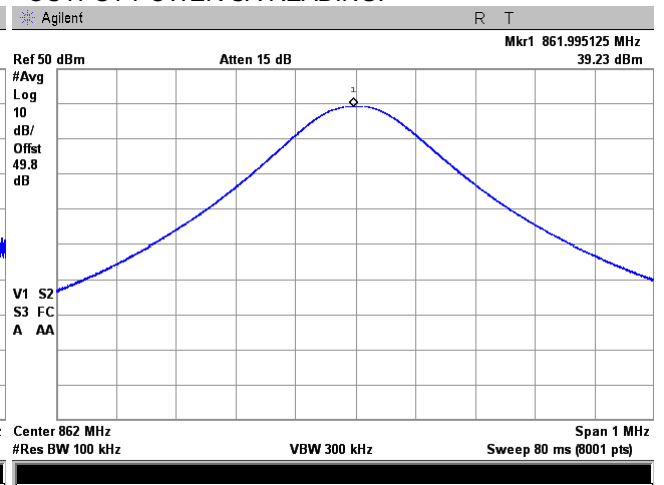
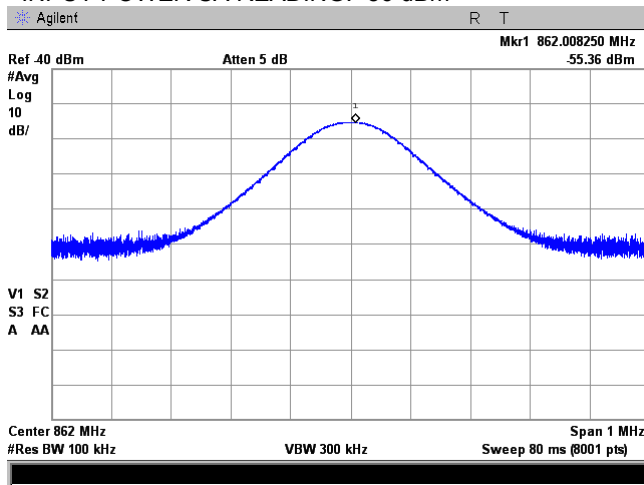

Plot 7.2.22 Input/output power test results at low frequency

FREQUENCY RANGE:
OPERATIONAL MODE:
INPUT PORT:
INPUT POWER SA READING: -71 dBm

806.0 – 817.0 MHz
Analog FM uplink transmit
Mobile
OUTPUT POWER SA READING:

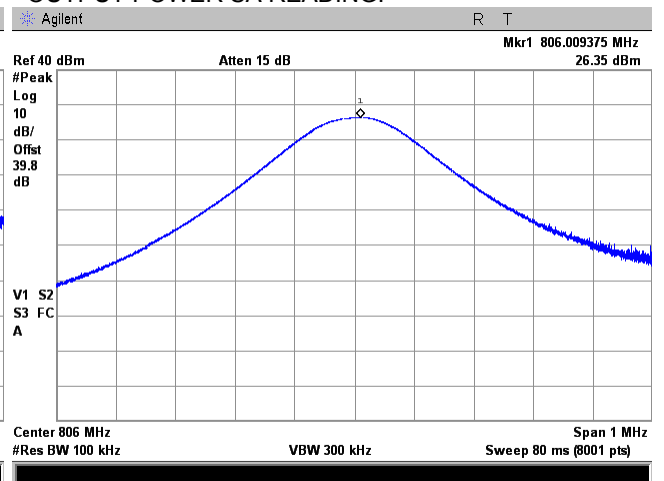
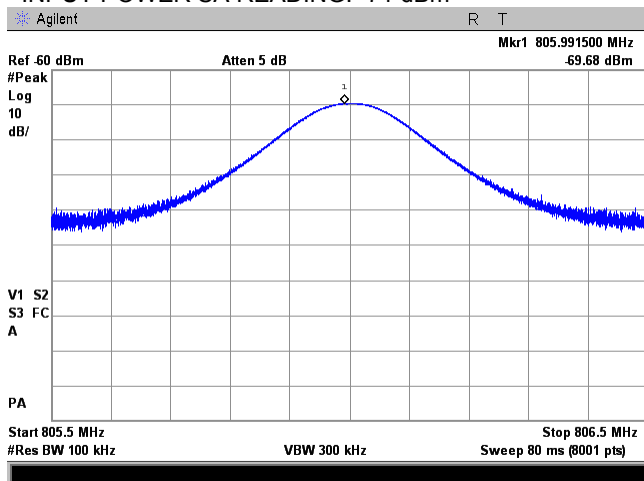



HERMON LABORATORIES

Test specification: Section 90.219(e)(1), Input/output power and booster gain test for PLMRS/PSRS			
Test procedure: KDB 935210 D05 v01r01, section 4.5			
Test mode: Compliance	Verdict: PASS		
Date(s): 17-Mar-16 - 29-Mar-16			
Temperature: 23.2 °C	Relative Humidity: 48 %	Air Pressure: 1015 hPa	Power supply: 120 VAC
Remarks:			

Plot 7.2.23 Input/output power test results at mid frequency

FREQUENCY RANGE:
OPERATIONAL MODE:
INPUT PORT:
INPUT POWER SA READING: -71 dBm

806.0 – 817.0 MHz
Analog FM uplink transmit
Mobile
OUTPUT POWER SA READING:

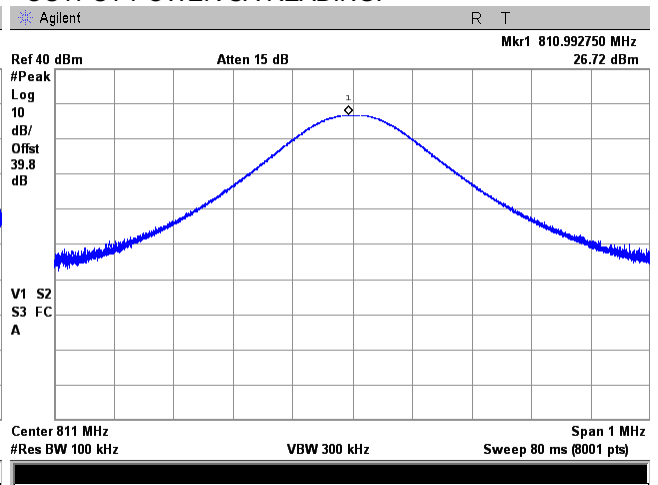
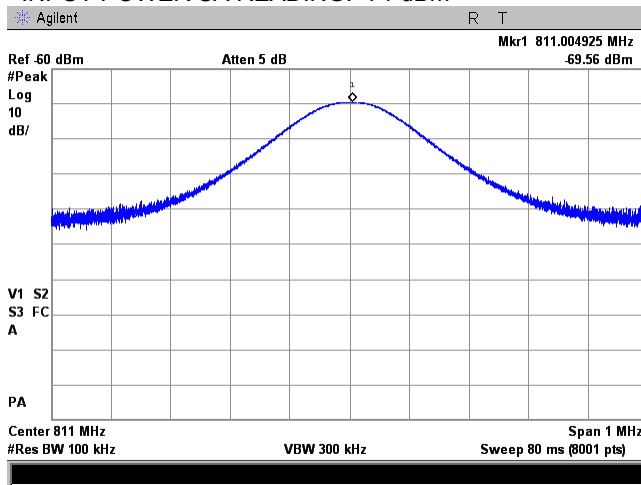

Plot 7.2.24 Input/output power test results at high frequency

FREQUENCY RANGE:
OPERATIONAL MODE:
INPUT PORT:
INPUT POWER SA READING: -69 dBm

806.0 – 817.0 MHz
Analog FM uplink transmit
Mobile
OUTPUT POWER SA READING:

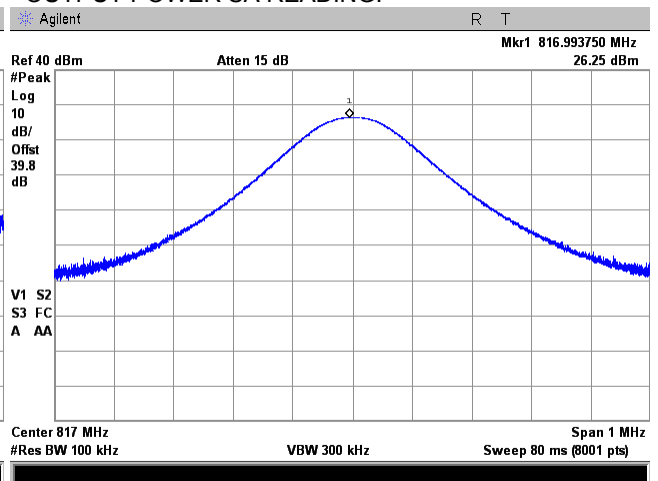
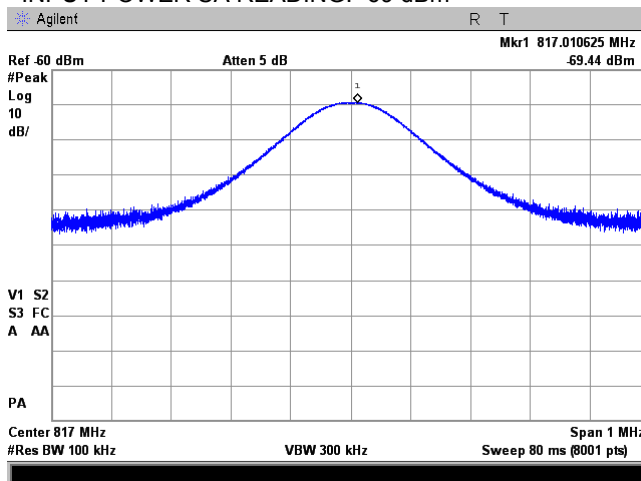



Test specification: Section 90.219(a), Out-of-band rejection test for PLMRS/PSRS			
Test procedure: KDB 935210 D05 v01r01, section 4.3			
Test mode: Compliance		Verdict: PASS	
Date(s): 17-Mar-16 - 29-Mar-16			
Temperature: 22.3 °C	Relative Humidity: 47 %	Air Pressure: 1015 hPa	Power supply: 120 VAC
Remarks:			

7.3 Out-of-band rejection test for for PLMRS/PSRS

7.3.1 General

This test was performed to measure transmitter occupied bandwidth. Specification test limits are given in Table 7.3.1.

Table 7.3.1 Out-of-band rejection limits

Assigned frequency range, MHz	Tested frequency range	Modulation envelope reference points*, dBc
806.0 – 824.0 851.0 – 869.0	$F_0 \pm 250\%BW$	20

* - Modulation envelope reference points are provided in terms of attenuation below the unmodulated carrier.

7.3.2 Test procedure

- 7.3.2.1 The EUT was set up as shown in Figure 7.3.1, energized and its proper operation was checked.
- 7.3.2.2 The EUT was set to transmit the unmodulated carrier and the reference peak power level was measured.
- 7.3.2.3 The EUT was set to transmit the normally modulated carrier.
- 7.3.2.4 The transmitter occupied bandwidth was measured with spectrum analyzer as a frequency delta between the reference points on modulation envelope and provided in Table 7.3.2, Table 7.3.3 and the associated plots.

Figure 7.3.1 Out-of-band rejection test setup

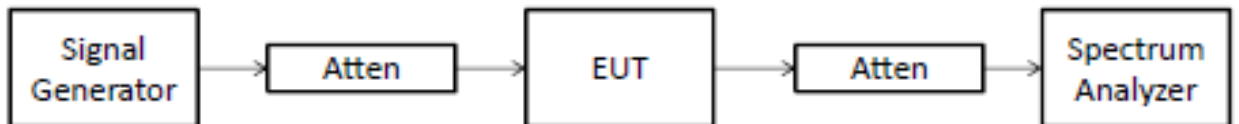



Test specification: Section 90.219(a), Out-of-band rejection test for PLMRS/PSRS			
Test procedure: KDB 935210 D05 v01r01, section 4.3			
Test mode: Compliance		Verdict: PASS	
Date(s): 17-Mar-16 - 29-Mar-16			
Temperature: 22.3 °C	Relative Humidity: 47 %	Air Pressure: 1015 hPa	Power supply: 120 VAC
Remarks:			

Table 7.3.2 Out-of-band rejection test results

FRQUENCY RANGE: 851.0 – 862.0 MHz Downlink
DETECTOR USED: Peak hold
RESOLUTION BANDWIDTH: 300 kHz
VIDEO BANDWIDTH: 1000 kHz
MODULATION ENVELOPE REFERENCE POINTS: 20 dBc

Input Power, dBm	Start Band frequency, MHz	Stop Band frequency, MHz	Occupied bandwidth, MHz	Limit, MHz	Verdict
-58	851.0675	861.985	10.9175	851.0 – 862.0	Pass
-28	851.1240	862.000	10.8760	851.0 – 862.0	Pass

Table 7.3.3 Out-of-band rejection test results

FRQUENCY RANGE: 806.0 – 817.0 MHz Uplink
DETECTOR USED: Peak hold
RESOLUTION BANDWIDTH: 300 kHz
VIDEO BANDWIDTH: 1000 kHz
MODULATION ENVELOPE REFERENCE POINTS: 20 dBc

Input Power, dBm	Start Band frequency, MHz	Stop Band frequency, MHz	Occupied bandwidth, MHz	Limit, MHz	Verdict
-69	806.0000	817.0000	11.0000	806.0 – 817.0	Pass
-39	806.0075	817.0000	10.9925	806.0 – 817.0	Pass

Reference numbers of test equipment used

HL 0557	HL 2909	HL 3434	HL 3787	HL 3788	HL 3818	HL 3903	HL 4068
HL 4097	HL 4273	HL 4274	HL 4275	HL 4354	HL 4413		

Full description is given in Appendix A.



HERMON LABORATORIES

Test specification: Section 90.219(a), Out-of-band rejection test for PLMRS/PSRS			
Test procedure: KDB 935210 D05 v01r01, section 4.3			
Test mode: Compliance		Verdict: PASS	
Date(s): 17-Mar-16 - 29-Mar-16			
Temperature: 22.3 °C	Relative Humidity: 47 %	Air Pressure: 1015 hPa	Power supply: 120 VAC
Remarks:			

Plot 7.3.1 Out-of-band rejection test result, PLMRS/PSRS

FREQUENCY RANGE:
MIDBAND FREQUENCY:
SWEEP FREQUENCY RANGE:
INPUT PORT:
INPUT POWER: -58 dBm

851.0 – 862.0 MHz
856.5 MHz
815.5 – 905.5 MHz
Base
INPUT POWER: -28 dBm

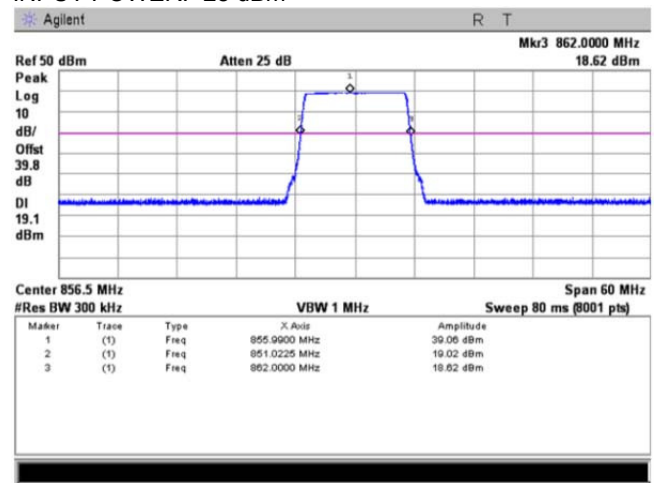
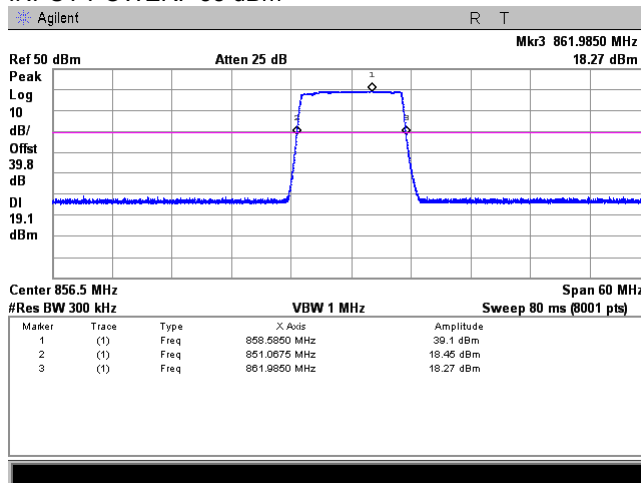

Plot 7.3.2 Out-of-band rejection test result, PLMRS/PSRS

FREQUENCY RANGE:
MIDBAND FREQUENCY:
SWEEP FREQUENCY RANGE:
INPUT PORT:
INPUT POWER: -66 dBm

806.0 – 817.0 MHz Uplink
811.5 MHz
771.5 – 861.5 MHz
Mobile
INPUT POWER: -36 dBm

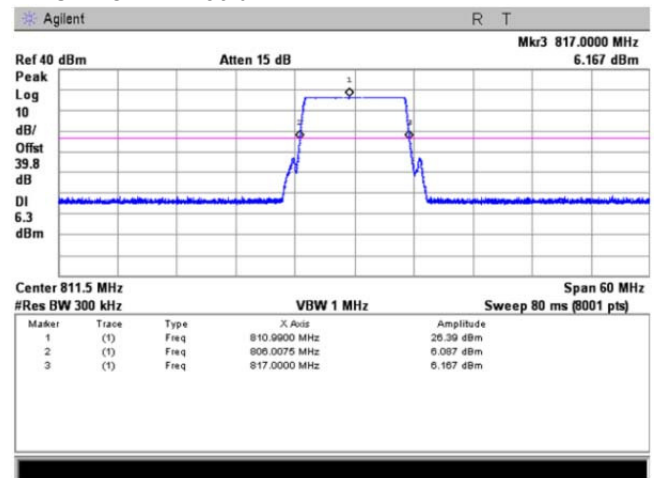
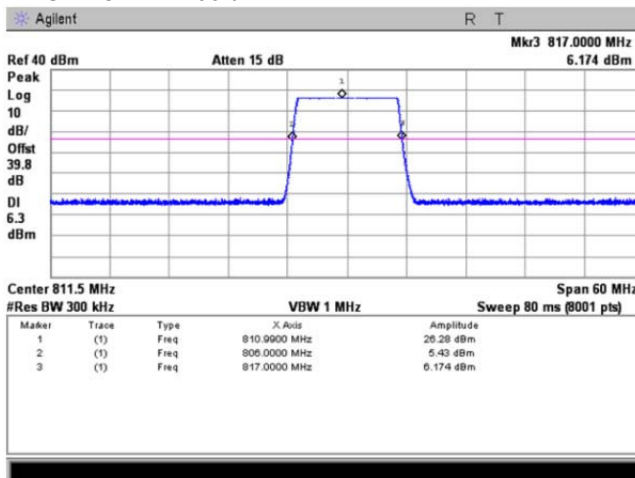



Test specification: Sections 90.210(b), 90.210(h), 90.210(g), Emission mask			
Test procedure: 47 CFR, Sections 2.1051, 2.1047 and 90.210(b); KDB 935210 D05 v01r01, section 4.4			
Test mode: Compliance		Verdict: PASS	
Date(s): 23-Mar-16 - 24-Mar-16			
Temperature: 23.2 °C	Relative Humidity: 48 %	Air Pressure: 1010 hPa	Power supply: 120 VAC
Remarks:			

7.4 Emission mask test

7.4.1 General

This test was performed to measure emission mask at RF antenna connector. Specification test limits are given in Table 7.4.1.

Table 7.4.1 Emission mask limits

Frequency displacement from carrier	Attenuation below carrier, dBc
Emission mask B (Channel bandwidth 10 kHz, authorized bandwidth 8 kHz) with audio low pass filter	
0 – 4.0 kHz	0
4.0 – 8.0 kHz	25.0
8.0 – 20.0 kHz	35.0
More than 20.0 kHz	43+10logP(W)
Emission mask B (Channel bandwidth 20.0 kHz, authorized bandwidth 20.0 kHz)	
0 – 9.0 kHz	0
9.0 – 18.0 kHz	25.0
18.0 – 45.0 kHz	35.0
More than 45.0 kHz	43+10logP(W)
Emission mask B (Channel bandwidth 25.0 kHz, authorized bandwidth 23.0 kHz)	
0 – 11.5 kHz	0
11.5 – 23.0 kHz	25.0
23.0 – 11.5 kHz	35.0
More than 23.0 kHz	43+10logP(W)
Emission mask B (Channel bandwidth 25.0 kHz, authorized bandwidth 16.0 kHz)	
0 – 11.5 kHz	0
11.5 – 23.0 kHz	25.0
23.0 – 11.5 kHz	35.0
More than 23.0 kHz	43+10logP(W)
Emission mask B (Channel bandwidth 12.5 kHz, authorized bandwidth 11.3 kHz)	
0 – 6.25 kHz	0
6.25 – 12.5 kHz	25.0
12.5 – 31.25 kHz	35.0
More than 31.25 kHz	43+10logP(W)
Emission mask B (Channel bandwidth 6.25 kHz, authorized bandwidth 4.0 kHz)	
0 – 3.125 kHz	0
3.125 – 6.25 kHz	25.0
6.25 – 15.625 kHz	35.0
More than 15.625 kHz	43+10logP(W)
Emission mask G (Channel bandwidth 24 kHz, authorized bandwidth 20 kHz)	
0 – 10.0 kHz	0
10.0 – 25.0 kHz	116 log (fd/6.1) or 50+10logP(W) or 70dB
More than 25.0 kHz	43+10logP(W)
Emission mask H (Channel bandwidth 8 kHz, authorized bandwidth 8 kHz)	
0 – 4.0 kHz	0
4.0 – 8.5 kHz	107 log (fd/4)
8.5 – 15.0 kHz	40.5 log(fd/1.16)
15.0 – 25.0 kHz	116 log(fd/6.1)
More than 25.0 kHz	43+10logP(W)

* - linearly increase with frequency

** - emission mask includes carrier modulation envelope within ± 250 % of the authorized bandwidth; the frequency range removed beyond ± 250 % of the authorized bandwidth from carrier was investigated as spurious emission



Test specification: Sections 90.210(b), 90.210(h), 90.210(g), Emission mask			
Test procedure: 47 CFR, Sections 2.1051, 2.1047 and 90.210(b); KDB 935210 D05 v01r01, section 4.4			
Test mode: Compliance		Verdict: PASS	
Date(s): 23-Mar-16 - 24-Mar-16			
Temperature: 23.2 °C	Relative Humidity: 48 %	Air Pressure: 1010 hPa	Power supply: 120 VAC
Remarks:			

7.4.2 Test procedure

7.4.2.1 The EUT was set up as shown in Figure 7.4.1, energized and its proper operation was checked.

7.4.2.2 The emission mask was measured with spectrum analyzer as provided in Table 7.4.2 and the associated plots.

Figure 7.4.1 Emission mask test setup

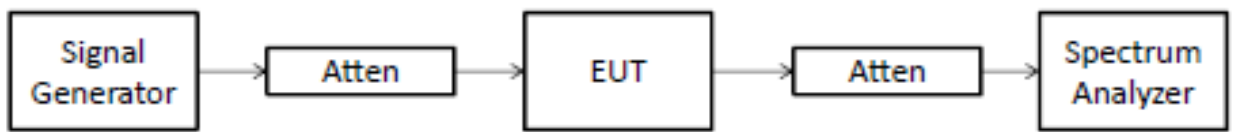



Test specification: Sections 90.210(b), 90.210(h), 90.210(g), Emission mask			
Test procedure: 47 CFR, Sections 2.1051, 2.1047 and 90.210(b); KDB 935210 D05 v01r01, section 4.4			
Test mode: Compliance		Verdict: PASS	
Date(s): 23-Mar-16 - 24-Mar-16			
Temperature: 23.2 °C	Relative Humidity: 48 %	Air Pressure: 1010 hPa	Power supply: 120 VAC
Remarks:			

Table 7.4.2 Emission mask test results

Carrier frequency, MHz	Limit	Verdict
Modulation C4F/iDEN/Analog FM		
Downlink 851 – 862 MHz		
856.0	Emission mask B	Pass
Uplink 806 – 817 MHz		
811.0	Emission mask B	Pass
Downlink 851 – 854 MHz		
852.5	Emission mask H	Pass
Uplink 806 – 809 MHz		
807.5	Emission mask H	Pass
Downlink 854 – 862 MHz		
856.0	Emission mask G	Pass
Uplink 809 – 817 MHz		
813.0	Emission mask G	Pass

Reference numbers of test equipment used

HL 0557	HL 2909	HL 3434	HL 3787	HL 3788	HL 3818	HL 3903	HL 4068
HL 4097	HL 4273	HL 4274	HL 4275	HL 4354	HL 4413		

Full description is given in Appendix A.



HERMON LABORATORIES

Test specification: Sections 90.210(b), 90.210(h), 90.210(g), Emission mask			
Test procedure: 47 CFR, Sections 2.1051, 2.1047 and 90.210(b); KDB 935210 D05 v01r01, section 4.4			
Test mode: Compliance		Verdict: PASS	
Date(s): 23-Mar-16 - 24-Mar-16			
Temperature: 23.2 °C	Relative Humidity: 48 %	Air Pressure: 1010 hPa	Power supply: 120 VAC
Remarks:			

Plot 7.4.1 Emission mask test result at mid frequency carrier, Port 1

FREQUENCY RANGE:
OPERATIONAL MODE:
INPUT PORT:
EMISSION MASK:
CONFIGURATION:
INPUT SIGNAL: -56 dBm

851 - 862 MHz
C4FM downlink transmit
Base
90.210(b)
Below AGC threshold
OUTPUT SIGNAL:

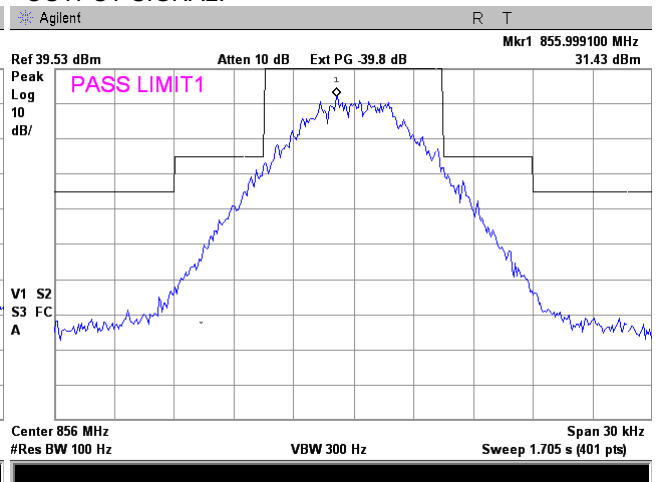
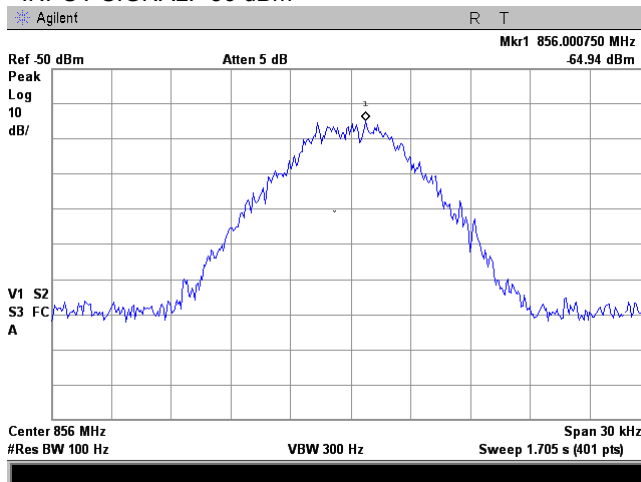

CONFIGURATION:
INPUT SIGNAL: -51 dBm

Above AGC threshold +3dB
OUTPUT SIGNAL:

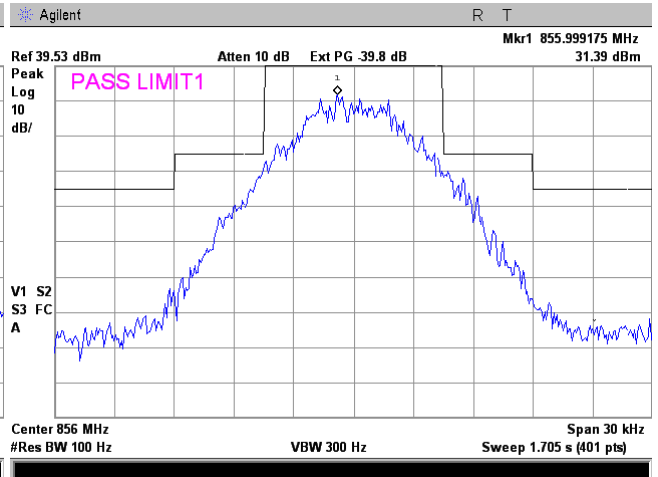
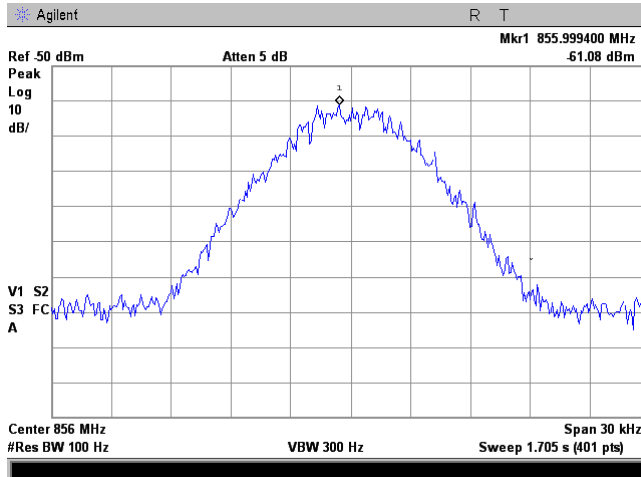



HERMON LABORATORIES

Test specification: Sections 90.210(b), 90.210(h), 90.210(g), Emission mask			
Test procedure: 47 CFR, Sections 2.1051, 2.1047 and 90.210(b); KDB 935210 D05 v01r01, section 4.4			
Test mode: Compliance		Verdict: PASS	
Date(s): 23-Mar-16 - 24-Mar-16			
Temperature: 23.2 °C	Relative Humidity: 48 %	Air Pressure: 1010 hPa	Power supply: 120 VAC
Remarks:			

Plot 7.4.2 Emission mask test result at mid frequency carrier, Port 2

FREQUENCY RANGE:
OPERATIONAL MODE:
INPUT PORT:
EMISSION MASK:
CONFIGURATION:
INPUT SIGNAL: -69 dBm

806 - 817 MHz
C4FM uplink transmit
Mobile
90.210(b)
Below AGC threshold
OUTPUT SIGNAL:

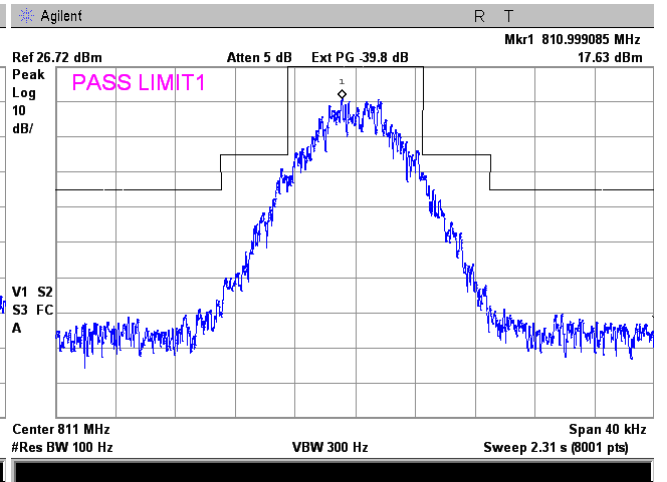
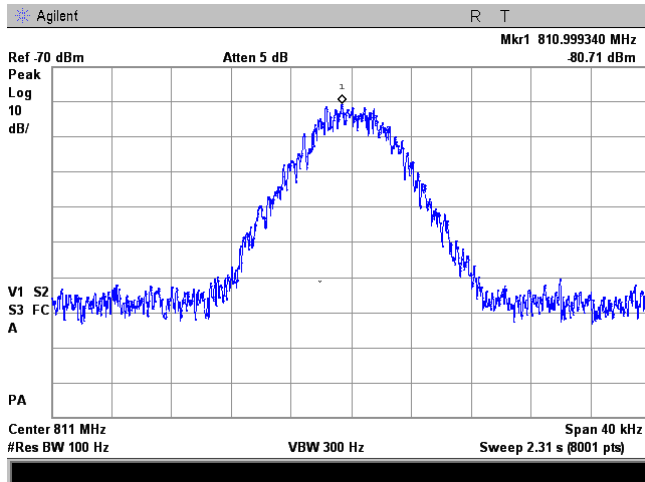

CONFIGURATION:
INPUT SIGNAL: -51 dBm

Above AGC threshold +3dB
OUTPUT SIGNAL:

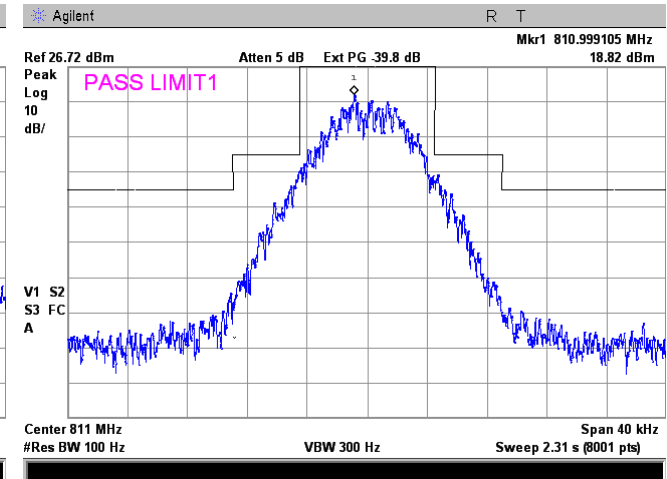
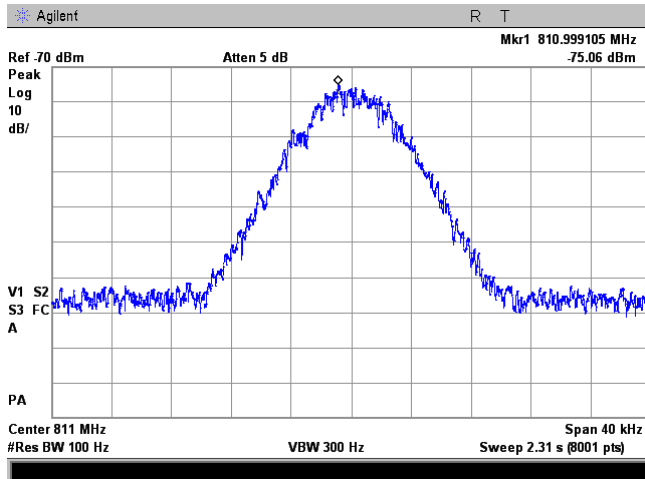



HERMON LABORATORIES

Test specification: Sections 90.210(b), 90.210(h), 90.210(g), Emission mask			
Test procedure: 47 CFR, Sections 2.1051, 2.1047 and 90.210(b); KDB 935210 D05 v01r01, section 4.4			
Test mode: Compliance		Verdict: PASS	
Date(s): 23-Mar-16 - 24-Mar-16			
Temperature: 23.2 °C	Relative Humidity: 48 %	Air Pressure: 1010 hPa	Power supply: 120 VAC
Remarks:			

Plot 7.4.3 Emission mask test result at mid frequency carrier, Port 1

FREQUENCY RANGE:
OPERATIONAL MODE:
INPUT PORT:
EMISSION MASK:
CONFIGURATION:
INPUT SIGNAL: -56 dBm

851 - 862 MHz
iDEN QAM downlink transmit
Base
90.210(b)
Below AGC threshold
OUTPUT SIGNAL:

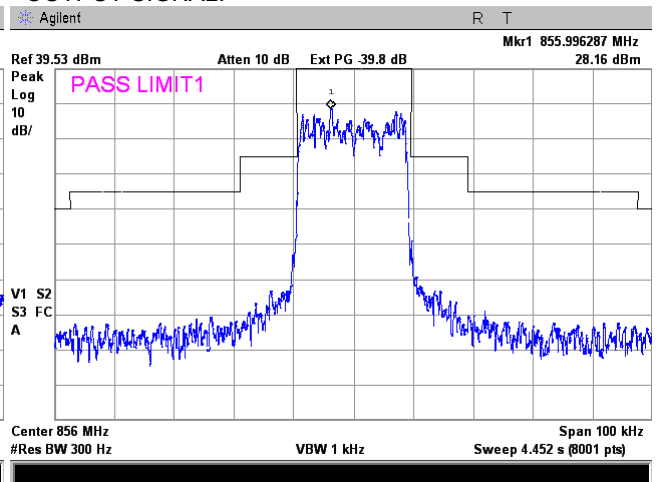
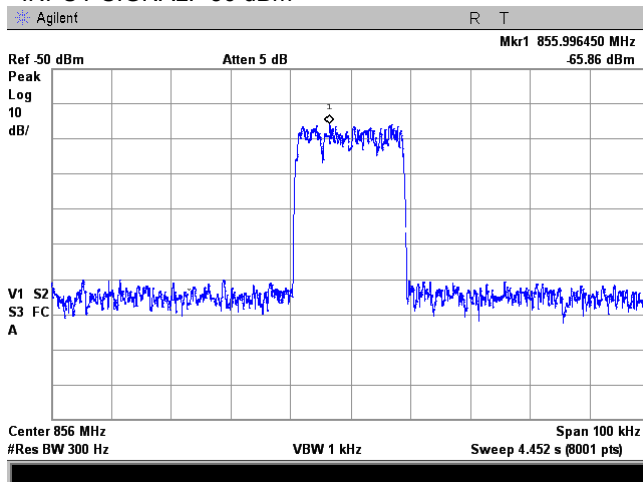

CONFIGURATION:
INPUT SIGNAL: -51 dBm

Above AGC threshold +3dB
OUTPUT SIGNAL:

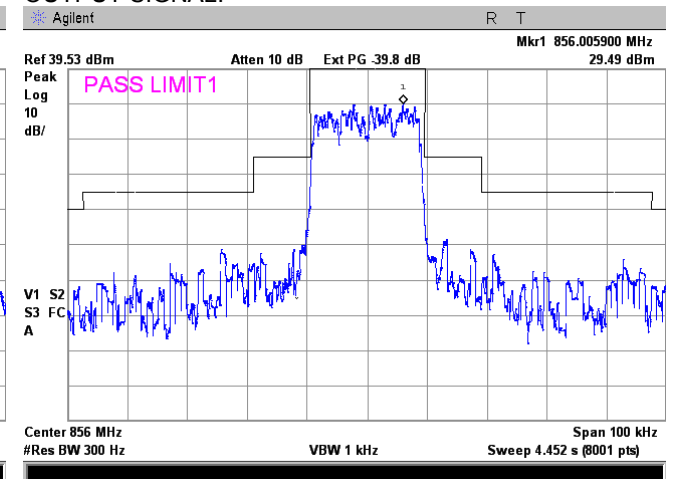
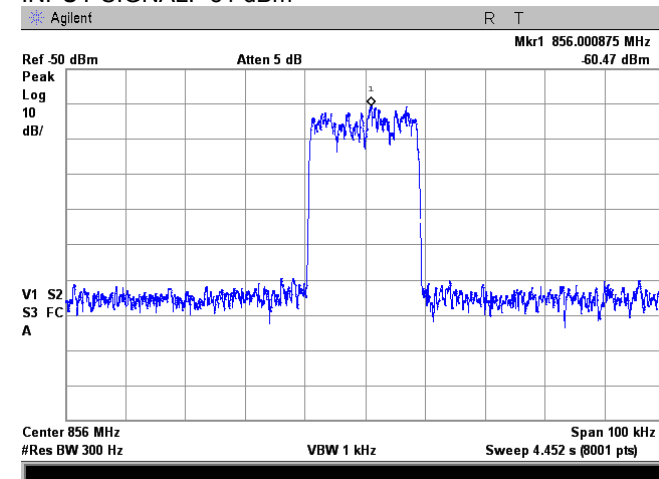



HERMON LABORATORIES

Test specification: Sections 90.210(b), 90.210(h), 90.210(g), Emission mask			
Test procedure: 47 CFR, Sections 2.1051, 2.1047 and 90.210(b); KDB 935210 D05 v01r01, section 4.4			
Test mode: Compliance		Verdict: PASS	
Date(s): 23-Mar-16 - 24-Mar-16			
Temperature: 23.2 °C	Relative Humidity: 48 %	Air Pressure: 1010 hPa	Power supply: 120 VAC
Remarks:			

Plot 7.4.4 Emission mask test result at mid frequency carrier, Port 2

FREQUENCY RANGE:
OPERATIONAL MODE:
INPUT PORT:
EMISSION MASK:
CONFIGURATION:
INPUT SIGNAL: -69 dBm

806 - 817 MHz
iDEN QAM uplink transmit
Base
90.210(b)
Below AGC threshold
OUTPUT SIGNAL:

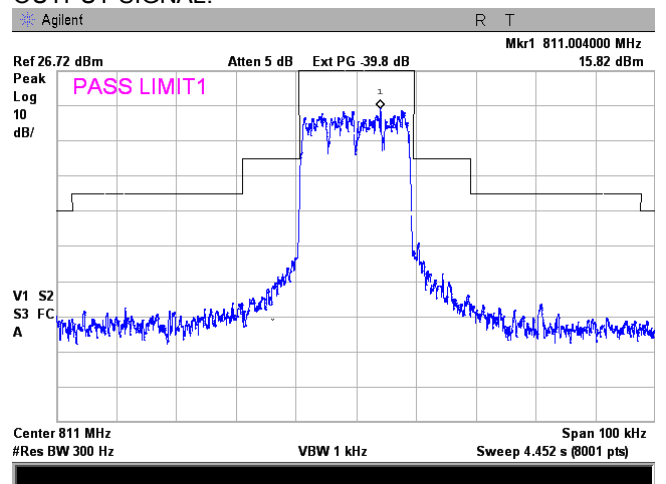
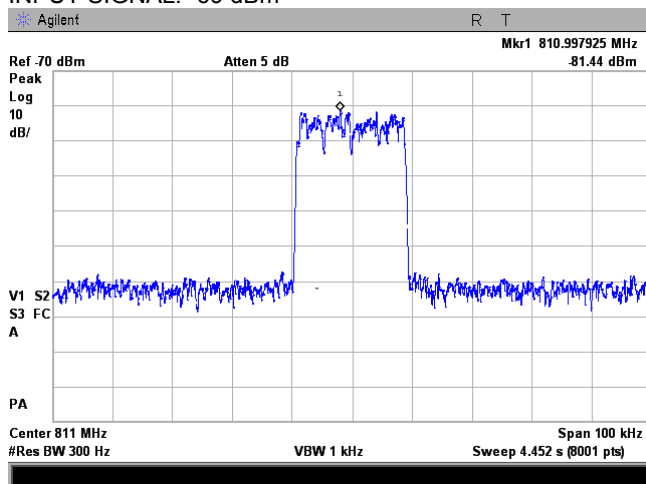

CONFIGURATION:
INPUT SIGNAL: -51 dBm

Above AGC threshold +3dB
OUTPUT SIGNAL:

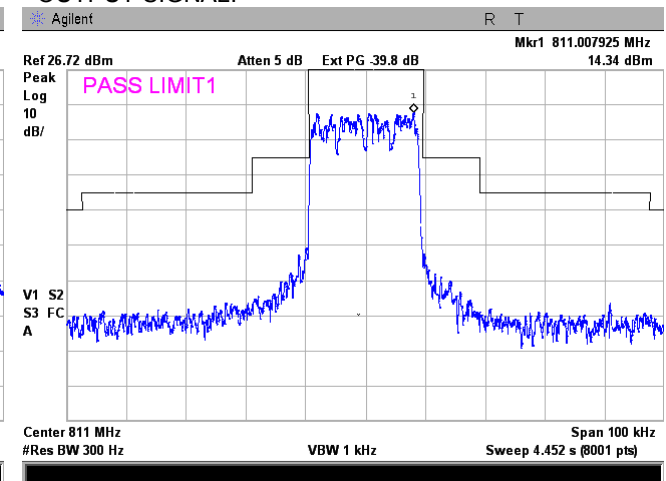
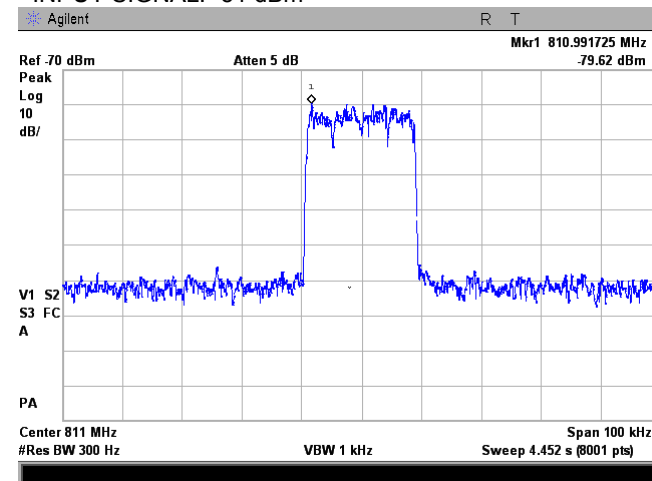



HERMON LABORATORIES

Test specification: Sections 90.210(b), 90.210(h), 90.210(g), Emission mask			
Test procedure: 47 CFR, Sections 2.1051, 2.1047 and 90.210(b); KDB 935210 D05 v01r01, section 4.4			
Test mode: Compliance		Verdict: PASS	
Date(s): 23-Mar-16 - 24-Mar-16			
Temperature: 23.2 °C	Relative Humidity: 48 %	Air Pressure: 1010 hPa	Power supply: 120 VAC
Remarks:			

Plot 7.4.5 Emission mask test result at mid frequency carrier, Port 1

FREQUENCY RANGE:
OPERATIONAL MODE:
INPUT PORT:
EMISSION MASK:
CONFIGURATION:
INPUT SIGNAL: -56 dBm

851 - 862 MHz
Analog FM downlink transmit 10kHz/1kHz
Base
90.210(b)
Below AGC threshold
OUTPUT SIGNAL:

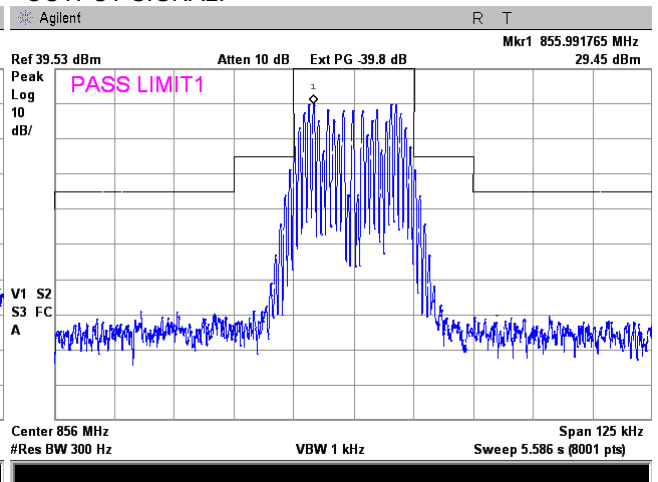
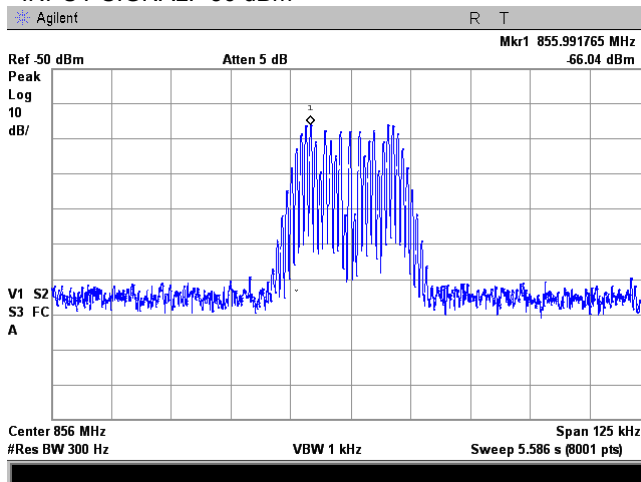

CONFIGURATION:
INPUT SIGNAL: -51 dBm

Above AGC threshold +3dB
OUTPUT SIGNAL:

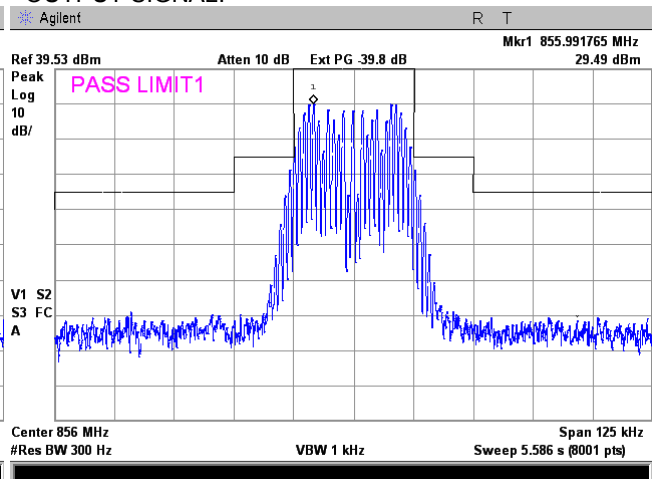
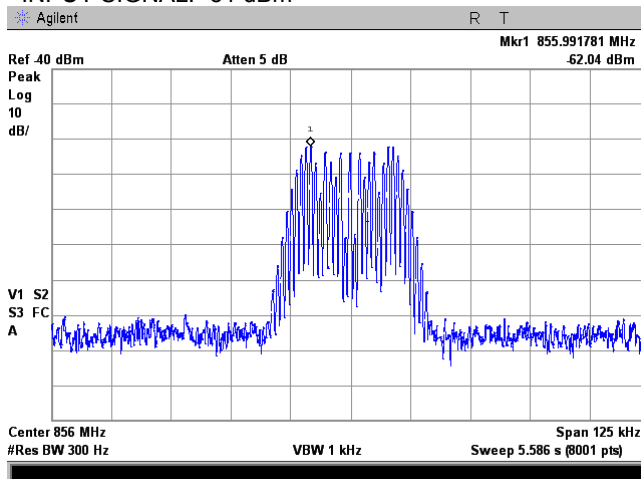



HERMON LABORATORIES

Test specification: Sections 90.210(b), 90.210(h), 90.210(g), Emission mask			
Test procedure: 47 CFR, Sections 2.1051, 2.1047 and 90.210(b); KDB 935210 D05 v01r01, section 4.4			
Test mode: Compliance		Verdict: PASS	
Date(s): 23-Mar-16 - 24-Mar-16			
Temperature: 23.2 °C	Relative Humidity: 48 %	Air Pressure: 1010 hPa	Power supply: 120 VAC
Remarks:			

Plot 7.4.6 Emission mask test result at mid frequency carrier, Port 2

FREQUENCY RANGE:
OPERATIONAL MODE:
INPUT PORT:
EMISSION MASK:
CONFIGURATION:
INPUT POWER: -69 dBm

806 - 817 MHz
Analog FM uplink transmit 10kHz/1kHz
Mobile
90.210(b)
Below AGC threshold
OUTPUT SIGNAL:

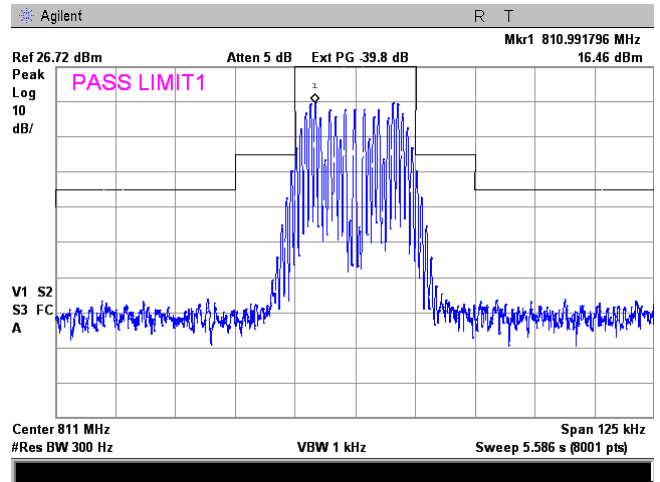
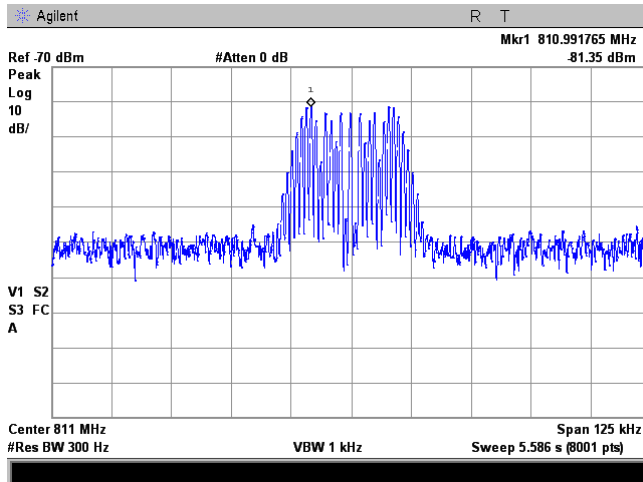

CONFIGURATION:
INPUT SIGNAL: -64 dBm

Above AGC threshold +3dB
OUTPUT SIGNAL:

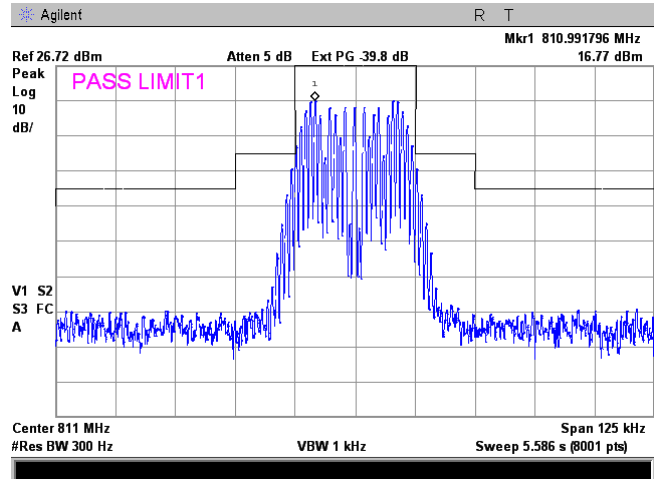
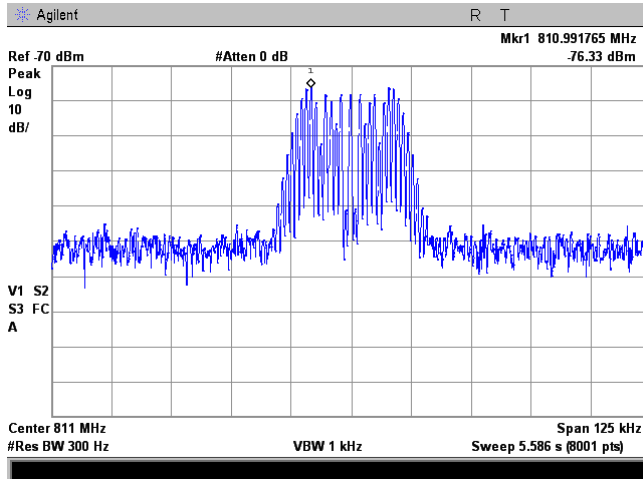



HERMON LABORATORIES

Test specification: Sections 90.210(b), 90.210(h), 90.210(g), Emission mask			
Test procedure: 47 CFR, Sections 2.1051, 2.1047 and 90.210(b); KDB 935210 D05 v01r01, section 4.4			
Test mode: Compliance		Verdict: PASS	
Date(s): 23-Mar-16 - 24-Mar-16			
Temperature: 23.2 °C	Relative Humidity: 48 %	Air Pressure: 1010 hPa	Power supply: 120 VAC
Remarks:			

Plot 7.4.7 Emission mask test result at mid frequency carrier, Port 1

FREQUENCY RANGE:
OPERATIONAL MODE:
INPUT PORT:
EMISSION MASK:
CONFIGURATION:
INPUT SIGNAL: -56 dBm

851 - 862 MHz
Analog FM downlink transmit 16K0F3E
Base
90.210(b)
Below AGC threshold
OUTPUT SIGNAL:

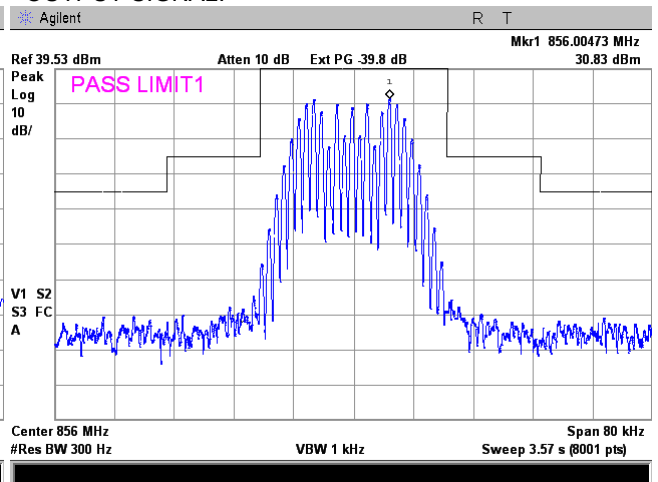
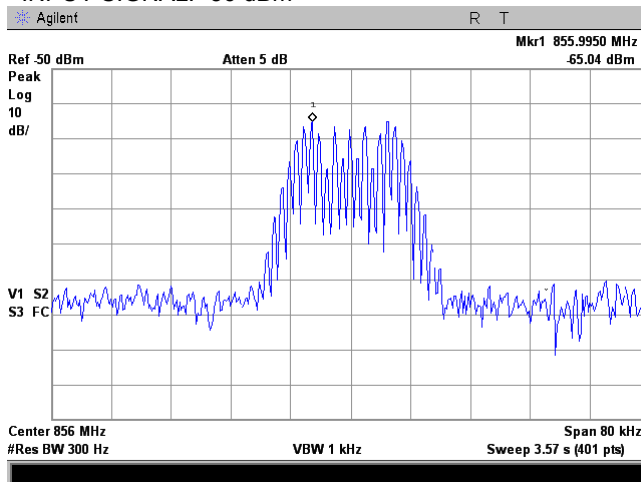

CONFIGURATION:
INPUT SIGNAL: -51 dBm

Above AGC threshold +3dB
OUTPUT SIGNAL:

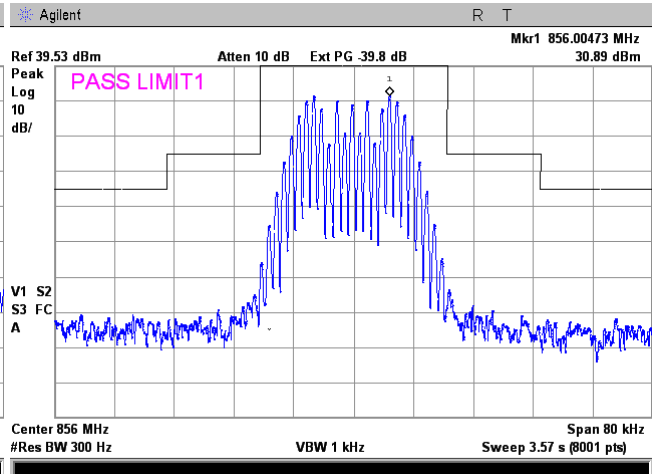
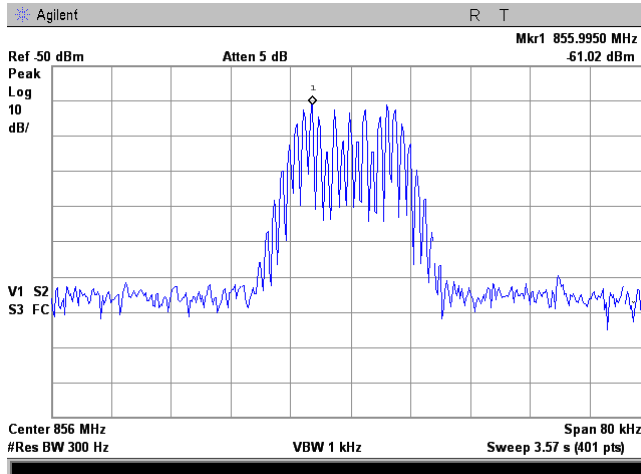



HERMON LABORATORIES

Test specification: Sections 90.210(b), 90.210(h), 90.210(g), Emission mask			
Test procedure: 47 CFR, Sections 2.1051, 2.1047 and 90.210(b); KDB 935210 D05 v01r01, section 4.4			
Test mode: Compliance		Verdict: PASS	
Date(s): 23-Mar-16 - 24-Mar-16			
Temperature: 23.2 °C	Relative Humidity: 48 %	Air Pressure: 1010 hPa	Power supply: 120 VAC
Remarks:			

Plot 7.4.8 Emission mask test result at mid frequency carrier, Port 2

FREQUENCY RANGE:
OPERATIONAL MODE:
INPUT PORT:
EMISSION MASK:
CONFIGURATION:
INPUT SIGNAL: -69 dBm

806 - 817 MHz
Analog FM uplink transmit 16K0F3E
Mobile
90.210(b)
Below AGC threshold
OUTPUT SIGNAL:

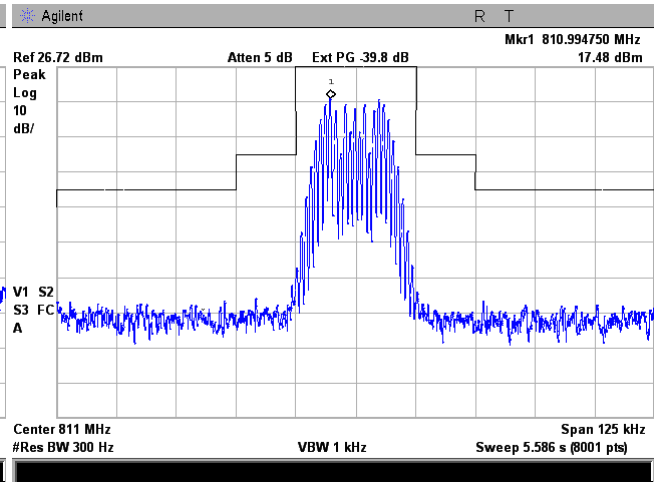
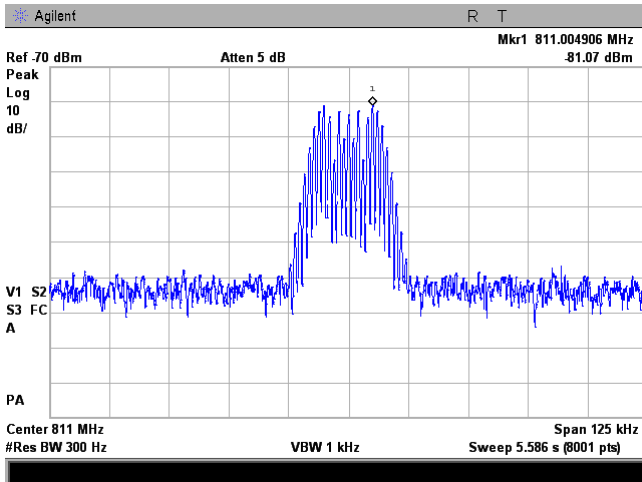

CONFIGURATION:
INPUT SIGNAL: -64 dBm

Above AGC threshold +3dB
OUTPUT SIGNAL:

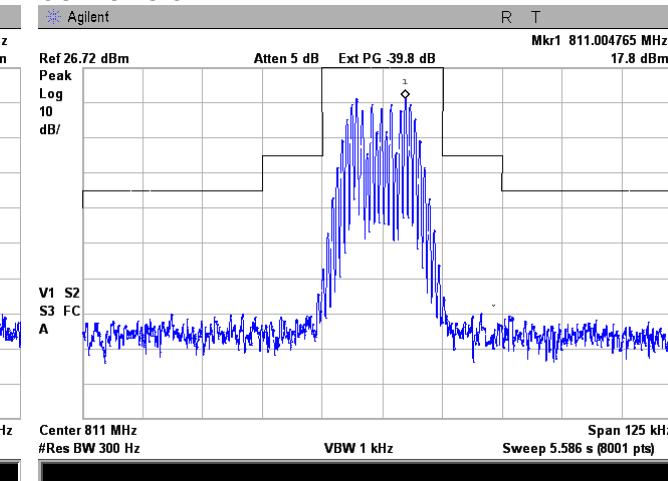
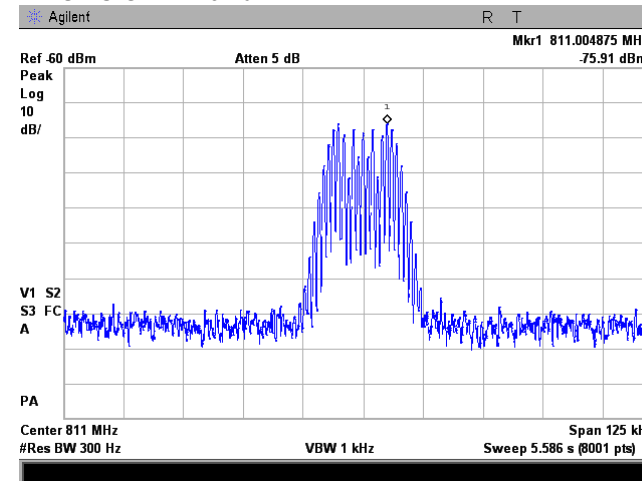



HERMON LABORATORIES

Test specification: Sections 90.210(b), 90.210(h), 90.210(g), Emission mask			
Test procedure: 47 CFR, Sections 2.1051, 2.1047 and 90.210(b); KDB 935210 D05 v01r01, section 4.4			
Test mode: Compliance		Verdict: PASS	
Date(s): 23-Mar-16 - 24-Mar-16			
Temperature: 23.2 °C	Relative Humidity: 48 %	Air Pressure: 1010 hPa	Power supply: 120 VAC
Remarks:			

Plot 7.4.9 Emission mask test result at mid frequency carrier, Port 1

FREQUENCY RANGE:
OPERATIONAL MODE:
INPUT PORT:
EMISSION MASK:
CONFIGURATION:
INPUT SIGNAL: -56 dBm

851 - 862 MHz
Analog FM uplink transmit 11K3F3E
Base
90.210(b)
Below AGC threshold
OUTPUT SIGNAL:

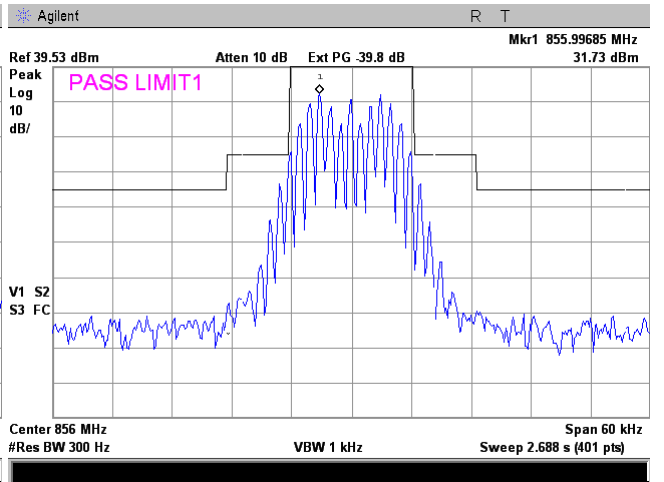
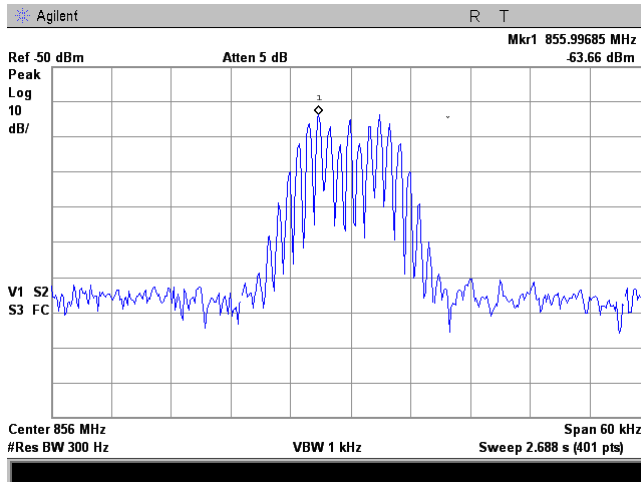

CONFIGURATION:
INPUT SIGNAL: -51 dBm

Above AGC threshold +3dB
OUTPUT SIGNAL:

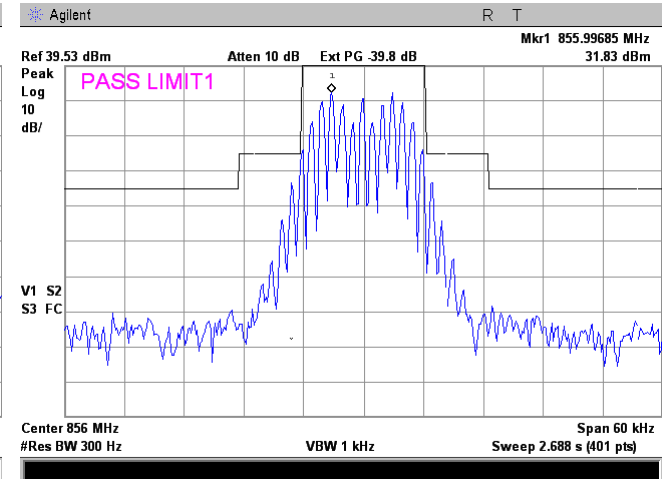
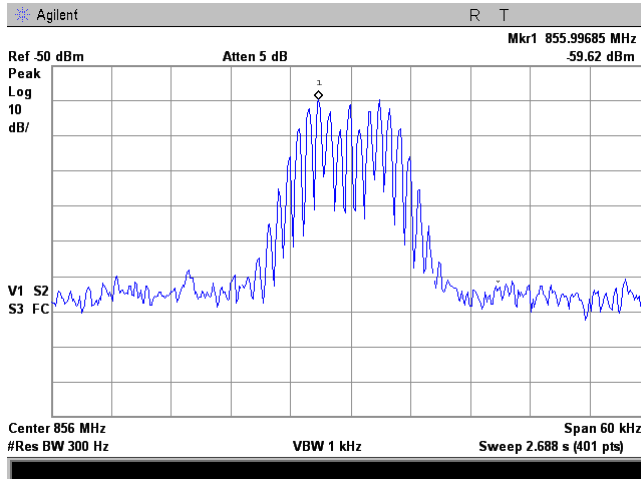



HERMON LABORATORIES

Test specification: Sections 90.210(b), 90.210(h), 90.210(g), Emission mask			
Test procedure: 47 CFR, Sections 2.1051, 2.1047 and 90.210(b); KDB 935210 D05 v01r01, section 4.4			
Test mode: Compliance		Verdict: PASS	
Date(s): 23-Mar-16 - 24-Mar-16			
Temperature: 23.2 °C	Relative Humidity: 48 %	Air Pressure: 1010 hPa	Power supply: 120 VAC
Remarks:			

Plot 7.4.10 Emission mask test result at mid frequency carrier, Port 2

FREQUENCY RANGE:
OPERATIONAL MODE:
INPUT PORT:
EMISSION MASK:
CONFIGURATION:
INPUT SIGNAL: -56 dBm

806 - 817 MHz
Analog FM uplink transmit 11K3F3E 4.17kHz
Mobile
90.210(b)
Below AGC threshold
OUTPUT SIGNAL:

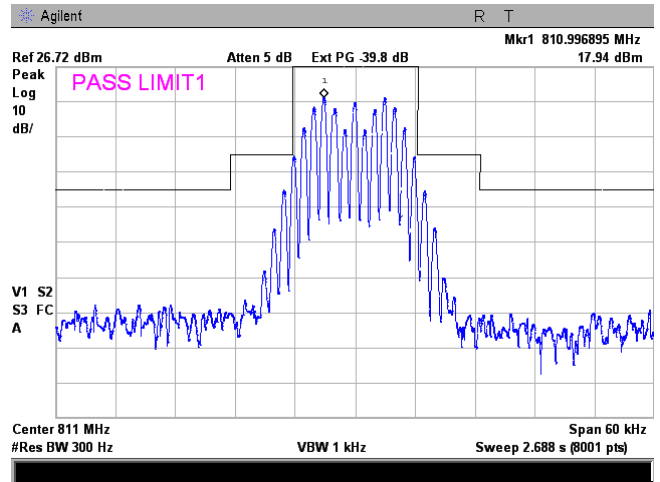
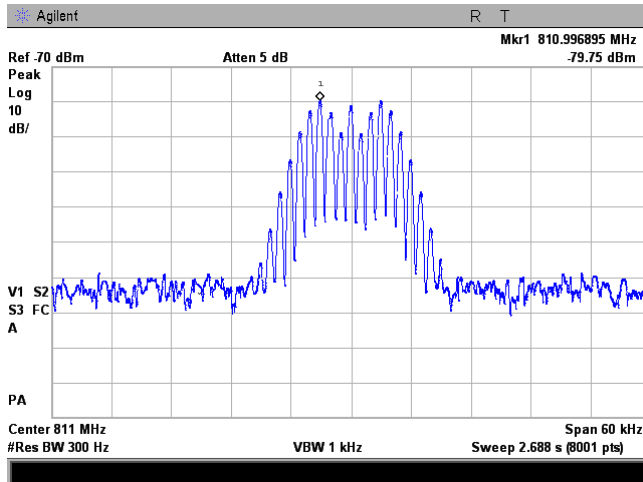

CONFIGURATION:
INPUT SIGNAL: -64 dBm

Above AGC threshold +3dB
OUTPUT SIGNAL:

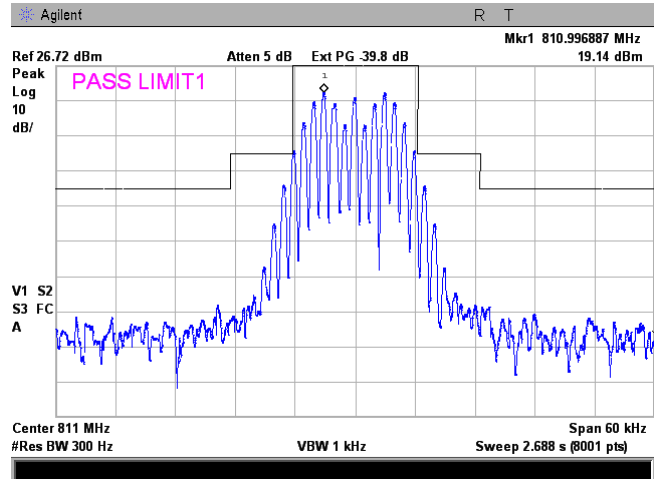
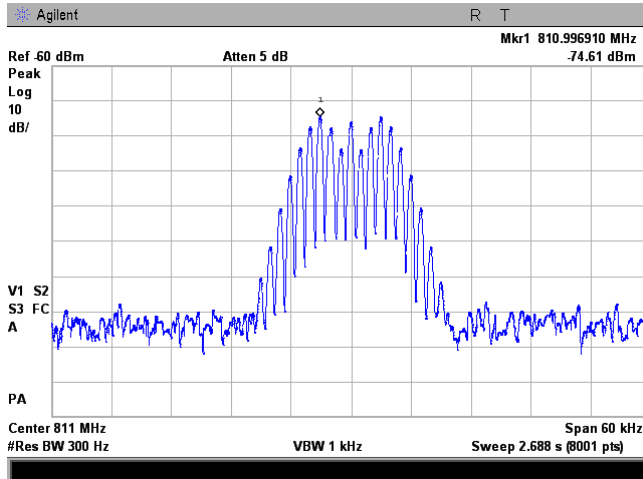



HERMON LABORATORIES

Test specification: Sections 90.210(b), 90.210(h), 90.210(g), Emission mask			
Test procedure: 47 CFR, Sections 2.1051, 2.1047 and 90.210(b); KDB 935210 D05 v01r01, section 4.4			
Test mode: Compliance		Verdict: PASS	
Date(s): 23-Mar-16 - 24-Mar-16			
Temperature: 23.2 °C	Relative Humidity: 48 %	Air Pressure: 1010 hPa	Power supply: 120 VAC
Remarks:			

Plot 7.4.11 Emission mask test result at mid frequency carrier, Port 1

FREQUENCY RANGE:
OPERATIONAL MODE:
INPUT PORT:
EMISSION MASK:
CONFIGURATION:
INPUT SIGNAL: -56 dBm

851 - 862 MHz
Digital FM downlink transmit
Base
90.210(b)
Below AGC threshold
OUTPUT SIGNAL:

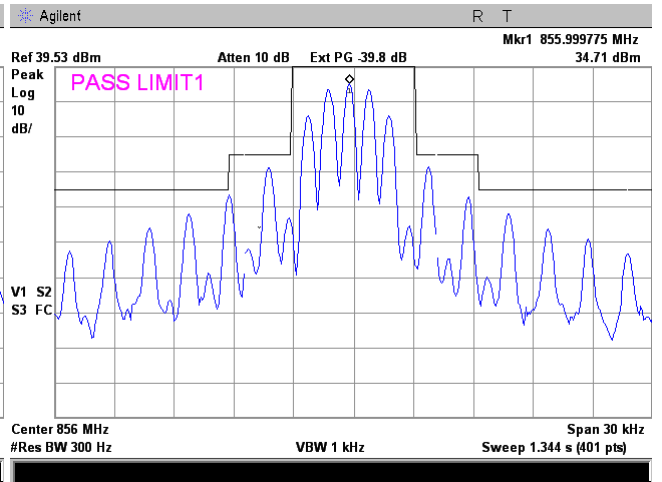
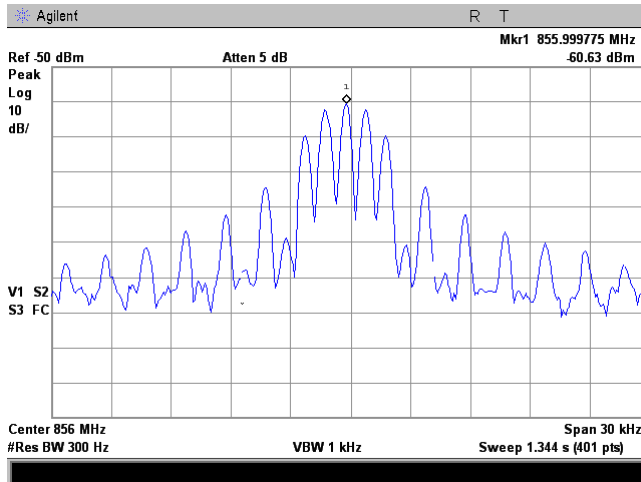

CONFIGURATION:
INPUT SIGNAL: -51 dBm

Above AGC threshold +3dB
OUTPUT SIGNAL:

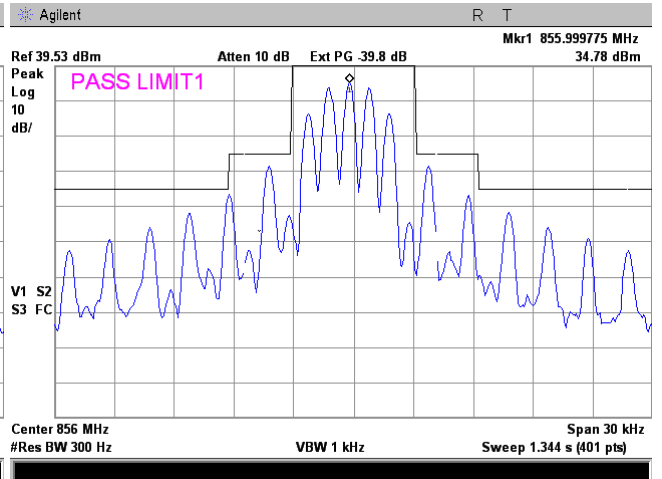
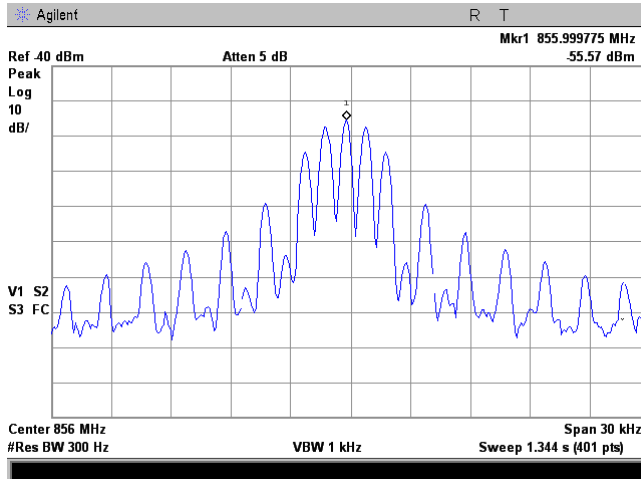



HERMON LABORATORIES

Test specification: Sections 90.210(b), 90.210(h), 90.210(g), Emission mask			
Test procedure: 47 CFR, Sections 2.1051, 2.1047 and 90.210(b); KDB 935210 D05 v01r01, section 4.4			
Test mode: Compliance		Verdict: PASS	
Date(s): 23-Mar-16 - 24-Mar-16			
Temperature: 23.2 °C	Relative Humidity: 48 %	Air Pressure: 1010 hPa	Power supply: 120 VAC
Remarks:			

Plot 7.4.12 Emission mask test result at mid frequency carrier, Port 2

FREQUENCY RANGE:
 OPERATIONAL MODE:
 INPUT PORT:
 EMISSION MASK:
 CONFIGURATION:
 INPUT SIGNAL: -69 dBm

806 - 817 MHz
 Digital FM uplink transmit
 Mobile
 90.210(b)
 Below AGC threshold
 OUTPUT SIGNAL:

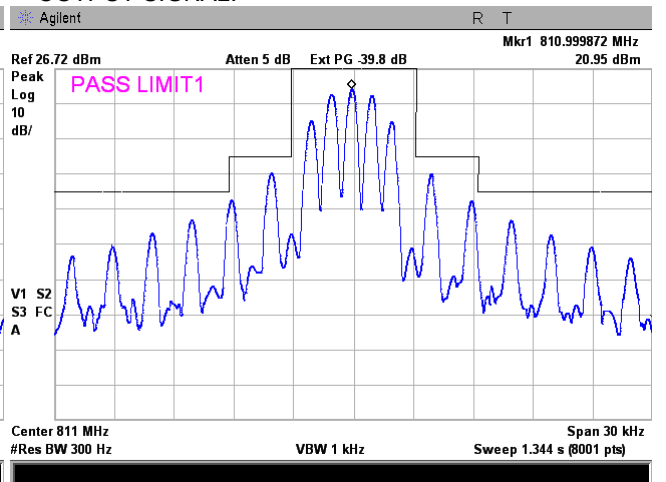
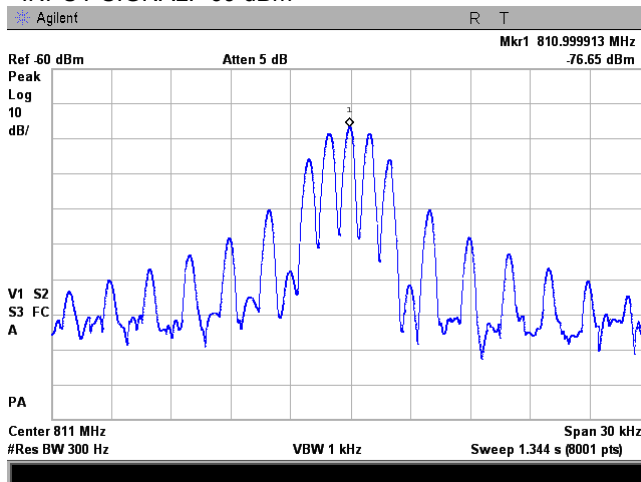

CONFIGURATION:
 INPUT SIGNAL: -64 dBm

Above AGC threshold +3dB
 OUTPUT SIGNAL:

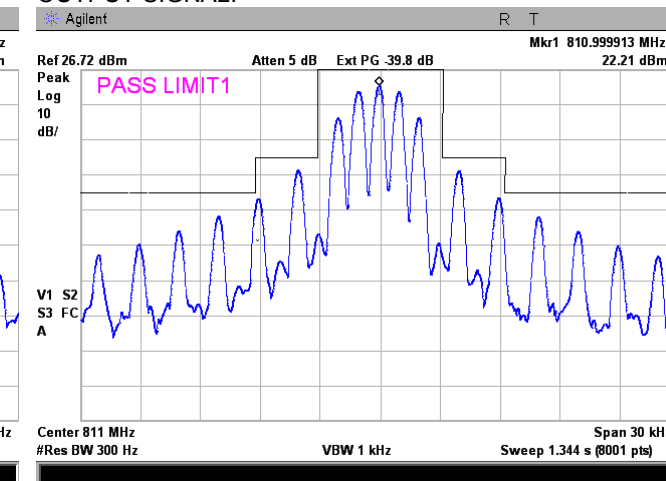
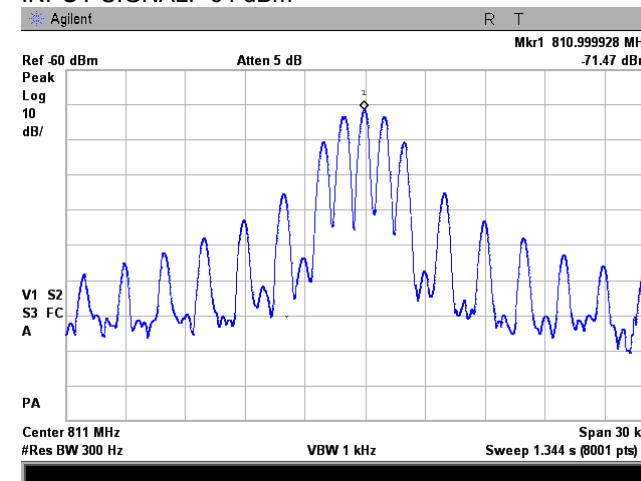



HERMON LABORATORIES

Test specification: Sections 90.210(b), 90.210(h), 90.210(g), Emission mask			
Test procedure: 47 CFR, Sections 2.1051, 2.1047 and 90.210(b); KDB 935210 D05 v01r01, section 4.4			
Test mode: Compliance		Verdict: PASS	
Date(s): 23-Mar-16 - 24-Mar-16			
Temperature: 23.2 °C	Relative Humidity: 48 %	Air Pressure: 1010 hPa	Power supply: 120 VAC
Remarks:			

Plot 7.4.13 Emission mask test result at mid frequency carrier, Port 1

FREQUENCY RANGE:
 OPERATIONAL MODE:
 INPUT PORT:
 EMISSION MASK:
 CONFIGURATION:
 INPUT SIGNAL: -56 dBm

851 - 862 MHz
 Digital FM downlink transmit
 Base
 90.210(b)
 Below AGC threshold
 OUTPUT SIGNAL:

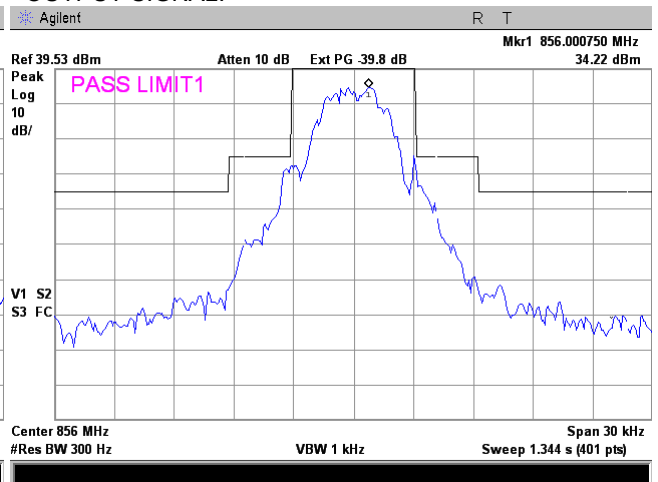
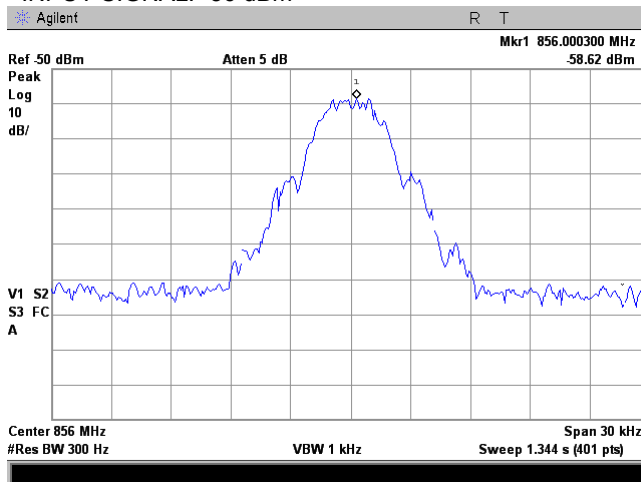

CONFIGURATION:
 INPUT SIGNAL: -51 dBm

Above AGC threshold +3dB
 OUTPUT SIGNAL:

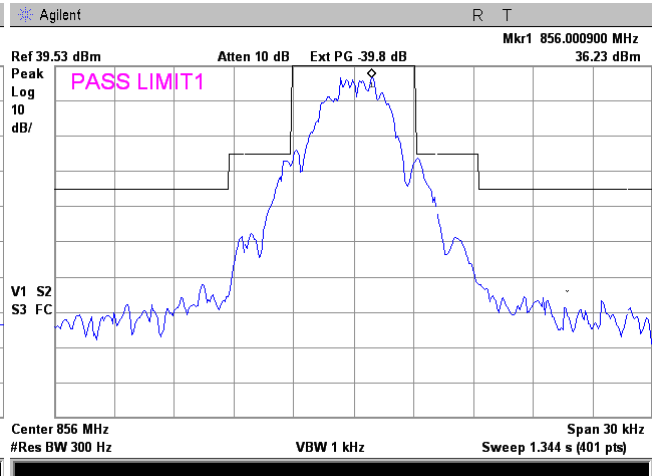
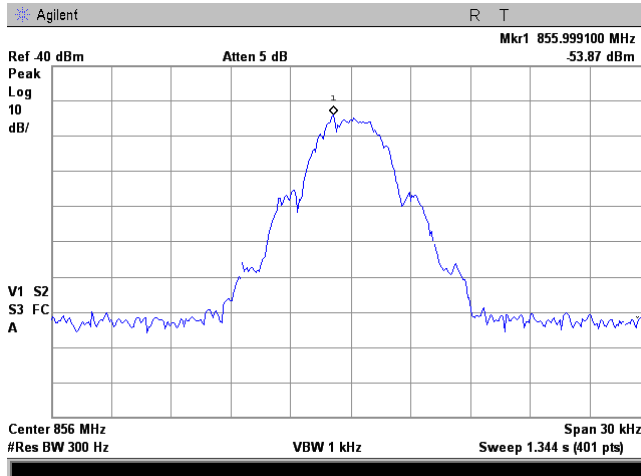



HERMON LABORATORIES

Test specification: Sections 90.210(b), 90.210(h), 90.210(g), Emission mask			
Test procedure: 47 CFR, Sections 2.1051, 2.1047 and 90.210(b); KDB 935210 D05 v01r01, section 4.4			
Test mode: Compliance		Verdict: PASS	
Date(s): 23-Mar-16 - 24-Mar-16			
Temperature: 23.2 °C	Relative Humidity: 48 %	Air Pressure: 1010 hPa	Power supply: 120 VAC
Remarks:			

Plot 7.4.14 Emission mask test result at mid frequency carrier, Port 2

FREQUENCY RANGE:
OPERATIONAL MODE:
INPUT PORT:
EMISSION MASK:
CONFIGURATION:
INPUT SIGNAL: -69 dBm

806 - 817 MHz
Digital FM downlink transmit
Mobile
90.210(b)
Below AGC threshold
OUTPUT SIGNAL:

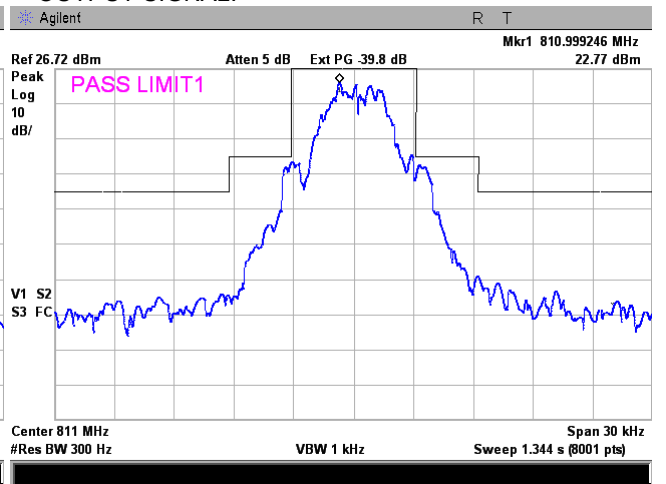
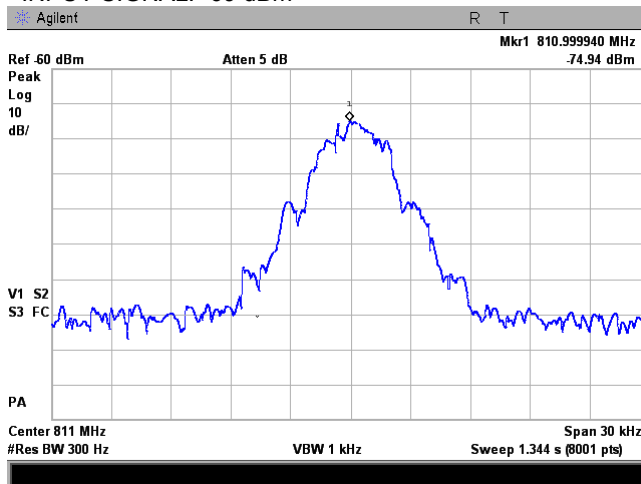

CONFIGURATION:
INPUT SIGNAL: -64 dBm

Above AGC threshold +3dB
OUTPUT SIGNAL:

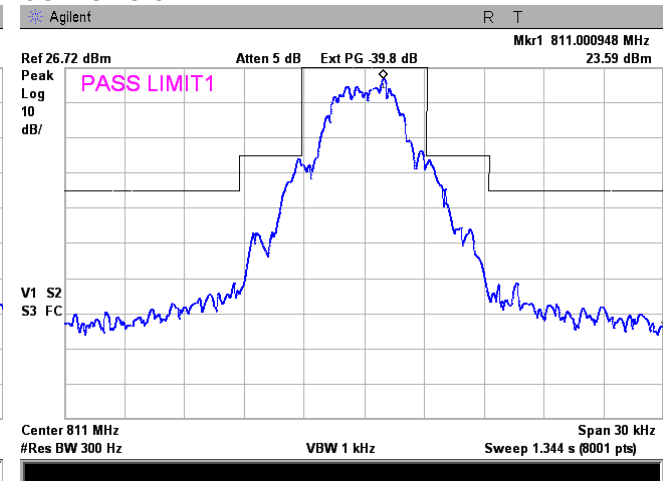
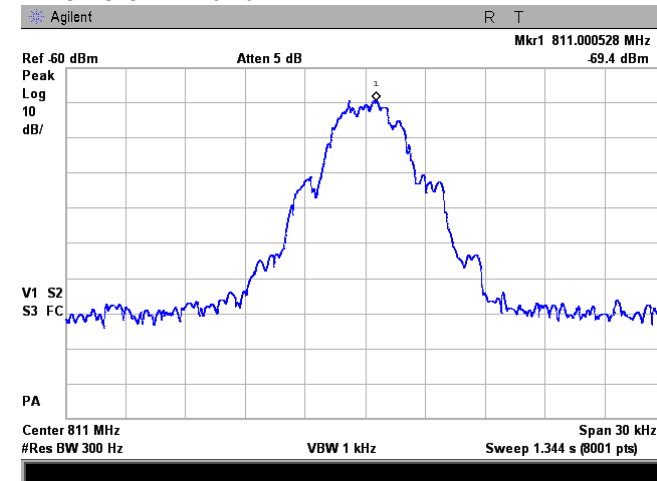



HERMON LABORATORIES

Test specification: Sections 90.210(b), 90.210(h), 90.210(g), Emission mask			
Test procedure: 47 CFR, Sections 2.1051, 2.1047 and 90.210(b); KDB 935210 D05 v01r01, section 4.4			
Test mode: Compliance		Verdict: PASS	
Date(s): 23-Mar-16 - 24-Mar-16			
Temperature: 23.2 °C	Relative Humidity: 48 %	Air Pressure: 1010 hPa	Power supply: 120 VAC
Remarks:			

Plot 7.4.15 Emission mask reference level test result at mid frequency carrier, Port 1

FRQUENCY RANGE: 851 - 854 MHz
 OPERATIONAL MODE: C4FM downlink transmit
 INPUT PORT: Base
 EMISSION MASK: 90.210(h)
 CONFIGURATION: Below AGC threshold
 INPUT SIGNAL: -56 dBm
 OUTPUT SIGNAL:

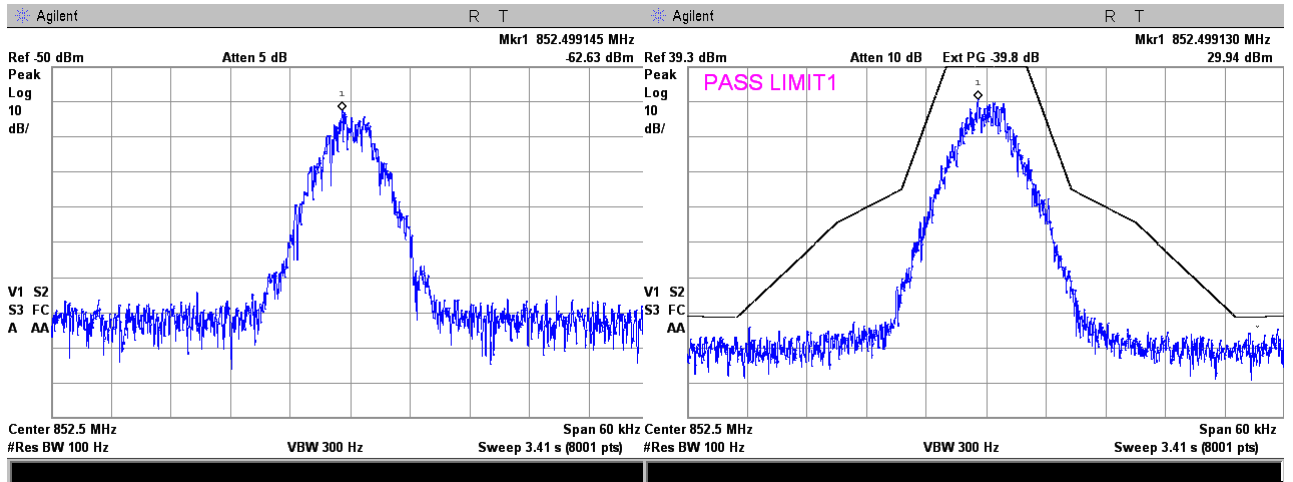

CONFIGURATION: Above AGC threshold +3dB
 INPUT SIGNAL: -51 dBm
 OUTPUT SIGNAL:

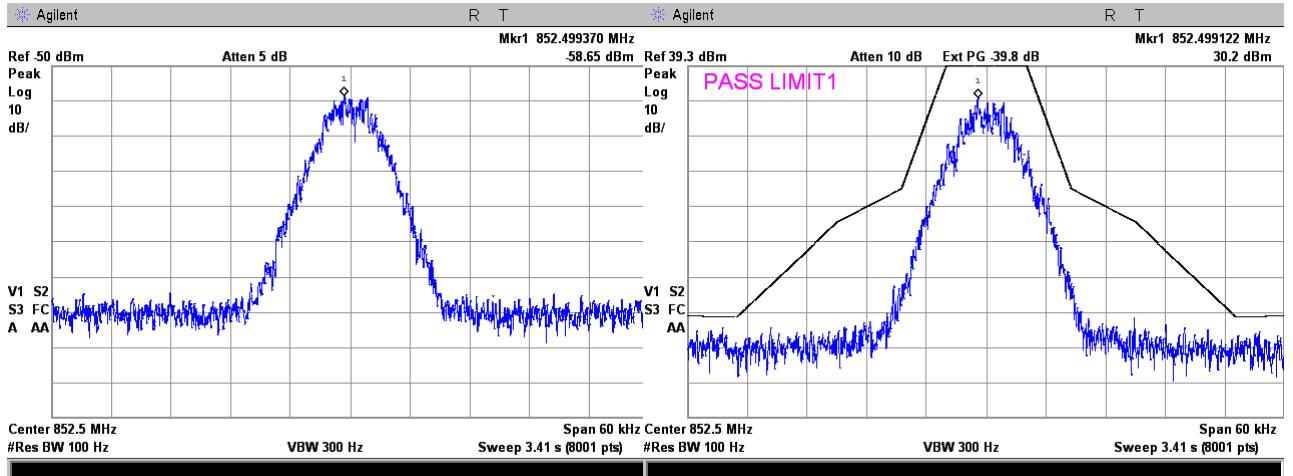



HERMON LABORATORIES

Test specification: Sections 90.210(b), 90.210(h), 90.210(g), Emission mask			
Test procedure: 47 CFR, Sections 2.1051, 2.1047 and 90.210(b); KDB 935210 D05 v01r01, section 4.4			
Test mode: Compliance		Verdict: PASS	
Date(s): 23-Mar-16 - 24-Mar-16			
Temperature: 23.2 °C	Relative Humidity: 48 %	Air Pressure: 1010 hPa	Power supply: 120 VAC
Remarks:			

Plot 7.4.16 Emission mask test result at low frequency carrier, Port 2

FREQUENCY RANGE:
OPERATIONAL MODE:
INPUT PORT:
EMISSION MASK:
CONFIGURATION:
INPUT SIGNAL: -69 dBm

806 - 809 MHz
C4FM uplink transmit
Mobile
90.210(h)
Below AGC threshold
OUTPUT SIGNAL:

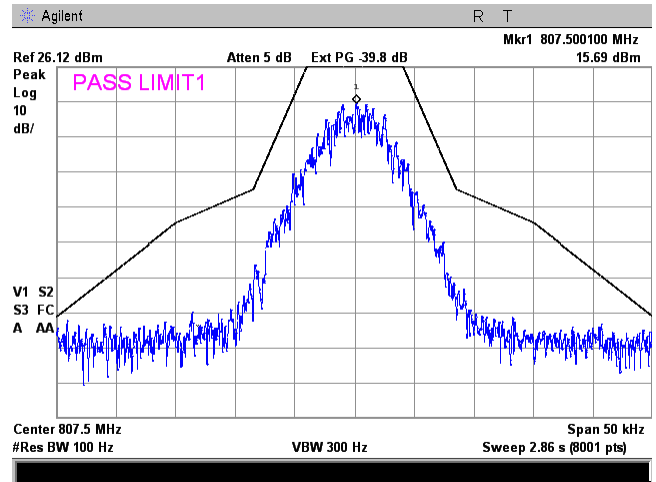
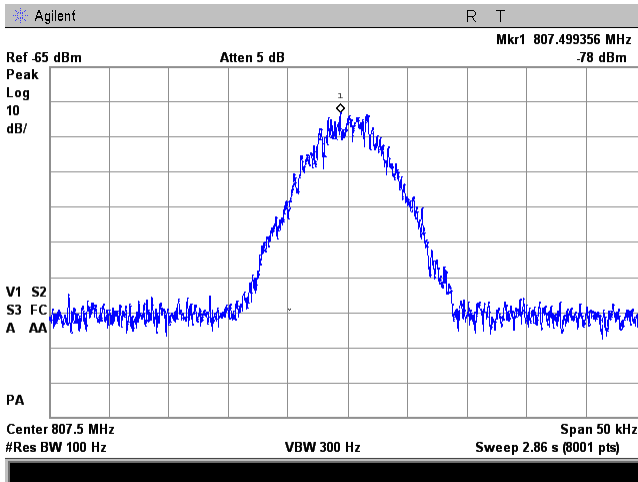

CONFIGURATION:
INPUT SIGNAL: -64 dBm

Above AGC threshold +3dB
OUTPUT SIGNAL:

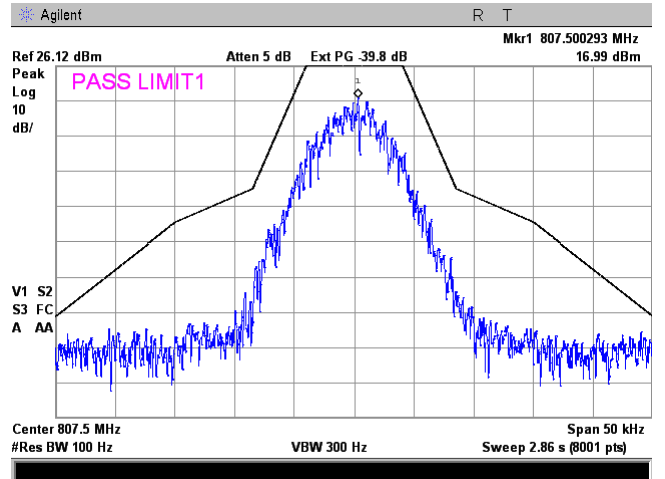
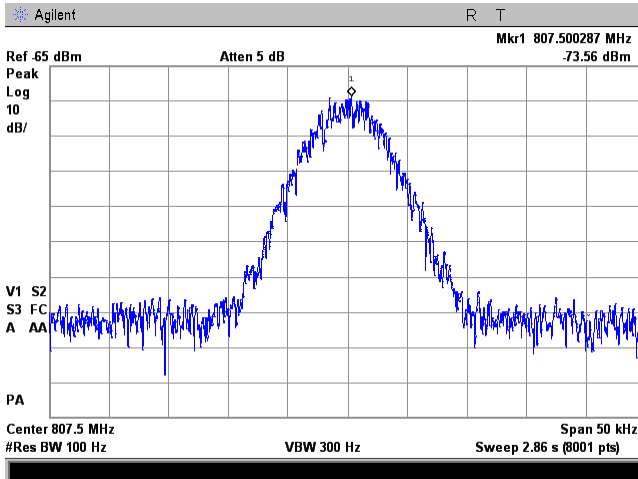



HERMON LABORATORIES

Test specification: Sections 90.210(b), 90.210(h), 90.210(g), Emission mask			
Test procedure: 47 CFR, Sections 2.1051, 2.1047 and 90.210(b); KDB 935210 D05 v01r01, section 4.4			
Test mode: Compliance		Verdict: PASS	
Date(s): 23-Mar-16 - 24-Mar-16			
Temperature: 23.2 °C	Relative Humidity: 48 %	Air Pressure: 1010 hPa	Power supply: 120 VAC
Remarks:			

Plot 7.4.17 Emission mask test result at low frequency carrier, Port 1

FREQUENCY RANGE: 851 - 854 MHz
 OPERATIONAL MODE: Analog FM downlink transmit
 INPUT PORT: Base
 EMISSION MASK: 90.210(h)
 CONFIGURATION: Below AGC threshold
 INPUT SIGNAL: -56 dBm
 OUTPUT SIGNAL:

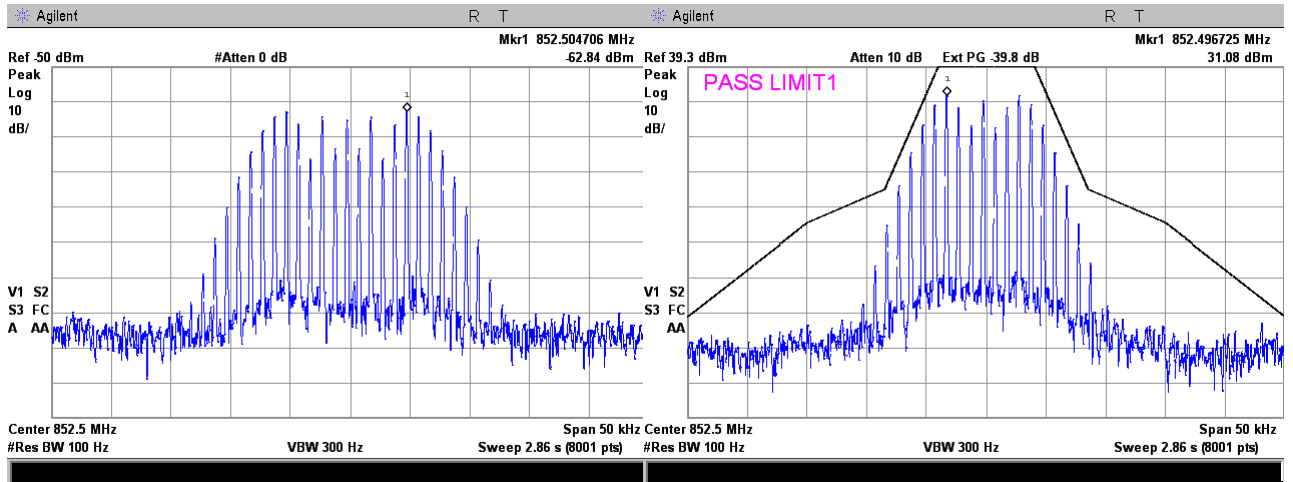

CONFIGURATION: Above AGC threshold +3dB
 INPUT SIGNAL: -51 dBm
 OUTPUT SIGNAL:

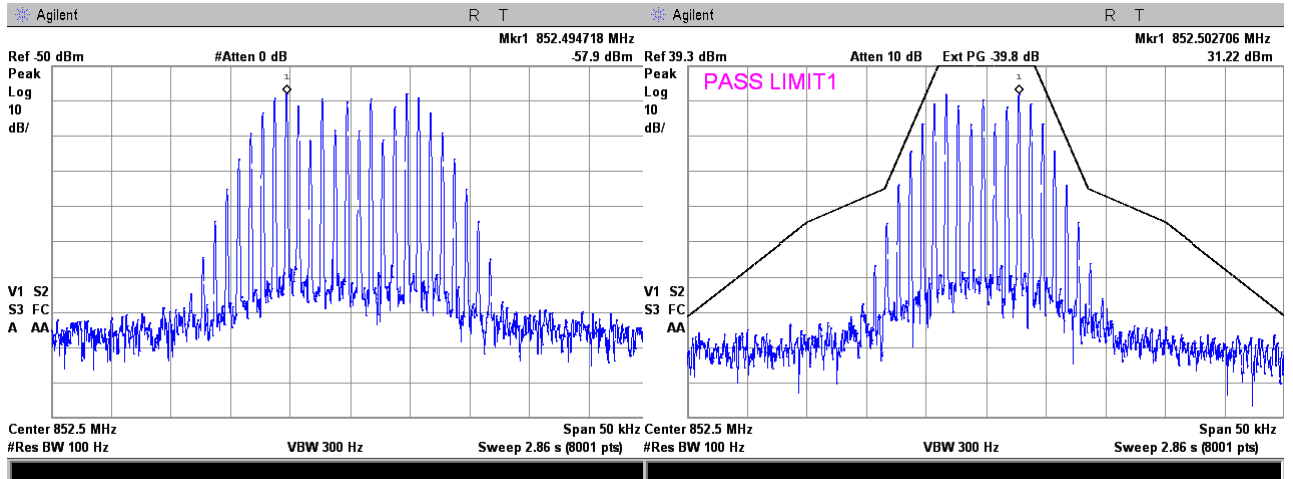



HERMON LABORATORIES

Test specification: Sections 90.210(b), 90.210(h), 90.210(g), Emission mask			
Test procedure: 47 CFR, Sections 2.1051, 2.1047 and 90.210(b); KDB 935210 D05 v01r01, section 4.4			
Test mode: Compliance		Verdict: PASS	
Date(s): 23-Mar-16 - 24-Mar-16			
Temperature: 23.2 °C	Relative Humidity: 48 %	Air Pressure: 1010 hPa	Power supply: 120 VAC
Remarks:			

Plot 7.4.18 Emission mask test result at low frequency carrier, Port 2

FRQUENCY RANGE: 806 - 809 MHz
 OPERATIONAL MODE: Analog FM downlink transmit
 INPUT PORT: Mobile
 EMISSION MASK: 90.210(h)
 CONFIGURATION: Below AGC threshold
 INPUT SIGNAL: -69 dBm
 OUTPUT SIGNAL:

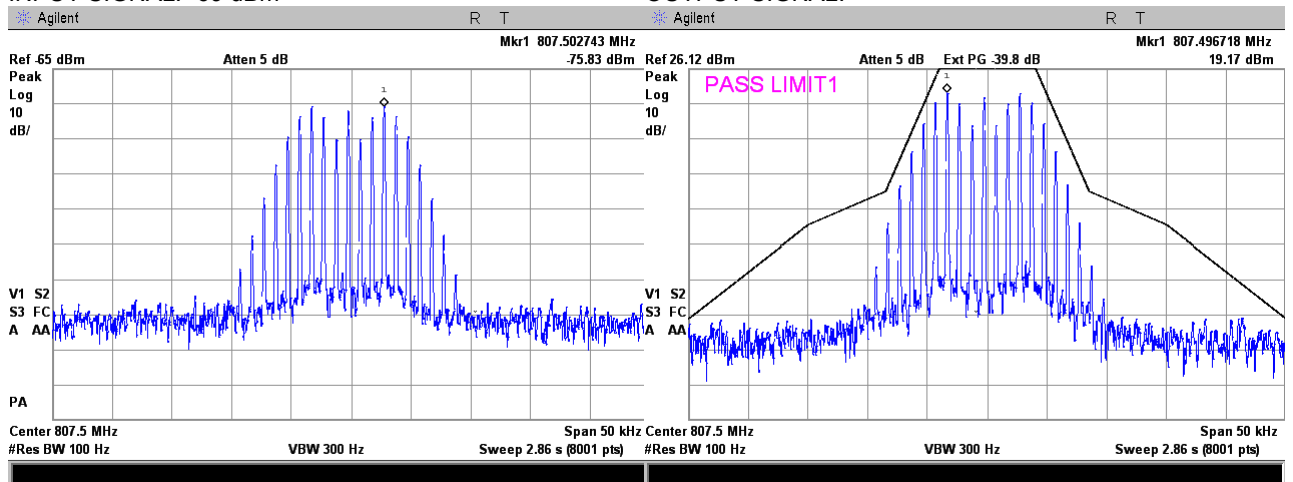

CONFIGURATION: Above AGC threshold +3dB
 INPUT SIGNAL: -64 dBm
 OUTPUT SIGNAL:

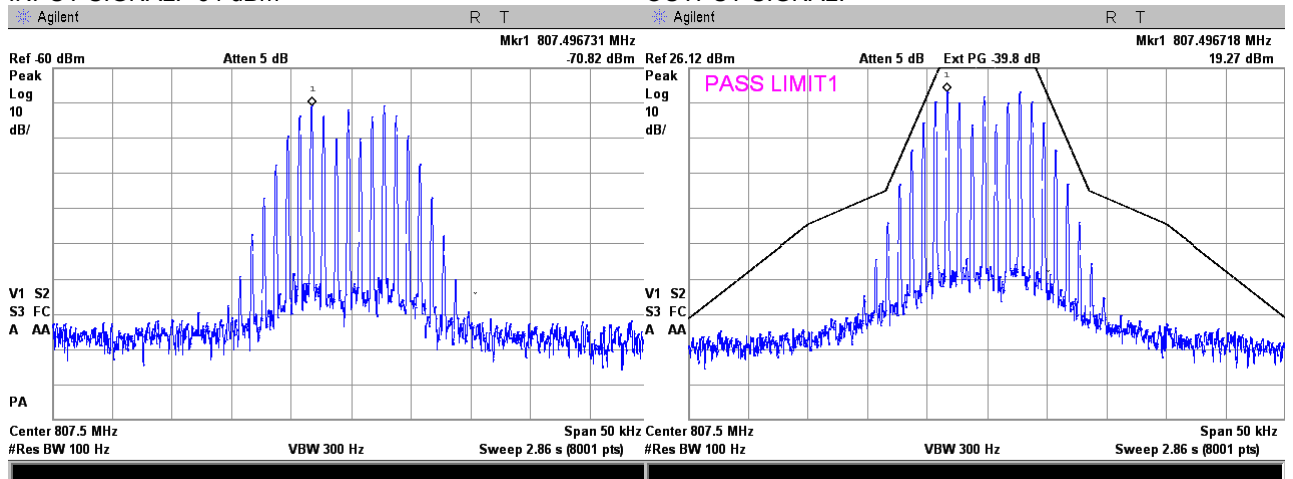



HERMON LABORATORIES

Test specification: Sections 90.210(b), 90.210(h), 90.210(g), Emission mask			
Test procedure: 47 CFR, Sections 2.1051, 2.1047 and 90.210(b); KDB 935210 D05 v01r01, section 4.4			
Test mode: Compliance		Verdict: PASS	
Date(s): 23-Mar-16 - 24-Mar-16			
Temperature: 23.2 °C	Relative Humidity: 48 %	Air Pressure: 1010 hPa	Power supply: 120 VAC
Remarks:			

Plot 7.4.19 Emission mask test result at low frequency carrier, Port 1

FREQUENCY RANGE:
OPERATIONAL MODE:
INPUT PORT:
EMISSION MASK:
CONFIGURATION:
INPUT SIGNAL: -56 dBm

854 - 862 MHz
Analog FM downlink transmit
Base
90.210(g)
Below AGC threshold
OUTPUT SIGNAL:

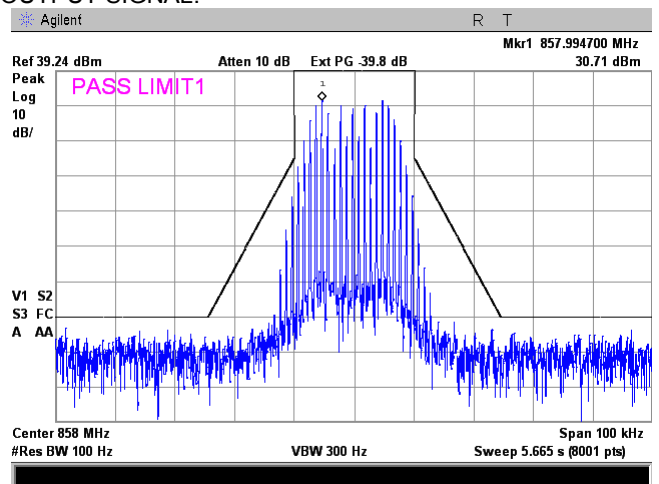
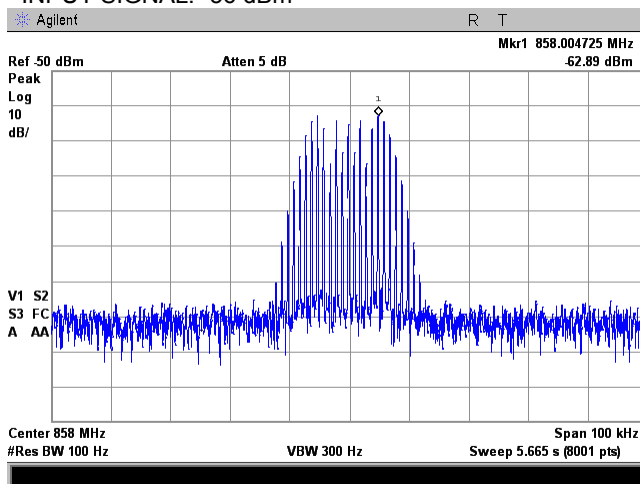

CONFIGURATION:
INPUT SIGNAL: -64 dBm

Above AGC threshold +3dB
OUTPUT SIGNAL:

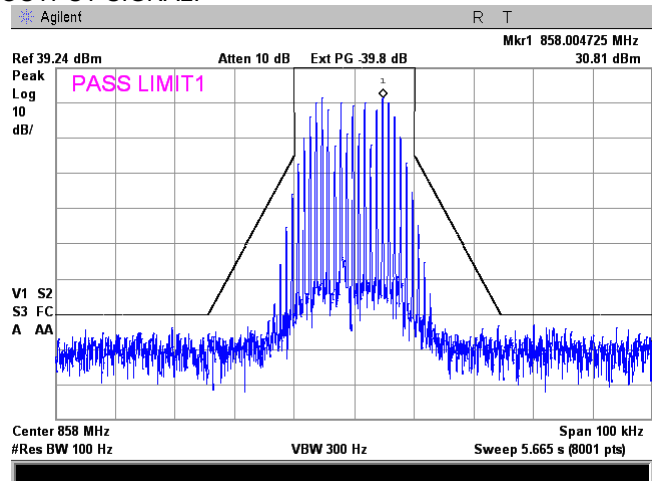
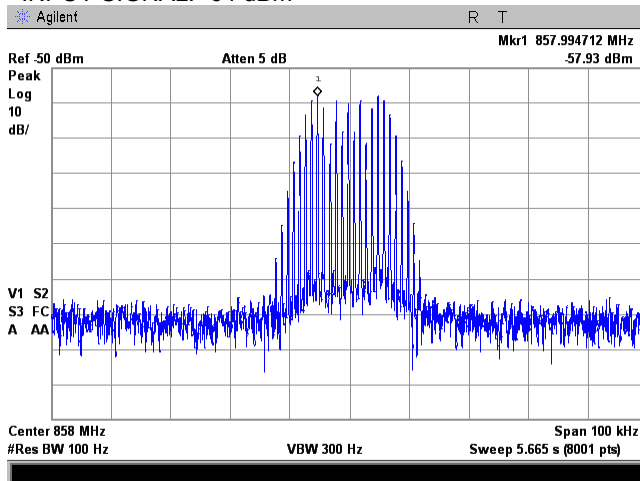



HERMON LABORATORIES

Test specification: Sections 90.210(b), 90.210(h), 90.210(g), Emission mask			
Test procedure: 47 CFR, Sections 2.1051, 2.1047 and 90.210(b); KDB 935210 D05 v01r01, section 4.4			
Test mode: Compliance		Verdict: PASS	
Date(s): 23-Mar-16 - 24-Mar-16			
Temperature: 23.2 °C	Relative Humidity: 48 %	Air Pressure: 1010 hPa	Power supply: 120 VAC
Remarks:			

Plot 7.4.20 Emission mask test result at low frequency carrier, Port 2

FRQUENCY RANGE: 809 - 817 MHz
 OPERATIONAL MODE: Analog FM uplink transmit
 INPUT PORT: Mobile
 EMISSION MASK: 90.210(g)
 CONFIGURATION: Below AGC threshold
 INPUT SIGNAL: -69 dBm
 OUTPUT SIGNAL:

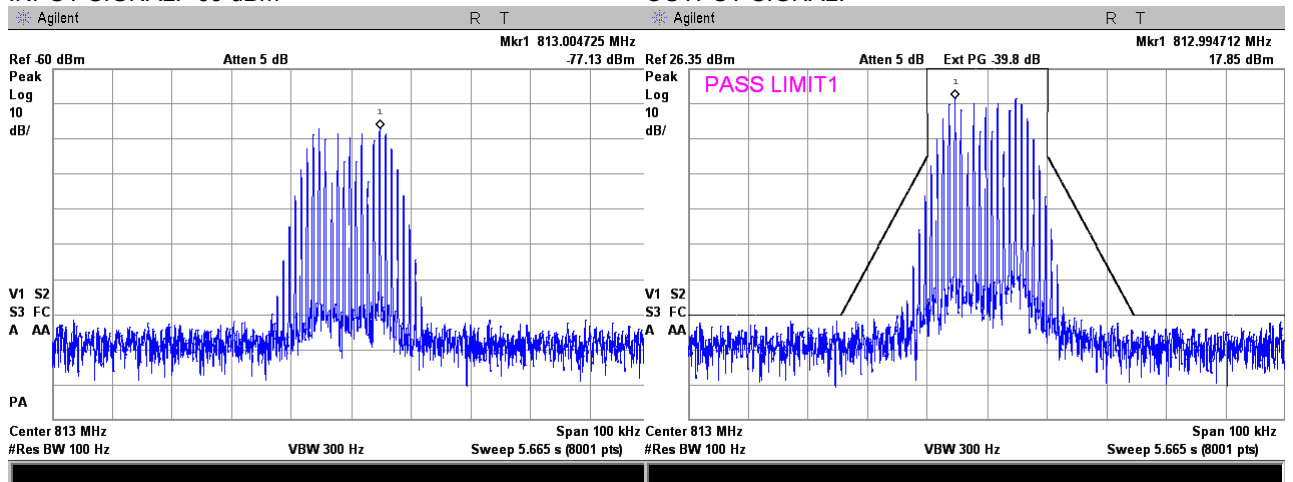

CONFIGURATION: Above AGC threshold +3dB
 INPUT SIGNAL: -64 dBm
 OUTPUT SIGNAL:

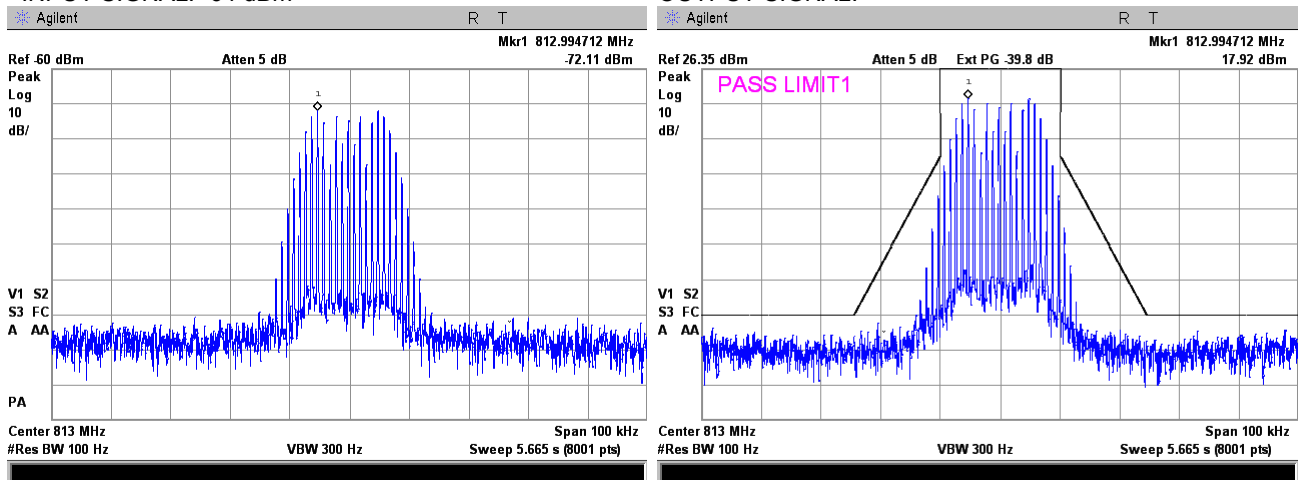



HERMON LABORATORIES

Test specification: Sections 90.210(b), 90.210(h), 90.210(g), Emission mask			
Test procedure: 47 CFR, Sections 2.1051, 2.1047 and 90.210(b); KDB 935210 D05 v01r01, section 4.4			
Test mode: Compliance		Verdict: PASS	
Date(s): 23-Mar-16 - 24-Mar-16			
Temperature: 23.2 °C	Relative Humidity: 48 %	Air Pressure: 1010 hPa	Power supply: 120 VAC
Remarks:			

Plot 7.4.21 Emission mask test result at low frequency carrier, Port 1

FRQUENCY RANGE:
OPERATIONAL MODE:
INPUT PORT:
EMISSION MASK:
CONFIGURATION:
INPUT SIGNAL: -56 dBm

854 - 862 MHz
C4FM uplink transmit
Base
90.210(g)
Below AGC threshold
OUTPUT SIGNAL:

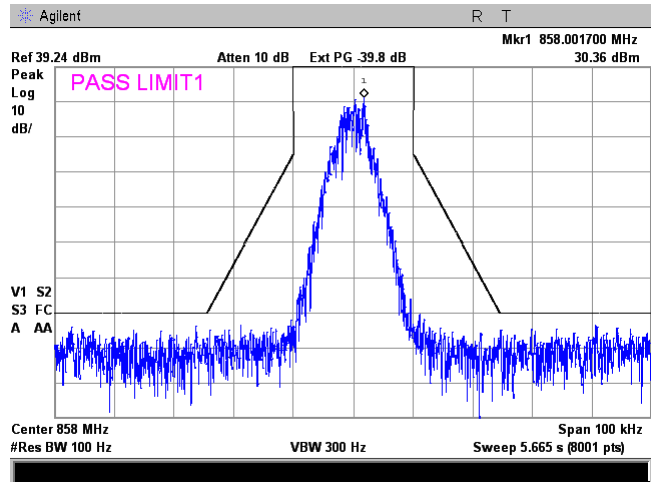
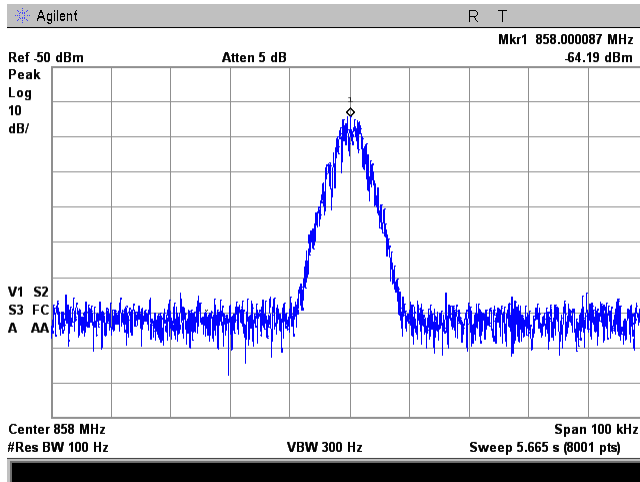

CONFIGURATION:
INPUT SIGNAL: -64 dBm

Above AGC threshold +3dB
OUTPUT SIGNAL:

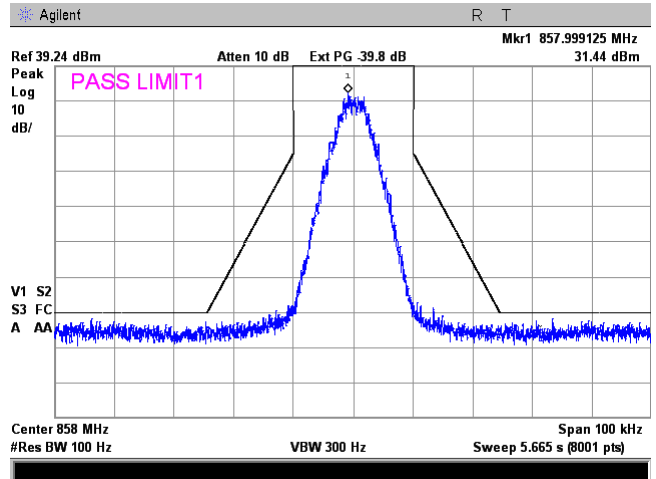
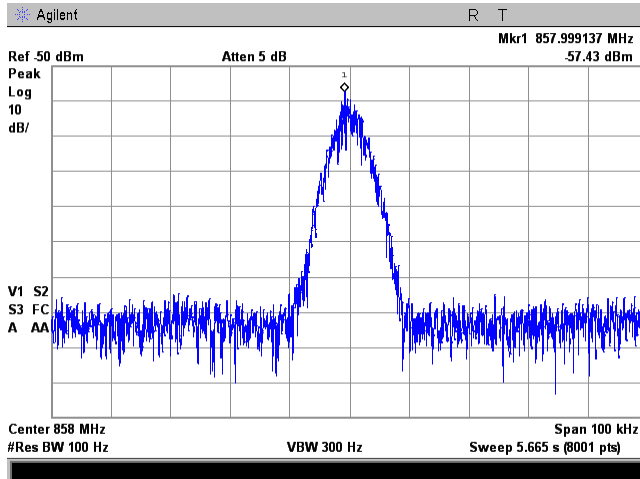



Test specification: Sections 90.210(b), 90.210(h), 90.210(g), Emission mask			
Test procedure: 47 CFR, Sections 2.1051, 2.1047 and 90.210(b); KDB 935210 D05 v01r01, section 4.4			
Test mode: Compliance		Verdict: PASS	
Date(s): 23-Mar-16 - 24-Mar-16			
Temperature: 23.2 °C	Relative Humidity: 48 %	Air Pressure: 1010 hPa	Power supply: 120 VAC
Remarks:			

Plot 7.4.22 Emission mask test result at low frequency carrier, Port 2

FREQUENCY RANGE: 809 - 817 MHz
 OPERATIONAL MODE: C4FM uplink transmit
 INPUT PORT: Mobile
 EMISSION MASK: 90.210(g)
 CONFIGURATION: Below AGC threshold
 INPUT SIGNAL: -69 dBm
 OUTPUT SIGNAL:

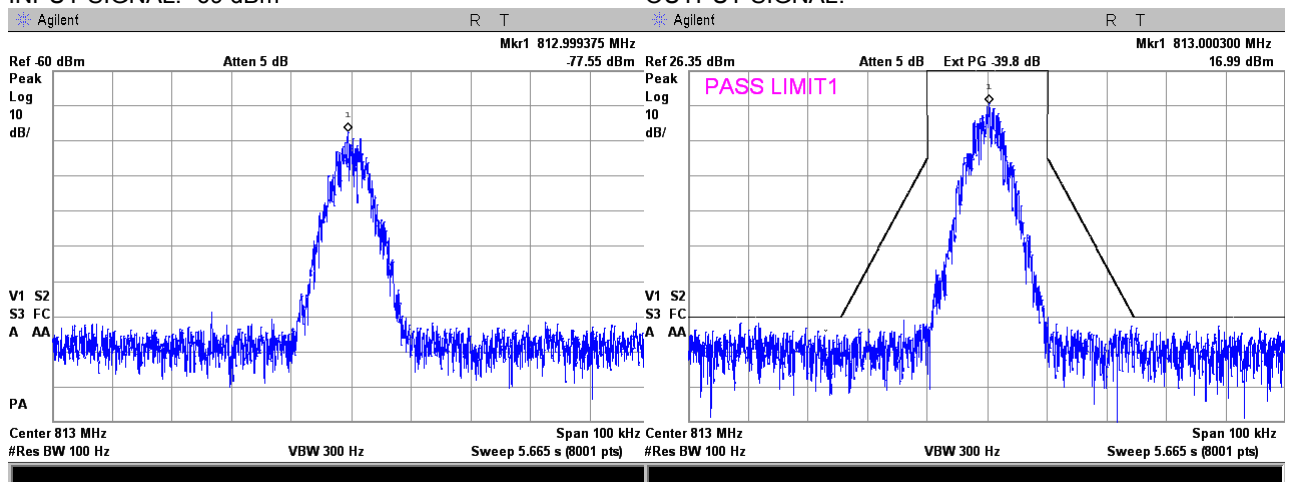

CONFIGURATION: Above AGC threshold +3dB
 INPUT SIGNAL: -64 dBm
 OUTPUT SIGNAL:

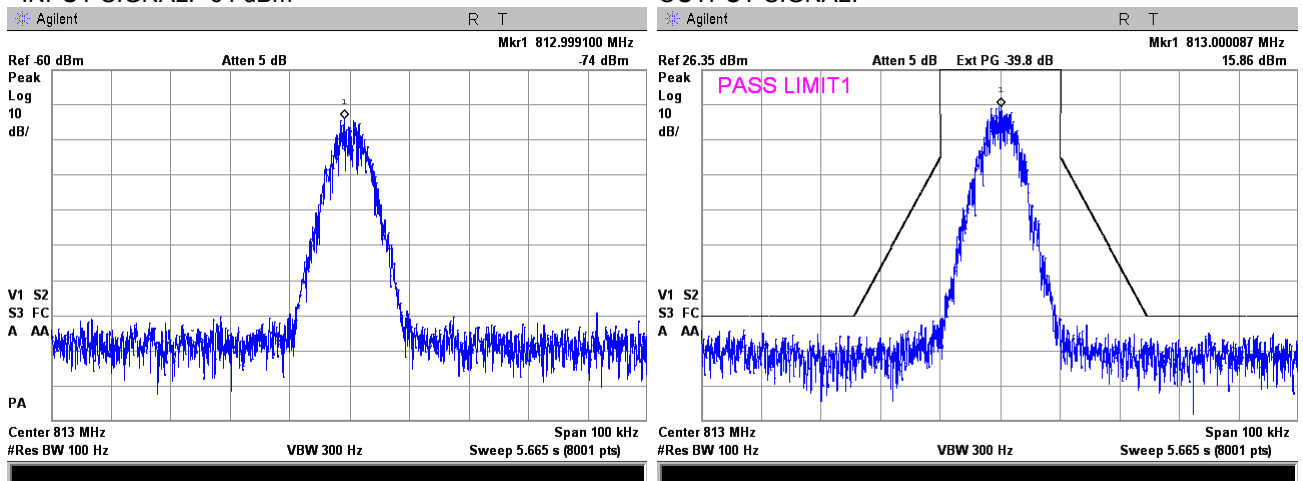



HERMON LABORATORIES

Test specification: Sections 90.210(b), 90.210(h), 90.210(g), Emission mask			
Test procedure: 47 CFR, Sections 2.1051, 2.1047 and 90.210(b); KDB 935210 D05 v01r01, section 4.4			
Test mode: Compliance		Verdict: PASS	
Date(s): 23-Mar-16 - 24-Mar-16			
Temperature: 23.2 °C	Relative Humidity: 48 %	Air Pressure: 1010 hPa	Power supply: 120 VAC
Remarks:			

Plot 7.4.23 Emission mask test result at low frequency carrier, Port 2

FRQUENCY RANGE:
OPERATIONAL MODE:
INPUT PORT:
EMISSION MASK:
CONFIGURATION:
INPUT SIGNAL: -69 dBm

806 - 809 MHz
C4FM uplink transmit
Mobile
90.210(h)
Below AGC threshold
OUTPUT SIGNAL:

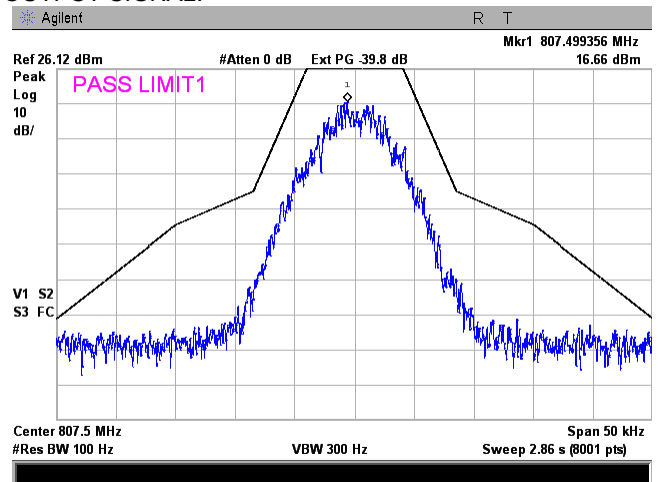
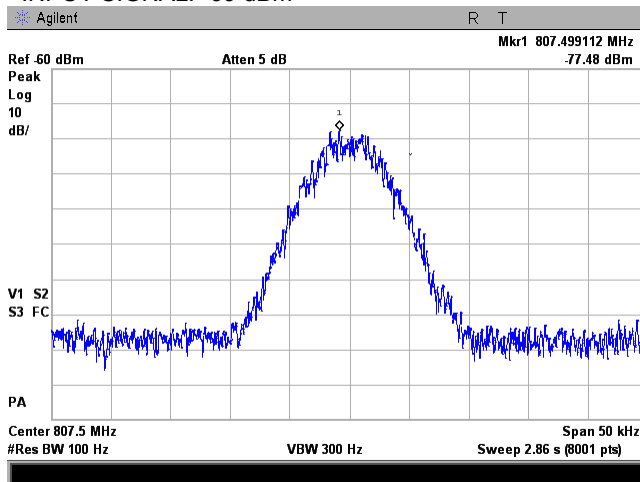

CONFIGURATION:
INPUT SIGNAL: -64 dBm

Above AGC threshold +3dB
OUTPUT SIGNAL:

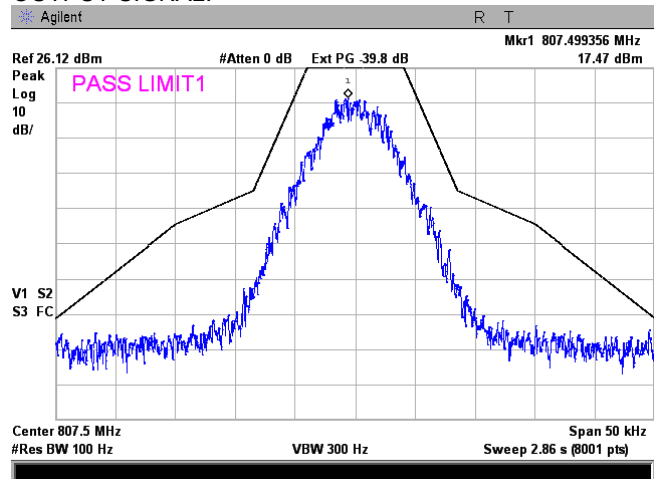
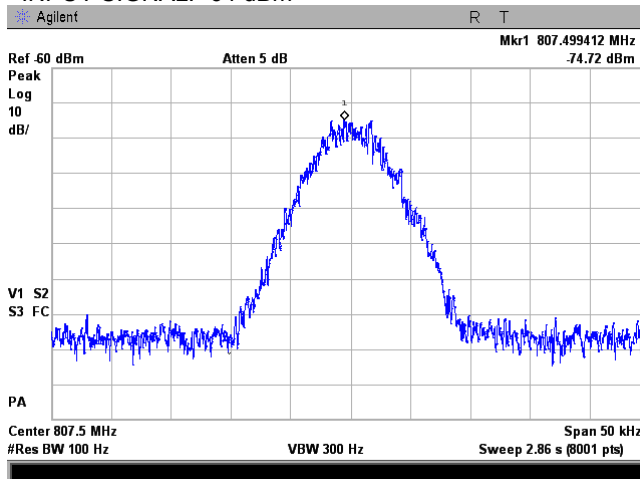



Test specification: Section 90.219(e)(2), Noise figure			
Test procedure: 47 CFR, Sections 2.1051; KDB 935210 D02 v02, Appendix D			
Test mode: Compliance		Verdict: PASS	
Date(s): 14-Apr-16			
Temperature: 23.2 °C	Relative Humidity: 48 %	Air Pressure: 1010 hPa	Power supply: 120 VAC
Remarks:			

7.5 Noise figure test

7.5.1 General

This test was performed to measure the noise figure at RF antenna connector. Specification test limits are given in Table 7.5.1.

Table 7.5.1 Noise figure limits

Frequency range	Noise figure limit, dB
Class A Booster	
851.0 – 862.0 / 806.0 – 817.0	9.0

7.5.2 Test procedure

7.5.2.1 The EUT was set up as shown in Figure 7.5.1, energized and its proper operation was checked.

7.5.2.2 The noise figure was measured with Noise Figure Analyzer as provided in the associated plots.

Figure 7.5.1 Noise figure test setup

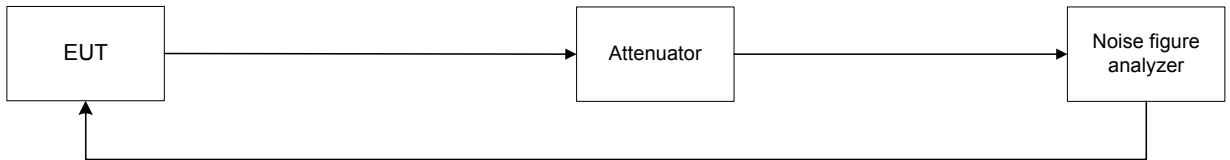



Test specification: Section 90.219(e)(2), Noise figure			
Test procedure: 47 CFR, Sections 2.1051; KDB 935210 D02 v02, Appendix D			
Test mode: Compliance		Verdict: PASS	
Date(s): 14-Apr-16			
Temperature: 23.2 °C	Relative Humidity: 48 %	Air Pressure: 1010 hPa	Power supply: 120 VAC
Remarks:			

Table 7.5.2 Noise figure test results

OPERATING FREQUENCY RANGE: 851 - 862 MHz (downlink)
806 - 817 MHz (uplink)

Frequency, MHz	Noise figure, dB	Limit, dB	Margin, dB	Verdict
Frequency range, 851 – 862 MHz Downlink				
851.00	3.22	9.0	-5.78	Pass
860.00	2.79	9.0	-6.21	Pass
866.00	3.25	9.0	-5.75	Pass
Frequency range, 806 –817 MHz Uplink				
806.00	1.94	9.0	-7.06	Pass
812.00	1.91	9.0	-7.09	Pass
821.38	2.18	9.0	-6.82	Pass

Reference numbers of test equipment used

HL 1876	HL 3768	HL 3772	HL 3779	HL 3901		
---------	---------	---------	---------	---------	--	--

Full description is given in Appendix A.



HERMON LABORATORIES

Test specification: Section 90.219(e)(2), Noise figure	
Test procedure: 47 CFR, Sections 2.1051; KDB 935210 D02 v02, Appendix D	
Test mode: Compliance	Verdict: PASS
Date(s): 14-Apr-16	
Temperature: 23.2 °C	Relative Humidity: 48 %
Remarks:	

Plot 7.5.1 Noise figure test results at frequency range 851 - 869 MHz

DETECTOR USED:
NOISE FIGURE:
CONFIGURATION:
POWER SETTING:

Average
Within the passband
Downlink
40 dBm

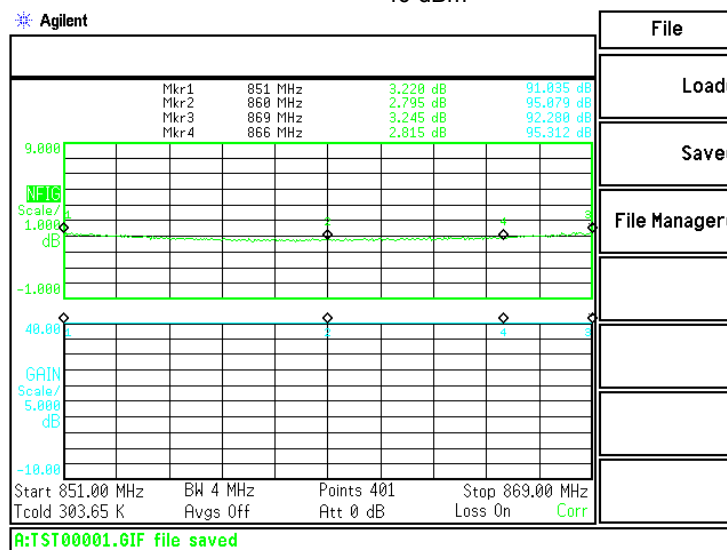

Plot 7.5.2 Noise figure test results at frequency range 806 - 816 MHz

DETECTOR USED:
NOISE FIGURE:
CONFIGURATION:
POWER SETTING:

Average
Within the passband
Uplink
28 dBm:

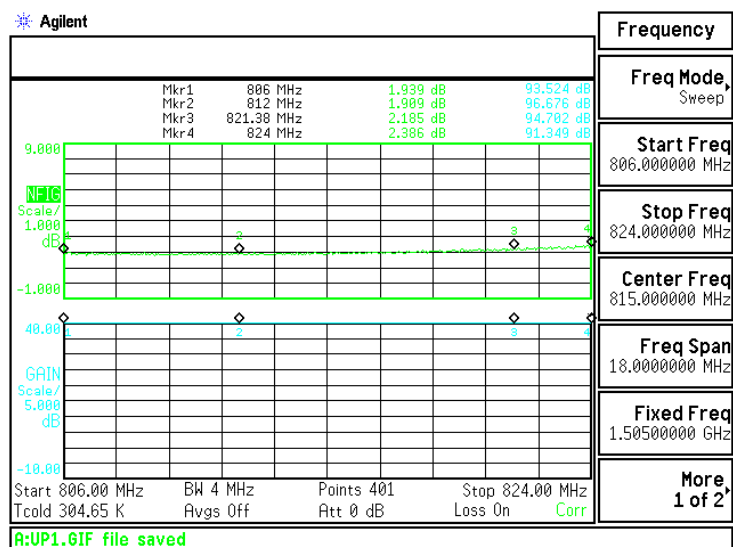



Test specification: Section 90.219(e)(3), Radiated spurious emissions			
Test procedure: 47 CFR, Sections 2.1053; KDB 935210 D05 v01r01, section 4.7.3			
Test mode: Compliance		Verdict: PASS	
Date(s): 29-Mar-16			
Temperature: 22.4 °C	Relative Humidity: 48 %	Air Pressure: 1015 hPa	Power supply: 120 VAC
Remarks:			

7.6 Radiated spurious emission measurements for PLMRS/PSRS

7.6.1 General

This test was performed to measure radiated spurious emissions from the EUT. Specification test limits are given in Table 7.6.1.

Table 7.6.1 Radiated spurious emission test limits

Frequency, MHz	Attenuation below carrier, dBc	ERP of spurious, dBm	Equivalent field strength limit @ 3m, dB(μV/m) ^{***}
0.009 – 10th harmonic*	43+10logP ^{**}	-13	84.4

* - Excluding the in band emission within ± 250 % of the authorized bandwidth from the carrier

** - P is transmitter output power in Watts

*** - Equivalent field strength limit was calculated from maximum allowed ERP of spurious as follows: $E = \sqrt{30 \times P \times 1.64} / r$, where P is ERP in Watts, 1.64 is numeric gain of ideal dipole and r is antenna to EUT distance in meters

7.6.2 Test procedure for spurious emission field strength measurements in 9 kHz to 30 MHz band

7.6.2.1 The EUT was set up as shown in Figure 7.6.1, energized and the performance check was conducted.

7.6.2.2 The specified frequency range was investigated with antenna connected to spectrum analyzer. To find maximum radiation the turntable was rotated 360° and the measuring antenna was rotated around its vertical axis.

7.6.2.3 The worst test results (the lowest margins) were recorded in Table 7.6.2 and shown in the associated plots.

7.6.3 Test procedure for spurious emission field strength measurements above 30 MHz

7.6.3.1 The EUT was set up as shown in Figure 7.6.2, energized and the performance check was conducted.

7.6.3.2 The specified frequency range was investigated with antenna connected to spectrum analyzer. To find maximum radiation the turntable was rotated 360° and the measuring antenna height was swept from 1 to 4 m in both, vertical and horizontal, polarizations.

7.6.3.3 The worst test results (the lowest margins) were recorded in Table 7.6.2 and shown in the associated plots.



Test specification: Section 90.219(e)(3), Radiated spurious emissions			
Test procedure: 47 CFR, Sections 2.1053; KDB 935210 D05 v01r01, section 4.7.3			
Test mode: Compliance		Verdict: PASS	
Date(s): 29-Mar-16			
Temperature: 22.4 °C	Relative Humidity: 48 %	Air Pressure: 1015 hPa	Power supply: 120 VAC
Remarks:			

Figure 7.6.1 Setup for spurious emission field strength measurements in 9 kHz to 30 MHz band

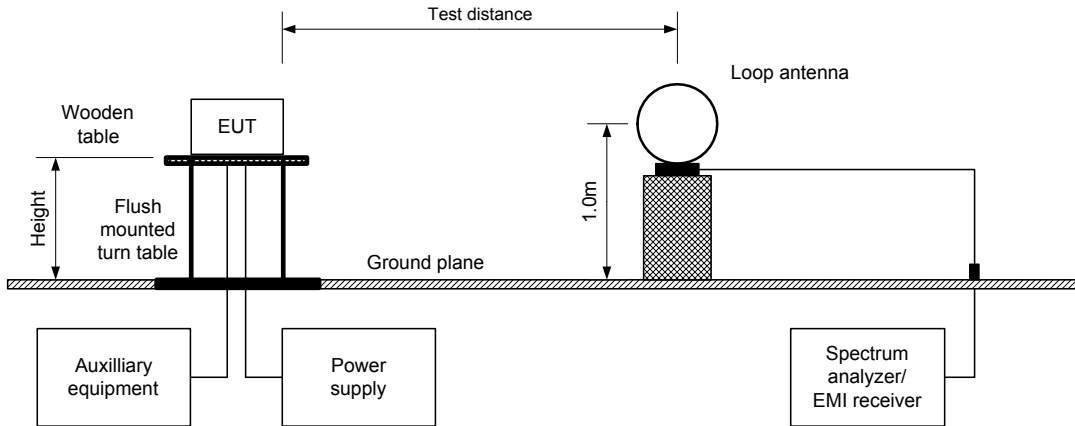
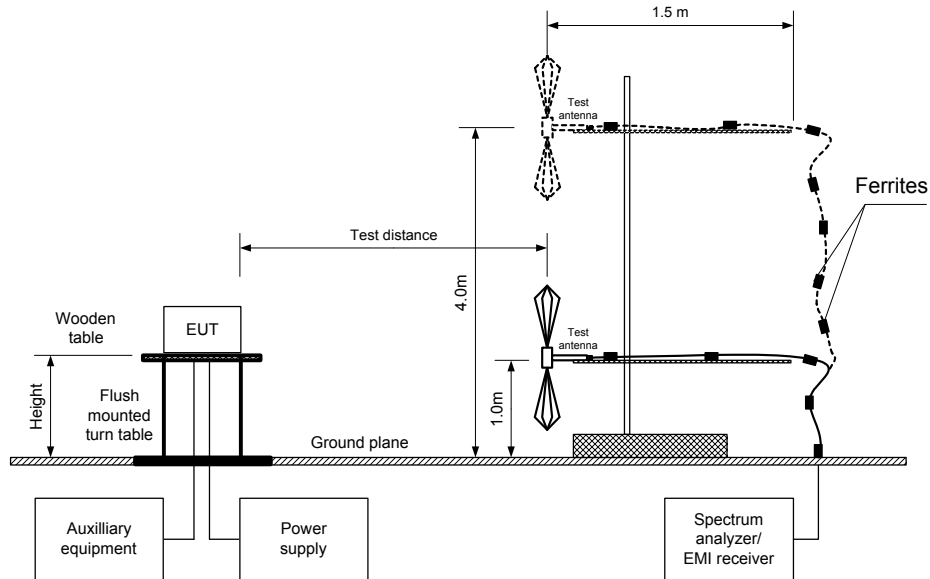

Figure 7.6.2 Setup for spurious emission field strength measurements above 30 MHz





Test specification: Section 90.219(e)(3), Radiated spurious emissions			
Test procedure: 47 CFR, Sections 2.1053; KDB 935210 D05 v01r01, section 4.7.3			
Test mode: Compliance		Verdict: PASS	
Date(s): 29-Mar-16			
Temperature: 22.4 °C	Relative Humidity: 48 %	Air Pressure: 1015 hPa	Power supply: 120 VAC
Remarks:			

Table 7.6.2 Spurious emission field strength test results

ASSIGNED FREQUENCY RANGE: 851 – 862 MHz Downlink
806 – 817 MHz Uplink

TEST DISTANCE: 3 m

TEST SITE: Semi anechoic chamber

EUT HEIGHT: 0.8 m

INVESTIGATED FREQUENCY RANGE: 0.009 – 8700 MHz

DETECTOR USED: Peak

VIDEO BANDWIDTH: > Resolution bandwidth

TEST ANTENNA TYPE: Active loop (9 kHz – 30 MHz)
Biconilog (30 MHz – 1000 MHz)
Double ridged guide (above 1000 MHz)

MODULATION: Unmodulated

Frequency, MHz	Field strength, dB(µV/m)	Limit, dB(µV/m)	Margin, dB*	RBW, kHz	Antenna polarization	Antenna height, m	Turn-table position**, degrees	Verdict
Downlink								
Low carrier frequency 851.0 MHz								
All emissions were found more than 20dB below limit								Pass
Mid carrier frequency 856.0 MHz								
All emissions were found more than 20dB below limit								Pass
High carrier frequency 862.0 MHz								
All emissions were found more than 20dB below limit								Pass
Uplink								
Low carrier frequency 806.0 MHz								
All emissions were found more than 20dB below limit								Pass
Mid carrier frequency 811.0 MHz								
All emissions were found more than 20dB below limit								Pass
High carrier frequency 817.0 MHz								
All emissions were found more than 20dB below limit								Pass

*- Margin = Field strength of spurious – calculated field strength limit.

** - EUT front panel refers to 0 degrees position of turntable.

Reference numbers of test equipment used

HL 0446	HL 0521	HL 0557	HL 0604	HL 2909	HL 3622	HL 3623	HL 4276
HL 4278	HL 4353	HL 4722	HL 4933				

Full description is given in Appendix A.



HERMON LABORATORIES

Test specification: Section 90.219(e)(3), Radiated spurious emissions			
Test procedure: 47 CFR, Sections 2.1053; KDB 935210 D05 v01r01, section 4.7.3			
Test mode: Compliance		Verdict: PASS	
Date(s): 29-Mar-16			
Temperature: 22.4 °C	Relative Humidity: 48 %	Air Pressure: 1015 hPa	Power supply: 120 VAC
Remarks:			

Plot 7.6.1 Radiated emission measurements in 9 - 150 kHz range

TEST SITE:
ASSIGNED FREQUENCY RANGES:

Semi anechoic chamber
851 – 862 MHz Downlink
806 – 817 MHz Uplink
Vertical and Horizontal

ANTENNA POLARIZATION:
TEST DISTANCE:
CONFIGURATION:
CARRIER FREQUENCY: Low

3 m
CW
CARRIER FREQUENCY: Mid

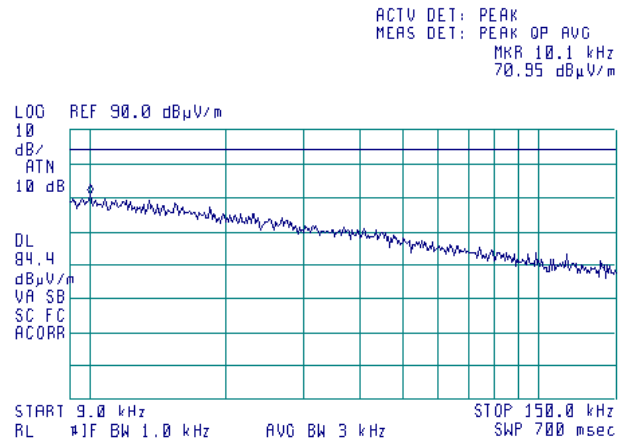
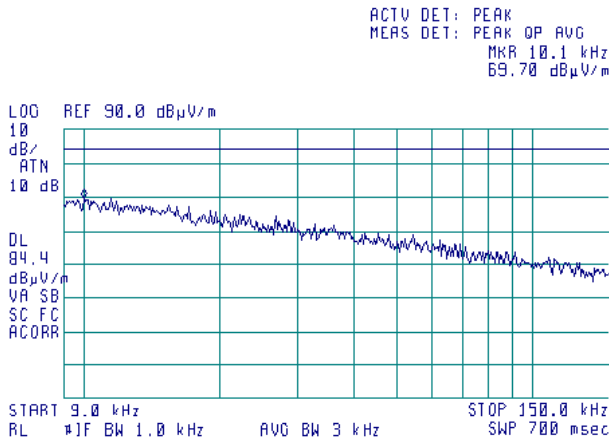

CARRIER FREQUENCY: High

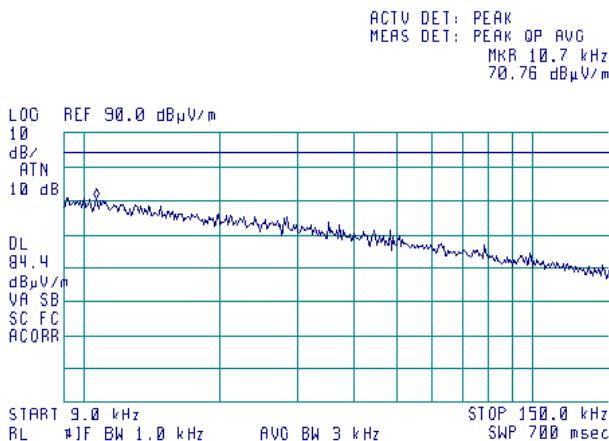



HERMON LABORATORIES

Test specification: Section 90.219(e)(3), Radiated spurious emissions			
Test procedure: 47 CFR, Sections 2.1053; KDB 935210 D05 v01r01, section 4.7.3			
Test mode: Compliance		Verdict: PASS	
Date(s): 29-Mar-16			
Temperature: 22.4 °C	Relative Humidity: 48 %	Air Pressure: 1015 hPa	Power supply: 120 VAC
Remarks:			

Plot 7.6.2 Radiated emission measurements in 0.15 - 30 MHz range

TEST SITE:
ASSIGNED FREQUENCY RANGES:

Semi anechoic chamber
851 – 862 MHz Downlink

ANTENNA POLARIZATION:
TEST DISTANCE:
CONFIGURATION:
CARRIER FREQUENCY: Low

806 – 817 MHz Uplink
Vertical and Horizontal
3 m
CW
CARRIER FREQUENCY: Mid

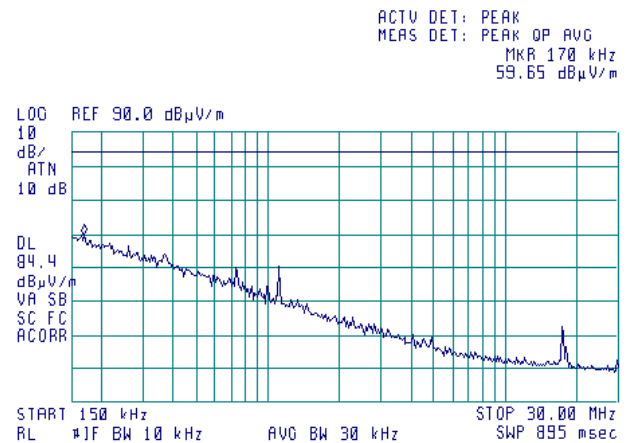
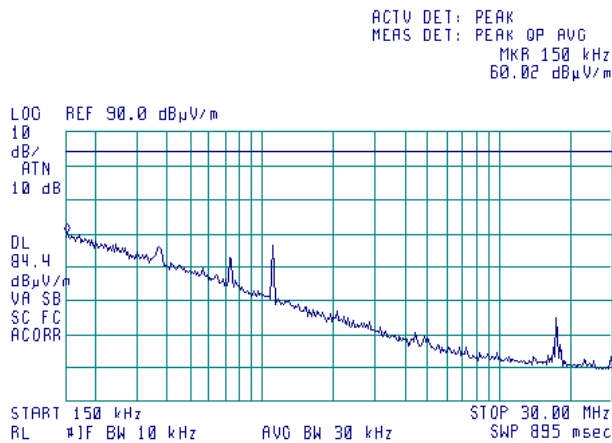

CARRIER FREQUENCY: High

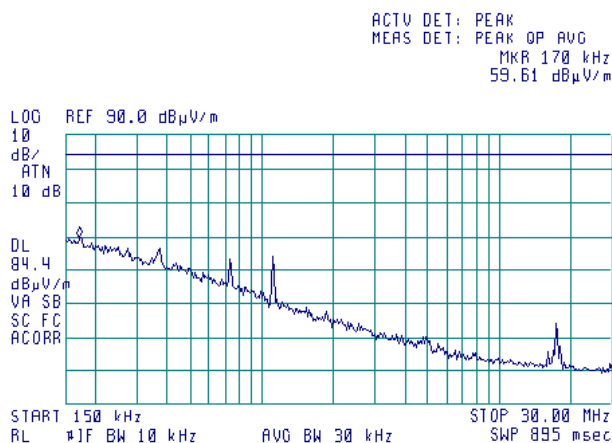



HERMON LABORATORIES

Test specification: Section 90.219(e)(3), Radiated spurious emissions			
Test procedure: 47 CFR, Sections 2.1053; KDB 935210 D05 v01r01, section 4.7.3			
Test mode: Compliance		Verdict: PASS	
Date(s): 29-Mar-16			
Temperature: 22.4 °C	Relative Humidity: 48 %	Air Pressure: 1015 hPa	Power supply: 120 VAC
Remarks:			

Plot 7.6.3 Radiated emission measurements in 30 - 1000 MHz range

ASSIGNED FREQUENCY RANGES:

851 – 862 MHz Downlink

806 – 817 MHz Uplink

ANTENNA POLARIZATION:

Vertical and Horizontal

TEST DISTANCE:

3 m

CONFIGURATION:

CW

CARRIER FREQUENCY: Low

CARRIER FREQUENCY: Mid

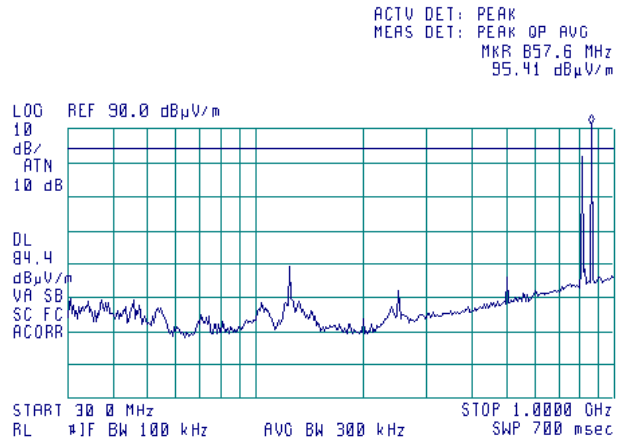
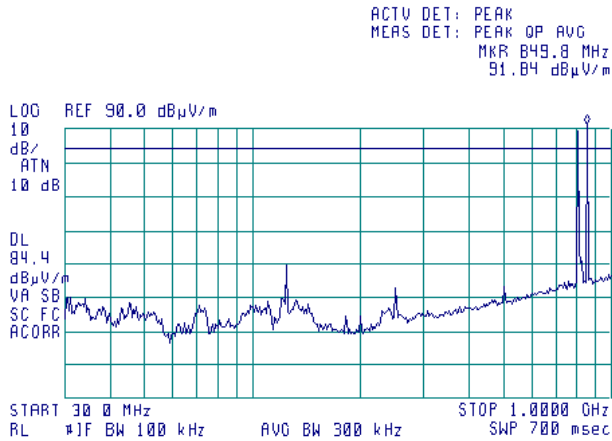

CARRIER FREQUENCY: High

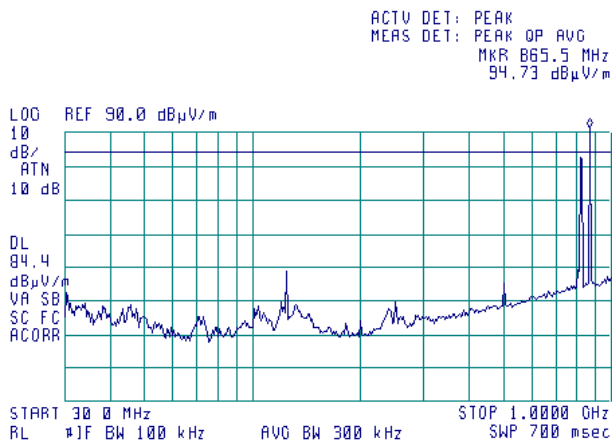

851/861/869 MHz – Downlink frequencies; 806/816/824 MHz – Uplink frequencies



HERMON LABORATORIES

Test specification: Section 90.219(e)(3), Radiated spurious emissions			
Test procedure: 47 CFR, Sections 2.1053; KDB 935210 D05 v01r01, section 4.7.3			
Test mode: Compliance		Verdict: PASS	
Date(s): 29-Mar-16			
Temperature: 22.4 °C	Relative Humidity: 48 %	Air Pressure: 1015 hPa	Power supply: 120 VAC
Remarks:			

Plot 7.6.4 Radiated emission measurements in 1000 – 8700 MHz range

TEST SITE:
ASSIGNED FREQUENCY RANGES:

Semi anechoic chamber
851 – 862 MHz Downlink
806 – 817 MHz Uplink
Vertical and Horizontal

ANTENNA POLARIZATION:
TEST DISTANCE:
CONFIGURATION:
CARRIER FREQUENCY: Low

3 m
CW
CARRIER FREQUENCY: Mid

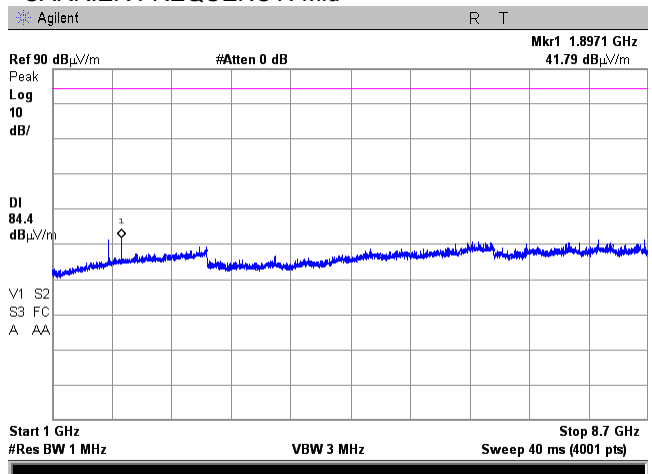
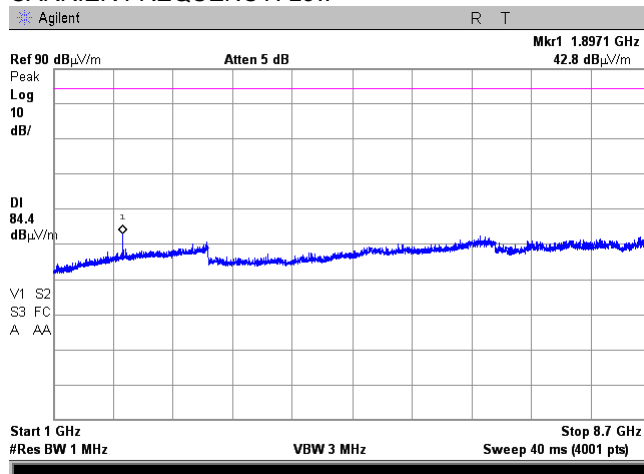

CARRIER FREQUENCY: High

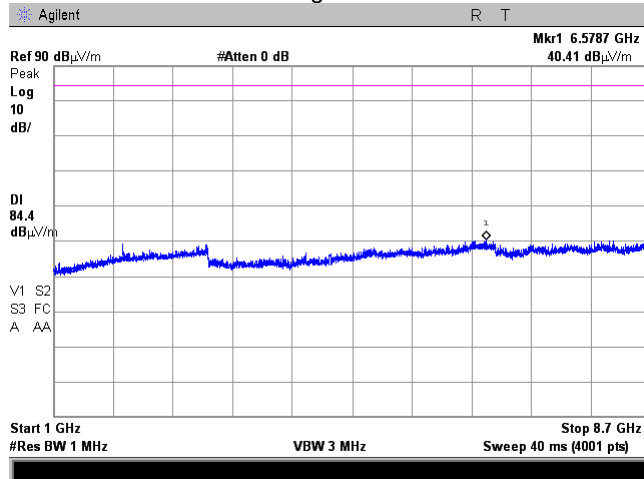



Test specification: Section 90.219(e)(3), Conducted spurious emissions for PLMRS/PSRS			
Test procedure: 47 CFR, Sections 2.1051 KDB 935210 D05 v01r01 section 4.7.3			
Test mode: Compliance		Verdict: PASS	
Date(s): 24-Mar-16 - 13-Apr-16			
Temperature: 22.3 °C	Relative Humidity: 48 %	Air Pressure: 1005 hPa	Power supply: 120 VAC
Remarks:			

7.7 Spurious emissions at RF antenna connector test for PLMRS/PSRS

7.7.1 General

This test was performed to measure spurious emissions at RF antenna connector. Specification test limits are given in Table 7.7.1.

Table 7.7.1 Spurious emission limits

Frequency, MHz	Attenuation below carrier, dBc	ERP of spurious, dBm
0.009 – 10th harmonic*	43+10logP** (mask B, C)	-13.0

* - spurious emission limits do not apply to the in band emission within ± 250 % of the authorized bandwidth from the carrier; investigated in course of emission mask testing

** - P is transmitter output power in Watts

7.7.2 Test procedure

7.7.2.1 The EUT was set up as shown in Figure 7.7.1, energized and its proper operation was checked.

7.7.2.2 The EUT was adjusted to produce maximum available for end user RF output power.

7.7.2.3 The spurious emission was measured with spectrum analyzer as provided in Table 7.7.2 and associated plots.

Figure 7.7.1 Spurious emission test setup

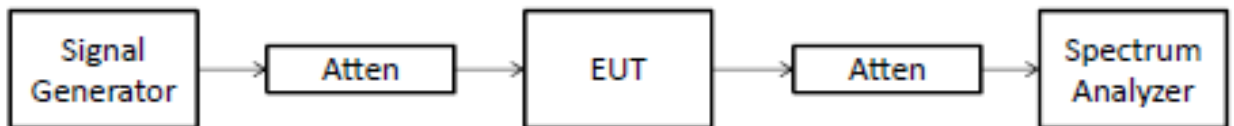



Test specification: Section 90.219(e)(3), Conducted spurious emissions for PLMRS/PSRS			
Test procedure: 47 CFR, Sections 2.1051 KDB 935210 D05 v01r01 section 4.7.3			
Test mode: Compliance		Verdict: PASS	
Date(s): 24-Mar-16 - 13-Apr-16			
Temperature: 22.3 °C	Relative Humidity: 48 %	Air Pressure: 1005 hPa	Power supply: 120 VAC
Remarks:			

Table 7.7.2 Spurious emission test results

ASSIGNED FREQUENCY RANGE: 851.0 – 862.0 MHz Downlink
806.0 – 817.0 MHz Uplink

INVESTIGATED FREQUENCY RANGE: 0.009 – 8700 MHz

DETECTOR USED: Average

VIDEO BANDWIDTH: ≥ Resolution bandwidth

RF SIGNAL: CW

BOOSTER OUTPUT POWER SETTINGS: Below AGC threshold

Frequency, MHz	SA reading, dBm	Attenuator, dB	Cable loss, dB	RBW, kHz	Spurious emission, dBm	Limit, dBm	Margin, dB*	Verdict
Downlink								
Mid carrier frequency								
849.25	-28.68	Included	Included	100	-28.68	-13.0	-15.68	Pass
Uplink								
Mid carrier frequency								
All emissions were found more than 20dB below limit								Pass

*- Margin = Spurious emission – specification limit.

Reference numbers of test equipment used

HL 2015	HL 2909	HL 3433	HL 3434	HL 3787	HL 3788	HL 4273	HL 4274
HL 4068	HL 4097	HL 4354	HL 4413				

Full description is given in Appendix A.



Test specification: Section 90.219(e)(3), Conducted spurious emissions for PLMRS/PSRS			
Test procedure: 47 CFR, Sections 2.1051 KDB 935210 D05 v01r01 section 4.7.3			
Test mode: Compliance		Verdict: PASS	
Date(s): 24-Mar-16 - 13-Apr-16			
Temperature: 22.3 °C	Relative Humidity: 48 %	Air Pressure: 1005 hPa	Power supply: 120 VAC
Remarks:			

Plot 7.7.1 Spurious emission measurements in 9 - 150 kHz range at mid carrier frequency

FREQUENCY RANGE: 851 – 862 MHz
 OPERATIONAL MODE: CW downlink transmit
 INPUT PORT: Base
 CONFIGURATION: Below AGC level
 INPUT POWER: -56 dBm

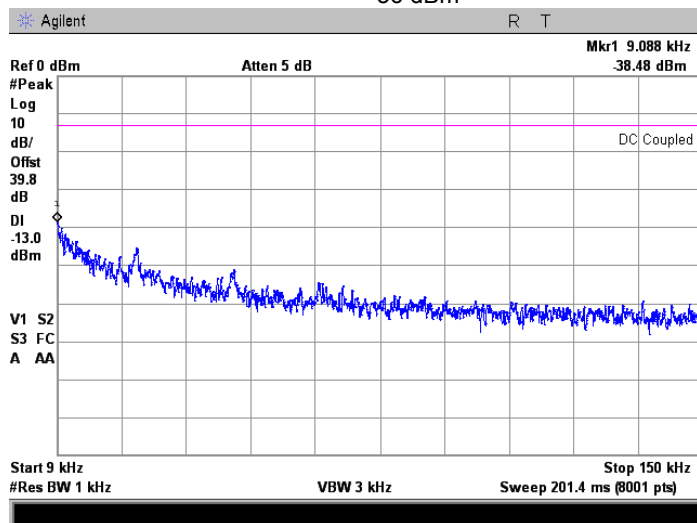

Plot 7.7.2 Spurious emission measurements in 0.15 - 30.0 MHz range at mid carrier frequency

FREQUENCY RANGE: 851 – 862 MHz
 OPERATIONAL MODE: CW downlink transmit
 INPUT PORT: Base
 CONFIGURATION: Below AGC level
 INPUT POWER: -56 dBm

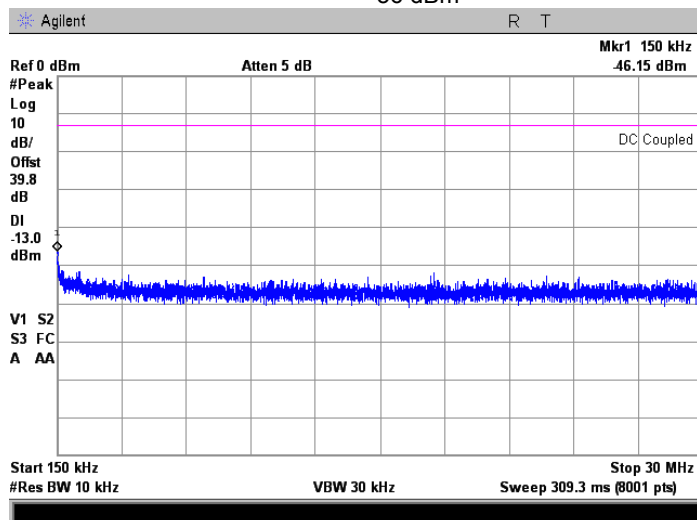



Test specification: Section 90.219(e)(3), Conducted spurious emissions for PLMRS/PSRS			
Test procedure: 47 CFR, Sections 2.1051 KDB 935210 D05 v01r01 section 4.7.3			
Test mode: Compliance		Verdict: PASS	
Date(s): 24-Mar-16 - 13-Apr-16			
Temperature: 22.3 °C	Relative Humidity: 48 %	Air Pressure: 1005 hPa	Power supply: 120 VAC
Remarks:			

Plot 7.7.3 Spurious emission measurements in 30.0 - 1000 MHz range at mid carrier frequency

FREQUENCY RANGE:
OPERATIONAL MODE:
INPUT PORT:
CONFIGURATION:
INPUT POWER:

851 – 862 MHz
CW downlink transmit
Base
Below AGC level
-56 dBm

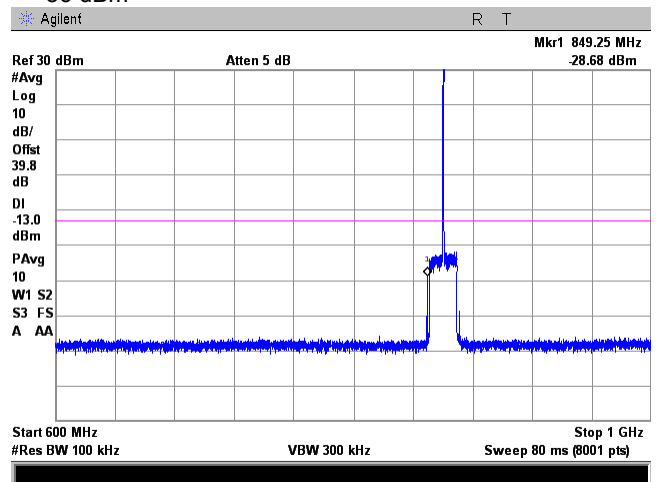
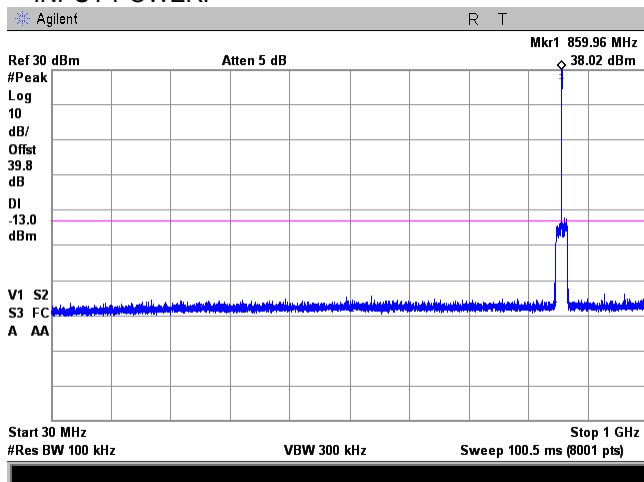

Plot 7.7.4 Spurious emission measurements in 1000 - 8700 MHz at mid carrier frequency

FREQUENCY RANGE:
OPERATIONAL MODE:
INPUT PORT:
CONFIGURATION:
INPUT POWER:

851 – 862 MHz
CW downlink transmit
Base
Below AGC level
-56 dBm

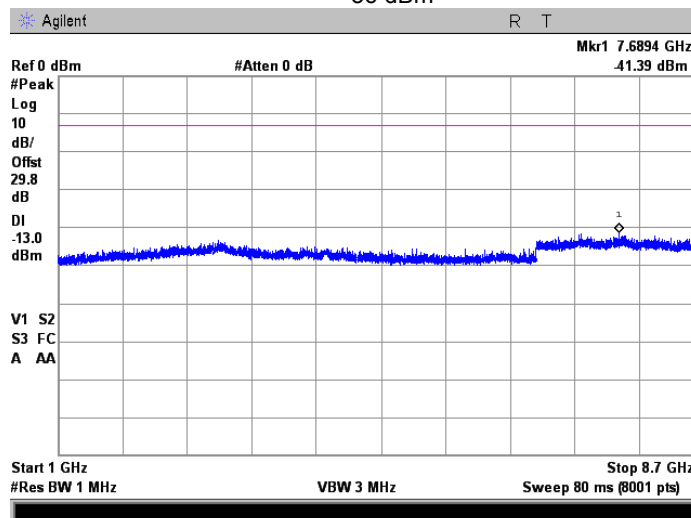



Test specification: Section 90.219(e)(3), Conducted spurious emissions for PLMRS/PSRS			
Test procedure: 47 CFR, Sections 2.1051 KDB 935210 D05 v01r01 section 4.7.3			
Test mode: Compliance		Verdict: PASS	
Date(s): 24-Mar-16 - 13-Apr-16			
Temperature: 22.3 °C	Relative Humidity: 48 %	Air Pressure: 1005 hPa	Power supply: 120 VAC
Remarks:			

Plot 7.7.5 Spurious emission measurements in 9 - 150 kHz range at mid carrier frequency

FREQUENCY RANGE: 806 – 817 MHz
 OPERATIONAL MODE: CW uplink transmit
 INPUT PORT: Mobile
 CONFIGURATION: Below AGC level
 INPUT POWER: -69 dBm

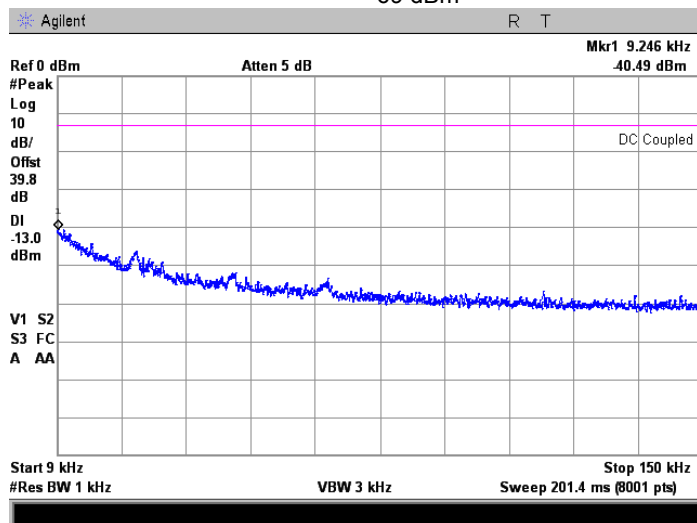

Plot 7.7.6 Spurious emission measurements in 0.15 - 30.0 MHz range at mid carrier frequency

FREQUENCY RANGE: 806 – 817 MHz
 OPERATIONAL MODE: CW uplink transmit
 INPUT PORT: Mobile
 CONFIGURATION: Below AGC level
 INPUT POWER: -69 dBm

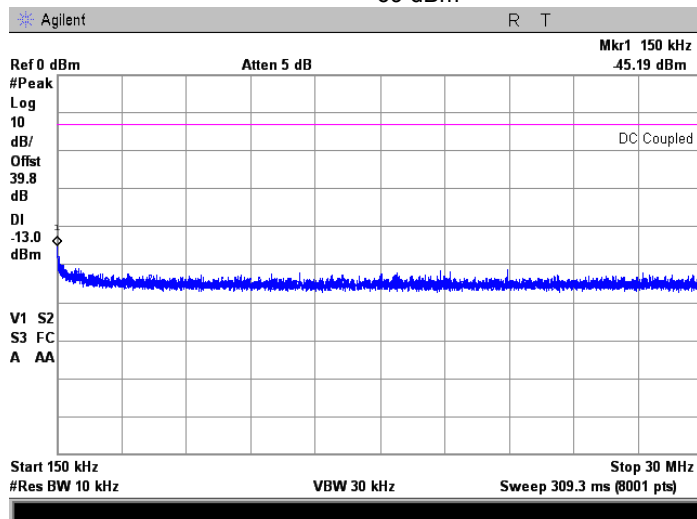



Test specification: Section 90.219(e)(3), Conducted spurious emissions for PLMRS/PSRS			
Test procedure: 47 CFR, Sections 2.1051 KDB 935210 D05 v01r01 section 4.7.3			
Test mode: Compliance		Verdict: PASS	
Date(s): 24-Mar-16 - 13-Apr-16			
Temperature: 22.3 °C	Relative Humidity: 48 %	Air Pressure: 1005 hPa	Power supply: 120 VAC
Remarks:			

Plot 7.7.7 Spurious emission measurements in 30.0 - 1000 MHz range at mid carrier frequency

FREQUENCY RANGE: 806 – 817 MHz
 OPERATIONAL MODE: CW uplink transmit
 INPUT PORT: Mobile
 CONFIGURATION: Below AGC level
 INPUT POWER: -69 dBm

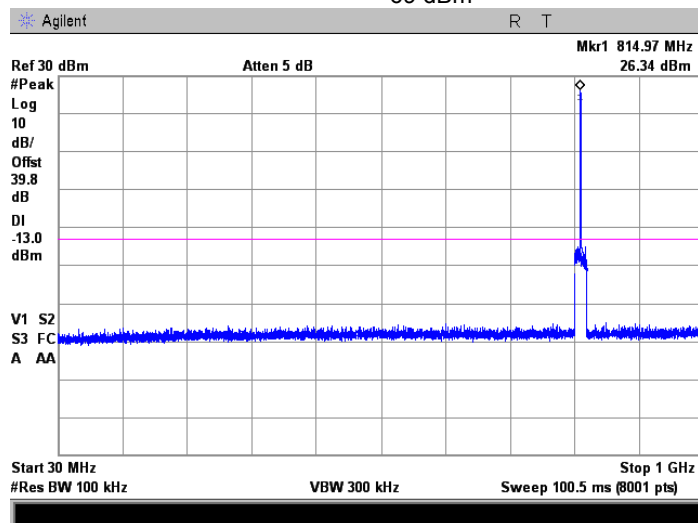

Plot 7.7.8 Spurious emission measurements in 1000 - 8300 MHz at mid carrier frequency

FREQUENCY RANGE: 806 – 817 MHz
 OPERATIONAL MODE: CW uplink transmit
 INPUT PORT: Mobile
 CONFIGURATION: Below AGC level
 INPUT POWER: -69 dBm

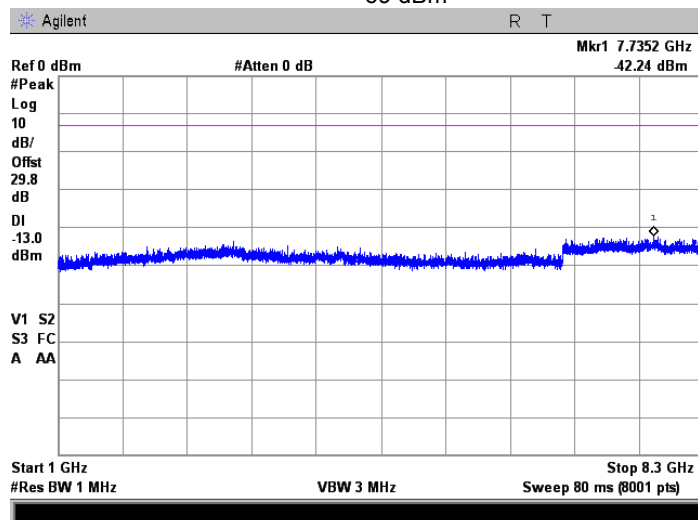



Test specification: Section 90.219(e)(3), Intermodulation product ERP			
Test procedure: 47 CFR, Sections 2.1051 KDB 935210 D05 v01r01 section 4.7.2			
Test mode: Compliance		Verdict: PASS	
Date(s): 24-Mar-16 - 13-Apr-16			
Temperature: 22.3 °C	Relative Humidity: 48 %	Air Pressure: 1005 hPa	Power supply: 120 VAC
Remarks:			

7.8 ERP intermodulation product test

7.8.1 General

This test was performed to measure spurious emissions at RF antenna connector. Specification test limits are given in Table 7.8.1.

Table 7.8.1 ERP intermodulation product limits

Frequency, MHz	Attenuation below carrier, dBc	ERP Intermodulation product limit, dBm
851 – 862 / 806 - 816	43+10logP**	-13.0

7.8.2 Test procedure

- 7.8.2.1 The EUT was set up as shown in Figure 7.8.1, energized and its proper operation was checked.
- 7.8.2.2 Signal generator A was configured for CW operation at the f0 frequency of appropriate frequency band,
- 7.8.2.3 Signal generator B was configured for CW operation tuned available channel spacing (e.g. 25, 12.5 or 6.25 kHz) above the frequency f0 or below the frequency f0 of the same frequency band.
- 7.8.2.4 The generator amplitudes were set so that the power from each into RF combiner was equivalent.
- 7.8.2.5 The signal generator's amplitudes were increased equally until just below the EUT's AGC threshold level was reached and all intermodulation products were measured.
- 7.8.2.6 Signal generator B was varied in frequency to check if intermodulation products were produced.
- 7.8.2.7 The intermodulation products were measured with spectrum analyzer as provided in the associated plots.
- 7.8.2.8 The EUT was tested with the composite input power level was set to 3 dB above the AGC threshold level to show AGC operation, worst case results taken.
- 7.8.2.9 The test was repeated for all uplink and downlink operational bands. The test results are provided in the associated Table 7.8.2 and plots.



Test specification: Section 90.219(e)(3), Intermodulation product ERP			
Test procedure: 47 CFR, Sections 2.1051 KDB 935210 D05 v01r01 section 4.7.2			
Test mode: Compliance		Verdict: PASS	
Date(s): 24-Mar-16 - 13-Apr-16			
Temperature: 22.3 °C	Relative Humidity: 48 %	Air Pressure: 1005 hPa	Power supply: 120 VAC
Remarks:			

Figure 7.8.1 Spurious emission test setup

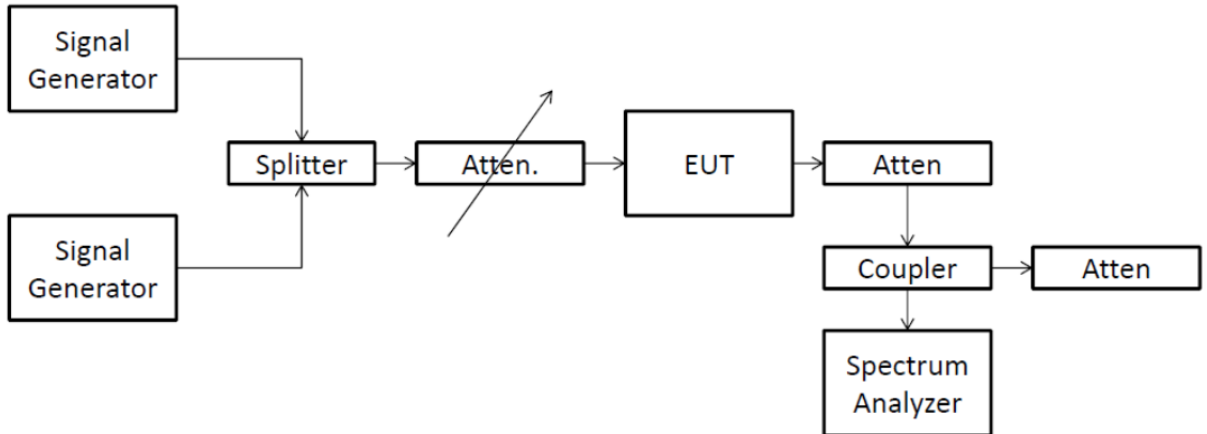

Photograph 7.8.1 Spurious emission test setup





Test specification: Section 90.219(e)(3), Intermodulation product ERP			
Test procedure: 47 CFR, Sections 2.1051 KDB 935210 D05 v01r01 section 4.7.2			
Test mode: Compliance		Verdict: PASS	
Date(s): 24-Mar-16 - 13-Apr-16			
Temperature: 22.3 °C	Relative Humidity: 48 %	Air Pressure: 1005 hPa	Power supply: 120 VAC
Remarks:			

Table 7.8.2 ERP intermodulation product test results

ASSIGNED FREQUENCY RANGE: 851 – 862 MHz Downlink
806 – 816 MHz Uplink
DETECTOR USED: Average
VIDEO BANDWIDTH: ≥ Resolution bandwidth
MODULATING SIGNAL: PRBS

CONFIGURATION: Two signals
MODULATION: Unmodulated

Frequency, MHz	SA reading below AGC, dBm	SA reading above AGC, dBm	RBW, kHz	Spurious emission, dBm	Limit, dBm	Margin, dB*	Verdict
Downlink							
Offset 6.25 kHz							
859.993825	-16.92	NA	100	-16.92	-13.0	-3.92	Pass
859.994012	NA	-16.42	100	-16.42	-13.0	-3.42	Pass
860.006575	-18.66	NA	100	-18.66	-13.0	-5.66	Pass
859.986850	NA	-16.71	100	-16.71	-13.0	-3.71	Pass
Offset 12.5 kHz							
859.983912	-22.13	NA	100	-22.13	-13.0	-9.13	Pass
859.983625	NA	-21.17	100	-21.17	-13.0	-8.17	Pass
860.008775	-20.78	NA	100	-20.78	-13.0	-7.78	Pass
859.970512	NA	-20.55	100	-20.55	-13.0	-7.55	Pass
Offset 25.0 kHz							
859.967150	-21.02	NA	100	-21.02	-13.0	-8.02	Pass
859.967087	NA	-21.22	100	-21.22	-13.0	-8.22	Pass
860.017012	-22.38	NA	100	-22.38	-13.0	-9.38	Pass
860.016987	NA	-22.74	100	-22.74	-13.0	-9.74	Pass
Offset 37.5 kHz							
859.045912	-25.76	NA	100	-25.76	-13.0	-12.76	Pass
859.981312	NA	-25.04	100	-25.04	-13.0	-12.04	Pass
860.037750	-19.42	NA	100	-19.42	-13.0	-6.42	Pass
860.037775	NA	-19.26	100	-19.26	-13.0	-6.26	Pass

*- Margin = Spurious emission – specification limit.



Test specification: Section 90.219(e)(3), Intermodulation product ERP			
Test procedure: 47 CFR, Sections 2.1051 KDB 935210 D05 v01r01 section 4.7.2			
Test mode: Compliance		Verdict: PASS	
Date(s): 24-Mar-16 - 13-Apr-16			
Temperature: 22.3 °C	Relative Humidity: 48 %	Air Pressure: 1005 hPa	Power supply: 120 VAC
Remarks:			

Table 7.8.2 ERP intermodulation product test results (continued)

ASSIGNED FREQUENCY RANGE: 851 – 862 MHz Downlink
806 – 816 MHz Uplink

DETECTOR USED: Average

VIDEO BANDWIDTH: ≥ Resolution bandwidth

MODULATING SIGNAL: PRBS

CONFIGURATION: Two signals

MODULATION: Unmodulated

Frequency, MHz	SA reading below AGC, dBm	SA reading above AGC, dBm	RBW, kHz	Spurious emission, dBm	Limit, dBm	Margin, dB*	Verdict
Uplink							
Offset 6.25 kHz							
814.993925	-17.13	NA	100	-17.13	-13.0	-4.13	Pass
814.994037	NA	-16.41	100	-16.41	-13.0	-3.41	Pass
814.986962	-19.06	NA	100	-19.06	-13.0	-6.06	Pass
814.986962	NA	-17.46	100	-17.46	-13.0	-4.46	Pass
Offset 12.5 kHz							
815.024275	-24.92	NA	100	-24.92	-13.0	-11.92	Pass
814.987812	NA	24.36	100	24.36	-13.0	37.36	Pass
815.012762	-25.73	NA	100	-25.73	-13.0	-12.73	Pass
814.974400	NA	-24.64	100	-24.64	-13.0	-11.64	Pass
Offset 25.0 kHz							
814.992075	-29.57	NA	100	-29.57	-13.0	-16.57	Pass
814.950787	NA	-31.20	100	-31.20	-13.0	-18.20	Pass
815.008337	-31.78	NA	100	-31.78	-13.0	-18.78	Pass
815.050000	NA	-30.67	100	-30.67	-13.0	-17.67	Pass
Offset 37.5 kHz							
815.044037	-29.37	NA	100	-29.37	-13.0	-16.37	Pass
815.044287	NA	-30.91	100	-30.91	-13.0	-17.91	Pass
814.990800	-31.89	NA	100	-31.89	-13.0	-18.89	Pass
815.037650	NA	-34.18	100	-34.18	-13.0	-21.18	Pass

*- Margin = Spurious emission – specification limit.

Reference numbers of test equipment used

HL 2015	HL 2909	HL 3433	HL 3434	HL 3787	HL 3788	HL 4068	HL 4097
HL 4273	HL 4274	HL 4354	HL 4413				

Full description is given in Appendix A.



HERMON LABORATORIES

Test specification: Section 90.219(e)(3), Intermodulation product ERP			
Test procedure: 47 CFR, Sections 2.1051 KDB 935210 D05 v01r01 section 4.7.2			
Test mode: Compliance		Verdict: PASS	
Date(s): 24-Mar-16 - 13-Apr-16			
Temperature: 22.3 °C	Relative Humidity: 48 %	Air Pressure: 1005 hPa	Power supply: 120 VAC
Remarks:			

Plot 7.8.1 Intermodulation test results in the 851 - 862 MHz frequency range

OPERATING FREQUENCY RANGE:

DETECTOR USED:

CONFIGURATION:

COMPOSITE INPUT POWER: -56 dBm

CHANNEL SPACING:

OUTPUT CONFIGURATION: Below AGC threshold

OPERATION FREQUENCIES:

851 – 862 MHz

Average

Downlink

COMPOSITE INPUT POWER: -51 dBm

6.25 kHz 860.000MHz

OUTPUT CONFIGURATION: Above AGC threshold +3dB

F₀ and F₁ +6.25 kHz

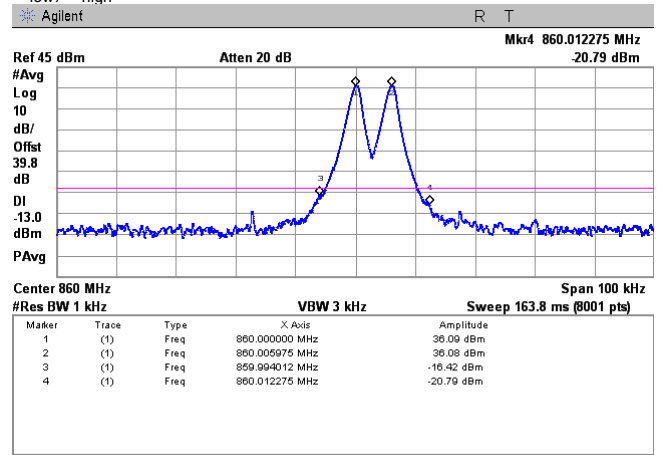
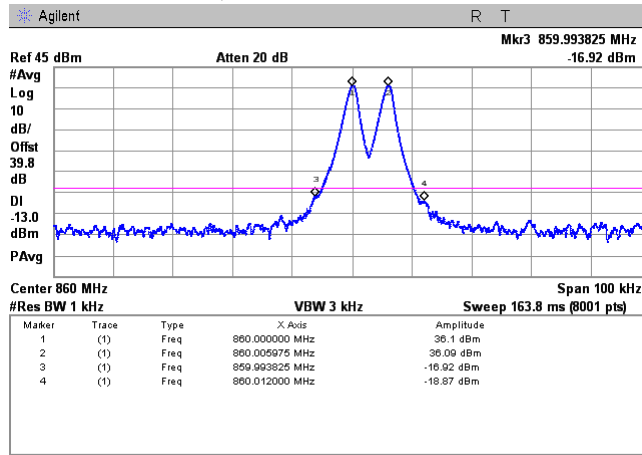

OPERATION FREQUENCIES:

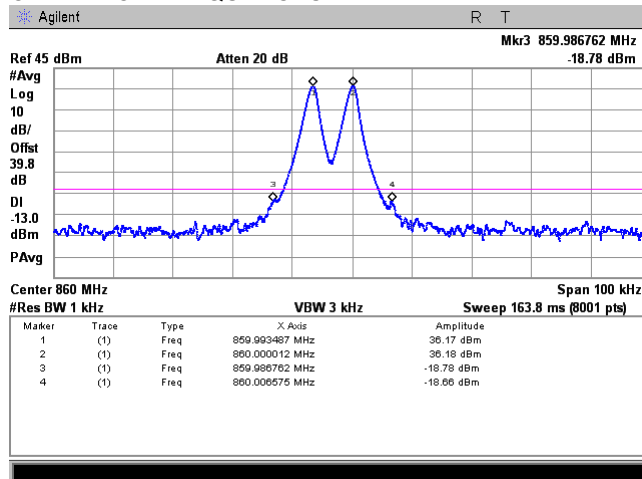

F₀ and F₁ -6.25 kHz

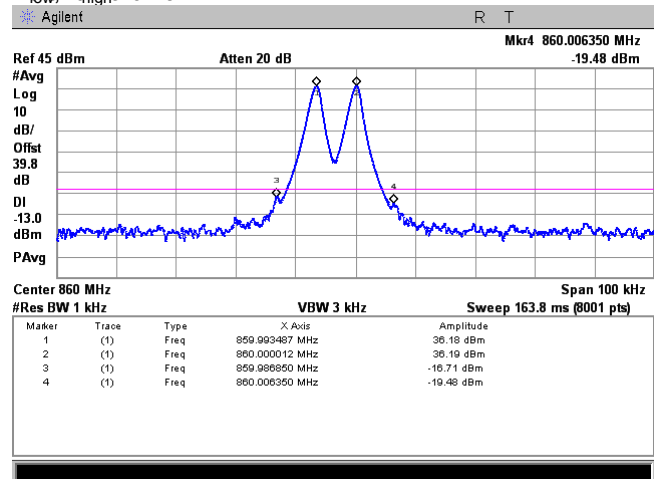



HERMON LABORATORIES

Test specification: Section 90.219(e)(3), Intermodulation product ERP	
Test procedure: 47 CFR, Sections 2.1051 KDB 935210 D05 v01r01 section 4.7.2	
Test mode: Compliance	Verdict: PASS
Date(s): 24-Mar-16 - 13-Apr-16	
Temperature: 22.3 °C	Relative Humidity: 48 %
Air Pressure: 1005 hPa	Power supply: 120 VAC
Remarks:	

Plot 7.8.2 Intermodulation test results in the 851 - 862 MHz frequency range

OPERATING FREQUENCY RANGE:

DETECTOR USED:

CONFIGURATION:

COMPOSITE INPUT POWER: -56 dBm

CHANNEL SPACING:

OUTPUT CONFIGURATION: Below AGC threshold

OPERATION FREQUENCIES:

851 – 862 MHz

Average

Uplink

COMPOSITE INPUT POWER: -51 dBm

12.5 kHz 859.996 MHz

OUTPUT CONFIGURATION: Above AGC threshold +3dB

F₀ and F₀+12.5 kHz

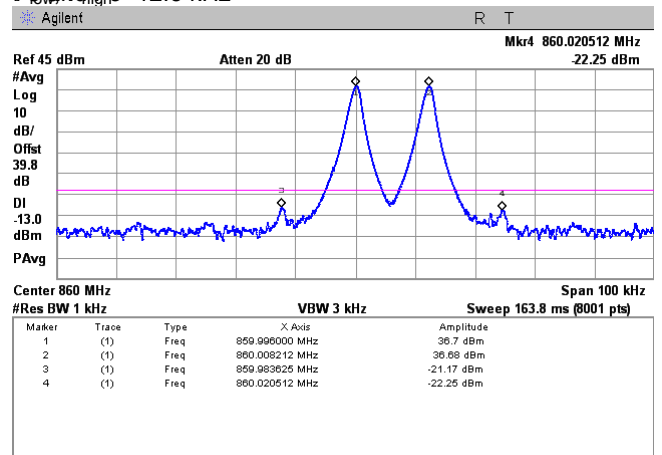
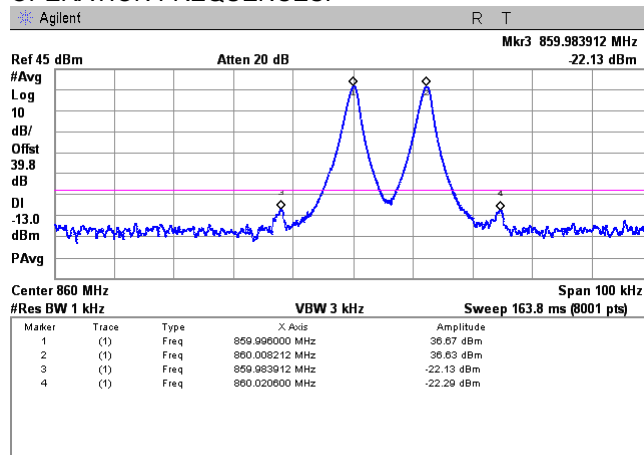

OPERATION FREQUENCIES:

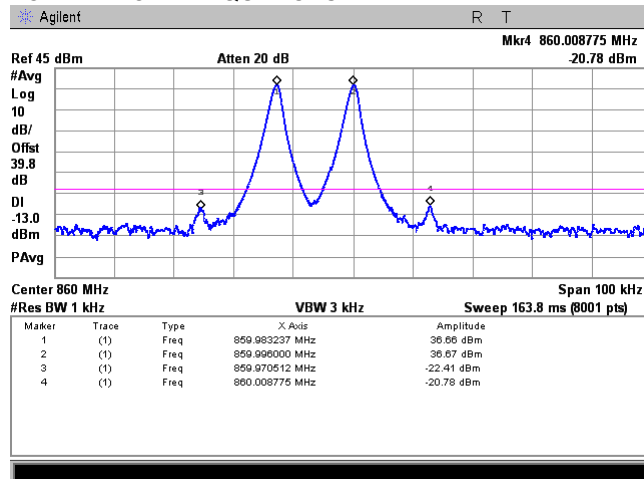

F₀ and F₀-12.5 kHz

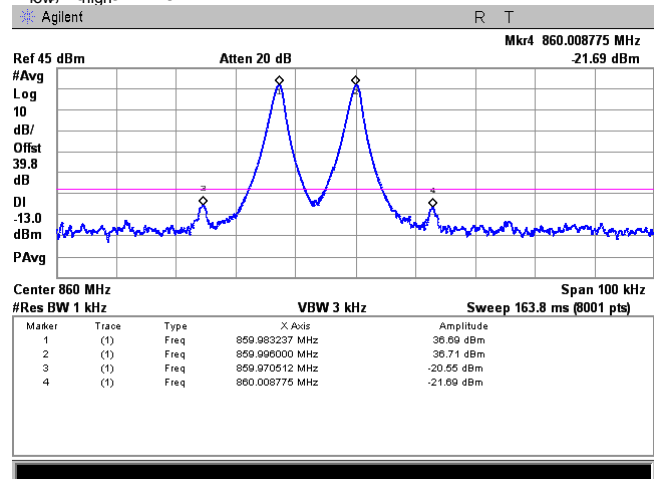



HERMON LABORATORIES

Test specification: Section 90.219(e)(3), Intermodulation product ERP			
Test procedure: 47 CFR, Sections 2.1051 KDB 935210 D05 v01r01 section 4.7.2			
Test mode: Compliance		Verdict: PASS	
Date(s): 24-Mar-16 - 13-Apr-16			
Temperature: 22.3 °C	Relative Humidity: 48 %	Air Pressure: 1005 hPa	Power supply: 120 VAC
Remarks:			

Plot 7.8.3 Intermodulation test results in the 851 - 862 MHz frequency range

OPERATING FREQUENCY RANGE:
DETECTOR USED:
CONFIGURATION:
COMPOSITE INPUT POWER: -56 dBm
CHANNEL SPACING:
OUTPUT CONFIGURATION: Below AGC threshold
OPERATION FREQUENCIES:

851 – 862 MHz
Average
Uplink
COMPOSITE INPUT POWER: -51 dBm
25 kHz 859.991765 MHz
OUTPUT CONFIGURATION: Above AGC threshold +3dB
F₀ and F₀+25 kHz

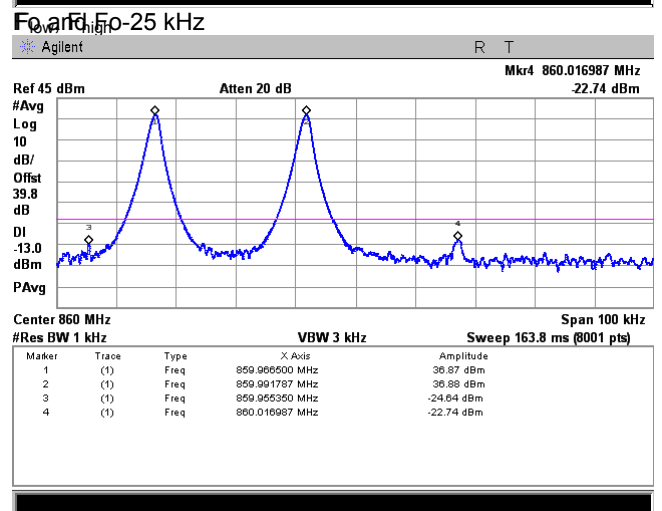
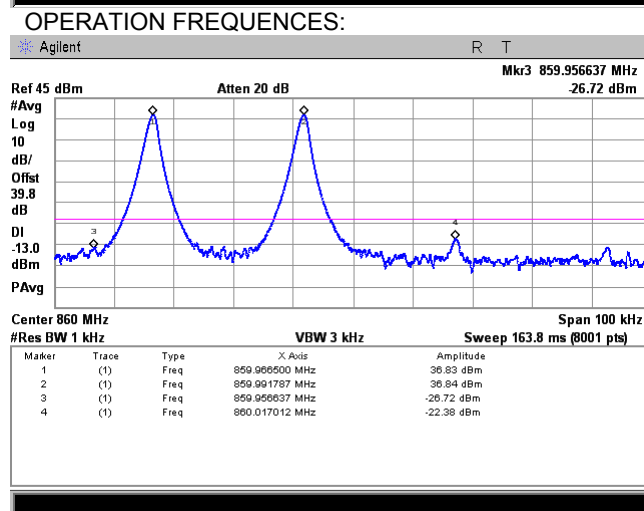
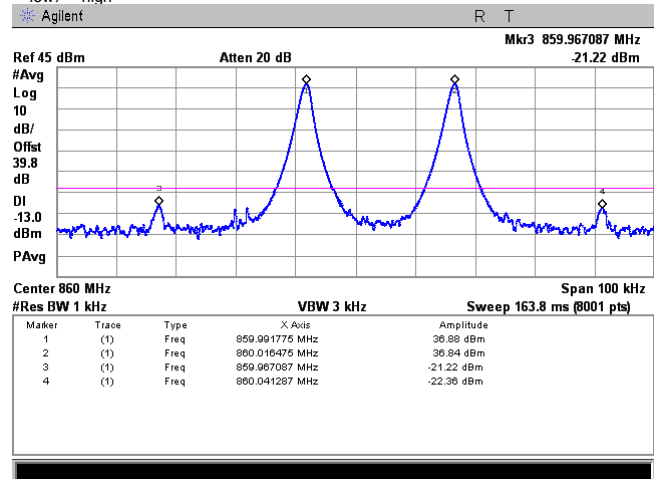
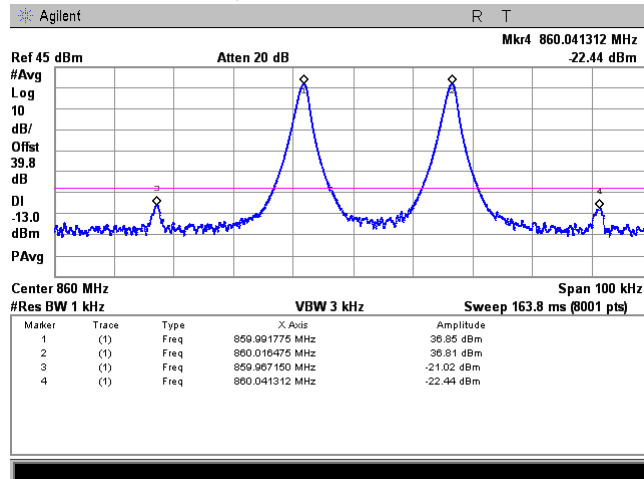



HERMON LABORATORIES

Test specification: Section 90.219(e)(3), Intermodulation product ERP			
Test procedure: 47 CFR, Sections 2.1051 KDB 935210 D05 v01r01 section 4.7.2			
Test mode: Compliance		Verdict: PASS	
Date(s): 24-Mar-16 - 13-Apr-16			
Temperature: 22.3 °C	Relative Humidity: 48 %	Air Pressure: 1005 hPa	Power supply: 120 VAC
Remarks:			

Plot 7.8.4 Intermodulation test results in the 851 - 862 MHz frequency range

OPERATING FREQUENCY RANGE:

DETECTOR USED:

CONFIGURATION:

COMPOSITE INPUT POWER: -56 dBm

CHANNEL SPACING:

OUTPUT CONFIGURATION: Below AGC threshold

OPERATION FREQUENCIES:

851 – 862 MHz

Average

Uplink

COMPOSITE INPUT POWER: -51 dBm

Above 25 kHz

OUTPUT CONFIGURATION: Above AGC threshold +3dB

F₀ and F₁ +37.5 kHz

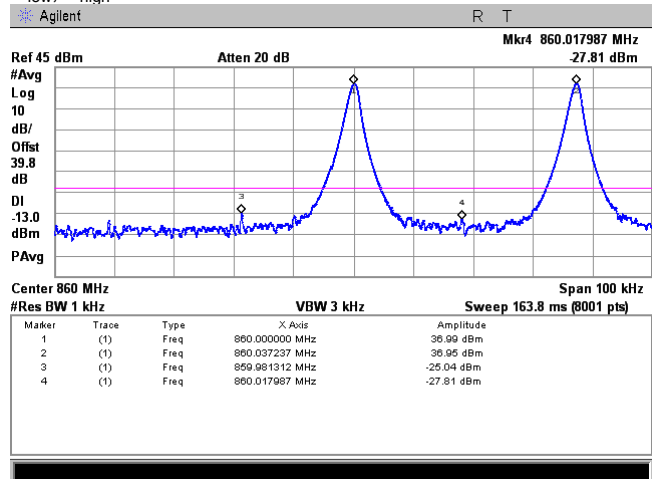
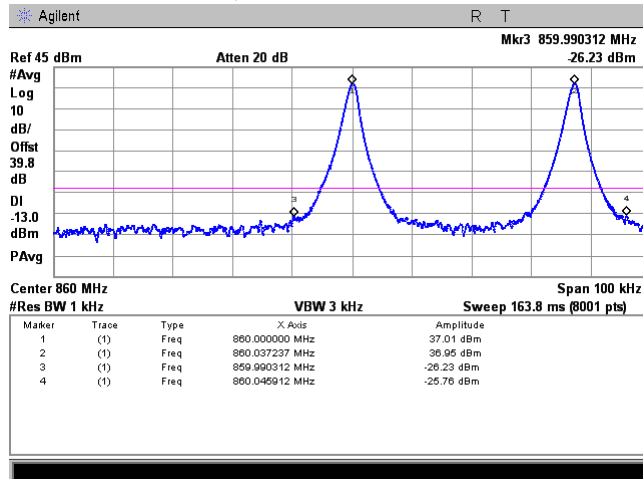

OPERATION FREQUENCIES:

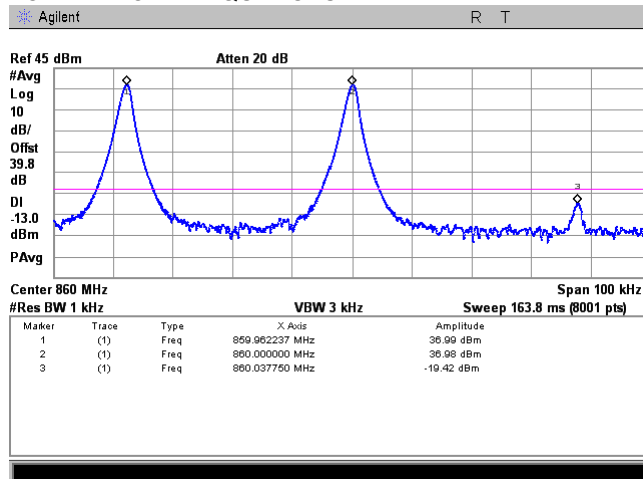

F₀ and F₁ -37.5 kHz

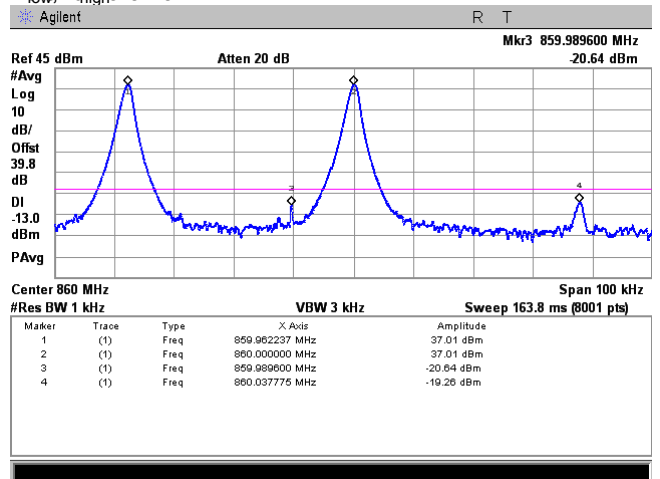



HERMON LABORATORIES

Test specification: Section 90.219(e)(3), Intermodulation product ERP			
Test procedure: 47 CFR, Sections 2.1051 KDB 935210 D05 v01r01 section 4.7.2			
Test mode: Compliance		Verdict: PASS	
Date(s): 24-Mar-16 - 13-Apr-16			
Temperature: 22.3 °C	Relative Humidity: 48 %	Air Pressure: 1005 hPa	Power supply: 120 VAC
Remarks:			

Plot 7.8.5 Intermodulation test results in the 806 - 816 MHz frequency range

OPERATING FREQUENCY RANGE:
DETECTOR USED:
CONFIGURATION:
COMPOSITE INPUT POWER: -69 dBm
CHANNEL SPACING:
OUTPUT CONFIGURATION: Below AGC threshold
OPERATION FREQUENCIES:

806 – 816 MHz
Average
Uplink
COMPOSITE INPUT POWER: -64 dBm
6.25 kHz 815.000MHz
OUTPUT CONFIGURATION: Above AGC threshold +3dB
F₀ and F₁+6.25 kHz

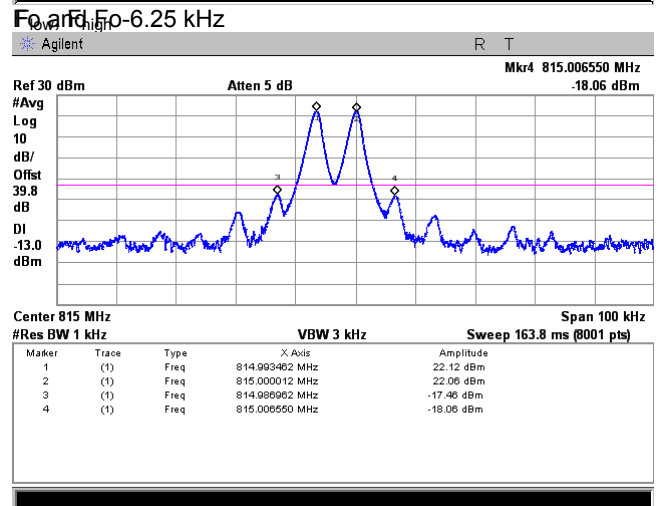
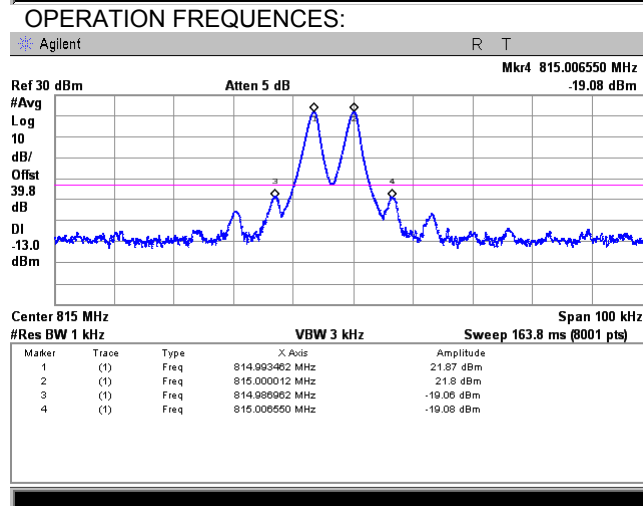
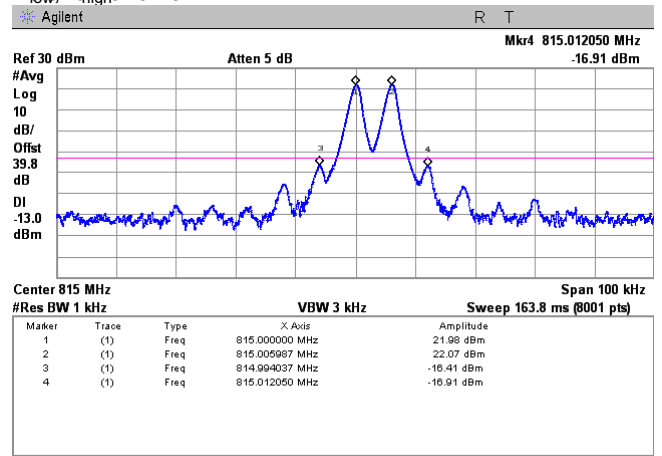
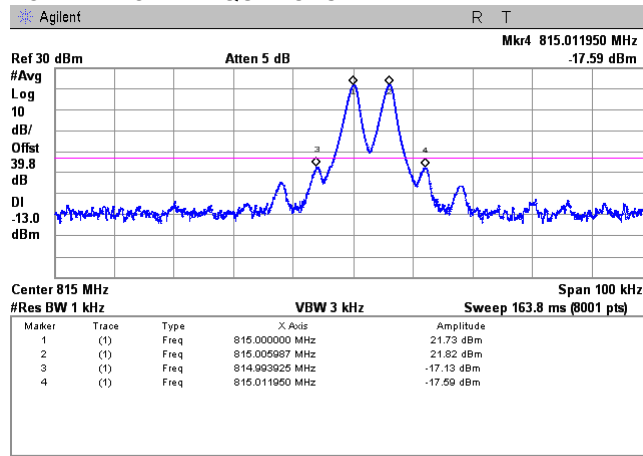



HERMON LABORATORIES

Test specification: Section 90.219(e)(3), Intermodulation product ERP			
Test procedure: 47 CFR, Sections 2.1051 KDB 935210 D05 v01r01 section 4.7.2			
Test mode: Compliance		Verdict: PASS	
Date(s): 24-Mar-16 - 13-Apr-16			
Temperature: 22.3 °C	Relative Humidity: 48 %	Air Pressure: 1005 hPa	Power supply: 120 VAC
Remarks:			

Plot 7.8.6 Intermodulation test results in the 806 - 816 MHz frequency range

OPERATING FREQUENCY RANGE:
DETECTOR USED:
CONFIGURATION:
COMPOSITE INPUT POWER: -69 dBm
CHANNEL SPACING:
OUTPUT CONFIGURATION: Below AGC threshold
OPERATION FREQUENCIES:

806 – 816 MHz
Average
Uplink
COMPOSITE INPUT POWER: -64 dBm
12.5 kHz 814.996MHz
OUTPUT CONFIGURATION: Above AGC threshold +3dB
Forward +12.5 kHz

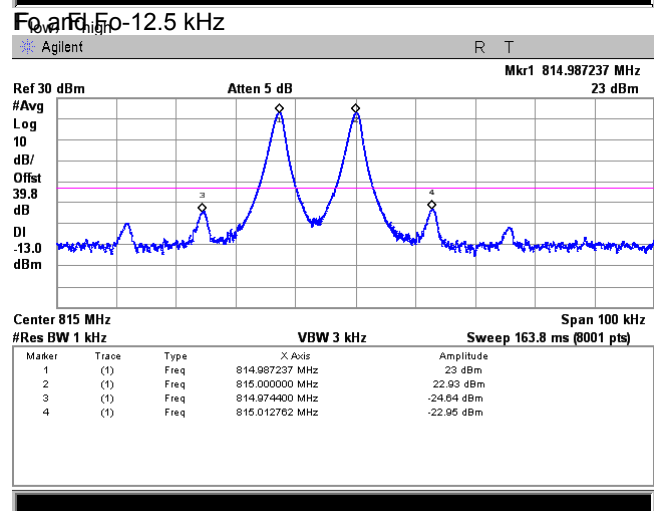
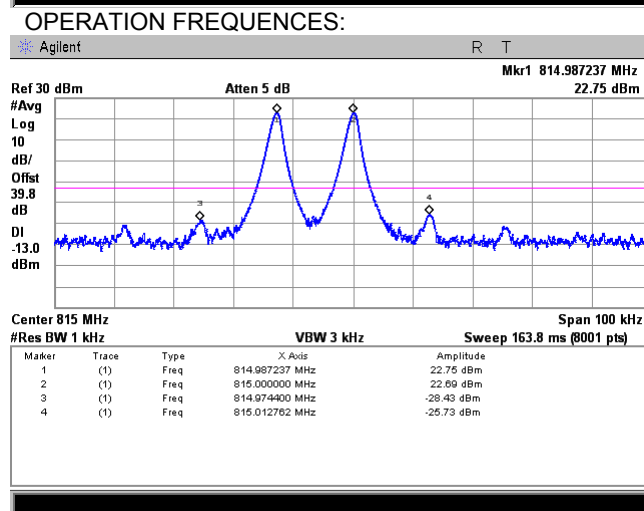
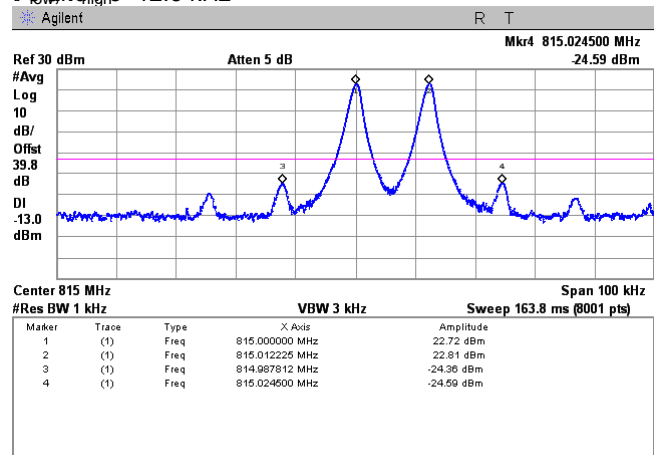
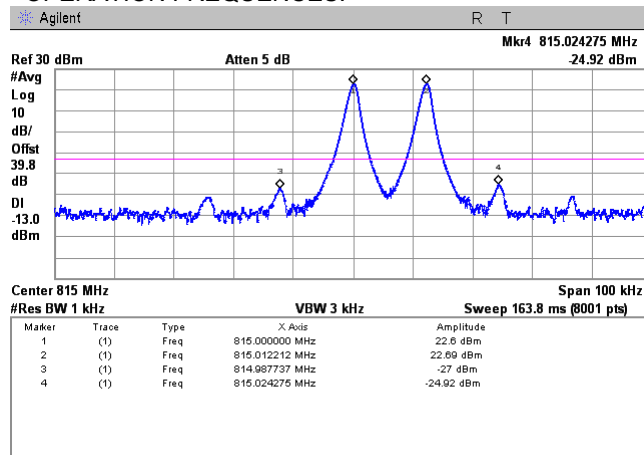



HERMON LABORATORIES

Test specification: Section 90.219(e)(3), Intermodulation product ERP	
Test procedure: 47 CFR, Sections 2.1051 KDB 935210 D05 v01r01 section 4.7.2	
Test mode: Compliance	Verdict: PASS
Date(s): 24-Mar-16 - 13-Apr-16	
Temperature: 22.3 °C	Relative Humidity: 48 %
Air Pressure: 1005 hPa	Power supply: 120 VAC
Remarks:	

Plot 7.8.7 Intermodulation test results in the 806 - 816 MHz frequency range

OPERATING FREQUENCY RANGE:

DETECTOR USED:

CONFIGURATION:

COMPOSITE INPUT POWER: -69 dBm

CHANNEL SPACING:

OUTPUT CONFIGURATION: Below AGC threshold

OPERATION FREQUENCIES:

806 – 816 MHz

Average

Uplink

COMPOSITE INPUT POWER: -64 dBm

25 kHz 814.9947 MHz

OUTPUT CONFIGURATION: Above AGC threshold +3dB

F₀ and F₀+25 kHz

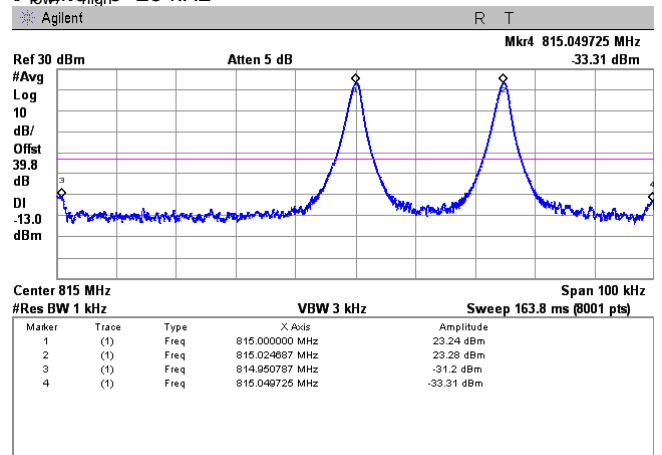
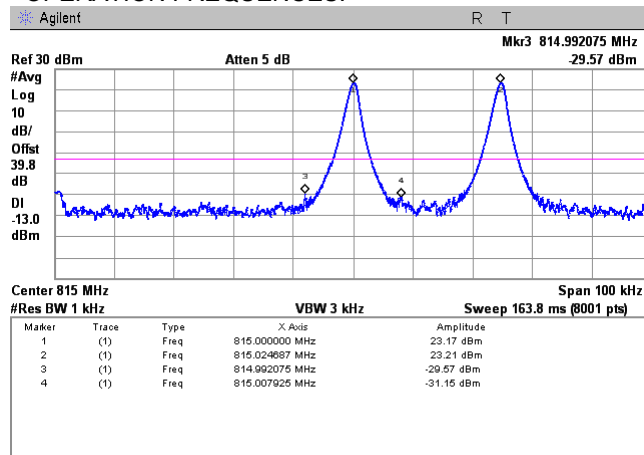

OPERATION FREQUENCIES:

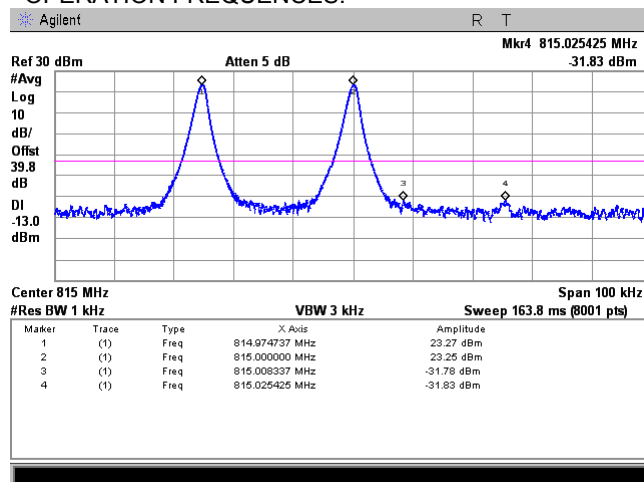

F₀ and F₀-25 kHz

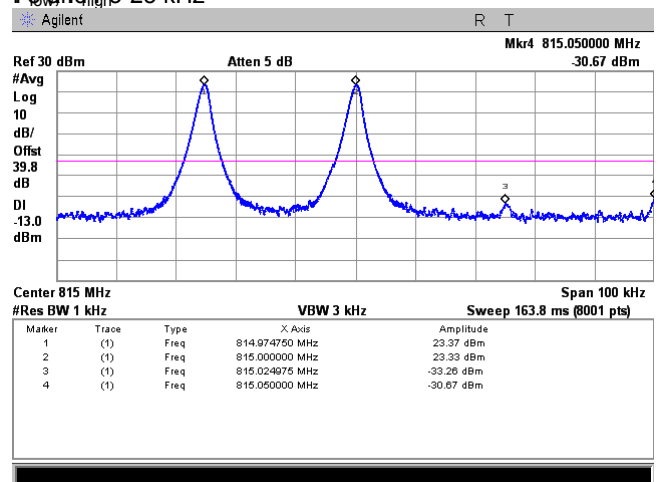



HERMON LABORATORIES

Test specification: Section 90.219(e)(3), Intermodulation product ERP	
Test procedure: 47 CFR, Sections 2.1051 KDB 935210 D05 v01r01 section 4.7.2	
Test mode: Compliance	Verdict: PASS
Date(s): 24-Mar-16 - 13-Apr-16	
Temperature: 22.3 °C	Relative Humidity: 48 %
Air Pressure: 1005 hPa	Power supply: 120 VAC
Remarks:	

Plot 7.8.8 Intermodulation test results in the 806 - 816 MHz frequency range

OPERATING FREQUENCY RANGE:
DETECTOR USED:
CONFIGURATION:
CHANNEL SPACING:
OUTPUT CONFIGURATION: Below AGC threshold
OPERATION FREQUENCIES:

806 – 816 MHz
Average
Uplink
Above 25 kHz
OUTPUT CONFIGURATION: Above AGC threshold +3dB
F₀ and F₁ +37.5 kHz

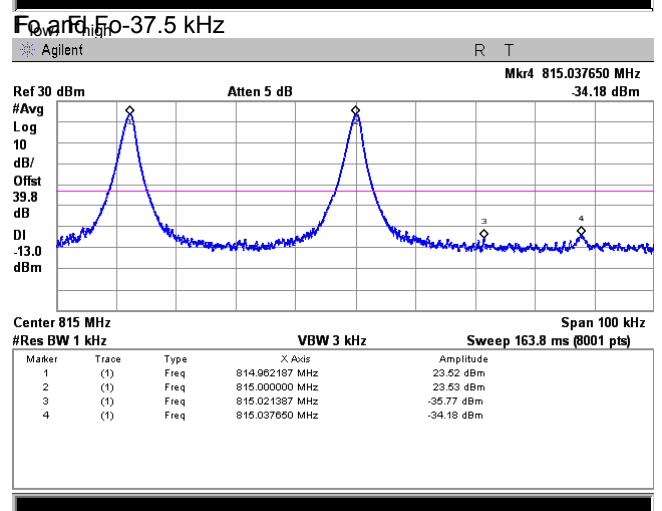
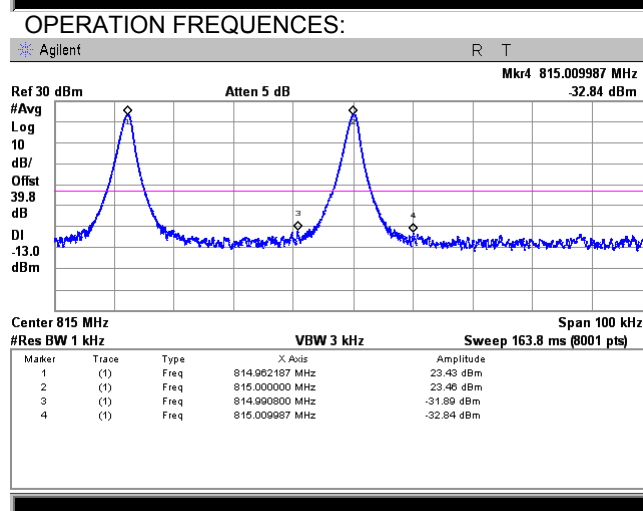
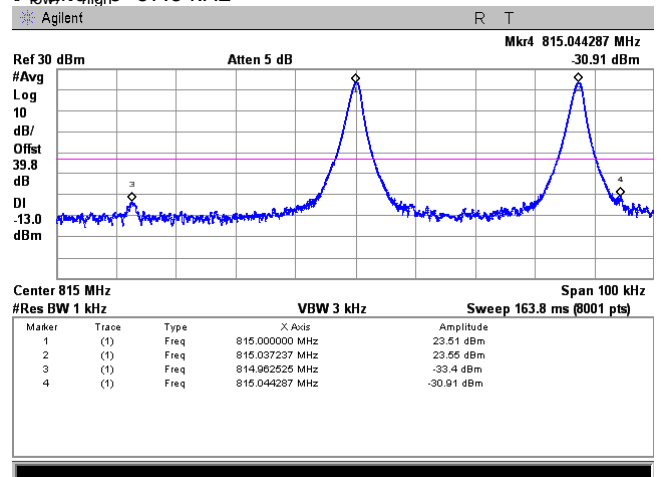
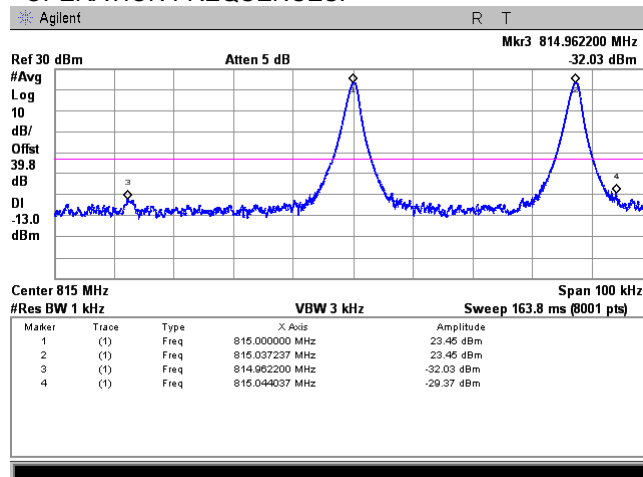

**8 APPENDIX A Test equipment and ancillaries used for tests**

HL No	Description	Manufacturer	Model	Ser. No.	Last Cal./ Check	Due Cal./ Check
0446	Antenna, Loop, Active, 10 kHz - 30 MHz	EMCO	6502	2857	18-Jan-16	18-Jan-17
0521	EMI Receiver (Spectrum Analyzer) with RF filter section 9 kHz-6.5 GHz	Hewlett Packard	8546A	3617A 00319, 3448A002 53	27-Oct-15	27-Oct-16
0539	Generator Signal, 10 kHz - 1.2 GHz	Marconi Instruments	2023	112121/04 1	31-Aug-15	31-Aug-16
0557	Generator Signal, 9 KHz - 1.2 GHz	Marconi Instruments	2023	112225/08 0	02-Jul-16	02-Jul-17
0604	Antenna BiconiLog Log-Periodic/T Bow-TIE, 26 - 2000 MHz	EMCO	3141	9611-1011	10-May-16	10-May-17
1876	Attenuator, 50 Ohm, 100 W, 20 dB	Bird Electronic Corp.	8343-200	2200	03-Feb-16	03-Feb-17
2015	Power Divider, 0.5-18.0 GHz, 80 W	Omni Spectra	2090- 6204-00	NA	01-Dec-14	01-Dec-16
2909	Spectrum analyzer, ESA-E, 100 Hz to 26.5 GHz	Agilent Technologies	E4407B	MY414447 62	30-Dec-15	30-Dec-16
3433	Test Cable , DC-18 GHz, 1.5 m, SMA - SMA	Mini-Circuits	CBL-5FT- SMSM+	25679	20-Mar-16	20-Mar-17
3434	Test Cable , DC-18 GHz, 1.5 m, SMA - SMA	Mini-Circuits	CBL-5FT- SMSM+	25683	20-Mar-16	20-Mar-17
3622	Cable RF, 6.0 m, N type-N type, DC-6.5 GHz	Alpha Wire	RG 214/U	NA	15-Dec-15	15-Dec-16
3623	Cable RF, 6.0 m, N type-N type, DC-6.5 GHz	Belden	MIL C-17	NA	09-Sep-15	09-Sep-16
3768	Attenuator, N-type, 20 dB, DC to 18 GHz, 5 W	Mini-Circuits	BW- N20W5+	NA	18-Aug-15	18-Aug-16
3772	Attenuator, N-type, 10 dB, DC to 18 GHz, 5 W	Mini-Circuits	BW- N10W5+	NA	17-Aug-15	17-Sep-16
3779	Attenuator, N-type, 10 dB, DC to 18 GHz, 5 W	Mini-Circuits	BW- N10W5+	NA	31-May-16	31-May-17
3787	Precision Fixed Attenuator, 50 Ohm, 5 W, 10 dB, DC to 18 GHz	Mini-Circuits	BW- S10W5+	NA	01-Dec-15	01-Dec-16
3788	Precision Fixed Attenuator, 50 Ohm, 5 W, 10 dB, DC to 18 GHz	Mini-Circuits	BW- S10W5+	NA	01-Dec-15	01-Dec-16
3818	PSA Series Spectrum Analyzer, 3 Hz- 44 GHz	Agilent Technologies	E4446A	MY482502 88	03-May-16	03-May-17
3901	Microwave Cable Assembly, 40.0 GHz, 3.5 m, SMA/SMA	Huber-Suhner	SUCOFLE X 102A	1225/2A	15-Feb-16	15-Feb-17
3903	Microwave Cable Assembly, 40.0 GHz, 1.5 m, SMA/SMA	Huber-Suhner	SUCOFLE X 102A	1226/2A	15-Feb-16	15-Feb-17
4068	Attenuator, SMA, 30 dB, DC to 12.4 GHz	Midwest Microwave	ATT- 0527-30- SMA-07	NA	13-Jul-15	13-Jul-16
4097	Attenuator, Manual Step, 0-60/10 dB, 0-9/1 dB, 0-4.0 GHz	Weinschel	AC9003- 69-11	17416	09-Mar-16	09-Mar-17



HL No	Description	Manufacturer	Model	Ser. No.	Last Cal./ Check	Due Cal./ Check
4273	Test Cable , DC-18 GHz, 1.8 m, SMA/M - N/M	Mini-Circuits	CBL-6FT-SMNM+	70045	30-May-16	30-May-17
4274	Test Cable , DC-18 GHz, 1.8 m, SMA/M - N/M	Mini-Circuits	CBL-6FT-SMNM+	70047	30-May-16	30-May-17
4275	Test Cable , DC-18 GHz, 1.8 m, SMA/M - N/M	Mini-Circuits	CBL-6FT-SMNM+	70050	22-Nov-15	22-Nov-16
4276	Test Cable , DC-18 GHz, 3.05 m, N/M - N/M	Mini-Circuits	APC-10FT-NMNM+	0747A	22-Nov-15	22-Nov-16
4278	Test Cable , DC-18 GHz, 4.6 m, N/M - N/M	Mini-Circuits	APC-15FT-NMNM+	0755A	22-Nov-15	22-Nov-16
4353	Low Loss Armored Test Cable, DC - 18 GHz, 6.2 m, N type-M/N type-M	MegaPhase	NC29-N1N1-244	12025101003	15-Mar-16	15-Mar-17
4354	Vector Signal Generator, 100 kHz to 6.0 GHz	Rohde & Schwarz	SMJ 100A	1403.4507 K02-101777-rc	27-Jun-16	27-Jun-17
4364	iKey 1000, USB, EMI Autotest (multi-user license), Software	Rohde & Schwarz	EMC32_M K10	101279	30-Dec-15	30-Dec-16
4413	Resistive divider, DC to 1.5 GHz, 2 W	Microlab	DA-3FN	NA	15-Jul-14	15-Jul-16
4722	Low Loss Armored Test Cable, DC - 18 GHz, 6.2 m, N type-M/N type-M	MegaPhase	NC29-N1N1-244	51228701001	30-Dec-15	30-Dec-16
4933	Active Horn Antenna, 1 GHz to 18 GHz	Com-Power Corporation	AHA-118	701046	04-Sep-15	04-Sep-16

8.1 Test equipment and ancillaries used for tests

HL No.	Description	Manufacturer	Model	Ser. No.	Last Cal./ Check	Due Cal./ Check
NA	Noise Figure Analyzer	Agilent	N8973A	GB39490364	20-Aug-15	19-Aug-17
NA	SNS Series Noise Source	Agilent	N4000A	MY44420199	20-Aug-15	19-Aug-17

9 APPENDIX B Measurement uncertainties

Expanded uncertainty at 95% confidence in Hermon Labs EMC measurements

Test description	Expanded uncertainty
Transmitter tests	
Carrier power conducted at antenna connector	± 1.7 dB
Carrier power radiated (substitution method)	± 4.5 dB
Occupied bandwidth	±8%
Conducted emissions at RF antenna connector	9 kHz to 2.9 GHz: ± 2.6 dB 2.9 GHz to 6.46 GHz: ± 3.5 dB 6.46 GHz to 13.2 GHz: ± 4.3 dB 13.2 GHz to 22.0 GHz: ± 5.0 dB 22.0 GHz to 26.8 GHz: ± 5.5 dB 26.8 GHz to 40.0 GHz: ± 4.8 dB
Spurious emissions radiated 30 MHz – 40 GHz (substitution method)	± 4.5 dB
Frequency error	30 – 300 MHz: ± 50.5 Hz (1.68 ppm) 300 – 1000 MHz: ± 168 Hz (0.56 ppm)
Transient frequency behaviour	187 Hz ± 13.9 %
Duty cycle, timing (Tx ON / OFF) and average factor measurements	± 1.0 %

Hermon Laboratories is accredited by A2LA for calibration according to present requirements of ISO/IEC 17025 and NCSL Z540-1. The accreditation is granted to perform calibration of parameters that are listed in the Scope of Hermon Laboratories Accreditation.

Hermon Laboratories calibrates its reference and transfer standards by calibration laboratories accredited to ISO/IEC 17025 by a mutually recognized Accreditation Body or by a recognized national metrology institute. All reference and transfer standards used in the calibration system are traceable to national or international standards.

In-house calibration of all test and measurement equipment is performed on a regular basis according to Hermon Laboratories calibration procedures, manufacturer calibration/verification procedures or procedures defined in the relevant standards. The Hermon Laboratories test and measurement equipment is calibrated within the tolerances specified by the manufacturers and/or by the relevant standards.

10 APPENDIX C Test facility description

Tests were performed at Hermon Laboratories Ltd., which is a fully independent, private, EMC, safety, environmental and telecommunication testing facility.

Hermon Laboratories is listed by the Federal Communications Commission (USA) for all parts of Code of Federal Regulations 47 (CFR 47), Registration Numbers 90624 for OATS and 90623 for the anechoic chamber; by Industry Canada for electromagnetic emissions (file number IC 2186A-1 for OATS), certified by VCCI, Japan (the registration numbers are R-808 for OATS, R-1082 for anechoic chamber, G-27 for full-anechoic chamber for RE measurements above 1 GHz, C-845 for conducted emissions site, T-1606 for conducted emissions at telecommunication ports), has a status of a Telefication - Listed Testing Laboratory, Certificate No. L138/00. The laboratory is accredited by American Association for Laboratory Accreditation (USA) according to ISO/IEC 17025 for electromagnetic compatibility, product safety, telecommunications testing and environmental simulation (for exact scope please refer to Certificate No. 839.01). The FCC Designation Number is IL1001.

Address: P.O. Box 23, Binyamina 30500, Israel.
Telephone: +972 4628 8001
Fax: +972 4628 8277
e-mail: mail@hermonlabs.com
website: www.hermonlabs.com

Person for contact: Mr. Alex Usoskin, CEO.

11 APPENDIX D Specification references

47CFR part 27: 2015	Private land mobile radio services
47CFR part 1: 2015	Practice and procedure
47CFR part 2: 2015	Frequency allocations and radio treaty matters; general rules and regulations
ANSI C63.2: 1996	American National Standard for Instrumentation-Electromagnetic Noise and Field Strength, 10 kHz to 40 GHz-Specifications.
ANSI/TIA/EIA-603-D:2010	Land Mobile FM or PM Communications Equipment Measurement and Performance Standards
KDB 935210 D02 v03r02:8.04.2016	Signal Boosters Certification Requirements
KDB 935210 D05 v01r01:12.02.2016	Measurements Guidance for Industrial and Non-consumer Signal Booste, Repeater and Amplifier Devices



12 APPENDIX E Test equipment correction factors

Antenna factor
Active loop antenna
Model 6502, S/N 2857, HL 0446

Frequency, MHz	Magnetic antenna factor, dB	Electric antenna factor, dB
0.009	-32.8	18.7
0.010	-33.8	17.7
0.020	-38.3	13.2
0.050	-41.1	10.4
0.075	-41.3	10.2
0.100	-41.6	9.9
0.150	-41.7	9.8
0.250	-41.6	9.9
0.500	-41.8	9.8
0.750	-41.9	9.7
1.000	-41.4	10.1
2.000	-41.5	10.0
3.000	-41.4	10.2
4.000	-41.4	10.1
5.000	-41.5	10.1
10.000	-41.9	9.6
15.000	-41.9	9.6
20.000	-42.2	9.3
25.000	-42.8	8.7
30.000	-44.0	7.5

Antenna factor in dB(1/m) is to be added to receiver meter reading in dB(μ V) to convert it into field strength in dB(μ V/m).



Antenna factor
Biconilog antenna EMCO Model 3141
Ser.No.1011, HL 0604

Frequency, MHz	Antenna factor, dB(1/m)	Frequency, MHz	Antenna factor, dB(1/m)	Frequency, MHz	Antenna factor, dB(1/m)
26	7.8	580	20.6	1320	27.8
28	7.8	600	21.3	1340	28.3
30	7.8	620	21.5	1360	28.2
40	7.2	640	21.2	1380	27.9
60	7.1	660	21.4	1400	27.9
70	8.5	680	21.9	1420	27.9
80	9.4	700	22.2	1440	27.8
90	9.8	720	22.2	1460	27.8
100	9.7	740	22.1	1480	28.0
110	9.3	760	22.3	1500	28.5
120	8.8	780	22.6	1520	28.9
130	8.7	800	22.7	1540	29.6
140	9.2	820	22.9	1560	29.8
150	9.8	840	23.1	1580	29.6
160	10.2	860	23.4	1600	29.5
170	10.4	880	23.8	1620	29.3
180	10.4	900	24.1	1640	29.2
190	10.3	920	24.1	1660	29.4
200	10.6	940	24.0	1680	29.6
220	11.6	960	24.1	1700	29.8
240	12.4	980	24.5	1720	30.3
260	12.8	1000	24.9	1740	30.8
280	13.7	1020	25.0	1760	31.1
300	14.7	1040	25.2	1780	31.0
320	15.2	1060	25.4	1800	30.9
340	15.4	1080	25.6	1820	30.7
360	16.1	1100	25.7	1840	30.6
380	16.4	1120	26.0	1860	30.6
400	16.6	1140	26.4	1880	30.6
420	16.7	1160	27.0	1900	30.6
440	17.0	1180	27.0	1920	30.7
460	17.7	1200	26.7	1940	30.9
480	18.1	1220	26.5	1960	31.2
500	18.5	1240	26.5	1980	31.6
520	19.1	1260	26.5	2000	32.0
540	19.5	1280	26.6		
560	19.8	1300	27.0		

Antenna factor in dB(1/m) is to be added to receiver meter reading in dB(μ V) to convert it into field strength in dB(μ V/m).



Antenna factor, HL 4933



Active Horn Antenna Factor Calibration

1 GHz to 18 GHz

Equipment:	ACTIVE HORN ANTENNA
Model:	AHA-118
Serial Number:	701046
Calibration Distance:	3 Meter
Polarization:	Horizontal
Calibration Date:	11/12/2014

Frequency (GHz)	Preamplifier Gain (dB)	Antenna Factor with pre-amp (dB/m)	Frequency (GHz)	Preamplifier Gain (dB)	Antenna Factor with pre-amp (dB/m)
1	40.96	-16.47	10	40.94	-1.97
1.5	41.21	-14.53	10.5	40.63	-1.06
2	41.44	-13.30	11	40.74	-1.50
2.5	41.71	-12.87	11.5	40.65	-0.52
3	41.96	-12.26	12	40.76	-0.15
3.5	42.14	-11.77	12.5	41.03	-0.85
4	42.13	-10.91	13	41.37	-0.81
4.5	41.79	-9.41	13.5	41.18	0.05
5	41.44	-7.54	14	40.98	0.36
5.5	40.91	-6.47	14.5	40.81	1.26
6	40.69	-5.48	15	40.65	0.25
6.5	40.64	-5.53	15.5	40.93	-1.05
7	40.76	-4.12	16	41.31	-1.44
7.5	40.94	-3.12	16.5	40.96	-0.80
8	40.68	-1.69	17	40.64	-0.02
8.5	40.08	-1.71	17.5	40.57	1.81
9	40.41	-1.86	18	40.08	3.63
9.5	41.21	-2.73			

Calibration according to ARP 958

Antenna Factor to be added to receiver reading:

Meter Reading (dBuV) + Antenna Factor (dB/m) = Corrected Reading (dBuV/m)



Cable loss
Test Cable, Mini-Circuits, CBL-5FT-SMSM+, SMA-SMA, 18 GHz, 1.5 m, S/N 25679
Mini-Circuits, HL 3433

Frequency, MHz	Cable loss, dB	Frequency, MHz	Cable loss, dB
10.0	0.06	9000	2.01
100	0.17	9500	2.06
500	0.41	10000	2.05
1000	0.58	10500	2.18
1500	0.72	11000	2.26
2000	0.86	11500	2.28
2500	0.96	12000	2.43
3000	1.04	12500	2.53
3500	1.13	13000	2.52
4000	1.23	13500	2.56
4500	1.31	14000	2.60
5000	1.41	14500	2.59
5500	1.49	15000	2.67
6000	1.55	15500	2.76
6500	1.63	16000	2.86
7000	1.71	16500	2.91
7500	1.78	17000	2.95
8000	1.86	17500	3.02
8500	1.92	18000	3.07



Cable loss
Test Cable, Mini-Circuits, CBL-5FT-SMSM+, SMA-SMA, 18 GHz, 1.5 m, S/N 25683
Mini-Circuits, HL 3434

Frequency, MHz	Cable loss, dB	Frequency, MHz	Cable loss, dB
10.0	0.06	9000	1.96
100	0.16	9500	2.01
500	0.40	10000	2.01
1000	0.57	10500	2.14
1500	0.72	11000	2.21
2000	0.85	11500	2.24
2500	0.95	12000	2.36
3000	1.03	12500	2.47
3500	1.11	13000	2.46
4000	1.21	13500	2.50
4500	1.29	14000	2.53
5000	1.39	14500	2.53
5500	1.46	15000	2.62
6000	1.52	15500	2.70
6500	1.60	16000	2.80
7000	1.68	16500	2.86
7500	1.75	17000	2.88
8000	1.83	17500	2.94
8500	1.88	18000	3.00



Cable loss
Cable coaxial, RG-214/U, N type-N type, 6 m
Alpha Wire, HL 3622

Frequency, MHz	Cable loss, dB	Frequency, MHz	Cable loss, dB	Frequency, MHz	Cable loss, dB
10	0.13	2100	2.95	4400	4.99
30	0.24	2200	2.99	4500	5.00
50	0.32	2300	3.11	4600	5.17
100	0.47	2400	3.16	4700	5.18
200	0.70	2500	3.31	4800	5.33
300	0.88	2600	3.36	4900	5.34
400	1.05	2700	3.46	5000	5.50
500	1.21	2800	3.52	5100	5.56
600	1.36	2900	3.65	5200	5.76
700	1.49	3000	3.70	5300	5.76
800	1.63	3100	3.82	5400	5.85
900	1.72	3200	3.88	5500	5.88
1000	1.84	3300	3.99	5600	5.96
1100	1.96	3400	4.08	5700	6.02
1200	2.06	3500	4.19	5800	6.06
1300	2.15	3600	4.28	5900	6.14
1400	2.28	3700	4.42	6000	6.17
1500	2.35	3800	4.40	6100	6.28
1600	2.43	3900	4.51	6200	6.36
1700	2.57	4000	4.62	6300	6.47
1800	2.62	4100	4.70	6400	6.51
1900	2.75	4200	4.78	6500	6.65
2000	2.80	4300	4.83		



Cable loss
Cable coaxial, MIL C-17, N type-N type, 6 m
Belden, HL 3623

Frequency, MHz	Cable loss, dB	Frequency, MHz	Cable loss, dB	Frequency, MHz	Cable loss, dB
10	0.10	2600	4.35	5300	7.67
50	0.30	2700	4.54	5400	7.79
100	0.45	2800	4.70	5500	7.89
200	0.69	2900	4.87	5600	7.94
300	0.89	3000	5.04	5700	8.01
400	1.06	3100	5.19	5800	8.12
500	1.24	3200	5.35	5900	8.19
600	1.38	3300	5.50	6000	8.30
700	1.54	3400	5.65	6100	8.35
800	1.69	3500	5.79	6200	8.45
900	1.83	3600	5.92	6300	8.55
1000	1.96	3700	6.07	6400	8.65
1100	2.14	3800	6.17	6500	8.75
1200	2.31	3900	6.30		
1300	2.38	4000	6.43		
1400	2.51	4100	6.53		
1500	2.63	4200	6.65		
1600	2.76	4300	6.75		
1700	2.90	4400	6.85		
1800	3.04	4500	7.01		
1900	3.19	4600	7.09		
2000	3.35	4700	7.20		
2100	3.51	4800	7.24		
2200	3.67	4900	7.31		
2300	3.84	5000	7.41		
2400	4.01	5100	7.48		
2500	4.18	5200	7.56		



Cable loss
Microwave Cable Assembly, Huber-Suhner, 40 GHz, 3.5 m, SMA-SMA, S/N 1225/2A
HL 3901

Frequency, MHz	Cable loss, dB	Frequency, MHz	Cable loss, dB	Frequency, MHz	Cable loss, dB
10	0.09	9500	4.29	21000	6.67
100	0.41	10000	4.40	22000	6.92
500	0.93	10500	4.52	23000	7.00
1000	1.33	11000	4.64	24000	7.18
1500	1.63	11500	4.76	25000	7.29
2000	1.90	12000	4.87	26000	7.55
2500	2.12	12500	4.99	27000	7.70
3000	2.33	13000	5.11	28000	7.88
3500	2.50	13500	5.20	29000	8.02
4000	2.67	14000	5.31	30000	8.15
4500	2.82	14500	5.42	31000	8.35
5000	2.99	15000	5.51	32000	8.40
5500	3.16	15500	5.58	33000	8.62
6000	3.32	16000	5.68	34000	8.73
6500	3.51	16500	5.78	35000	8.78
7000	3.65	17000	5.91	36000	8.94
7500	3.79	17500	5.99	37000	9.21
8000	3.92	18000	6.07	38000	9.37
8500	4.04	19000	6.36	39000	9.45
9000	4.18	20000	6.49	40000	9.52



Cable loss
Microwave Cable Assembly, Huber-Suhner, 40 GHz, 1.5 m, SMA-SMA, S/N 1226/2A
HL 3903

Frequency, MHz	Cable loss, dB	Frequency, MHz	Cable loss, dB	Frequency, MHz	Cable loss, dB
10	-0.02	9500	1.84	21000	2.98
100	0.15	10000	1.86	22000	3.07
500	0.38	10500	1.93	23000	3.13
1000	0.56	11000	1.99	24000	3.21
1500	0.69	11500	2.04	25000	3.26
2000	0.82	12000	2.10	26000	3.48
2500	0.90	12500	2.15	27000	3.44
3000	0.98	13000	2.21	28000	3.53
3500	1.06	13500	2.25	29000	3.59
4000	1.11	14000	2.29	30000	3.66
4500	1.17	14500	2.34	31000	3.70
5000	1.24	15000	2.36	32000	3.79
5500	1.32	15500	2.40	33000	3.88
6000	1.40	16000	2.45	34000	3.94
6500	1.50	16500	2.48	35000	3.91
7000	1.56	17000	2.56	36000	4.05
7500	1.62	17500	2.58	37000	4.22
8000	1.68	18000	2.60	38000	4.25
8500	1.74	19000	2.84	39000	4.27
9000	1.78	20000	2.88	40000	4.33



Cable loss
Test cable, Mini-Circuits, S/N 70045, 18 GHz, 1.8 m, SMA/M - N/M
CBL-6FT-SMNM+, HL 4273

Frequency, MHz	Cable loss, dB	Frequency, MHz	Cable loss, dB	Frequency, MHz	Cable loss, dB	Frequency, MHz	Cable loss, dB
10	0.09	4800	1.76	9800	2.70	14800	3.59
30	0.11	4900	1.78	9900	2.71	14900	3.59
50	0.14	5000	1.81	10000	2.73	15000	3.60
100	0.20	5100	1.82	10100	2.75	15100	3.63
200	0.30	5200	1.86	10200	2.76	15200	3.67
300	0.38	5300	1.89	10300	2.79	15300	3.70
400	0.45	5400	1.92	10400	2.81	15400	3.68
500	0.50	5500	1.96	10500	2.82	15500	3.70
600	0.55	5600	2.00	10600	2.83	15600	3.71
700	0.60	5700	2.03	10700	2.87	15700	3.77
800	0.65	5800	2.04	10800	2.87	15800	3.75
900	0.69	5900	2.07	10900	2.88	15900	3.77
1000	0.73	6000	2.10	11000	2.89	16000	3.79
1100	0.77	6100	2.10	11100	2.91	16100	3.85
1200	0.80	6200	2.11	11200	2.92	16200	3.82
1300	0.84	6300	2.11	11300	2.94	16300	3.83
1400	0.88	6400	2.14	11400	2.95	16400	3.88
1500	0.92	6500	2.15	11500	2.98	16500	3.89
1600	0.95	6600	2.15	11600	3.00	16600	3.92
1700	0.98	6700	2.16	11700	3.02	16700	3.88
1800	1.01	6800	2.19	11800	3.04	16800	3.95
1900	1.04	6900	2.22	11900	3.08	16900	3.91
2000	1.07	7000	2.24	12000	3.09	17000	3.97
2100	1.09	7100	2.26	12100	3.12	17100	3.92
2200	1.13	7200	2.29	12200	3.13	17200	3.94
2300	1.15	7300	2.32	12300	3.16	17300	3.94
2400	1.18	7400	2.36	12400	3.17	17400	3.98
2500	1.21	7500	2.39	12500	3.19	17500	3.93
2600	1.24	7600	2.41	12600	3.20	17600	3.95
2700	1.27	7700	2.43	12700	3.21	17700	3.96
2800	1.30	7800	2.46	12800	3.21	17800	3.97
2900	1.34	7900	2.49	12900	3.22	17900	3.96
3000	1.36	8000	2.52	13000	3.22	18000	3.97
3100	1.38	8100	2.52	13100	3.24		
3200	1.41	8200	2.54	13200	3.24		
3300	1.45	8300	2.59	13300	3.27		
3400	1.46	8400	2.61	13400	3.28		
3500	1.49	8500	2.60	13500	3.31		
3600	1.51	8600	2.63	13600	3.31		
3700	1.55	8700	2.65	13700	3.35		
3800	1.34	8800	2.65	13800	3.37		
3900	1.36	8900	2.65	13900	3.40		
4000	1.38	9000	2.66	14000	3.43		
4100	1.41	9100	2.66	14100	3.45		
4200	1.45	9200	2.67	14200	3.46		
4300	1.46	9300	2.67	14300	3.46		
4400	1.49	9400	2.67	14400	3.49		
4500	1.51	9500	2.68	14500	3.50		
4600	1.55	9600	2.69	14600	3.50		
4700	1.34	9700	2.69	14700	3.52		



Cable loss
Test cable, Mini-Circuits, S/N 70047, 18 GHz, 1.8 m, SMA/M - N/M
CBL-6FT-SMNM+, HL 4274

Frequency, MHz	Cable loss, dB	Frequency, MHz	Cable loss, dB	Frequency, MHz	Cable loss, dB	Frequency, MHz	Cable loss, dB
10	0.07	4800	1.69	9800	2.62	14800	3.42
30	0.11	4900	1.70	9900	2.63	14900	3.39
50	0.14	5000	1.72	10000	2.64	15000	3.38
100	0.21	5100	1.75	10100	2.64	15100	3.40
200	0.26	5200	1.76	10200	2.66	15200	3.41
300	0.30	5300	1.77	10300	2.67	15300	3.40
400	0.37	5400	1.79	10400	2.68	15400	3.39
500	0.44	5500	1.82	10500	2.68	15500	3.41
600	0.49	5600	1.85	10600	2.70	15600	3.44
700	0.54	5700	1.86	10700	2.71	15700	3.46
800	0.58	5800	1.87	10800	2.73	15800	3.45
900	0.63	5900	1.91	10900	2.74	15900	3.47
1000	0.67	6000	1.94	11000	2.76	16000	3.51
1100	0.71	6100	1.97	11100	2.77	16100	3.56
1200	0.75	6200	1.98	11200	2.78	16200	3.55
1300	0.78	6300	1.99	11300	2.79	16300	3.54
1400	0.81	6400	2.02	11400	2.80	16400	3.57
1500	0.85	6500	2.05	11500	2.82	16500	3.62
1600	0.88	6600	2.06	11600	2.83	16600	3.61
1700	0.91	6700	2.06	11700	2.84	16700	3.60
1800	0.94	6800	2.08	11800	2.85	16800	3.62
1900	0.97	6900	2.10	11900	2.87	16900	3.68
2000	1.00	7000	2.12	12000	2.88	17000	3.70
2100	1.03	7100	2.12	12100	2.89	17100	3.68
2200	1.06	7200	2.13	12200	2.90	17200	3.70
2300	1.08	7300	2.16	12300	2.92	17300	3.80
2400	1.11	7400	2.19	12400	2.94	17400	3.84
2500	1.14	7500	2.22	12500	2.95	17500	3.83
2600	1.16	7600	2.23	12600	2.96	17600	3.83
2700	1.19	7700	2.26	12700	2.98	17700	3.86
2800	1.21	7800	2.30	12800	3.00	17800	3.86
2900	1.27	7900	2.33	12900	3.02	17900	3.80
3000	1.29	8000	2.35	13000	3.03	18000	3.79
3100	1.32	8100	2.37	13100	3.06		
3200	1.35	8200	2.41	13200	3.08		
3300	1.37	8300	2.44	13300	3.09		
3400	1.38	8400	2.47	13400	3.10		
3500	1.41	8500	2.48	13500	3.13		
3600	1.43	8600	2.51	13600	3.17		
3700	1.46	8700	2.53	13700	3.17		
3800	1.47	8800	2.55	13800	3.18		
3900	1.49	8900	2.56	13900	3.22		
4000	1.52	9000	2.57	14000	3.26		
4100	1.55	9100	2.58	14100	3.28		
4200	1.56	9200	2.59	14200	3.30		
4300	1.58	9300	2.59	14300	3.35		
4400	1.60	9400	2.60	14400	3.39		
4500	1.63	9500	2.60	14500	3.39		
4600	1.65	9600	2.61	14600	3.39		
4700	1.67	9700	2.61	14700	3.41		



Cable loss
Test cable, Mini-Circuits, S/N 70050, 18 GHz, 1.8 m, SMA/M - N/M
CBL-6FT-SMNM+, HL 4275

Frequency, MHz	Cable loss, dB	Frequency, MHz	Cable loss, dB	Frequency, MHz	Cable loss, dB	Frequency, MHz	Cable loss, dB
10	0.08	5000	1.71	10200	2.64	15400	3.46
30	0.11	5100	1.73	10300	2.65	15500	3.47
50	0.14	5200	1.75	10400	2.66	15600	3.52
100	0.21	5300	1.76	10500	2.67	15700	3.55
200	0.30	5400	1.77	10600	2.70	15800	3.55
300	0.37	5500	1.82	10700	2.71	15900	3.55
400	0.43	5600	1.84	10800	2.72	16000	3.61
500	0.49	5700	1.86	10900	2.73	16100	3.62
600	0.54	5800	1.86	11000	2.75	16200	3.63
700	0.58	5900	1.89	11100	2.77	16300	3.62
800	0.62	6000	1.94	11200	2.78	16400	3.66
900	0.66	6100	1.95	11300	2.80	16500	3.71
1000	0.70	6200	1.96	11400	2.82	16600	3.71
1100	0.74	6300	1.97	11500	2.83	16700	3.67
1200	0.78	6400	2.01	11600	2.84	16800	3.69
1300	0.81	6500	2.03	11700	2.86	16900	3.74
1400	0.84	6600	2.02	11800	2.88	17000	3.73
1500	0.88	6700	2.02	11900	2.89	17100	3.71
1600	0.91	6800	2.05	12000	2.90	17200	3.73
1700	0.94	6900	2.06	12100	2.92	17300	3.77
1800	0.97	7000	2.07	12200	2.93	17400	3.77
1900	1.00	7100	2.07	12300	2.94	17500	3.76
2000	1.02	7200	2.08	12400	2.96	17600	3.76
2100	1.05	7300	2.11	12500	2.98	17700	3.78
2200	1.07	7400	2.13	12600	2.99	17800	3.80
2300	1.10	7500	2.15	12700	3.01	17900	3.79
2400	1.13	7600	2.16	12800	3.03	18000	3.78
2500	1.15	7700	2.18	12900	3.05		
2600	1.18	7800	2.21	13000	3.07		
2700	1.20	7900	2.24	13100	3.09		
2800	1.24	8000	2.25	13200	3.12		
2900	1.26	8100	2.26	13300	3.13		
3000	1.28	8200	2.29	13400	3.14		
3100	1.30	8300	2.31	13500	3.16		
3200	1.33	8400	2.33	13600	3.18		
3300	1.36	8500	2.33	13700	3.19		
3400	1.37	8600	2.34	13800	3.21		
3500	1.39	8700	2.36	13900	3.23		
3600	1.42	8800	2.38	14000	3.25		
3700	1.45	8900	2.39	14100	3.26		
3800	1.46	9000	2.40	14200	3.27		
3900	1.48	9100	2.42	14300	3.30		
4000	1.50	9200	2.45	14400	3.32		
4100	1.53	9300	2.46	14500	3.33		
4200	1.55	9400	2.48	14600	3.34		
4300	1.57	9500	2.50	14700	3.36		
4400	1.59	9600	2.52	14800	3.39		
4500	1.61	9700	2.54	14900	3.40		
4600	1.64	9800	2.56	15000	3.41		
4700	1.66	9900	2.58	15100	3.41		
4800	1.67	10000	2.60	15200	3.44		
4900	1.69	10100	2.61	15300	3.46		



Cable loss
Test cable, Mini-Circuits, S/N 0747A, 18 GHz, 3.05 m, N/M - N/M
APC-10FT-NMNM+, HL 4276

Frequency, MHz	Cable loss, dB	Frequency, MHz	Cable loss, dB	Frequency, MHz	Cable loss, dB	Frequency, MHz	Cable loss, dB
10	0.11	4500	2.81	9300	4.30	14100	5.59
30	0.19	4600	2.85	9400	4.33	14200	5.61
50	0.25	4700	2.88	9500	4.36	14300	5.63
100	0.36	4800	2.92	9600	4.39	14400	5.66
150	0.44	4900	2.95	9700	4.42	14500	5.68
200	0.52	5000	3.00	9800	4.46	14600	5.70
300	0.64	5100	3.03	9900	4.49	14700	5.72
400	0.75	5200	3.08	10000	4.53	14800	5.75
500	0.84	5300	3.11	10100	4.56	14900	5.77
600	0.93	5400	3.13	10200	4.60	15000	5.80
700	1.01	5500	3.16	10300	4.64	15100	5.82
800	1.08	5600	3.20	10400	4.66	15200	5.85
900	1.15	5700	3.22	10500	4.68	15300	5.88
1000	1.22	5800	3.26	10600	4.70	15400	5.91
1100	1.28	5900	3.30	10700	4.73	15500	5.93
1200	1.34	6000	3.34	10800	4.75	15600	5.97
1300	1.40	6100	3.39	10900	4.77	15700	5.99
1400	1.46	6200	3.42	11000	4.80	15800	6.02
1500	1.51	6300	3.47	11100	4.83	15900	6.07
1600	1.57	6400	3.50	11200	4.86	16000	6.08
1700	1.62	6500	3.52	11300	4.88	16100	6.11
1800	1.68	6600	3.55	11400	4.90	16200	6.12
1900	1.72	6700	3.58	11500	4.92	16300	6.14
2000	1.77	6800	3.60	11600	4.94	16400	6.17
2100	1.82	6900	3.62	11700	4.96	16500	6.19
2200	1.87	7000	3.64	11800	4.98	16600	6.21
2300	1.92	7100	3.66	11900	5.01	16700	6.22
2400	1.96	7200	3.68	12000	5.03	16800	6.24
2500	2.01	7300	3.71	12100	5.06	16900	6.26
2600	2.05	7400	3.74	12200	5.09	17000	6.28
2700	2.10	7500	3.78	12300	5.12	17100	6.31
2800	2.14	7600	3.81	12400	5.15	17200	6.33
2900	2.18	7700	3.84	12500	5.17	17300	6.36
3000	2.23	7800	3.87	12600	5.20	17400	6.39
3100	2.27	7900	3.90	12700	5.22	17500	6.42
3200	2.31	8000	3.93	12800	5.25	17600	6.45
3300	2.35	8100	3.96	12900	5.28	17700	6.48
3400	2.39	8200	4.00	13000	5.32	17800	6.50
3500	2.42	8300	4.03	13100	5.35	17900	6.52
3600	2.46	8400	4.06	13200	5.38	18000	6.55
3700	2.50	8500	4.08	13300	5.40		
3800	2.54	8600	4.11	13400	5.42		
3900	2.58	8700	4.13	13500	5.44		
4000	2.61	8800	4.16	13600	5.46		
4100	2.65	8900	4.18	13700	5.48		
4200	2.69	9000	4.21	13800	5.51		
4300	2.73	9100	4.24	13900	5.53		
4400	2.77	9200	4.27	14000	5.56		



Cable loss
Test cable, Mini-Circuits, S/N 0755A, 18 GHz, 4.6 m, N/M - N/M
APC-15FT-NMNM+, HL 4278

Frequency, MHz	Cable loss, dB	Frequency, MHz	Cable loss, dB	Frequency, MHz	Cable loss, dB	Frequency, MHz	Cable loss, dB
10	0.24	4900	4.19	10000	6.47	15100	8.33
30	0.26	5000	4.25	10100	6.50	15200	8.35
50	0.34	5100	4.29	10200	6.52	15300	8.37
100	0.50	5200	4.32	10300	6.57	15400	8.40
200	0.72	5300	4.38	10400	6.59	15500	8.42
300	0.90	5400	4.41	10500	6.61	15600	8.46
400	1.06	5500	4.46	10600	6.64	15700	8.50
500	1.20	5600	4.51	10700	6.64	15800	8.52
600	1.32	5700	4.56	10800	6.65	15900	8.56
700	1.44	5800	4.59	10900	6.68	16000	8.61
800	1.54	5900	4.64	11000	6.68	16100	8.64
900	1.64	6000	4.69	11100	6.69	16200	8.66
1000	1.74	6100	4.72	11200	6.70	16300	8.70
1100	1.83	6200	4.77	11300	6.74	16400	8.73
1200	1.92	6300	4.80	11400	6.78	16500	8.74
1300	2.01	6400	4.83	11500	6.81	16600	8.75
1400	2.09	6500	4.89	11600	6.84	16700	8.78
1500	2.18	6600	4.90	11700	6.87	16800	8.79
1600	2.25	6700	4.95	11800	6.92	16900	8.81
1700	2.33	6800	5.01	11900	6.98	17000	8.85
1800	2.39	6900	4.99	12000	7.02	17100	8.90
1900	2.47	7000	5.04	12100	7.08	17200	8.95
2000	2.53	7100	5.11	12200	7.15	17300	8.99
2100	2.60	7200	5.14	12300	7.20	17400	9.03
2200	2.67	7300	5.21	12400	7.26	17500	9.07
2300	2.73	7400	5.29	12500	7.31	17600	9.11
2400	2.80	7500	5.33	12600	7.36	17700	9.15
2500	2.87	7600	5.38	12700	7.41	17800	9.19
2600	2.93	7700	5.46	12800	7.46	17900	9.24
2700	3.00	7800	5.52	12900	7.51	18000	9.28
2800	3.06	7900	5.58	13000	7.55		
2900	3.12	8000	5.64	13100	7.59		
3000	3.18	8100	5.69	13200	7.65		
3100	3.24	8200	5.75	13300	7.69		
3200	3.30	8300	5.80	13400	7.72		
3300	3.35	8400	5.84	13500	7.78		
3400	3.42	8500	5.90	13600	7.82		
3500	3.46	8600	5.97	13700	7.86		
3600	3.52	8700	5.99	13800	7.91		
3700	3.57	8800	6.04	13900	7.96		
3800	3.61	8900	6.10	14000	8.01		
3900	3.67	9000	6.13	14100	8.06		
4000	3.71	9100	6.17	14200	8.10		
4100	3.77	9200	6.23	14300	8.13		
4200	3.83	9300	6.27	14400	8.16		
4300	3.89	9400	6.30	14500	8.19		
4400	3.94	9500	6.35	14600	8.21		
4500	4.00	9600	6.37	14700	8.23		
4600	4.05	9700	6.40	14800	8.26		
4700	4.10	9800	6.44	14900	8.28		
4800	4.16	9900	6.45	15000	8.30		



Cable loss
Low Loss Armored Test Cable, MegaPhase, 18 GHz, 6.2 m, N type-M/N type-M,
NC29-N1N1-244S/N 12025101 003,
HL 4353

Frequency, MHz	Cable loss, dB	Frequency, MHz	Cable loss, dB
50	0.20	9000	2.71
100	0.27	9500	2.81
300	0.47	10000	2.90
500	0.61	10500	2.97
1000	0.87	11000	3.06
1500	1.07	11500	3.13
2000	1.24	12000	3.20
2500	1.39	12500	3.26
3000	1.53	13000	3.34
3500	1.65	13500	3.39
4000	1.77	14000	3.47
4500	1.89	14500	3.54
5000	1.99	15000	3.62
5500	2.07	15500	3.69
6000	2.20	16000	3.76
6500	2.30	16500	3.83
7000	2.39	17000	3.86
7500	2.51	17500	3.94
8000	2.58	18000	4.02
8500	2.65		



Cable loss
Low Loss Armored Test Cable, MegaPhase, 18 GHz, 6.2 m, N type-M/N type-M,
NC29-N1N1-244, S/N 51228701001
HL 4722

Frequency, MHz	Cable loss, dB	Frequency, MHz	Cable loss, dB
50	0.22	9000	2.93
100	0.30	9500	3.06
300	0.52	10000	3.16
500	0.66	10500	3.20
1000	0.93	11000	3.34
1500	1.15	11500	3.39
2000	1.33	12000	3.48
2500	1.49	12500	3.55
3000	1.64	13000	3.66
3500	1.77	13500	3.75
4000	1.90	14000	3.76
4500	2.03	14500	3.87
5000	2.17	15000	3.98
5500	2.30	15500	4.01
6000	2.39	16000	4.14
6500	2.51	16500	4.15
7000	2.59	17000	4.32
7500	2.67	17500	4.36
8000	2.76	18000	4.38
8500	2.84		



13 APPENDIX F Abbreviations and acronyms

A	ampere
AC	alternating current
AM	amplitude modulation
AVRG	average (detector)
BB	broad band
cm	centimeter
dB	decibel
dBm	decibel referred to one milliwatt
dB(μ V)	decibel referred to one microvolt
dB(μ V/m)	decibel referred to one microvolt per meter
dB(μ A)	decibel referred to one microampere
DC	direct current
EIRP	equivalent isotropically radiated power
ERP	effective radiated power
EUT	equipment under test
F	frequency
GHz	gigahertz
GND	ground
H	height
HL	Hermon laboratories
Hz	hertz
k	kilo
kHz	kilohertz
LO	local oscillator
m	meter
MHz	megahertz
min	minute
mm	millimeter
ms	millisecond
μ s	microsecond
NA	not applicable
NB	narrow band
OATS	open area test site
Ω	Ohm
QP	quasi-peak
RE	radiated emission
RF	radio frequency
rms	root mean square
Rx	receive
s	second
T	temperature
Tx	transmit
V	volt

END OF DOCUMENT