

A RADIO TEST REPORT
FOR
AXELL WIRELESS LIMITED
ON
D-SBR 3709S
DOCUMENT NO. TRA-014856-47-01-A

HULL

Unit E, South Orbital Trading Park, Hedon Road, Hull, HU9 1NJ, UK.
T +44 (0)1482 801801 **F** +44 (0)1482 801806 **E** test@tracglobal.com
www.tracglobal.com

TRaC Wireless Test Report : TRA-014856-47-01-A

Applicant : Axell Wireless Limited

Apparatus : D-SBR 3709S

Specification(s) : CFR47 Part 90

Purpose of Test : Certification

FCCID : **NEODSBR3709S**

Authorised by :

: Radio Product Manager

Issue Date : 9th April 2015

Authorised Copy Number : *PDF*

Contents

Section 1:	Introduction	4
1.1	General	4
1.2	Tests Requested By	5
1.3	Manufacturer	5
1.4	Apparatus Assessed	5
1.5	Test Result Summary	6
1.6	Equipment Test Conditions	7
1.7	Standard References	8
1.8	Notes Relating To Assessment	9
1.9	Deviations from Test Standards	9
Section 2:	Measurement Uncertainty	10
2.1	Measurement Uncertainty Values	10
Section 3:	Modifications	12
3.1	Modifications Performed During Assessment	12
Appendix A:	Uplink Formal Emission Test Results	13
A1	RF Gain and Output Power	14
A2	Amplifier Intermodulation Emissions	15
A3	Amplifier Modulated Channel Test	18
A4	Spurious Emissions at Antenna Terminals Less than 1MHz	25
A5	Spurious Emissions at Antenna Terminals Greater than 1MHz	28
A6	Radiated Electric Field Emissions	32
A7	Passband Gain & Bandwidth	37
A8	Noise (conducted)	39
Appendix B:	Downlink Formal Emission Test Results	42
B1	RF Gain and Output Power	43
B2	Amplifier Intermodulation Emissions	44
B3	Amplifier Modulated Channel Test	47
B4	Spurious Emissions at Antenna Terminals Less than 1MHz	54
B5	Spurious Emissions at Antenna Terminals Greater than 1MHz	57
B6	Radiated Electric Field Emissions	61
B7	Passband Gain & Bandwidth	66
B8	Noise (Conducted)	68
Appendix C:	Additional Test and Sample Details	71
Appendix D:	Additional Information	77
Appendix E:	Photographs and Figures	78

Section 1:**Introduction****1.1 General**

This report contains an assessment of an apparatus against Electromagnetic Compatibility Standards based upon tests carried out on samples submitted to the Laboratory.

Test performed by: TRaC Global []
Unit E
South Orbital Trading Park
Hedon Road
Hull, HU9 1NJ.
United Kingdom.

Telephone: +44 (0) 1482 801801
Fax: +44 (0) 1482 801806

TRaC Global [X]
Unit 1
Pendle Place
Skelmersdale
West Lancashire, WN8 9PN
United Kingdom

Telephone: +44 (0) 1695 556666
Fax: +44 (0) 1695 577077

Email: test@tracglobal.com
Web site: <http://www.tracglobal.com>

Tests performed by: S Hodgkinson

Report author: S Hodgkinson

This report must not be reproduced except in full without prior written permission from TRaC Global.

1.2 Tests Requested By

This testing in this report was requested by :

Axell Wireless Limited
 Aerial House
 Asheridge Road
 Chesham
 Buckinghamshire
 HP5 1TU

1.3 Manufacturer

Axell Wireless Limited
 Aerial House
 Asheridge Road
 Chesham
 Buckinghamshire
 HP5 1TU

1.4 Apparatus Assessed

The following apparatus was assessed between and 3rd March and 10th March 2015

D-SBR 3709S

SMR 900MHz Digital Channel Selective and Band selective repeater.

The D-SBR 3709S digital single band repeater is specifically designed for outdoor and inbuilding for SMR 900MHz applications.

Technical specifications		
Uplink	Downlink	CFR 47 Rule Part 90S
896.00-901.00MHz	935.00MHz – 940.00MHz	

1.5 Test Result Summary

Full details of test results are contained within Appendix A. The following table summarises the results of the assessment.

The statements relating to compliance with the standards below apply ONLY as qualified in the notes and deviations stated in sections 1.6 to 1.7 of this test report.

Full details of test results are contained within Appendix A. The following table summarises the results of the assessment.

Test Type	CFR 47 Part 90 Subpart S	Appendix in Report
RF Power Output	90.219(e)(1)	A1 & B1
Intermodulation Spurious Emissions	90.219(d)(i)	A2 & B2
Occupied Bandwidth & Modulation	90.219(e)(4)	A3 & B3
Spurious Emissions at Antenna Terminals Less than 1 MHz	90.219(e)(1)	A4 & B4
Spurious Emissions at Antenna Terminals Greater than 1MHz	90.219(e)(1)	A5 & B5
Field Strength of Spurious Emissions	90.219(e)(1)	A6 & B6
Passband Gain & 20dB bandwidth	90.219(d)(7)	A7 & B7
Frequency Stability	90.213	N/A(note 1)
Transient behaviour	N/A	N/A(note 2)
Audio Frequency Response (a)	N/A	N/A
Modulation Limiting	N/A	N/A
Signal Booster Labelling Requirements	90.219(e)(5)	N/A

Notes:

1 The EUT does not contain modulation circuitry; therefore the test was not performed.

2 The EUT is not a keyed carrier system; therefore the test was not performed.

Abbreviations used in the above table:

CFR : Code of Federal Regulations
 REFE : Radiated Electric Field Emissions
 A Uplink Results Appendix

ANSI : American National Standards Institution
 PLCE : Power Line Conducted Emissions
 B Downlink Results Appendix

1.6 Equipment Test Conditions

Product class:	Uplink	Class A <input type="checkbox"/> Class B <input checked="" type="checkbox"/>
	Downlink	Class A <input type="checkbox"/> Class B <input checked="" type="checkbox"/>
Product Use:	Specialized Mobile Radio	
Emission Designator(s):	F1E F3E G1E GXW G7W G7D W7W	
Supply Voltages:	Vnom	+230Vac/110Vac
Note: Vnom voltages are as stated above unless otherwise shown on the test report page		
Equipment Category:	Single channel	<input type="checkbox"/>
	Two channel	<input type="checkbox"/>
	Multi-channel	<input checked="" type="checkbox"/>
Channel spacing:	Wideband	Uplink
	Wideband	Downlink
Test Location	TRaC Global	
	Skelmersdale	<input checked="" type="checkbox"/>
	Hull	<input type="checkbox"/>
	Other	<input type="checkbox"/> Please Specify

1.7 Standard References

47 CFR 2	Code of Federal Regulations, Title 47, Part 2, "Frequency allocations and Radio Telemetry Matters; General Rules and Regulations"
47 CFR 90	Code of Federal Regulations, Title 47, Part 90, "Land Mobile Radio Service"
ANSI/TIA-603-C.	Land Mobile FM or PM Communications Equipment
KDB 935210 D01	Booster Definitions v02
KDB 935210 D02	Certification Requirements v02
KDB 935210 D03	Signal Booster Measurements v02

1.8 Notes Relating To Assessment

With regard to this assessment, the following points should be noted:

The results contained in this report relate only to the items tested and were obtained in the period between the date of initial receipt of samples and the date of issue of the report.

The apparatus was set up and exercised using the configurations, modes of operation and arrangements defined in this report only.

Particular operating modes, apparatus monitoring methods and performance criteria required by the standards tested to have been performed except where identified in Section 1.7 of this test report (Deviations from Test Standards).

For emissions testing, throughout this test report, "Pass" indicates that the results for the sample as tested were below the specified limit (refer also to Section 2, Measurement Uncertainty).

Where relevant, the apparatus was only assessed using the monitoring methods and susceptibility criteria defined in this report.

All testing with the exception of testing at the Open Area Test Site was performed under the following environmental conditions:

Temperature	: 17 to 23 °C
Humidity	: 45 to 75 %
Barometric Pressure	: 86 to 106 kPa

All dates used in this report are in the format dd/mm/yy.

This assessment has been performed in accordance with the requirements of ISO/IEC 17025.

1.9 Deviations from Test Standards

There were no deviations from the standards tested to.

Section 2:**Measurement Uncertainty****2.1 Measurement Uncertainty Values**

For the test data recorded the following measurement uncertainty was calculated:

Radio Testing – General Uncertainty Schedule

All statements of uncertainty are expanded standard uncertainty using a coverage factor of 1.96 to give a 95% confidence where no required test level exists.

[1] Adjacent Channel Power

Uncertainty in test result = **1.86dB**

[2] Carrier Power

Uncertainty in test result (Power Meter) = **1.08dB**

Uncertainty in test result (Spectrum Analyser) = **2.48dB**

[3] Effective Radiated Power

Uncertainty in test result = **4.71dB**

[4] Spurious Emissions

Uncertainty in test result = **4.75dB**

[5] Maximum frequency error

Uncertainty in test result (Frequency Counter) = **0.113ppm**

Uncertainty in test result (Spectrum Analyser) = **0.265ppm**

[6] Radiated Emissions, field strength OATS 14kHz-18GHz Electric Field

Uncertainty in test result (14kHz – 30MHz) = **4.8dB**,

Uncertainty in test result (30MHz – 1GHz) = **4.6dB**,

Uncertainty in test result (1GHz – 18GHz) = **4.7dB**

[7] Frequency deviation

Uncertainty in test result = **3.2%**

[8] Magnetic Field Emissions

Uncertainty in test result = **2.3dB**

[9] Conducted Spurious

Uncertainty in test result – Up to 8.1GHz = **3.31dB**

Uncertainty in test result – 8.1GHz – 15.3GHz = **4.43dB**

Uncertainty in test result – 15.3GHz – 21GHz = **5.34dB**

Uncertainty in test result – Up to 26GHz = **3.14dB**

[10] Channel Bandwidth

Uncertainty in test result = **15.5%**

[11] Amplitude and Time Measurement – Oscilloscope

Uncertainty in overall test level = **2.1dB**,
Uncertainty in time measurement = **0.59%**,
Uncertainty in Amplitude measurement = **0.82%**

[12] Power Line Conduction

Uncertainty in test result = **3.4dB**

[13] Spectrum Mask Measurements

Uncertainty in test result = **2.59% (frequency)**
Uncertainty in test result = **1.32dB (amplitude)**

[14] Adjacent Sub Band Selectivity

Uncertainty in test result = **1.24dB**

[15] Receiver Blocking – Listen Mode, Radiated

Uncertainty in test result = **3.42dB**

[16] Receiver Blocking – Talk Mode, Radiated

Uncertainty in test result = **3.36dB**

[17] Receiver Blocking – Talk Mode, Conducted

Uncertainty in test result = **1.24dB**

[18] Receiver Threshold

Uncertainty in test result = **3.23dB**

[19] Transmission Time Measurement

Uncertainty in test result = **7.98%**

Section 3:

Modifications

3.1 Modifications Performed During Assessment

No modifications were performed during the assessment

Appendix A:**Uplink Formal Emission Test Results**

Abbreviations used in the tables in this appendix:

Spec	: Specification	ALSR	: Absorber Lined Screened Room
Mod	: Modification	OATS	: Open Area Test Site
EUT	: Equipment Under Test	ATS	: Alternative Test Site
SE	: Support Equipment	Ref	: Reference
L	: Live Power Line	Freq	: Frequency
N	: Neutral Power Line	MD	: Measurement Distance
E	: Earth Power Line	SD	: Spec Distance
Pk	: Peak Detector	Pol	: Polarisation
QP	: Quasi-Peak Detector	H	: Horizontal Polarisation
Av	: Average Detector	V	: Vertical Polarisation
CDN	: Coupling & decoupling network		

A1 RF Gain and Output Power

Test Details:	
Measurement standard	Part 2.1046, 90.219(e)(1)
EUT sample number	S01
Modification state	0
SE in test environment	None
SE isolated from EUT	None
Temperature	25°C
Humidity	20%
EUT set up	Refer to Appendix C

Frequency (MHz)	Signal Generator input level (dBm)	Input Cable Loss (dB)	Input Level (dBm)	Level at Spectrum Analyser (dBm)	Output Cable & Attenuator loss (dB)	Gain (dB)	Conducted Output Power (dBm)	Gain after 10dB input level increase (dB)
896.100	-65.39	0.60	-65.99	-15.78	39.9	90.11	24.12	80.11
898.500	-66.59	0.60	-67.19	-15.82	39.9	91.27	24.08	81.54
900.900	-65.40	0.60	-66.00	-15.82	39.9	90.08	24.08	80.32

Notes: 1. The signal generator input was increased by 10dBs and the level of the output signal remeasured.

A2 Amplifier Intermodulation Emissions

Test Details:	
Measurement standard	Part 2.1053, 90.219(d)(i)
EUT sample number	S01
Modification state	0
SE in test environment	None
SE isolated from EUT	None
EUT set up	Refer to Appendix C

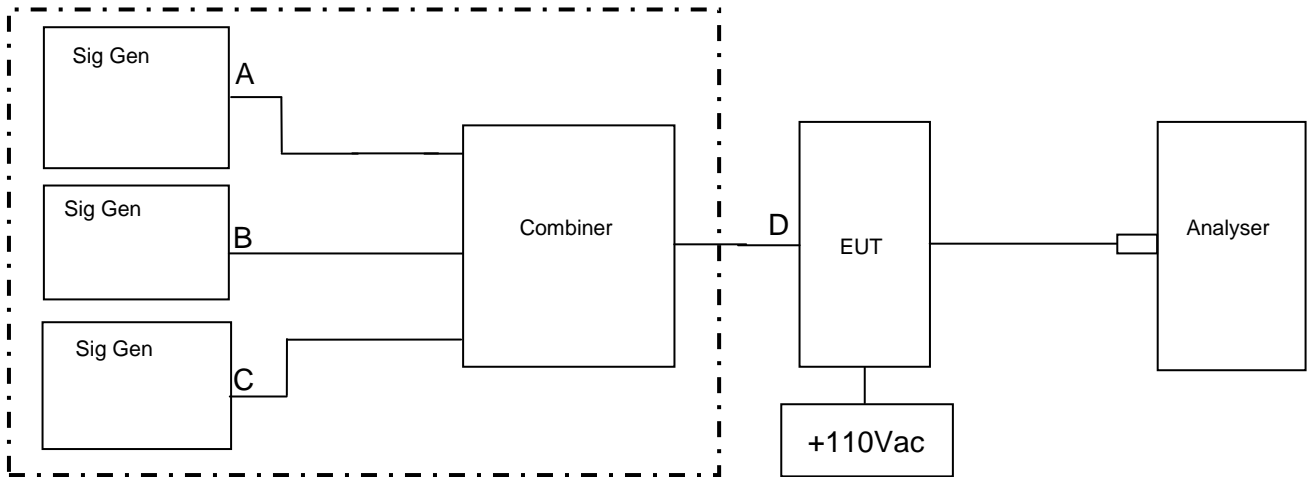

3 Signals	Frequency (MHz)	Level (dBm)	Limit (dBm)
No Emissions Within 20 dB of the limit			-13

Sweep data is shown on the next page:

Results

The EUT was found to comply with the limits

See plots below

Intermodulation Close View

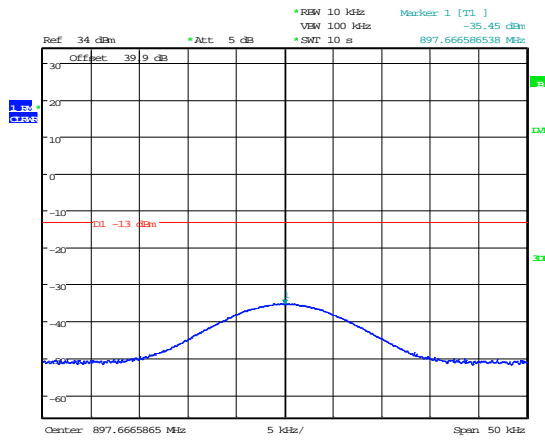

Date: 12.MAR.2015 16:39:45

Intermodulation Wide View

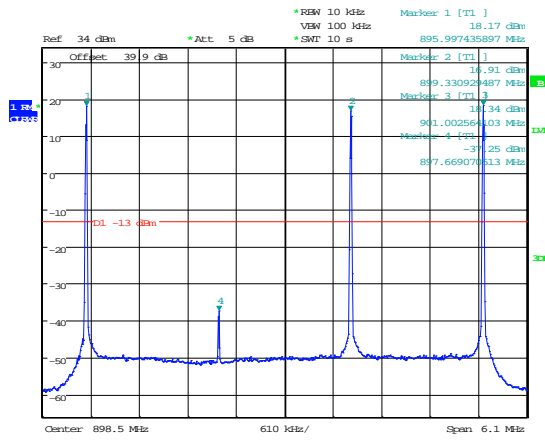

Date: 12.MAR.2015 16:38:27

Intermodulation Wide View

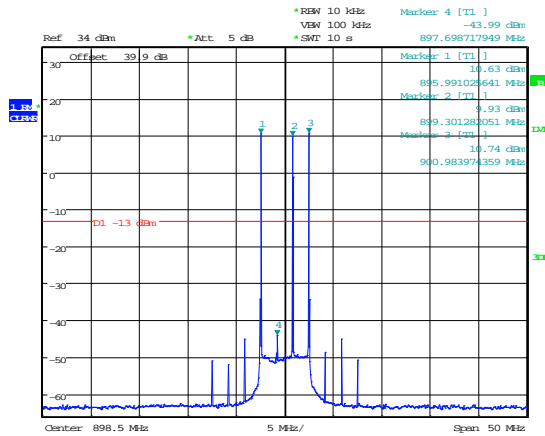

Date: 12.MAR.2015 16:41:12

9-150kHz

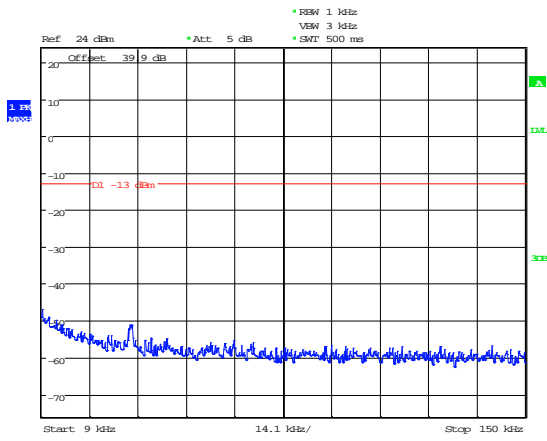

Date: 4.MAR.2015 11:43:49

150kHz – 30MHz

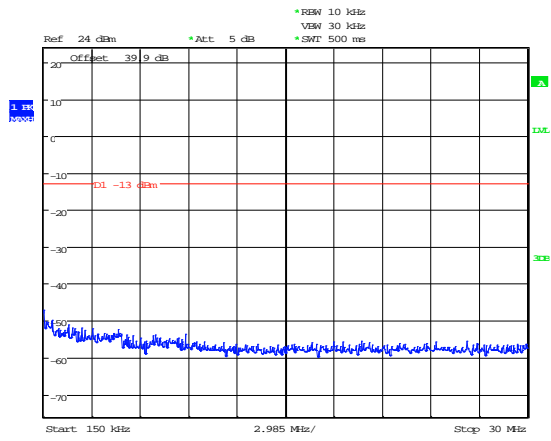

Date: 4.MAR.2015 11:44:35

30MHz – 1GHz

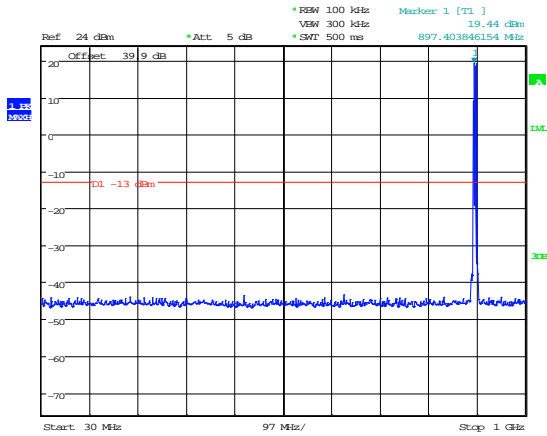

Date: 4.MAR.2015 11:45:09

1-5GHz

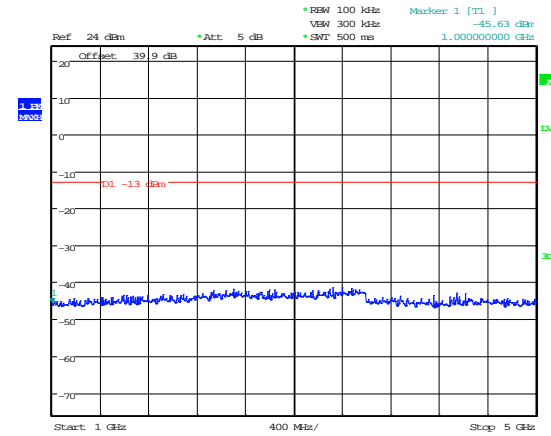

Date: 4.MAR.2015 11:45:28

5-10GHz

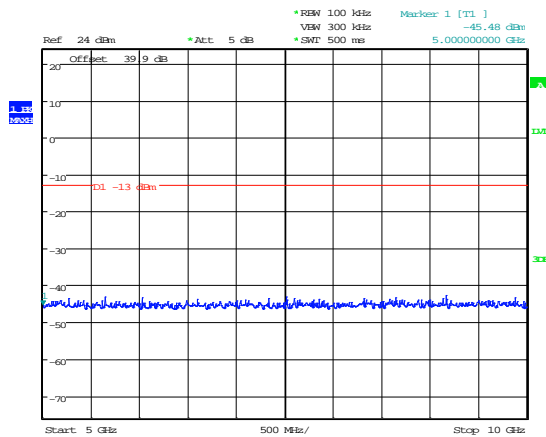

Date: 4.MAR.2015 11:45:49

A3 Amplifier Modulated Channel Test

Test Details:	
Measurement standard	D.3 Policies + Procedures (j) of KDB 935210 D02 Signal Boosters Certification v02 ,90.219(e)(4)
EUT sample number	S01
Modification state	0
SE in test environment	None
SE isolated from EUT	None
EUT set up	Refer to Appendix C

Frequency Of Operation Channel	Modulation Type					
	FM	C4FM	H-DQPSK	H-CPM	P1/4 - DQPSK	Iden
896.100	10.096kHz	8.333kHz	9.871kHz	8.141kHz	21.025kHz	29.006kHz
898.500	10.096kHz	8.525kHz	9.871kHz	8.076kHz	21.089kHz	29.006kHz
900.900	10.096kHz	8.717kHz	9.807kHz	8.076kHz	20.961kHz	28.846kHz

Waveforms applied to selected bands as requested.

FM low channel

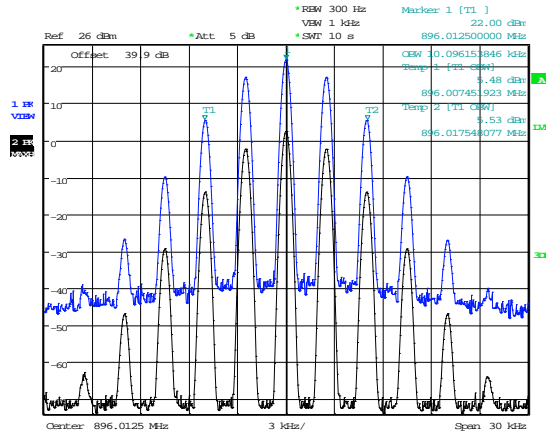

Date: 4.MAR.2015 14:55:35

FM mid channel

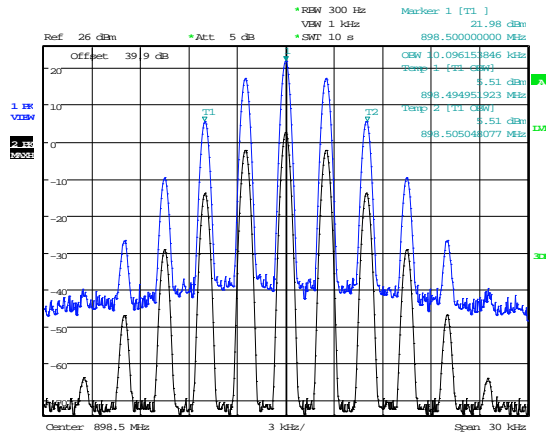

Date: 4.MAR.2015 14:59:21

FM High channel

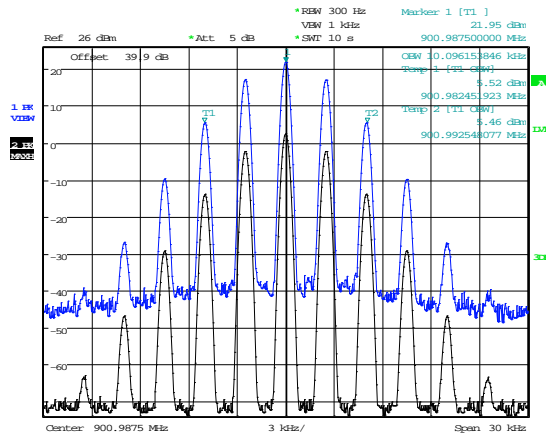

Date: 4.MAR.2015 15:03:13

C4FM low channel

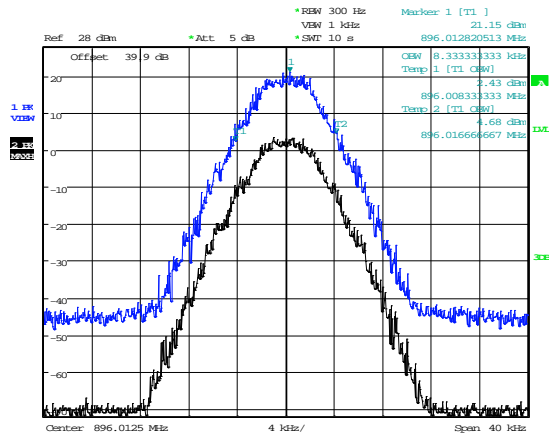

Date: 5.MAR.2015 15:45:04

C4FM mid channel

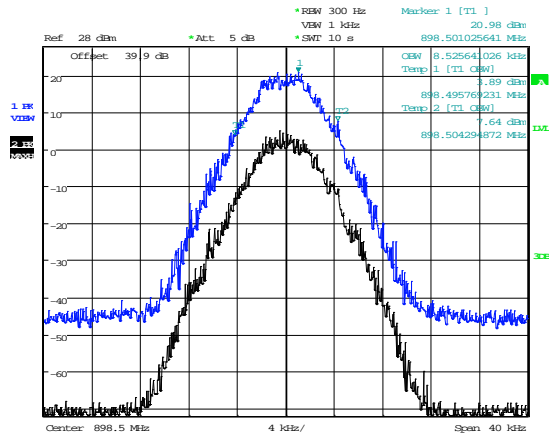

Date: 5.MAR.2015 15:42:12

C4FM high channel

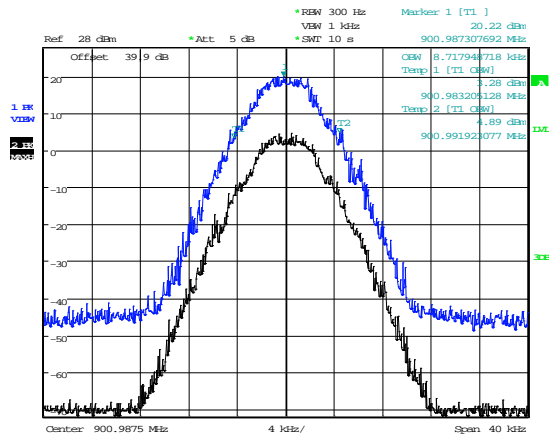

Date: 5.MAR.2015 15:39:50

H-DQPSK low channel

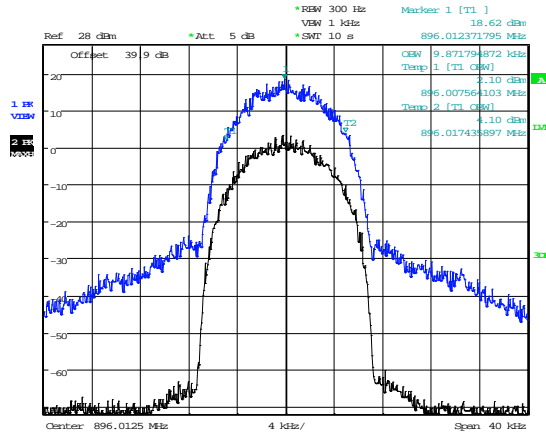

Date: 5.MAR.2015 16:10:29

H-DQPSK mid channel

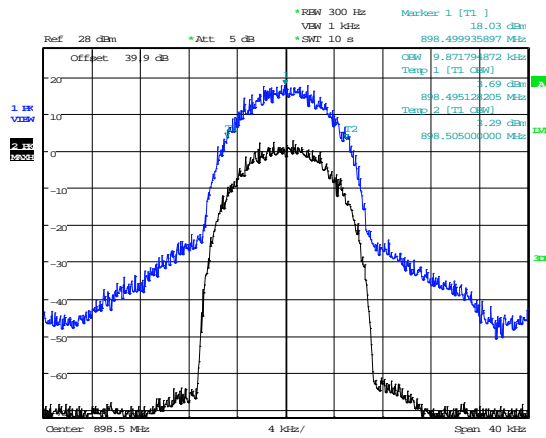

Date: 5.MAR.2015 16:08:11

H-DQPSK high channel

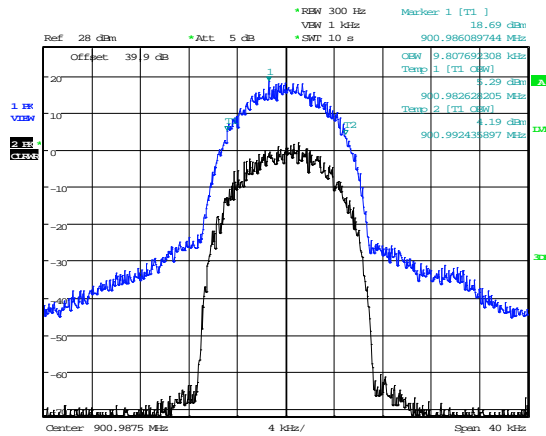

Date: 5.MAR.2015 15:59:50

H-CPM low channel

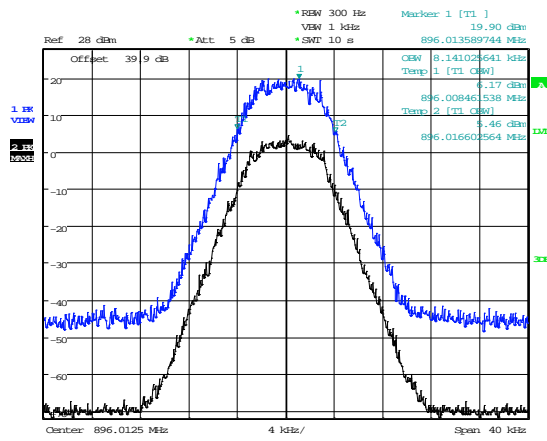

Date: 5.MAR.2015 15:48:58

H-CPM mid channel

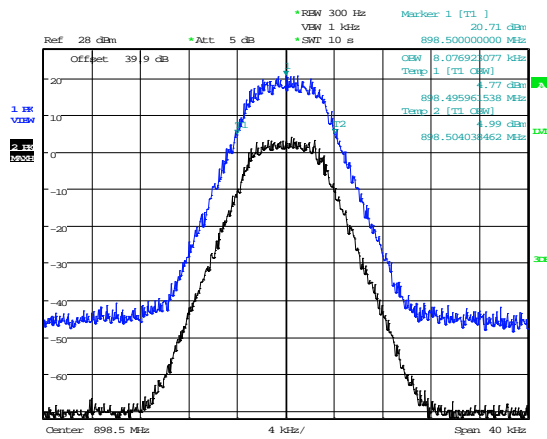

Date: 5.MAR.2015 15:52:51

H-CPM top channel

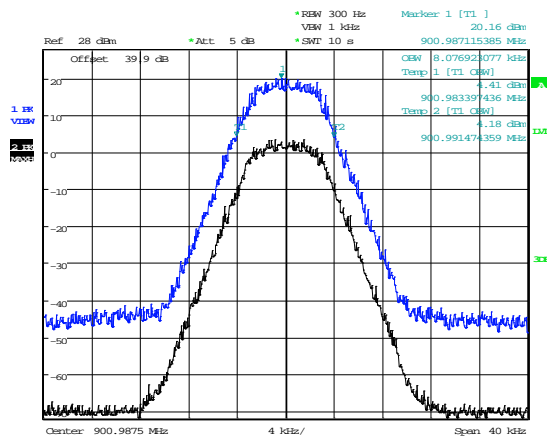

Date: 5.MAR.2015 15:56:04

P1/4 -DQPSK low channel

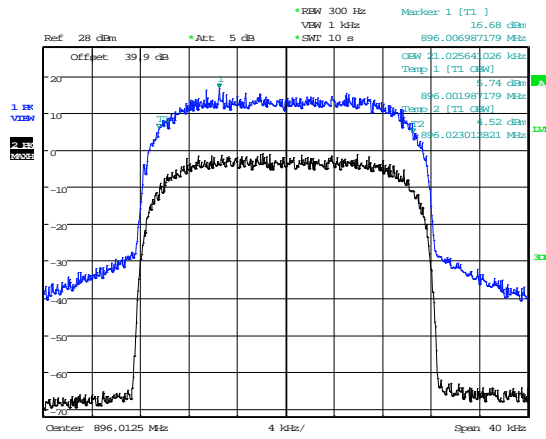

Date: 5.MAR.2015 15:28:36

P1/4 -DQPSK mid channel

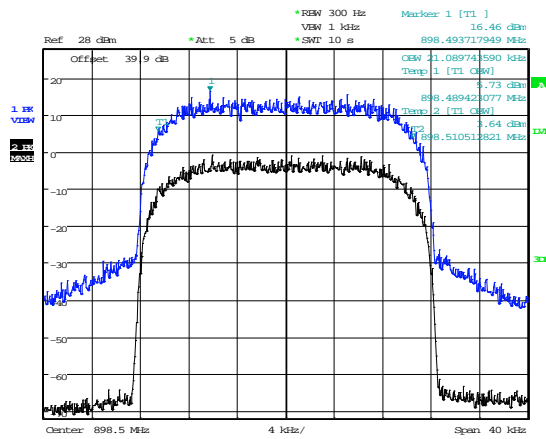

Date: 5.MAR.2015 15:31:33

P1/4 -DQPSK high channel

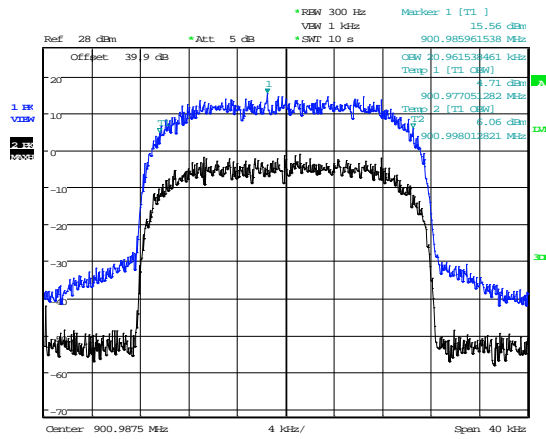

Date: 5.MAR.2015 15:35:24

Iden low channel

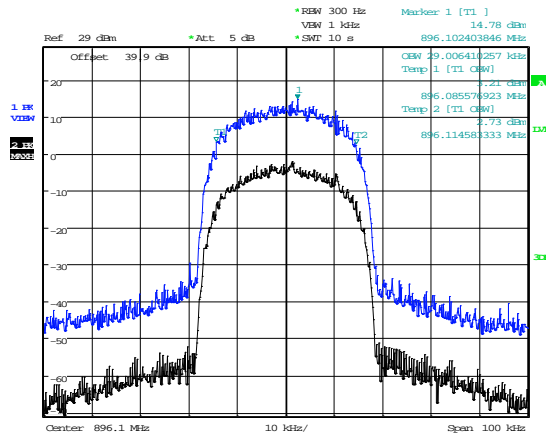

Date: 10.MAR.2015 12:14:12

Iden mid channel

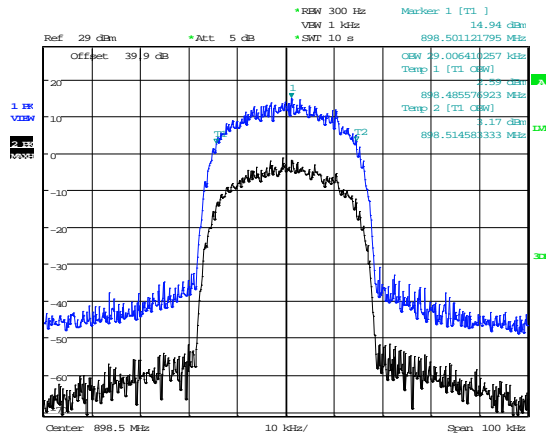

Date: 10.MAR.2015 12:28:32

Iden high channel

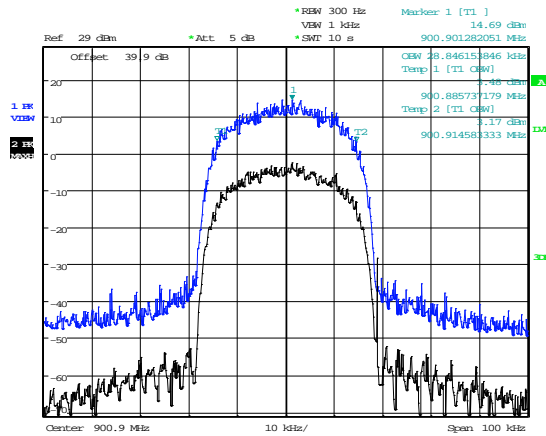

Date: 10.MAR.2015 12:33:24

The above plots depicting the output wavscape show no measurable distortion visible when compared to the input signal.

A4 Spurious Emissions at Antenna Terminals Less than 1MHz

Test Details:	
Measurement standard	Part 2.1053, 90.219(e)(1)
EUT sample number	S01
Modification state	0
SE in test environment	None
SE isolated from EUT	None
EUT set up	Refer to Appendix C

Modulation Type	Bandedge	Carrier Frequency (MHz)	Max Level @ bandedge (dBm)
FM	Lower	896.004550	-14.35
	Upper	900.99360	-17.99
C4FM	Lower	896.004600	-13.69
	Upper	900.994170	-14.72
H-CPM	Lower	896.004600	-13.98
	Upper	900.994190	-14.74
H -DQPSK	Lower	896.005000	-14.31
	Upper	900.993620	-14.75
P1/4 DQPSK	Lower	896.010700	-14.77
	Upper	900.988050	-14.17
Iden	Lower	896.016636	-14.31
	Upper	900.982117	-16.41

LBE FM

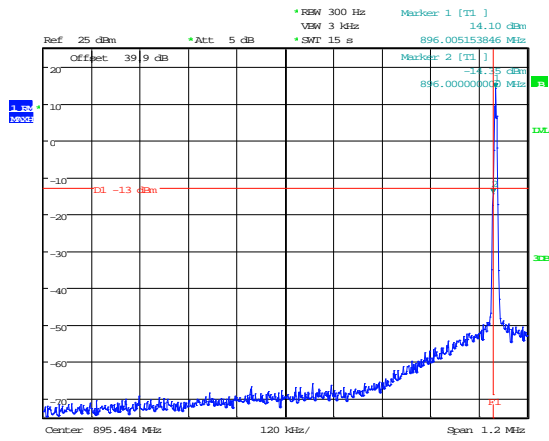

Date: 13.MAR.2015 10:24:34

UBE FM

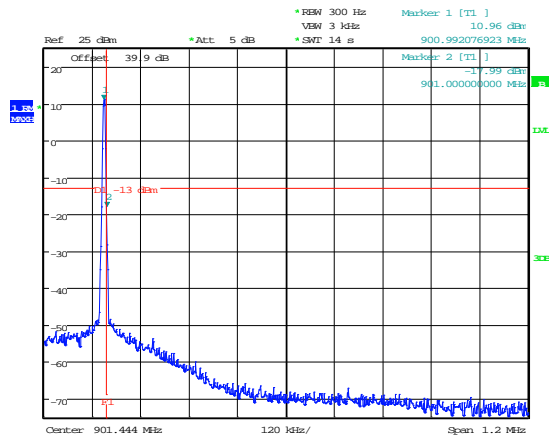

Date: 13.MAR.2015 10:09:00

LBE C4FM

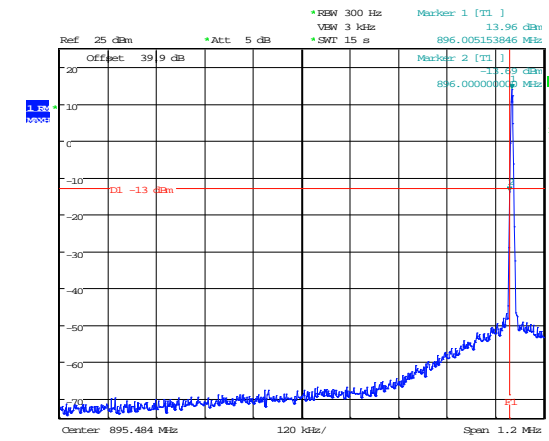

Date: 13.MAR.2015 10:30:29

UBE C4FM

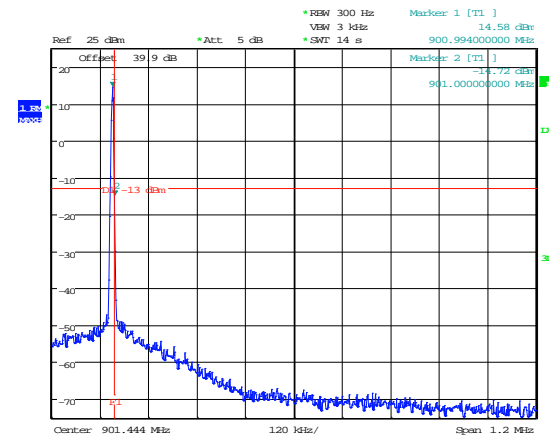

Date: 13.MAR.2015 09:39:46

LBE H-CPM

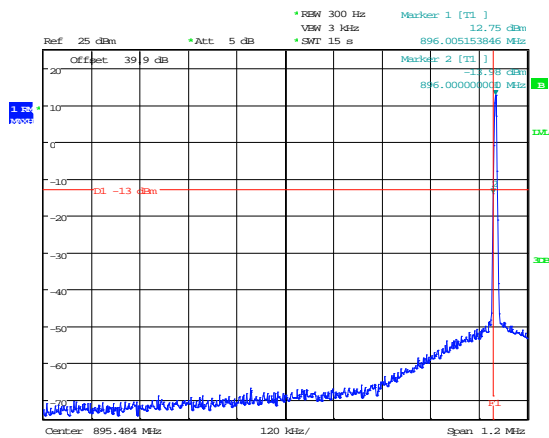

Date: 13.MAR.2015 10:32:12

UBE H-CPM

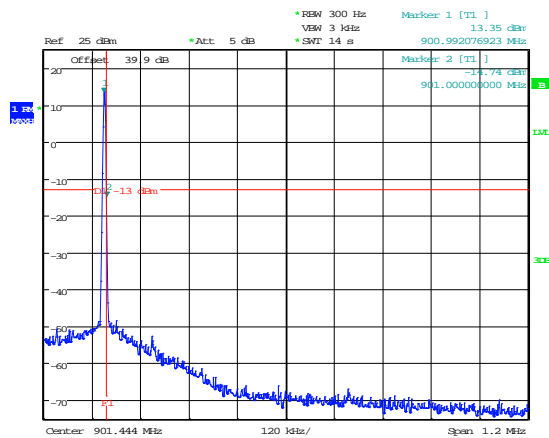

Date: 13.MAR.2015 09:42:59

LBE H-DQPSK

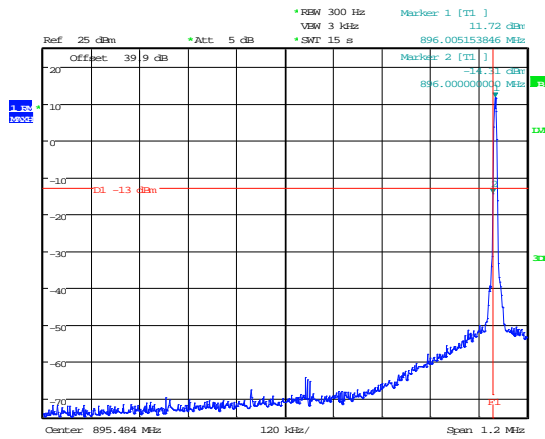

UBE H-DQPSK

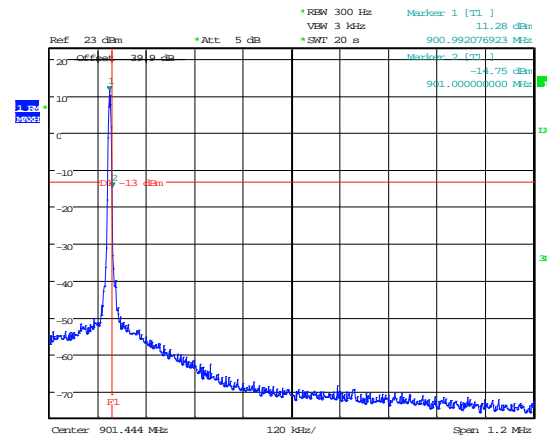

Date: 13.MAR.2015 10:34:50

LBE P1/4 DQPSK

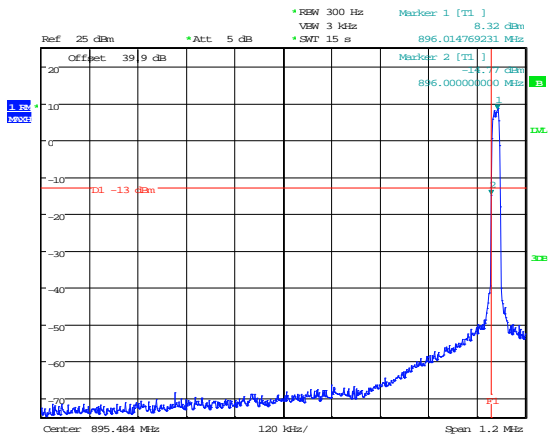

Date: 12.MAR.2015 17:48:03

LBE P1/4 DQPSK

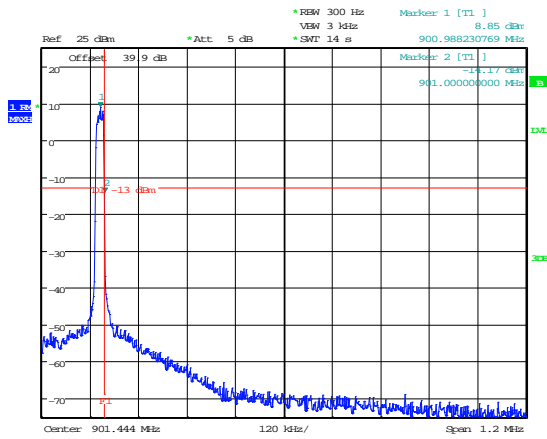

Date: 13.MAR.2015 10:39:43

LBE Iden

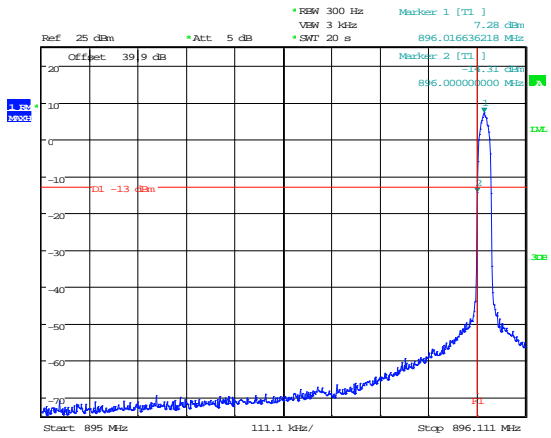

Date: 13.MAR.2015 10:01:32

UBE Iden

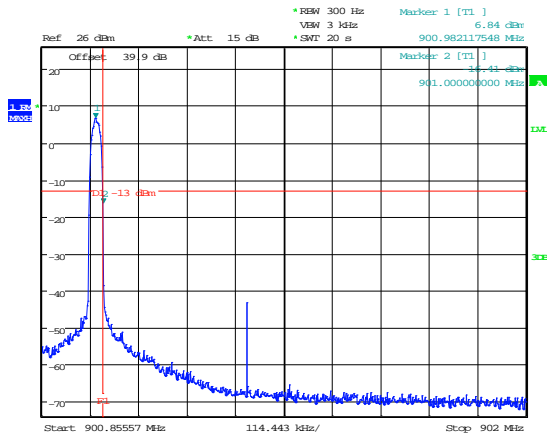

Date: 10.MAR.2015 12:57:31

Date: 10.MAR.2015 13:09:51

A5 Spurious Emissions at Antenna Terminals Greater than 1MHz

Test Details:	
Measurement standard	Part 2.1053, 90.219(e)(1)
EUT sample number	S01
Modification state	0
SE in test environment	None
SE isolated from EUT	None
EUT set up	Refer to Appendix C

Frequency (MHz)	Frequency Range (MHz)	Freq. of Emission (MHz)	Measured Level (dBm)	Attenuator & Cable Losses (dB)	Spurious Emission Level (dBm)	Limit (dBm)
896.100	No Significant Emissions Within 20 dB of limit					-13
898.500						-13
900.900						-13

Limit is determined by the outermost step of the emissions mask and is calculated as follows:

At least $43 + 10 \log P$ dB

$$(10 \log P_{\text{watts}}) - (43 + 10 \log (P_{\text{watts}} * 1000)) = \text{LIMIT} = -13 \text{ dBm}$$

Result

The EUT was found to comply with the limits

896.1MHz

9kHz - 150kHz

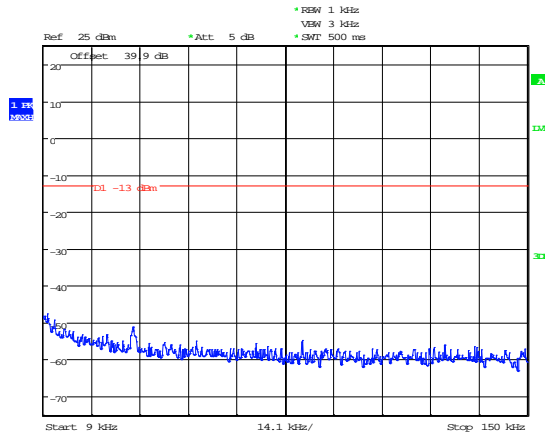

Date: 4.MAR.2015 08:49:36

150kHz - 30MHz

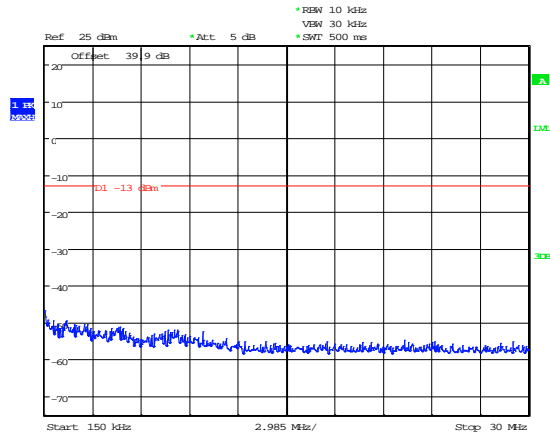

Date: 4.MAR.2015 08:50:30

30MHz - 1GHz

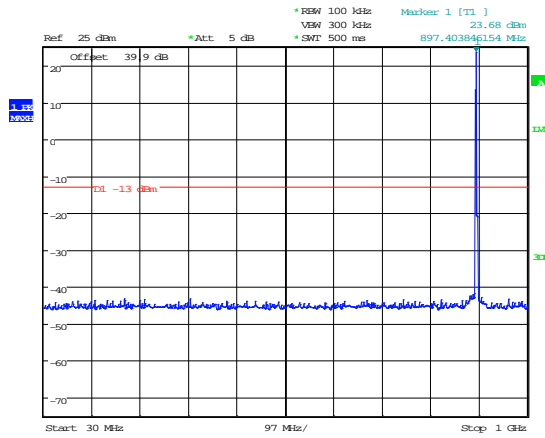

Date: 4.MAR.2015 08:51:18

1GHz - 5GHz

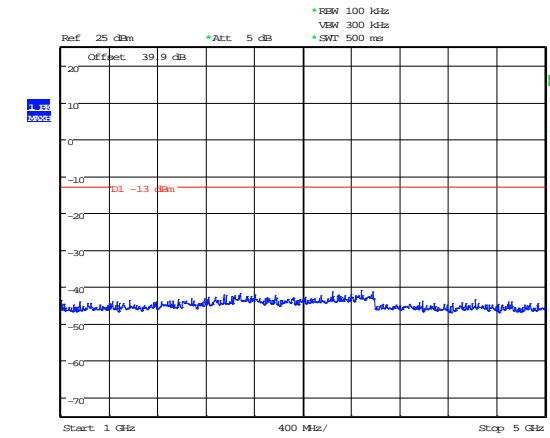

Date: 4.MAR.2015 08:52:21

5GHz - 10GHz

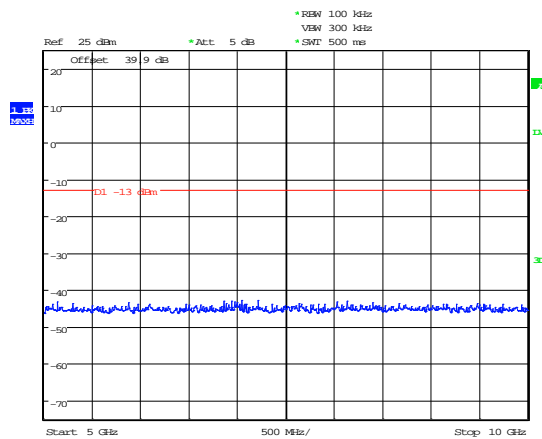

Date: 4.MAR.2015 08:52:45

898.500MHz

9kHz - 150kHz

150kHz - 30MHz

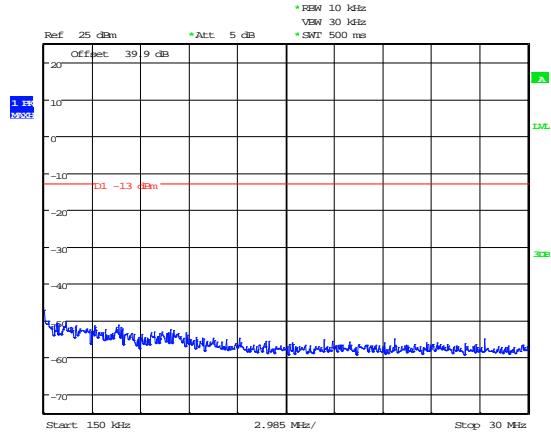
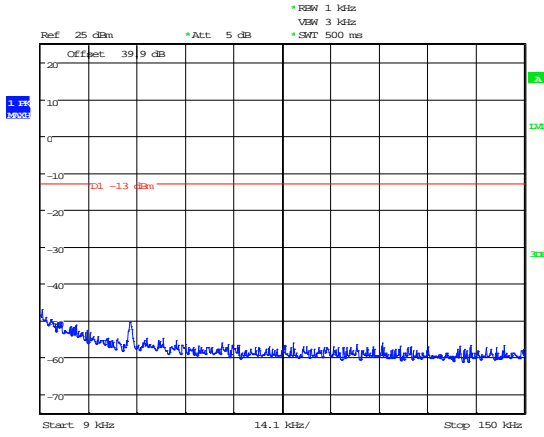

Date: 4.MAR.2015 08:58:15

Date: 4.MAR.2015 08:58:47

30MHz - 1GHz

1GHz - 5GHz

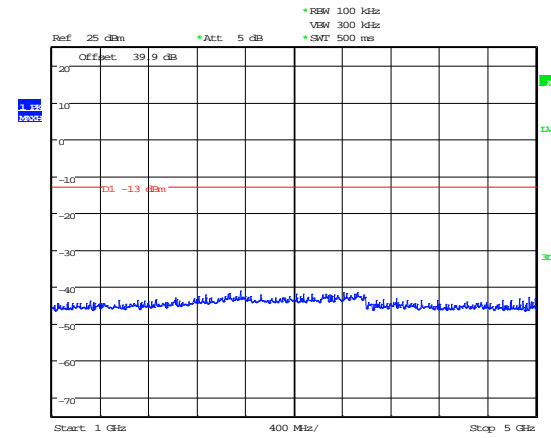
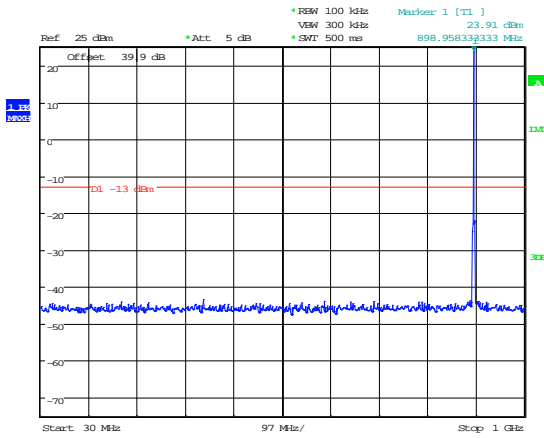

Date: 4.MAR.2015 08:57:38

Date: 4.MAR.2015 08:59:24

5GHz - 10GHz

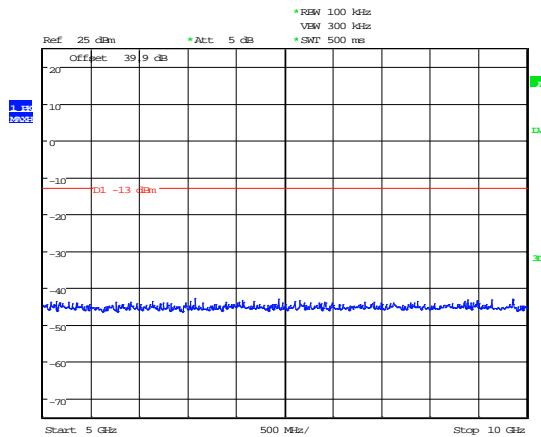

Date: 4.MAR.2015 08:59:52

9kHz - 150kHz

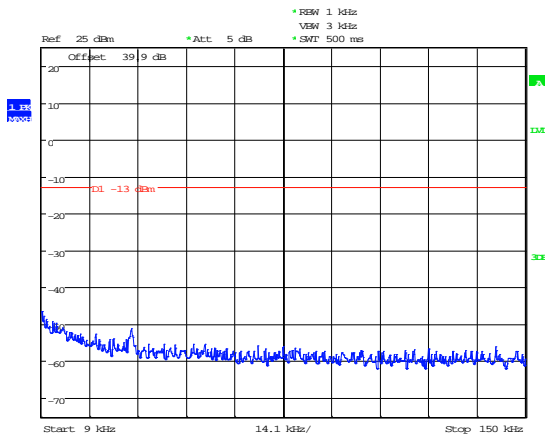

Date: 4.MAR.2015 09:03:55

900.900MHz

150kHz - 30MHz

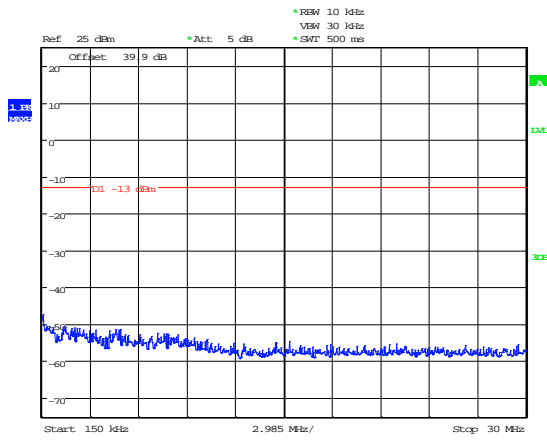

Date: 4.MAR.2015 09:04:23

30MHz - 1GHz

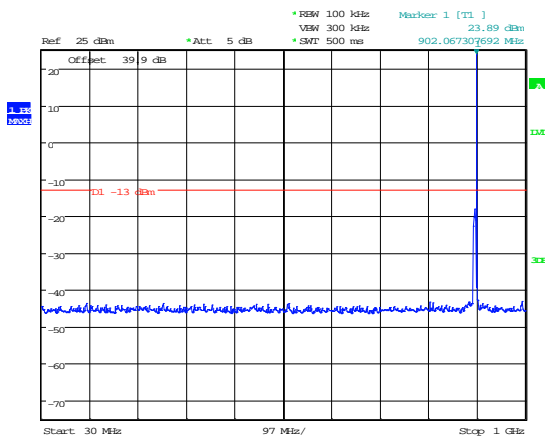

Date: 4.MAR.2015 09:03:20

1GHz - 5GHz

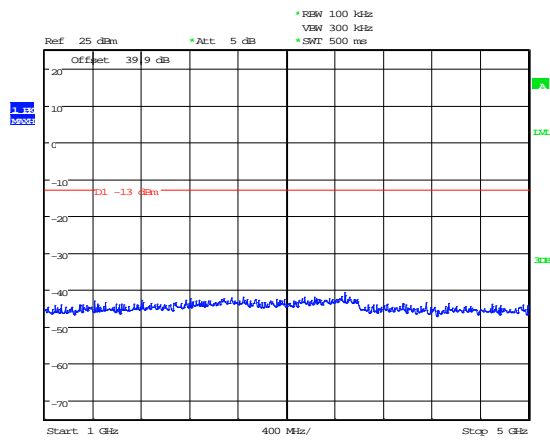

Date: 4.MAR.2015 09:05:02

5GHz - 10GHz

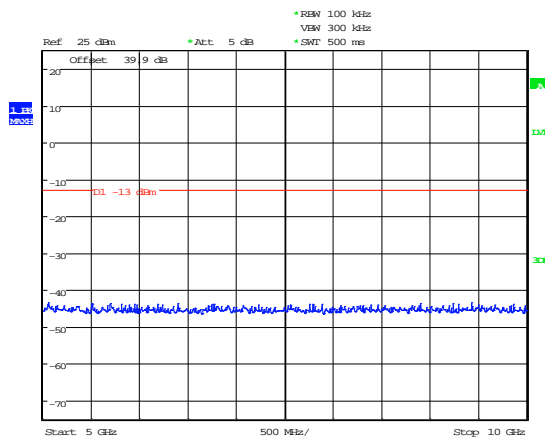

Date: 4.MAR.2015 09:05:28

A6 Radiated Electric Field Emissions

Preliminary scans were performed using a peak detector with the RBW = 100kHz. The radiated electric field emission test applies to all spurious and harmonic emissions. The EUT was set to transmit as required.

The following test site was used for final measurements as specified by the standard tested to:

3m open area test site :

3m alternative test site :

The effect of the EUT set-up on the measurements is summarised in note (c) below.

Test Details:	
Measurement standard	Part 2.1053, 90.219(e)(1)
Frequency range	30 MHz – 10 GHz
EUT sample number	S01
Modification state	0
SE in test environment	None
SE isolated from EUT	None
EUT set up	Refer to Appendix C
Photographs	Appendix F

Frequency (MHz)	Freq. of Emission (MHz)	ERP/EIRP (dBm)	Limit (dBm)
896.100	No Significant Emissions Within 20 dB of limit		-13
898.500			-13
900.900			-13

Result

The EUT was found to comply with the limits

Notes:

1. Emissions Checked up to 10 times Fc.
2. The unit was mounted on a turntable and rotated through 360° and in 3 orthogonal planes to find the worst case emission.
3. For Frequencies below 1 GHz, RBW = 120 kHz, testing was performed with CISPR16 compliant test receiver with QP detector. Above 1 GHz tests were performed using a spectrum analyser using the following settings:

Peak Detector RBW = 1MHz; VBW = ≥RBW

4. Limit is determined as the outermost step of the emissions mask and is calculated as follows.

At least 43 + 10 log P dB

$$(10\log P_{\text{watts}}) - (43 + 10\log (P_{\text{watts}} * 1000)) = \text{LIMIT} = -13 \text{ dBm}$$

The upper and lower frequency of the measurement range was decided according to 47 CFR Part 2.1057.

- (a) Where results have been measured at one distance, and a signal level displayed at another, the results have been extrapolated using the following formula:

$$\text{Extrapolation (dB)} = 20 \log_{10} \left(\frac{\text{measurement distance}}{\text{specification distance}} \right)$$

- (b) The levels may have been rounded for display purposes.
- (c) The following table summarises the effect of the EUT operating mode, internal configuration and arrangement of cables / samples on the measured emission levels :

	See (i)	See (ii)	See (iii)	See (iv)
Effect of EUT operating mode on emission levels	✓			
Effect of EUT internal configuration on emission levels	✓			
Effect of Position of EUT cables & samples on emission levels			✓	
(i) Parameter defined by standard and / or single possible, refer to Appendix D (ii) Parameter defined by client and / or single possible, refer to Appendix D (iii) Parameter had a negligible effect on emission levels, refer to Appendix D (iv) Worst case determined by initial measurement, refer to Appendix D				

896.100MHz

30MHz – 1GHz

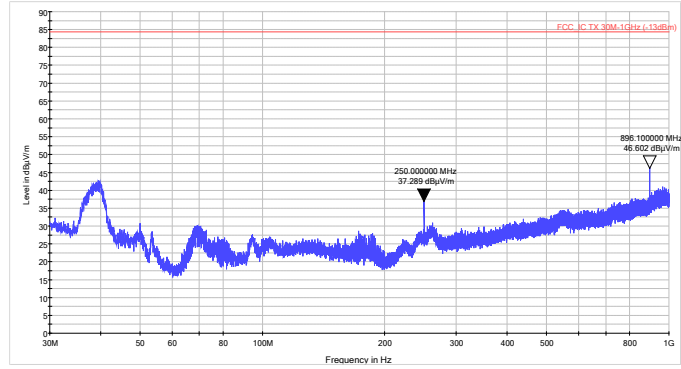

1GHz – 5GHz

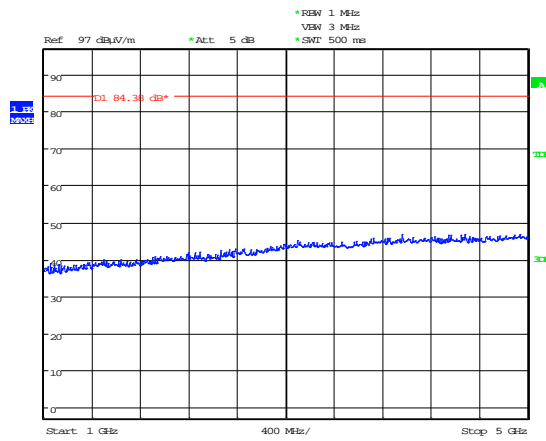

Date: 9.MAR.2015 11:41:07

5GHz – 10GHz

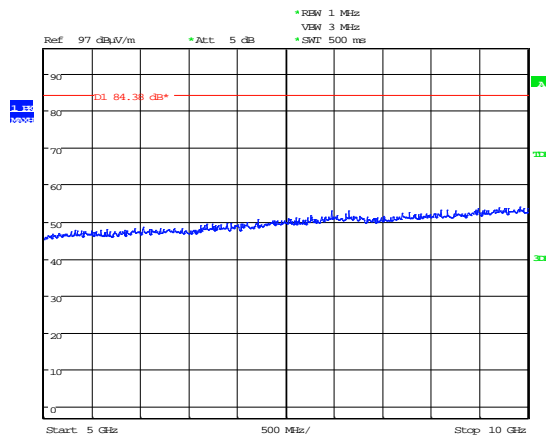

Date: 9.MAR.2015 11:41:29

898.500MHz

30MHz – 1GHz

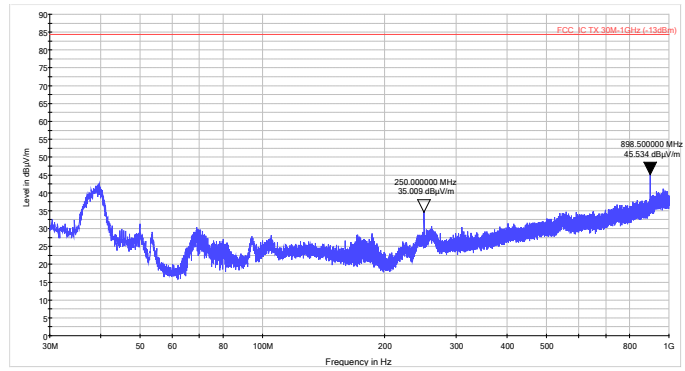

1GHz – 5GHz

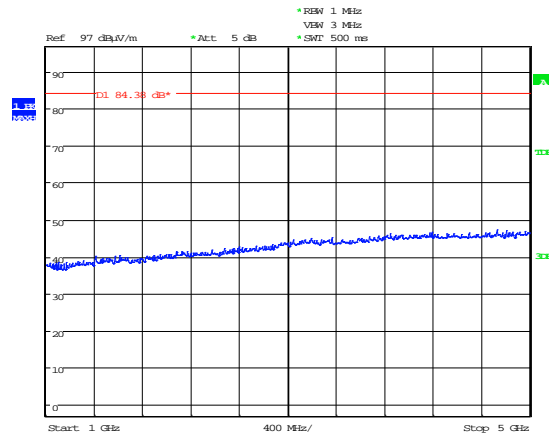

Date: 9.MAR.2015 11:43:56

5GHz – 10GHz

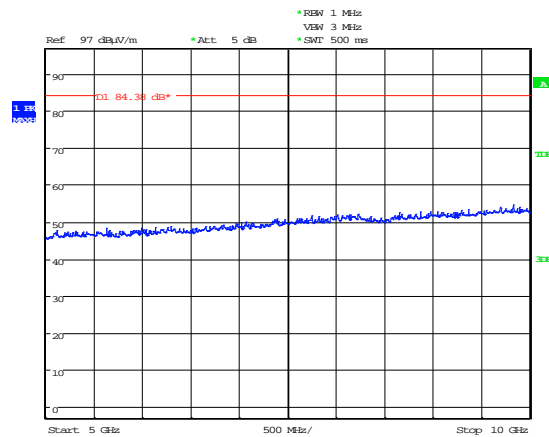

Date: 9.MAR.2015 11:44:28

900.900MHz

30MHz – 1GHz

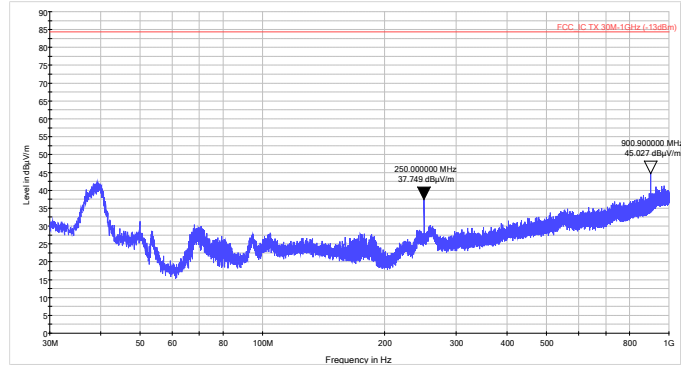

1GHz – 5GHz

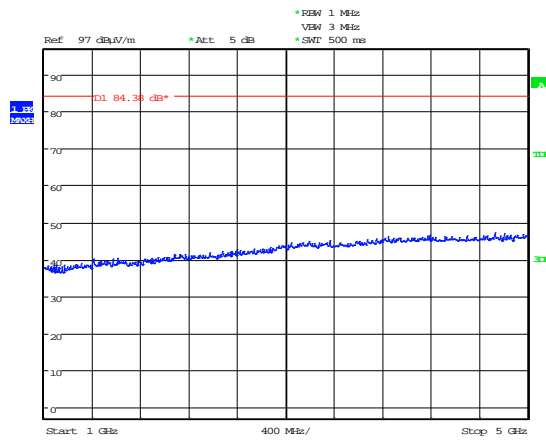

Date: 9.MAR.2015 11:43:56

5GHz – 10GHz

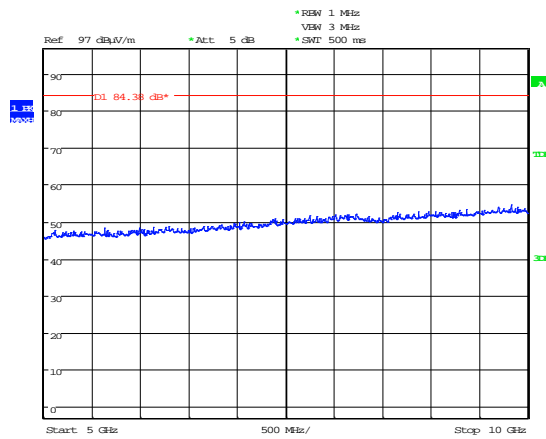

Date: 9.MAR.2015 11:44:28

A7 Passband Gain & Bandwidth

Test Details:	
Measurement standard	D.3 Policies + Procedures (k) of KDB 935210 D02 Signal Boosters Certification v02, 90.219(d)(7)
EUT sample number	S01
Modification state	0
SE in test environment	None
SE isolated from EUT	None
EUT set up	Refer to Appendix C

BAND	fl	fh	20 dB Bandwidth
896.00-901.00MHz	895.655000MHz	901.345000MHz	5.690MHz

With the aid of a CW Swept signal generator and spectrum analyser, the bandwidth and frequency response of the open channel (i.e. at the point where the gain has fallen by 20 dB) is measured. This measurement shows the gain-versus-frequency response of the open channel from the midband frequency f_0 of the channel up to at least $f_0 + 250\%$ of the 20 dB bandwidth.

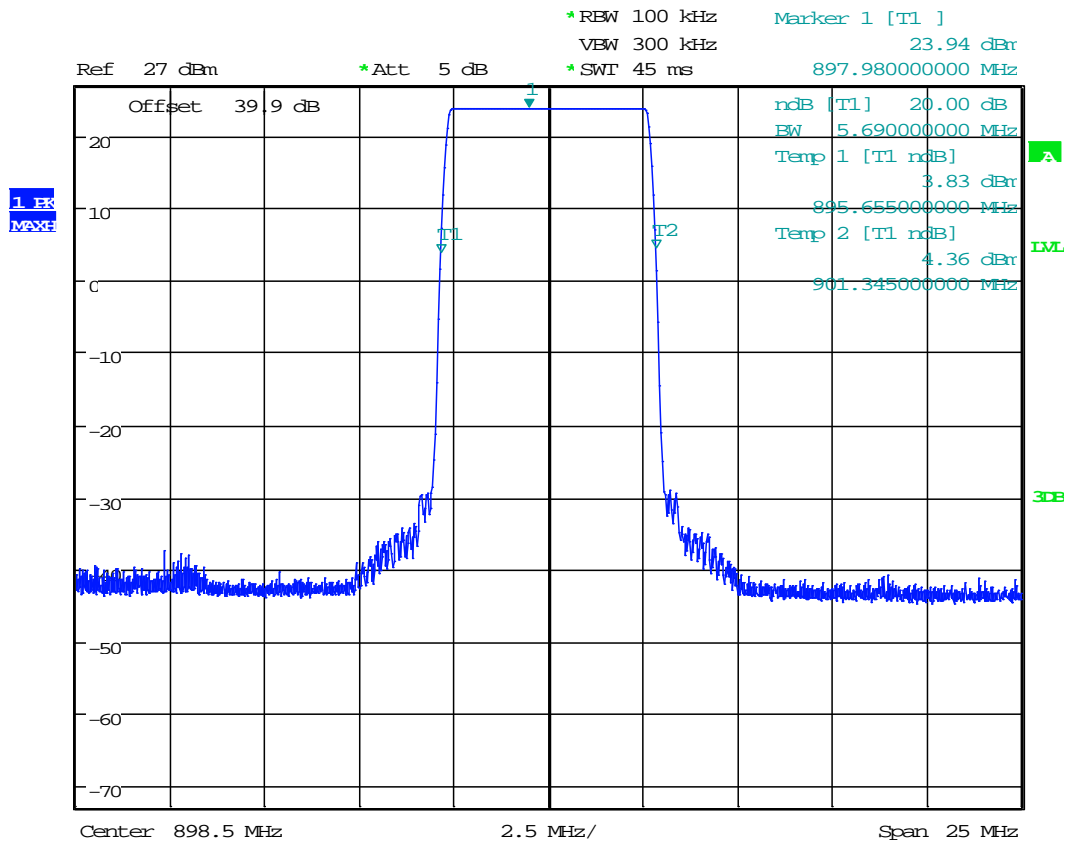

Date: 6.MAR.2015 10:37:47

A8 Noise (conducted)

Test Details:	
Measurement standard	90.219(d)(ii)(iii)90.219(e)(2)
Frequency range	30 MHz – 10 GHz
EUT sample number	S01
Modification state	0
SE in test environment	None
SE isolated from EUT	None

See Plot below

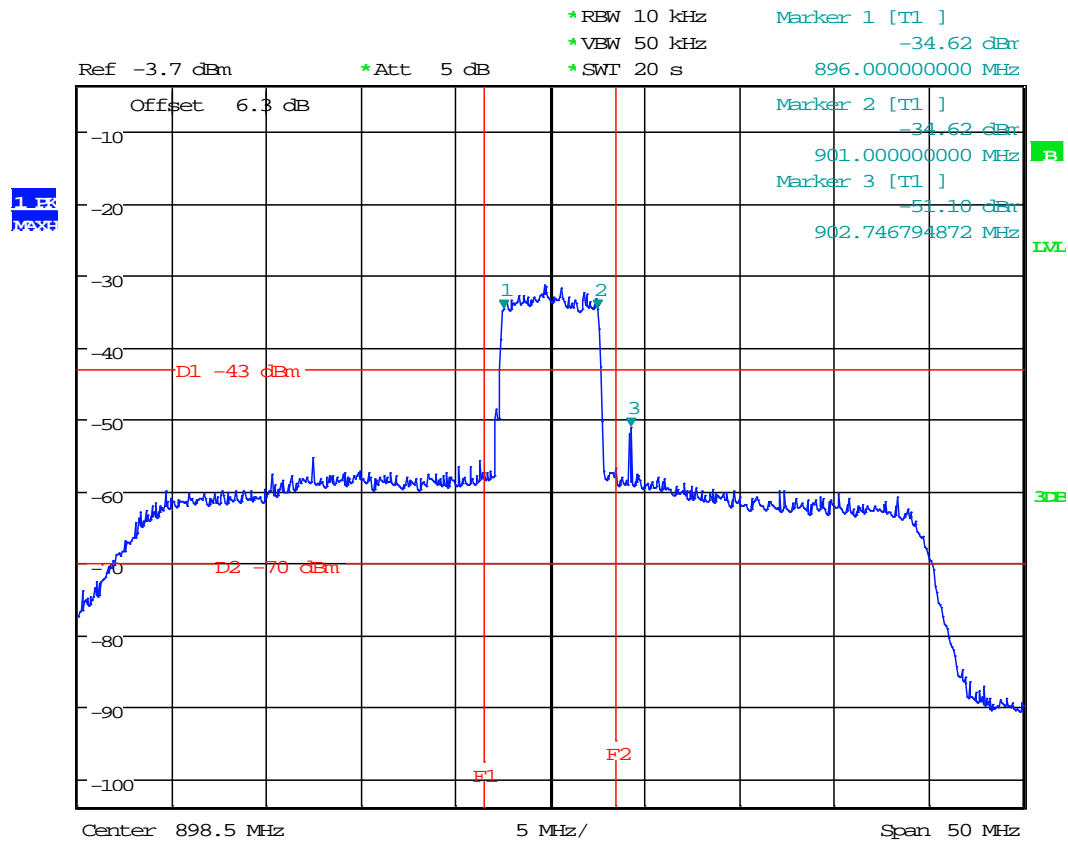

Date: 13.MAR.2015 14:29:02

- ii) In general the ERP of noise within the passband should not exceed -43dBm in a 10 kHz measurement bandwidth.
- iii) In general the ERP of noise on the spectrum more than 1MHz outside of the passband should not exceed -70dBm in a 10 kHz measurement bandwidth.

Whilst the pass band noise is greater than the -43dBm limit by approximately 11dB, the manufacturer has stated that they mitigate this by using good engineering practice as follows:-

Compliance with FCC deployment rule regarding the radiation of noise

Good engineering practice must be used in regard to the signal booster's noise radiation. Thus, the gain of the signal booster should be set so that the EIRP of the output noise from the signal booster should not exceed the level of -43 dBm in 10 kHz measurement bandwidth.

In the event that the noise level measured exceeds the aforementioned value, the signal booster gain should be decreased accordingly.

In general, the ERP of noise on a spectrum more than 1 MHz outside of the pass band should not exceed -70 dBm in a 10 kHz measurement bandwidth.

The D-SBR 3709S signal booster has a noise level of -51.10 dBm in 10 kHz measurement at 1 MHz spectrum outside the passband of the signal booster. It has an in-band noise level at around -32 dBm in a 10 kHz bandwidth Therefore the noise at the antenna input port should be calculated based on equation (3)

Equation (3) - Input Noise to service antenna

Input Noise to service antenna:

-43 dBm + Service Antenna gain – Antenna splitter losses in dB – cable loss in dBs

Example:

Signal booster connected to 10 service antennas with a 100m long ½ inch cable.

- *Losses of such a cable with the connectors = ~ 11dB.*
- *Gain = ~ 2 dBi*

Assuming 10 service antennas: antenna splitter losses = 11 dBi

Based on equation (3) Input antenna noise (to the antenna) = -51.1+2-11 -11=-71.1 dBm.

The inband input noise to the antenna should be -32+2 -11-11= -52dbm

NOTE: in this example no external bandpass filter would be required.

Conclusion:

Good engineering practice requires that in general when the out of band noise measured at the service antenna input is more than -70 dBm per 10 kHz measurement bandwidth, an external band pass filter should be added to attenuate the out of band noise level .

As per Part 90.219(e)(2) The noise figure of a signal booster must not exceed 9dB in either direction.



Max noise figure = 2.8195dB.

Appendix B:**Downlink Formal Emission Test Results**

Abbreviations used in the tables in this appendix:

Spec	: Specification	ALSR	: Absorber Lined Screened Room
Mod	: Modification	OATS	: Open Area Test Site
EUT	: Equipment Under Test	ATS	: Alternative Test Site
SE	: Support Equipment	Ref	: Reference
L	: Live Power Line	Freq	: Frequency
N	: Neutral Power Line	MD	: Measurement Distance
E	: Earth Power Line	SD	: Spec Distance
Pk	: Peak Detector	Pol	: Polarisation
QP	: Quasi-Peak Detector	H	: Horizontal Polarisation
Av	: Average Detector	V	: Vertical Polarisation
CDN	: Coupling & decoupling network		

B1 RF Gain and Output Power

Test Details:	
Measurement standard	Part 2.1046, 90.219(e)(1)
EUT sample number	S01
Modification state	0
SE in test environment	None
SE isolated from EUT	None
Temperature	25°C
Humidity	20%
EUT set up	Refer to Appendix C

Frequency (MHz)	Signal Generator input level (dBm)	Input Cable Loss (dB)	Input Level (dBm)	Level at Spectrum Analyser (dBm)	Output Cable & Attenuator loss (dB)	Gain (dB)	Conducted Output Power (dBm)	Gain after 10dB input level increase (dB)
935.100	-54.50	0.40	-54.90	-2.66	39.7	91.94	37.04	81.94
937.500	-53.73	0.40	-54.13	-2.60	39.7	91.23	37.10	81.37
939.900	-53.13	0.40	-53.53	-2.60	39.7	90.63	37.10	80.74

Notes: 1. The signal generator input was increased by 10dBs and the level of the output signal remeasured.

B2 Amplifier Intermodulation Emissions

Test Details:	
Measurement standard	Part 2.1053, 90.219(d)(i)
EUT sample number	S01
Modification state	0
SE in test environment	None
SE isolated from EUT	None
EUT set up	Refer to Appendix C

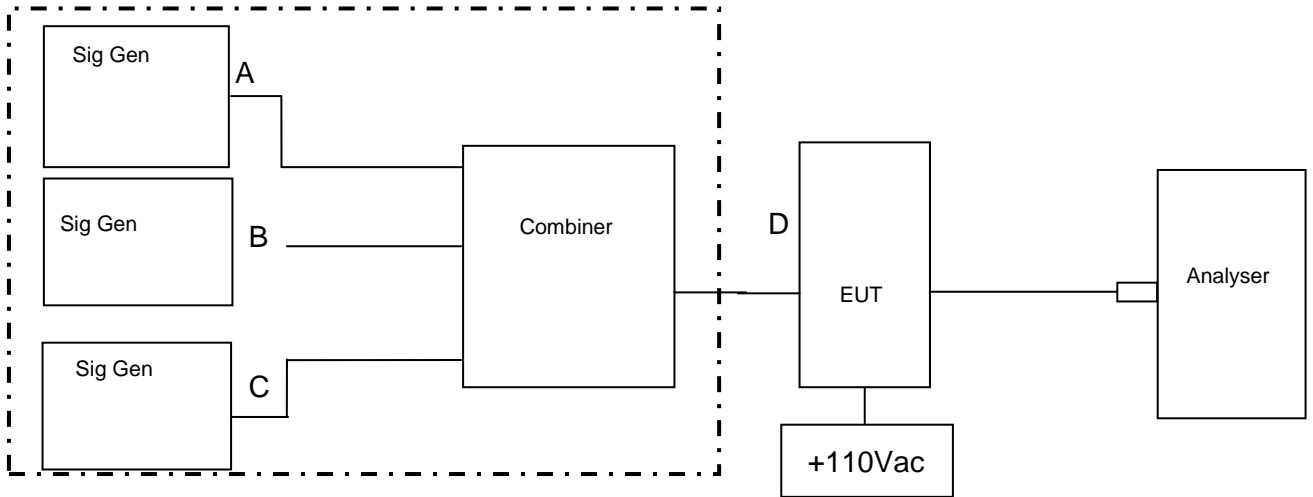

3 Signals	Frequency (MHz)	Level (dBm)	Limit (dBm)
	938.333493	-30.26dBm	-13.0

Sweep data is shown on the next page:

The middle carrier was swept between the bottom and top carriers until the worse case intermodulation product was produced.

Results

The EUT was found to comply with the limits

See plots below

Intermodulation Close View

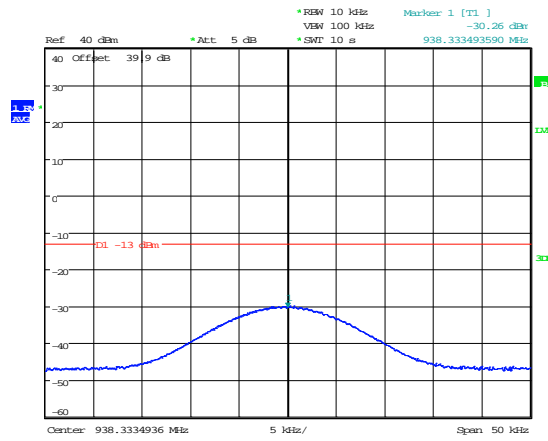

Date: 12.MAR.2015 16:54:48

Intermodulation Close View

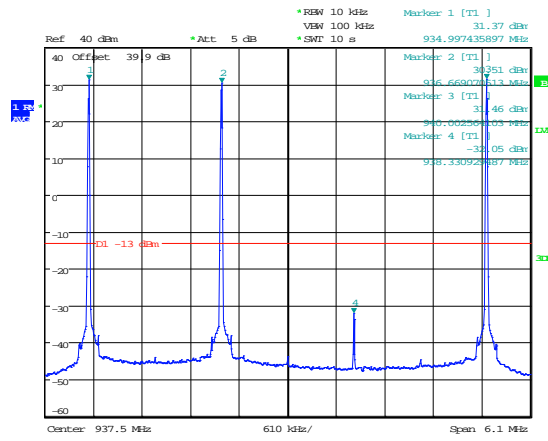

Date: 12.MAR.2015 16:52:35

Intermodulation Wide View

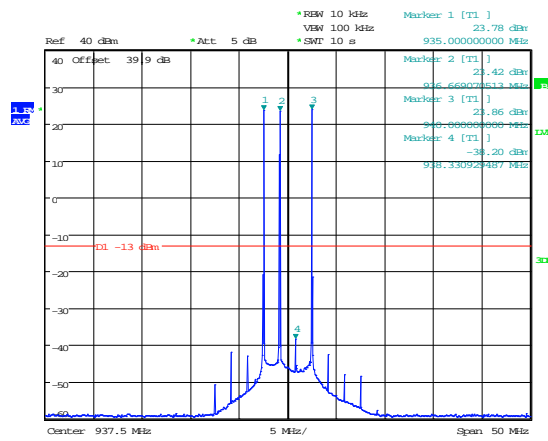

Date: 12.MAR.2015 16:53:41

9kHz-150kHz

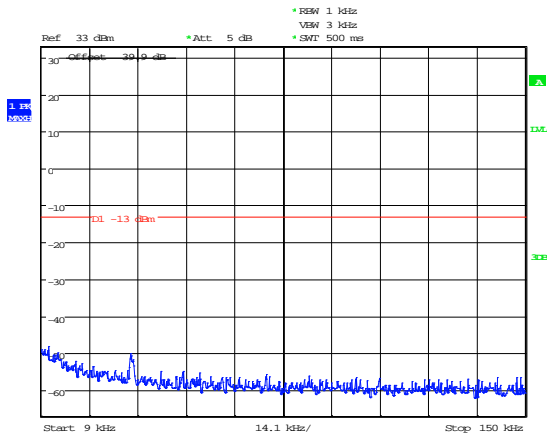

Date: 4.MAR.2015 11:16:24

150kHz – 30MHz

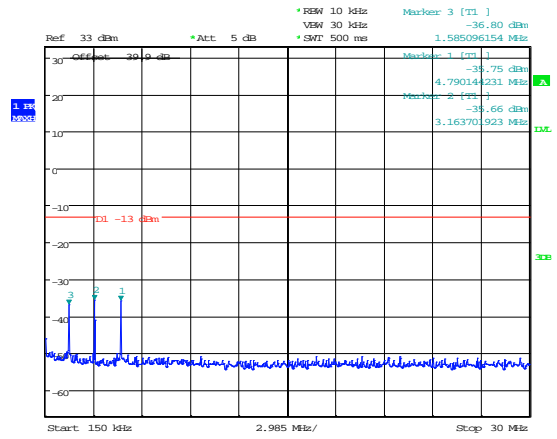

Date: 4.MAR.2015 11:17:24

30MHz – 1GHz

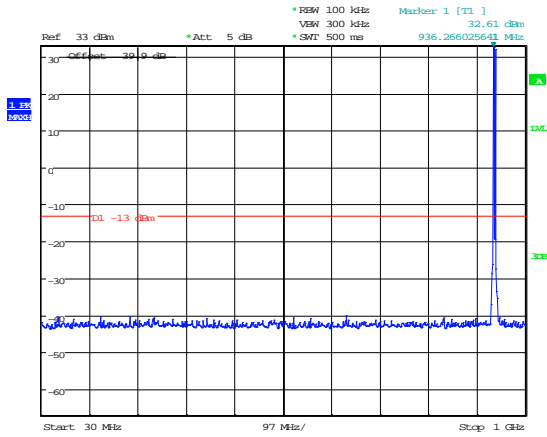

Date: 4.MAR.2015 11:15:47

1GHz – 5GHz

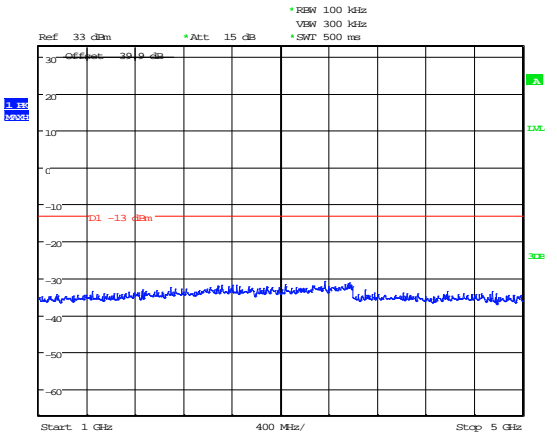

Date: 4.MAR.2015 11:18:14

5-10GHz

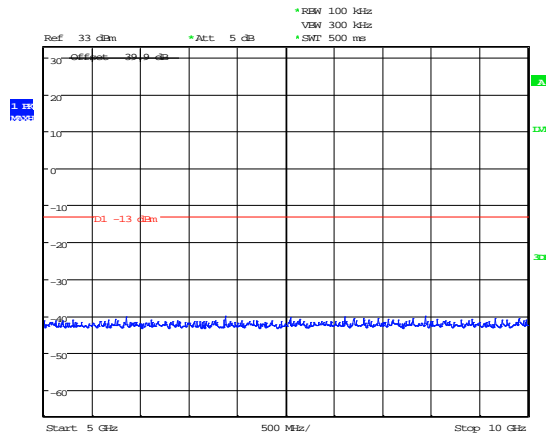

Date: 4.MAR.2015 11:18:56

B3 Amplifier Modulated Channel Test

Test Details:	
Measurement standard	D.3 Policies + Procedures (j) of KDB 935210 D02 Signal Boosters Certification v02, 90.219(e)(4)
EUT sample number	S01
Modification state	0
SE in test environment	None
SE isolated from EUT	None
EUT set up	Refer to Appendix C

Frequency Of Operation Channel	Modulation Type					
	FM	C4FM	H-DQPSK	H-CPM	P1/4 -DQPSK	Iden
935.100	10.096kHz	8.565kHz	9.679kHz	8.076kHz	21.153kHz	29.006kHz
937.500	10.096kHz	8.565kHz	9.807kHz	8.012kHz	21.025kHz	28.846kHz
939.900	10.096kHz	8.461kHz	9.807kHz	8.141kHz	21.089kHz	28.846kHz

Waveforms applied to selected bands as requested.

FM low channel

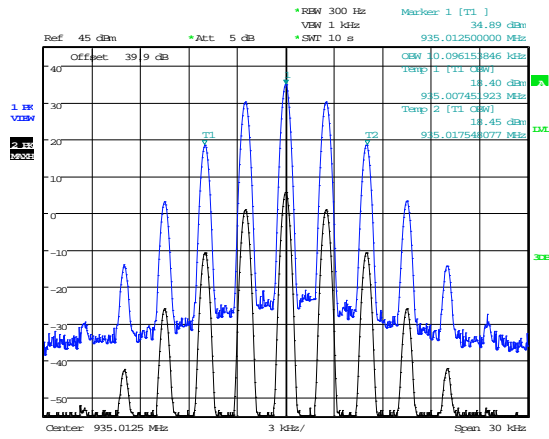

Date: 4.MAR.2015 15:12:35

FM mid channel

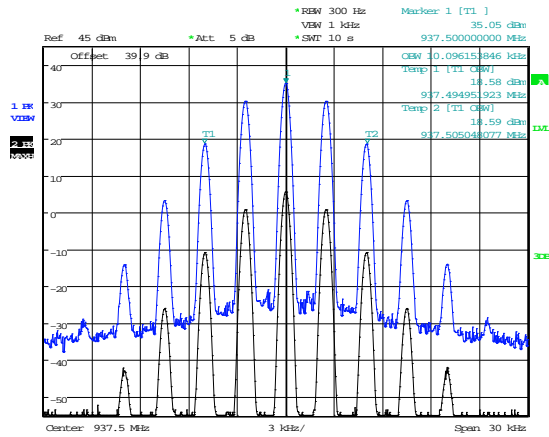

Date: 4.MAR.2015 15:17:25

FM top channel

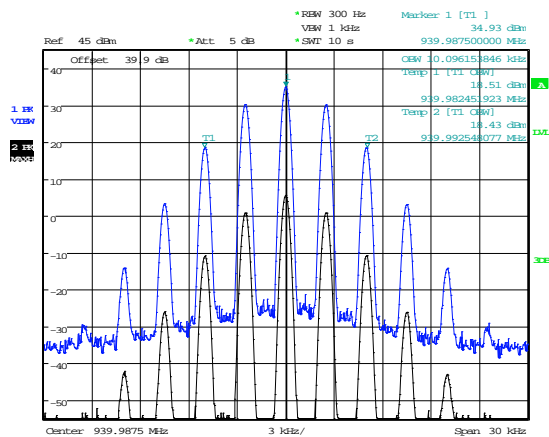

Date: 4.MAR.2015 15:30:27

C4FM low channel

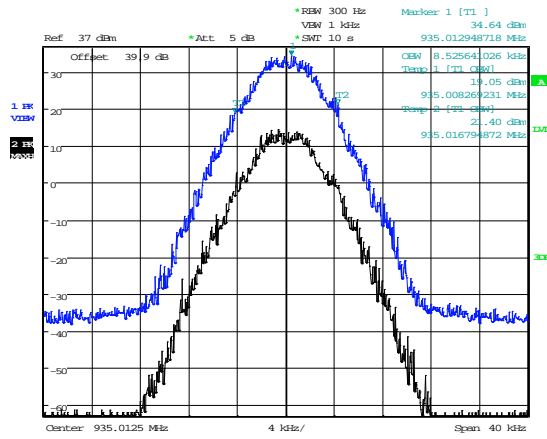

Date: 5.MAR.2015 14:47:49

C4FM mid channel

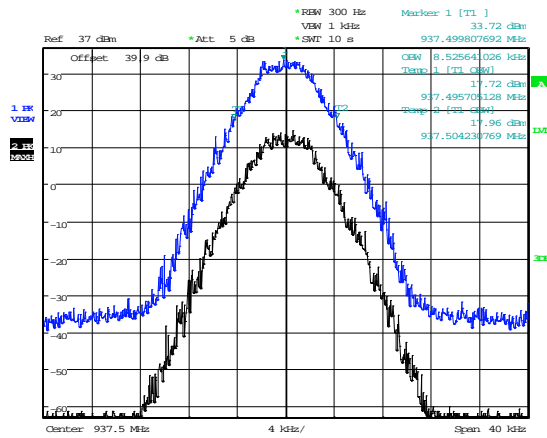

Date: 5.MAR.2015 14:44:15

C4FM high channel

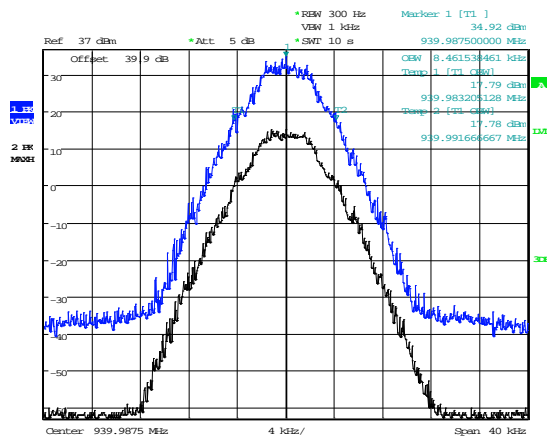

Date: 5.MAR.2015 14:40:59

H-DQPSK low channel

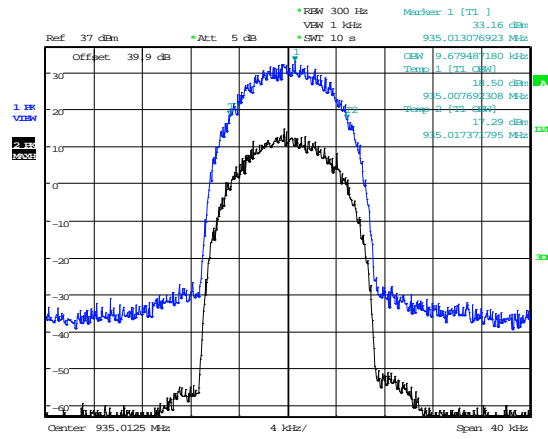

Date: 5.MAR.2015 15:07:51

H-DQPSK mid channel

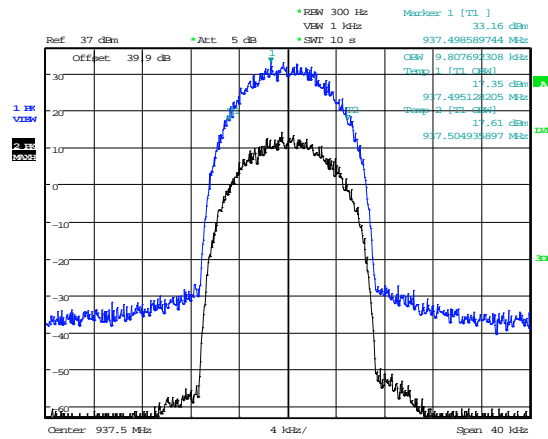

Date: 5.MAR.2015 15:05:21

H-DQPSK high channel

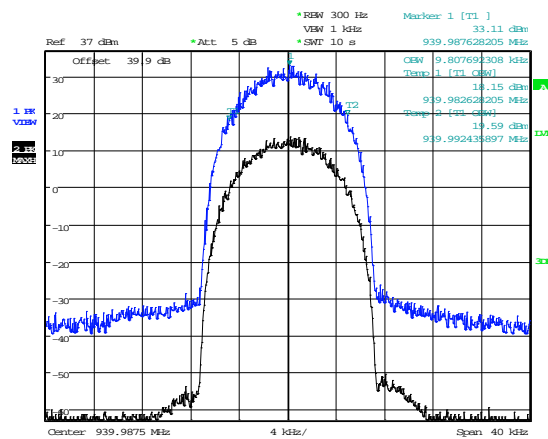

Date: 5.MAR.2015 15:02:57

H-CPM low channel

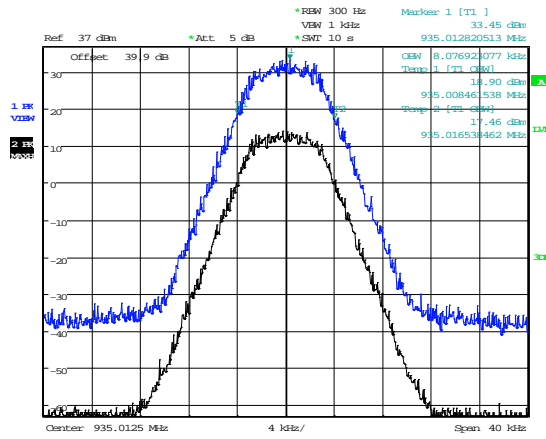

Date: 5.MAR.2015 14:52:08

H-CPM mid channel

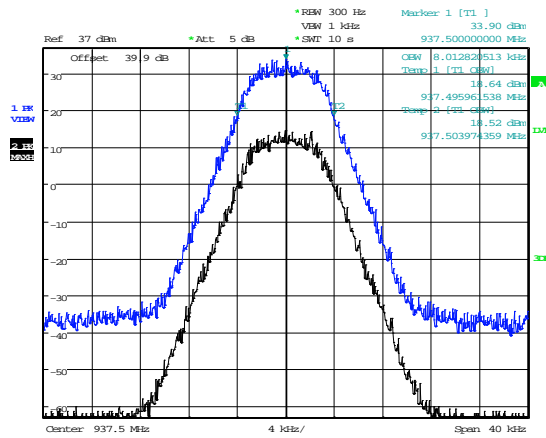

Date: 5.MAR.2015 14:55:09

H-CPM high channel

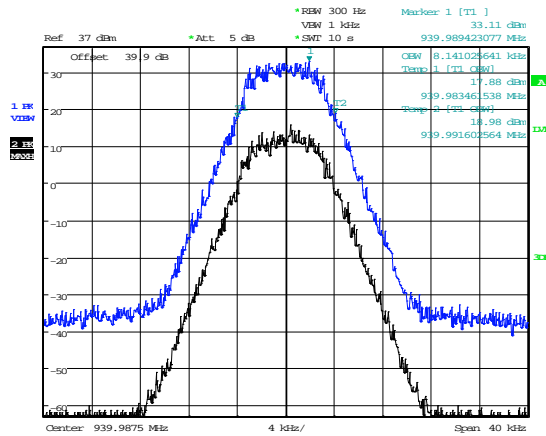

Date: 5.MAR.2015 14:58:05

P 1/4 DQPSK low channel

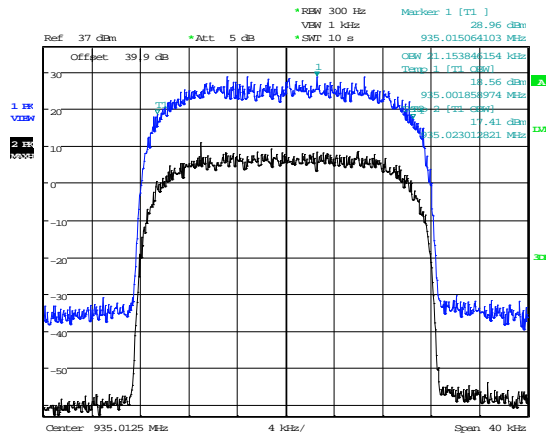

Date: 5.MAR.2015 15:14:25

P 1/4 DQPSK mid channel

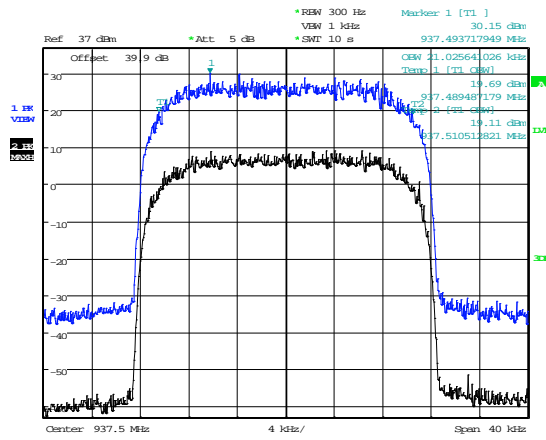

Date: 5.MAR.2015 15:17:12

P 1/4 DQPSK high channel

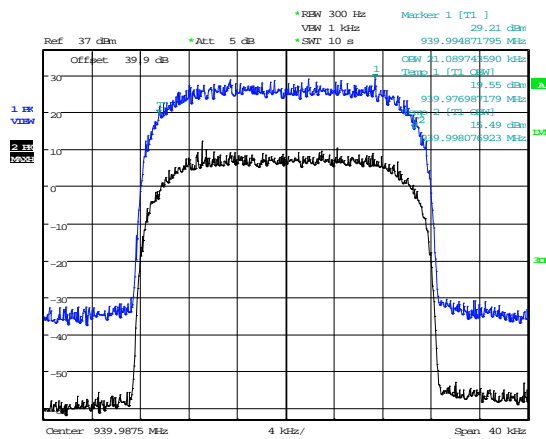

Date: 5.MAR.2015 15:21:15

Iden low channel

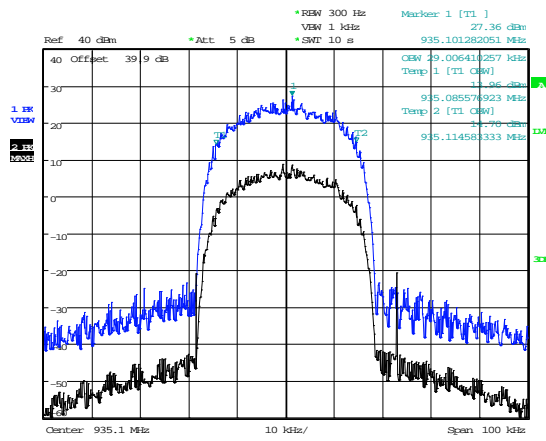

Date: 10.MAR.2015 11:47:42

Iden mid channel

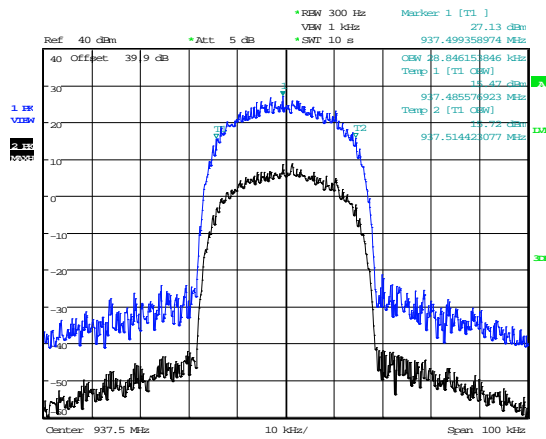

Date: 10.MAR.2015 11:56:02

Iden high channel

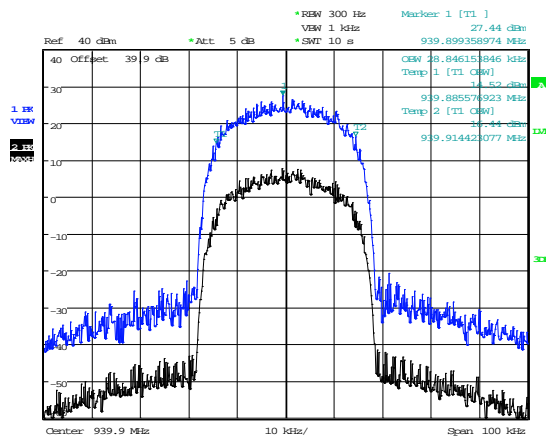

Date: 10.MAR.2015 12:09:28

The above plots depicting the output wawshape show no measurable distortion visible when compared to the input signal.

B4 Spurious Emissions at Antenna Terminals Less than 1MHz

Test Details:	
Measurement standard	Part 2.1053, 90.219(e)(1)
EUT sample number	S01
Modification state	0
SE in test environment	None
SE isolated from EUT	None
EUT set up	Refer to Appendix C

Modulation Type	Bandedge	Carrier Frequency (MHz)	Max Level @ bandedge (dBm)
FM	Lower	935.007000	-14.05
	Upper	939.991880	-14.63
C4FM	Lower	935.005865	-14.14
	Upper	939.992600	-14.16
H-CPM	Lower	935.005770	-13.98
	Upper	939.993000	-14.81
H -DQPSK	Lower	935.005700	-14.43
	Upper	939.99310	-14.28
P1/4 DQPSK	Lower	935.011335	-14.43
	Upper	939.987550	-13.95
Iden	Lower	935.016506	-14.23
	Upper	939.980326	-16.28

LBE FM

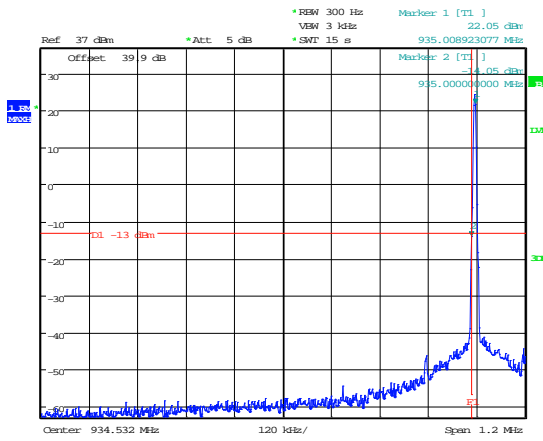

Date: 13.MAR.2015 11:21:21

UBE FM

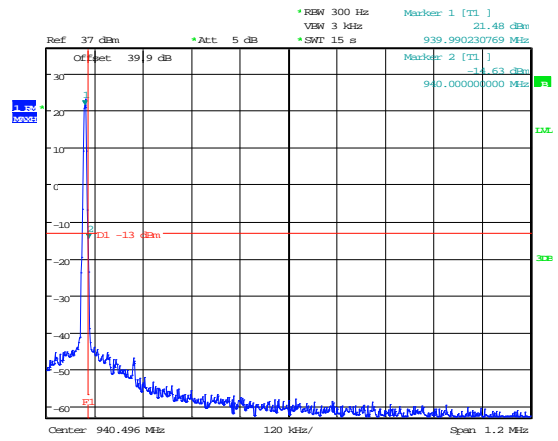

Date: 13.MAR.2015 11:27:52

C4FM LBE

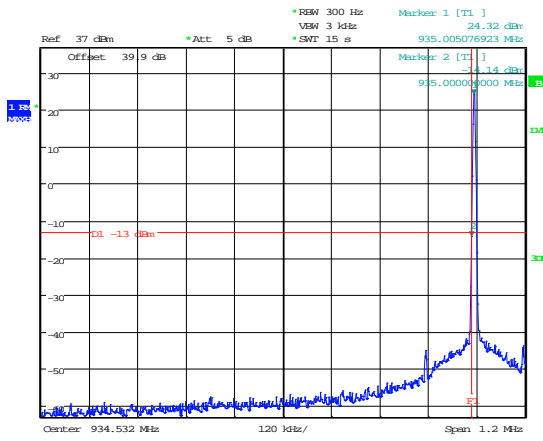

Date: 13.MAR.2015 11:15:45

C4FM UBE

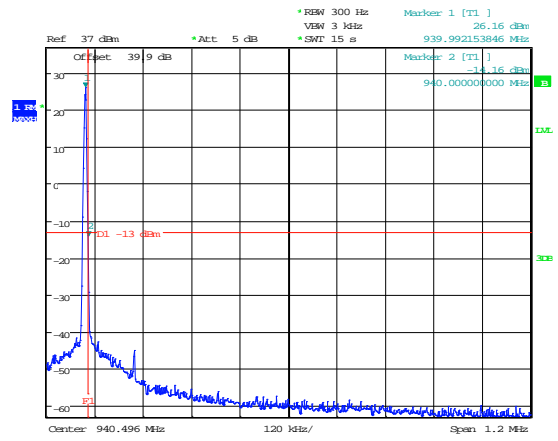

Date: 13.MAR.2015 11:37:25

LBE H-CPM

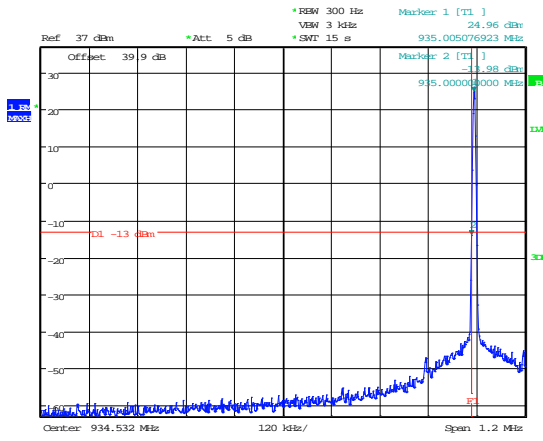

Date: 13.MAR.2015 11:04:12

UBE H-CPM

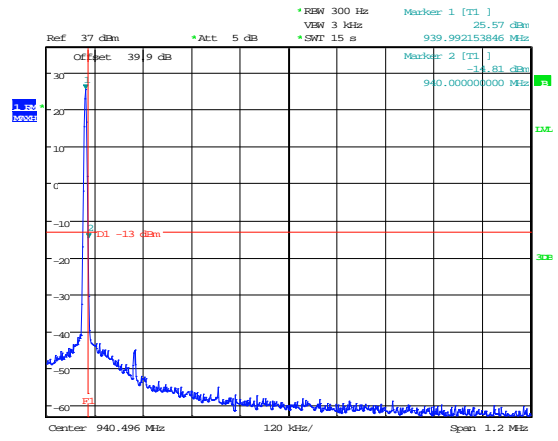

Date: 13.MAR.2015 11:44:10

LBE H-DQPSK

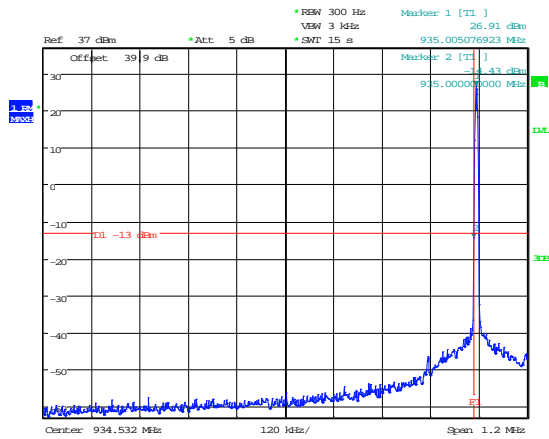

Date: 13.MAR.2015 11:01:07

UBE H-DQPSK

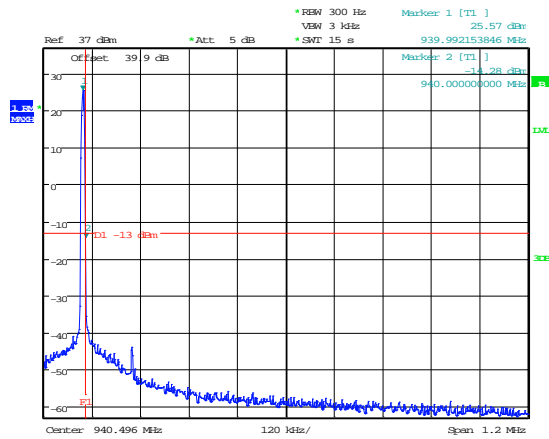

Date: 13.MAR.2015 11:49:10

LBE P1/4 DQPSK

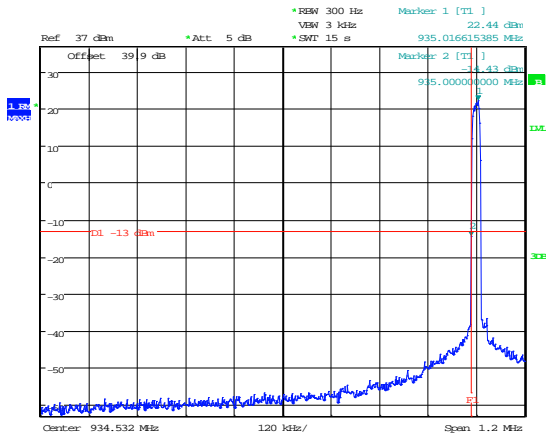

Date: 13.MAR.2015 10:53:14

UBE P1/4 DQPSK

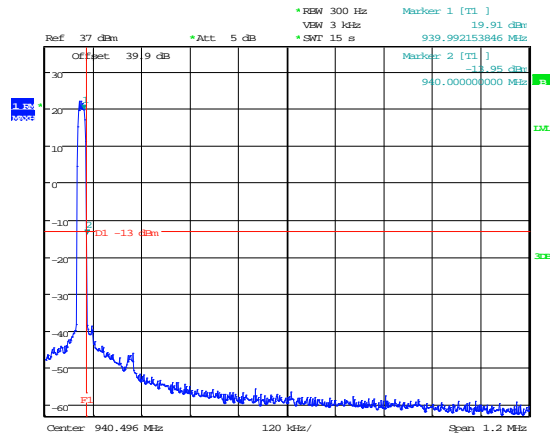

Date: 13.MAR.2015 12:11:15

LBE Iden

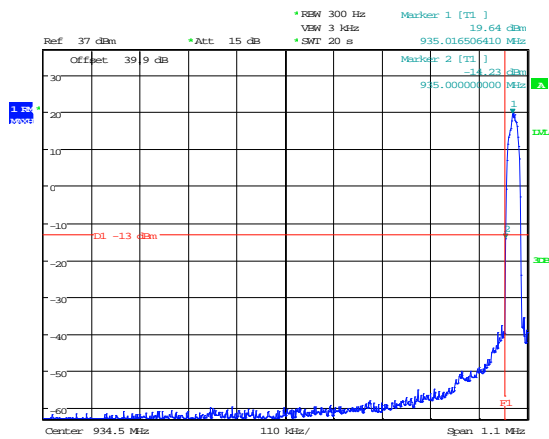

Date: 10.MAR.2015 14:40:19

UBE Iden

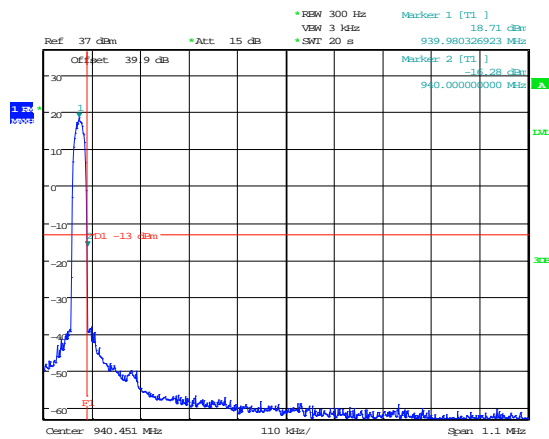

Date: 10.MAR.2015 14:56:50

B5 Spurious Emissions at Antenna Terminals Greater than 1MHz

Test Details:	
Measurement standard	Part 2.1053, 90.219(e)(1)
EUT sample number	S01
Modification state	0
SE in test environment	None
SE isolated from EUT	None
EUT set up	Refer to Appendix C

Frequency (MHz)	Frequency Range (MHz)	Freq. of Emission (MHz)	Measured Level (dBm)	Attenuator & Cable Losses (dB)	Spurious Emission Level (dBm)	Limit (dBm)
935.100	No Significant Emissions Within 20 dB of limit					-13
937.500						-13
939.900						-13

Limit is determined by the outermost step of the emissions mask and is calculated as follows:

At least $43 + 10 \log P$ dB

$$(10 \log P_{\text{watts}}) - (43 + 10 \log (P_{\text{watts}} * 1000)) = \text{LIMIT} = -13 \text{ dBm}$$

Result

The EUT was found to comply with the limits

Note: The plots below are without the use of a notch filter.

935.100MHz

9kHz - 150kHz

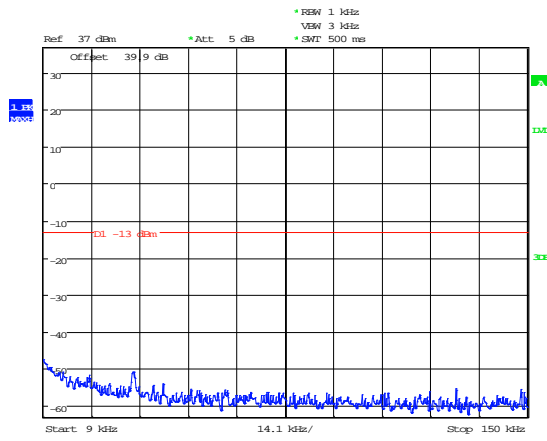

Date: 4.MAR.2015 09:15:07

150kHz - 30MHz

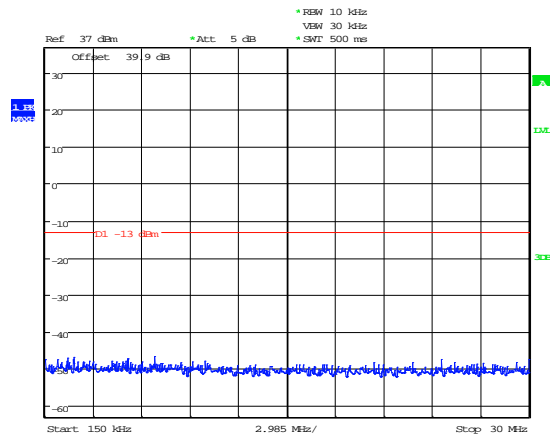

Date: 4.MAR.2015 09:15:34

30MHz - 1GHz

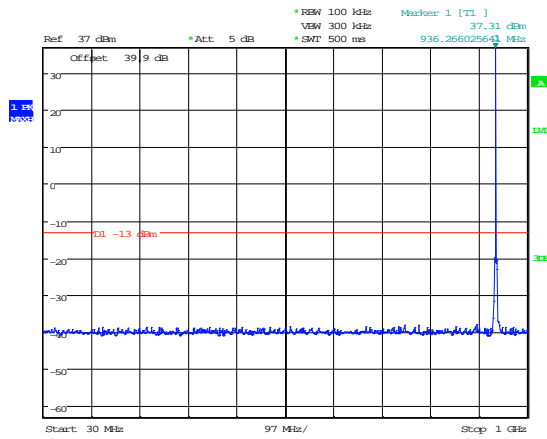

Date: 4.MAR.2015 09:14:34

1GHz - 5GHz

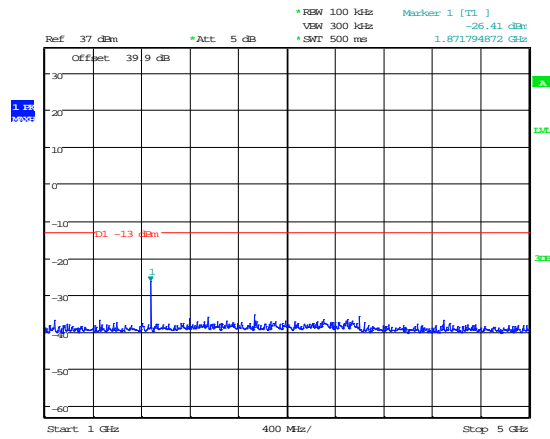

Date: 4.MAR.2015 09:16:40

5GHz - 10GHz

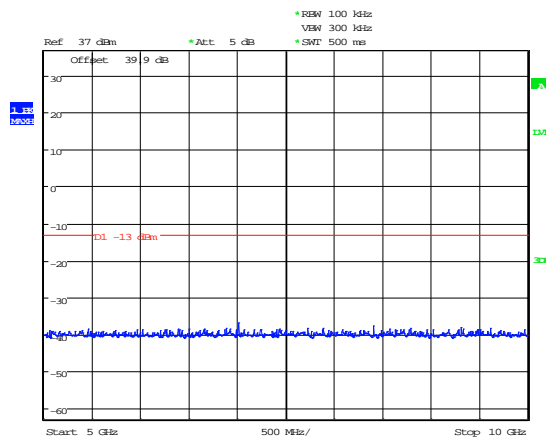

Date: 4.MAR.2015 09:17:04

937.500MHz

9kHz - 150kHz

150kHz - 30MHz

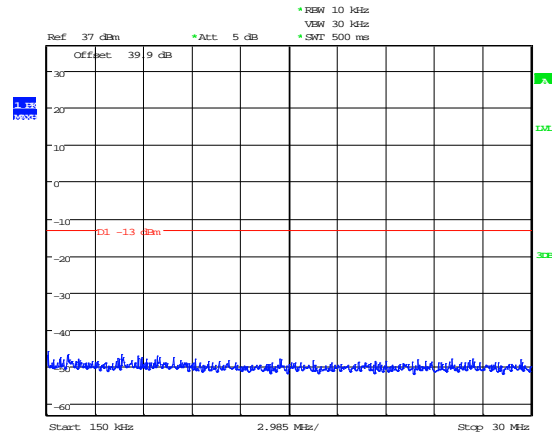
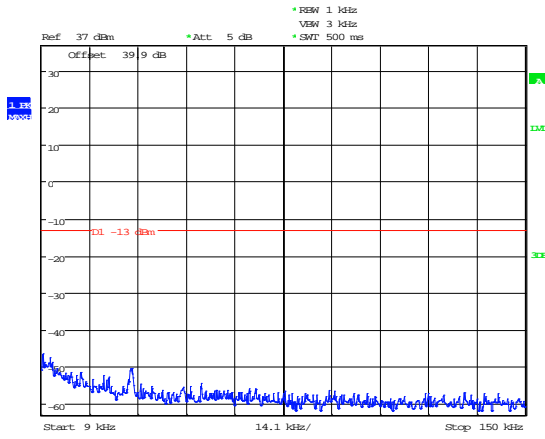

Date: 4.MAR.2015 09:21:01

Date: 4.MAR.2015 09:21:29

30MHz - 1GHz

1GHz - 5GHz

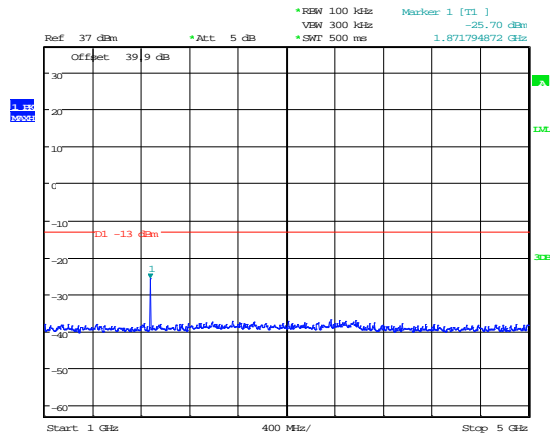
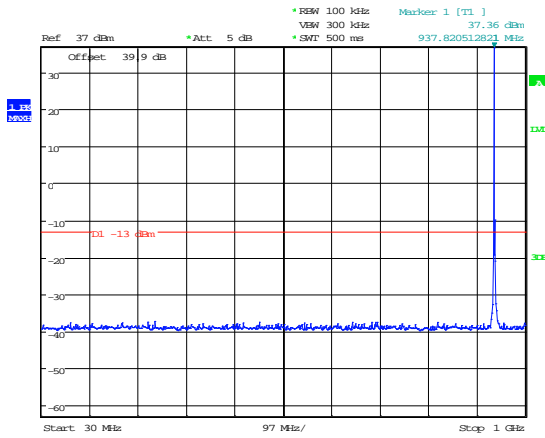

Date: 4.MAR.2015 09:20:31

Date: 4.MAR.2015 09:22:59

5GHz - 10GHz

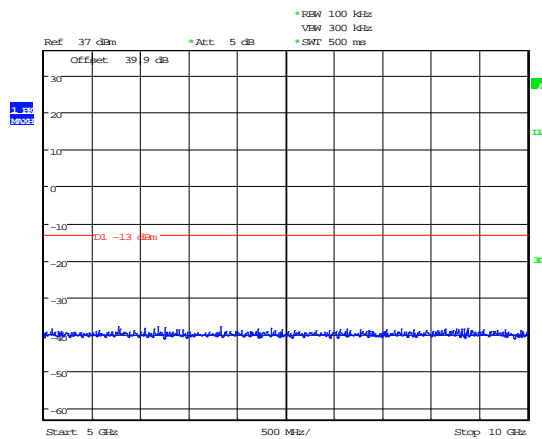

Date: 4.MAR.2015 09:24:08

939.900MHz

9kHz - 150kHz

150kHz – 30MHz

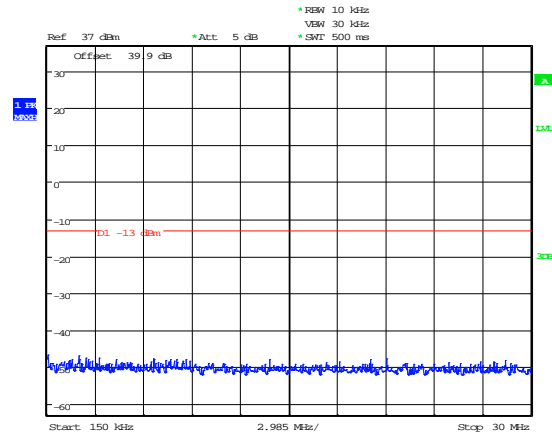
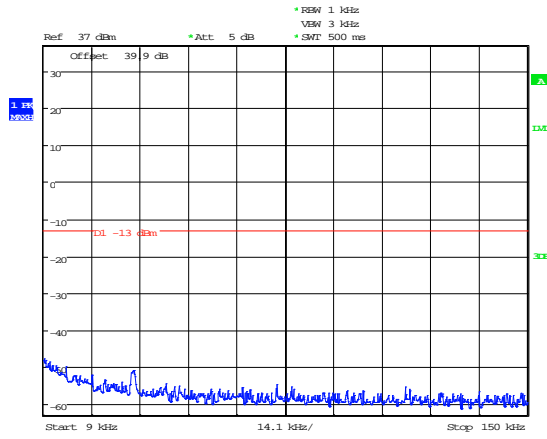

Date: 4.MAR.2015 09:27:59

Date: 4.MAR.2015 09:28:25

30MHz – 1GHz

1GHz – 5GHz

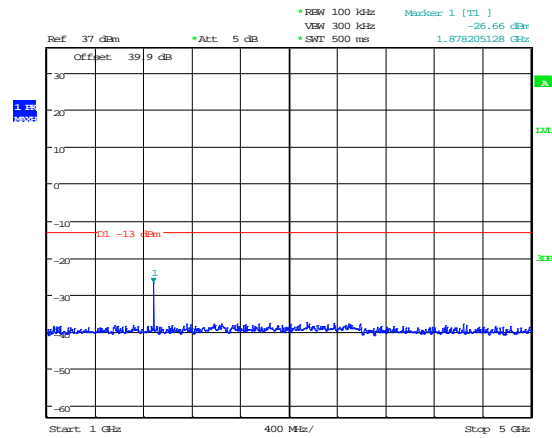
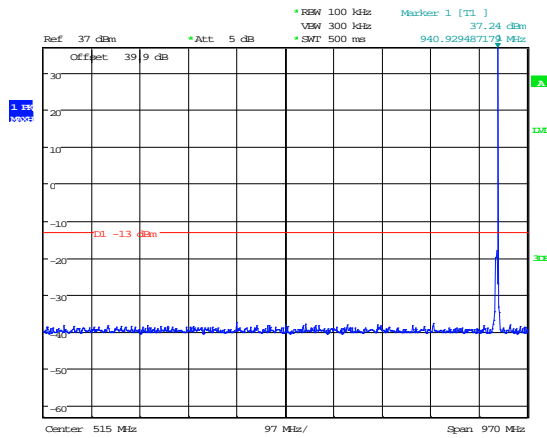

Date: 4.MAR.2015 09:27:14

Date: 4.MAR.2015 09:29:04

5GHz – 10GHz

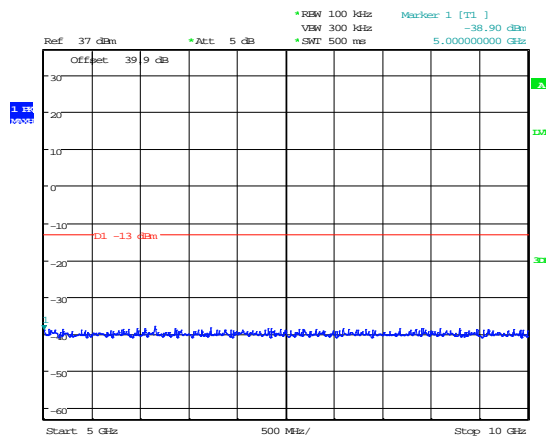

Date: 4.MAR.2015 09:29:29

B6 Radiated Electric Field Emissions

Preliminary scans were performed using a peak detector with the RBW = 100kHz. The radiated electric field emission test applies to all spurious and harmonic emissions. The EUT was set to transmit as required.

The following test site was used for final measurements as specified by the standard tested to:

3m open area test site : 3m alternative test site :

The effect of the EUT set-up on the measurements is summarised in note (c) below.

Test Details:	
Measurement standard	Part 2.1053, 90.219(e)(1)
Frequency range	30 MHz – 22 GHz
EUT sample number	S01
Modification state	0
SE in test environment	None
SE isolated from EUT	None
EUT set up	Refer to Appendix C

Frequency (MHz)	Freq. of Emission (MHz)	ERP/EIRP (dBm)	Limit (dBm)
935.100	No Significant Emissions Within		-13
937.500			-13
939.900			-13

Result

The EUT was found to comply with the limits

Notes:

1. Emissions Checked up to 10 times Fc.
2. The unit was mounted on a turntable and rotated through 360⁰ and in 3 orthogonal planes to find the worst case emission.
3. For Frequencies below 1 GHz, RBW = 120 kHz, testing was performed with CISPR16 compliant test receiver with QP detector. Above 1 GHz tests were performed using a spectrum analyser using the following settings:

Peak Detector RBW = 1MHz; VBW = ≥RBW

4. Limit is determined as the outermost step of the emissions mask and is calculated as follows.

At least 43 + 10 log P dB

$$(10\log P_{\text{watts}}) - (43 + 10\log (P_{\text{watts}} * 1000)) = \text{LIMIT} = -13 \text{ dBm}$$

The upper and lower frequency of the measurement range was decided according to 47 CFR Part 2.1057.

- (a) Where results have been measured at one distance, and a signal level displayed at another, the results have been extrapolated using the following formula:

$$\text{Extrapolation (dB)} = 20 \log_{10} \left(\frac{\text{measurement distance}}{\text{specification distance}} \right)$$

- (b) The levels may have been rounded for display purposes.
- (c) The following table summarises the effect of the EUT operating mode, internal configuration and arrangement of cables / samples on the measured emission levels :

	See (i)	See (ii)	See (iii)	See (iv)
Effect of EUT operating mode on emission levels	✓			
Effect of EUT internal configuration on emission levels	✓			
Effect of Position of EUT cables & samples on emission levels			✓	
(v) Parameter defined by standard and / or single possible, refer to Appendix D				
(vi) Parameter defined by client and / or single possible, refer to Appendix D				
(vii) Parameter had a negligible effect on emission levels, refer to Appendix D				
(viii) Worst case determined by initial measurement, refer to Appendix D				

935.100MHz

30MHz – 1GHz

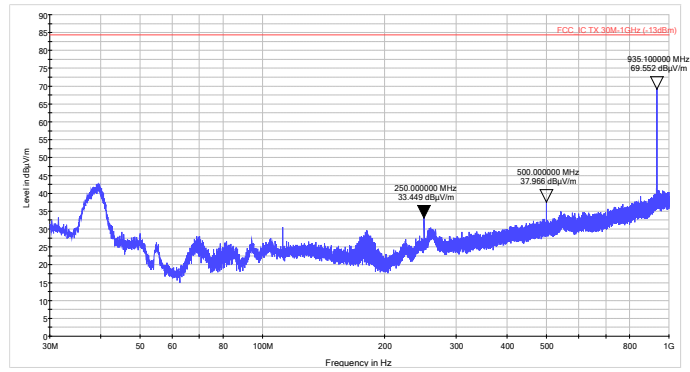

1GHz – 5GHz

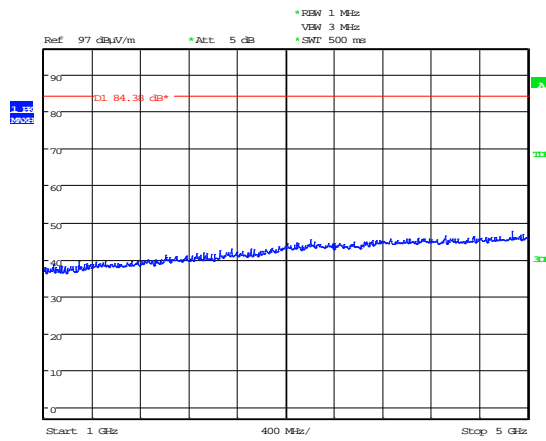

Date: 9.MAR.2015 11:23:03

5GHz – 10GHz

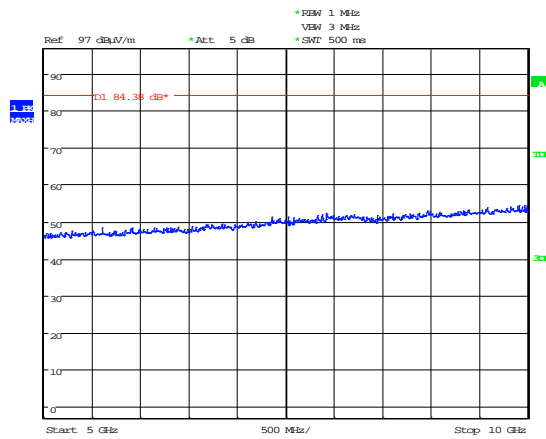

Date: 9.MAR.2015 11:23:29

937.500MHz

30MHz – 1GHz

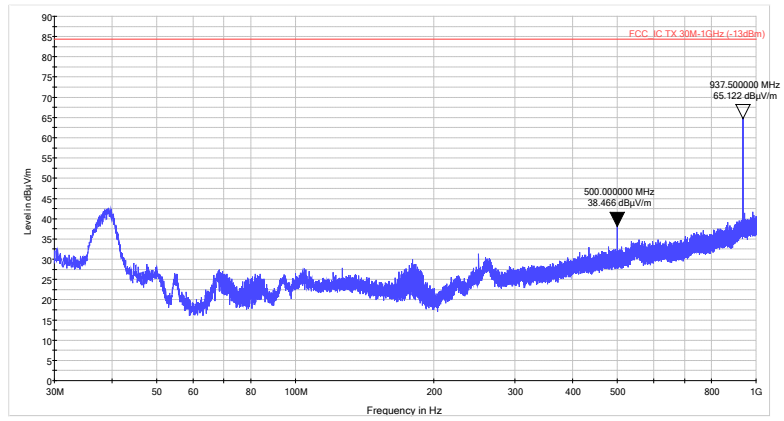

1GHz – 5GHz

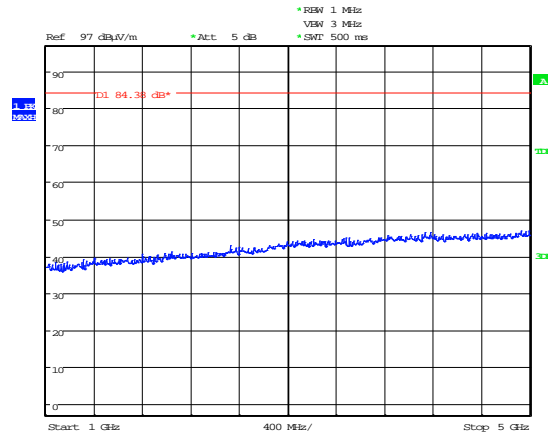

Date: 9.MAR.2015 11:26:26

5GHz – 10GHz

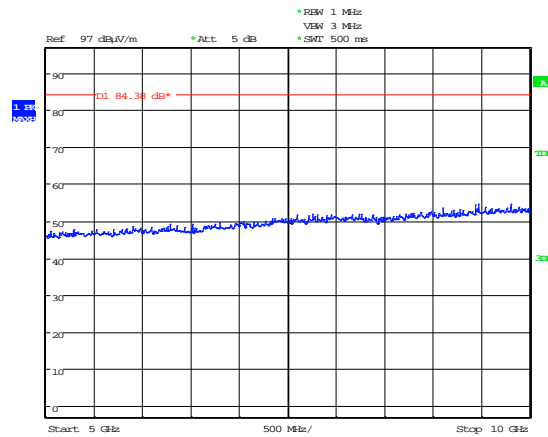

Date: 9.MAR.2015 11:26:52

939.900MHz

30MHz – 1GHz

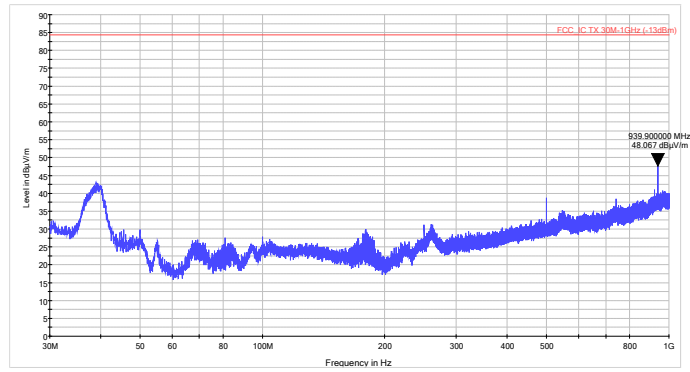

1GHz – 5GHz

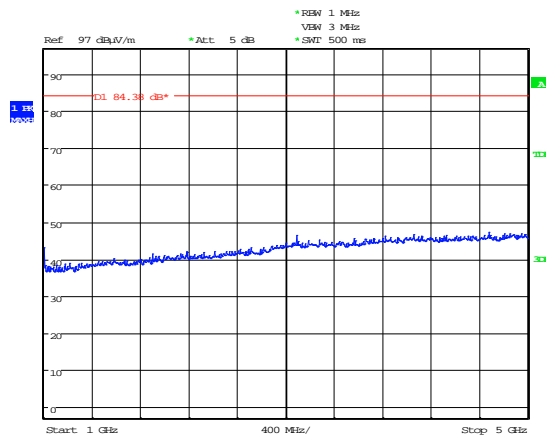

Date: 9.MAR.2015 11:29:23

5GHz – 10GHz

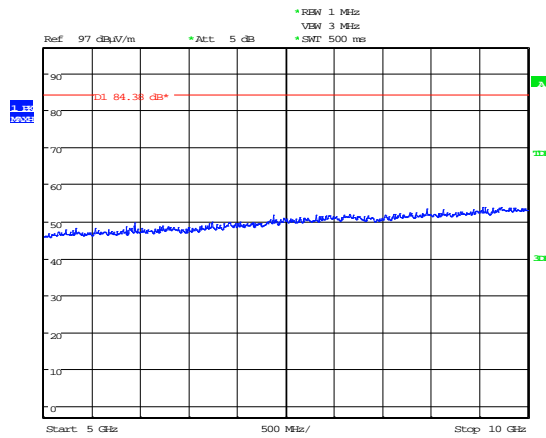

Date: 9.MAR.2015 11:29:58

B7 Passband Gain & Bandwidth

Test Details:	
Measurement standard	D.3 Policies + Procedures (k) of KDB 935210 D02 Signal Boosters Certification v02
EUT sample number	S01
Modification state	0
SE in test environment	None
SE isolated from EUT	None
EUT set up	Refer to Appendix C

BAND	fl	fh	20 dB Bandwidth
935.00MHz – 940.00MHz	934.665000MHz	940.320000MHz	5.655MHz

With the aid of a CW Swept signal generator and spectrum analyser, the bandwidth and frequency response of the open channel (i.e. at the point where the gain has fallen by 20 dB) is measured. This measurement shows the gain-versus-frequency response of the open channel from the midband frequency f_0 of the channel up to at least $f_0 + 250\%$ of the 20 dB bandwidth.

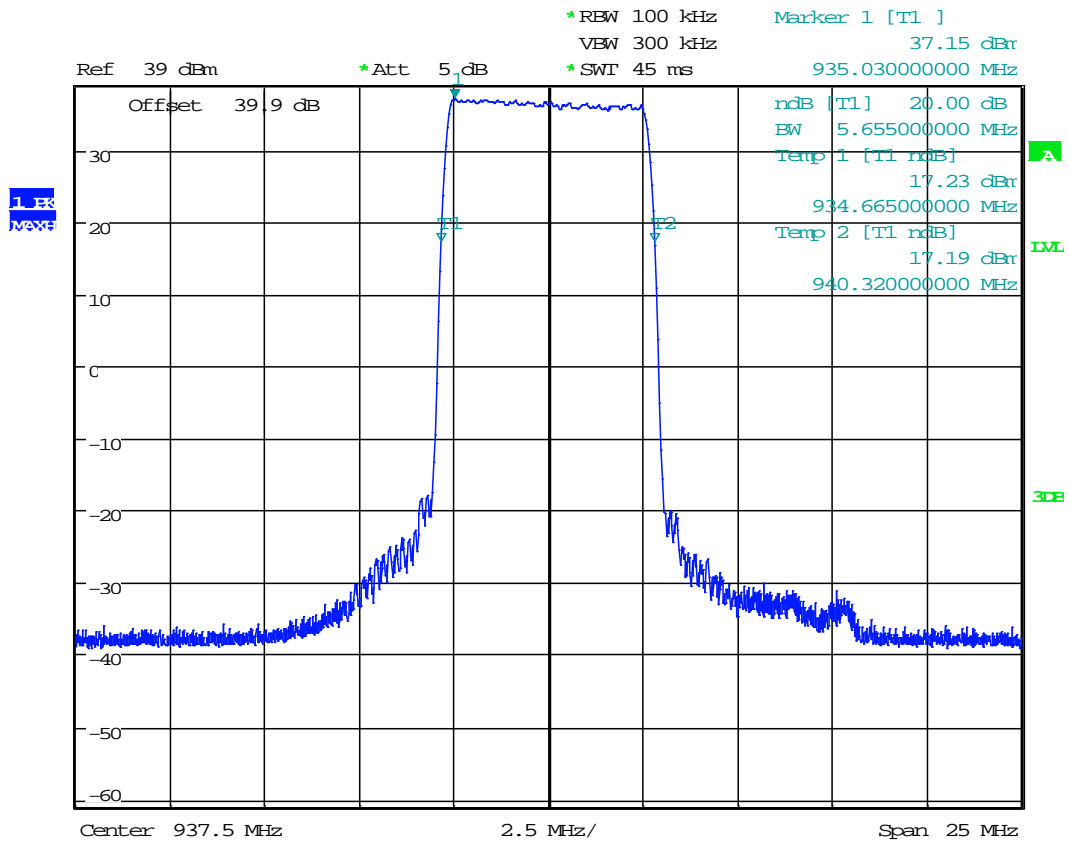

Date: 6.MAR.2015 11:01:06

B8 Noise (Conducted)

Test Details:	
Measurement standard	90.219(d)(ii)(iii)90.219(e)(2)
Frequency range	30 MHz – 10 GHz
EUT sample number	S01
Modification state	0
SE in test environment	None
SE isolated from EUT	None

See Plot below

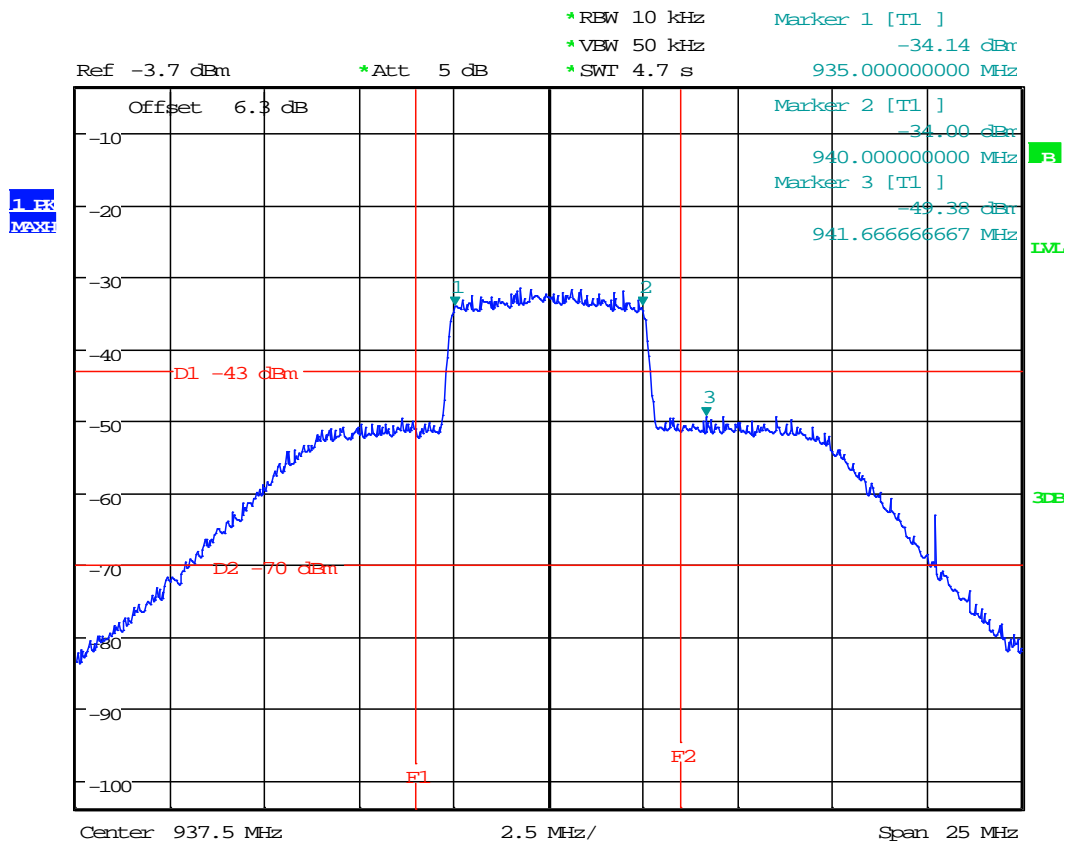

Date: 13.MAR.2015 14:32:02

- ii) In general the ERP of noise within the passband should not exceed -43dBm in a 10 kHz measurement bandwidth.
- iii) In general the ERP of noise on the spectrum more than 1MHz outside of the passband should not exceed -70dBm in a 10 kHz measurement bandwidth.

Whilst the pass band noise is greater than the -43dBm limit by approximately 11dB, the manufacturer has stated that they mitigate this by using good engineering practice as follows:-

Compliance with FCC deployment rule regarding the radiation of noise

Good engineering practice must be used in regard to the signal booster's noise radiation. Thus, the gain of the signal booster should be set so that the EIRP of the output noise from the signal booster should not exceed the level of -43 dBm in 10 kHz measurement bandwidth.

In the event that the noise level measured exceeds the aforementioned value, the signal booster gain should be decreased accordingly.

In general, the ERP of noise on a spectrum more than 1 MHz outside of the pass band should not exceed -70 dBm in a 10 kHz measurement bandwidth.

The D-SBR 3709S signal booster has a noise level of -49.38 dBm in 10 kHz measurement at 1 MHz spectrum outside the passband of the signal booster. It has an in-band noise level at around -32 dBm in a 10 kHz bandwidth Therefore the noise at the antenna input port should be calculated based on equation (3)

Equation (3) - Input Noise to service antenna

Input Noise to service antenna:

-43 dBm + Service Antenna gain – Antenna splitter losses in dB – cable loss in dBs

Example:

Signal booster connected to 10 service antennas with a 100m long ½ inch cable.

- *Losses of such a cable with the connectors = ~ 11dB.*
- *Gain = ~ 2 dBi*

Assuming 10 service antennas: antenna splitter losses = 11 dBi

Based on equation (3) Input antenna noise (to the antenna) = -49.38+2-11 -11=-69.38 dB .

The inband input noise to the antenna should be -32+2 -11-11= -52dbm

NOTE: in this example you may be required to add an external bandpass filter that would attenuate out of band noise by 1dB.

Conclusion:

Good engineering practice requires that in general when the out of band noise measured at the service antenna input is more than -70 dBm per 10 kHz measurement bandwidth, an external band pass filter should be added to attenuate the out of band noise level .

As per Part 90.219(e)(2) The noise figure of a signal booster must not exceed 9dB in either direction.

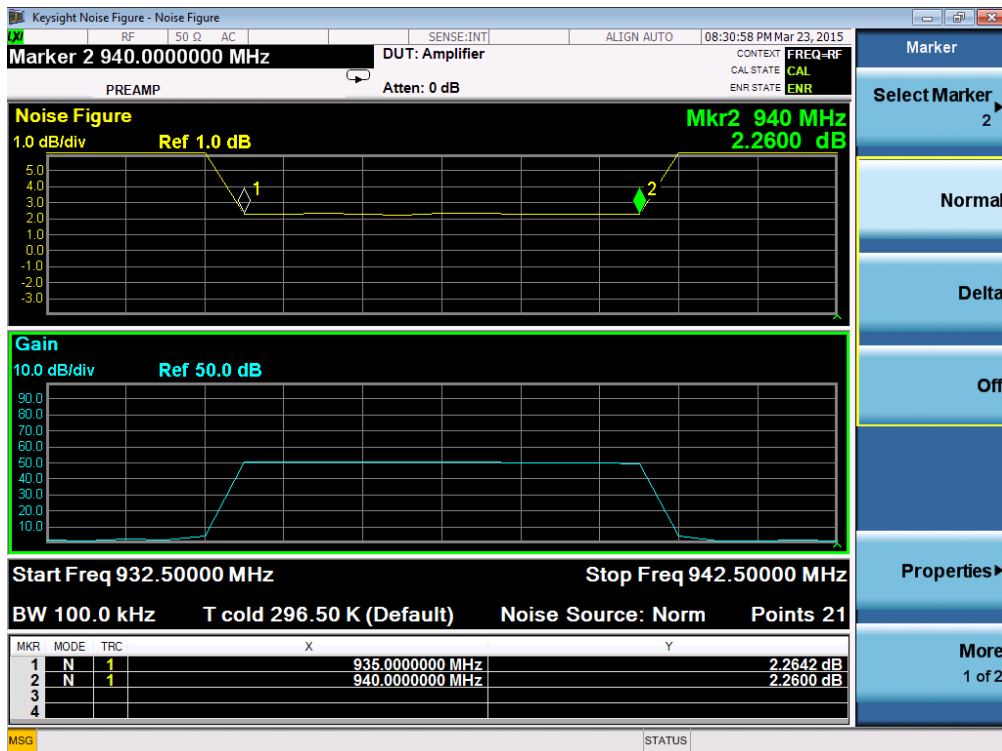

Max noise figure = 2.2642dB

Appendix C:**Additional Test and Sample Details**

This appendix contains details of:

1. The samples submitted for testing.
2. Details of EUT operating mode(s)
3. Details of EUT configuration(s) (see below).
4. EUT arrangement (see below).

Throughout testing, the following numbering system is used to identify the sample and it's modification state:

Sample No: Sxx Mod w

where:

xx	= sample number	eg. S01
w	= modification number	eg. Mod 2

The following terminology is used throughout the test report:

Support Equipment (SE) is any additional equipment required to exercise the EUT in the applicable operating mode. Where relevant SE is divided into two categories:

SE in test environment: The SE is positioned in the test environment and is not isolated from the EUT (e.g. on the table top during REFE testing).

SE isolated from the EUT: The SE is isolated via filtering from the EUT. (e.g. equipment placed externally to the ALSR during REFE testing).

EUT configuration refers to the internal set-up of the EUT. It may include for example:

- Positioning of cards in a chassis.
- Setting of any internal switches.
- Circuit board jumper settings.
- Alternative internal power supplies.

Where no change in EUT configuration is **possible**, the configuration is described as "single possible configuration".

EUT arrangement refers to the termination of EUT ports / connection of support equipment, and where relevant, the relative positioning of samples (EUT and SE) in the test environment.

For further details of the test procedures and general test set ups used during testing please refer to the related document "EMC Test Methods - An Overview", which can be supplied by TRaC Global upon request.

C1) Test samples

The following samples of the apparatus were submitted by the client for testing :

Sample No.	Description
S01	D-SBR 3709S (SMR 900 Digital Channel Selective and Band selective repeater)

Sample No.		
S01	Hardware revision number	B
S01	Software revision number	5.9.5

C2) EUT Operating Mode During Testing.

During testing, the EUT was exercised as described in the following tables :

Test	Description of Operating Mode:
All tests detailed in this report	EUT active, operating at maximum gain and output power

C3) EUT Configuration Information.

The EUT was submitted for testing in one single possible configuration.

C4) List of EUT Ports

The tables below describe the termination of EUT ports:

Sample : S01
Tests : Conducted

Port	Description of Cable Attached	Cable length	Equipment Connected
Network port	Ethernet Cable	3M	Test PC

Sample : S01
Tests : Radiated Emissions

Port	Description of Cable Attached	Cable length	Equipment Connected
Network port	Ethernet Cable	3M	Test PC
Power	Multi core	1.5m	AC Mains
Output ports	50 Ω Dummy Load	1.5m	N/A
Input ports	N-N coax cable	1.m	Signal generator

* Only connected during setup.

C5 Details of Equipment Used

TRaC No	Equipment Type	Equipment Description	Manufacturer	Last Cal	Cal Period	Due For Cal
L352	ESVS10	Receiver	R&S	21/03/2014	12	21/03/2015
UH093	CBL6112B	Bilog	Chase	08/07/2013	24	08/07/2015
REF909	FSU26	Spectrum Analyser	R&S	13/02/2015	12	13/02/2016
L138	3115	1-18GHz Horn	EMCO	17/10/2013	24	17/10/2015
L139	3115	1-18GHz Horn	EMCO	20/09/2013	24	20/09/2015
L572	8449B	Pre Amp	Agilent	10/02/2015	12	10/02/2016
REF916	SMBV100A	Signal Generator	R&S	17/02/2015	12	17/02/2016
REF940	ATS	IC Reg Radio Chamber - PP	Rainford EMC	19/11/2014	36	19/11/2017
REF976	34405a	Multimeter	Agilent	19/05/2014	12	19/05/2015
REF828	50140	Tunable bandstop filter	K&L	Cal in use		
REF 844	E4438C	VSG	Agilent	28/03/2014	12	28/03/2015
UH253	1m N type	Cable	TRaC	Cal in use		
UH271	1.5m N type	Cable	TRaC	Cal in use		
UH273	2m N type	Cable	TRaC	Cal in use		
TRLUH225	100W 20dB	Attenuator	Spinner	Cal in use		
TRL135	2W 3dB	Attenuator	Huber Suhner	Cal in use		
TRL222	10W 10dB	Attenuator	Bird	Cal in use		
TRL246	10W 6dB	Attenuator	Bird	Cal in use		

Appendix D:

Additional Information

No additional information is included within this test report.

Appendix E:

Photographs and Figures

The following photographs were taken of the test samples:

1. Radiated electric field emissions arrangement
2. Radiated electric field emissions arrangement

Photograph 1

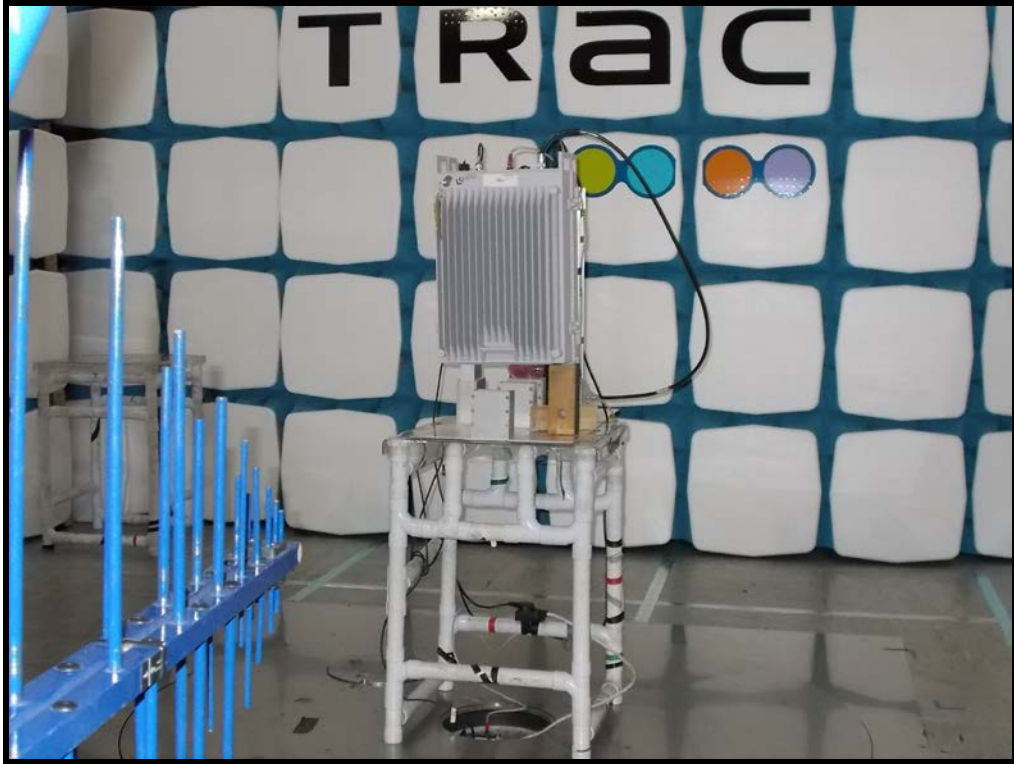

Photograph 2

