



Hermon Laboratories Ltd.
Harakevet Industrial Zone, Binyamina 30500,
Israel
Tel. +972-4-6288001
Fax. +972-4-6288277
E-mail: mail@hermonlabs.com

TEST REPORT

ACCORDING TO: FCC CFR 47 PART 90, section 90.219

FOR:

Axell Wireless Israel Ltd.

Band Selective Repeater

Model: D-MBR 3007-3008-PS NFPA-A

FCC ID:NEODMBA30073008PS

This report is in conformity with ISO/IEC 17025. The "A2LA Accredited" symbol endorsement applies only to the tests and calibrations that are listed in the scope of Hermon Laboratories accreditation. The test results relate only to the items tested.
This test report shall not be reproduced in any form except in full with the written approval of Hermon Laboratories Ltd.

Table of contents

1	Applicant information	3
2	Equipment under test attributes	3
3	Manufacturer information	3
4	Test details	3
5	Tests summary	4
6	EUT description	5
6.1	General information	5
6.2	EUT modules and sub-assemblies	5
6.3	EUT options/configurations	5
6.4	Ports and lines	5
6.5	Support and test equipment	5
6.6	Changes made in EUT	5
6.7	Test configuration	6
6.8	Transmitter characteristics	7
7	Transmitter tests according to 47CFR part 90 requirements	8
7.1	Maximum output power test	8
7.2	Occupied bandwidth test	30
7.3	Emission mask test	52
7.4	Intermodulation product test	79
7.5	Noise figure test	89
7.6	Emission mask test according to section 90.210(h)	95
7.7	Radiated spurious emission measurements	105
7.8	Spurious emissions at RF antenna connector test	123
8	APPENDIX A Test equipment and ancillaries used for tests	199
9	APPENDIX B Measurement uncertainties	201
10	APPENDIX C Test facility description	202
11	APPENDIX D Specification references	202
12	APPENDIX E Test equipment correction factors	203
13	APPENDIX F Abbreviations and acronyms	212



1 Applicant information

Client name: Axell Wireless Israel Ltd.
Address: 6 Bareket street, Petach Tikva 49002, Israel
Telephone: +972 3918 0180
Fax: +972 3918 0190
E-mail: Tamir.BenShoshan@axellwireless.com
Contact name: Mr. Tamir Ben Shoshan

2 Equipment under test attributes

Product name: Band Selective Repeater
Product type: a 90.219 Class A signal booster
Model(s): D-MBR 3007-3008-PS NFPA-A
Serial number: 14060076
Hardware version: B
Software release: 6.0.6
Receipt date: 3-Aug-14

3 Manufacturer information

Manufacturer name: Axell Wireless Israel Ltd.
Address: 6 Bareket street, Petach Tikva 49002, Israel
Telephone: +972 3918 0180
Fax: +972 3918 0190
E-Mail: Tamir.BenShoshan@axellwireless.com
Contact name: Mr. Tamir Ben Shoshan

4 Test details

Project ID: 25633
Location: Hermon Laboratories Ltd. Harakevet Industrial Zone, Binyamina 30500, Israel
Test started: 3-Aug-14
Test completed: 01-Sep-14
Test specification(s): 47CFR part 90, section 90.219



5 Tests summary

Test	Status
Transmitter characteristics	
Section 90.219(e)(1), Radiated output power	Pass
Section 90.219(a), Occupied bandwidth	Pass
Section 90.210(b), Emission mask	Pass
Section 90.210(h), Emission mask	Pass
Section 90.210(b), Intermodulation product	Pass
Section 90.219(e)(2) Noise figure	Pass
Section 90.219(e)(3), Radiated spurious emissions	Pass
Section 90.219(e)(3), Conducted spurious emissions	Pass
Section 2.1091, RF radiation exposure evaluation	Pass, exhibit provided in Application for certification

Testing was completed against all relevant requirements of the test standard. The results obtained indicate that the product under test complies in full with the requirements tested.

The test results relate only to the items tested. Pass/ fail decision was based on nominal values.

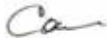
This test report supersedes the previously issued test report identified by Doc ID:AXERAD_FCC.25633A.

	Name and Title	Date	Signature
Tested by:	Mr. S. Samokha, test engineer	September 1, 2014	
Reviewed by:	Mrs. M. Cherniavsky, certification engineer	February 10, 2015	
Approved by:	Mr. M. Nikishin, EMC and Radio group manager	February 10, 2015	

6 EUT description

6.1 General information

The EUT, Digital Multi Band Repeater for Public Safety, model D-MBR 3007-3008-PS NFPA-A, is a high-power digital multi-channel Class A signal booster (DCSB) that features an array of up to 12 DSP based, softwarecontrolled, variable bandwidth filters, user-programmable across the 700 and 800 MHz bands.

The D-MBR 3007-3008-PS NFPA supports all public safety technologies. In addition to specifying the centre frequency of each filter, the user can select a filter from a drop down list that has several choices for each pass band that vary in time delay and filter slope. This gives the engineer the unique ability to trade off the adjacent channel rejection and time delay interference for the coverage area permitting the use of the D-MBR 3007-3008-PS NFPA in applications where no other booster solution will work.

Every parameter of D-MBR 3007-3008 PS NFPA including filter tuning and selection, is software controlled via Web management. The patented Axell Wireless' digital RF filter not only enables simple initial setup for any channel plan, but if necessary even permits a simple reconfiguration because of re-banding.

6.2 EUT modules and sub-assemblies

Description	Manufacturer	Model or P/N	Serial number
Booster	Axell Wireless	D-MBP 3007-3008-PS-NFPA	14060076
AC/DC adapter	MW	CLG-150-30A	RB05229260

6.3 EUT options/configurations

Number	Operating mode description	Configuration
1	Transmit 758-775 MHz, Downlink	1
2	Transmit 851-861 MHz, Downlink	2
3	Transmit 788-805 MHz, Uplink	3
4	Transmit 806-816 MHz, Uplink	4

6.4 Ports and lines

Port type	Port description	Connected from	Connected to	Qty.	Cable type	Cable length, m
Power	AC	AC mains	AC/DC adapter	1	Unshielded	1.5
Power	DC	AC/DC adapter	EUT	1	Unshielded	0.3
Signal	Ethernet	EUT	PC	1	UTP	5
Signal	Antenna	EUT	Antenna	2	Coax	NA
Signal	Alarm I/O	EUT	OC	1	Unshielded	3

6.5 Support and test equipment

Description	Manufacturer	Model number	Serial number
Laptop	DELL	PP20L	5QXF83J
AC/DC adapter	DELL	LA65NS0	0DF263-71615-79F-E85D
Mouse	Logitech	810-001317	NA

6.6 Changes made in EUT

No changes were implemented in the EUT during testing.



6.7 Test configuration

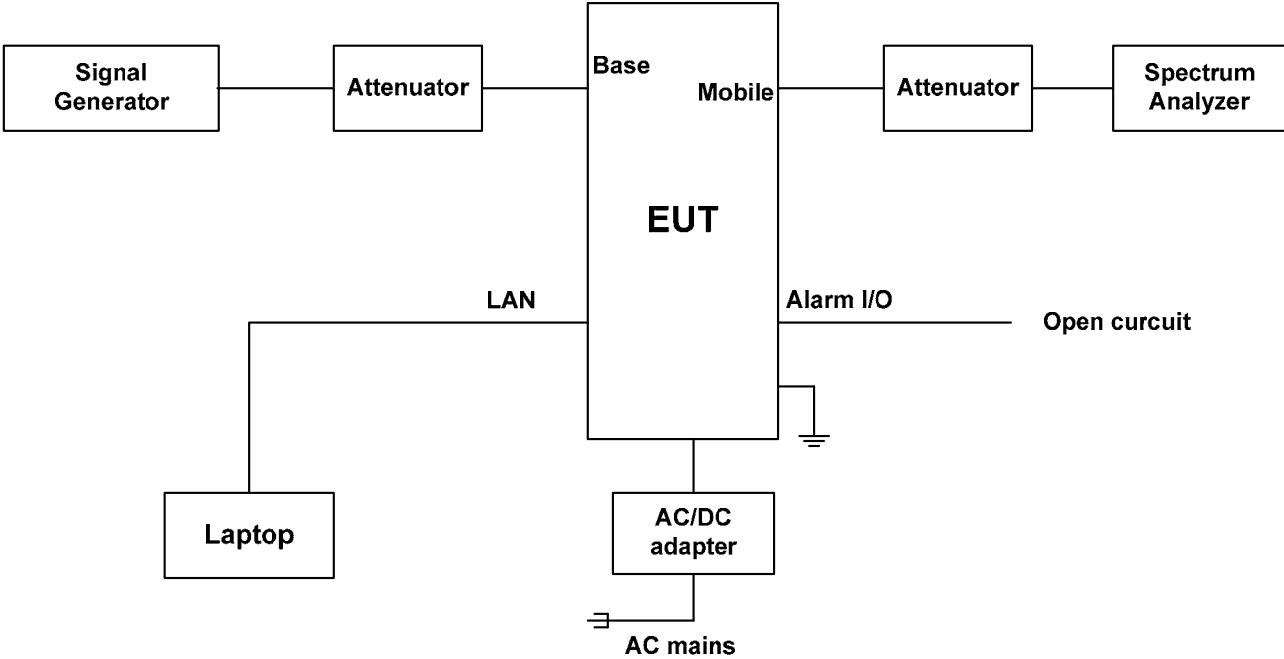

6.8 Transmitter characteristics

Type of equipment						
V	Stand-alone (Equipment with or without its own control provisions)					
	Combined equipment (Equipment where the radio part is fully integrated within another type of equipment)					
	Plug-in card (Equipment intended for a variety of host systems)					
Intended use		Condition of use				
V	fixed	Always at a distance more than 2 m from all people				
	mobile	Always at a distance more than 20 cm from all people				
	portable	May operate at a distance closer than 20 cm to human body				
Assigned frequency range		DL 758.0 – 775.0 MHz; UL 788.0 – 805.0 MHz- FCC part 90, subpart R DL 851.0 – 861.0 MHz; UL 806.0 – 816.0 MHz - FCC part 90, section 90.614				
Operating frequency range		DL 758.0 – 775.0 MHz; UL 788.0 – 805.0 MHz DL 851.0 – 861.0 MHz; UL 806.0 – 816.0 MHz				
Maximum rated output power		At maximum gain, Output port		30 dBm each band		
		EIRP density dBm / MHz (aggregate power of both RF chains) with maximum declared antenna gain		NA		
Is transmitter output power variable?		No				
		V	Yes	continuous variable		
				V	stepped variable with stepsize	1.0 dB
				minimum RF power		NA
maximum RF power		30 dBm				
Antenna connection						
unique coupling	V	standard connector	Integral	with temporary RF connector without temporary RF connector		
Antenna/s technical characteristics						
Type	Manufacturer		Model number	Antenna gain, dBi	Cable loss, dB	
External (Indoor)			NA	NA	NA	
External (Outdoor)			NA	NA	NA	
Transmitter aggregate data rate/s, Mbps						
Transmitter 99% power bandwidth		Type of modulation				
		C4FM	iDEN QAM	Analog FM		
		9.6 kbps	64 kbps	9.6 kbps		
Type of multiplexing						
Modulating test signal (baseband)						
Maximum transmitter duty cycle in normal use						
Transmitter power source						
	DC	Nominal rated voltage				
V	AC	Nominal rated voltage		From 120 VAC via AC/DC adapter		
Common power source for transmitter and receiver			V	yes	no	

Test specification:		Section 90.219(e)(1), Maximum output power	
Test procedure:		47 CFR, Section 2.1046; KDB 935210 D02 v02, Appendix D	
Test mode:		Verdict:	
Compliance		PASS	
Date(s):		03-Aug-14 - 07-Aug-14	
Temperature: 23.2 °C	Air Pressure: 1004 hPa	Relative Humidity: 44 %	Power Supply: 120 VAC
Remarks:			

7 Transmitter tests according to 47CFR part 90 requirements

7.1 Maximum output power test

7.1.1 General

This test was performed to measure the peak output power at RF antenna connector. Specification test limits are given in Table 7.1.1.

Table 7.1.1 Maximum output power limits

Assigned frequency range, MHz	Maximum output power (ERP)	
	W	dBm
Above 150.0	5.0	37.0

Test procedure

7.1.1.1 The EUT was set up as shown in Figure 7.1.1, energized and its proper operation was checked.

7.1.1.2 The EUT was adjusted to produce maximum available to the end user RF output power.

7.1.1.3 The peak output power was measured with spectrum analyzer as provided in Table 7.1.2 and associated plots.

Figure 7.1.1 Peak output power test setup

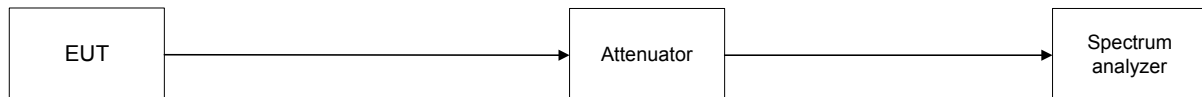



Test specification:		Section 90.219(e)(1), Maximum output power	
Test procedure:		47 CFR, Section 2.1046; KDB 935210 D02 v02, Appendix D	
Test mode:		Compliance	
Date(s):		03-Aug-14 - 07-Aug-14	
Temperature: 23.2 °C		Air Pressure: 1004 hPa	
		Relative Humidity: 44 %	
		Power Supply: 120 VAC	
Remarks:			

Table 7.1.2 Peak output power test results

DETECTOR USED: Average
 RESOLUTION BANDWIDTH: 1 MHz
 VIDEO BANDWIDTH: 3 MHz
 MODULATING SIGNAL: C4FM
 CONFIGURATION: Single Band

OPERATING FREQUENCY RANGE: 758 - 775 MHz (downlink)
 788 - 805 MHz (uplink)

Carrier frequency, MHz	Input port	SA reading, dBm		Output power**, dBm	Limit, dBm	Margin*, dB	Verdict
		Without ALC	With ALC				
Downlink transmit mode							
758.0	Base	31.97	32.03	32.03	37.0	-4.97	Pass
766.0	Base	32.60	32.61	32.61	37.0	-4.39	Pass
775.0	Base	31.84	31.84	31.84	37.0	-5.16	Pass
Uplink transmit mode							
788.0	Mobile	26.25	26.28	26.28	37.0	-10.72	Pass
796.0	Mobile	26.87	26.93	26.93	37.0	-10.07	Pass
805.0	Mobile	26.63	26.73	26.73	37.0	-10.27	Pass

OPERATING FREQUENCY RANGE: 851 - 861 MHz (downlink)
 806 - 816 MHz (uplink)

Carrier frequency, MHz	Input port	SA reading, dBm		Output power**, dBm	Limit, dBm	Margin*, dB	Verdict
		Without ALC	With ALC				
Downlink transmit mode							
851.0	Base	31.70	32.24	32.24	37.0	-4.76	Pass
856.0	Base	32.46	32.49	32.49	37.0	-4.51	Pass
861.0	Base	31.87	32.00	32.00	37.0	-5.00	Pass
Uplink transmit mode							
806.0	Mobile	26.94	26.94	26.94	37.0	-10.06	Pass
811.0	Mobile	26.99	26.67	26.99	37.0	-10.01	Pass
816.0	Mobile	26.04	26.20	26.20	37.0	-10.80	Pass

* - Margin = Maximum ERP – specification limit

** - There are no specific antennas supplied as a part of the unit that is why the maximum antenna assembly gain in dBd shall not exceed the power margin in dB.

Antenna Assembly Gain (dBd) = Antenna Gain (dBd) – Feeder Loss (dB) = Antenna Gain (dBi) – 2.15 – Feeder Loss (dB)

Note: Output power = Maximum value from SA reading (Without ALC or With ALC)

Test specification:		Section 90.219(e)(1), Maximum output power	
Test procedure:		47 CFR, Section 2.1046; KDB 935210 D02 v02, Appendix D	
Test mode:		Compliance	
Date(s):		03-Aug-14 - 07-Aug-14	
Temperature: 23.2 °C		Air Pressure: 1004 hPa	
		Relative Humidity: 44 %	
		Power Supply: 120 VAC	
Remarks:			

Table 7.1.3 Peak output power test results

DETECTOR USED: Average
 RESOLUTION BANDWIDTH: 1 kHz
 VIDEO BANDWIDTH: 10 kHz
 MODULATING SIGNAL: iDEN QAM
 CONFIGURATION: Single Band

OPERATING FREQUENCY RANGE: 758 - 775 MHz (downlink)
 788 - 805 MHz (uplink)

Carrier frequency, MHz	Input port	SA reading, dBm		Output power**, dBm	Limit, dBm	Margin*, dB	Verdict
		Without ALC	With ALC				
Downlink transmit mode							
758.0	Base	28.03	28.17	28.17	37.0	-8.83	Pass
766.0	Base	29.60	29.33	29.60	37.0	-7.40	Pass
775.0	Base	29.23	29.26	29.26	37.0	-7.74	Pass
Uplink transmit mode							
788.0	Mobile	24.10	25.53	25.53	37.0	-11.47	Pass
796.0	Mobile	26.10	28.31	28.31	37.0	-8.69	Pass
805.0	Mobile	26.77	28.55	28.55	37.0	-8.45	Pass

OPERATING FREQUENCY RANGE: 861 MHz (downlink)
 816 MHz (uplink)

Carrier frequency, MHz	Input port	SA reading, dBm		Output power**, dBm	Limit, dBm	Margin*, dB	Verdict
		Without ALC	With ALC				
Downlink transmit mode							
851.0	Base	29.58	29.26	29.58	37.0	-7.42	Pass
856.0	Base	29.25	29.62	29.62	37.0	-7.38	Pass
861.0	Base	29.35	29.39	29.39	37.0	-7.61	Pass
Uplink transmit mode							
806.0	Mobile	25.97	27.86	27.86	37.0	-9.14	Pass
811.0	Mobile	26.25	27.97	27.97	37.0	-9.03	Pass
816.0	Mobile	24.19	25.83	25.83	37.0	-11.17	Pass

* - Margin = Maximum ERP – specification limit

** - There are no specific antennas supplied as a part of the unit that is why the maximum antenna assembly gain in dBd shall not exceed the power margin in dB.

Antenna Assembly Gain (dBd) = Antenna Gain (dBd) – Feeder Loss (dB) = Antenna Gain (dBi) – 2.15 – Feeder Loss (dB)

Note: Output power = Maximum value from SA reading (Without ALC or With ALC)



Test specification:		Section 90.219(e)(1), Maximum output power	
Test procedure:		47 CFR, Section 2.1046; KDB 935210 D02 v02, Appendix D	
Test mode:		Compliance	
Date(s):		03-Aug-14 - 07-Aug-14	
Temperature: 23.2 °C		Air Pressure: 1004 hPa	
		Relative Humidity: 44 %	
		Power Supply: 120 VAC	
Remarks:			
Verdict: PASS			

Table 7.1.4 Peak output power test results

DETECTOR USED: Average
RESOLUTION BANDWIDTH: 1 MHz
VIDEO BANDWIDTH: 3 MHz
MODULATING SIGNAL: Analog FM 10.0 kHz/1 kHz
CONFIGURATION: Single Band

OPERATING FREQUENCY RANGE: 758 - 775 MHz (downlink)
788 - 805 MHz (uplink)

Carrier frequency, MHz	Input port	SA reading, dBm		Output power**, dBm	Limit, dBm	Margin*, dB	Verdict
		Without ALC	With ALC				
Downlink transmit mode							
758.0	Base	31.80	32.05	32.05	37.0	-4.95	Pass
766.0	Base	32.34	32.44	32.44	37.0	-4.56	Pass
775.0	Base	32.06	32.04	32.06	37.0	-4.94	Pass
Uplink transmit mode							
788.0	Mobile	26.31	26.46	26.46	37.0	-10.54	Pass
796.0	Mobile	26.98	27.06	27.06	37.0	-9.94	Pass
805.0	Mobile	26.77	26.82	26.82	37.0	-10.18	Pass

OPERATING FREQUENCY RANGE: 851 - 861 MHz (downlink)
806 - 816 MHz (uplink)

Carrier frequency, MHz	Input port	SA reading, dBm		Output power**, dBm	Limit, dBm	Margin*, dB	Verdict
		Without ALC	With ALC				
Downlink transmit mode							
851.0	Base	32.06	32.04	32.06	37.0	-4.94	Pass
856.0	Base	32.40	32.44	32.44	37.0	-4.56	Pass
861.0	Base	32.17	32.12	32.17	37.0	-4.83	Pass
Uplink transmit mode							
806.0	Mobile	26.94	27.05	27.05	37.0	-9.95	Pass
811.0	Mobile	26.56	26.66	26.66	37.0	-10.34	Pass
816.0	Mobile	25.85	26.15	26.15	37.0	-10.85	Pass

* - Margin = Maximum ERP – specification limit

** - There are no specific antennas supplied as a part of the unit that is why the maximum antenna assembly gain in dBd shall not exceed the power margin in dB.

Antenna Assembly Gain (dBd) = Antenna Gain (dBd) – Feeder Loss (dB) = Antenna Gain (dBi) – 2.15 – Feeder Loss (dB)

Note: Output power = Maximum value from SA reading (Without ALC or With ALC)

Reference numbers of test equipment used

HL 2909	HL 3768	HL 3770	HL 3776	HL 3818	HL 4224	HL 4273	HL 4274
---------	---------	---------	---------	---------	---------	---------	---------

Full description is given in Appendix A.

Test specification:		Section 90.219(e)(1), Maximum output power	
Test procedure:		47 CFR, Section 2.1046; KDB 935210 D02 v02, Appendix D	
Test mode:		Compliance	
Date(s):		03-Aug-14 - 07-Aug-14	
Temperature: 23.2 °C		Air Pressure: 1004 hPa	
		Relative Humidity: 44 %	
		Power Supply: 120 VAC	
Remarks:			

Plot 7.1.1 RF output power measurements at low frequency carrier, Port 1

FRQUENCY RANGE:
OPERATIONAL MODE:
CONFIGURATION:
INPUT PORT:
INPUT POWER: -54 dBm

758 - 775 MHz
C4FM downlink transmit
Dual Band
Base
INPUT POWER: -24 dBm

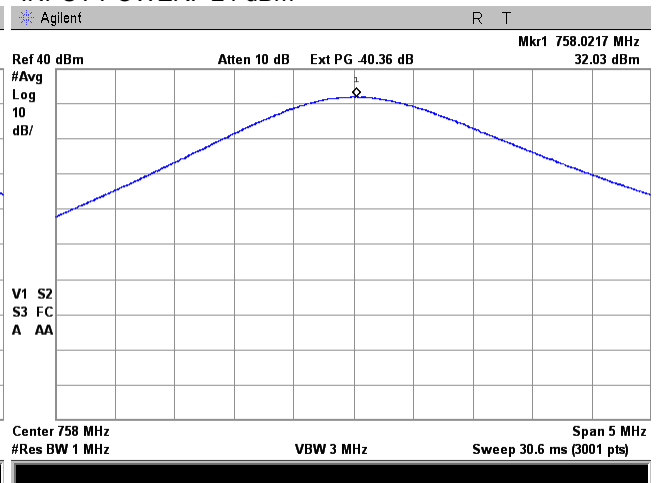
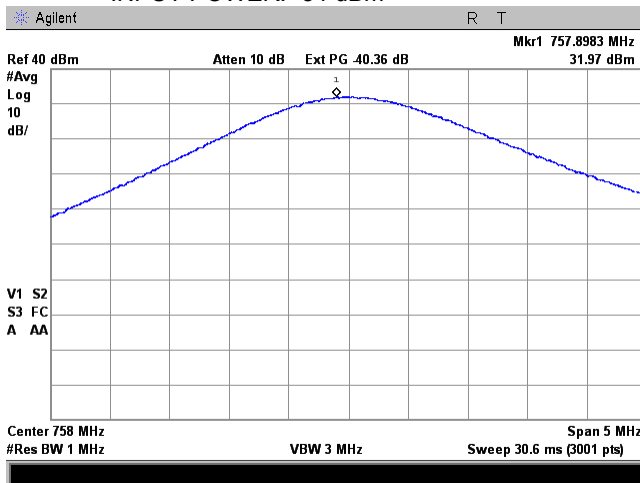

Plot 7.1.2 RF output power measurements at mid frequency carrier, Port 1

FRQUENCY RANGE:
OPERATIONAL MODE:
CONFIGURATION:
INPUT PORT:
INPUT POWER: -54 dBm

758 - 775 MHz
C4FM downlink transmit
Dual Band
Base
INPUT POWER: -24 dBm

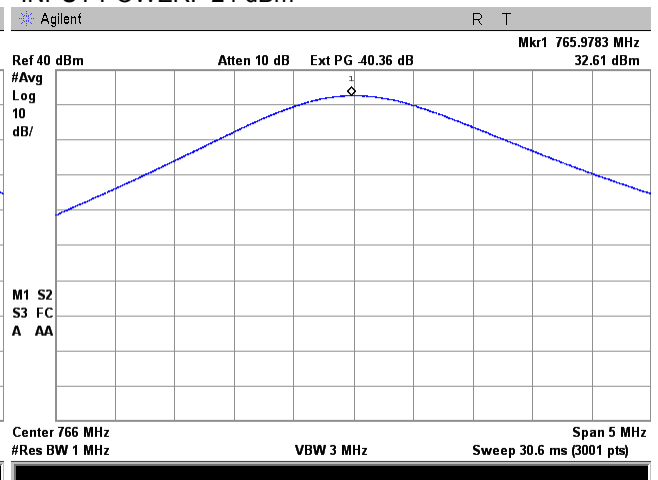
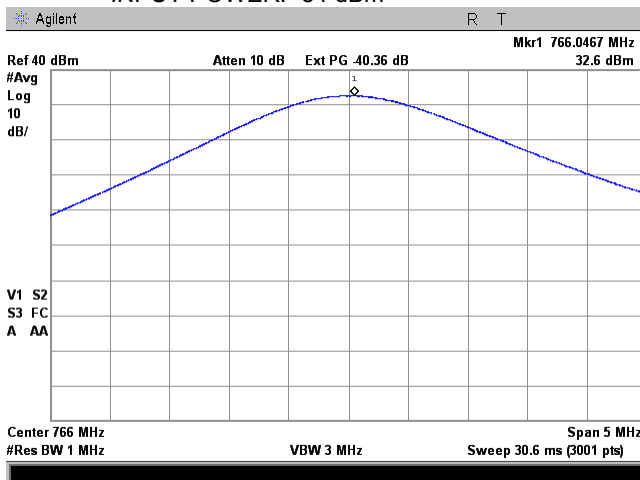

Test specification: Section 90.219(e)(1), Maximum output power			
Test procedure: 47 CFR, Section 2.1046; KDB 935210 D02 v02, Appendix D			
Test mode: Compliance			Verdict: PASS
Date(s): 03-Aug-14 - 07-Aug-14			
Temperature: 23.2 °C	Air Pressure: 1004 hPa	Relative Humidity: 44 %	Power Supply: 120 VAC
Remarks:			

Plot 7.1.3 RF output power measurements at high frequency carrier, Port 1

FRQUENCY RANGE:
OPERATIONAL MODE:
CONFIGURATION:
INPUT PORT:
INPUT POWER: -54 dBm

758 - 775 MHz
C4FM downlink transmit
Dual Band
Base
INPUT POWER: -24 dBm

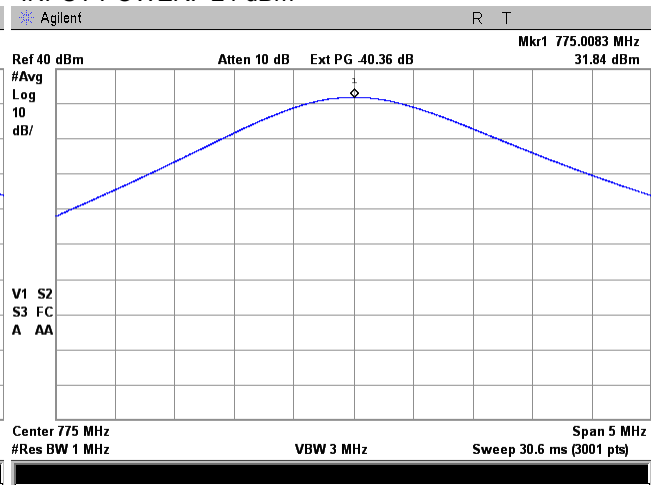
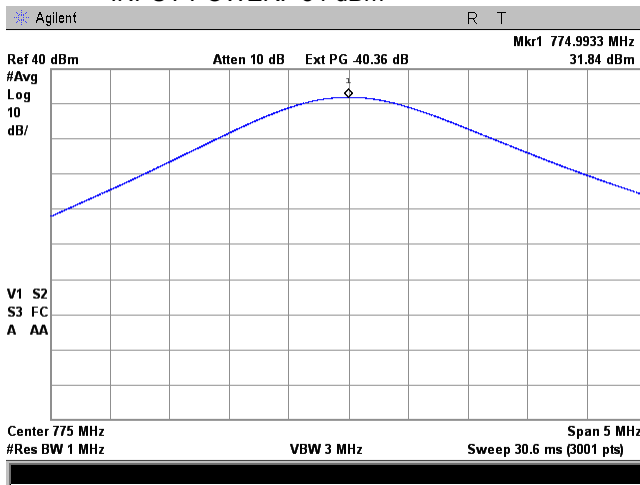

Plot 7.1.4 RF output power measurements at low frequency carrier, Port 2

FRQUENCY RANGE:
OPERATIONAL MODE:
CONFIGURATION:
INPUT PORT:
INPUT POWER: -54 dBm

788 - 805 MHz
C4FM uplink transmit
Dual Band
Mobile
INPUT POWER: -24 dBm

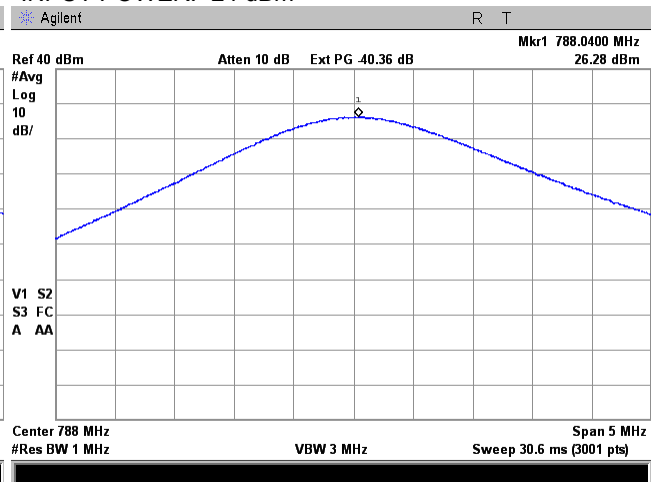
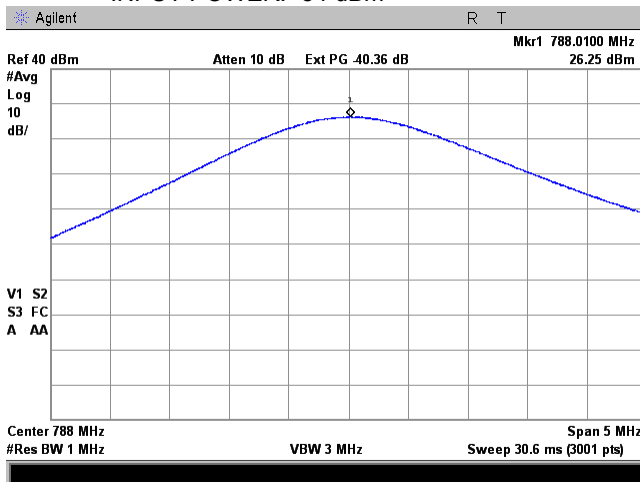

Test specification: Section 90.219(e)(1), Maximum output power	
Test procedure: 47 CFR, Section 2.1046; KDB 935210 D02 v02, Appendix D	
Test mode: Compliance	Verdict: PASS
Date(s): 03-Aug-14 - 07-Aug-14	
Temperature: 23.2 °C	Air Pressure: 1004 hPa
	Relative Humidity: 44 %
	Power Supply: 120 VAC
Remarks:	

Plot 7.1.5 RF output power measurements at mid frequency carrier, Port 2

FRQUENCY RANGE:
OPERATIONAL MODE:
CONFIGURATION:
INPUT PORT:
INPUT POWER: -54 dBm

788 - 805 MHz
C4FM uplink transmit
Dual Band
Mobile
INPUT POWER: -24 dBm

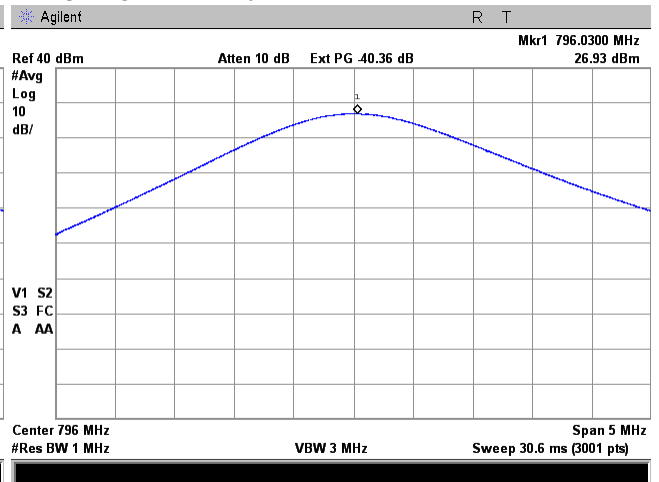
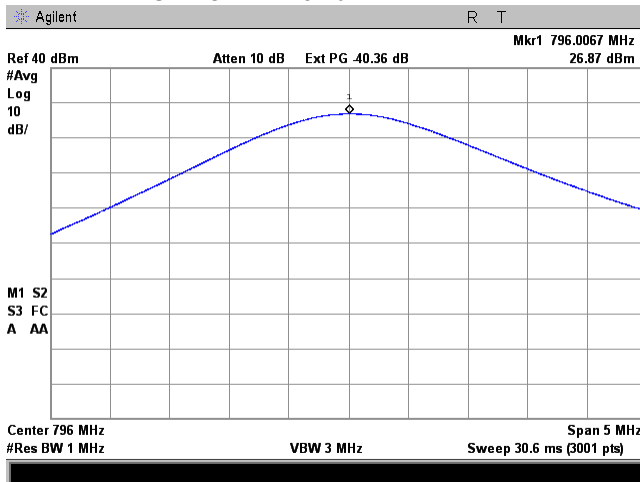

Plot 7.1.6 RF output power measurements at high frequency carrier, Port 2

FRQUENCY RANGE:
OPERATIONAL MODE:
CONFIGURATION:
INPUT PORT:
INPUT POWER: -54 dBm

788 - 805 MHz
C4FM uplink transmit
Dual Band
Mobile
INPUT POWER: -24 dBm

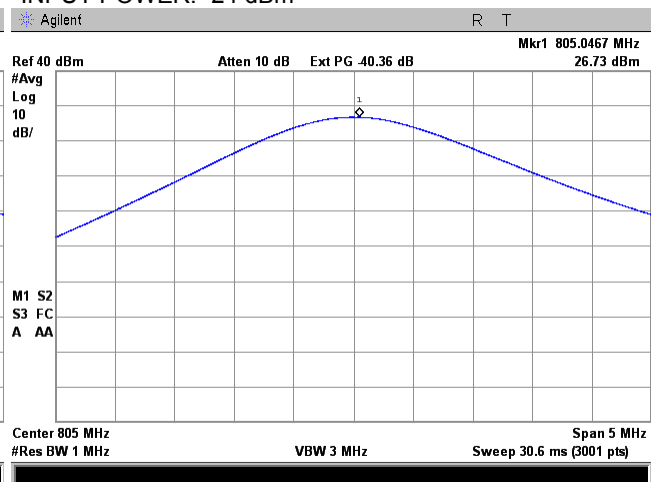
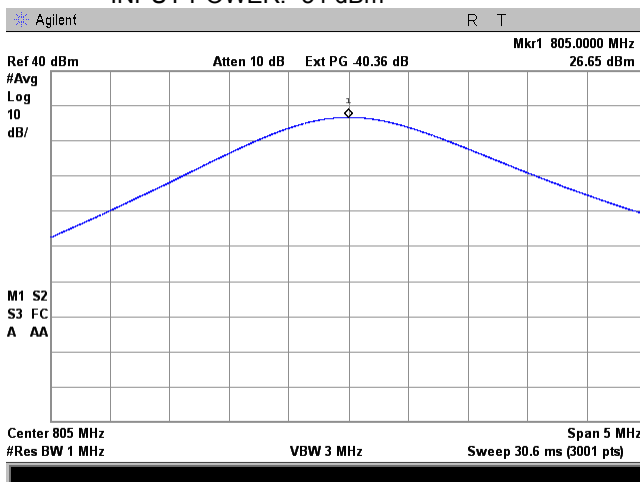

Test specification:		Section 90.219(e)(1), Maximum output power	
Test procedure:		47 CFR, Section 2.1046; KDB 935210 D02 v02, Appendix D	
Test mode:		Verdict:	
Compliance		PASS	
Date(s):		03-Aug-14 - 07-Aug-14	
Temperature: 23.2 °C	Air Pressure: 1004 hPa	Relative Humidity: 44 %	Power Supply: 120 VAC
Remarks:			

Plot 7.1.7 RF output power measurements at low frequency carrier, Port 1

FRQUENCY RANGE:
OPERATIONAL MODE:
CONFIGURATION:
INPUT PORT:
INPUT POWER: -54 dBm

851 - 861 MHz
C4FM downlink transmit
Dual Band
Mobile
INPUT POWER: -24 dBm

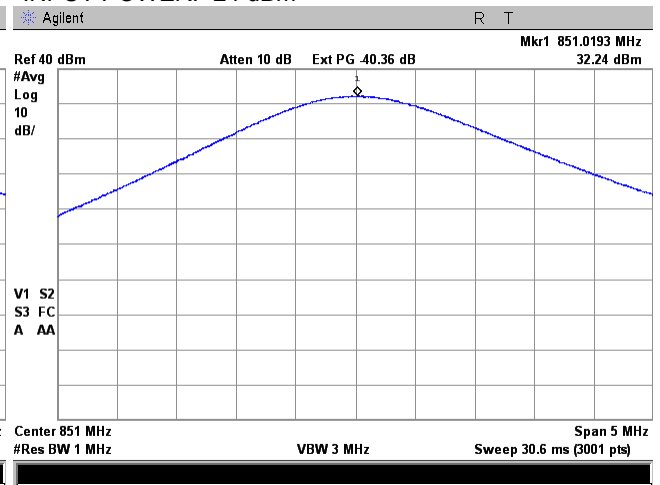
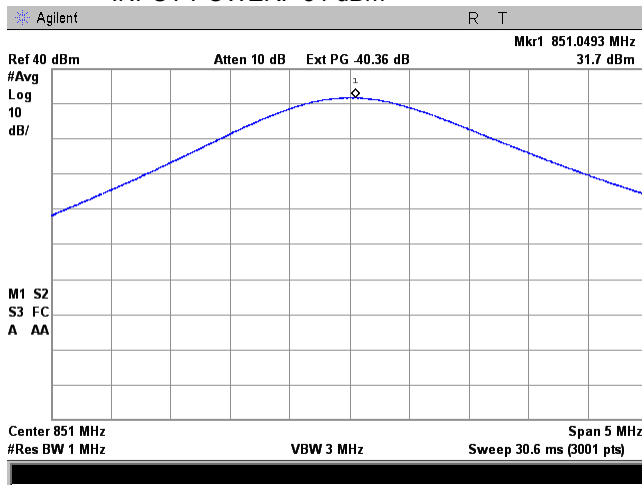

Plot 7.1.8 RF output power measurements at mid frequency carrier, Port 1

FRQUENCY RANGE:
OPERATIONAL MODE:
CONFIGURATION:
INPUT PORT:
INPUT POWER: -54 dBm

851 - 861 MHz
C4FM downlink transmit
Dual Band
Mobile
INPUT POWER: -24 dBm

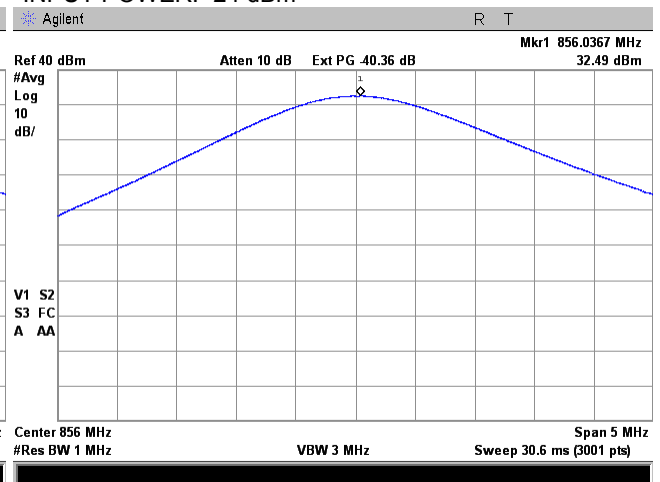
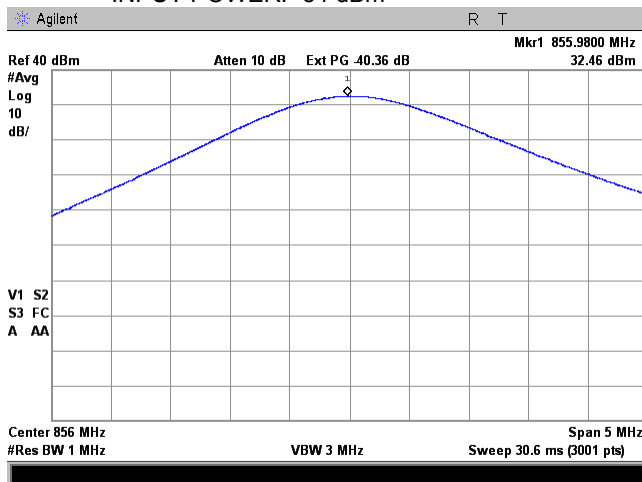

Test specification: Section 90.219(e)(1), Maximum output power			
Test procedure: 47 CFR, Section 2.1046; KDB 935210 D02 v02, Appendix D			
Test mode: Compliance		Verdict: PASS	
Date(s): 03-Aug-14 - 07-Aug-14			
Temperature: 23.2 °C	Air Pressure: 1004 hPa	Relative Humidity: 44 %	Power Supply: 120 VAC
Remarks:			

Plot 7.1.9 RF output power measurements at high frequency carrier, Port 1

FRQUENCY RANGE:
OPERATIONAL MODE:
CONFIGURATION:
INPUT PORT:
INPUT POWER: -51 dBm

851 - 861 MHz
C4FM downlink transmit
Dual Band
Mobile
INPUT POWER: -21 dBm

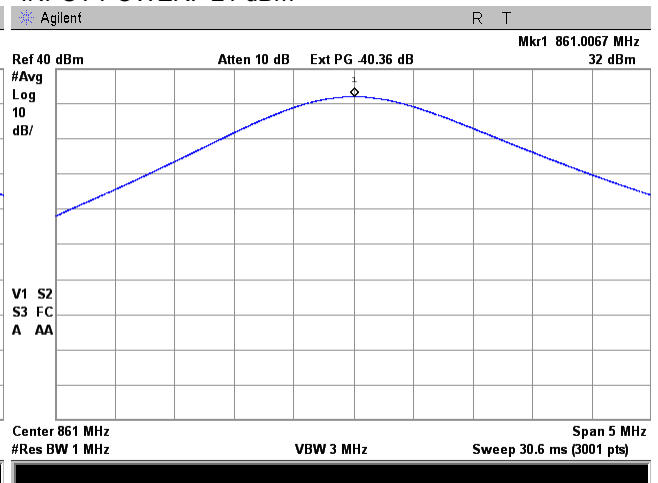
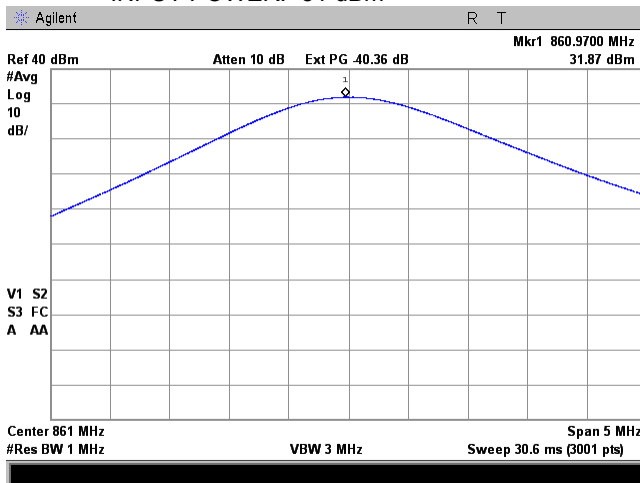

Plot 7.1.10 RF output power measurements at low frequency carrier, Port 2

FRQUENCY RANGE:
OPERATIONAL MODE:
CONFIGURATION:
INPUT PORT:
INPUT POWER: -54 dBm

806 - 816 MHz
C4FM uplink transmit
Dual Band
Base
INPUT POWER: -24 dBm

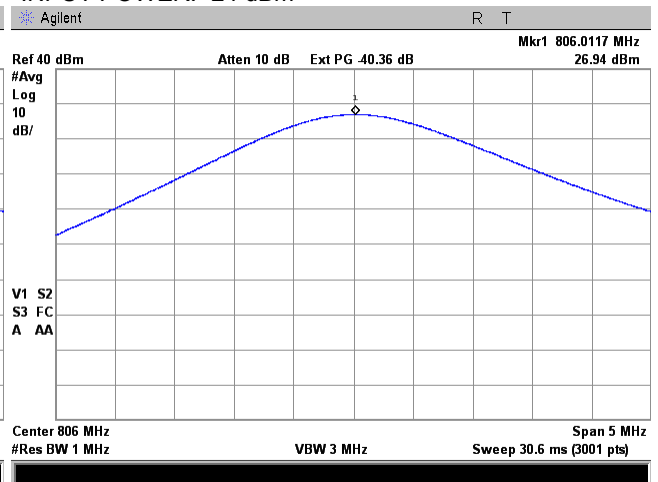
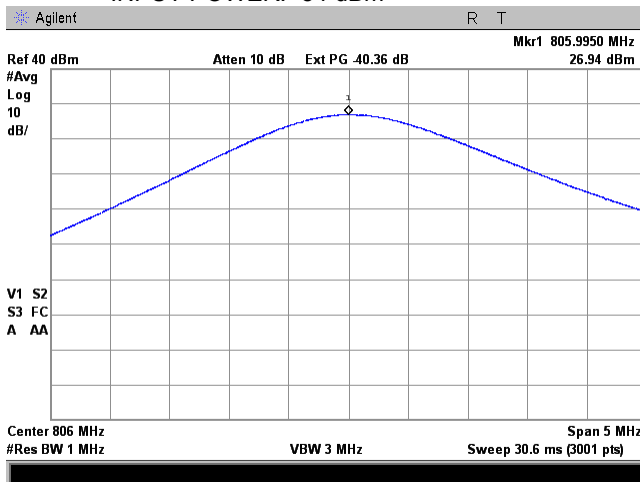

Test specification: Section 90.219(e)(1), Maximum output power			
Test procedure: 47 CFR, Section 2.1046; KDB 935210 D02 v02, Appendix D			
Test mode: Compliance	Verdict: PASS		
Date(s): 03-Aug-14 - 07-Aug-14			
Temperature: 23.2 °C	Air Pressure: 1004 hPa	Relative Humidity: 44 %	Power Supply: 120 VAC
Remarks:			

Plot 7.1.11 RF output power measurements at mid frequency carrier, Port 2

FRQUENCY RANGE:
OPERATIONAL MODE:
CONFIGURATION:
INPUT PORT:
INPUT POWER: -54 dBm

806 - 816 MHz
C4FM uplink transmit
Dual Band
Base
INPUT POWER: -24 dBm

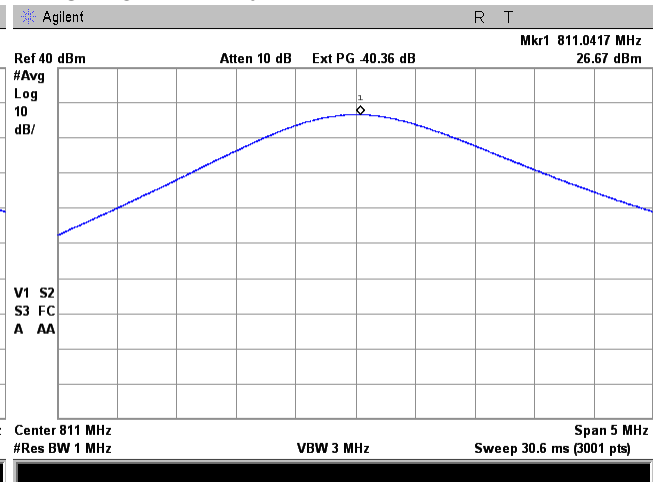
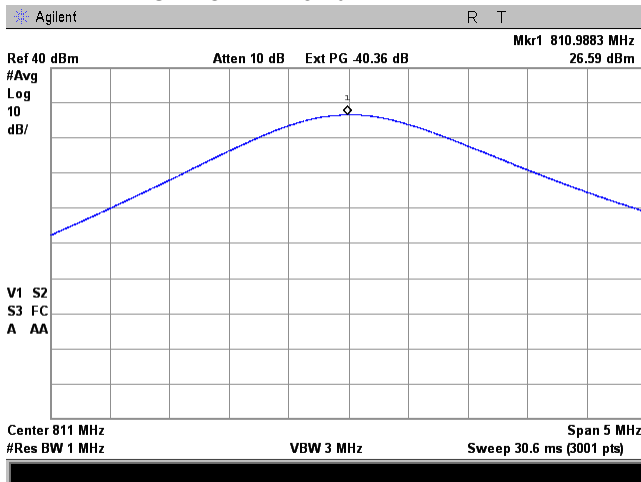

Plot 7.1.12 RF output power measurements at high frequency carrier, Port 2

FRQUENCY RANGE:
OPERATIONAL MODE:
CONFIGURATION:
INPUT PORT:
INPUT POWER: -54 dBm

806 - 816 MHz
C4FM uplink transmit
Dual Band
Base
INPUT POWER: -24 dBm

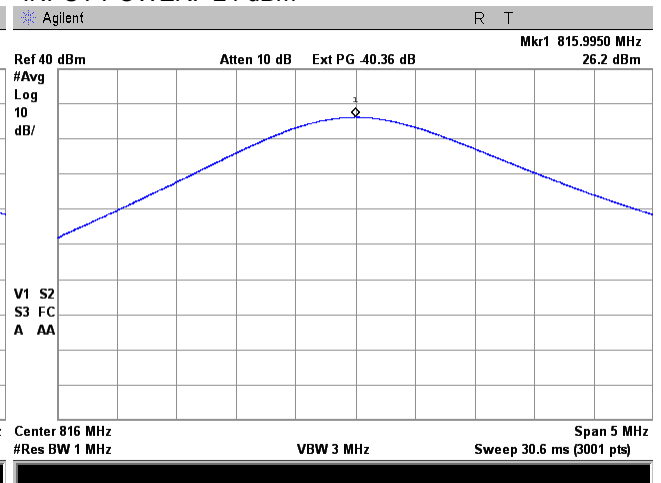
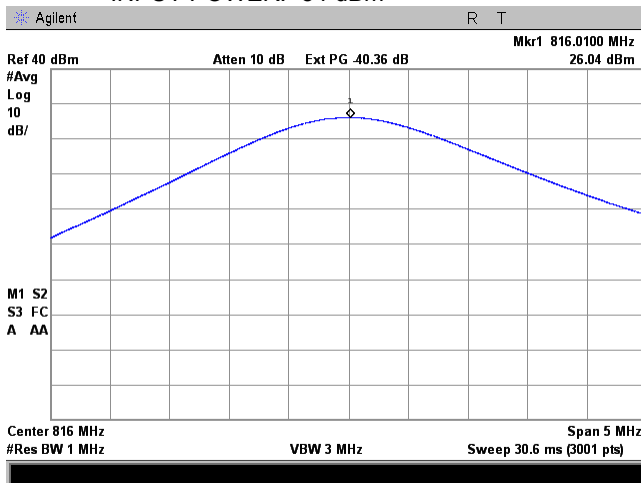

Test specification: Section 90.219(e)(1), Maximum output power			
Test procedure: 47 CFR, Section 2.1046; KDB 935210 D02 v02, Appendix D			
Test mode: Compliance	Verdict: PASS		
Date(s): 03-Aug-14 - 07-Aug-14			
Temperature: 23.2 °C	Air Pressure: 1004 hPa	Relative Humidity: 44 %	Power Supply: 120 VAC
Remarks:			

Plot 7.1.13 RF output power measurements at low frequency carrier, Port 1

FRQUENCY RANGE:
OPERATIONAL MODE:
CONFIGURATION:
INPUT PORT:
INPUT POWER: -51 dBm

758 - 775 MHz
iDEN QAM downlink transmit
Dual Band
Mobile
INPUT POWER: -21 dBm

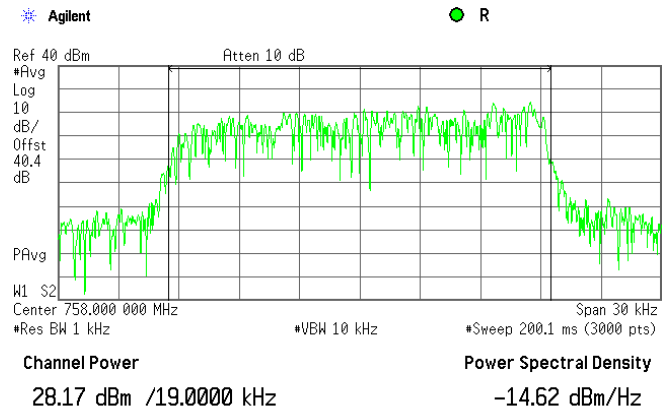
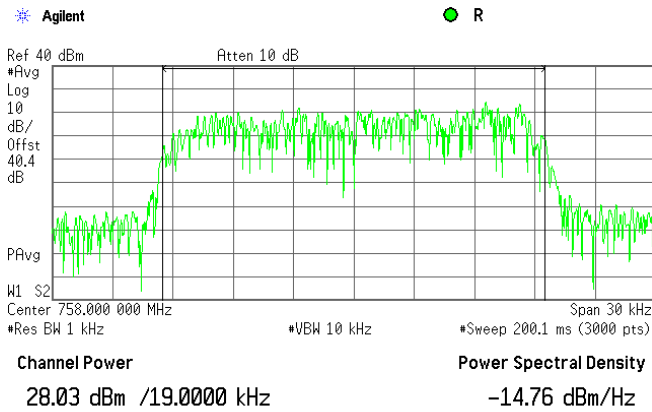

Plot 7.1.14 RF output power measurements at mid frequency carrier, Port 1

FRQUENCY RANGE:
OPERATIONAL MODE:
CONFIGURATION:
INPUT PORT:
INPUT POWER: -51 dBm

758 - 775 MHz
iDEN QAM downlink transmit
Dual Band
Mobile
INPUT POWER: -21 dBm

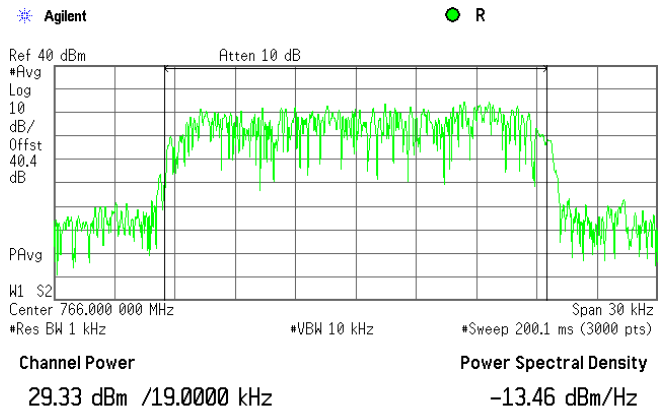
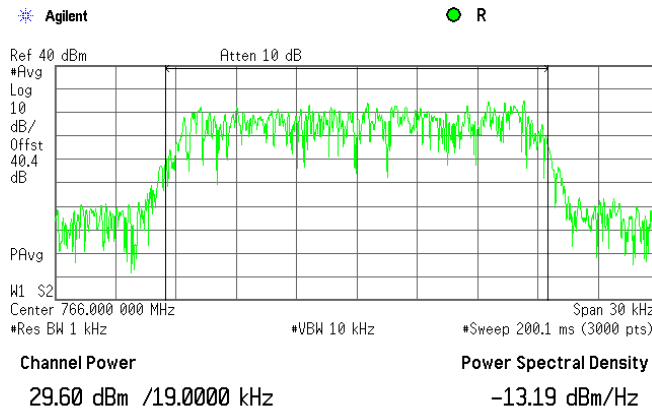

Test specification:		Section 90.219(e)(1), Maximum output power	
Test procedure:		47 CFR, Section 2.1046; KDB 935210 D02 v02, Appendix D	
Test mode:		Compliance	
Date(s):		03-Aug-14 - 07-Aug-14	
Temperature: 23.2 °C		Air Pressure: 1004 hPa	
		Relative Humidity: 44 %	
		Power Supply: 120 VAC	
Remarks:			
		Verdict: PASS	

Plot 7.1.15 RF output power measurements at high frequency carrier, Port 1

FRQUENCY RANGE:
OPERATIONAL MODE:
CONFIGURATION:
INPUT PORT:
INPUT POWER: -51 dBm

758 - 775 MHz
iDEN QAM downlink transmit
Dual Band
Mobile
INPUT POWER: -21 dBm

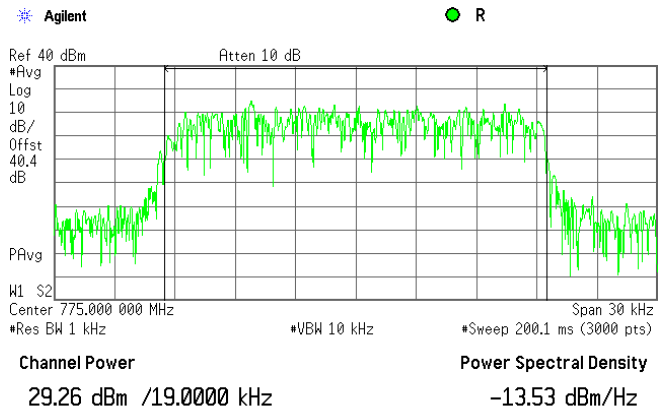
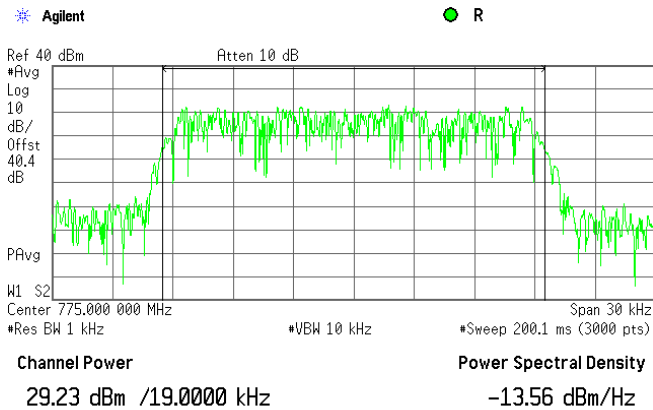

Plot 7.1.16 RF output power measurements at low frequency carrier, Port 2

FRQUENCY RANGE:
OPERATIONAL MODE:
CONFIGURATION:
INPUT PORT:
INPUT POWER: -51 dBm

788 - 805 MHz
iDEN QAM uplink transmit
Dual Band
Base
INPUT POWER: -21 dBm

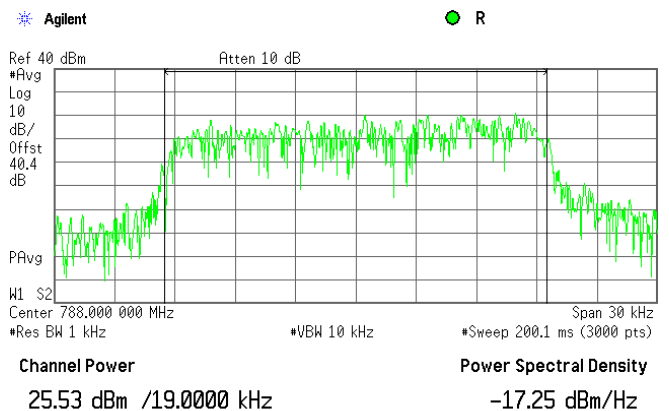
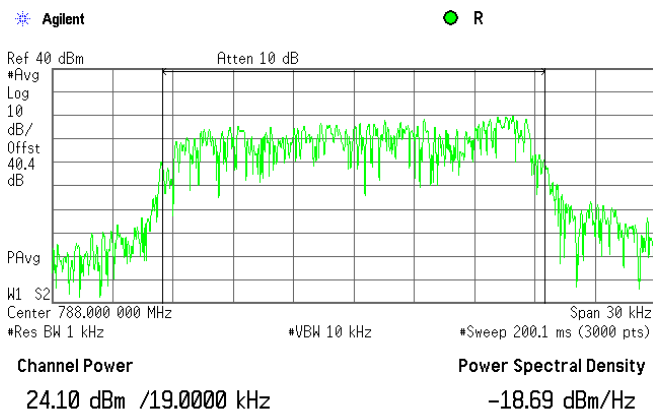

Test specification: Section 90.219(e)(1), Maximum output power			
Test procedure: 47 CFR, Section 2.1046; KDB 935210 D02 v02, Appendix D			
Test mode: Compliance	Verdict: PASS		
Date(s): 03-Aug-14 - 07-Aug-14			
Temperature: 23.2 °C	Air Pressure: 1004 hPa	Relative Humidity: 44 %	Power Supply: 120 VAC
Remarks:			

Plot 7.1.17 RF output power measurements at mid frequency carrier, Port 2

FRQUENCY RANGE:
OPERATIONAL MODE:
CONFIGURATION:
INPUT PORT:
INPUT POWER: -51 dBm

788 - 805 MHz
iDEN QAM uplink transmit
Dual Band
Base
INPUT POWER: -21 dBm

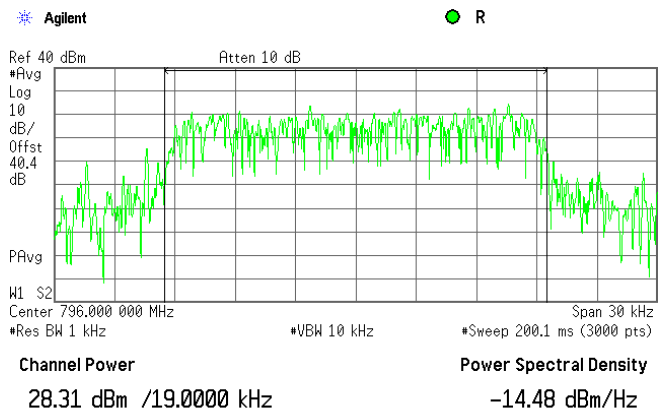
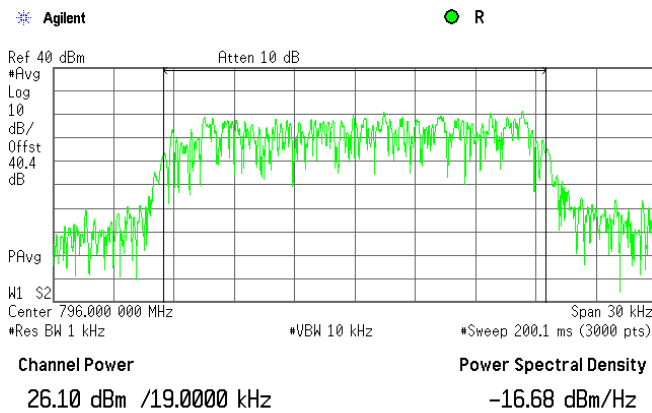

Plot 7.1.18 RF output power measurements at high frequency carrier, Port 2

FRQUENCY RANGE:
OPERATIONAL MODE:
CONFIGURATION:
INPUT PORT:
COMPOSITE INPUT POWER: -51 dBm

788 - 805 MHz
iDEN QAM uplink transmit
Dual Band
Base
COMPOSITE INPUT POWER: -21 dBm

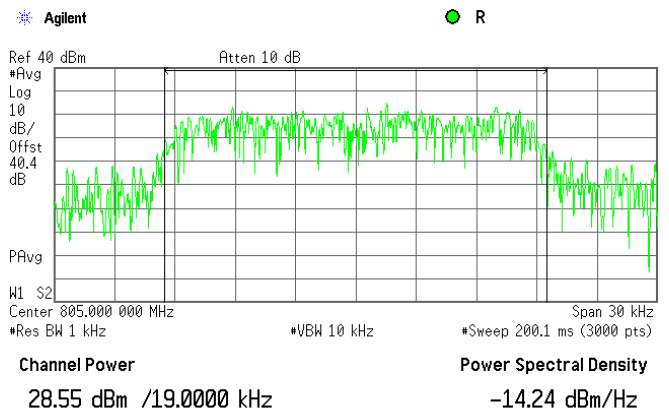
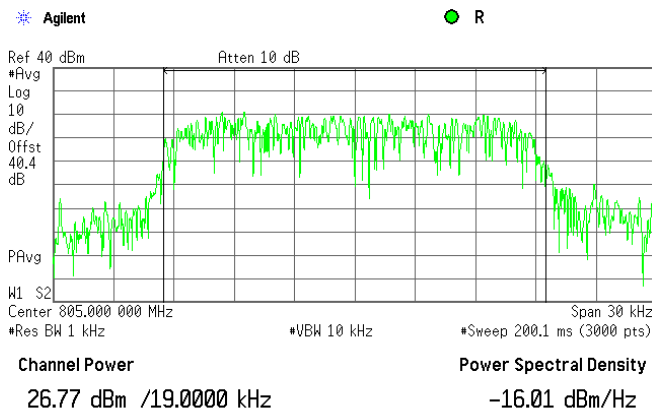

Test specification:		Section 90.219(e)(1), Maximum output power	
Test procedure:		47 CFR, Section 2.1046; KDB 935210 D02 v02, Appendix D	
Test mode:		Compliance	
Date(s):		03-Aug-14 - 07-Aug-14	
Temperature: 23.2 °C		Air Pressure: 1004 hPa	
		Relative Humidity: 44 %	
		Power Supply: 120 VAC	
Remarks:			
Verdict: PASS			

Plot 7.1.19 RF output power measurements at low frequency carrier, Port 1

FRQUENCY RANGE:
OPERATIONAL MODE:
CONFIGURATION:
INPUT PORT:
INPUT POWER: -51 dBm

851 - 861 MHz
iDEN QAM downlink transmit
Dual Band
Mobile
INPUT POWER: -21dBm

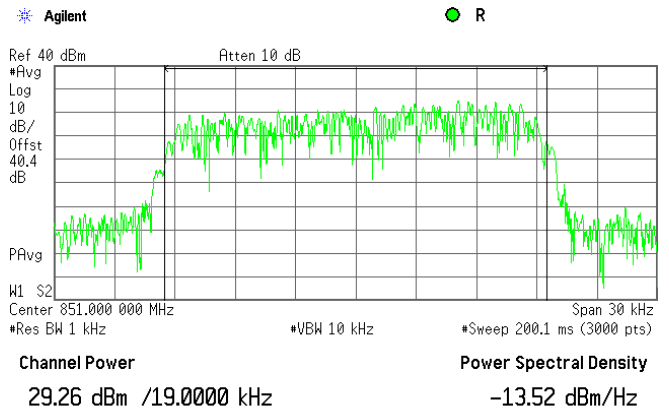
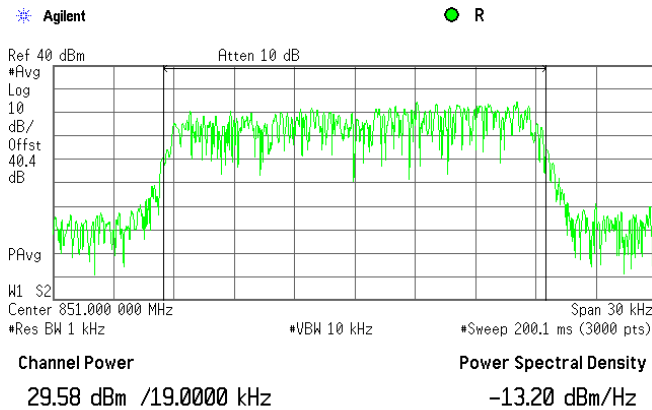

Plot 7.1.20 RF output power measurements at mid frequency carrier, Port 1

FRQUENCY RANGE:
OPERATIONAL MODE:
CONFIGURATION:
INPUT PORT:
INPUT POWER: -51 dBm

851 - 861 MHz
iDEN QAM downlink transmit
Dual Band
Mobile
INPUT POWER: -21 dBm

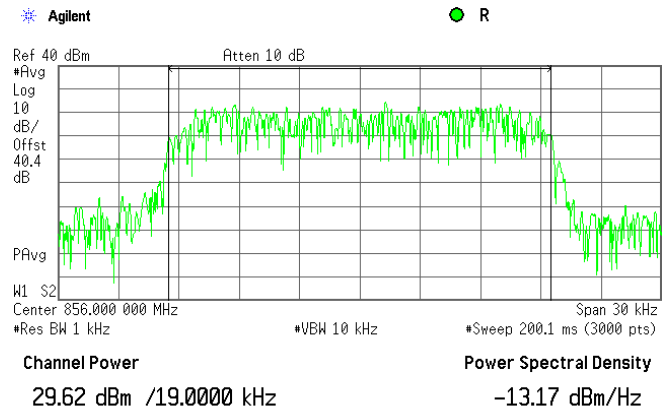
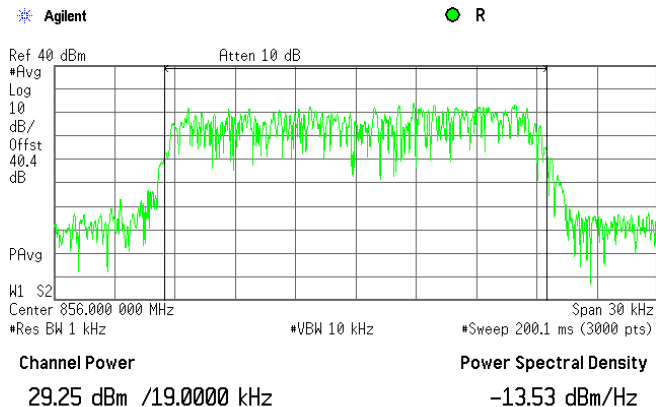

Test specification:		Section 90.219(e)(1), Maximum output power	
Test procedure:		47 CFR, Section 2.1046; KDB 935210 D02 v02, Appendix D	
Test mode:		Compliance	
Date(s):		03-Aug-14 - 07-Aug-14	
Temperature: 23.2 °C		Air Pressure: 1004 hPa	
		Relative Humidity: 44 %	
		Power Supply: 120 VAC	
Remarks:			

Plot 7.1.21 RF output power measurements at high frequency carrier, Port 1

FRQUENCY RANGE:
OPERATIONAL MODE:
CONFIGURATION:
INPUT PORT:
INPUT POWER: -51 dBm

851 - 861 MHz
iDEN QAM downlink transmit
Dual Band
Mobile
INPUT POWER: -21 dBm

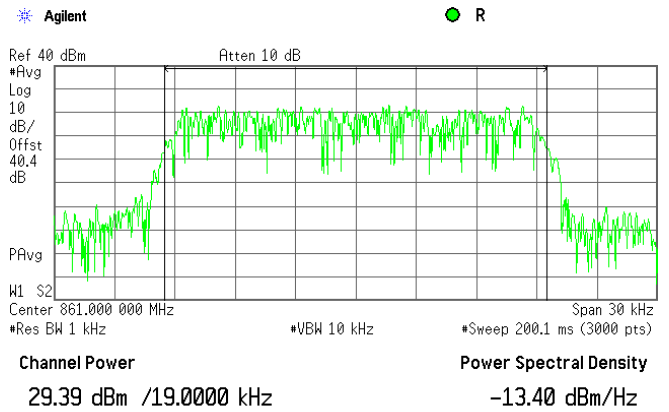
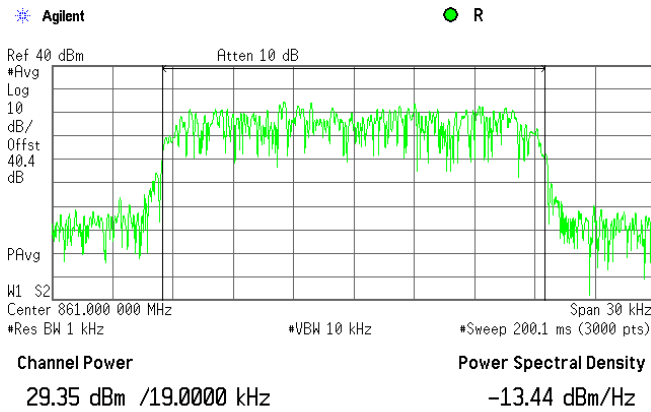

Plot 7.1.22 RF output power measurements at low frequency carrier, Port 2

FRQUENCY RANGE:
OPERATIONAL MODE:
CONFIGURATION:
INPUT PORT:
INPUT POWER: -51 dBm

806 - 816 MHz
iDEN QAM uplink transmit
Dual Band
Base
INPUT POWER: -21 dBm

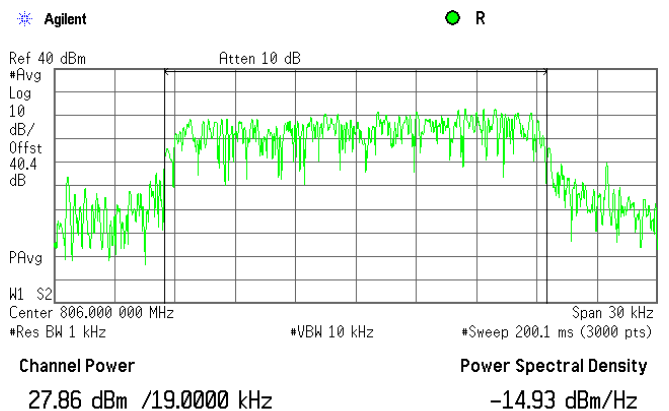
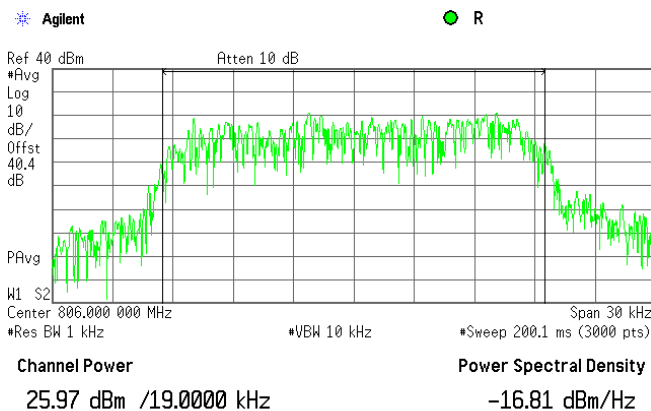

Test specification:		Section 90.219(e)(1), Maximum output power	
Test procedure:		47 CFR, Section 2.1046; KDB 935210 D02 v02, Appendix D	
Test mode:		Compliance	
Date(s):		03-Aug-14 - 07-Aug-14	
Temperature: 23.2 °C		Air Pressure: 1004 hPa	
		Relative Humidity: 44 %	
		Power Supply: 120 VAC	
Remarks:			
		Verdict: PASS	

Plot 7.1.23 RF output power measurements at mid frequency carrier, Port 2

FRQUENCY RANGE:
OPERATIONAL MODE:
CONFIGURATION:
INPUT PORT:
INPUT POWER: -51 dBm

806 - 816 MHz
iDEN QAM uplink transmit
Dual Band
Base
INPUT POWER: -21 dBm

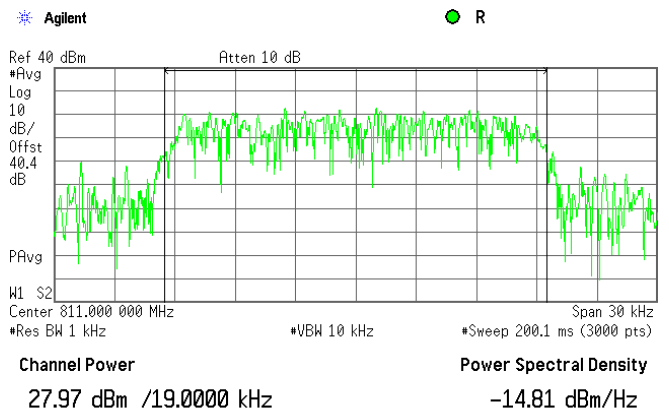
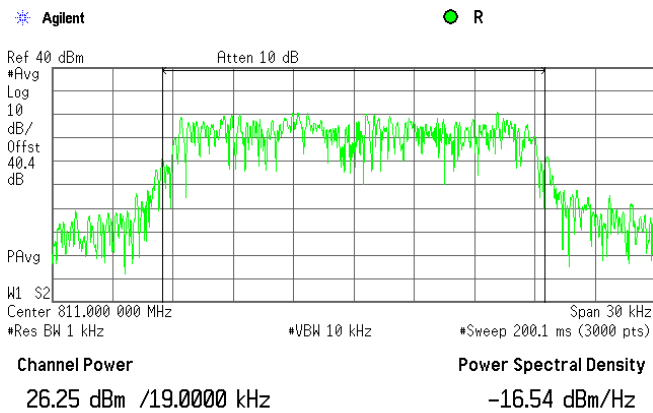

Plot 7.1.24 RF output power measurements at high frequency carrier, Port 2

FRQUENCY RANGE:
OPERATIONAL MODE:
CONFIGURATION:
INPUT PORT:
INPUT POWER: -51 dBm

806 - 816 MHz
iDEN QAM uplink transmit
Dual Band
Base
INPUT POWER: -21 dBm

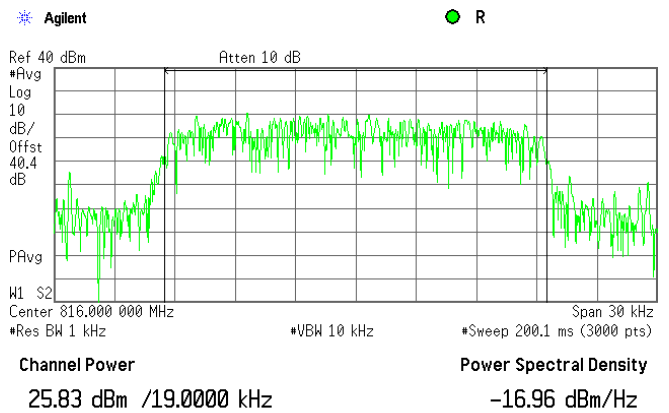
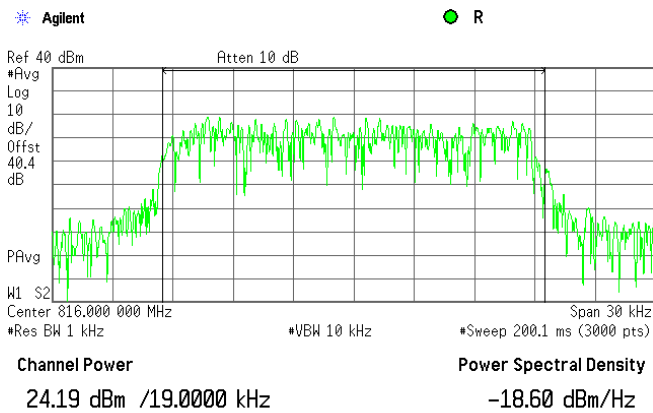

Test specification:		Section 90.219(e)(1), Maximum output power	
Test procedure:		47 CFR, Section 2.1046; KDB 935210 D02 v02, Appendix D	
Test mode:		Verdict:	
Compliance		PASS	
Date(s):		03-Aug-14 - 07-Aug-14	
Temperature: 23.2 °C	Air Pressure: 1004 hPa	Relative Humidity: 44 %	Power Supply: 120 VAC
Remarks:			

Plot 7.1.25 RF output power measurements at low frequency carrier, Port 1

FRQUENCY RANGE:
OPERATIONAL MODE:
CONFIGURATION:
INPUT PORT:
INPUT POWER: -50 dBm

758 - 775 MHz
Analog FM downlink transmit
Dual Band
Base
INPUT POWER: -20 dBm

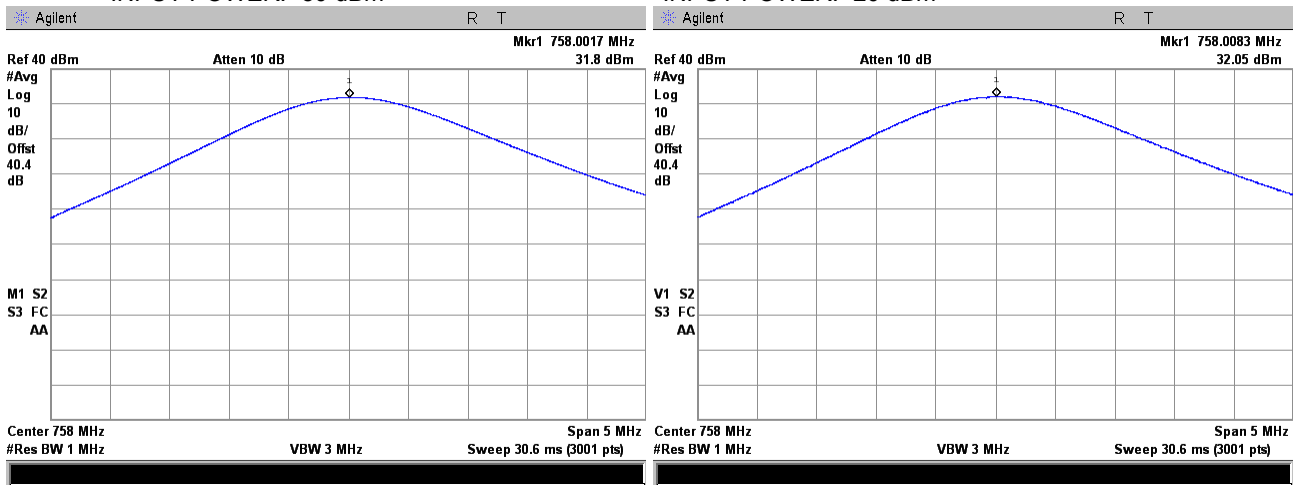

Plot 7.1.26 RF output power measurements at mid frequency carrier, Port 1

FRQUENCY RANGE:
OPERATIONAL MODE:
CONFIGURATION:
INPUT PORT:
INPUT POWER: -50 dBm

758 - 775 MHz
Analog FM downlink transmit
Dual Band
Base
INPUT POWER: -20 dBm

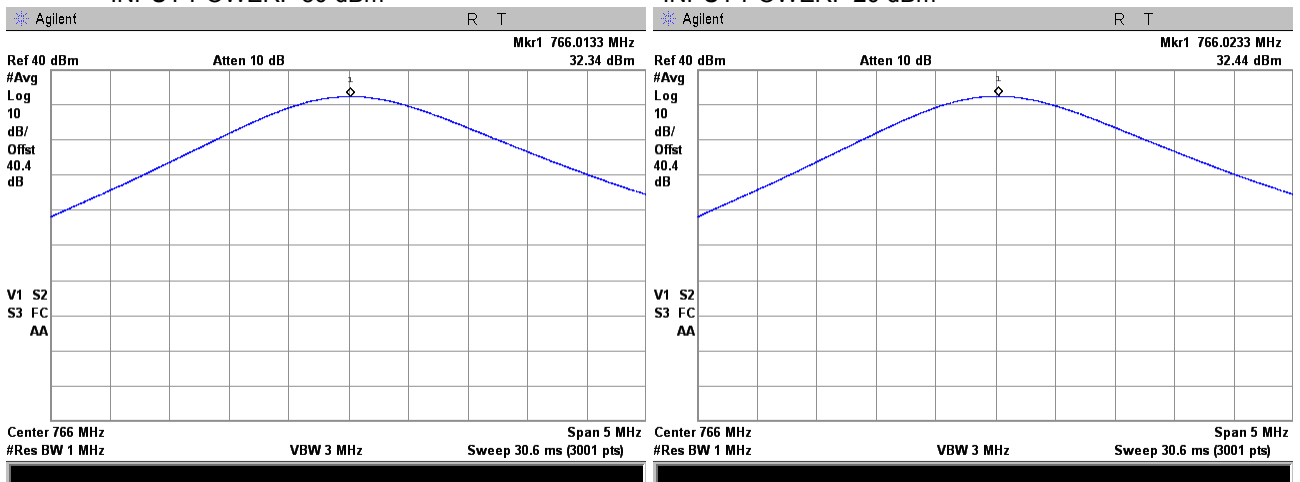

Test specification: Section 90.219(e)(1), Maximum output power			
Test procedure: 47 CFR, Section 2.1046; KDB 935210 D02 v02, Appendix D			
Test mode: Compliance			Verdict: PASS
Date(s): 03-Aug-14 - 07-Aug-14			
Temperature: 23.2 °C	Air Pressure: 1004 hPa	Relative Humidity: 44 %	Power Supply: 120 VAC
Remarks:			

Plot 7.1.27 RF output power measurements at high frequency carrier, Port 1

FRQUENCY RANGE:
OPERATIONAL MODE:
CONFIGURATION:
INPUT PORT:
INPUT POWER: -50 dBm

758 - 775 MHz
Analog FM downlink transmit
Dual Band
Base
INPUT POWER: -20 dBm

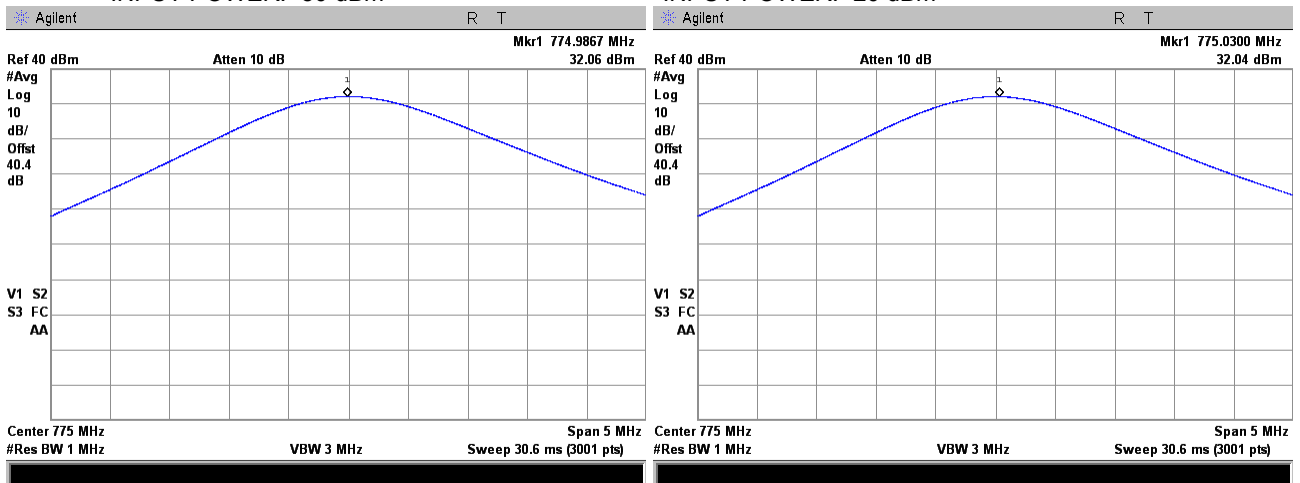

Plot 7.1.28 RF output power measurements at low frequency carrier, Port 2

FRQUENCY RANGE:
OPERATIONAL MODE:
CONFIGURATION:
INPUT PORT:
INPUT POWER: -54 dBm

788 - 805 MHz
Analog FM uplink transmit
Dual Band
Mobile
INPUT POWER: -24 dBm

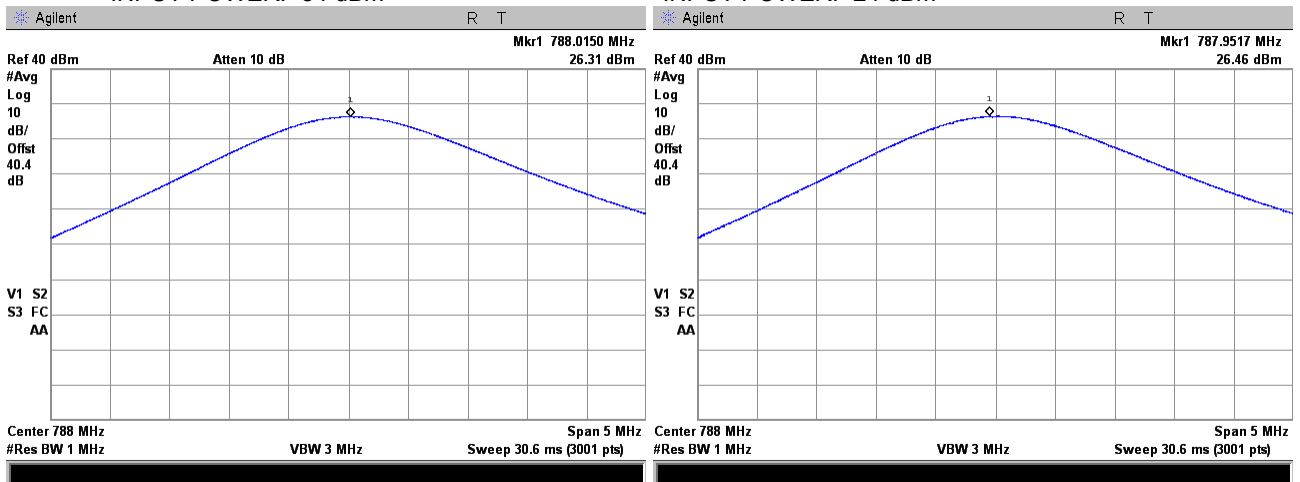

Test specification: Section 90.219(e)(1), Maximum output power	
Test procedure: 47 CFR, Section 2.1046; KDB 935210 D02 v02, Appendix D	
Test mode: Compliance	Verdict: PASS
Date(s): 03-Aug-14 - 07-Aug-14	
Temperature: 23.2 °C	Air Pressure: 1004 hPa
	Relative Humidity: 44 %
	Power Supply: 120 VAC
Remarks:	

Plot 7.1.29 RF output power measurements at mid frequency carrier, Port 2

FRQUENCY RANGE:
OPERATIONAL MODE:
CONFIGURATION:
INPUT PORT:
INPUT POWER: -54 dBm

788 - 805 MHz
Analog FM uplink transmit
Dual Band
Mobile
INPUT POWER: -24 dBm

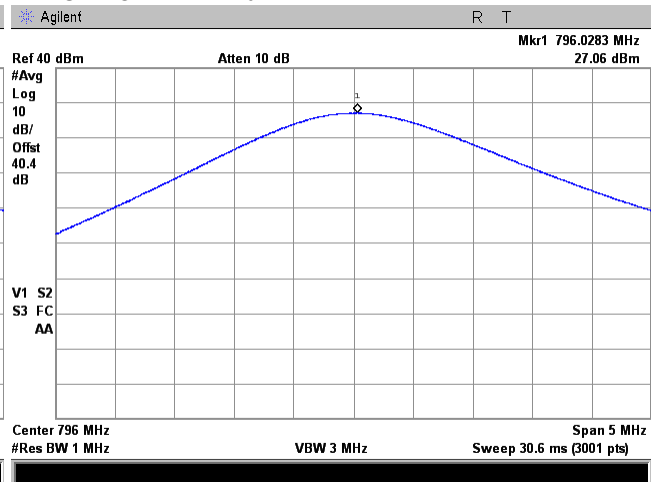
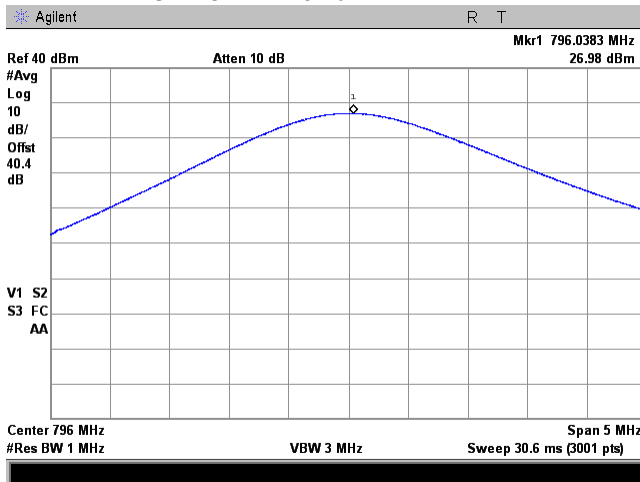

Plot 7.1.30 RF output power measurements at high frequency carrier, Port 2

FRQUENCY RANGE:
OPERATIONAL MODE:
CONFIGURATION:
INPUT PORT:
INPUT POWER: -54 dBm

788 - 805 MHz
Analog FM uplink transmit
Dual Band
Mobile
INPUT POWER: -24 dBm

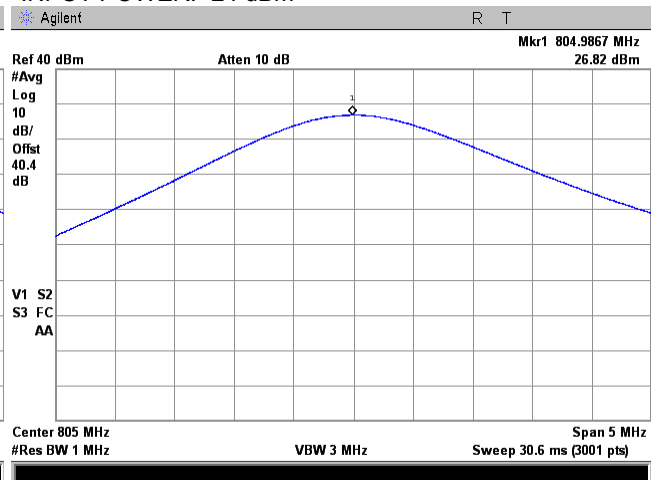
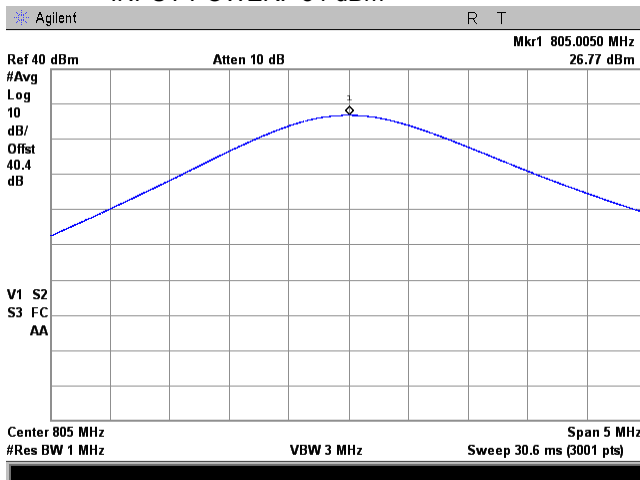

Test specification: Section 90.219(e)(1), Maximum output power	
Test procedure: 47 CFR, Section 2.1046; KDB 935210 D02 v02, Appendix D	
Test mode: Compliance	Verdict: PASS
Date(s): 03-Aug-14 - 07-Aug-14	
Temperature: 23.2 °C	Air Pressure: 1004 hPa
Relative Humidity: 44 %	
Power Supply: 120 VAC	
Remarks:	

Plot 7.1.31 RF output power measurements at low frequency carrier, Port 1

FRQUENCY RANGE:
OPERATIONAL MODE:
CONFIGURATION:
INPUT PORT:
INPUT POWER: -54 dBm

851 - 861 MHz
Analog FM downlink transmit
Dual Band
Base
INPUT POWER: -24 dBm

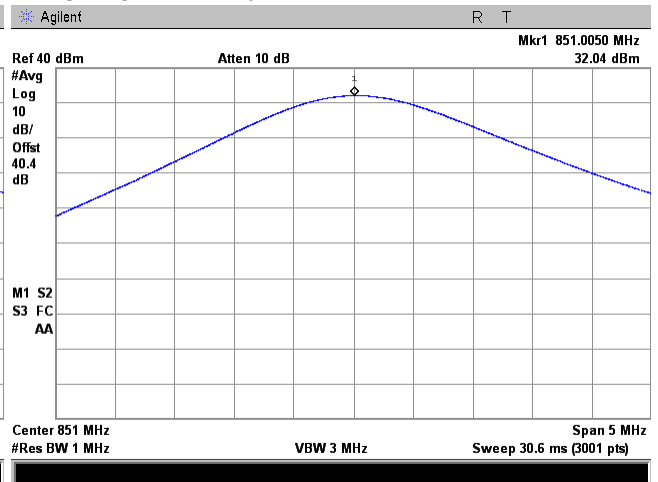
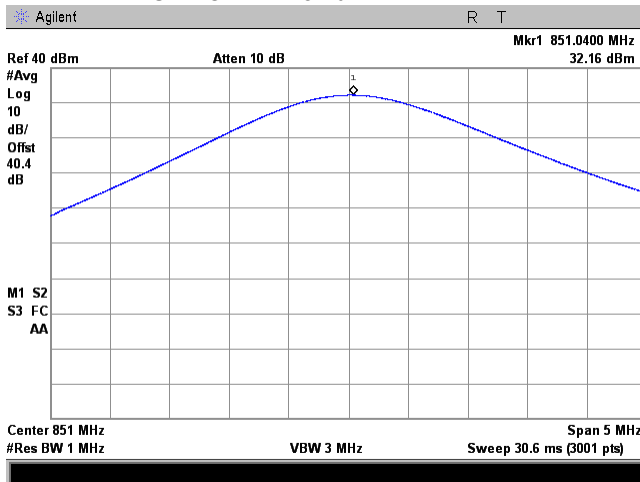

Plot 7.1.32 RF output power measurements at mid frequency carrier, Port 1

FRQUENCY RANGE:
OPERATIONAL MODE:
CONFIGURATION:
INPUT PORT:
INPUT POWER: -54 dBm

851 - 861 MHz
Analog FM downlink transmit
Dual Band
Base
INPUT POWER: -24 dBm

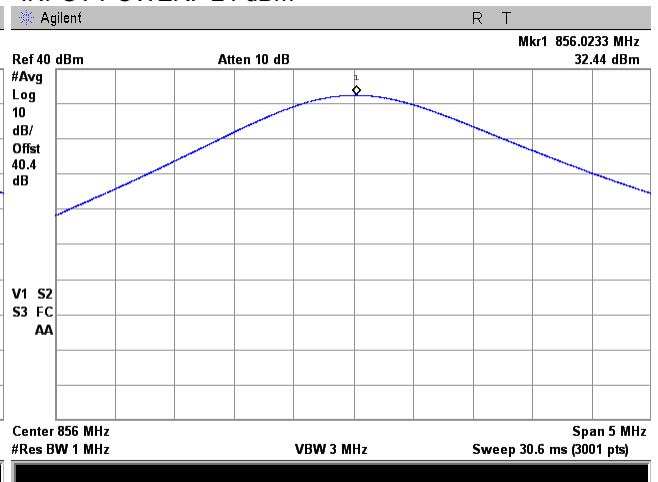
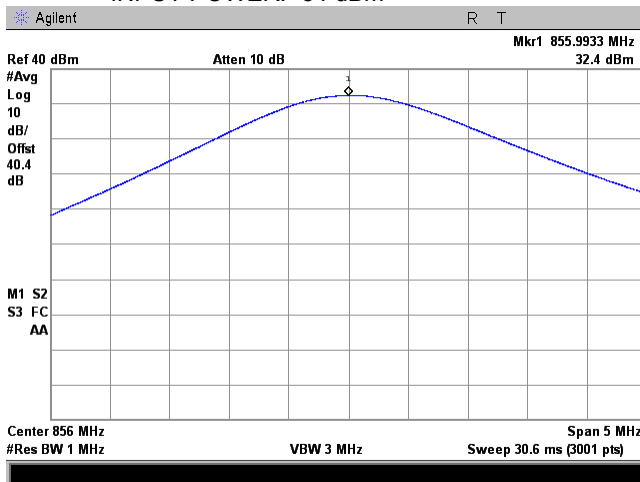

Test specification: Section 90.219(e)(1), Maximum output power	
Test procedure: 47 CFR, Section 2.1046; KDB 935210 D02 v02, Appendix D	
Test mode: Compliance	Verdict: PASS
Date(s): 03-Aug-14 - 07-Aug-14	
Temperature: 23.2 °C	Air Pressure: 1004 hPa
Relative Humidity: 44 %	Power Supply: 120 VAC
Remarks:	

Plot 7.1.33 RF output power measurements at high frequency carrier, Port 1

FRQUENCY RANGE:
OPERATIONAL MODE:
CONFIGURATION:
INPUT PORT:
INPUT POWER: -54 dBm

851 - 861 MHz
Analog FM downlink transmit
Dual Band
Base
INPUT POWER: -24 dBm

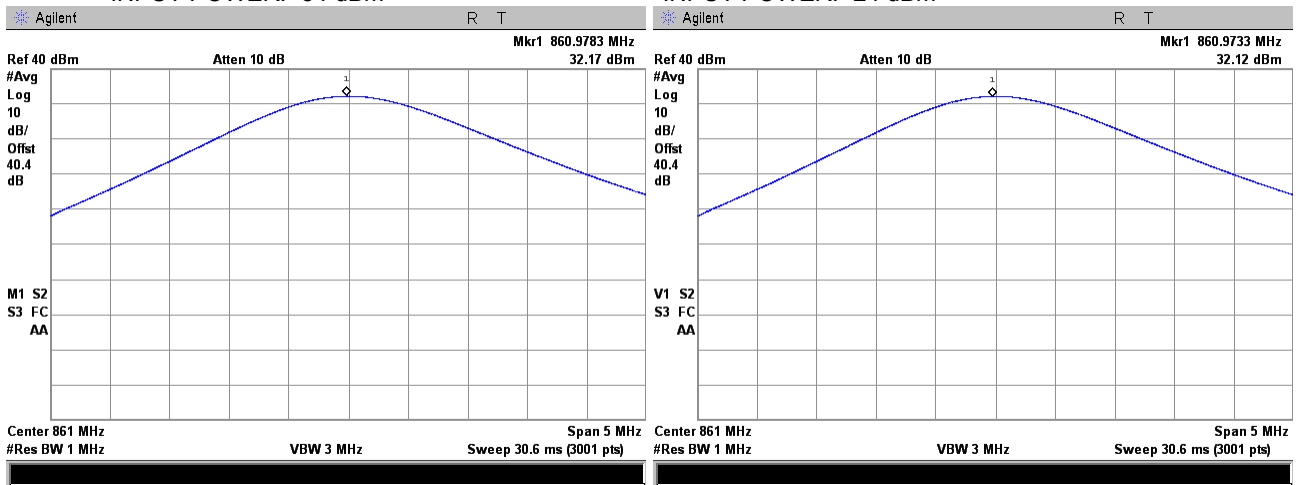

Plot 7.1.34 RF output power measurements at low frequency carrier, Port 2

FRQUENCY RANGE:
OPERATIONAL MODE:
CONFIGURATION:
INPUT PORT:
INPUT POWER: -54 dBm

806 - 816 MHz
Analog FM uplink transmit
Dual Band
Mobile
INPUT POWER: -24 dBm

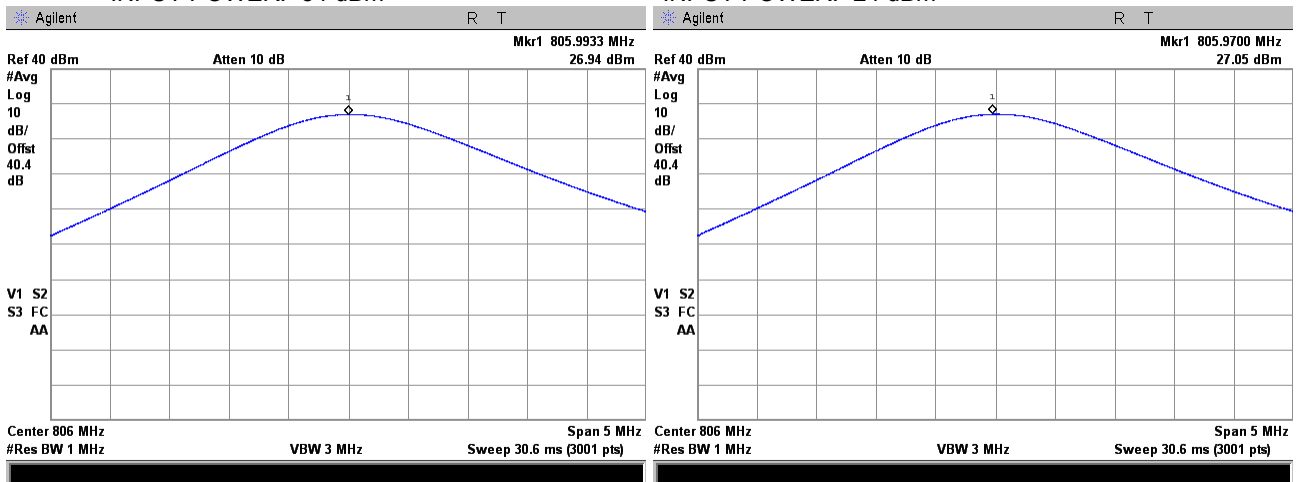

Test specification: Section 90.219(e)(1), Maximum output power			
Test procedure: 47 CFR, Section 2.1046; KDB 935210 D02 v02, Appendix D			
Test mode: Compliance	Verdict: PASS		
Date(s): 03-Aug-14 - 07-Aug-14			
Temperature: 23.2 °C	Air Pressure: 1004 hPa	Relative Humidity: 44 %	Power Supply: 120 VAC
Remarks:			

Plot 7.1.35 RF output power measurements at mid frequency carrier, Port 2

FRQUENCY RANGE:
OPERATIONAL MODE:
CONFIGURATION:
INPUT PORT:
INPUT POWER: -54 dBm

806 - 816 MHz
Analog FM uplink transmit
Dual Band
Mobile
INPUT POWER: -24 dBm

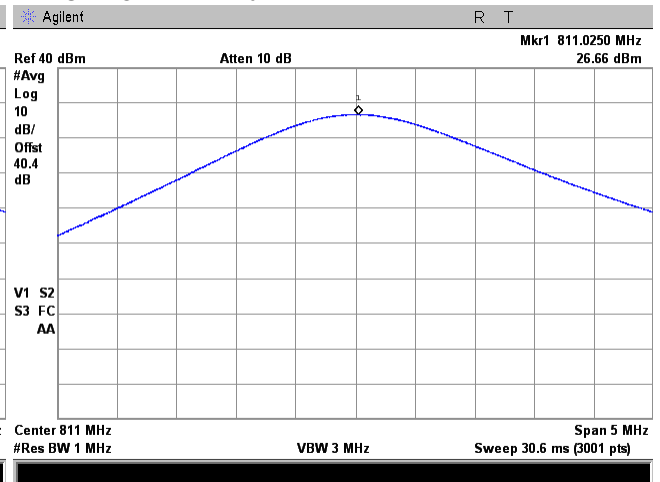
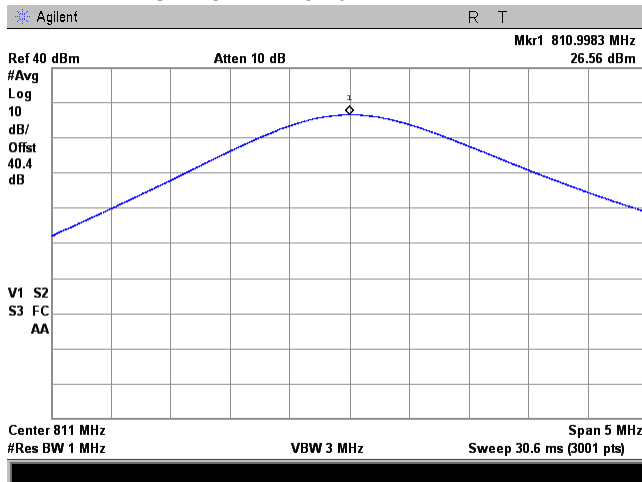

Plot 7.1.36 RF output power measurements at high frequency carrier, Port 2

FRQUENCY RANGE:
OPERATIONAL MODE:
CONFIGURATION:
INPUT PORT:
INPUT POWER: -54 dBm

806 - 816 MHz
Analog FM uplink transmit
Dual Band
Mobile
INPUT POWER: -24 dBm

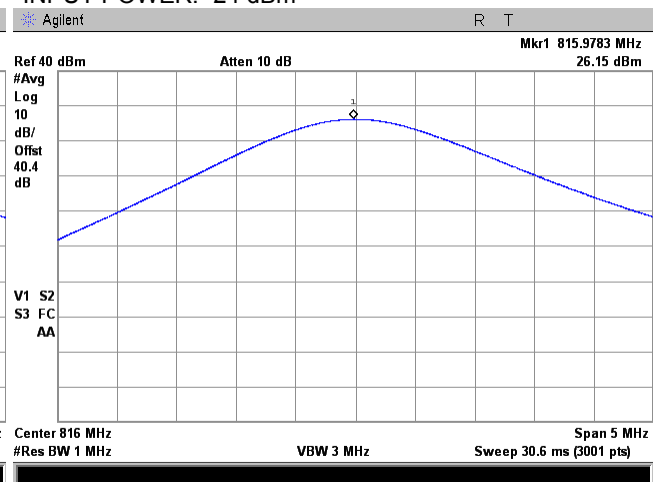
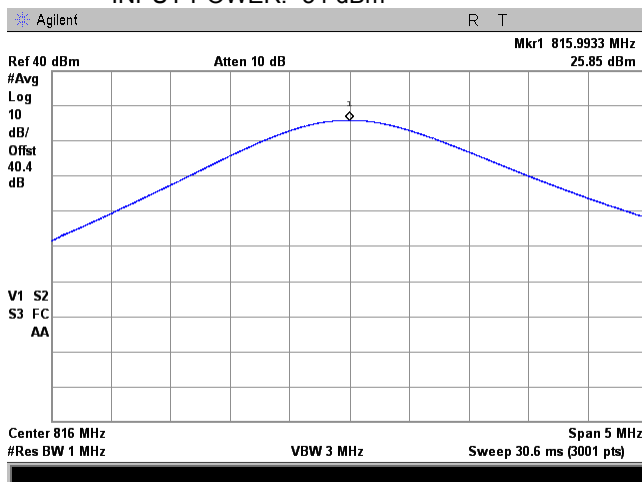

Test specification:		Section 90.219(a), Occupied bandwidth	
Test procedure:		47 CFR, Section 2.1049	
Test mode:		Compliance	
Date(s):		03-Aug-14	
Temperature: 23.1 °C		Air Pressure: 1005 hPa	
		Relative Humidity: 41 %	
		Power Supply: 120 VAC	
Remarks:			

7.2 Occupied bandwidth test

7.2.1 General

This test was performed to measure transmitter occupied bandwidth. Specification test limits are given in Table 7.2.1.

Table 7.2.1 Occupied bandwidth limits

Assigned frequency, MHz	Modulation envelope reference points*, dBc	Maximum allowed bandwidth, kHz
758 – 775/778 - 805	26	75.0
806 – 816/851 - 861		75.0

* - Modulation envelope reference points are provided in terms of attenuation below the unmodulated carrier.

7.2.2 Test procedure

7.2.2.1 The EUT was set up as shown in Figure 7.2.1, energized and its proper operation was checked.

7.2.2.2 The EUT was set to transmit the unmodulated carrier and the reference peak power level was measured.

7.2.2.3 The EUT was set to transmit the normally modulated carrier.

7.2.2.4 The transmitter occupied bandwidth was measured with spectrum analyzer as a frequency delta between the reference points on modulation envelope and provided in Table 7.2.2 and the associated plots.

Figure 7.2.1 Occupied bandwidth test setup

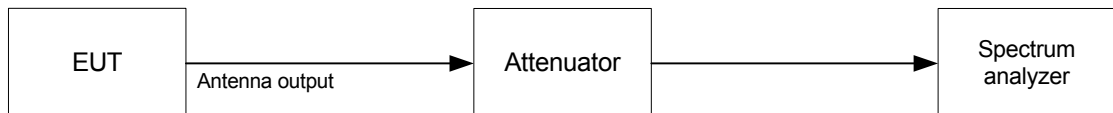



Test specification:		Section 90.219(a), Occupied bandwidth	
Test procedure:		47 CFR, Section 2.1049	
Test mode:		Compliance	
Date(s):		03-Aug-14	
Temperature: 23.1 °C		Air Pressure: 1005 hPa	
		Relative Humidity: 41 %	
		Power Supply: 120 VAC	
Remarks:			

Table 7.2.2 Occupied bandwidth test results

OPERATING FREQUENCY RANGE: 758 - 775 MHz (downlink)
788 - 805 MHz (uplink)

DETECTOR USED: Peak hold

RESOLUTION BANDWIDTH: 300 Hz

VIDEO BANDWIDTH: 1 kHz

MODULATION ENVELOPE REFERENCE POINTS: 26 dBc

MODULATING SIGNAL: C4FM

BIT RATE: 4 kbps

CONFIGURATION: Single Band

Carrier frequency, MHz	Output port	Occupied bandwidth, kHz		Limit, kHz	Margin, kHz	Verdict
		Without ALC	With ALC			
758.0	Base	7.3000	8.2306	75.0	-66.7694	Pass
766.0	Base	7.2899	8.1385	75.0	-66.8615	Pass
775.0	Base	7.3022	8.3718	75.0	-66.6282	Pass
778.0	Mobile	8.0009	6.4669	75.0	-66.9991	Pass
796.0	Mobile	8.6600	7.3793	75.0	-66.3400	Pass
805.0	Mobile	7.8389	7.8266	75.0	-67.1611	Pass

OPERATING FREQUENCY RANGE: 851 - 861 MHz (downlink)
806 - 816 MHz (uplink)

CONFIGURATION: Single Band

Carrier frequency, MHz	Output port	Occupied bandwidth, kHz		Limit, kHz	Margin, kHz	Verdict
		Without ALC	With ALC			
851.0	Base	7.9695	7.5837	75.0	-67.0305	Pass
856.0	Base	8.4345	7.5905	75.0	-66.5655	Pass
861.0	Base	8.1117	7.7895	75.0	-66.8883	Pass
806.0	Mobile	8.8098	7.9788	75.0	-66.1902	Pass
811.0	Mobile	7.8638	7.4782	75.0	-67.1362	Pass
816.0	Mobile	7.6446	7.7414	75.0	-67.2586	Pass



Test specification:		Section 90.219(a), Occupied bandwidth	
Test procedure:		47 CFR, Section 2.1049	
Test mode:		Compliance	
Date(s):		03-Aug-14	
Temperature: 23.1 °C		Air Pressure: 1005 hPa	
		Relative Humidity: 41 %	
		Power Supply: 120 VAC	
Remarks:			

Table 7.2.2 Occupied bandwidth test results (continued)

OPERATING FREQUENCY RANGE: 758 - 775 MHz (downlink)
788 - 805 MHz (uplink)

DETECTOR USED: Peak hold

RESOLUTION BANDWIDTH: 300 Hz

VIDEO BANDWIDTH: 1 kHz

MODULATION ENVELOPE REFERENCE POINTS: 26 dBc

MODULATING SIGNAL: iDEN QAM

BIT RATE: 4 kbps

CONFIGURATION: Single Band

Carrier frequency, MHz	Output port	Occupied bandwidth, kHz		Limit, kHz	Margin, kHz	Verdict
		Without ALC	With ALC			
758.0	Base	17.3428	17.1947	75.0	-57.6572	Pass
766.0	Base	17.3805	17.3988	75.0	-57.6012	Pass
775.0	Base	17.4880	17.5346	75.0	-57.4654	Pass
788.0	Mobile	17.2238	17.8246	75.0	-57.1754	Pass
796.0	Mobile	17.1647	18.2084	75.0	-56.7916	Pass
805.0	Mobile	16.9310	17.7204	75.0	-57.2796	Pass

OPERATING FREQUENCY RANGE: 851 - 861 MHz (downlink)
806 - 816 MHz (uplink)

CONFIGURATION: Single Band

Carrier frequency, MHz	Output port	Occupied bandwidth, kHz		Limit, kHz	Margin, kHz	Verdict
		Without ALC	With ALC			
851.0	Base	17.2156	17.2744	75.0	-57.7256	Pass
856.0	Base	17.2111	17.7038	75.0	-57.2962	Pass
861.0	Base	17.6493	17.3958	75.0	-57.3507	Pass
806.0	Mobile	17.2476	18.8122	75.0	-56.1878	Pass
811.0	Mobile	17.0099	17.6466	75.0	-57.3534	Pass
816.0	Mobile	17.5175	18.4070	75.0	-56.5930	Pass



Test specification:		Section 90.219(a), Occupied bandwidth	
Test procedure:		47 CFR, Section 2.1049	
Test mode:		Compliance	
Date(s):		03-Aug-14	
Temperature: 23.1 °C		Air Pressure: 1005 hPa	
		Relative Humidity: 41 %	
		Power Supply: 120 VAC	
Remarks:			
Verdict: PASS			

Table 7.2.2 Occupied bandwidth test results (continued)

OPERATING FREQUENCY RANGE: 758 - 775 MHz (downlink)
788 - 805 MHz (uplink)

DETECTOR USED: Peak hold

RESOLUTION BANDWIDTH: 300 Hz

VIDEO BANDWIDTH: 1 kHz

MODULATION ENVELOPE REFERENCE POINTS: 26 dBc

MODULATING SIGNAL: Analog FM 10.0 kHz/1 kHz

BIT RATE: 4 kbps

CONFIGURATION: Single Band

Carrier frequency, MHz	Output port	Occupied bandwidth, kHz		Limit, kHz	Margin, kHz	Verdict
		Without ALC	With ALC			
758.0	Base	23.4588	23.4976	75.0	-51.5024	Pass
796.0	Base	23.3205	23.5050	75.0	-51.4950	Pass
775.0	Base	23.4538	23.4200	75.0	-51.5462	Pass
778.0	Mobile	23.3416	23.9455	75.0	-51.0545	Pass
796.0	Mobile	23.0253	23.7805	75.0	-51.2195	Pass
805.0	Mobile	23.7124	24.2557	75.0	-50.7443	Pass

OPERATING FREQUENCY RANGE: 851 - 861 MHz (downlink)
806 - 816 MHz (uplink)

CONFIGURATION: Single Band

Carrier frequency, MHz	Output port	Occupied bandwidth, kHz		Limit, kHz	Margin, kHz	Verdict
		Without ALC	With ALC			
851.0	Base	23.8191	24.1293	75.0	-50.8707	Pass
856.0	Base	24.0642	23.8611	75.0	-50.9358	Pass
861.0	Base	24.1426	24.1330	75.0	-50.8574	Pass
806.0	Mobile	23.9339	24.0529	75.0	-50.9471	Pass
811.0	Mobile	23.6971	24.0685	75.0	-50.9315	Pass
816.0	Mobile	23.7202	24.1110	75.0	-50.8890	Pass

Reference numbers of test equipment used

HL 2909	HL 3768	HL 3770	HL 3776	HL 4224	HL 4273	HL 4274	HL 4413
---------	---------	---------	---------	---------	---------	---------	---------

Full description is given in Appendix A.

Test specification: Section 90.219(a), Occupied bandwidth			
Test procedure: 47 CFR, Section 2.1049			
Test mode: Compliance	Verdict: PASS		
Date(s): 03-Aug-14			
Temperature: 23.1 °C	Air Pressure: 1005 hPa	Relative Humidity: 41 %	Power Supply: 120 VAC
Remarks:			

Plot 7.2.1 Occupied bandwidth test result at low frequency carrier, Port 1

FRQUENCY RANGE:	758 - 775 MHz
OPERATIONAL MODE:	C4FM downlink transmit
INPUT PORT:	Base
INPUT POWER: -50 dBm	INPUT POWER: -20 dBm
CONFIGURATION:	Single Band

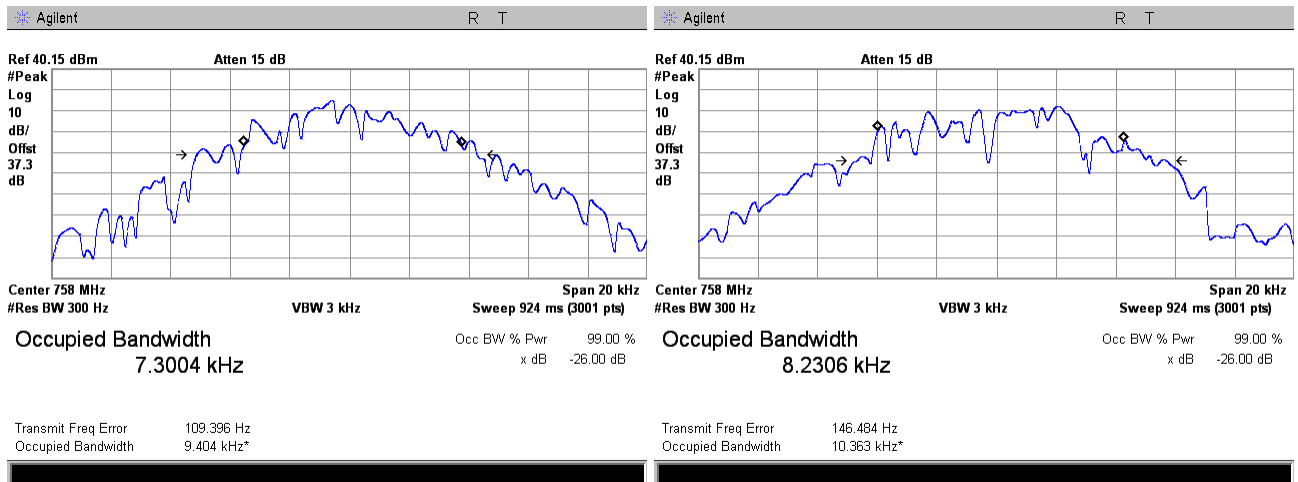

Plot 7.2.2 Occupied bandwidth test result at mid frequency carrier, Port 1

FRQUENCY RANGE:	758 - 775 MHz
OPERATIONAL MODE:	C4FM downlink transmit
INPUT PORT:	Base
INPUT POWER: -50 dBm	INPUT POWER: -20 dBm
CONFIGURATION:	Single Band

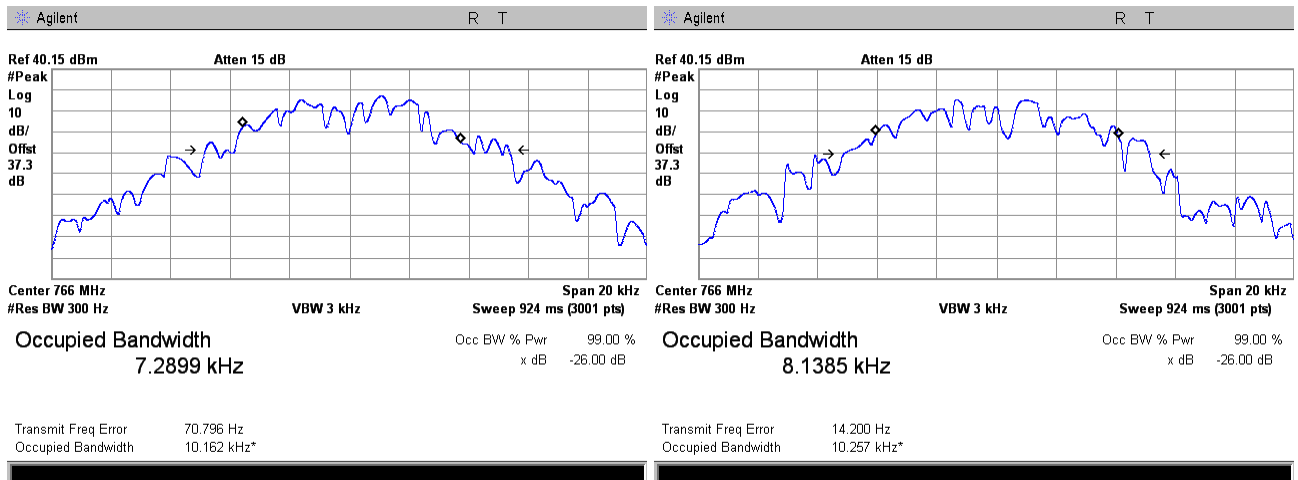

Test specification: Section 90.219(a), Occupied bandwidth			
Test procedure: 47 CFR, Section 2.1049			
Test mode: Compliance	Verdict: PASS		
Date(s): 03-Aug-14			
Temperature: 23.1 °C	Air Pressure: 1005 hPa	Relative Humidity: 41 %	Power Supply: 120 VAC
Remarks:			

Plot 7.2.3 Occupied bandwidth test result at high frequency carrier, Port 1

FRQUENCY RANGE:
OPERATIONAL MODE:
INPUT PORT:
INPUT POWER: -54 dBm
CONFIGURATION:

758 - 775 MHz
C4FM downlink transmit
Base
INPUT POWER: -24 dBm
Single Band

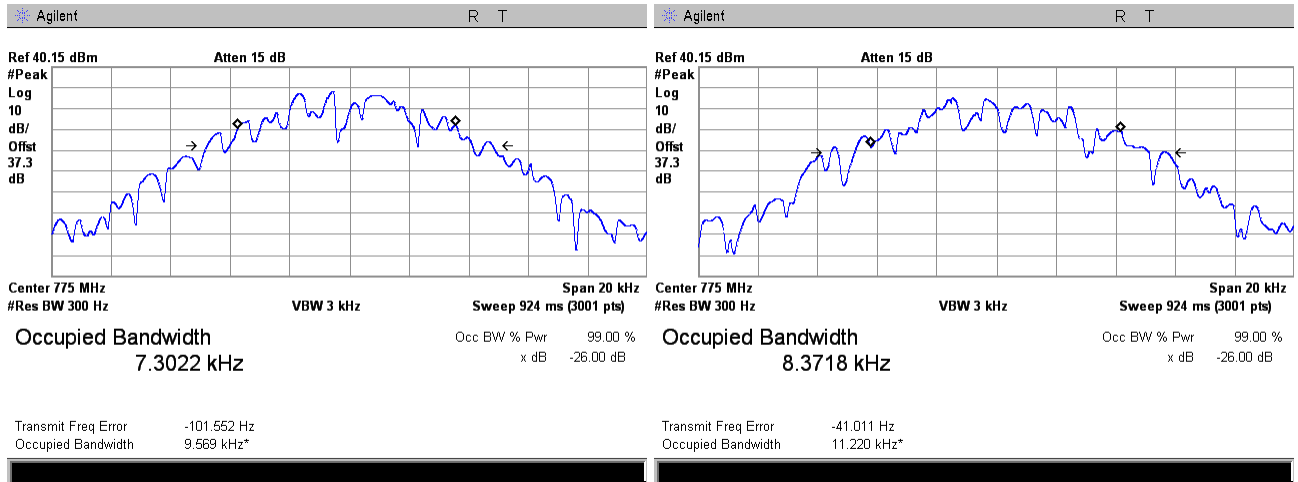

Plot 7.2.4 Occupied bandwidth test result at low frequency carrier, Port 2

FRQUENCY RANGE:
OPERATIONAL MODE:
INPUT PORT:
INPUT POWER: -54 dBm
CONFIGURATION:

788 - 805 MHz
C4FM uplink transmit
Mobile
INPUT POWER: -24 dBm
Dual Band

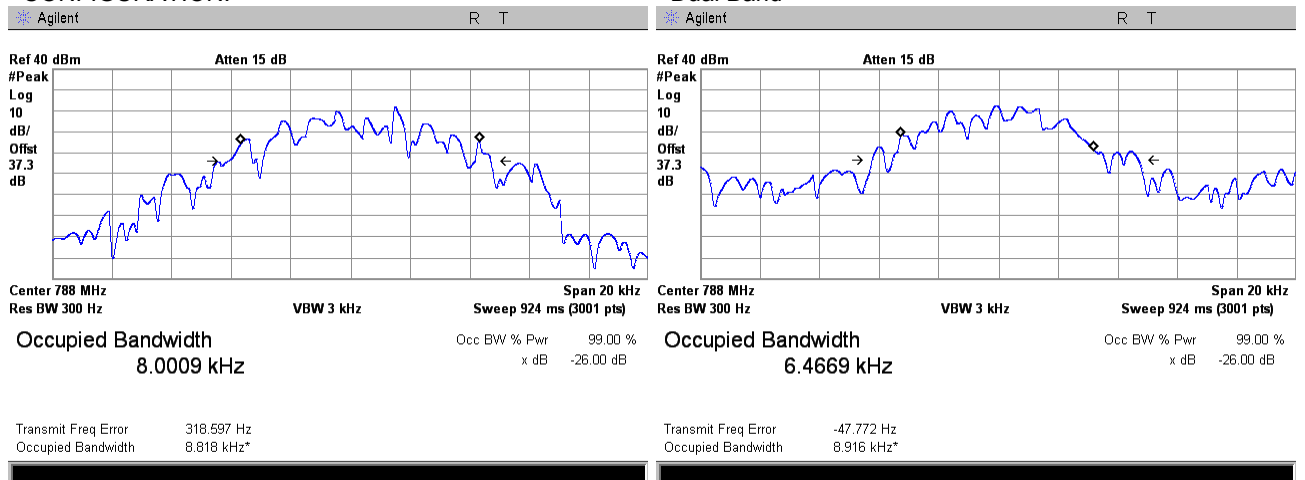

Test specification: Section 90.219(a), Occupied bandwidth			
Test procedure: 47 CFR, Section 2.1049			
Test mode: Compliance	Verdict: PASS		
Date(s): 03-Aug-14			
Temperature: 23.1 °C	Air Pressure: 1005 hPa	Relative Humidity: 41 %	Power Supply: 120 VAC
Remarks:			

Plot 7.2.5 Occupied bandwidth test result at mid frequency carrier, Port 2

FRQUENCY RANGE:
OPERATIONAL MODE:
INPUT PORT:
INPUT POWER: -54 dBm
CONFIGURATION:

788 - 805 MHz
C4FM uplink transmit
Mobile
INPUT POWER: -24 dBm
Dual Band

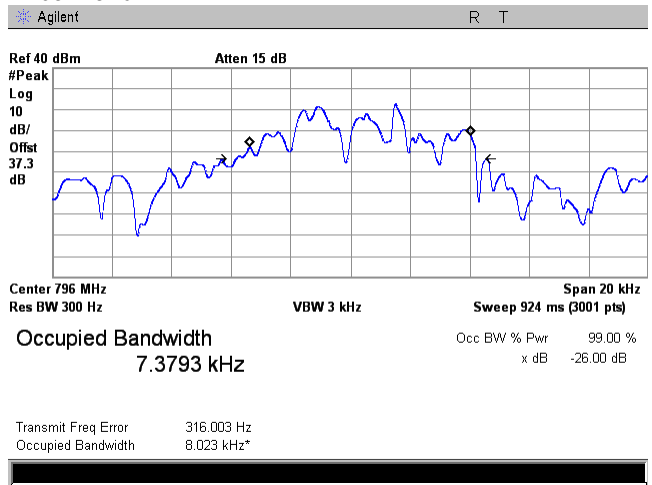
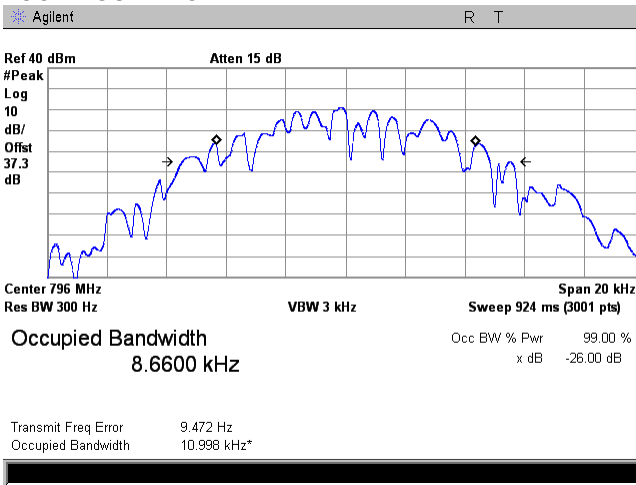

Plot 7.2.6 Occupied bandwidth test result at high frequency carrier, Port 2

FRQUENCY RANGE:
OPERATIONAL MODE:
INPUT PORT:
INPUT POWER: -54 dBm
CONFIGURATION:

788 - 805 MHz
C4FM uplink transmit
Mobile
INPUT POWER: -24 dBm
Dual Band

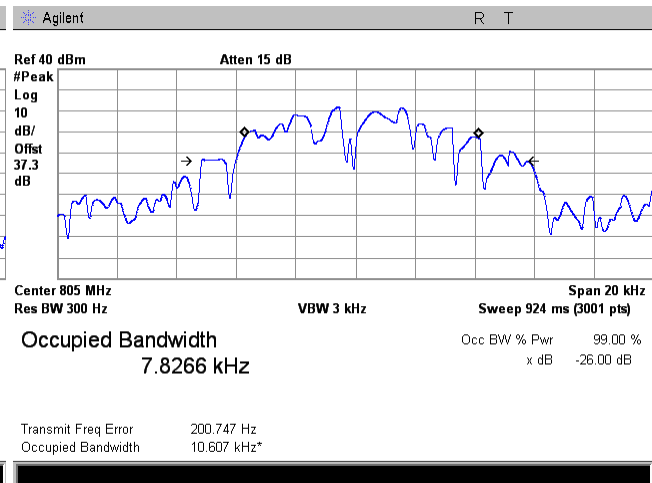
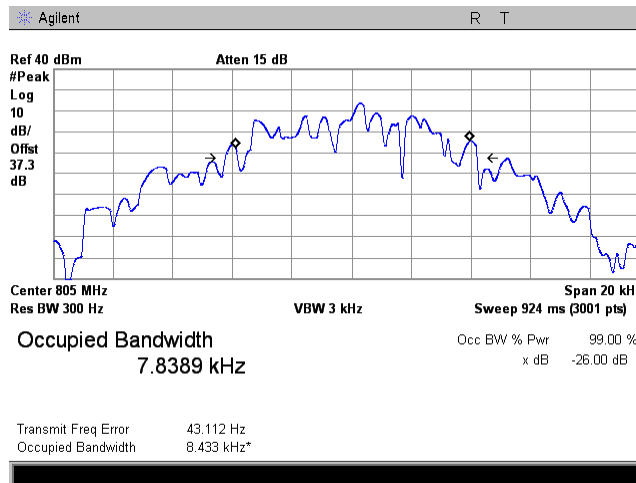

Test specification: Section 90.219(a), Occupied bandwidth			
Test procedure: 47 CFR, Section 2.1049			
Test mode: Compliance	Verdict: PASS		
Date(s): 03-Aug-14			
Temperature: 23.1 °C	Air Pressure: 1005 hPa	Relative Humidity: 41 %	Power Supply: 120 VAC
Remarks:			

Plot 7.2.7 Occupied bandwidth test result at low frequency carrier, Port 1

FRQUENCY RANGE:	851 - 861 MHz
OPERATIONAL MODE:	C4FM downlink transmit
INPUT PORT:	Mobile
INPUT POWER: -51 dBm	INPUT POWER: -21 dBm
CONFIGURATION:	Single Band

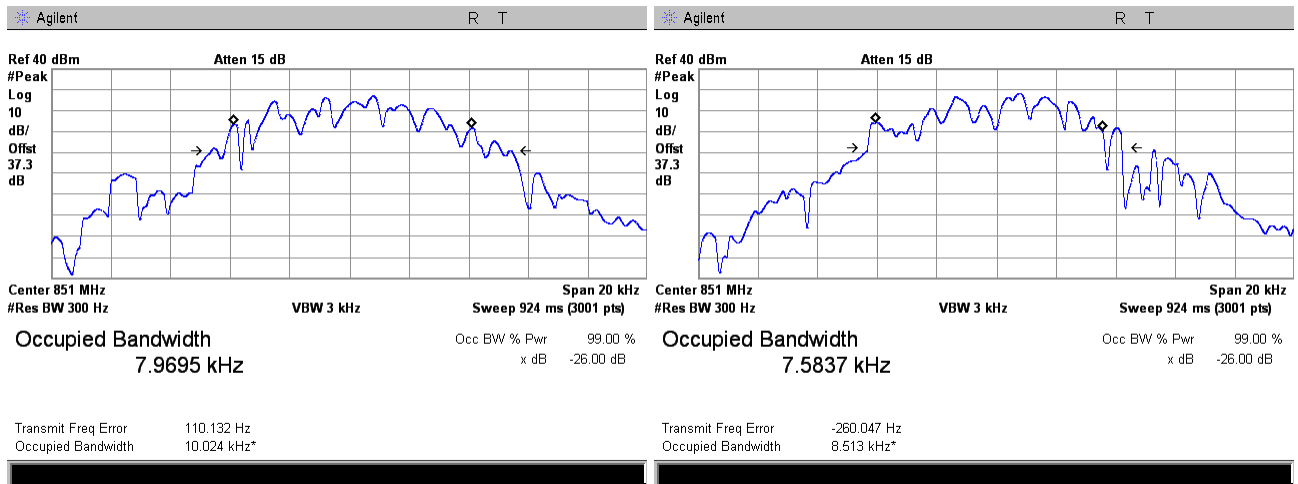

Plot 7.2.8 Occupied bandwidth test result at mid frequency carrier, Port 1

FRQUENCY RANGE:	851 - 861 MHz
OPERATIONAL MODE:	C4FM downlink transmit
INPUT PORT:	Mobile
INPUT POWER: -51 dBm	INPUT POWER: -21 dBm
CONFIGURATION:	Single Band

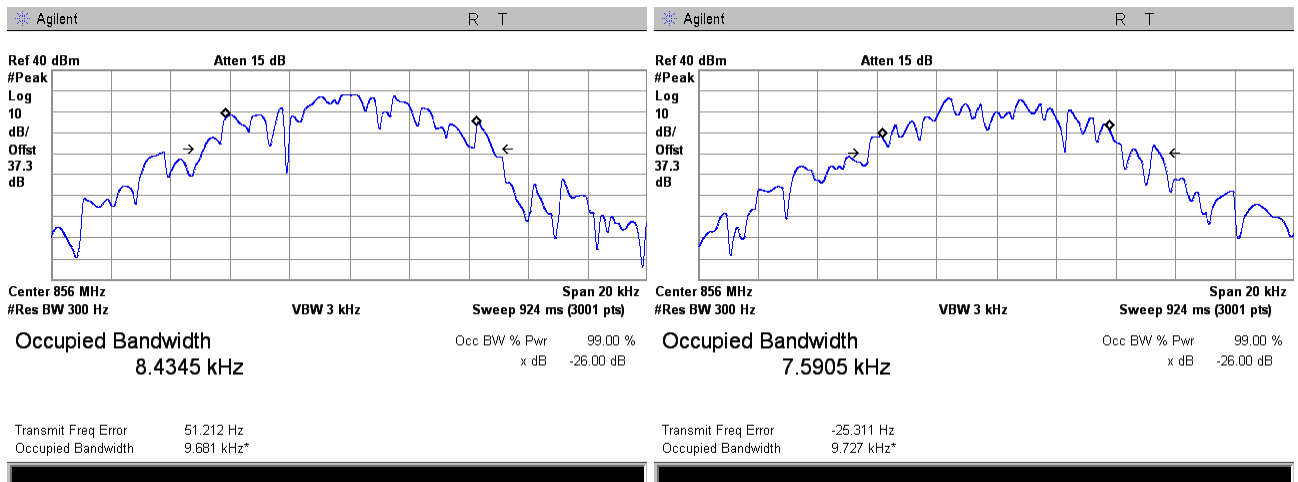

Test specification: Section 90.219(a), Occupied bandwidth			
Test procedure: 47 CFR, Section 2.1049			
Test mode: Compliance	Verdict: PASS		
Date(s): 03-Aug-14			
Temperature: 23.1 °C	Air Pressure: 1005 hPa	Relative Humidity: 41 %	Power Supply: 120 VAC
Remarks:			

Plot 7.2.9 Occupied bandwidth test result at high frequency carrier, Port 1

FRQUENCY RANGE:	851 - 861 MHz
OPERATIONAL MODE:	C4FM downlink transmit
INPUT PORT:	Mobile
INPUT POWER: -51 dBm	INPUT POWER: -21 dBm
CONFIGURATION:	Single Band

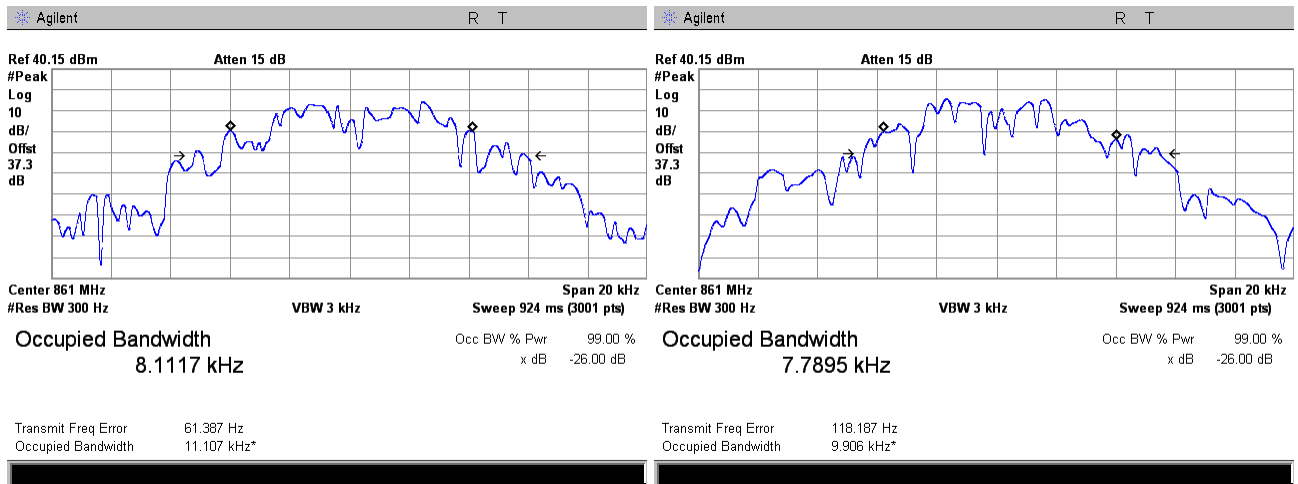

Plot 7.2.10 Occupied bandwidth test result at low frequency carrier, Port 2

FRQUENCY RANGE:	806 - 816 MHz
OPERATIONAL MODE:	C4FM uplink transmit
INPUT PORT:	Mobile
INPUT POWER: -54 dBm	INPUT POWER: -24 dBm
CONFIGURATION:	Dual Band

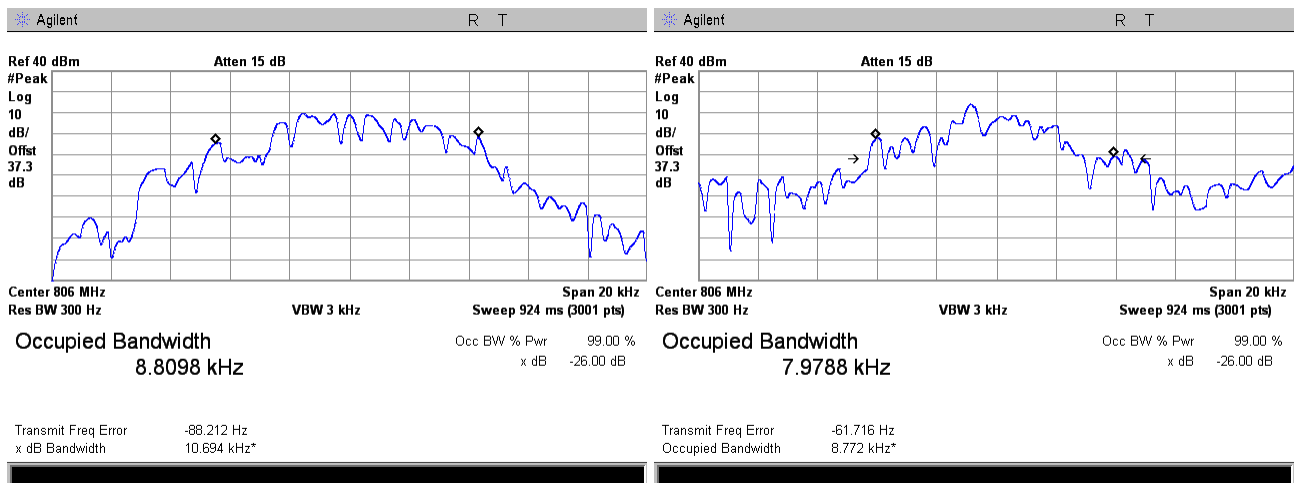

Test specification: Section 90.219(a), Occupied bandwidth			
Test procedure: 47 CFR, Section 2.1049			
Test mode: Compliance	Verdict: PASS		
Date(s): 03-Aug-14			
Temperature: 23.1 °C	Air Pressure: 1005 hPa	Relative Humidity: 41 %	Power Supply: 120 VAC
Remarks:			

Plot 7.2.11 Occupied bandwidth test result at mid frequency carrier, Port 2

FRQUENCY RANGE:	806 - 816 MHz
OPERATIONAL MODE:	C4FM uplink transmit
INPUT PORT:	Mobile
INPUT POWER: -54 dBm	INPUT POWER: -24 dBm
CONFIGURATION:	Dual Band

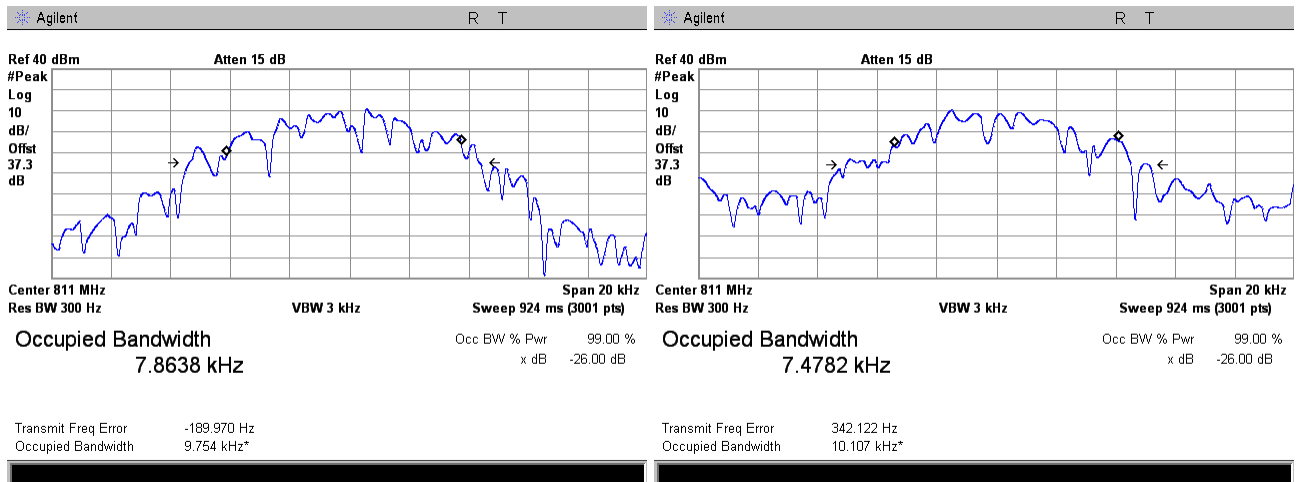

Plot 7.2.12 Occupied bandwidth test result at low frequency carrier, Port 2

FRQUENCY RANGE:	806 - 816 MHz
OPERATIONAL MODE:	C4FM uplink transmit
INPUT PORT:	Mobile
INPUT POWER: -54 dBm	INPUT POWER: -24 dBm
CONFIGURATION:	Dual Band

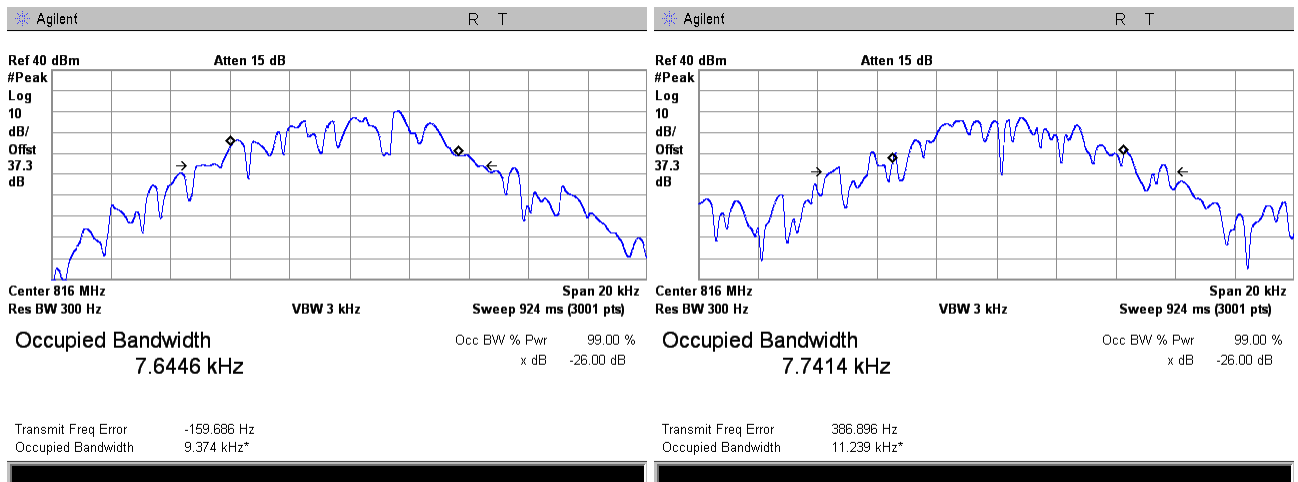

Test specification: Section 90.219(a), Occupied bandwidth			
Test procedure: 47 CFR, Section 2.1049			
Test mode: Compliance	Verdict: PASS		
Date(s): 03-Aug-14			
Temperature: 23.1 °C	Air Pressure: 1005 hPa	Relative Humidity: 41 %	Power Supply: 120 VAC
Remarks:			

Plot 7.2.13 Occupied bandwidth test result at low frequency carrier, Port 1

FRQUENCY RANGE:
OPERATIONAL MODE:
INPUT PORT:
INPUT POWER: -54 dBm
CONFIGURATION:

758 - 775 MHz
iDEN QAM downlink transmit
Base
INPUT POWER: -24 dBm
Single Band

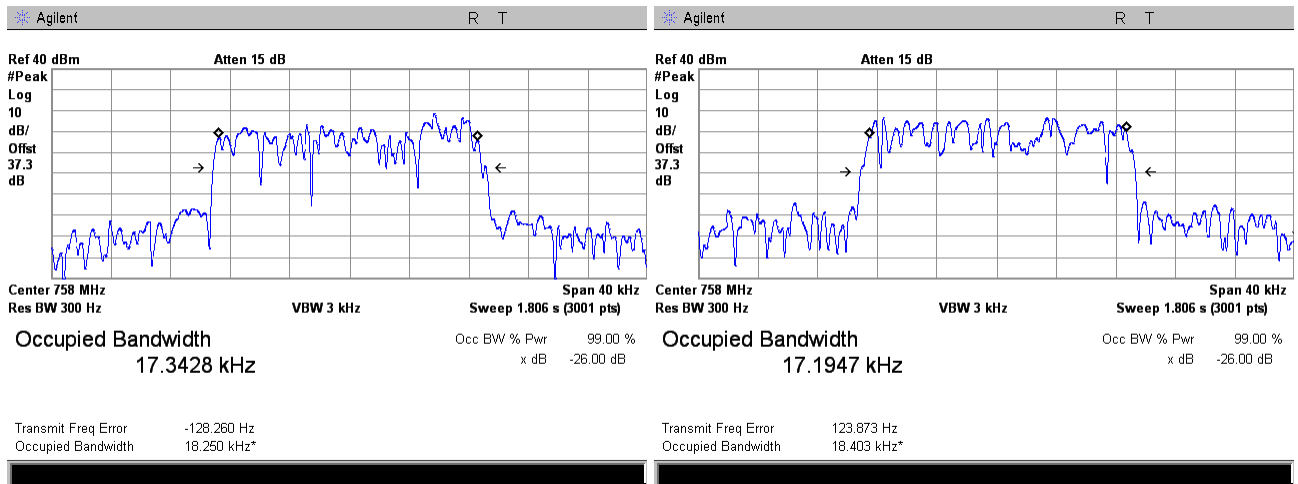

Plot 7.2.14 Occupied bandwidth test result at mid frequency carrier, Port 1

FRQUENCY RANGE:
OPERATIONAL MODE:
INPUT PORT:
INPUT POWER: -54 dBm
CONFIGURATION:

758 - 775 MHz
iDEN QAM downlink transmit
Mobile
INPUT POWER: -24 dBm
Single Band

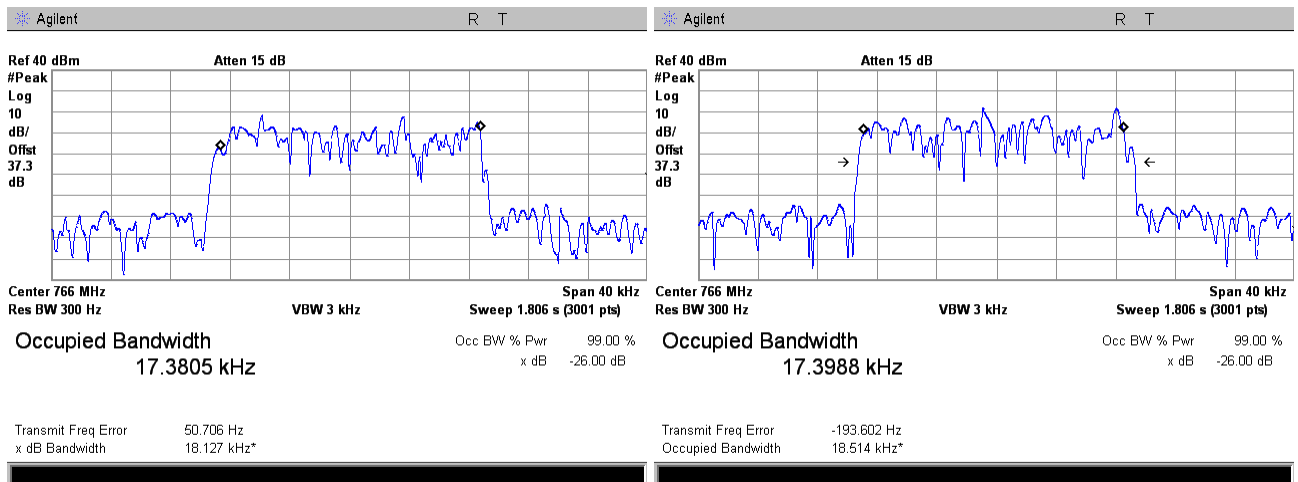

Test specification:		Section 90.219(a), Occupied bandwidth	
Test procedure:		47 CFR, Section 2.1049	
Test mode:		Compliance	
Date(s):		03-Aug-14	
Temperature: 23.1 °C		Air Pressure: 1005 hPa	
Remarks:		Verdict: PASS	
		Relative Humidity: 41 %	
		Power Supply: 120 VAC	

Plot 7.2.15 Occupied bandwidth test result at high frequency carrier, Port 1

FRQUENCY RANGE:	758 - 775 MHz
OPERATIONAL MODE:	iDEN QAM downlink transmit
INPUT PORT:	Mobile
COMPOSITE INPUT POWER:	-54 dBm
INPUT POWER: -54 dBm	INPUT POWER: -24 dBm
CONFIGURATION:	Single Band

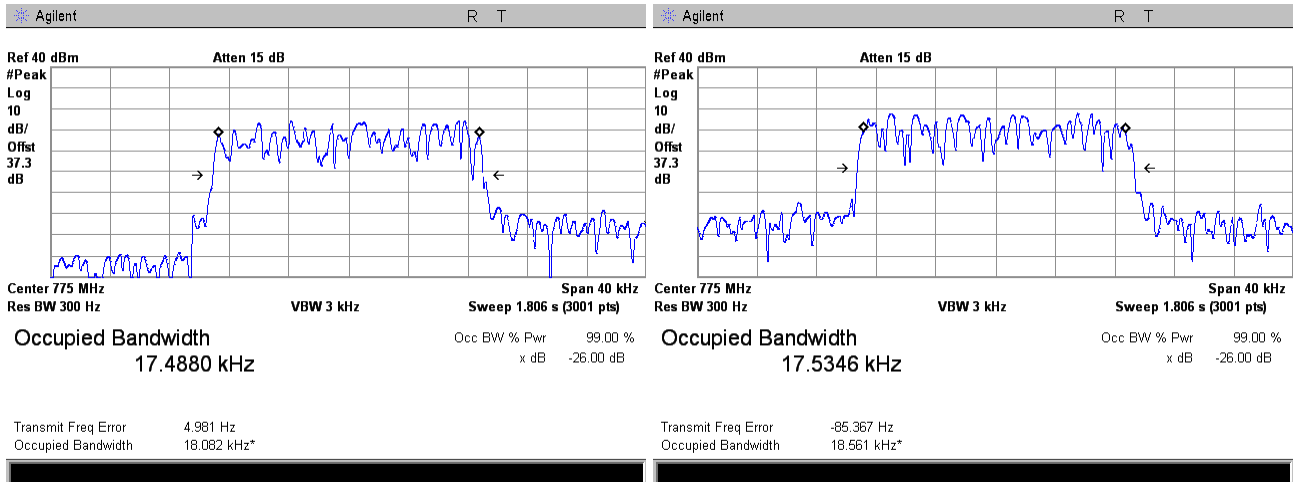

Plot 7.2.16 Occupied bandwidth test result at low frequency carrier, Port 2

FRQUENCY RANGE:	788 - 805 MHz
OPERATIONAL MODE:	iDEN QAM uplink transmit
INPUT PORT:	Mobile
INPUT POWER: -54 dBm	INPUT POWER: -24 dBm
CONFIGURATION:	Dual Band

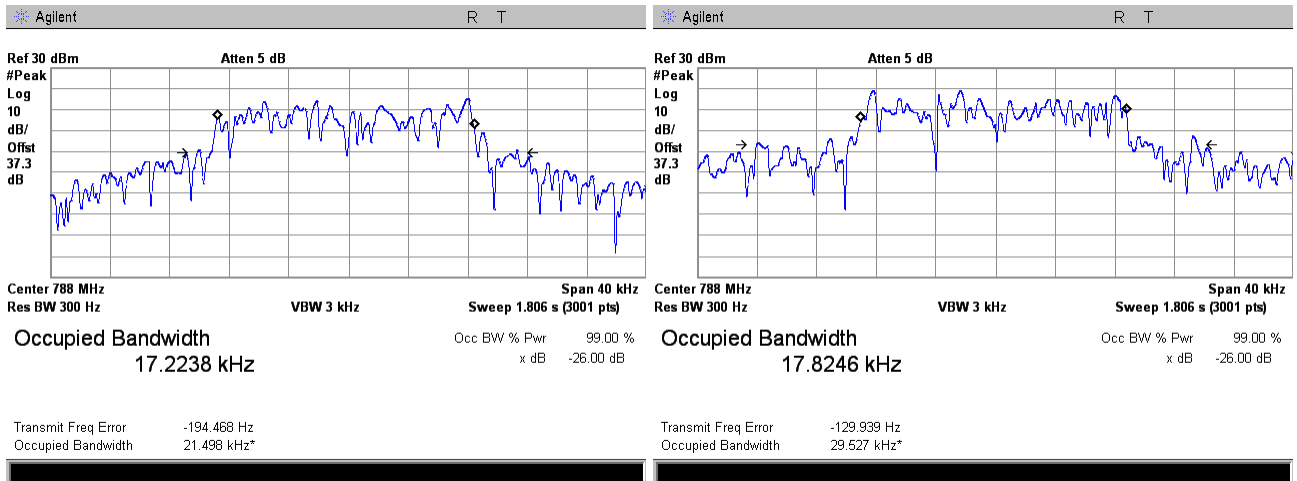

Test specification: Section 90.219(a), Occupied bandwidth			
Test procedure: 47 CFR, Section 2.1049			
Test mode: Compliance	Verdict: PASS		
Date(s): 03-Aug-14			
Temperature: 23.1 °C	Air Pressure: 1005 hPa	Relative Humidity: 41 %	Power Supply: 120 VAC
Remarks:			

Plot 7.2.17 Occupied bandwidth test result at low frequency carrier, Port 2

FRQUENCY RANGE:
OPERATIONAL MODE:
INPUT PORT:
INPUT POWER: -54 dBm
CONFIGURATION:

788 - 805 MHz
iDEN QAM uplink transmit
Mobile
INPUT POWER: -24 dBm
Dual Band

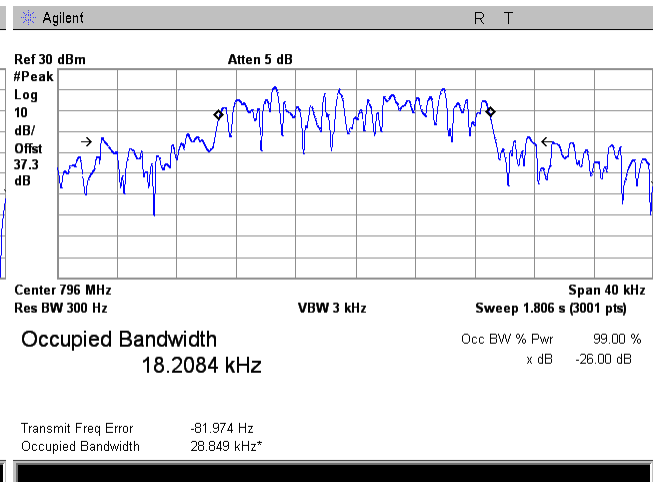
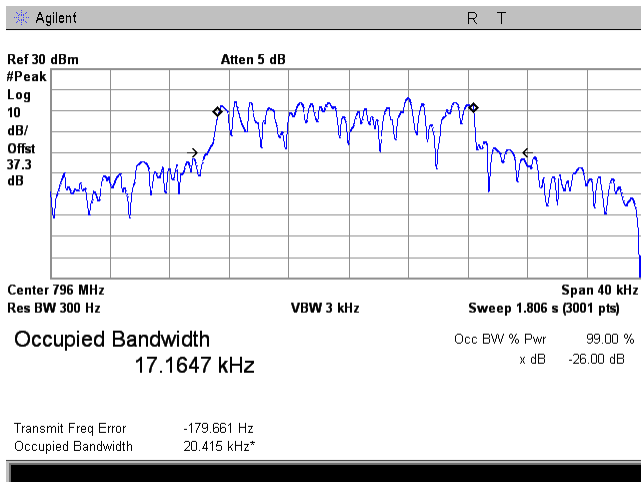

Plot 7.2.18 Occupied bandwidth test result at low frequency carrier, Port 2

FRQUENCY RANGE:
OPERATIONAL MODE:
INPUT PORT:
INPUT POWER: -54 dBm
CONFIGURATION:

788 - 805 MHz
iDEN QAM uplink transmit
Mobile
INPUT POWER: -24 dBm
Dual Band

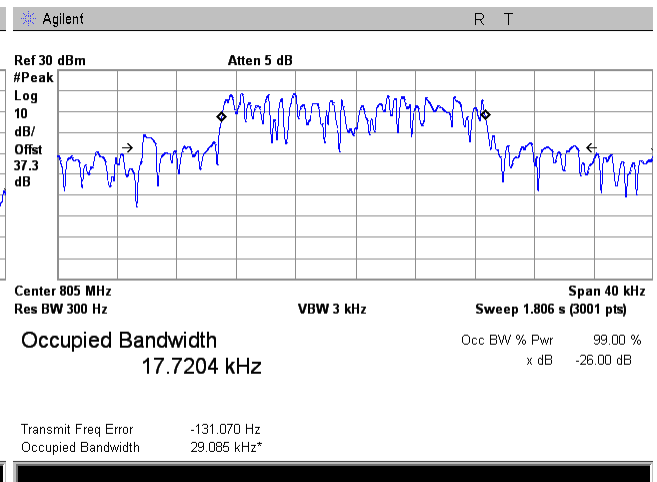
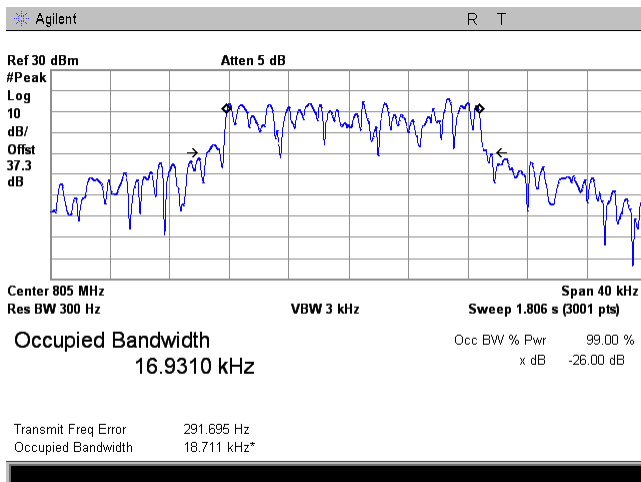

Test specification: Section 90.219(a), Occupied bandwidth			
Test procedure: 47 CFR, Section 2.1049			
Test mode: Compliance	Verdict: PASS		
Date(s): 03-Aug-14			
Temperature: 23.1 °C	Air Pressure: 1005 hPa	Relative Humidity: 41 %	Power Supply: 120 VAC
Remarks:			

Plot 7.2.19 Occupied bandwidth test result at low frequency carrier, Port 1

FRQUENCY RANGE:
OPERATIONAL MODE:
INPUT PORT:
INPUT POWER: -51 dBm
CONFIGURATION:

851 - 861 MHz
iDEN QAM downlink transmit
Mobile
INPUT POWER: -21 dBm
Single Band

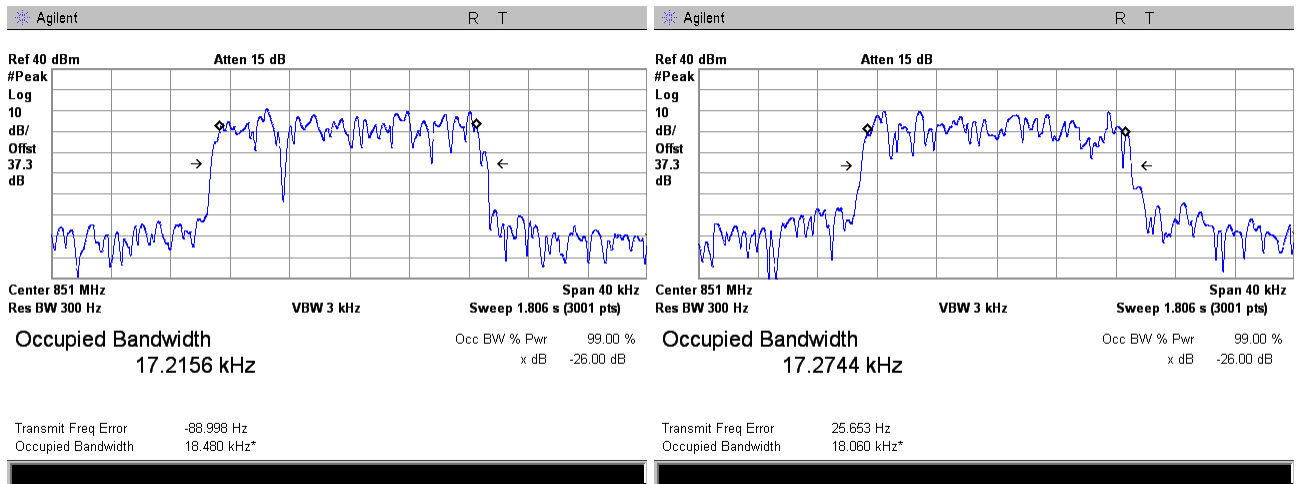

Plot 7.2.20 Occupied bandwidth test result at mid frequency carrier, Port 1

FRQUENCY RANGE:
OPERATIONAL MODE:
INPUT PORT:
INPUT POWER: -51 dBm
CONFIGURATION:

851 - 861 MHz
iDEN QAM downlink transmit
Mobile
INPUT POWER: -21 dBm
Single Band

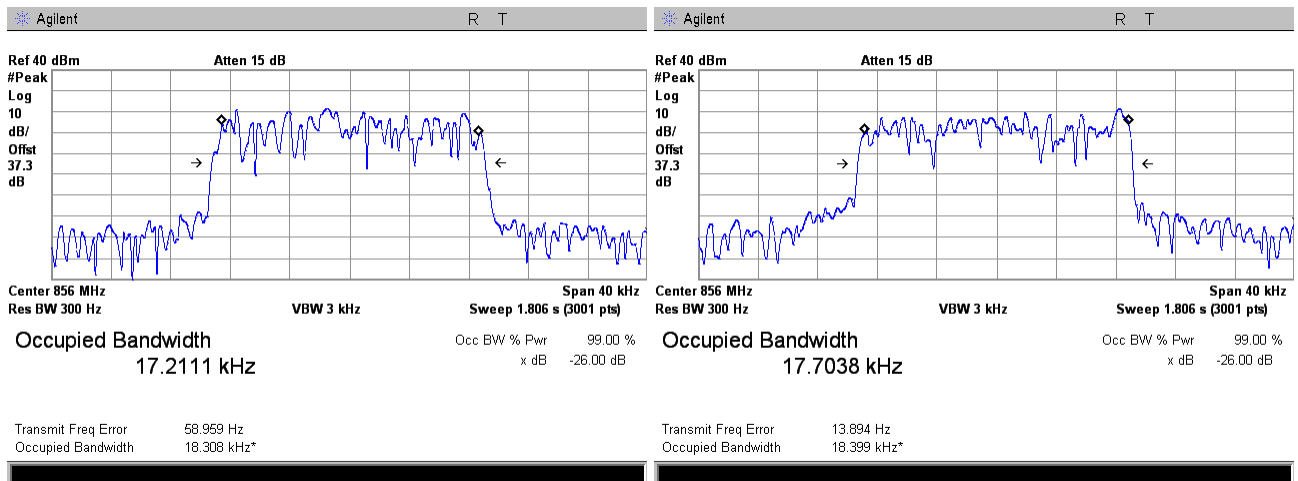

Test specification: Section 90.219(a), Occupied bandwidth			
Test procedure: 47 CFR, Section 2.1049			
Test mode: Compliance	Verdict: PASS		
Date(s): 03-Aug-14			
Temperature: 23.1 °C	Air Pressure: 1005 hPa	Relative Humidity: 41 %	Power Supply: 120 VAC
Remarks:			

Plot 7.2.21 Occupied bandwidth test result at high frequency carrier, Port 1

FRQUENCY RANGE:
OPERATIONAL MODE:
INPUT PORT:
INPUT POWER: -51 dBm
CONFIGURATION:

851 - 861 MHz
iDEN QAM downlink transmit
Mobile
INPUT POWER: -21 dBm
Single Band

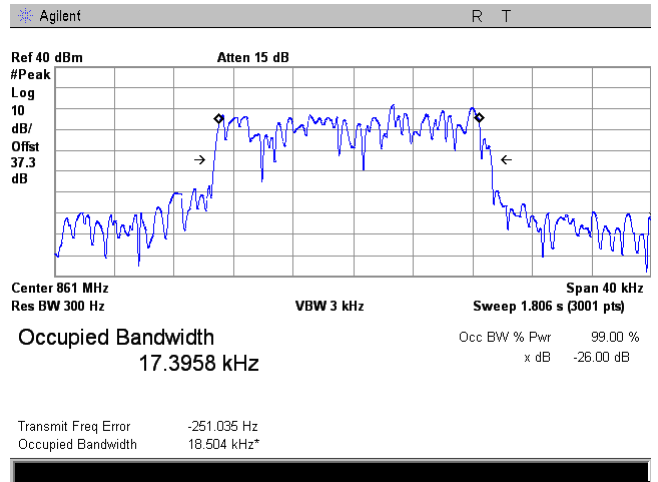
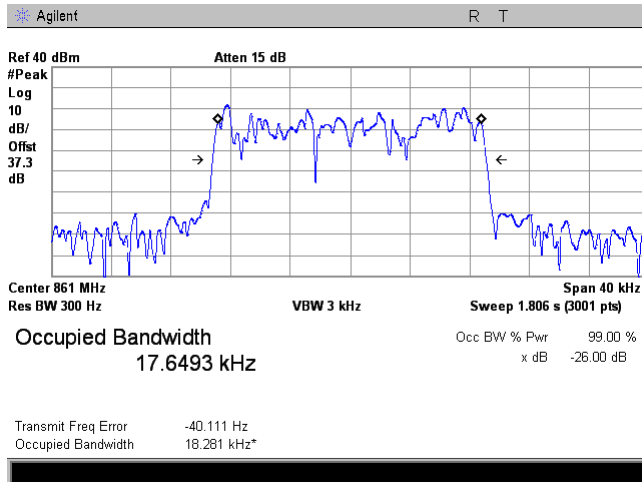

Plot 7.2.22 Occupied bandwidth test result at low frequency carrier, Port 2

FRQUENCY RANGE:
OPERATIONAL MODE:
INPUT PORT:
INPUT POWER: -54 dBm
CONFIGURATION:

806 - 816 MHz
iDEN QAM uplink transmit
Base
INPUT POWER: -24 dBm
Dual Band

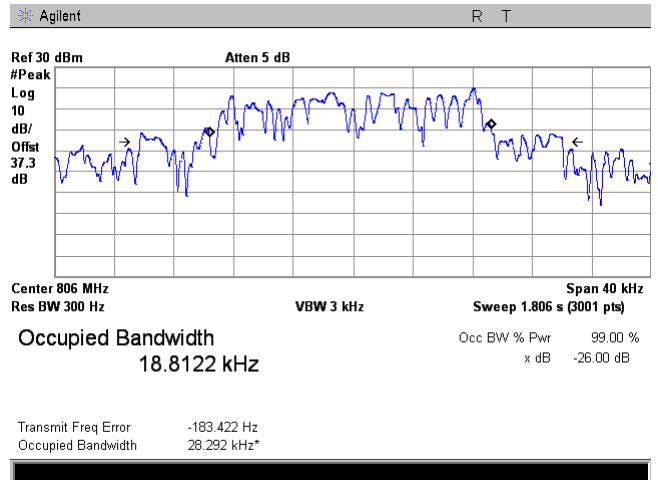
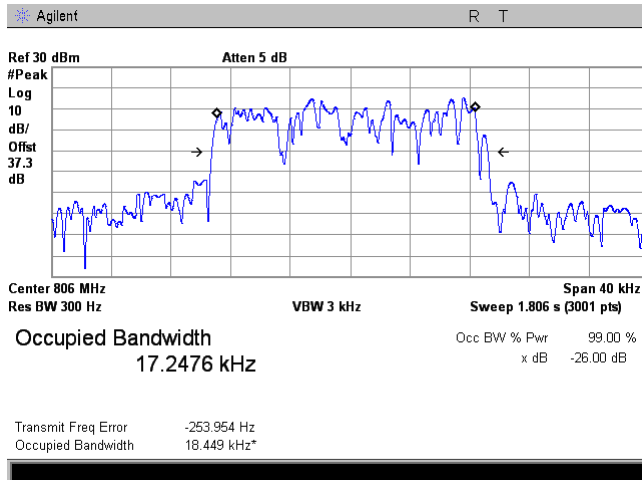

Test specification:		Section 90.219(a), Occupied bandwidth	
Test procedure:		47 CFR, Section 2.1049	
Test mode:		Compliance	
Date(s):		03-Aug-14	
Temperature: 23.1 °C		Air Pressure: 1005 hPa	
		Relative Humidity: 41 %	
		Power Supply: 120 VAC	
Remarks:			
		Verdict: PASS	

Plot 7.2.23 Occupied bandwidth test result at mid frequency carrier, Port 2

FRQUENCY RANGE:
OPERATIONAL MODE:
INPUT PORT:
INPUT POWER: -54 dBm
CONFIGURATION:

806 - 816 MHz
iDEN QAM uplink transmit
Base
INPUT POWER: -24 dBm
Dual Band

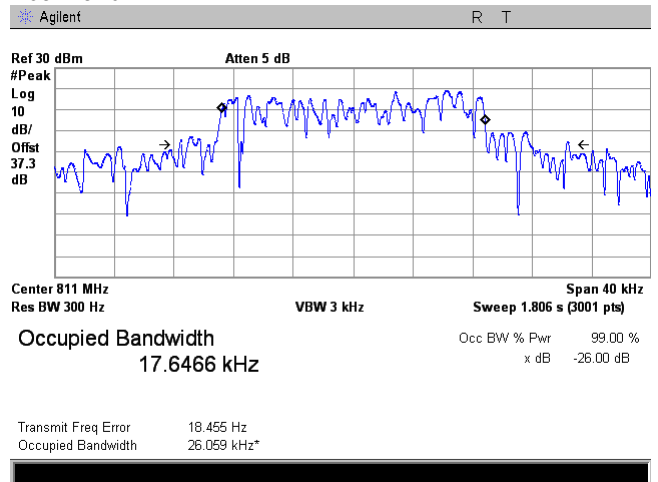
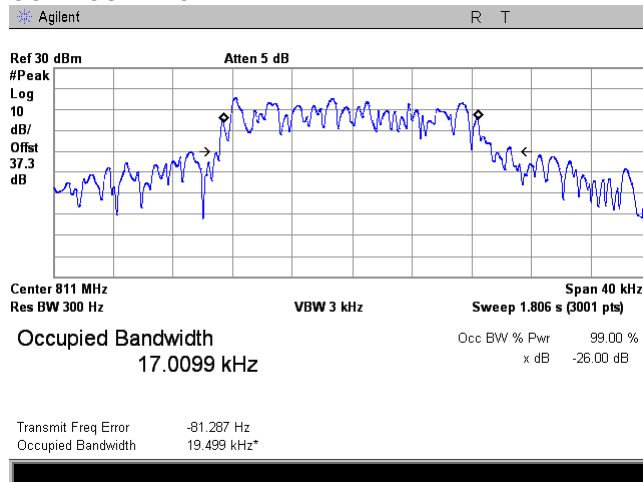

Plot 7.2.24 Occupied bandwidth test result at high frequency carrier, Port 2

FRQUENCY RANGE:
OPERATIONAL MODE:
INPUT PORT:
INPUT POWER: -54 dBm
CONFIGURATION:

806 - 816 MHz
iDEN QAM uplink transmit
Base
INPUT POWER: -24 dBm
Dual Band

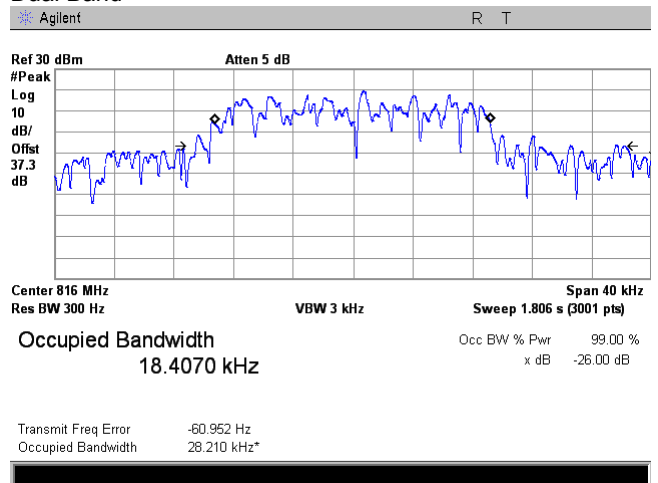
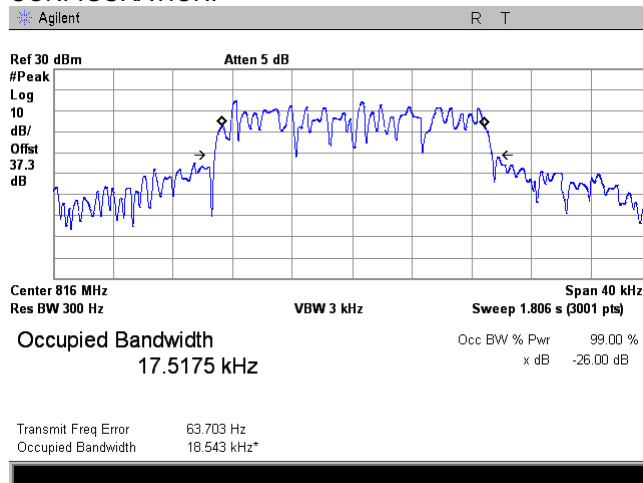

Test specification: Section 90.219(a), Occupied bandwidth			
Test procedure: 47 CFR, Section 2.1049			
Test mode: Compliance	Verdict: PASS		
Date(s): 03-Aug-14			
Temperature: 23.1 °C	Air Pressure: 1005 hPa	Relative Humidity: 41 %	Power Supply: 120 VAC
Remarks:			

Plot 7.2.25 Occupied bandwidth test result at low frequency carrier, Port 1

FRQUENCY RANGE:	758 - 775 MHz
OPERATIONAL MODE:	Analog FM downlink transmit
INPUT PORT:	Base
COMPOSITE INPUT POWER:	-54 dBm
INPUT POWER: -51 dBm	INPUT POWER: -21 dBm
CONFIGURATION:	Single Band

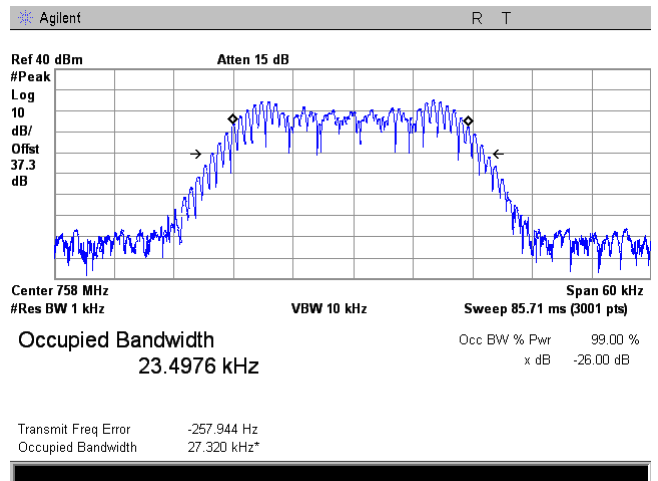
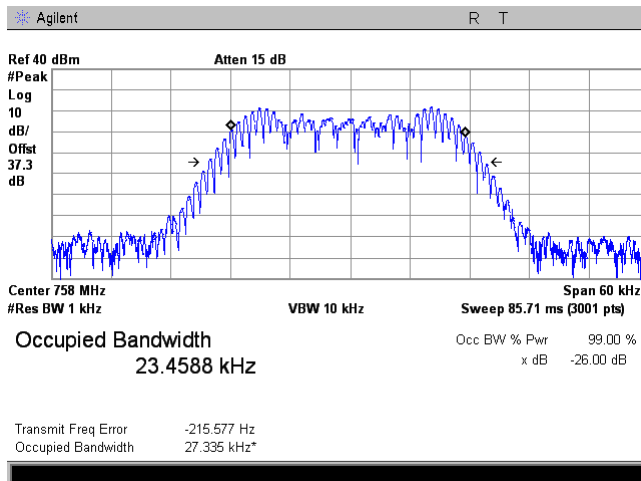

Plot 7.2.26 Occupied bandwidth test result at mid frequency carrier, Port 1

FRQUENCY RANGE:	758 - 775 MHz
OPERATIONAL MODE:	Analog FM downlink transmit
INPUT PORT:	Base
INPUT POWER: -51 dBm	INPUT POWER: -21 dBm
CONFIGURATION:	Single Band

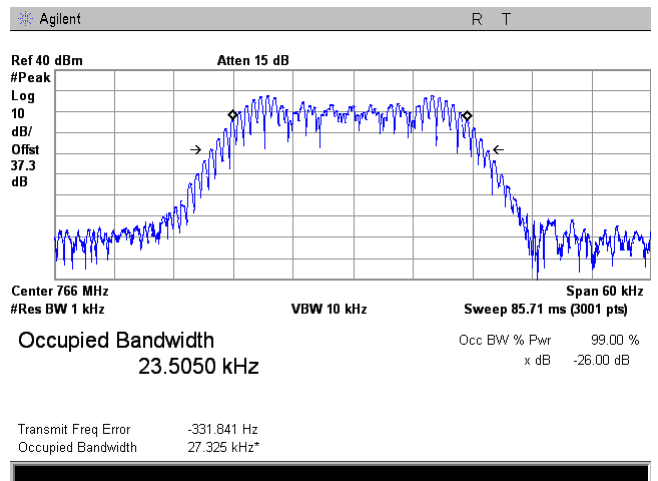
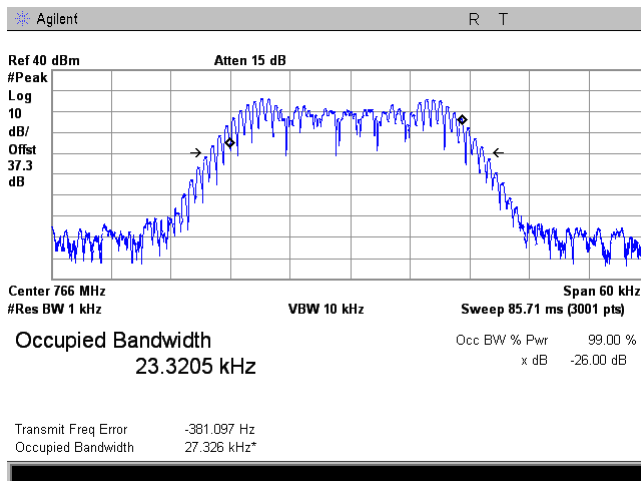

Test specification: Section 90.219(a), Occupied bandwidth			
Test procedure: 47 CFR, Section 2.1049			
Test mode: Compliance	Verdict: PASS		
Date(s): 03-Aug-14			
Temperature: 23.1 °C	Air Pressure: 1005 hPa	Relative Humidity: 41 %	Power Supply: 120 VAC
Remarks:			

Plot 7.2.27 Occupied bandwidth test result at high frequency carrier, Port 1

FRQUENCY RANGE:
OPERATIONAL MODE:
INPUT PORT:
INPUT POWER: -51 dBm
CONFIGURATION:

758 - 775 MHz
Analog FM downlink transmit
Base
INPUT POWER: -21 dBm
Single Band

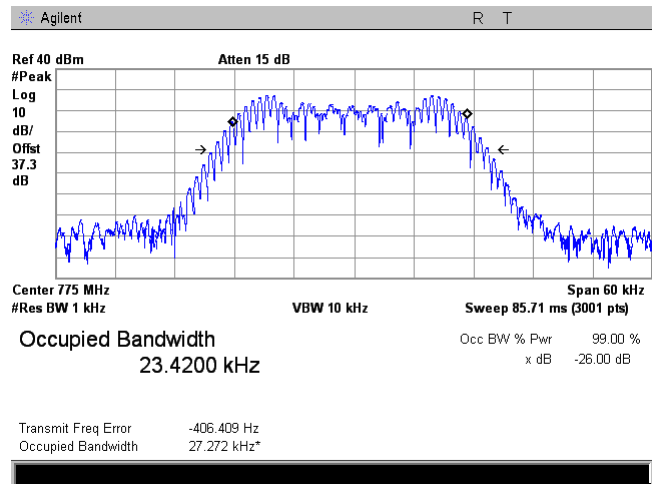
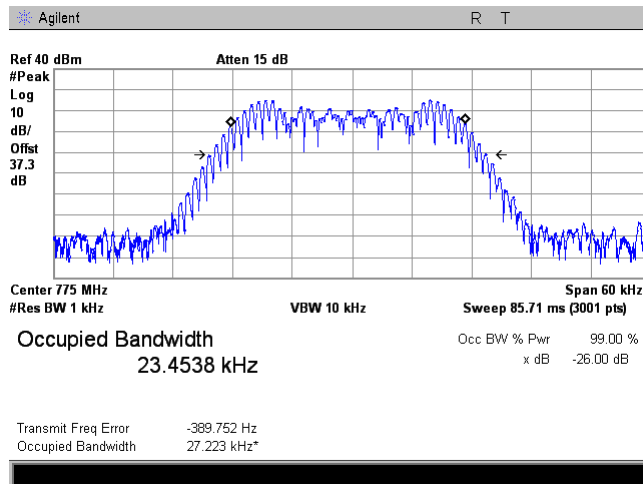

Plot 7.2.28 Occupied bandwidth test result at low frequency carrier, Port 2

FRQUENCY RANGE:
OPERATIONAL MODE:
INPUT PORT:
INPUT POWER: -54 dBm
CONFIGURATION:

788 - 805 MHz
Analog FM uplink transmit
Mobile
INPUT POWER: -24 dBm
Dual Band

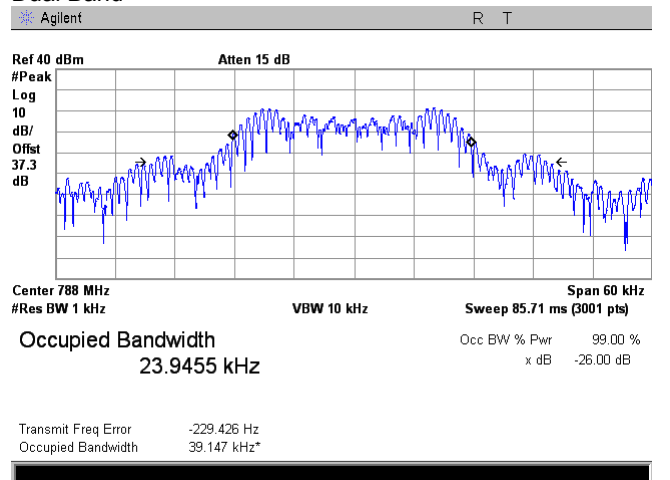
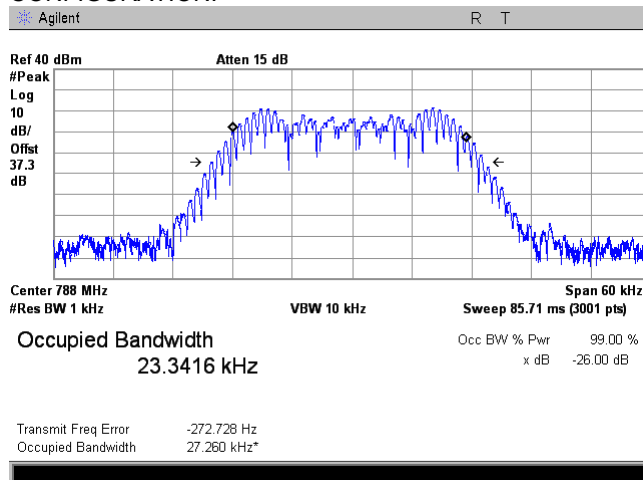

Test specification: Section 90.219(a), Occupied bandwidth			
Test procedure: 47 CFR, Section 2.1049			
Test mode: Compliance	Verdict: PASS		
Date(s): 03-Aug-14			
Temperature: 23.1 °C	Air Pressure: 1005 hPa	Relative Humidity: 41 %	Power Supply: 120 VAC
Remarks:			

Plot 7.2.29 Occupied bandwidth test result at mid frequency carrier, Port 2

FRQUENCY RANGE:
OPERATIONAL MODE:
INPUT PORT:
INPUT POWER: -54 dBm
CONFIGURATION:

788 - 805 MHz
Analog FM uplink transmit
Mobile
INPUT POWER: -24 dBm
Dual Band

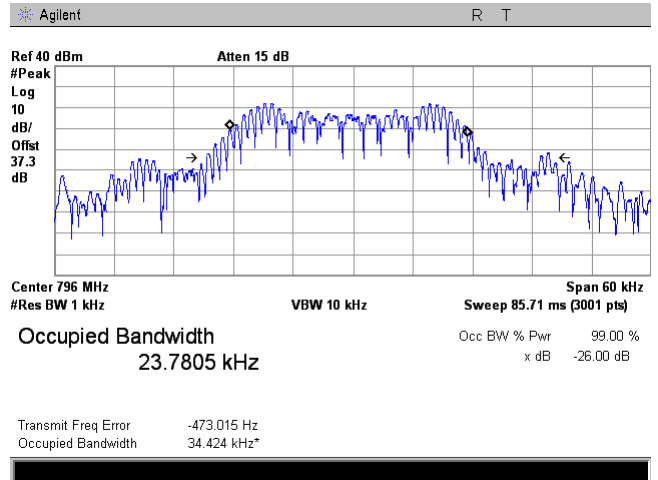
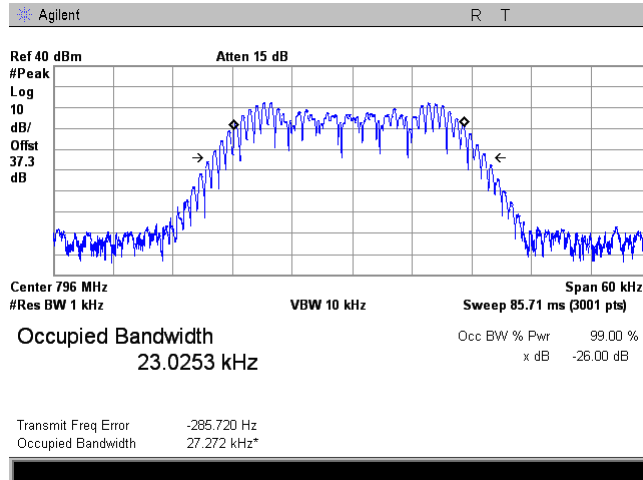

Plot 7.2.30 Occupied bandwidth test result at high frequency carrier, Port 2

FRQUENCY RANGE:
OPERATIONAL MODE:
INPUT PORT:
COMPOSITE INPUT POWER:
INPUT POWER: -54 dBm
CONFIGURATION:

788 - 805 MHz
Analog FM uplink transmit
Mobile
-54 dBm
INPUT POWER: -24 dBm
Dual Band

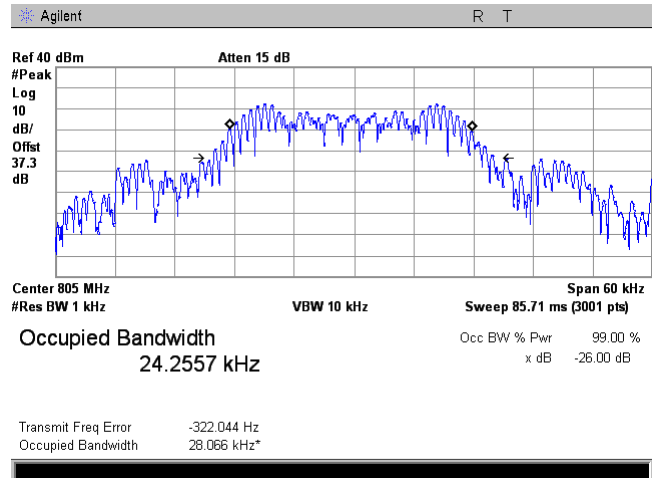
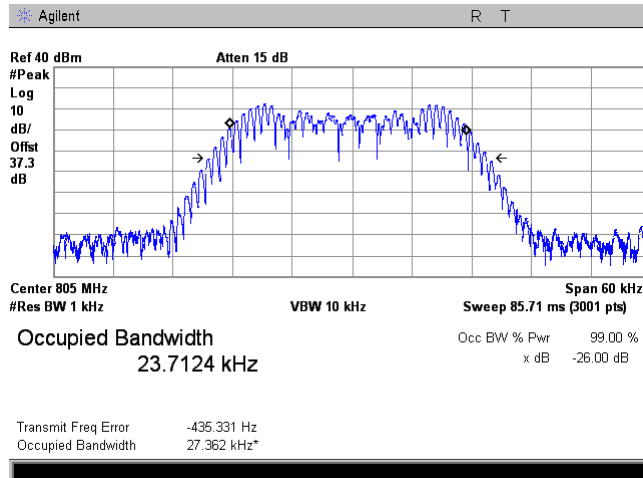

Test specification:		Section 90.219(a), Occupied bandwidth	
Test procedure:		47 CFR, Section 2.1049	
Test mode:		Compliance	
Date(s):		03-Aug-14	
Temperature: 23.1 °C		Air Pressure: 1005 hPa	
Remarks:		Verdict: PASS	
		Relative Humidity: 41 %	
		Power Supply: 120 VAC	

Plot 7.2.31 Occupied bandwidth test result at low frequency carrier, Port 1

FRQUENCY RANGE:
OPERATIONAL MODE:
INPUT PORT:
CONFIGURATION:
INPUT POWER: -54 dBm
CONFIGURATION:

851 - 861 MHz
Analog FM downlink transmit
Base
Dual Band
INPUT POWER: -24 dBm
Single Band

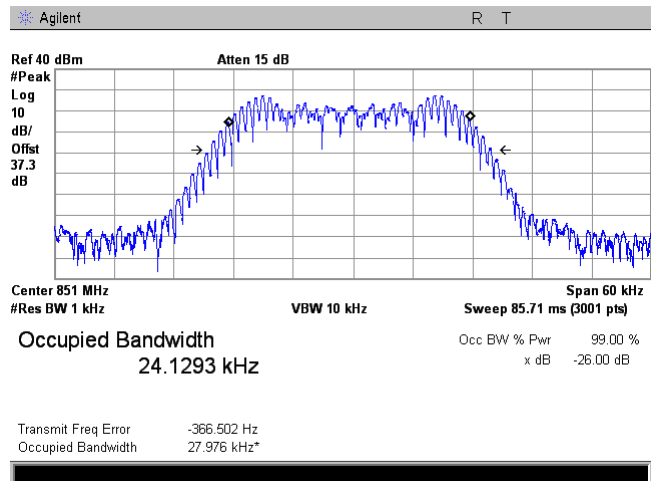
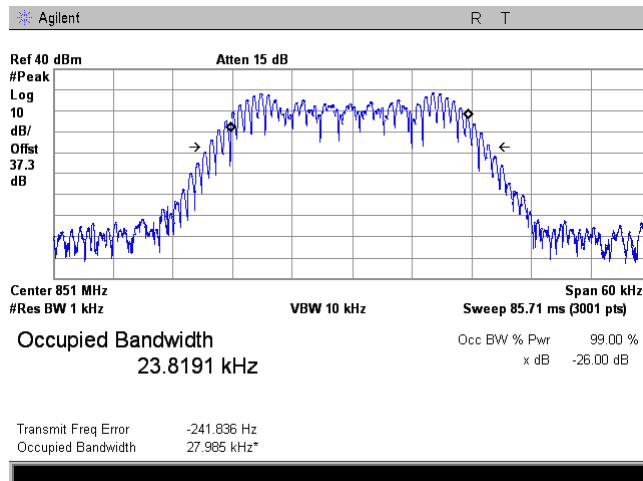

Plot 7.2.32 Occupied bandwidth test result at mid frequency carrier, Port 1

FRQUENCY RANGE:
OPERATIONAL MODE:
INPUT PORT:
INPUT POWER: -54 dBm
CONFIGURATION:

851 - 861 MHz
Analog FM downlink transmit
Base
INPUT POWER: -24 dBm
Single Band

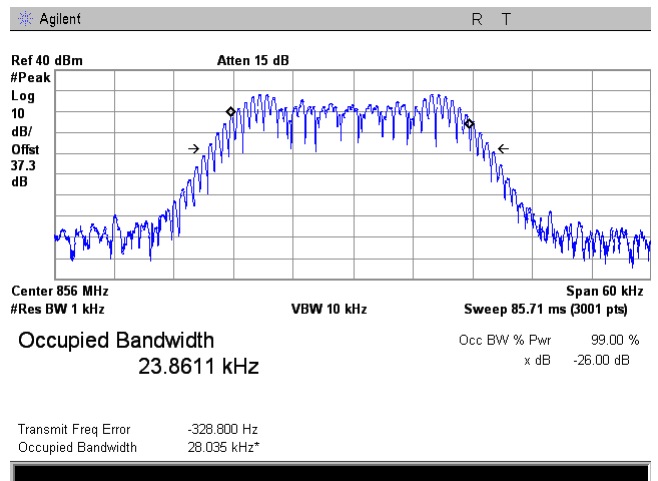
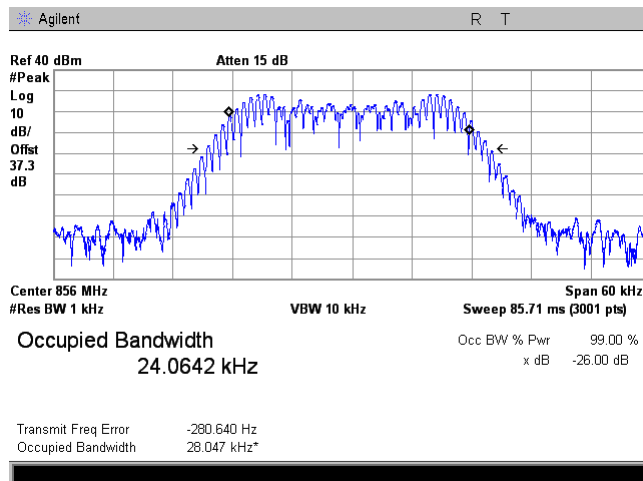

Test specification: Section 90.219(a), Occupied bandwidth			
Test procedure: 47 CFR, Section 2.1049			
Test mode: Compliance	Verdict: PASS		
Date(s): 03-Aug-14			
Temperature: 23.1 °C	Air Pressure: 1005 hPa	Relative Humidity: 41 %	Power Supply: 120 VAC
Remarks:			

Plot 7.2.33 Occupied bandwidth test result at high frequency carrier, Port 1

FRQUENCY RANGE:
OPERATIONAL MODE:
INPUT PORT:
INPUT POWER: -54 dBm
CONFIGURATION:

851 - 861 MHz
Analog FM downlink transmit
Base
INPUT POWER: -24 dBm
Single Band

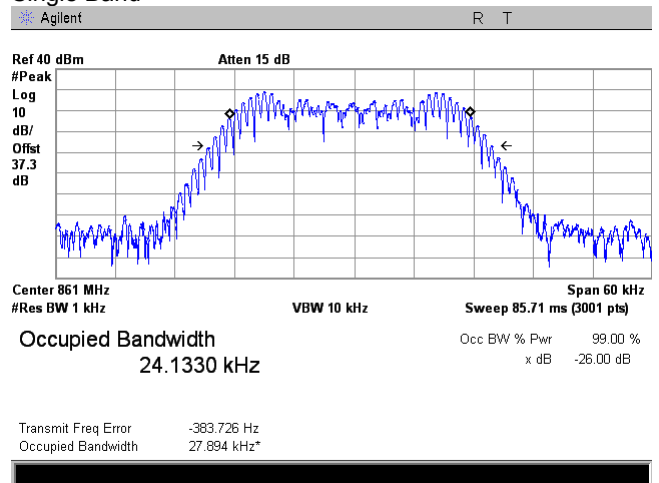
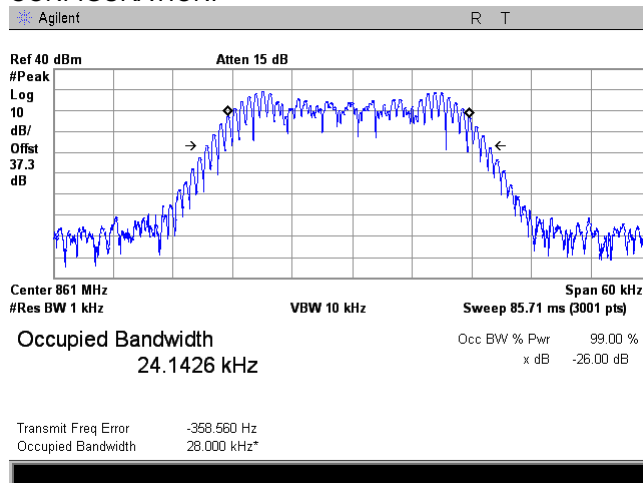

Plot 7.2.34 Occupied bandwidth test result at low frequency carrier, Port 2

FRQUENCY RANGE:
OPERATIONAL MODE:
INPUT PORT:
INPUT POWER: -54 dBm
CONFIGURATION:

806 - 816 MHz
Analog FM downlink transmit
Mobile
INPUT POWER: -24 dBm
Dual Band

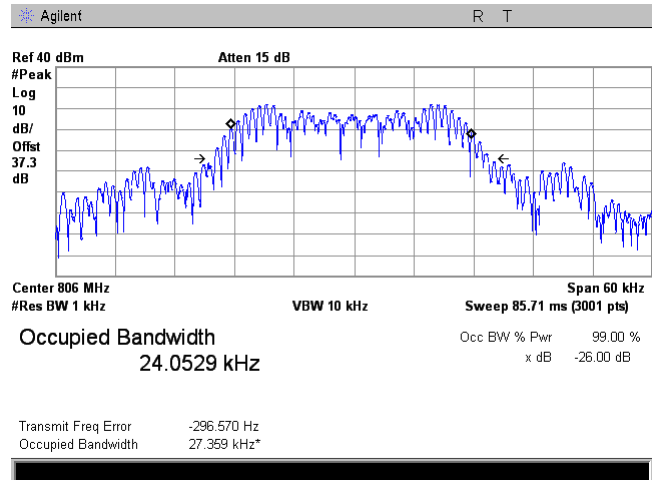
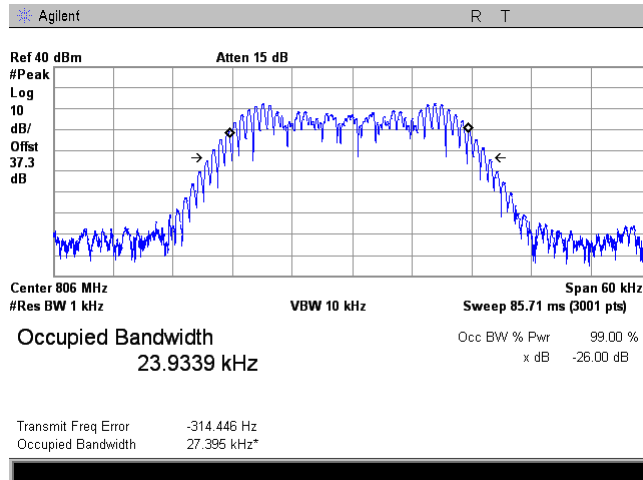

Test specification: Section 90.219(a), Occupied bandwidth			
Test procedure: 47 CFR, Section 2.1049			
Test mode: Compliance	Verdict: PASS		
Date(s): 03-Aug-14			
Temperature: 23.1 °C	Air Pressure: 1005 hPa	Relative Humidity: 41 %	Power Supply: 120 VAC
Remarks:			

Plot 7.2.35 Occupied bandwidth test result at mid frequency carrier, Port 2

FRQUENCY RANGE:
OPERATIONAL MODE:
INPUT PORT:
INPUT POWER: -54 dBm
CONFIGURATION:

806 - 816 MHz
Analog FM uplink transmit
Mobile
INPUT POWER: -24 dBm
Dual Band

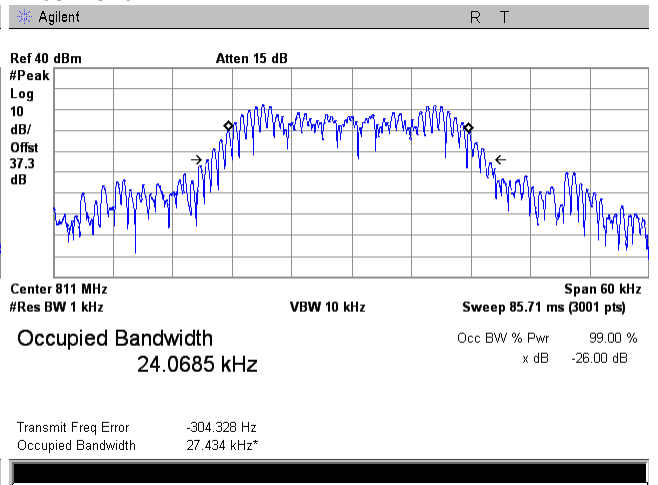
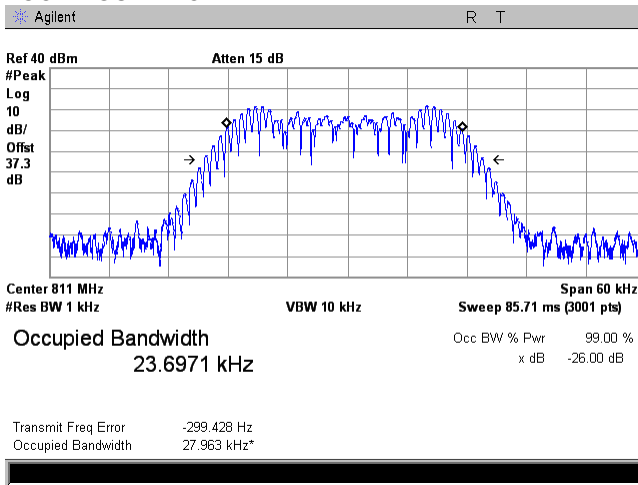

Plot 7.2.36 Occupied bandwidth test result at high frequency carrier, Port 2

FRQUENCY RANGE:
OPERATIONAL MODE:
INPUT PORT:
INPUT POWER: -54 dBm
CONFIGURATION:

806 - 816 MHz
Analog FM uplink transmit
Mobile
INPUT POWER: -24 dBm
Dual Band

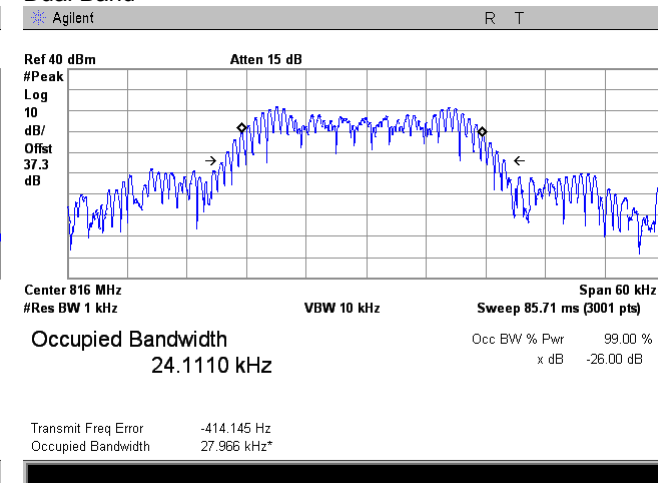
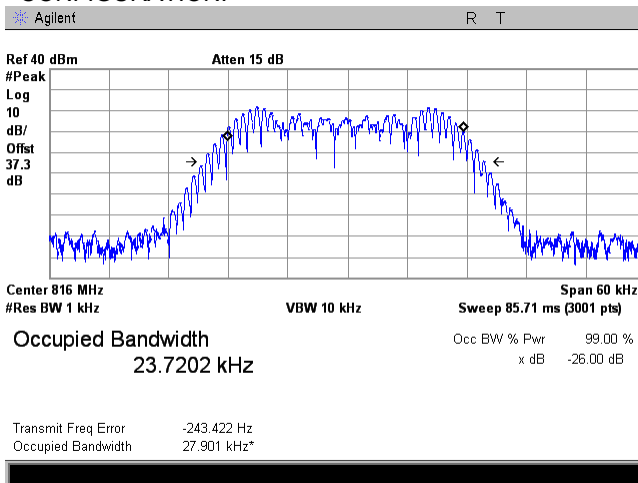

Test specification:	Section 90.210(b), Emission mask		
Test procedure:	47 CFR, Sections 2.1051, 2.1047 and 90.210(b)		
Test mode:	Compliance	Verdict:	PASS
Date(s):	05-Aug-14 - 07-Aug-14		
Temperature: 23.3 °C	Air Pressure: 1004 hPa	Relative Humidity: 40 %	Power Supply: 120 VAC
Remarks:			

7.3 Emission mask test

7.3.1 General

This test was performed to measure emission mask at RF antenna connector. Specification test limits are given in Table 7.3.1.

Table 7.3.1 Emission mask limits

Frequency displacement from carrier	Attenuation below carrier, dBc
Emission mask B (Channel bandwidth 10 kHz, authorized bandwidth 8 kHz) with audio low pass filter	
0 – 4.0 kHz	0
4.0 – 8.0 kHz	25.0
8.0 – 20.0 kHz	35.0
More than 20.0 kHz	43+10logP(W)
Emission mask B (Channel bandwidth 20.0 kHz, authorized bandwidth 18.0 kHz)	
0 – 9.0 kHz	0
9.0 – 18.0 kHz	25.0
18.0 – 45.0 kHz	35.0
More than 45.0 kHz	43+10logP(W)
Emission mask B (Channel bandwidth 25.0 kHz, authorized bandwidth 23.0 kHz)	
0 – 11.5 kHz	0
11.5 – 23.0 kHz	25.0
23.0 – 11.5 kHz	35.0
More than 23.0 kHz	43+10logP(W)

* - linearly increase with frequency

** - emission mask includes carrier modulation envelope within ± 250 % of the authorized bandwidth; the frequency range removed beyond ± 250 % of the authorized bandwidth from carrier was investigated as spurious emission

7.3.2 Test procedure

7.3.2.1 The EUT was set up as shown in Figure 7.3.1, energized and its proper operation was checked.

7.3.2.2 The emission mask was measured with spectrum analyzer as provided in Table 7.3.2 and the associated plots.

Figure 7.3.1 Emission mask test setup

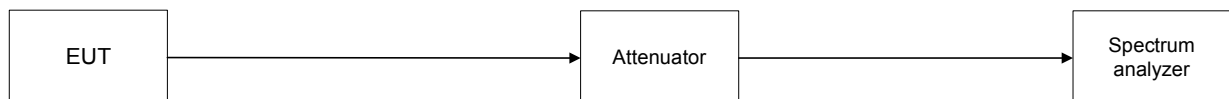



HERMON LABORATORIES

Test specification:	Section 90.210(b), Emission mask		
Test procedure:	47 CFR, Sections 2.1051, 2.1047 and 90.210(b)		
Test mode:	Compliance	Verdict:	PASS
Date(s):	05-Aug-14 - 07-Aug-14		
Temperature: 23.3 °C	Air Pressure: 1004 hPa	Relative Humidity: 40 %	Power Supply: 120 VAC
Remarks:			

Table 7.3.2 Emission mask test results

Carrier frequency, MHz	Limit	Verdict
Downlink 758 – 775 MHz		
758.0	Emission mask B	Pass
766.0		
775.0		
Uplink 788 – 805 MHz		
788.0	Emission mask B	Pass
796.0		
805.0		
Downlink 851 – 861 MHz		
851.0	Emission mask B	Pass
856.0		
861.0		
Uplink 806 – 816 MHz		
806.0	Emission mask B	Pass
811.0		
816.0		

Reference numbers of test equipment used

HL 0539	HL 2909	HL 3301	HL 3302	HL 3768	HL 3770	HL 3776	HL 4273	HL 4275
HL 4354	HL 4413							

Full description is given in Appendix A.

Test specification: Section 90.210(b), Emission mask			
Test procedure: 47 CFR, Sections 2.1051, 2.1047 and 90.210(b)			
Test mode: Compliance	Verdict: PASS		
Date(s): 05-Aug-14 - 07-Aug-14			
Temperature: 23.3 °C	Air Pressure: 1004 hPa	Relative Humidity: 40 %	Power Supply: 120 VAC
Remarks:			

Plot 7.3.1 Reference level test results at low carrier frequency, Port 1

FREQUENCY RANGE:
REFERENCE LEVEL:
CONFIGURATION:
INPUT POWER: -51 dBm

758 - 775 MHz
Unmodulated power
Single Band
INPUT POWER: -21 dBm

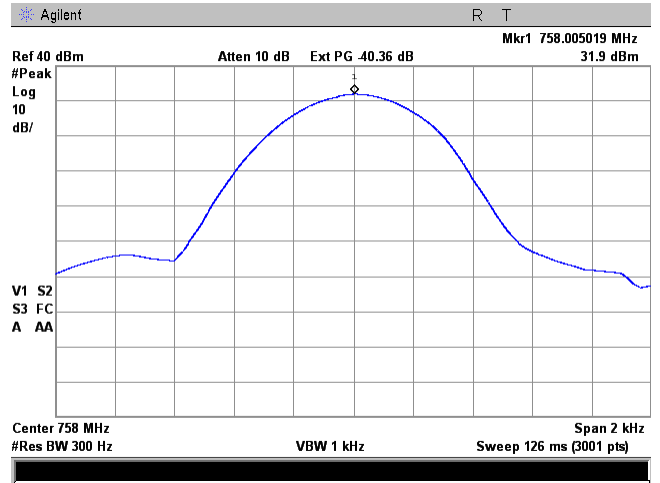
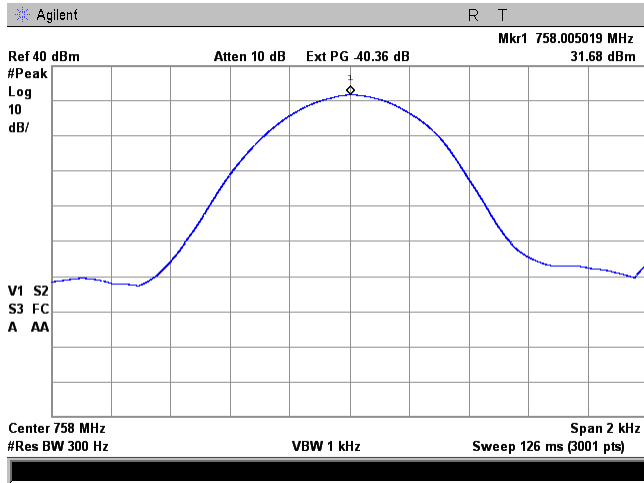

Plot 7.3.2 Reference level test results at mid carrier frequency, Port 1

FREQUENCY RANGE:
REFERENCE LEVEL:
CONFIGURATION:
INPUT POWER: -51 dBm

758 - 775 MHz
Unmodulated power
Single Band
INPUT POWER: -21 dBm

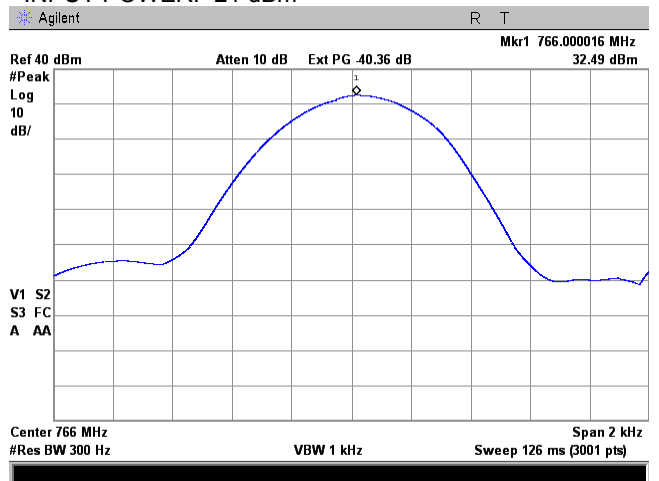
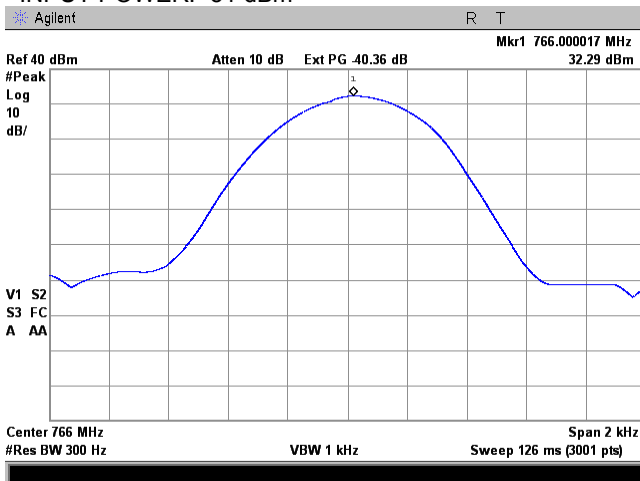

Test specification:		Section 90.210(b), Emission mask	
Test procedure:		47 CFR, Sections 2.1051, 2.1047 and 90.210(b)	
Test mode:		Compliance	
Date(s):		05-Aug-14 - 07-Aug-14	
Temperature: 23.3 °C		Air Pressure: 1004 hPa	
		Relative Humidity: 40 %	
		Power Supply: 120 VAC	
Remarks:			
		Verdict: PASS	

Plot 7.3.3 Reference level test results at high carrier frequency, Port 1

FREQUENCY RANGE:
REFERENCE LEVEL:
CONFIGURATION: Single Band
INPUT POWER: -51 dBm

758 - 775 MHz
Unmodulated power
Single Band
INPUT POWER: -21 dBm

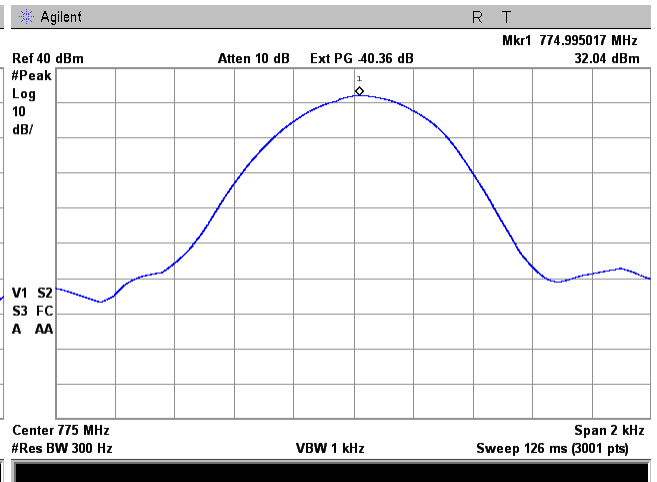
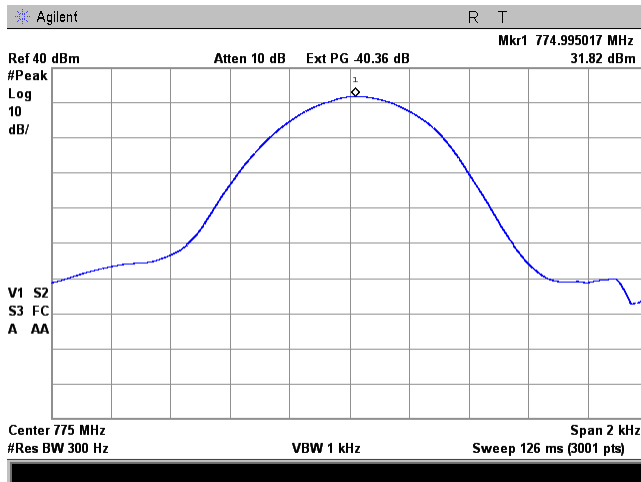

Plot 7.3.4 Reference level test results at low carrier frequency, Port 1

FREQUENCY RANGE:
REFERENCE LEVEL:
CONFIGURATION: Single Band
INPUT POWER: -54 dBm

788 - 805 MHz
Unmodulated power
Single Band
INPUT POWER: -24 dBm

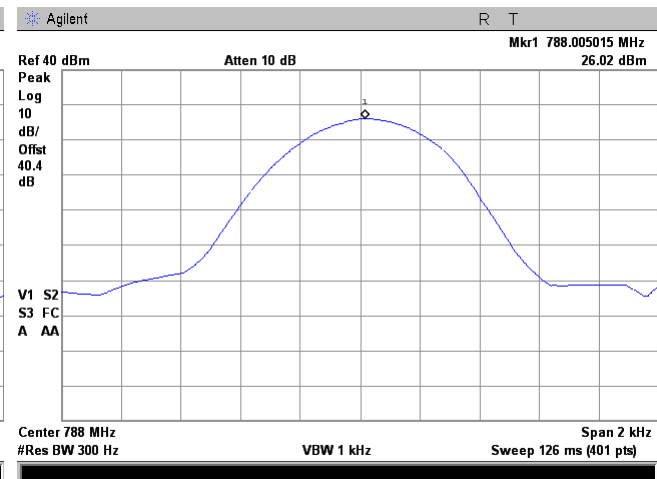
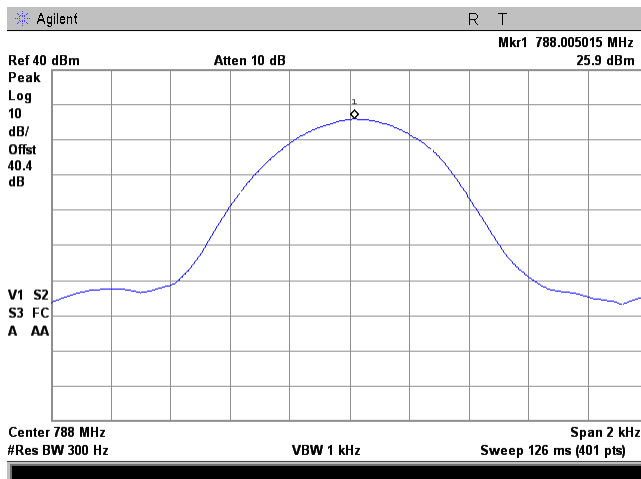

Test specification:		Section 90.210(b), Emission mask	
Test procedure:		47 CFR, Sections 2.1051, 2.1047 and 90.210(b)	
Test mode:		Compliance	
Date(s):		05-Aug-14 - 07-Aug-14	
Temperature: 23.3 °C		Air Pressure: 1004 hPa	
		Relative Humidity: 40 %	
		Power Supply: 120 VAC	
Remarks:			
		Verdict: PASS	

Plot 7.3.5 Reference level test results at mid carrier frequency, Port 1

FREQUENCY RANGE:
REFERENCE LEVEL:
CONFIGURATION: Single Band
INPUT POWER: -54 dBm

788 - 805 MHz
Unmodulated power
Single Band
INPUT POWER: -24 dBm

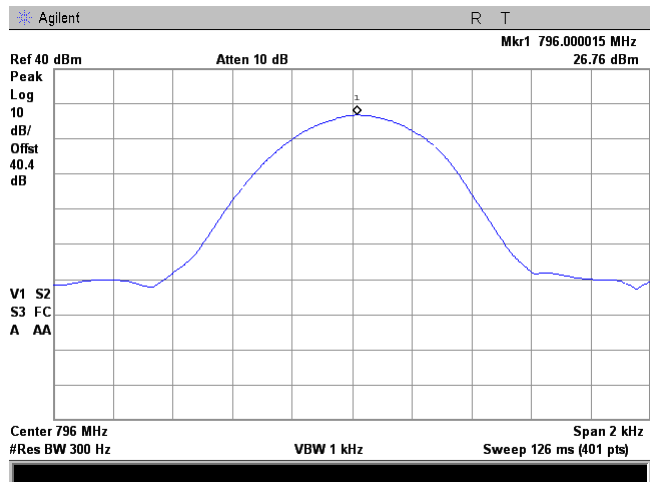
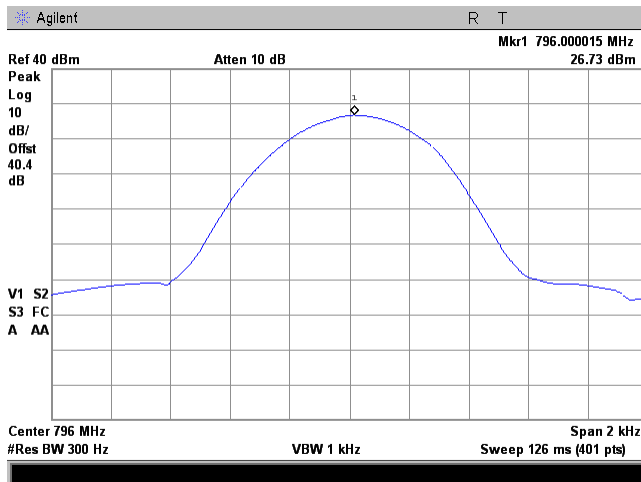

Plot 7.3.6 Reference level test results at high carrier frequency, Port 1

FREQUENCY RANGE:
REFERENCE LEVEL:
CONFIGURATION: Single Band
INPUT POWER: -54 dBm

788 - 805 MHz
Unmodulated power
Single Band
INPUT POWER: -24 dBm

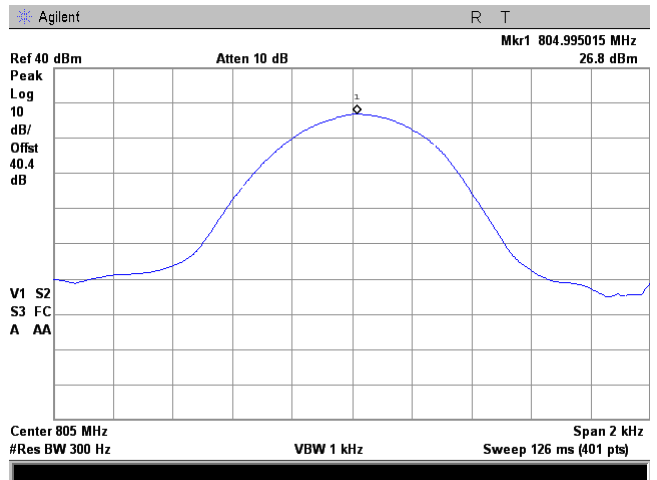
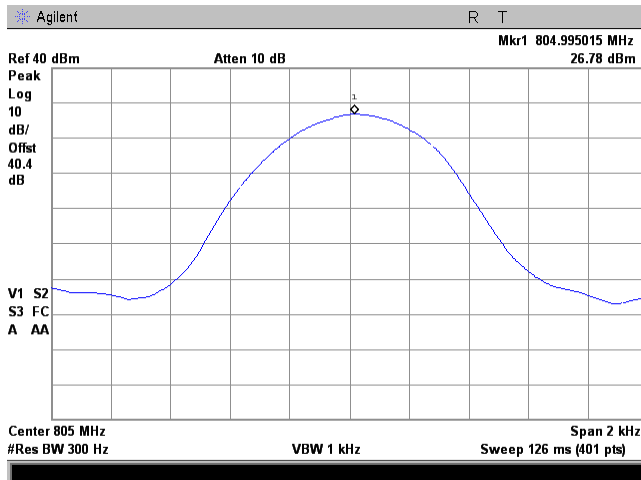

Test specification:	Section 90.210(b), Emission mask		
Test procedure:	47 CFR, Sections 2.1051, 2.1047 and 90.210(b)		
Test mode:	Compliance	Verdict:	PASS
Date(s):	05-Aug-14 - 07-Aug-14		
Temperature: 23.3 °C	Air Pressure: 1004 hPa	Relative Humidity: 40 %	Power Supply: 120 VAC
Remarks:			

Plot 7.3.7 Reference level test results at low carrier frequency, Port 1

FREQUENCY RANGE:
REFERENCE LEVEL:
CONFIGURATION: Single Band
INPUT POWER: -51 dBm

851 - 861 MHz
Unmodulated power
Single Band
INPUT POWER: -21 dBm

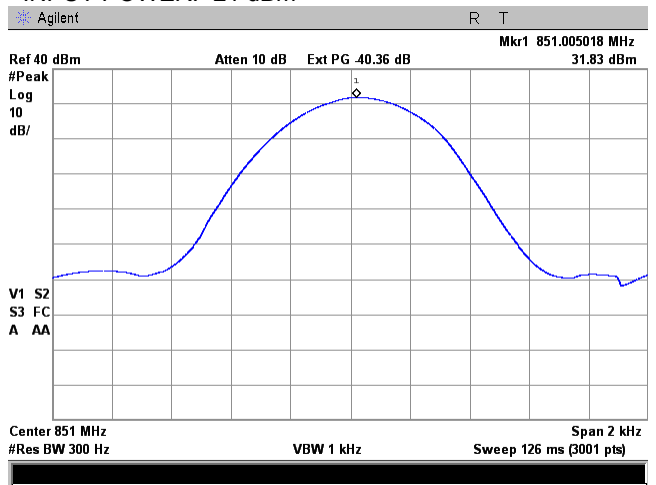
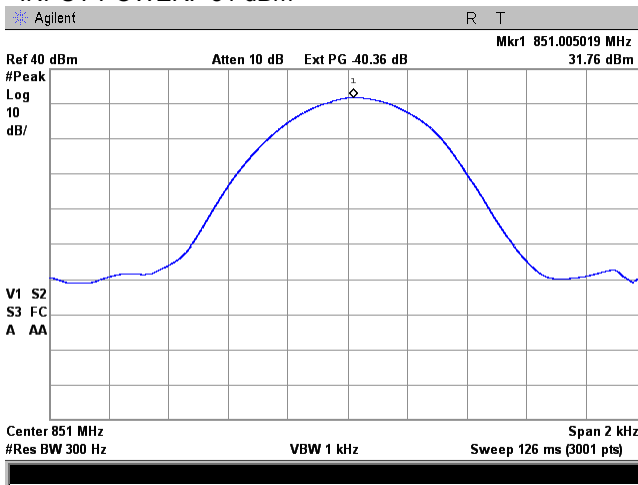

Plot 7.3.8 Reference level test results at mid carrier frequency, Port 1

FREQUENCY RANGE:
REFERENCE LEVEL:
CONFIGURATION: Single Band
INPUT POWER: -51 dBm

851 - 861 MHz
Unmodulated power
Single Band
INPUT POWER: -21 dBm

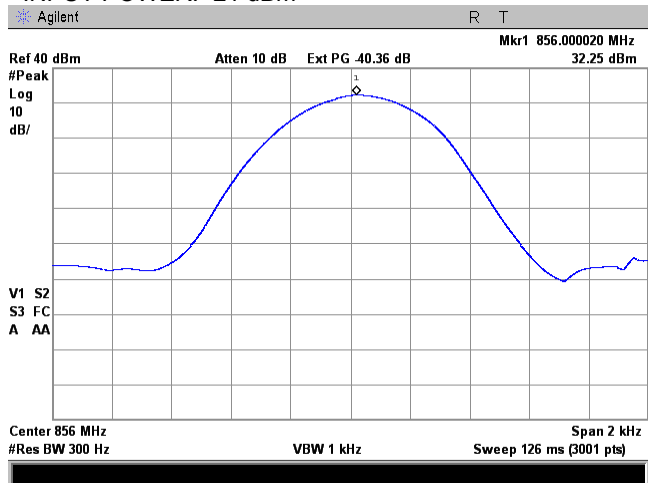
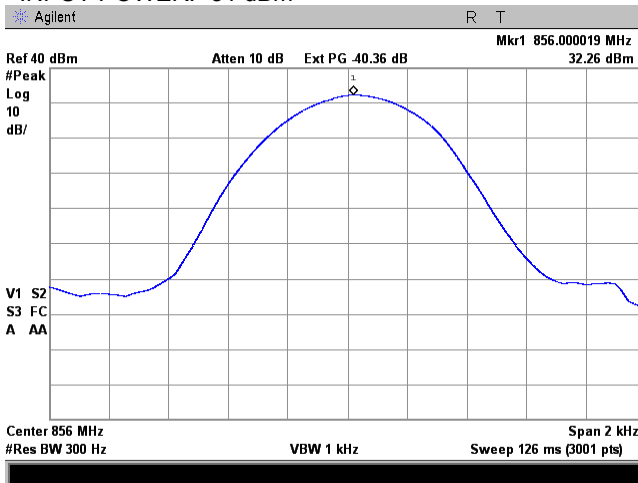

Test specification:		Section 90.210(b), Emission mask	
Test procedure:		47 CFR, Sections 2.1051, 2.1047 and 90.210(b)	
Test mode:		Compliance	
Date(s):		05-Aug-14 - 07-Aug-14	
Temperature: 23.3 °C		Air Pressure: 1004 hPa	
		Relative Humidity: 40 %	
		Power Supply: 120 VAC	
Remarks:			
		Verdict: PASS	

Plot 7.3.9 Reference level test results at high carrier frequency, Port 1

FREQUENCY RANGE:
REFERENCE LEVEL:
CONFIGURATION: Single Band
INPUT POWER: -51 dBm

851 - 861 MHz
Unmodulated power
Single Band
INPUT POWER: -21 dBm

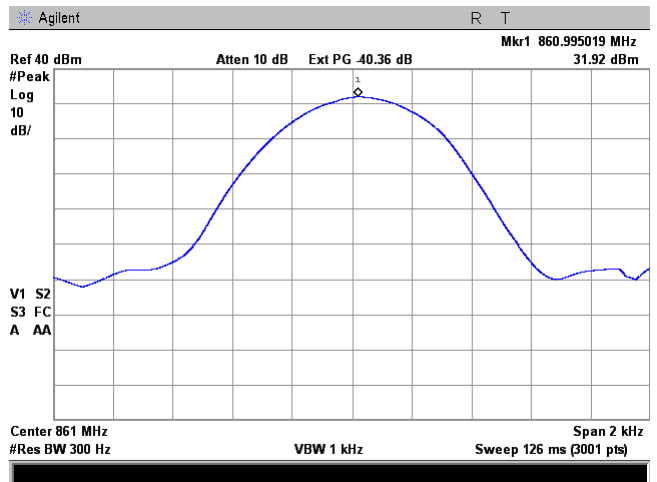
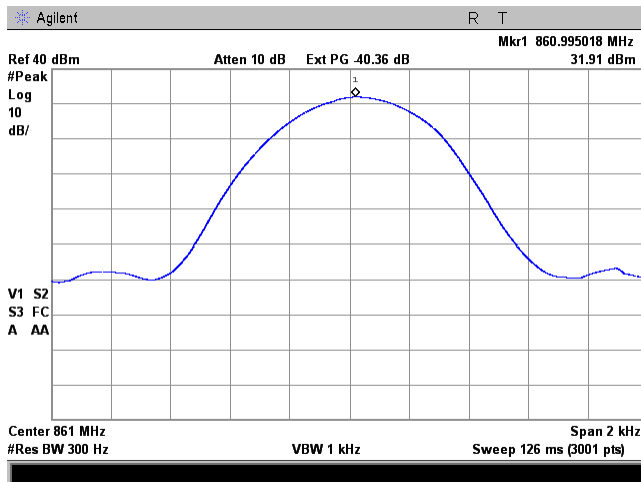

Plot 7.3.10 Reference level test results at low carrier frequency, Port 1

FREQUENCY RANGE:
REFERENCE LEVEL:
CONFIGURATION: Single Band
INPUT POWER: -54 dBm

806 - 816 MHz
Unmodulated power
Single Band
INPUT POWER: -24 dBm

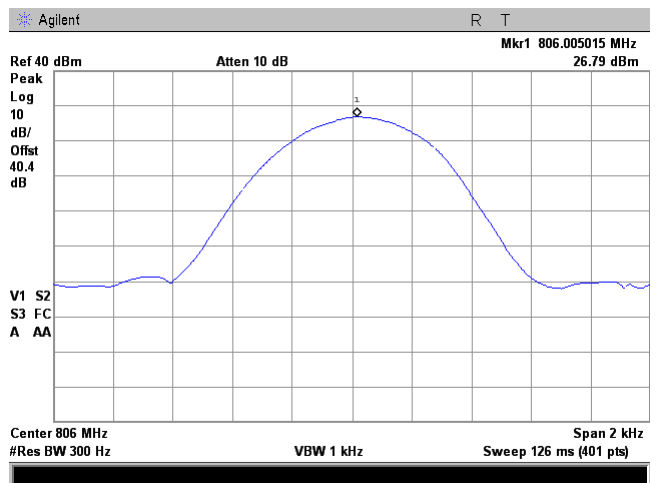
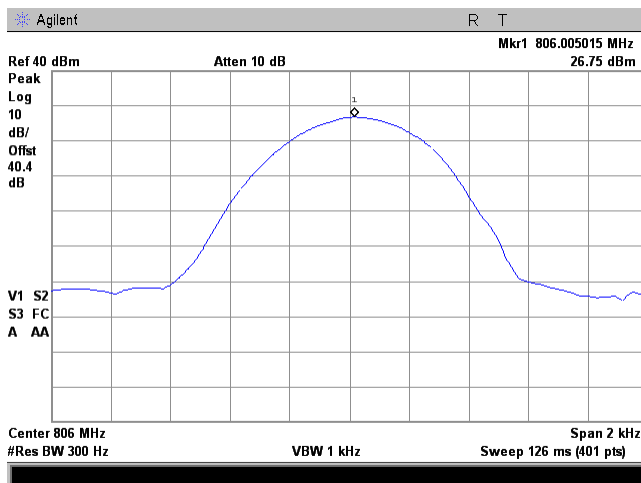

Test specification:		Section 90.210(b), Emission mask	
Test procedure:		47 CFR, Sections 2.1051, 2.1047 and 90.210(b)	
Test mode:		Compliance	
Date(s):		05-Aug-14 - 07-Aug-14	
Temperature: 23.3 °C		Air Pressure: 1004 hPa	
		Relative Humidity: 40 %	
		Power Supply: 120 VAC	
Remarks:			
		Verdict: PASS	

Plot 7.3.11 Reference level test results at mid carrier frequency, Port 1

FREQUENCY RANGE:
REFERENCE LEVEL:
CONFIGURATION: Single Band
INPUT POWER: -54 dBm

806 - 816 MHz
Unmodulated power
Single Band
INPUT POWER: -24 dBm

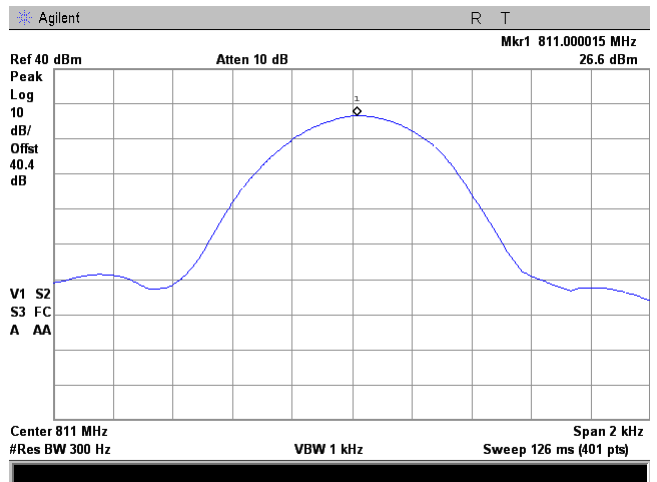
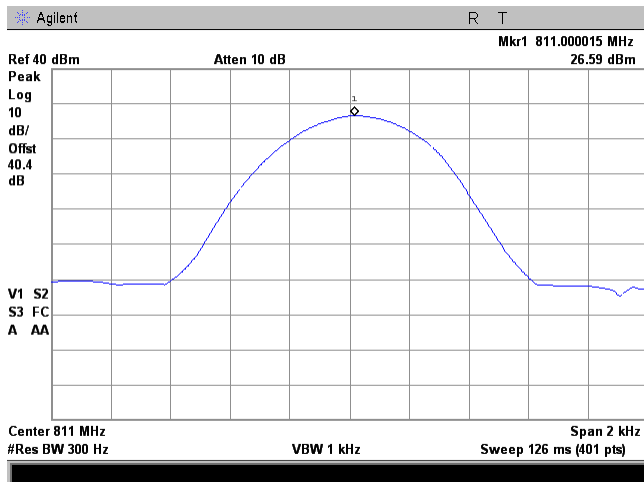

Plot 7.3.12 Reference level test results at high carrier frequency, Port 1

FREQUENCY RANGE:
REFERENCE LEVEL:
CONFIGURATION: Single Band
INPUT POWER: -54 dBm

806 - 816 MHz
Unmodulated power
CONFIGURATION: Single Band
INPUT POWER: -24 dBm

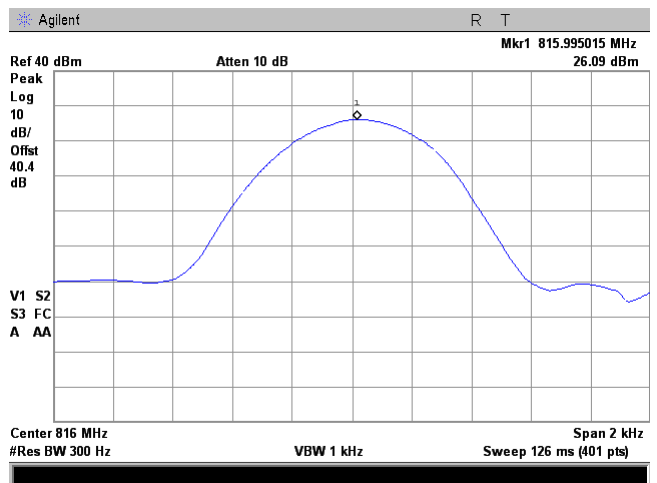
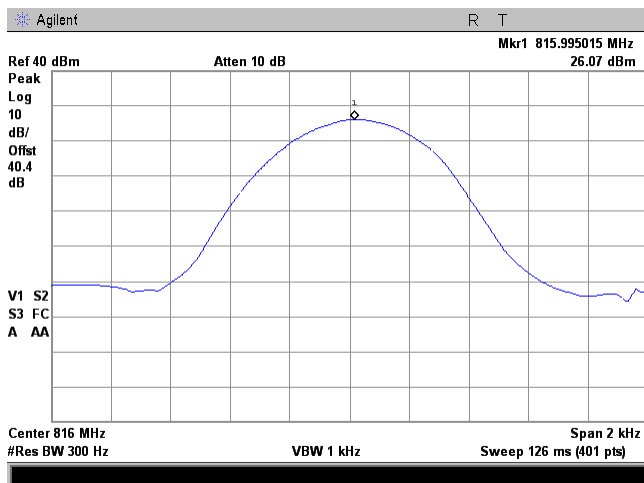

Test specification:		Section 90.210(b), Emission mask	
Test procedure:		47 CFR, Sections 2.1051, 2.1047 and 90.210(b)	
Test mode:		Compliance	
Date(s):		05-Aug-14 - 07-Aug-14	
Temperature: 23.3 °C		Air Pressure: 1004 hPa	
		Relative Humidity: 40 %	
		Power Supply: 120 VAC	
Remarks:			
		Verdict: PASS	

Plot 7.3.13 Emission mask test results at low carrier frequency, Port 1

FREQUENCY RANGE:
OPERATIONAL MODE:
INPUT PORT:
EMISSION MASK:
CONFIGURATION:
INPUT POWER: -51 dBm

758 - 775 MHz
C4FM downlink transmit
Base
90.210(B)
Single Band
INPUT POWER: -21 dBm

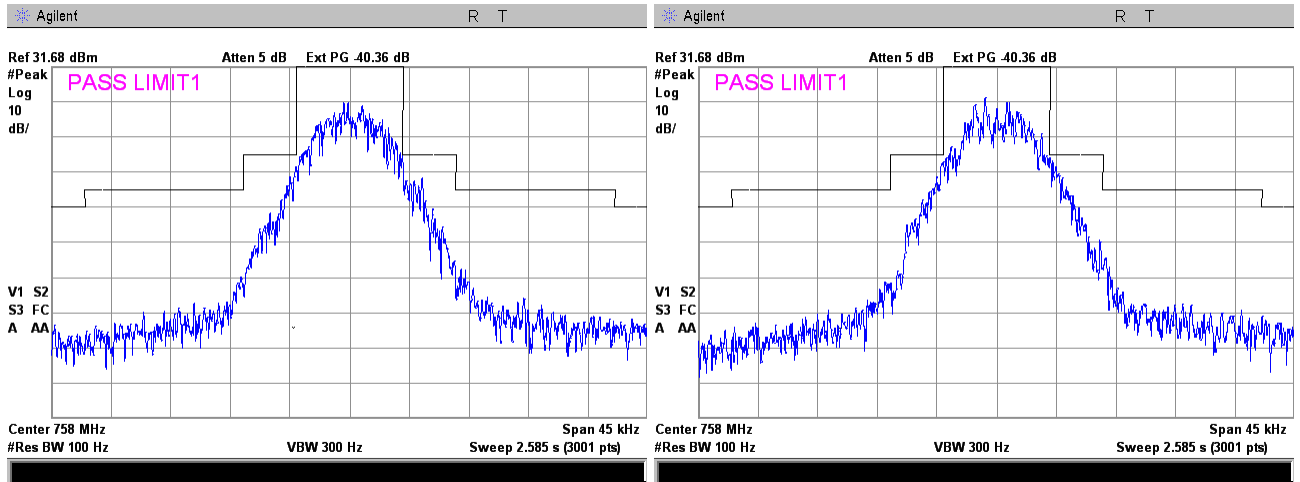

Plot 7.3.14 Emission mask test result at mid frequency carrier, Port 1

FREQUENCY RANGE:
OPERATIONAL MODE:
INPUT PORT:
EMISSION MASK:
CONFIGURATION:
INPUT POWER: -51 dBm

758 - 775 MHz
C4FM downlink transmit
Base
90.210(B)
Single Band
INPUT POWER: -21 dBm

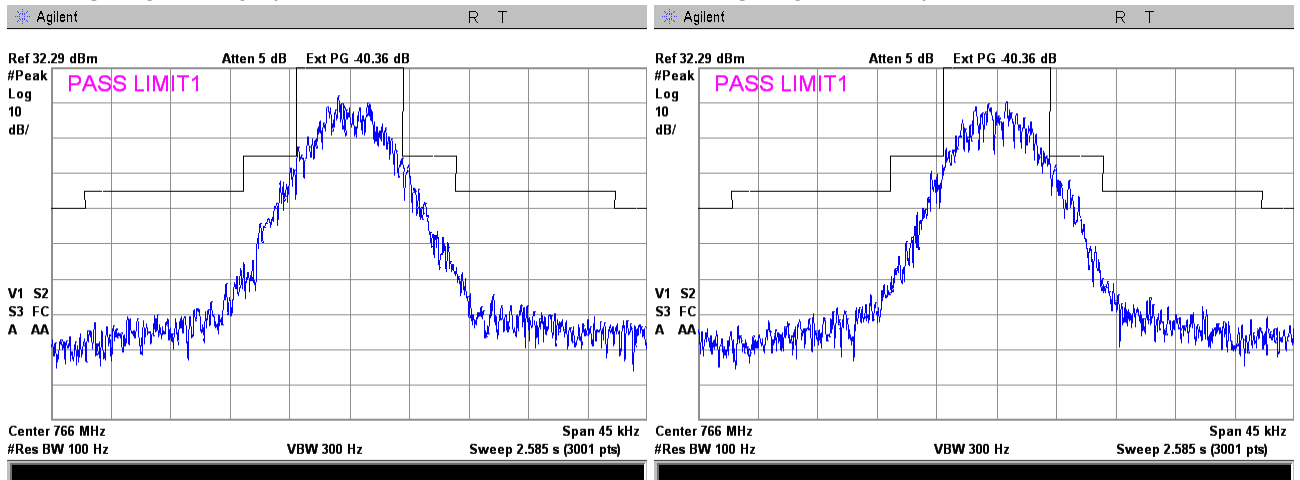



HERMON LABORATORIES

Test specification:	Section 90.210(b), Emission mask		
Test procedure:	47 CFR, Sections 2.1051, 2.1047 and 90.210(b)		
Test mode:	Compliance	Verdict:	PASS
Date(s):	05-Aug-14 - 07-Aug-14		
Temperature: 23.3 °C	Air Pressure: 1004 hPa	Relative Humidity: 40 %	Power Supply: 120 VAC
Remarks:			

Plot 7.3.15 Emission mask test result at high frequency carrier, Port 1

FREQUENCY RANGE:
 OPERATIONAL MODE:
 INPUT PORT:
 EMISSION MASK:
 CONFIGURATION:
 INPUT POWER: -51 dBm

758 - 775 MHz
 C4FM downlink transmit
 Base
 90.210(B)
 Single Band
 INPUT POWER: -21 dBm

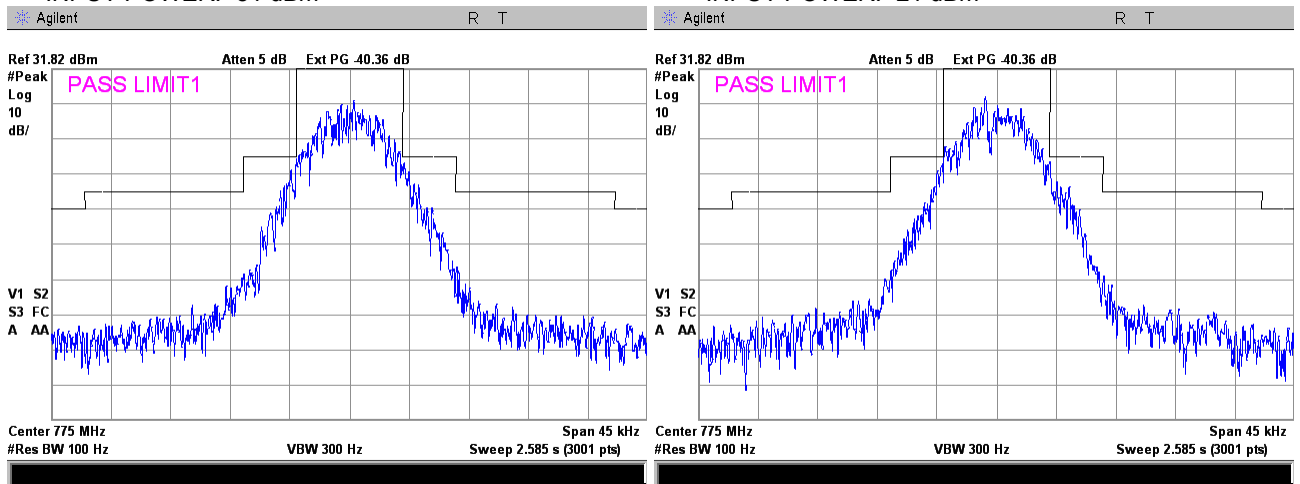

Test specification:		Section 90.210(b), Emission mask	
Test procedure:		47 CFR, Sections 2.1051, 2.1047 and 90.210(b)	
Test mode:		Compliance	
Date(s):		05-Aug-14 - 07-Aug-14	
Temperature: 23.3 °C		Air Pressure: 1004 hPa	
		Relative Humidity: 40 %	
		Power Supply: 120 VAC	
Remarks:			
		Verdict: PASS	

Plot 7.3.16 Emission mask test result at low frequency carrier, Port 2

FREQUENCY RANGE:
OPERATIONAL MODE:
INPUT PORT:
EMISSION MASK:
INPUT POWER: -54 dBm

788 - 805 MHz
C4FM uplink transmit
Mobile
90.210(B)
INPUT POWER: -24 dBm

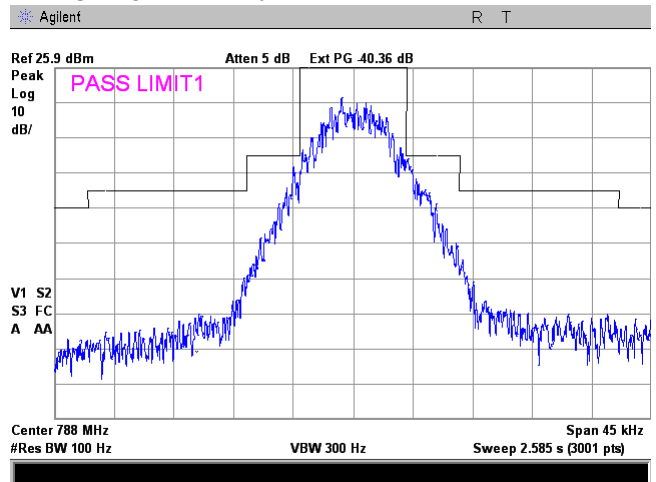
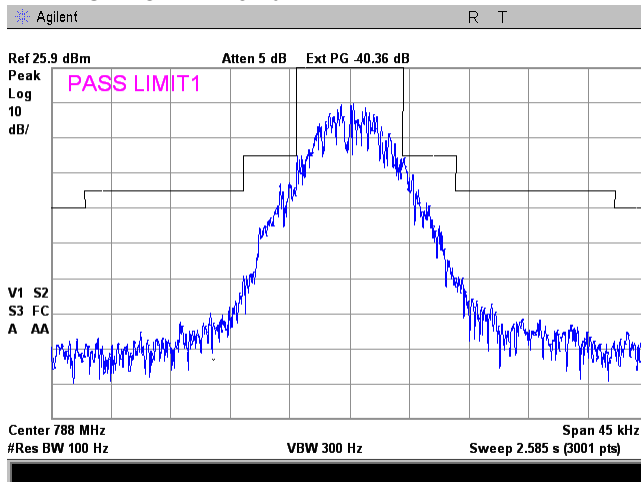

Plot 7.3.17 Emission mask test result at mid frequency carrier, Port 2

FREQUENCY RANGE:
OPERATIONAL MODE:
INPUT PORT:
EMISSION MASK:
INPUT POWER: -54 dBm

788 - 805 MHz
C4FM uplink transmit
Mobile
90.210(B)
INPUT POWER: -24 dBm

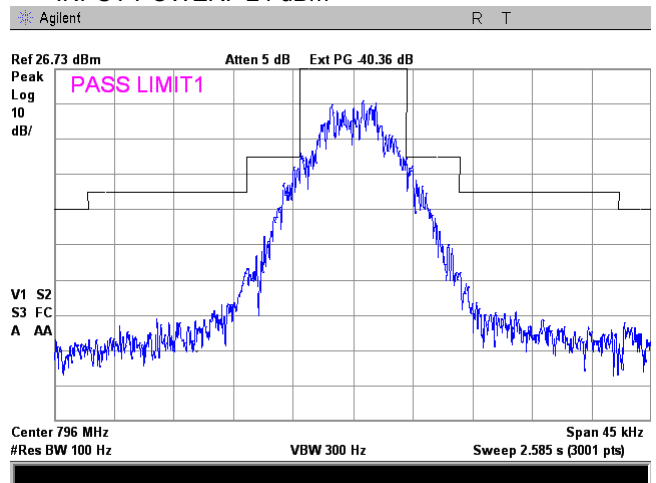
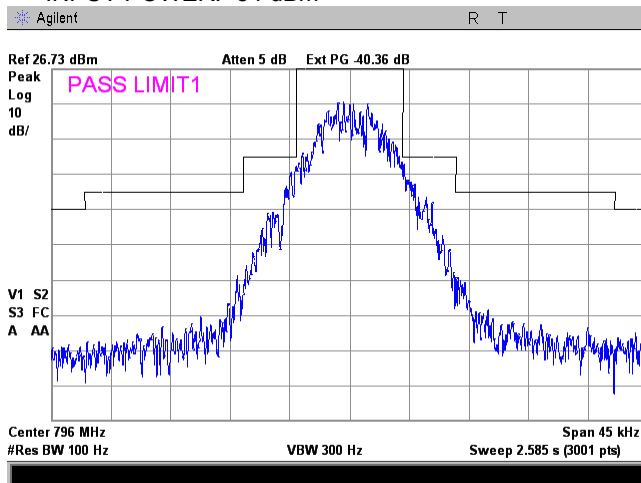

Test specification:		Section 90.210(b), Emission mask	
Test procedure:		47 CFR, Sections 2.1051, 2.1047 and 90.210(b)	
Test mode:		Compliance	
Date(s):		05-Aug-14 - 07-Aug-14	
Temperature: 23.3 °C		Air Pressure: 1004 hPa	
		Relative Humidity: 40 %	
		Power Supply: 120 VAC	
Remarks:			
		Verdict: PASS	

Plot 7.3.18 Emission mask test result at high frequency carrier, Port 2

FREQUENCY RANGE:
OPERATIONAL MODE:
INPUT PORT:
EMISSION MASK:
INPUT POWER: -54 dBm

788 - 805 MHz
C4FM uplink transmit
Mobile
90.210(B)
INPUT POWER: -24 dBm

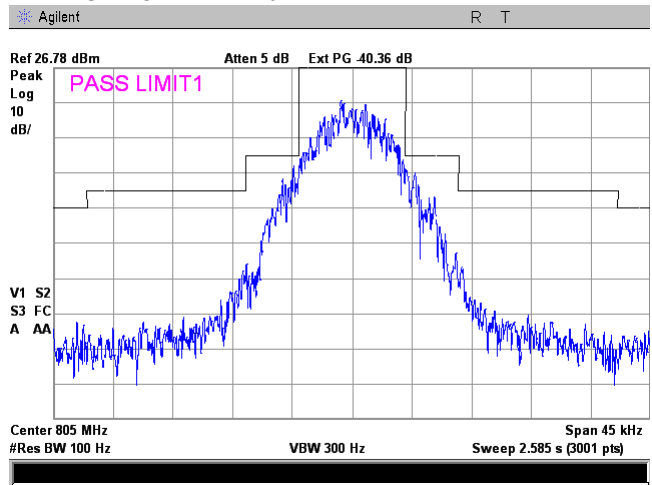
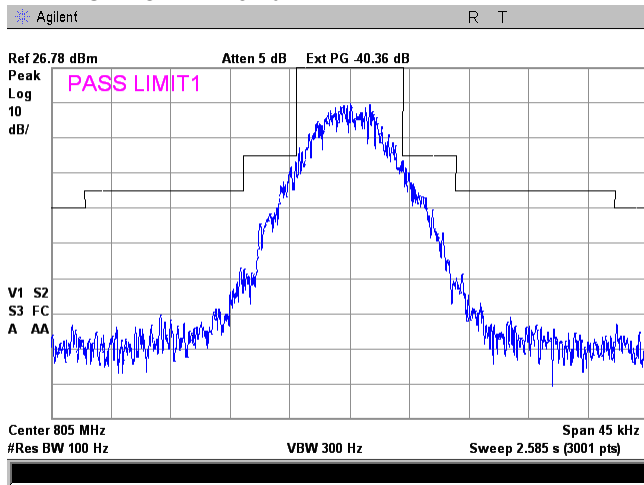

Test specification:		Section 90.210(b), Emission mask	
Test procedure:		47 CFR, Sections 2.1051, 2.1047 and 90.210(b)	
Test mode:		Compliance	
Date(s):		05-Aug-14 - 07-Aug-14	
Temperature: 23.3 °C		Air Pressure: 1004 hPa	
		Relative Humidity: 40 %	
		Power Supply: 120 VAC	
Remarks:			
		Verdict: PASS	

Plot 7.3.19 Emission mask test result at low frequency carrier, Port 1

FREQUENCY RANGE:
OPERATIONAL MODE:
INPUT PORT:
EMISSION MASK:
CONFIGURATION:
INPUT POWER: -51 dBm

851 - 861 MHz
C4FM downlink transmit
Base
90.210(B)
Single Band
INPUT POWER: -21 dBm

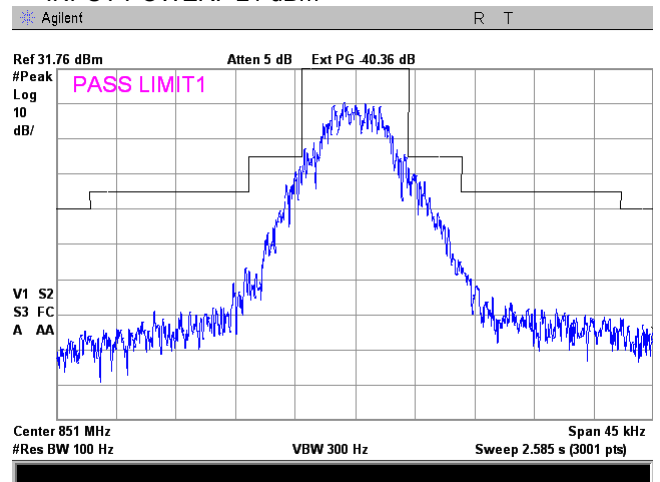
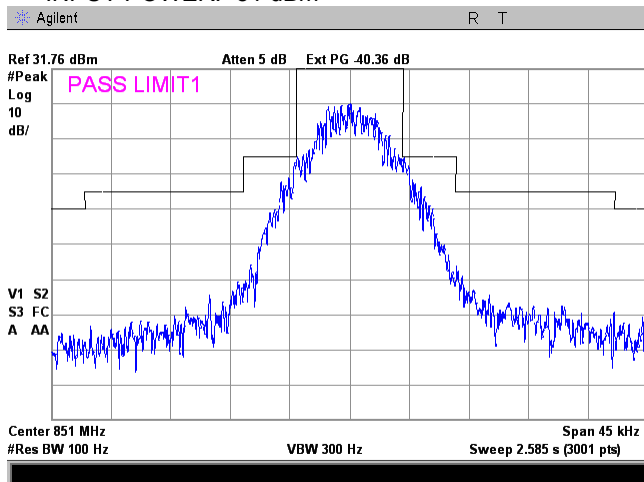

Plot 7.3.20 Emission mask test result at mid frequency carrier, Port 1

FREQUENCY RANGE:
OPERATIONAL MODE:
INPUT PORT:
EMISSION MASK:
CONFIGURATION:
INPUT POWER: -51 dBm

851 - 861 MHz
C4FM downlink transmit
Base
90.210(B)
Single Band
INPUT POWER: -21 dBm

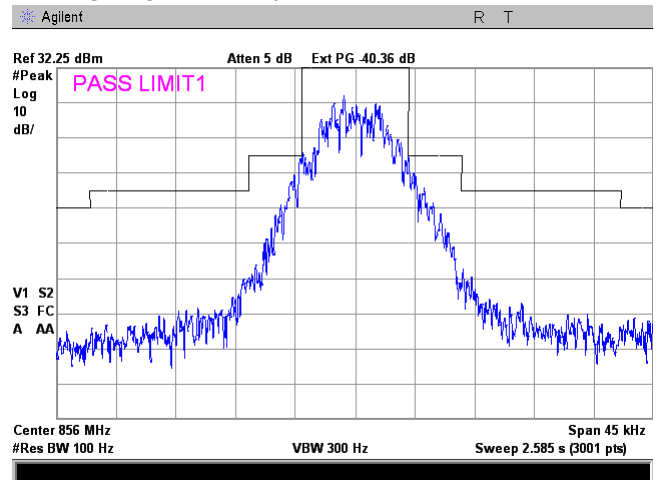
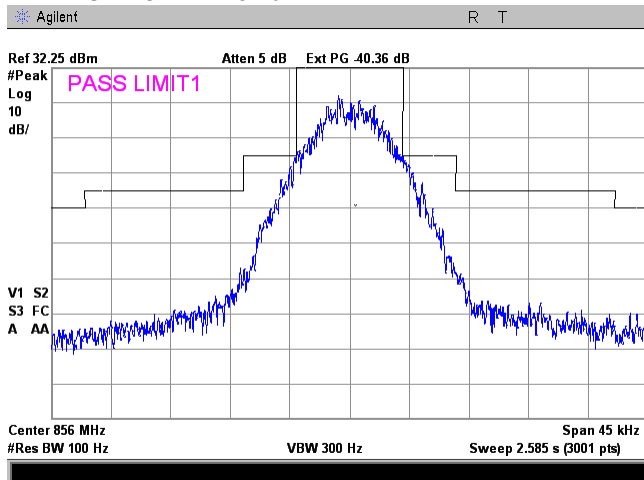

Test specification:		Section 90.210(b), Emission mask	
Test procedure:		47 CFR, Sections 2.1051, 2.1047 and 90.210(b)	
Test mode:		Compliance	
Date(s):		05-Aug-14 - 07-Aug-14	
Temperature: 23.3 °C		Air Pressure: 1004 hPa	
		Relative Humidity: 40 %	
		Power Supply: 120 VAC	
Remarks:			
		Verdict: PASS	

Plot 7.3.21 Emission mask test result at high frequency carrier, Port 1

FREQUENCY RANGE:
OPERATIONAL MODE:
INPUT PORT:
EMISSION MASK:
CONFIGURATION:
INPUT POWER: -51 dBm

851 - 861 MHz
C4FM downlink transmit
Base
90.210(B)
Single Band
INPUT POWER: -21 dBm

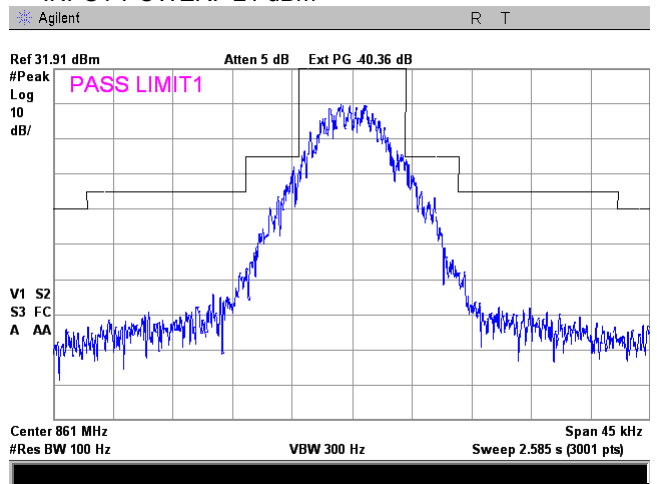
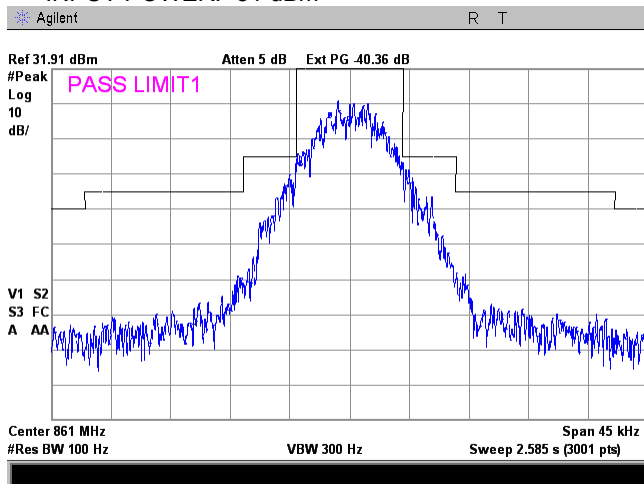

Plot 7.3.22 Emission mask test result at low frequency carrier, Port 2

FREQUENCY RANGE:
OPERATIONAL MODE:
INPUT PORT:
COMPOSITE INPUT POWER:
EMISSION MASK:
INPUT POWER: -54 dBm

806 - 816 MHz
C4FM uplink transmit
Mobile
-54 dBm
90.210(B)
INPUT POWER: -24 dBm

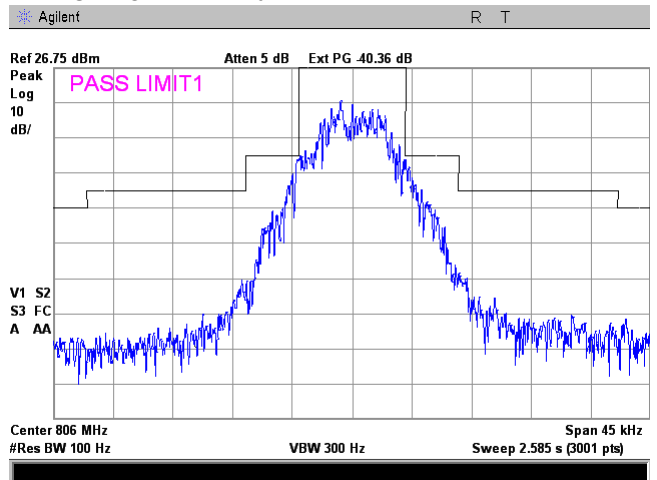
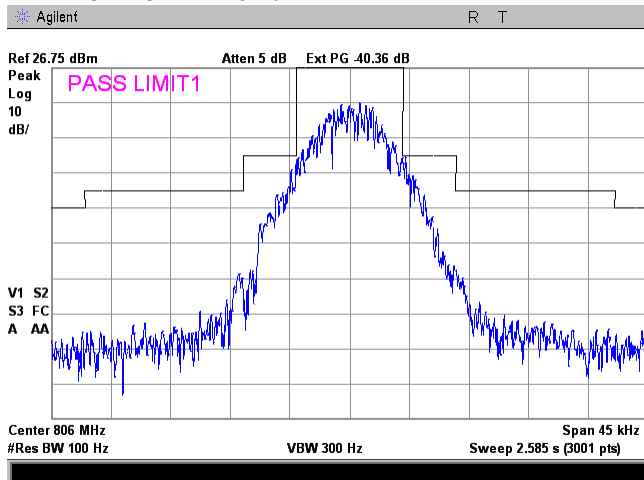

Test specification:		Section 90.210(b), Emission mask	
Test procedure:		47 CFR, Sections 2.1051, 2.1047 and 90.210(b)	
Test mode:		Compliance	
Date(s):		05-Aug-14 - 07-Aug-14	
Temperature: 23.3 °C		Air Pressure: 1004 hPa	
		Relative Humidity: 40 %	
		Power Supply: 120 VAC	
Remarks:			
		Verdict: PASS	

Plot 7.3.23 Emission mask test result at mid frequency carrier, Port 2

FREQUENCY RANGE:	806 - 816 MHz
OPERATIONAL MODE:	C4FM uplink transmit
INPUT PORT:	Mobile
COMPOSITE INPUT POWER:	-54 dBm
EMISSION MASK:	90.210(B)
INPUT POWER: -54 dBm	INPUT POWER: -24 dBm

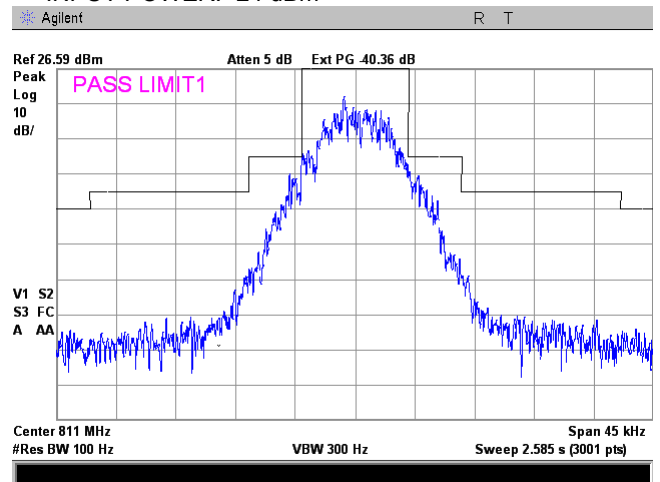
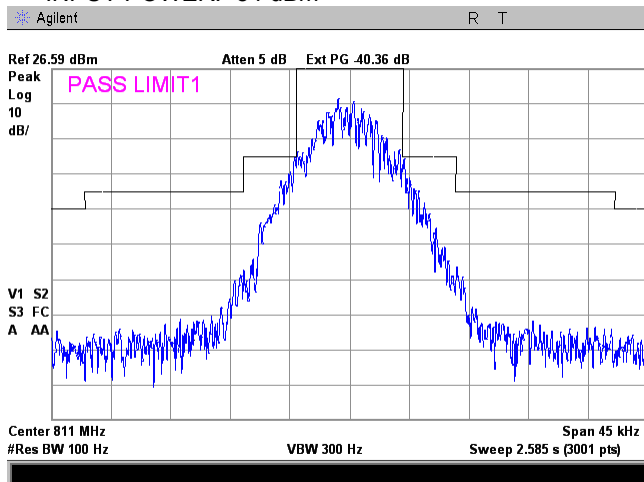

Plot 7.3.24 Emission mask test result at high frequency carrier, Port 2

FREQUENCY RANGE:	806 - 816 MHz
OPERATIONAL MODE:	C4FM uplink transmit
INPUT PORT:	Mobile
COMPOSITE INPUT POWER:	-54 dBm
EMISSION MASK:	90.210(B)
INPUT POWER: -54 dBm	INPUT POWER: -24 dBm

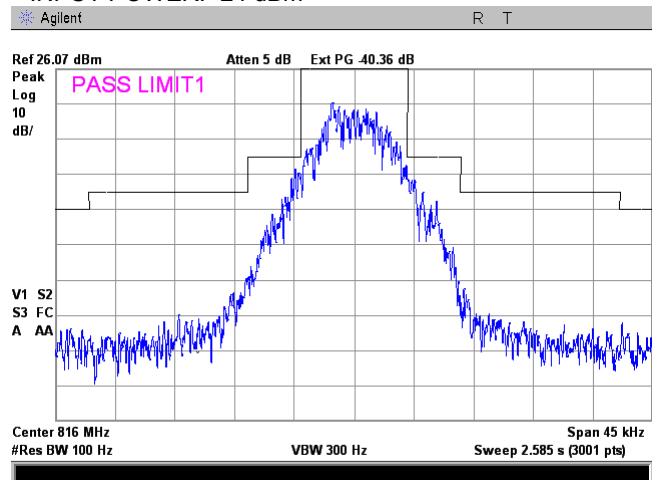
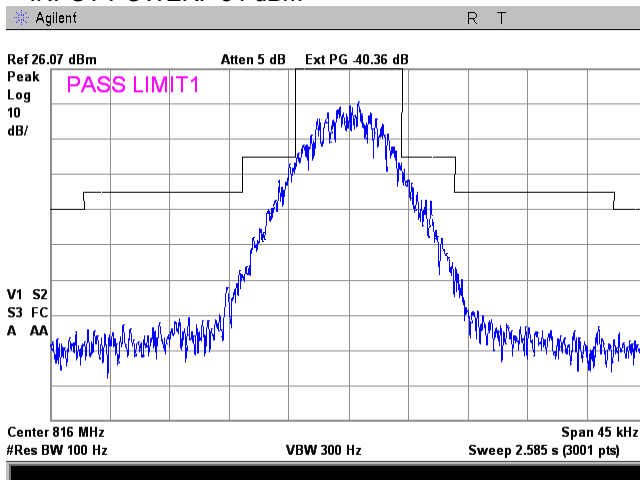

Test specification:	Section 90.210(b), Emission mask		
Test procedure:	47 CFR, Sections 2.1051, 2.1047 and 90.210(b)		
Test mode:	Compliance	Verdict:	PASS
Date(s):	05-Aug-14 - 07-Aug-14		
Temperature: 23.3 °C	Air Pressure: 1004 hPa	Relative Humidity: 40 %	Power Supply: 120 VAC
Remarks:			

Plot 7.3.25 Emission mask test result at low frequency carrier, Port 1

FREQUENCY RANGE:
OPERATIONAL MODE:
INPUT PORT:
EMISSION MASK:
CONFIGURATION:
INPUT POWER: -51 dBm

758 - 775 MHz
iDEN QAM downlink transmit
Base
90.210(B)
Single Band
INPUT POWER: -21 dBm

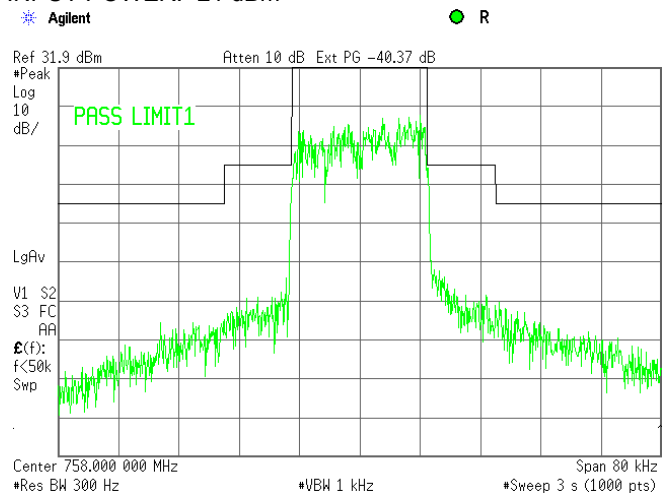
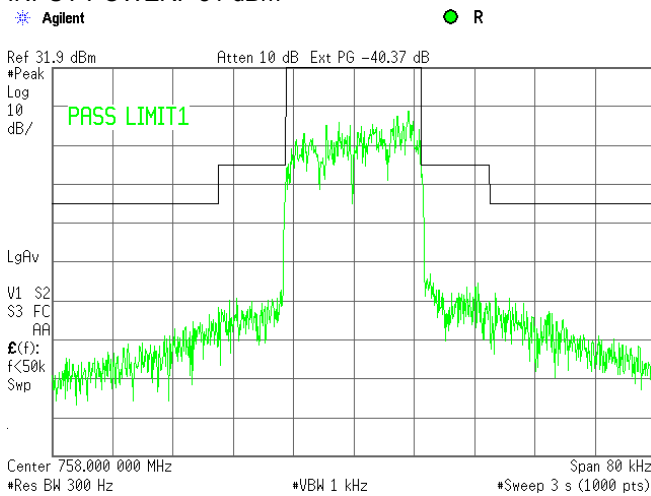

Plot 7.3.26 Emission mask test result at mid frequency carrier, Port 1

FREQUENCY RANGE:
OPERATIONAL MODE:
INPUT PORT:
EMISSION MASK:
CONFIGURATION:
INPUT POWER: -51 dBm

758 - 775 MHz
iDEN QAM downlink transmit
Base
90.210(B)
Single and Single Band
INPUT POWER: -21 dBm

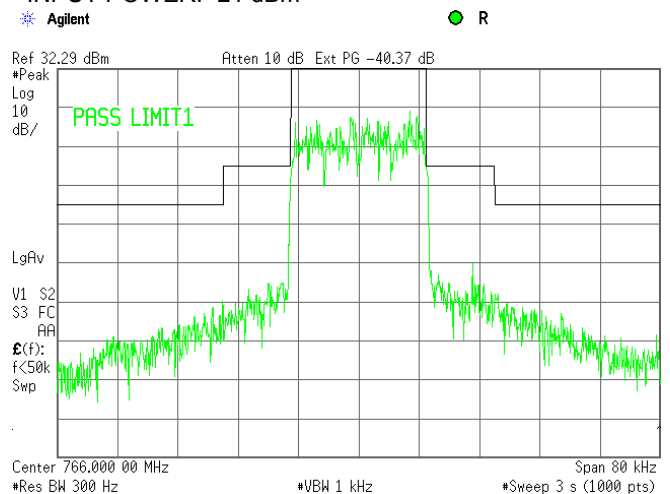
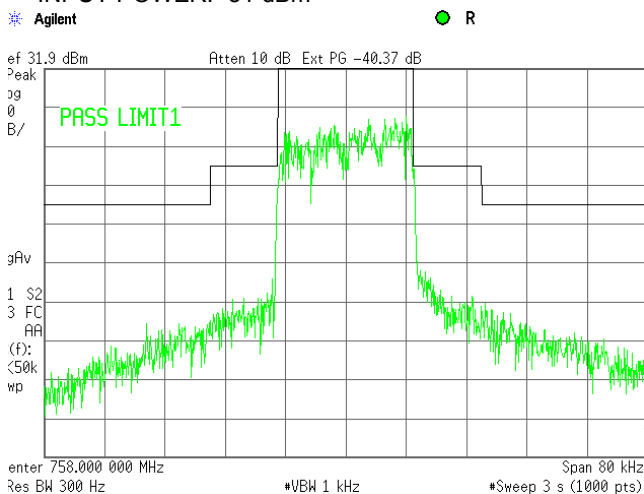

Test specification:	Section 90.210(b), Emission mask		
Test procedure:	47 CFR, Sections 2.1051, 2.1047 and 90.210(b)		
Test mode:	Compliance	Verdict:	PASS
Date(s):	05-Aug-14 - 07-Aug-14		
Temperature: 23.3 °C	Air Pressure: 1004 hPa	Relative Humidity: 40 %	Power Supply: 120 VAC
Remarks:			

Plot 7.3.27 Emission mask test result at high frequency carrier, Port 1

FREQUENCY RANGE: 758 - 775 MHz
 OPERATIONAL MODE: iDEN QAM downlink transmit
 INPUT PORT: Base
 EMISSION MASK: 90.210(B)
 CONFIGURATION: Single Band
 INPUT POWER: -51 dBm

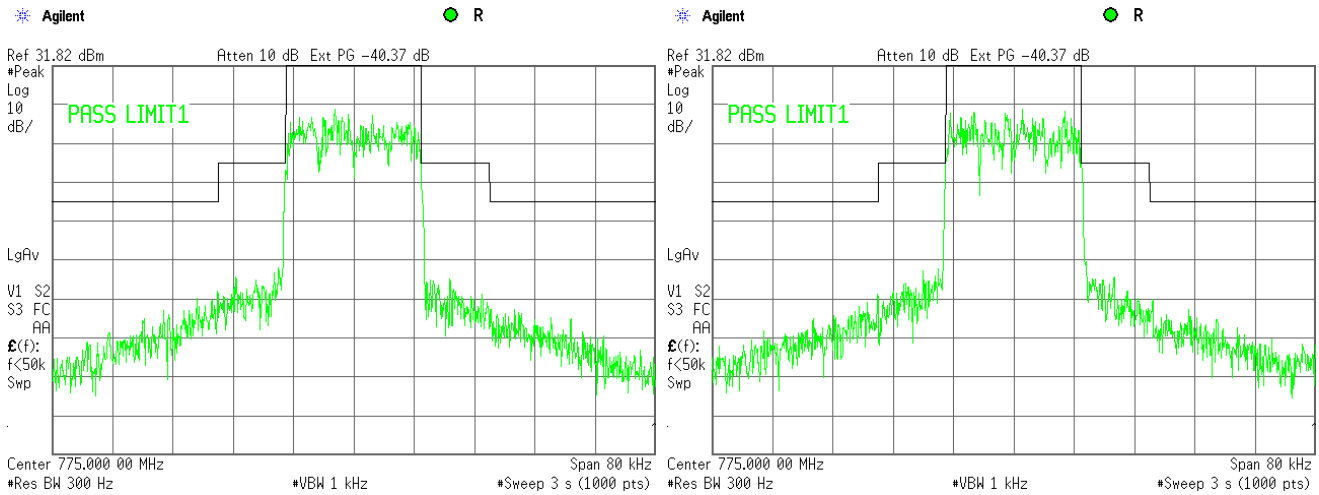

Plot 7.3.28 Emission mask test result at low frequency carrier, Port 2

FREQUENCY RANGE: 788 - 805 MHz
 OPERATIONAL MODE: iDEN QAM uplink transmit
 INPUT PORT: Mobile
 EMISSION MASK: 90.210(B)
 INPUT POWER: -24 dBm

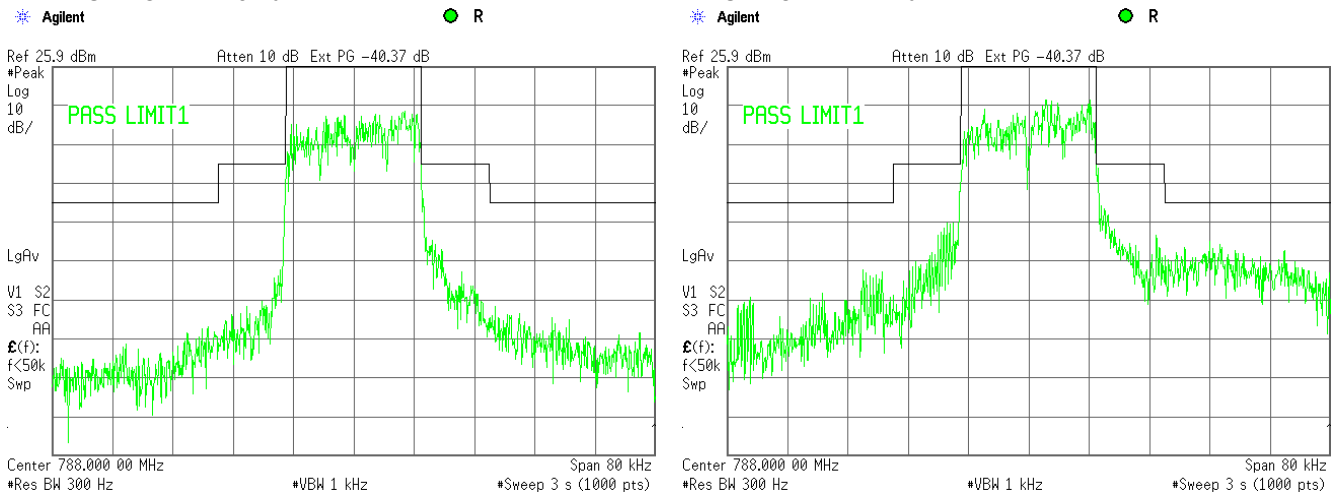

Test specification:	Section 90.210(b), Emission mask		
Test procedure:	47 CFR, Sections 2.1051, 2.1047 and 90.210(b)		
Test mode:	Compliance	Verdict:	PASS
Date(s):	05-Aug-14 - 07-Aug-14		
Temperature: 23.3 °C	Air Pressure: 1004 hPa	Relative Humidity: 40 %	Power Supply: 120 VAC
Remarks:			

Plot 7.3.29 Emission mask test result at mid frequency carrier, Port 2

FREQUENCY RANGE:
OPERATIONAL MODE:
INPUT PORT:
EMISSION MASK:
INPUT POWER: -54 dBm

788 - 805 MHz
iDEN QAM uplink transmit
Mobile
90.210(B)
INPUT POWER: -24 dBm

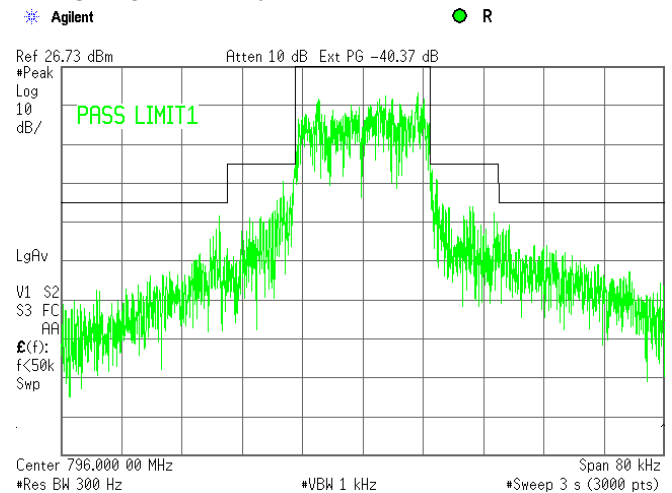
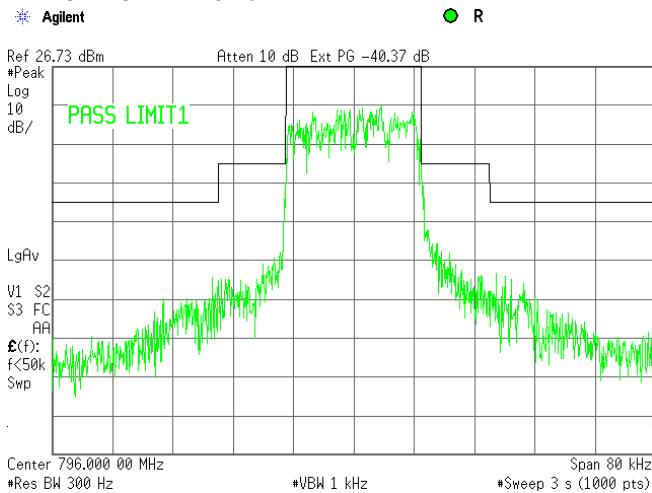

Plot 7.3.30 Emission mask test result at high frequency carrier, Port 2

FREQUENCY RANGE:
OPERATIONAL MODE:
INPUT PORT:
EMISSION MASK:
INPUT POWER: -54 dBm

788 - 805 MHz
iDEN QAM uplink transmit
Mobile
90.210(B)
INPUT POWER: -24 dBm

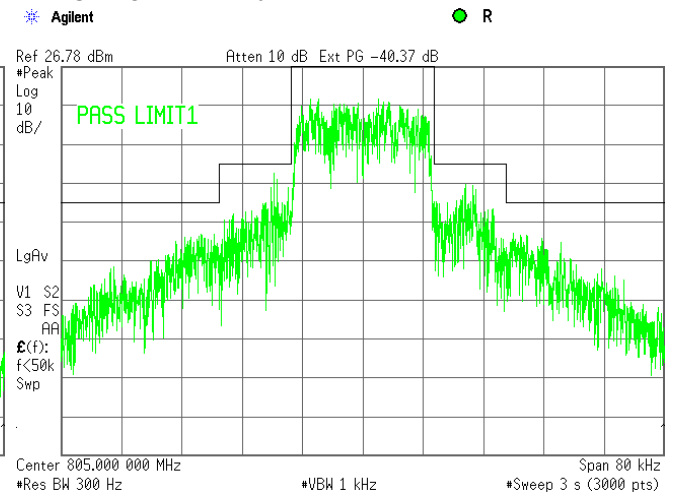
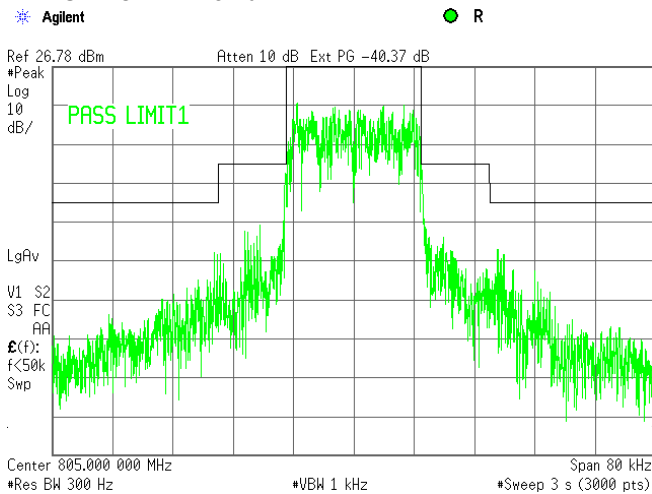

Test specification:	Section 90.210(b), Emission mask		
Test procedure:	47 CFR, Sections 2.1051, 2.1047 and 90.210(b)		
Test mode:	Compliance	Verdict:	PASS
Date(s):	05-Aug-14 - 07-Aug-14		
Temperature: 23.3 °C	Air Pressure: 1004 hPa	Relative Humidity: 40 %	Power Supply: 120 VAC
Remarks:			

Plot 7.3.31 Emission mask test result at low frequency carrier, Port 1

FREQUENCY RANGE:
OPERATIONAL MODE:
INPUT PORT:
EMISSION MASK:
CONFIGURATION:
INPUT POWER: -51 dBm

851 - 861 MHz
iDEN QAM downlink transmit
Base
90.210(B)
Single Band
INPUT POWER: -21 dBm

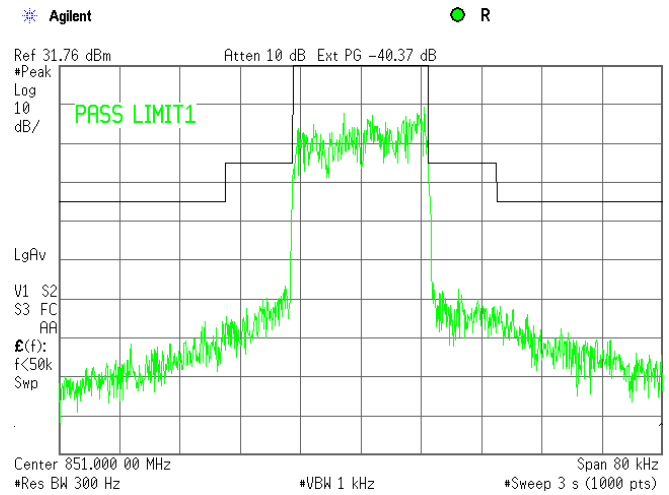
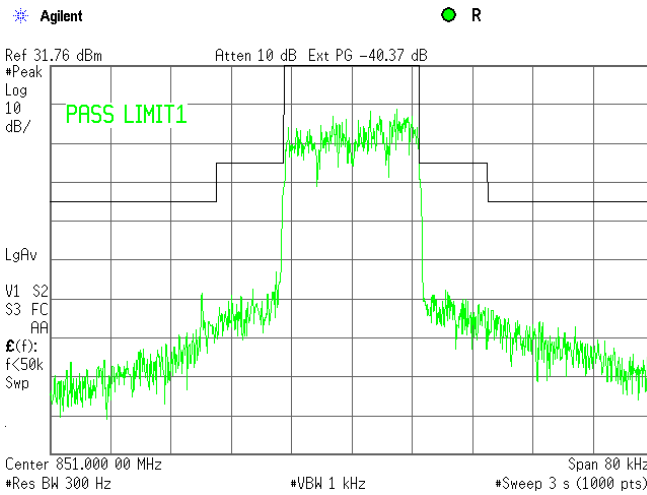

Plot 7.3.32 Emission mask test result at mid frequency carrier, Port 1

FREQUENCY RANGE:
OPERATIONAL MODE:
INPUT PORT:
EMISSION MASK:
CONFIGURATION:
INPUT POWER: -51 dBm

851 - 861 MHz
iDEN QAM downlink transmit
Base
90.210(B)
Single Band
INPUT POWER: -21 dBm

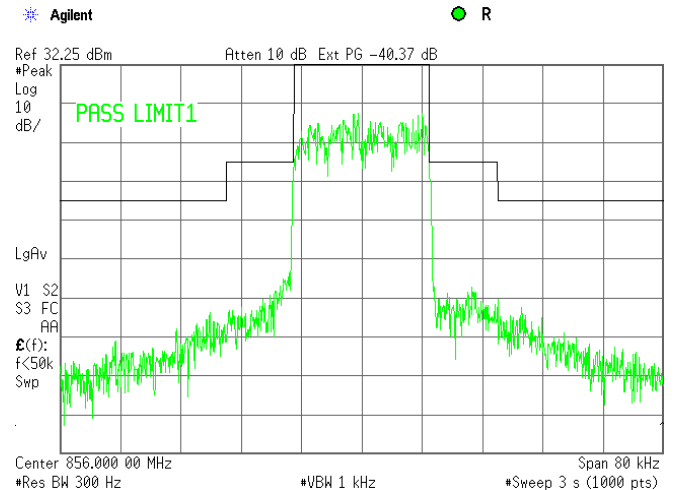
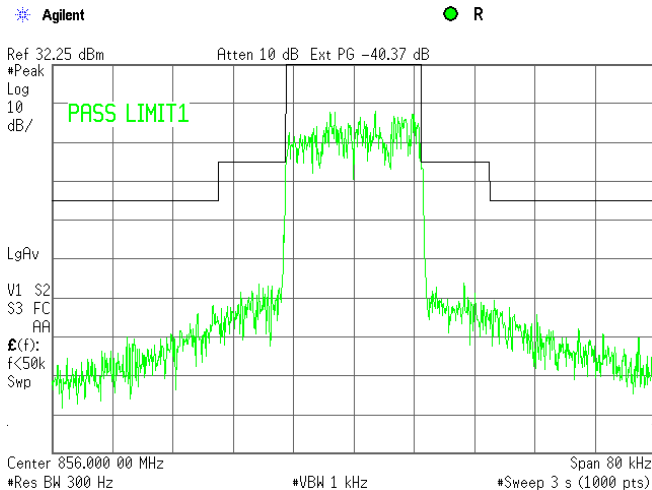

Test specification:		Section 90.210(b), Emission mask	
Test procedure:		47 CFR, Sections 2.1051, 2.1047 and 90.210(b)	
Test mode:		Compliance	
Date(s):		05-Aug-14 - 07-Aug-14	
Temperature: 23.3 °C		Air Pressure: 1004 hPa	
		Relative Humidity: 40 %	
		Power Supply: 120 VAC	
Remarks:			
		Verdict: PASS	

Plot 7.3.33 Emission mask test result at high frequency carrier, Port 1

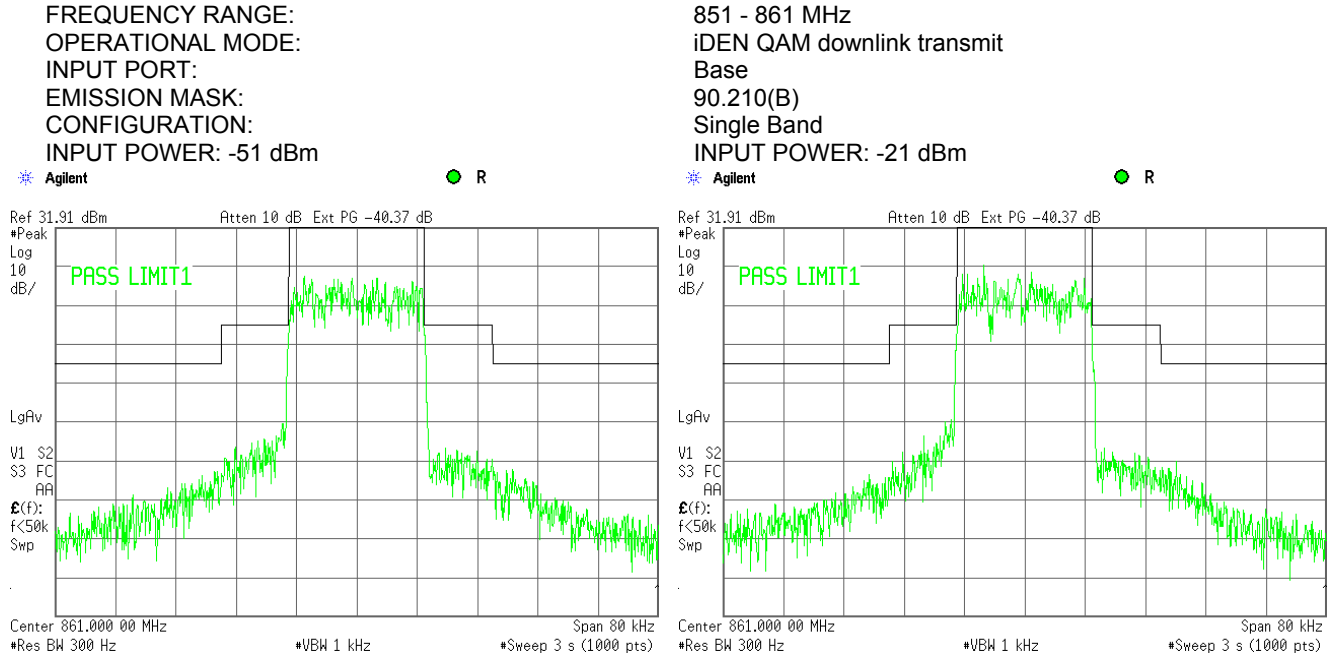

Plot 7.3.34 Emission mask test result at low frequency carrier, Port 2

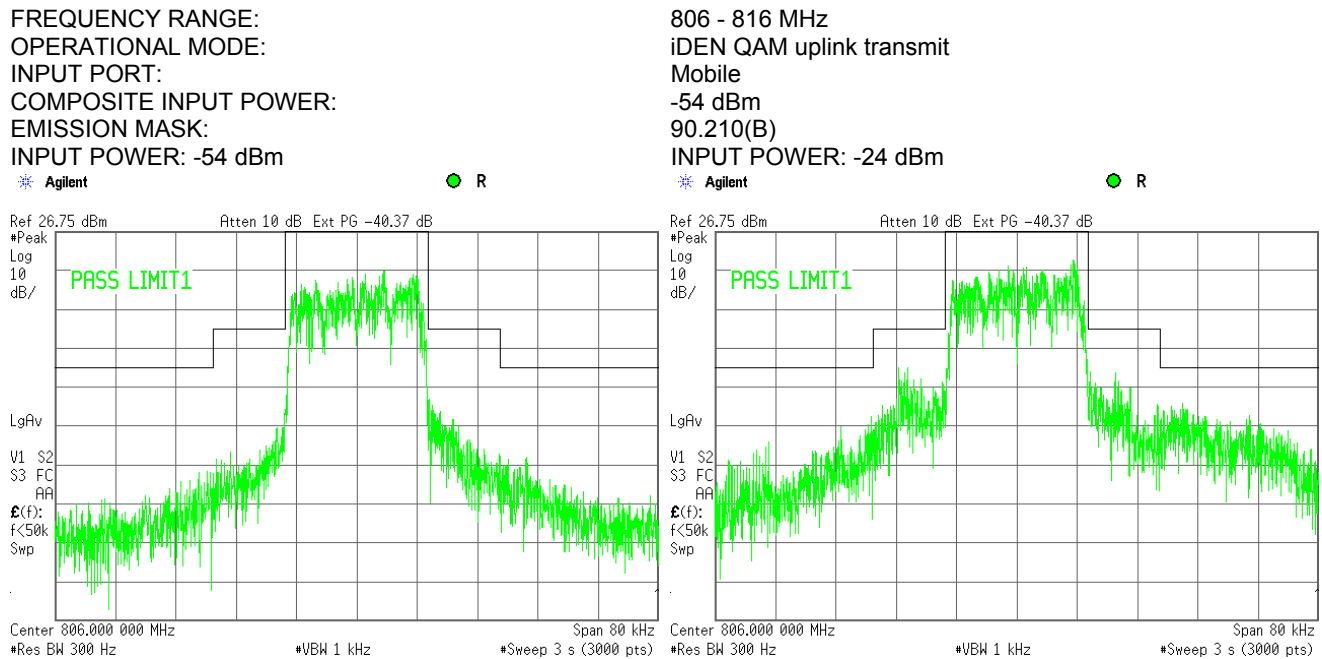

Test specification: Section 90.210(b), Emission mask			
Test procedure: 47 CFR, Sections 2.1051, 2.1047 and 90.210(b)			
Test mode: Compliance	Verdict: PASS		
Date(s): 05-Aug-14 - 07-Aug-14			
Temperature: 23.3 °C	Air Pressure: 1004 hPa	Relative Humidity: 40 %	Power Supply: 120 VAC
Remarks:			

Plot 7.3.35 Emission mask test result at mid frequency carrier, Port 2

FREQUENCY RANGE:
OPERATIONAL MODE:
INPUT PORT:
EMISSION MASK:
INPUT POWER: -54 dBm

806 - 816 MHz
iDEN QAM uplink transmit
Mobile
90.210(B)
INPUT POWER: -24 dBm

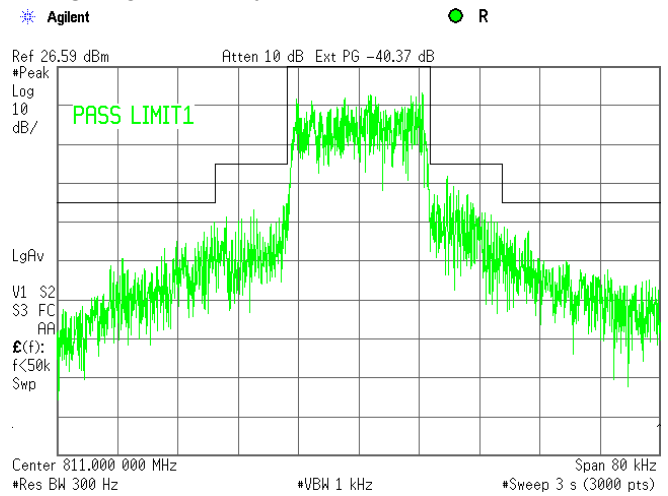
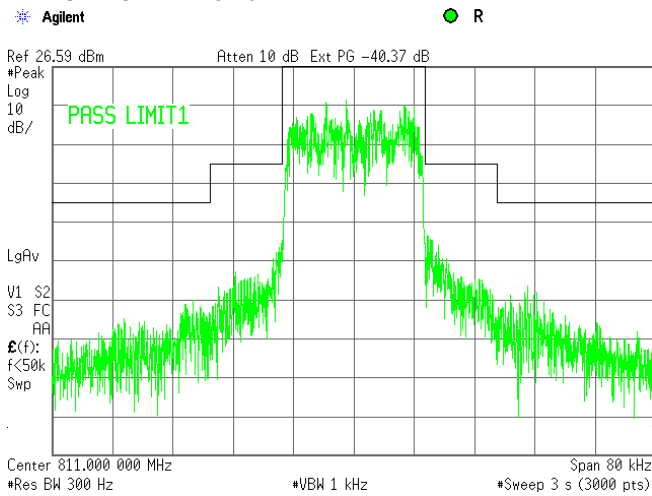

Plot 7.3.36 Emission mask test result at high frequency carrier, Port 2

FREQUENCY RANGE:
OPERATIONAL MODE:
INPUT PORT:
EMISSION MASK:
INPUT POWER: -54 dBm

806 - 816 MHz
iDEN QAM uplink transmit
Mobile
90.210(B)
INPUT POWER: -24 dBm

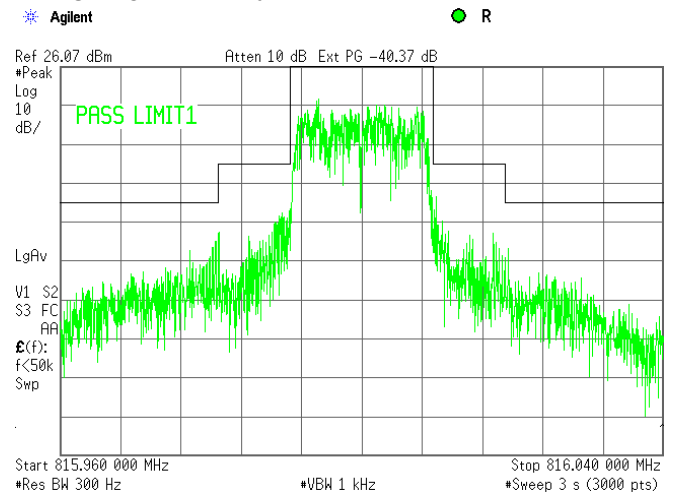
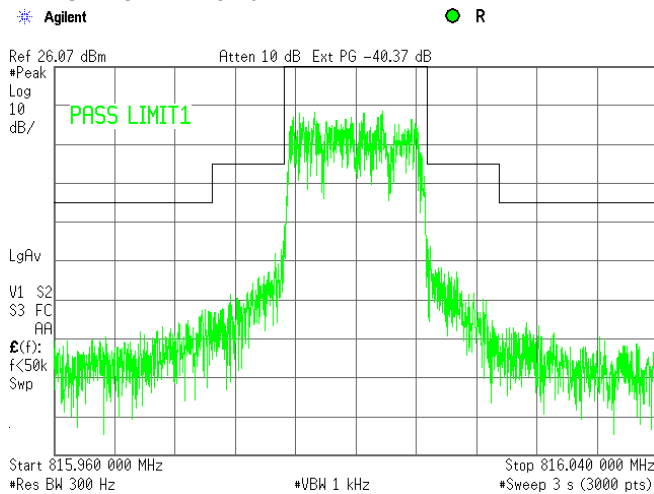

Test specification:		Section 90.210(b), Emission mask	
Test procedure:		47 CFR, Sections 2.1051, 2.1047 and 90.210(b)	
Test mode:		Compliance	
Date(s):		05-Aug-14 - 07-Aug-14	
Temperature: 23.3 °C		Air Pressure: 1004 hPa	
Remarks:		Verdict: PASS	
		Relative Humidity: 40 %	
		Power Supply: 120 VAC	

Plot 7.3.37 Emission mask test result at low frequency carrier, Port 1

FREQUENCY RANGE:
OPERATIONAL MODE:
INPUT PORT:
EMISSION MASK:
CONFIGURATION:
INPUT POWER: -51 dBm

758 - 775 MHz
Analog FM downlink transmit
Base
90.210(B)
Single Band
INPUT POWER: -21 dBm

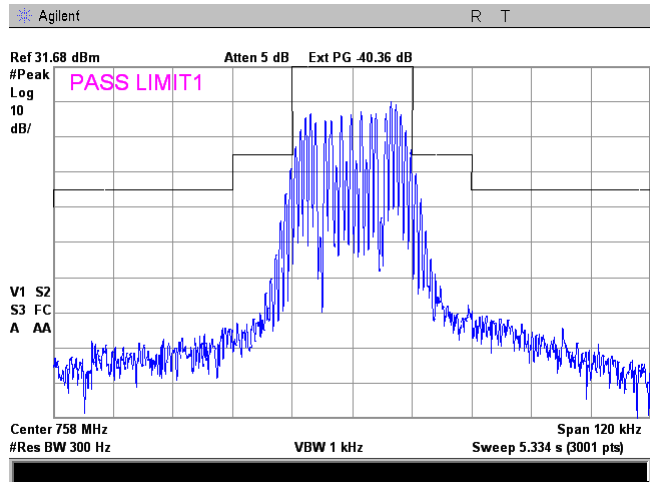
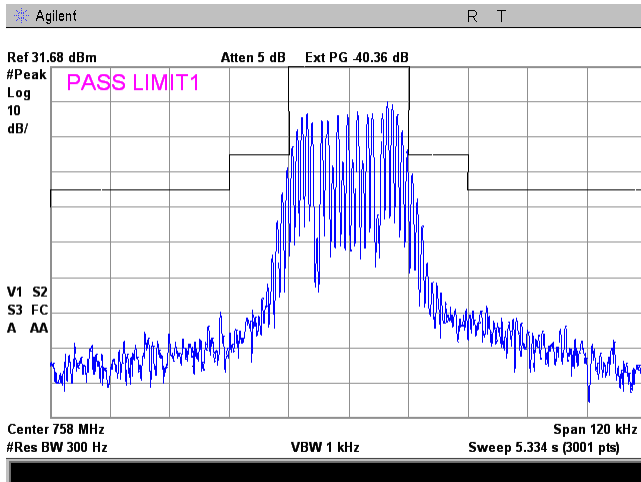

Plot 7.3.38 Emission mask test result at mid frequency carrier, Port 1

FREQUENCY RANGE:
OPERATIONAL MODE:
INPUT PORT:
EMISSION MASK:
CONFIGURATION:
INPUT POWER: -51 dBm

758 - 775 MHz
Analog FM downlink transmit
Base
90.210(B)
Single Band
INPUT POWER: -21 dBm

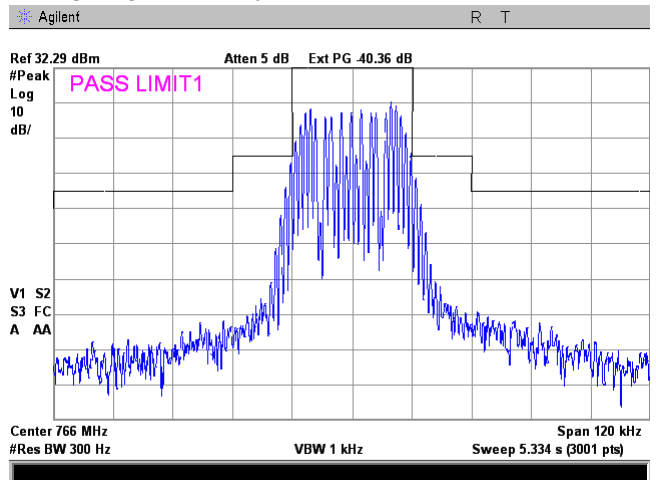
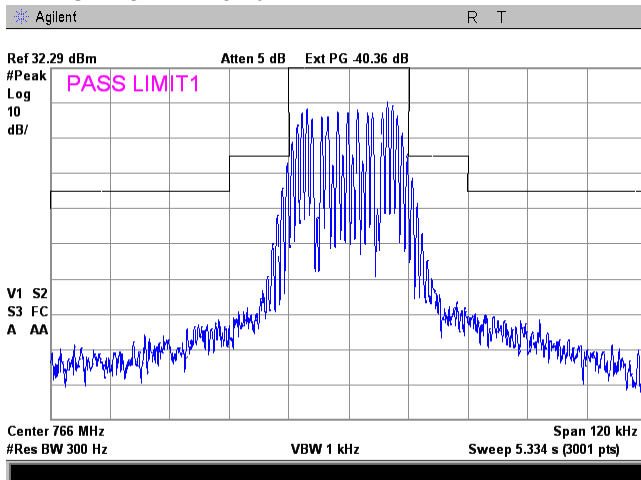

Test specification:		Section 90.210(b), Emission mask	
Test procedure:		47 CFR, Sections 2.1051, 2.1047 and 90.210(b)	
Test mode:		Compliance	
Date(s):		05-Aug-14 - 07-Aug-14	
Temperature: 23.3 °C		Air Pressure: 1004 hPa	
		Relative Humidity: 40 %	
		Power Supply: 120 VAC	
Remarks:			
		Verdict: PASS	

Plot 7.3.39 Emission mask test result at high frequency carrier, Port 1

FREQUENCY RANGE:
OPERATIONAL MODE:
INPUT PORT:
EMISSION MASK:
CONFIGURATION:
INPUT POWER: -51 dBm

758 - 775 MHz
Analog FM downlink transmit
Base
90.210(B)
Single Band
INPUT POWER: -21 dBm

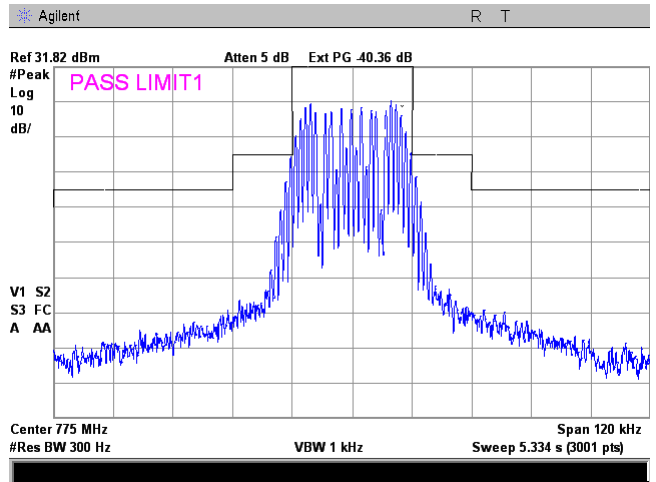
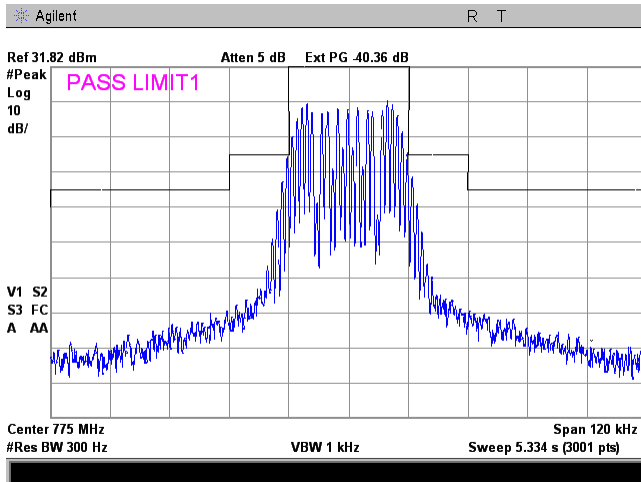

Plot 7.3.40 Emission mask test result at low frequency carrier, Port 2

FREQUENCY RANGE:
OPERATIONAL MODE:
INPUT PORT:
EMISSION MASK:
INPUT POWER: -54 dBm

788 - 805 MHz
Analog FM uplink transmit
Mobile
90.210(B)
INPUT POWER: -24 dBm

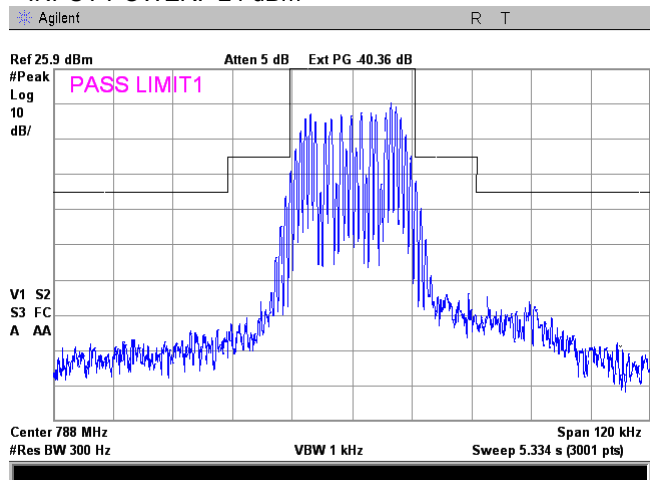
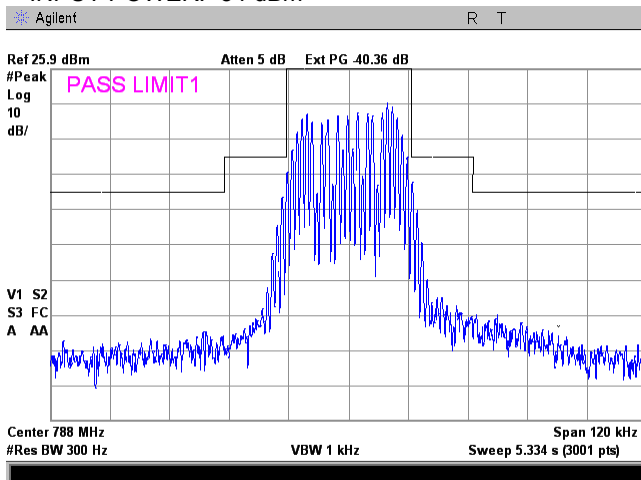

Test specification:		Section 90.210(b), Emission mask	
Test procedure:		47 CFR, Sections 2.1051, 2.1047 and 90.210(b)	
Test mode:		Compliance	
Date(s):		05-Aug-14 - 07-Aug-14	
Temperature: 23.3 °C		Air Pressure: 1004 hPa	
		Relative Humidity: 40 %	
		Power Supply: 120 VAC	
Remarks:			
		Verdict: PASS	

Plot 7.3.41 Emission mask test result at mid frequency carrier, Port 2

FREQUENCY RANGE:
OPERATIONAL MODE:
INPUT PORT:
EMISSION MASK:
INPUT POWER: -54 dBm

788 - 805 MHz
Analog FM uplink transmit
Mobile
90.210(B)
INPUT POWER: -24 dBm

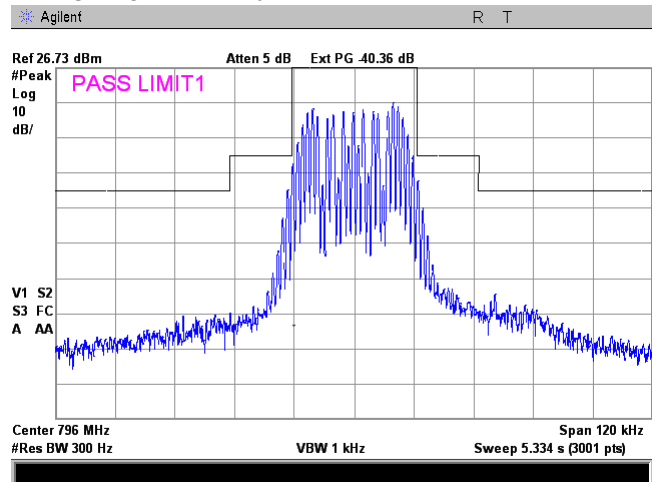
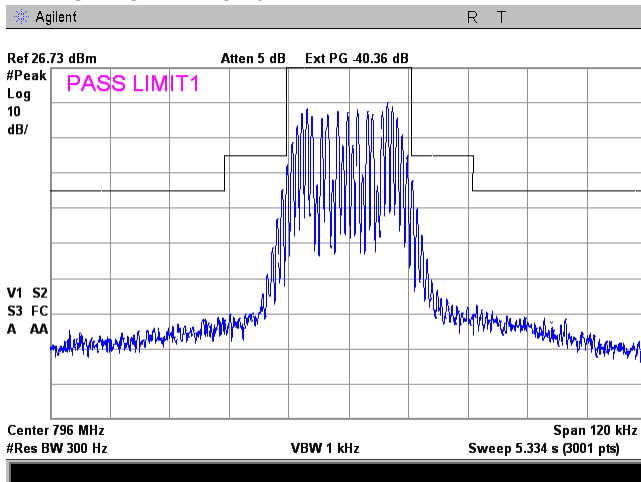

Plot 7.3.42 Emission mask test result at high frequency carrier, Port 2

FREQUENCY RANGE:
OPERATIONAL MODE:
INPUT PORT:
EMISSION MASK:
INPUT POWER: -54 dBm

788 - 805 MHz
Analog FM uplink transmit
Mobile
90.210(B)
INPUT POWER: -24 dBm

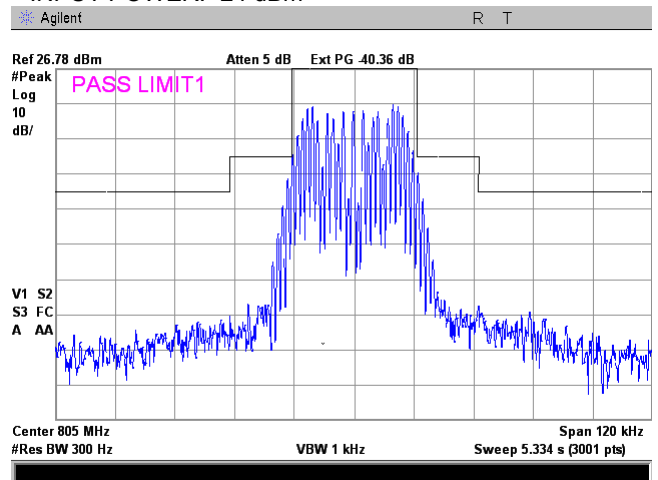
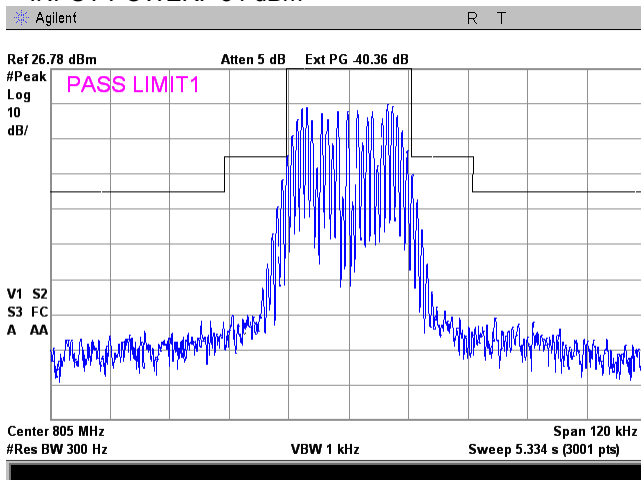

Test specification:		Section 90.210(b), Emission mask	
Test procedure:		47 CFR, Sections 2.1051, 2.1047 and 90.210(b)	
Test mode:		Compliance	
Date(s):		05-Aug-14 - 07-Aug-14	
Temperature: 23.3 °C		Air Pressure: 1004 hPa	
Remarks:		Verdict: PASS	
		Relative Humidity: 40 %	
		Power Supply: 120 VAC	

Plot 7.3.43 Emission mask test result at low frequency carrier, Port 1

FREQUENCY RANGE:
OPERATIONAL MODE:
INPUT PORT:
EMISSION MASK:
CONFIGURATION:
INPUT POWER: -51 dBm

851 - 861 MHz
Analog FM downlink transmit
Base
90.210(B)
Single Band
INPUT POWER: -21 dBm

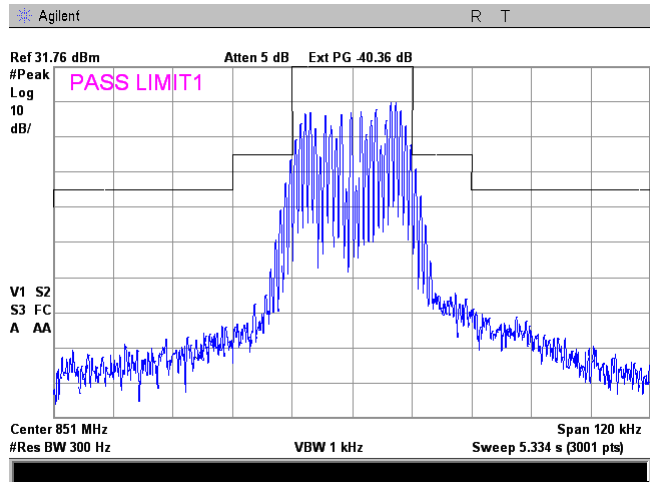
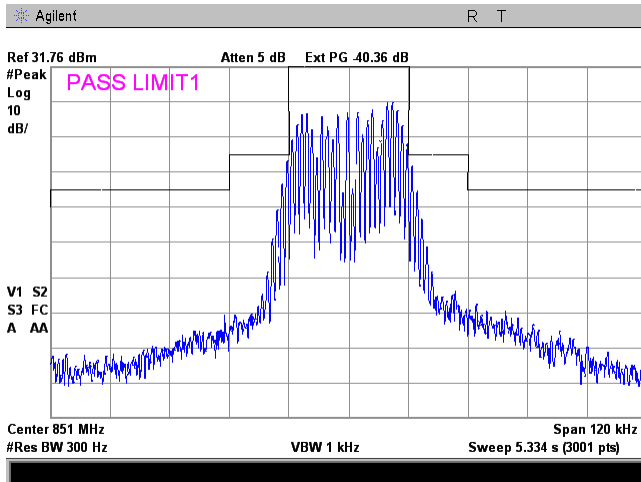

Plot 7.3.44 Emission mask test result at mid frequency carrier, Port 1

FREQUENCY RANGE:
OPERATIONAL MODE:
INPUT PORT:
EMISSION MASK:
CONFIGURATION:
INPUT POWER: -51 dBm

851 - 861 MHz
Analog FM downlink transmit
Base
90.210(B)
Single Band
INPUT POWER: -21 dBm

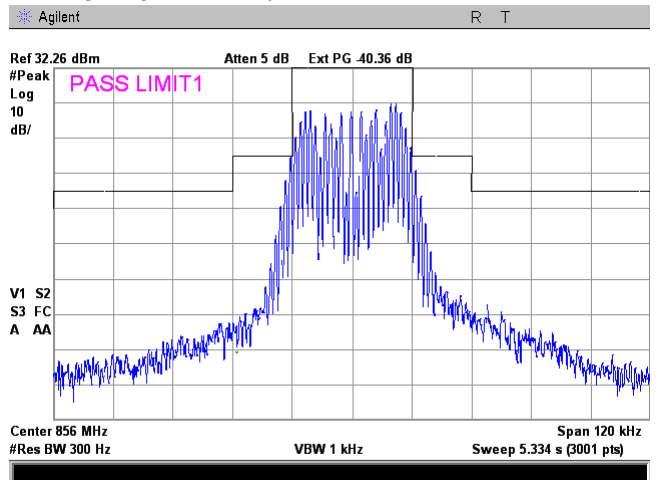
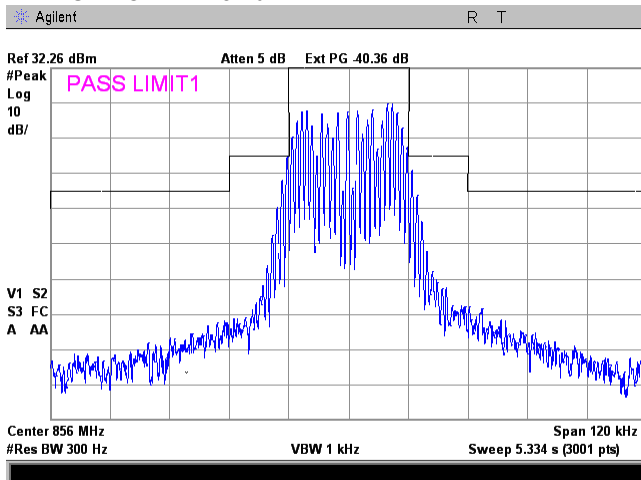

Test specification: Section 90.210(b), Emission mask			
Test procedure: 47 CFR, Sections 2.1051, 2.1047 and 90.210(b)			
Test mode: Compliance		Verdict: PASS	
Date(s): 05-Aug-14 - 07-Aug-14			
Temperature: 23.3 °C	Air Pressure: 1004 hPa	Relative Humidity: 40 %	Power Supply: 120 VAC
Remarks:			

Plot 7.3.45 Emission mask test result at high frequency carrier, Port 1

FREQUENCY RANGE:
OPERATIONAL MODE:
INPUT PORT:
EMISSION MASK:
CONFIGURATION:
INPUT POWER: -51 dBm

851 - 861 MHz
Analog FM downlink transmit
Base
90.210(B)
Single Band
INPUT POWER: -21 dBm

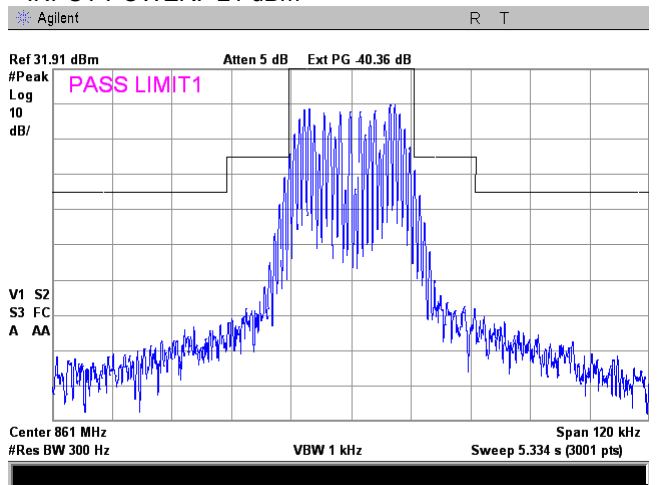
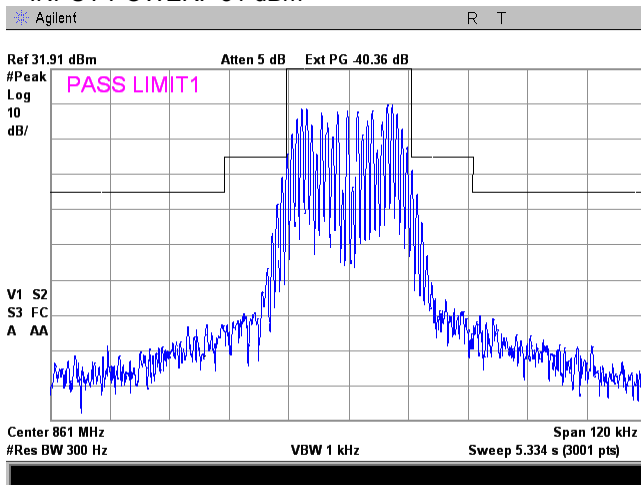

Plot 7.3.46 Emission mask test result at low frequency carrier, Port 2

FREQUENCY RANGE:
OPERATIONAL MODE:
INPUT PORT:
EMISSION MASK:
INPUT POWER: -54 dBm

806 - 816 MHz
Analog FM downlink transmit
Mobile
90.210(B)
INPUT POWER: -24 dBm

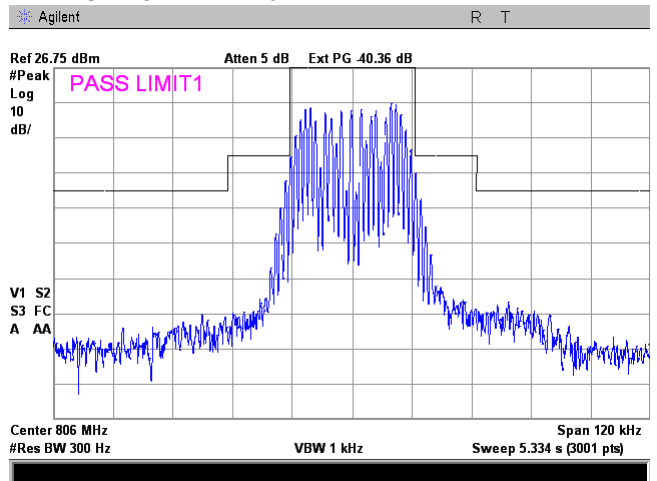
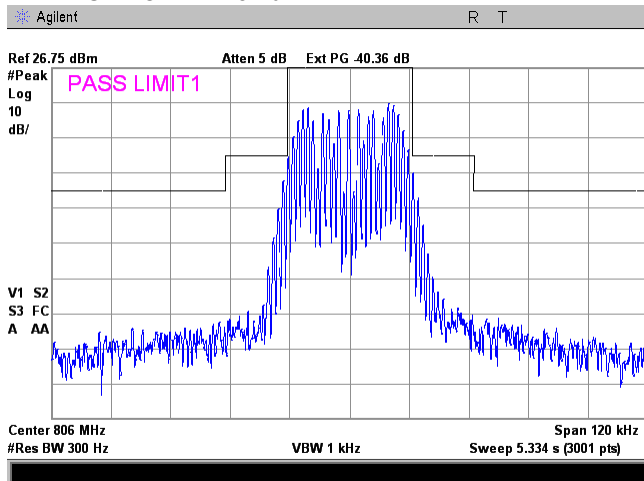

Test specification:		Section 90.210(b), Emission mask	
Test procedure:		47 CFR, Sections 2.1051, 2.1047 and 90.210(b)	
Test mode:		Compliance	
Date(s):		05-Aug-14 - 07-Aug-14	
Temperature: 23.3 °C		Air Pressure: 1004 hPa	
		Relative Humidity: 40 %	
		Power Supply: 120 VAC	
Remarks:			
		Verdict: PASS	

Plot 7.3.47 Emission mask test result at mid frequency carrier, Port 2

FREQUENCY RANGE:
OPERATIONAL MODE:
INPUT PORT:
EMISSION MASK:
INPUT POWER: -54 dBm

806 - 816 MHz
Analog FM downlink transmit
Mobile
90.210(B)
INPUT POWER: -24 dBm

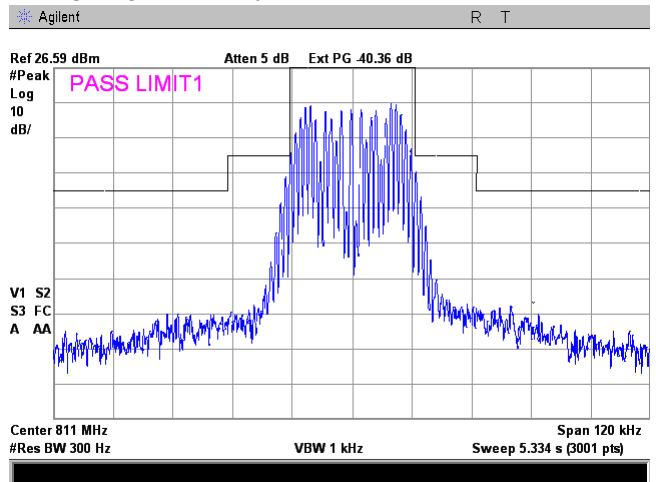
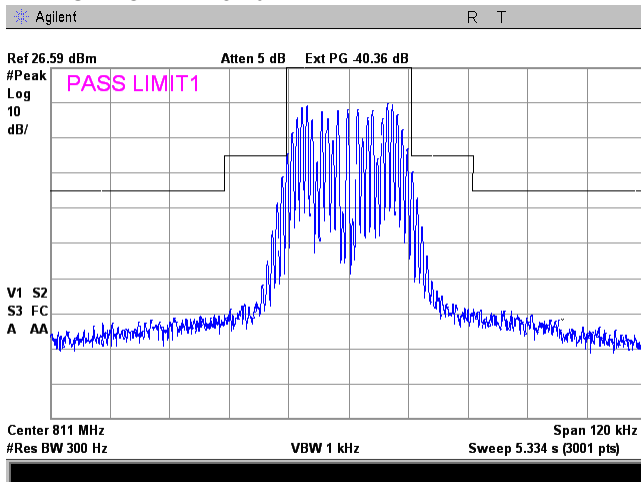

Plot 7.3.48 Emission mask test result at high frequency carrier, Port 2

FREQUENCY RANGE:
OPERATIONAL MODE:
INPUT PORT:
EMISSION MASK:
INPUT POWER: -54 dBm

806 - 816 MHz
Analog FM downlink transmit
Mobile
90.210(B)
INPUT POWER: -24 dBm

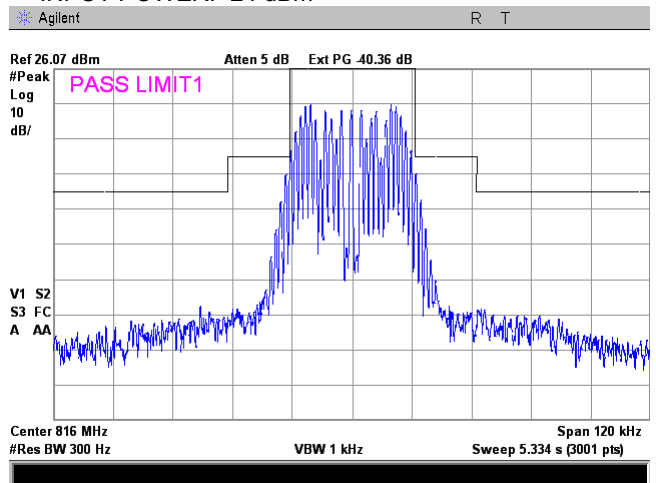
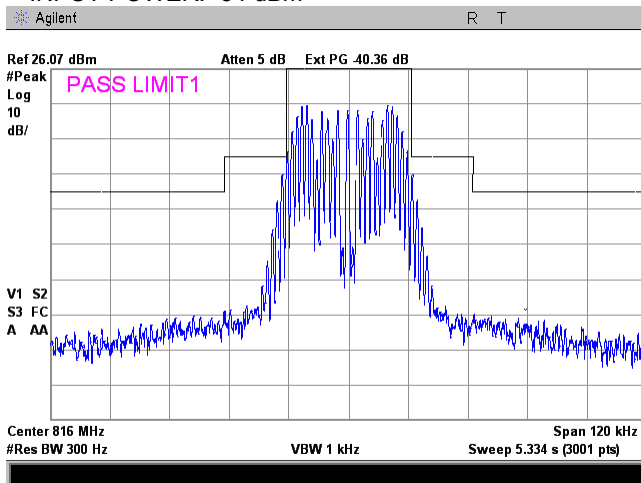



HERMON LABORATORIES		Section 90.210(b), Intermodulation product test	
Test specification:		47 CFR, Sections 2.1051, 2.1047 and 90.210(b); KDB 935210 D02 v02, Appendix D	
Test mode:	Compliance	Verdict:	PASS
Date(s):	10-Aug-14		
Temperature: 23.2 °C	Air Pressure: 1006 hPa	Relative Humidity: 43 %	Power Supply: 120 VAC
Remarks:			

7.4 Intermodulation product test

7.4.1 General

This test was performed to measure emission mask at RF antenna connector. Specification test limits are given in Table 7.4.1. The test results are provided in the associated plots.

Table 7.4.1 Intermodulation product limits

Frequency range, MHz	ERP Intermodulation product limit, dBm
Class A Booster	
758 – 775 / 788 - 805	-13.0
851 – 861 / 806 - 816	-13.0

7.4.2 Test procedure

- 7.4.2.1 The EUT was set up as shown in Figure 7.4.1, energized and its proper operation was checked.
- 7.4.2.2 Signal generator A was configured for CW operation at the low frequency of appropriate frequency band,
- 7.4.2.3 Signal generator B was configured for CW operation at the high frequency of the same frequency band.
- 7.4.2.4 The generator amplitudes were set so that the power from each into RF combiner was equivalent.
- 7.4.2.5 The signal generator's amplitudes were increased equally until just before the EUT was began ALC and all intermodulation products were measured.
- 7.4.2.6 Signal generator B was varied in frequency to check if intermodulation products were produced.
- 7.4.2.7 The intermodulation products were measured with spectrum analyzer as provided in the associated plots.
- 7.4.2.8 The EUT was tested at the compression and 10 dB into compression to show ALC operation, worst case results taken.
- 7.4.2.9 The test was repeated for all uplink and downlink operational bands.



HERMON LABORATORIES Test specification:		Section 90.210(b), Intermodulation product test		
Test procedure:	47 CFR, Sections 2.1051, 2.1047 and 90.210(b); KDB 935210 D02 v02, Appendix D			
Test mode:	Compliance	Verdict:		PASS
Date(s):	10-Aug-14			
Temperature: 23.2 °C	Air Pressure: 1006 hPa	Relative Humidity: 43 %	Power Supply: 120 VAC	
Remarks:				

Figure 7.4.1 Intermodulation product test setup

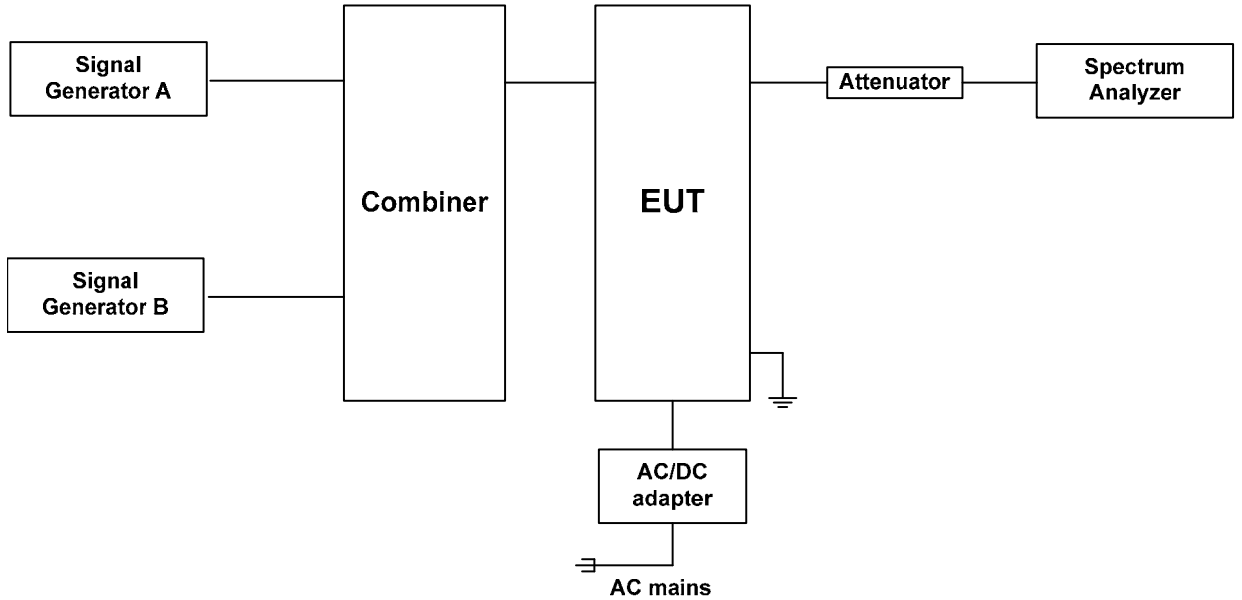



HERMON LABORATORIES Test specification:		Section 90.210(b), Intermodulation product test			
Test procedure:		47 CFR, Sections 2.1051, 2.1047 and 90.210(b); KDB 935210 D02 v02, Appendix D			
Test mode:	Compliance	Verdict:		PASS	
Date(s):	10-Aug-14				
Temperature: 23.2 °C	Air Pressure: 1006 hPa	Relative Humidity: 43 %	Power Supply: 120 VAC		
Remarks:					

Table 7.4.2 Intermodulation product test results

OPERATING FREQUENCY RANGE: 758 - 775 MHz (downlink)
788 - 805 MHz (uplink)

DETECTOR USED: Average

RESOLUTION BANDWIDTH: 10 kHz

VIDEO BANDWIDTH: 30 kHz

MODULATING SIGNAL: Unmodulated

CONFIGURATION: Single Band

Frequency, MHz	SA reading, dBm/10kHz**	ERP***, dBm/10kHz	ERP Limit, dBm/10kHz	Margin, dB*	Verdict
Frequency range, 758 – 775 MHz Downlink					
758.1378	-14.14	-14.14	-13.0	-1.14	Pass
757.9385	-13.16	-13.16	-13.0	-0.16	Pass
766.1013	-13.79	-13.79	-13.0	-0.79	Pass
765.8998	-14.01	-14.01	-13.0	-1.01	Pass
774.8567	-15.17	-15.17	-13.0	-2.17	
774.8578	-15.56	-15.56	-13.0	-2.56	
Frequency range, 788 – 805 MHz Uplink					
787.9377	-28.71	-28.71	-13.0	-15.71	Pass
788.1366	-27.38	-27.38	-13.0	-14.38	Pass
796.9004	-26.97	-26.97	-13.0	-13.97	Pass
795.1000	-26.58	-26.58	-13.0	-13.58	Pass
804.8558	-27.81	-27.81	-13.0	-14.81	Pass
805.0696	-28.09	-28.09	-13.0	-15.09	Pass



HERMON LABORATORIES		Section 90.210(b), Intermodulation product test	
Test specification:		47 CFR, Sections 2.1051, 2.1047 and 90.210(b); KDB 935210 D02 v02, Appendix D	
Test procedure:	47 CFR, Sections 2.1051, 2.1047 and 90.210(b); KDB 935210 D02 v02, Appendix D	Verdict: PASS	
Test mode:	Compliance		
Date(s):	10-Aug-14		
Temperature: 23.2 °C	Air Pressure: 1006 hPa	Relative Humidity: 43 %	Power Supply: 120 VAC
Remarks:			

Table 7.4.2 Intermodulation product test results (continued)

DETECTOR USED: Average
RESOLUTION BANDWIDTH: 10 kHz
VIDEO BANDWIDTH: 30 kHz
MODULATING SIGNAL: Unmodulated

FREQUENCY RANGE: 851 - 861 MHz (downlink)

806 - 816 MHz (uplink)

CONFIGURATION: Single Band

Frequency, MHz	SA reading, dBm/10kHz**	ERP***, dBm/10kHz	ERP Limit, dBm/10kHz	Margin, dB*	Verdict
Frequency range, 851 – 861 MHz Downlink					
850.9378	-16.04	-16.04	-13.0	-3.04	Pass
851.1380	-15.55	-15.55	-13.0	-2.55	Pass
855.9012	-13.63	-13.63	-13.0	-0.63	Pass
856.1004	-13.81	-13.81	-13.0	-0.81	Pass
860.9569	-13.20	-13.20	-13.0	-0.20	Pass
861.0697	-13.29	-13.29	-13.0	-0.29	Pass
Frequency range, 806 –816 MHz Uplink					
805.9351	-26.93	-26.93	-13.0	-13.93	Pass
806.1377	-25.62	-25.62	-13.0	-12.62	Pass
810.9020	-26.40	-26.40	-13.0	-13.40	Pass
811.1015	-27.90	-27.90	-13.0	-14.90	Pass
815.8541	-28.89	-28.89	-13.0	-15.89	Pass
816.0696	-30.43	-30.43	-13.0	-17.43	Pass

* - Margin = ERP of intermodulation product – specification limit

** - Antenna Assembly Gain = Antenna Gain (dBd) – Cable Loss (dB) = 5.85 – 2 = 3.85dBd

*** - Maximum ERP of intermodulation product = Worst case from SA reading (Without ALC or With ALC) + Antenna Gain (dBd) - Cable Loss (dB)

Reference numbers of test equipment used

HL 0539	HL 0789	HL 1182	HL 2909	HL 3174	HL 3770	HL 3790	HL 3994
HL 4273	HL 4274						

Full description is given in Appendix A.



HERMON LABORATORIES Test Specification:		Section 90.210(b), Intermodulation product test	
Test procedure:		47 CFR, Sections 2.1051, 2.1047 and 90.210(b); KDB 935210 D02 v02, Appendix D	
Test mode:	Compliance	Verdict:	PASS
Date(s):	10-Aug-14		
Temperature: 23.2 °C	Air Pressure: 1006 hPa	Relative Humidity: 43 %	Power Supply: 120 VAC
Remarks:			

Plot 7.4.1 Intermodulation test results at frequency range 758 - 775 MHz, Low Band

OPERATING FREQUENCY RANGE:
DETECTOR USED:
NOISE FIGURE:
CONFIGURATION:
POWER SETTING:
OPERATION FREQUENCIES:
CONFIGURATION:
INPUT POWER: -51 dBm

758 – 775 MHz
Average
Within and outside the passband
Downlink
30dBm
Flow, Fhigh
Single Band
INPUT POWER: -41 dBm

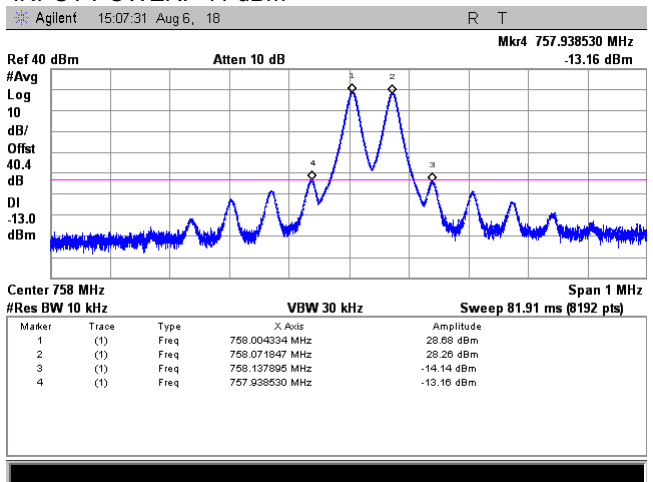
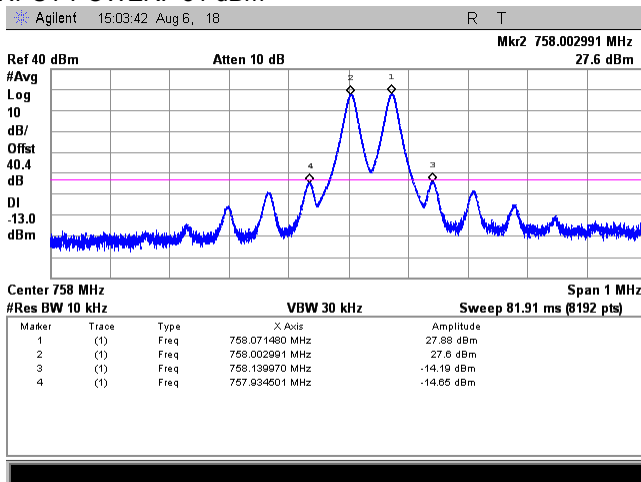

Plot 7.4.2 Intermodulation test results at frequency range 758 - 775 MHz, Mid Band

OPERATING FREQUENCY RANGE:
DETECTOR USED:
NOISE FIGURE:
CONFIGURATION:
POWER SETTING:
OPERATION FREQUENCIES:
CONFIGURATION:
INPUT POWER: -51 dBm

758 – 775 MHz
Average
Within and outside the passband
Downlink
30dBm
Flow, Fhigh
Single Band
INPUT POWER: -41 dBm

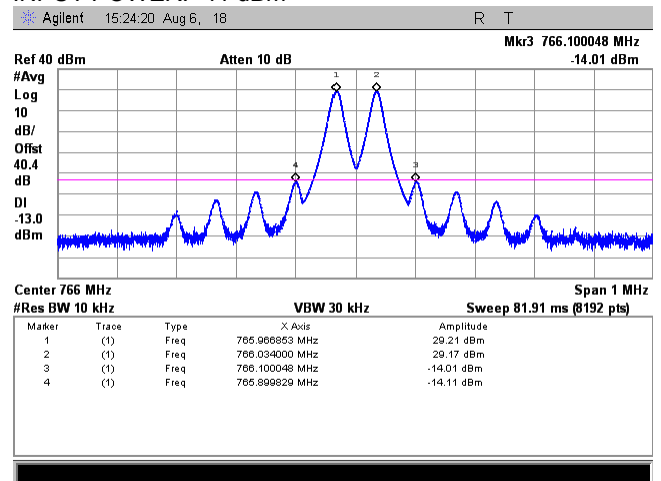
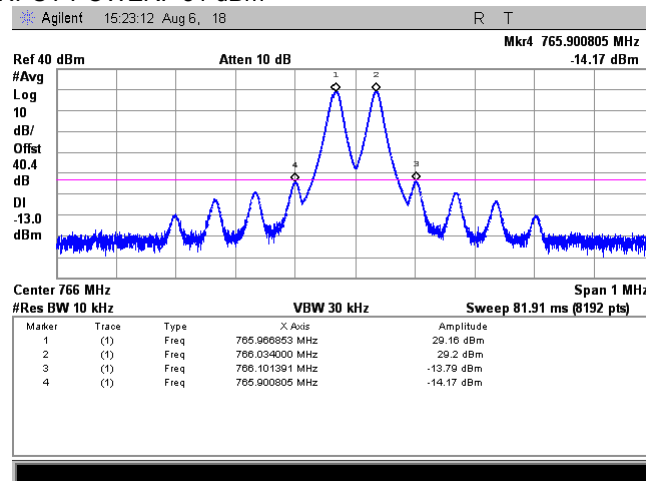



HERMON LABORATORIES Test Specification:		Section 90.210(b), Intermodulation product test	
Test procedure: 47 CFR, Sections 2.1051, 2.1047 and 90.210(b); KDB 935210 D02 v02, Appendix D			
Test mode: Compliance		Verdict: PASS	
Date(s): 10-Aug-14			
Temperature: 23.2 °C		Air Pressure: 1006 hPa	Relative Humidity: 43 %
		Power Supply: 120 VAC	
Remarks:			

Plot 7.4.3 Intermodulation test results at frequency range 758 - 775 MHz, High Band

OPERATING FREQUENCY RANGE:
DETECTOR USED:
NOISE FIGURE:
CONFIGURATION:
POWER SETTING:
OPERATION FREQUENCIES:
CONFIGURATION:
INPUT POWER: -51 dBm

758 – 775 MHz
Average
Within and outside the passband
Downlink
30dBm
Flow, Fhigh
Single Band
INPUT POWER: -41 dBm

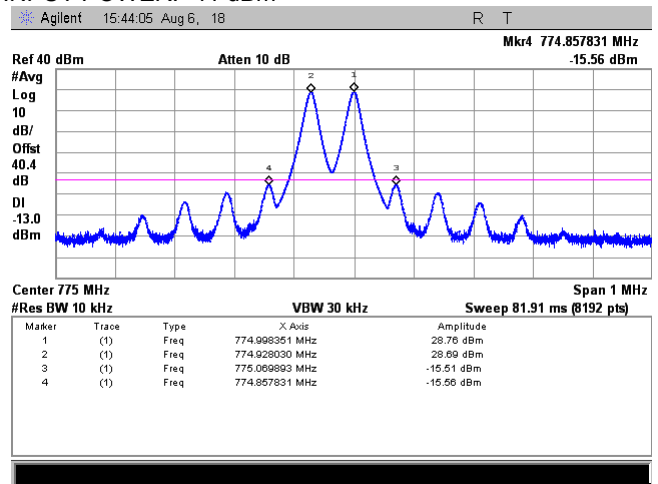
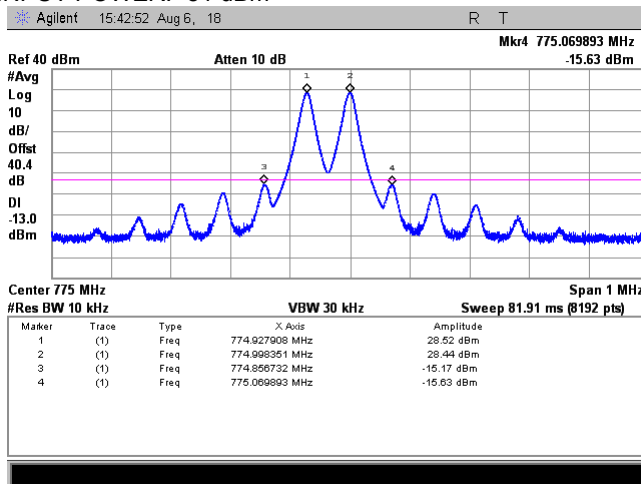

Plot 7.4.4 Intermodulation test results at frequency range 788 - 805 MHz, Low Band

OPERATING FREQUENCY RANGE:
DETECTOR USED:
AVERAGING:
CONFIGURATION:
OPERATION FREQUENCIES:
CONFIGURATION:
INPUT POWER: -54 dBm

788 – 805 MHz
Average
On, 100 traces
Uplink
Flow, Fhigh
Single Band
INPUT POWER: -44 dBm

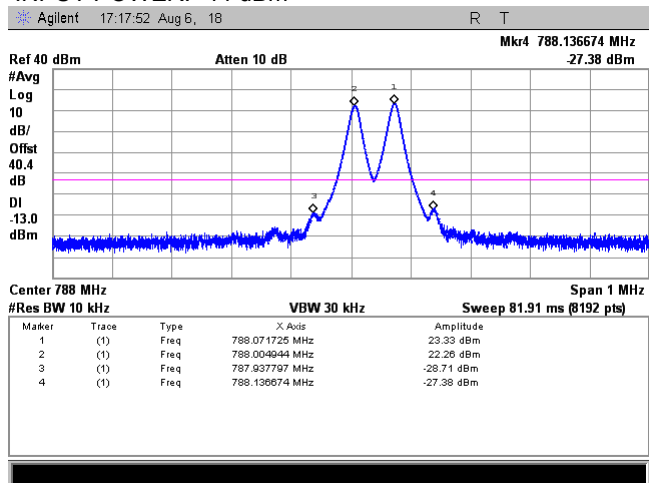
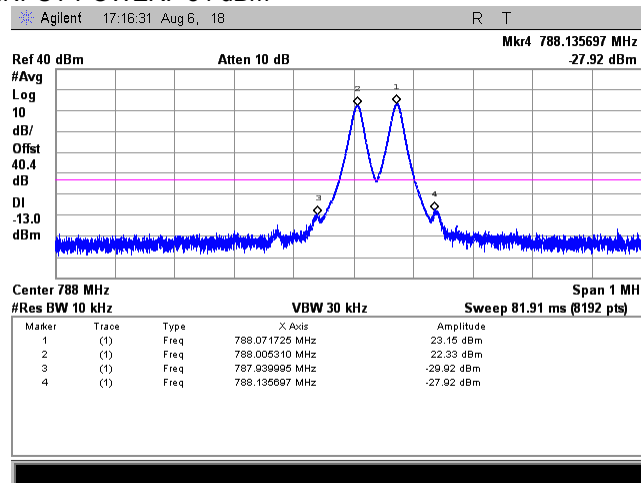



HERMON LABORATORIES Test Specification:		Section 90.210(b), Intermodulation product test	
Test procedure:		47 CFR, Sections 2.1051, 2.1047 and 90.210(b); KDB 935210 D02 v02, Appendix D	
Test mode:	Compliance	Verdict: PASS	
Date(s):	10-Aug-14		
Temperature: 23.2 °C	Air Pressure: 1006 hPa	Relative Humidity: 43 %	Power Supply: 120 VAC
Remarks:			

Plot 7.4.5 Intermodulation test results at frequency range 788 - 805 MHz, Mid Band

OPERATING FREQUENCY RANGE:
DETECTOR USED:
AVERAGING:
CONFIGURATION:
OPERATION FREQUENCIES:
CONFIGURATION:
INPUT POWER: -54 dBm

788 – 805 MHz
Average
On, 100 traces
Uplink
Flow, Fhigh
Single Band
INPUT POWER: -44 dBm

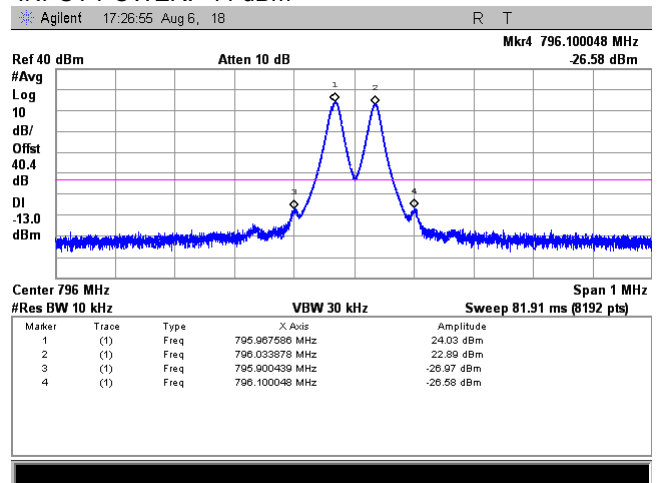
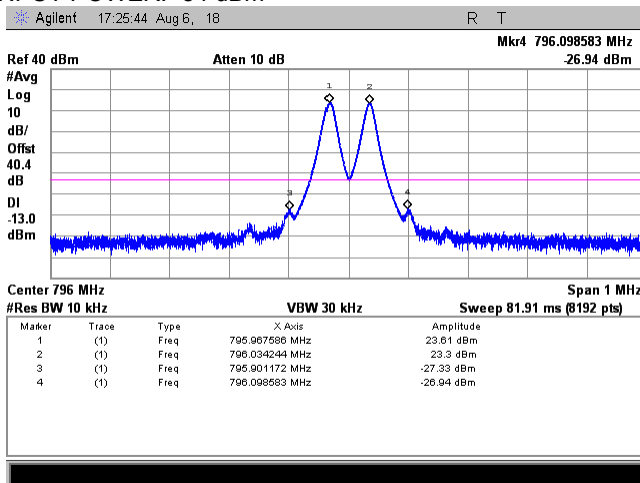

Plot 7.4.6 Intermodulation test results at frequency range 788 - 805 MHz, High Band

OPERATING FREQUENCY RANGE:
DETECTOR USED:
AVERAGING:
CONFIGURATION:
OPERATION FREQUENCIES:
CONFIGURATION:
INPUT POWER: -54 dBm

788 – 805 MHz
Average
On, 100 traces
Uplink
Flow, Fhigh
Single Band
INPUT POWER: -44 dBm

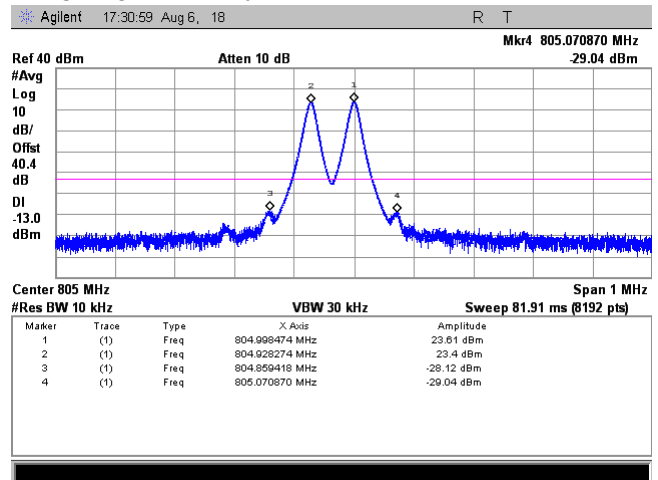
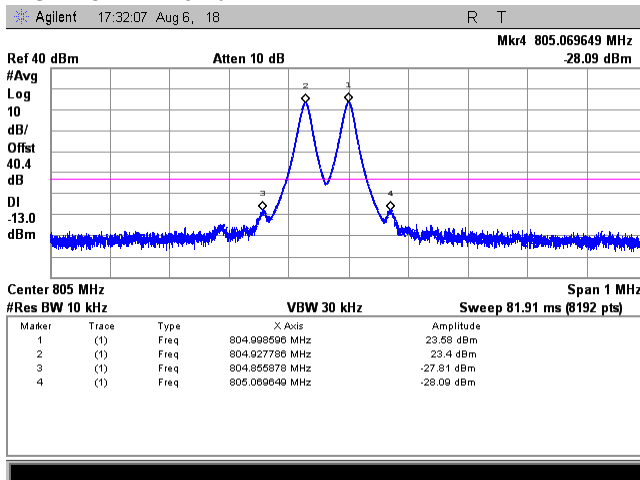



HERMON LABORATORIES Test Specification:		Section 90.210(b), Intermodulation product test	
Test procedure:		47 CFR, Sections 2.1051, 2.1047 and 90.210(b); KDB 935210 D02 v02, Appendix D	
Test mode:	Compliance	Verdict:	PASS
Date(s):	10-Aug-14	Relative Humidity:	43 %
Temperature:	23.2 °C	Air Pressure:	1006 hPa
Remarks:		Power Supply:	120 VAC

Plot 7.4.7 Intermodulation results at frequency range 851 - 861 MHz, Low Band

OPERATING FREQUENCY RANGE:
DETECTOR USED:
CONFIGURATION:
POWER SETTING:
OPERATION FREQUENCIES:
CONFIGURATION:
INPUT POWER: -51 dBm

851 – 861 MHz
Average
Downlink
30dBm
Flow, Fhigh
Single Band
INPUT POWER: -41 dBm

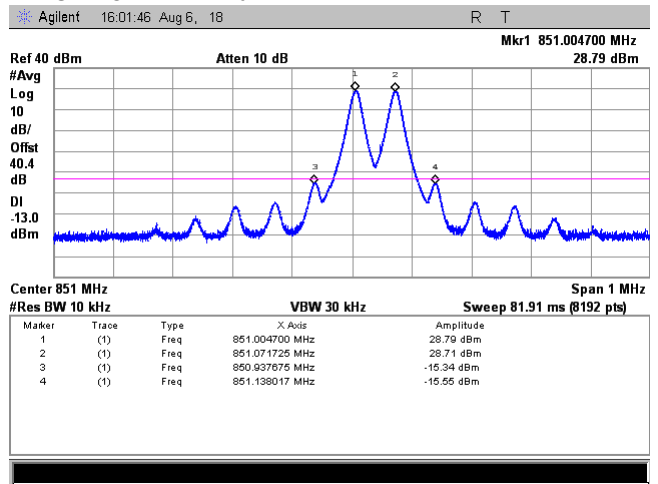
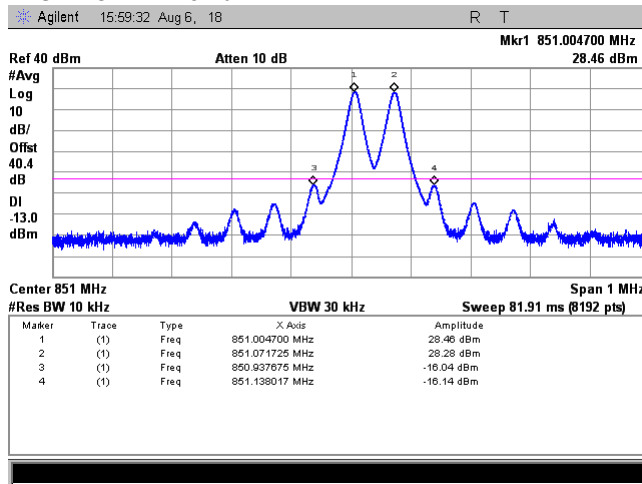

Plot 7.4.8 Intermodulation results at frequency range 851 - 861 MHz, Mid Band

OPERATING FREQUENCY RANGE:
DETECTOR USED:
CONFIGURATION:
POWER SETTING:
OPERATION FREQUENCIES:
CONFIGURATION:
INPUT POWER: -51 dBm

851 – 861 MHz
Average
Downlink
30dBm
Flow, Fhigh
Single Band
INPUT POWER: -41 dBm

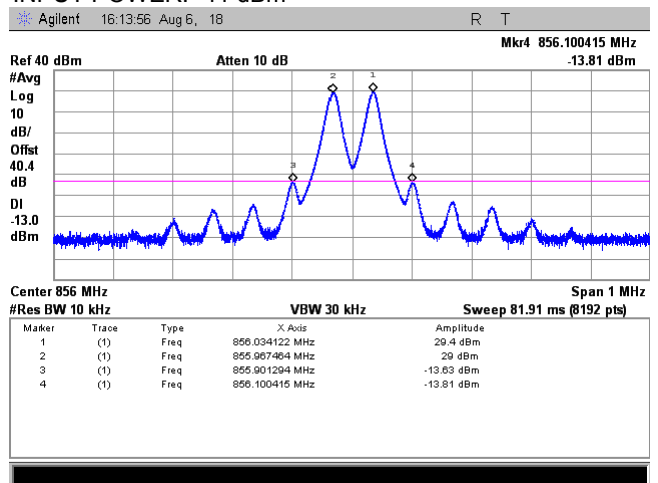
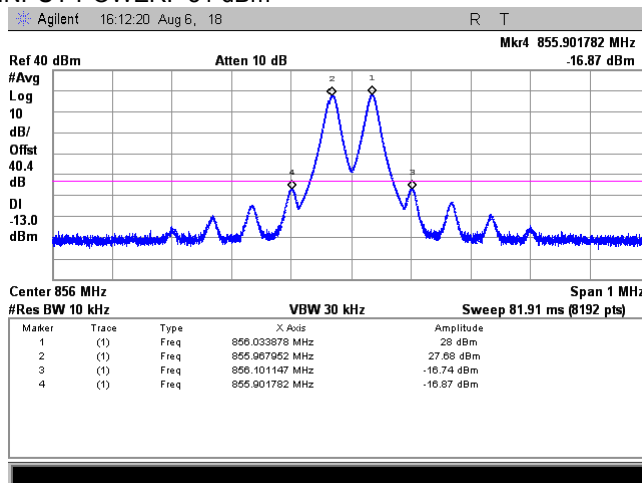



HERMON LABORATORIES Test Specification:		Section 90.210(b), Intermodulation product test	
Test procedure:		47 CFR, Sections 2.1051, 2.1047 and 90.210(b); KDB 935210 D02 v02, Appendix D	
Test mode:		Compliance	
Date(s):		10-Aug-14	
Temperature: 23.2 °C		Air Pressure: 1006 hPa	
Remarks:		Verdict: PASS	
		Relative Humidity: 43 %	
		Power Supply: 120 VAC	

Plot 7.4.9 Intermodulation results at frequency range 851 - 861 MHz, High Band

OPERATING FREQUENCY RANGE:
DETECTOR USED:
CONFIGURATION:
POWER SETTING:
OPERATION FREQUENCIES:
CONFIGURATION:
INPUT POWER: -51 dBm

851 – 861 MHz
Average
Downlink
30dBm
Flow, Fhigh
Single Band
INPUT POWER: -41 dBm

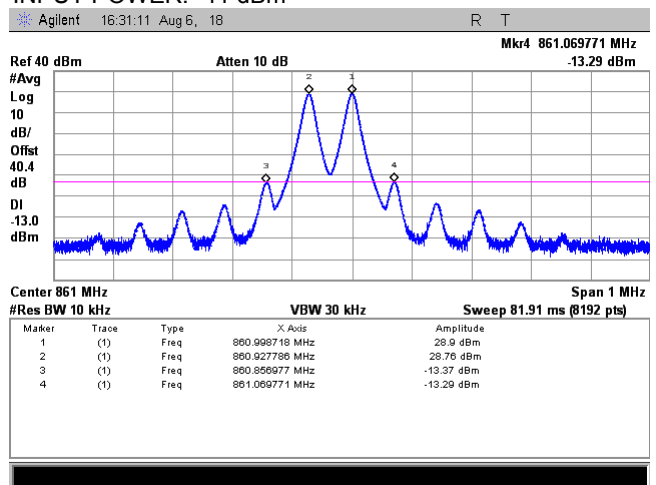
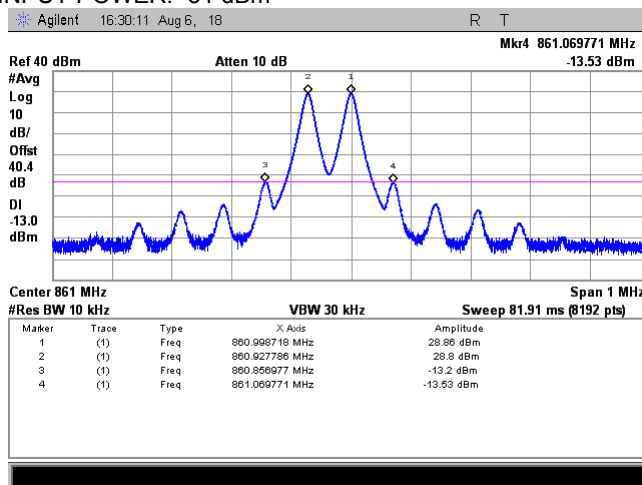

Plot 7.4.10 Intermodulation test results at frequency range 806 - 816 MHz, Low Band

OPERATING FREQUENCY RANGE:
DETECTOR USED:
AVERAGING:
CONFIGURATION:
OPERATION FREQUENCIES:
CONFIGURATION:
INPUT POWER: -54 dBm

806 – 816 MHz
Average
On, 100 traces
Uplink
Flow, Fhigh
Dual Band
INPUT POWER: -44 dBm

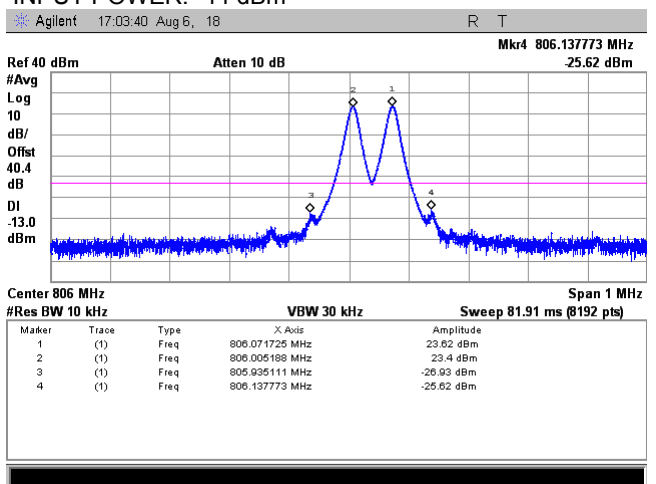
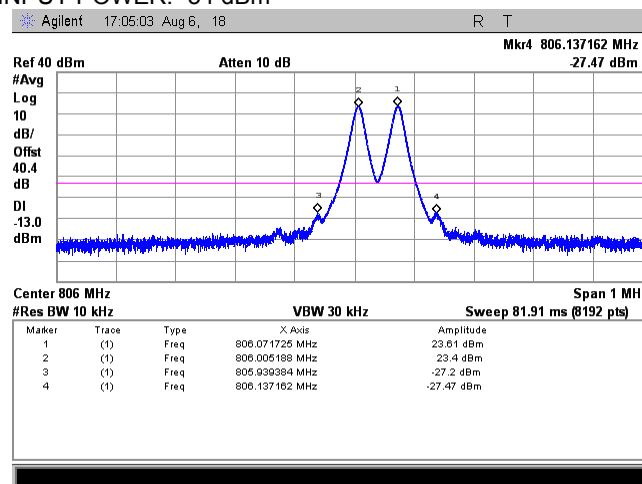



HERMON LABORATORIES Test Specification:		Section 90.210(b), Intermodulation product test	
Test procedure: 47 CFR, Sections 2.1051, 2.1047 and 90.210(b); KDB 935210 D02 v02, Appendix D			
Test mode: Compliance		Verdict: PASS	
Date(s): 10-Aug-14		Relative Humidity: 43 %	
Temperature: 23.2 °C		Power Supply: 120 VAC	
Remarks:			

Plot 7.4.11 Intermodulation test results at frequency range 806 - 816 MHz, Mid Band

OPERATING FREQUENCY RANGE:
DETECTOR USED:
AVERAGING:
CONFIGURATION:
OPERATION FREQUENCIES:
CONFIGURATION:
INPUT POWER: -54 dBm

806 – 816 MHz
Average
On, 100 traces
Uplink
Flow, Fhigh
Dual Band
INPUT POWER: -44 dBm

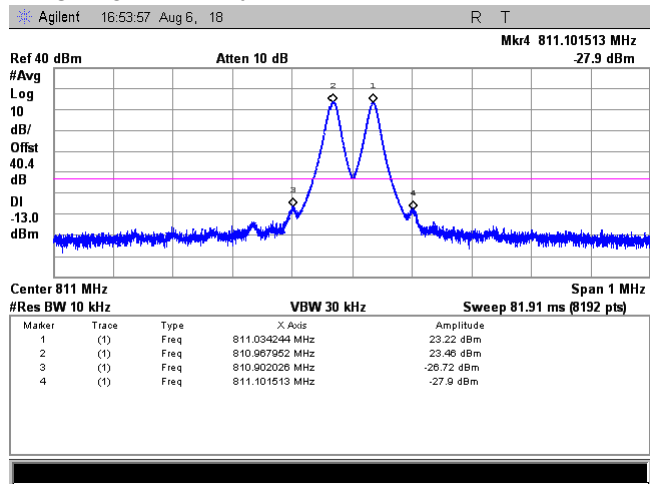
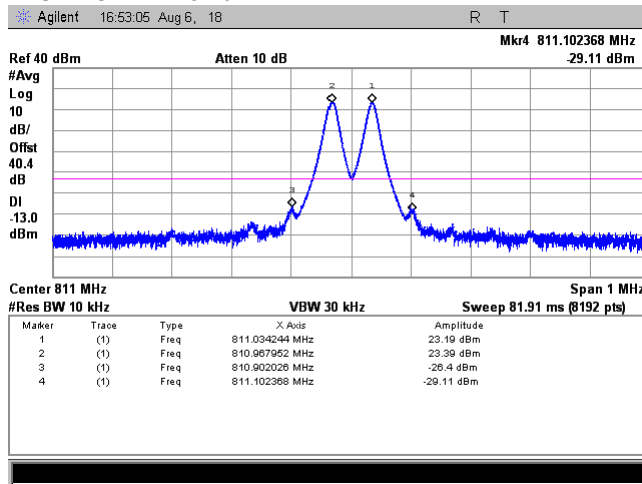

Plot 7.4.12 Intermodulation test results at frequency range 806 - 816 MHz, High Band

OPERATING FREQUENCY RANGE:
DETECTOR USED:
AVERAGING:
CONFIGURATION:
OPERATION FREQUENCIES:
CONFIGURATION:
INPUT POWER: -54 dBm

806 – 816 MHz
Average
On, 100 traces
Uplink
Flow, Fhigh
Dual Band
INPUT POWER: -44 dBm

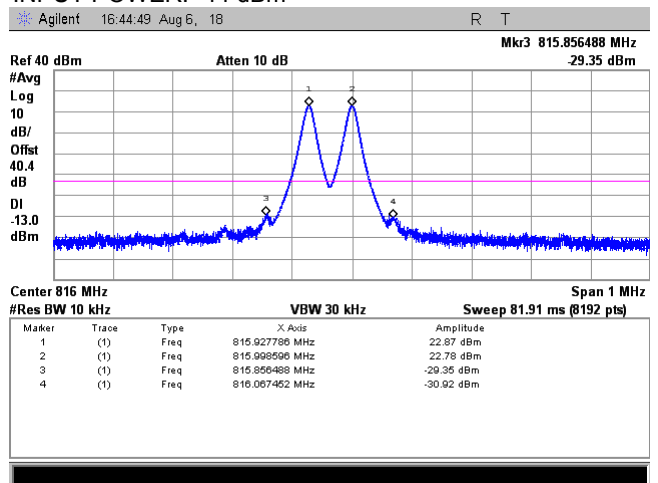
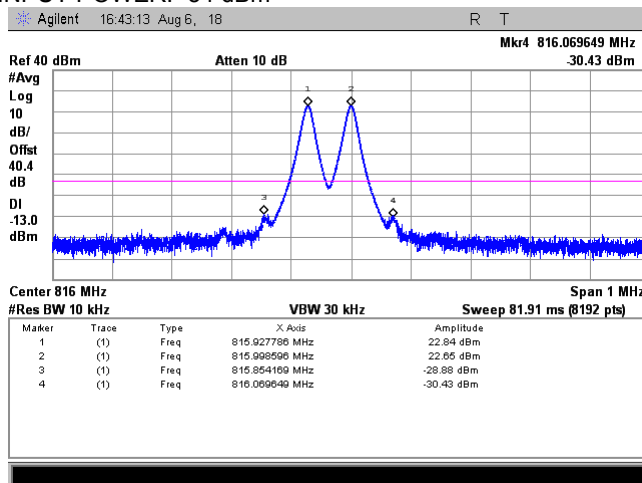

Test specification:		Section 90.219(e)(2), Noise figure	
Test procedure:		47 CFR, Sections 2.1051; KDB 935210 D02 v02, Appendix D	
Test mode:		Compliance	
Date(s):		28-Aug-14	
Temperature: 23.2 °C		Air Pressure: 1005 hPa	
Remarks:		Verdict: PASS	
		Relative Humidity: 44 %	
		Power Supply: 120 VAC	

7.5 Noise figure test

7.5.1 General

This test was performed to measure emission mask at RF antenna connector. Specification test limits are given in Table 7.5.1.

Table 7.5.1 Noise figure limits

Frequency range	Noise figure limit, dB
Class A Booster	
758.0 – 775.0 / 788.0 – 805.0	9.0
851.0 – 861.0 / 806.0 – 816.0	

7.5.2 Test procedure

7.5.2.1 The EUT was set up as shown in Figure 7.5.1, energized and its proper operation was checked.

7.5.2.2 The noise figure was measured with Noise Figure Analyzer as provided in the associated plots.

Figure 7.5.1 Emission mask test setup

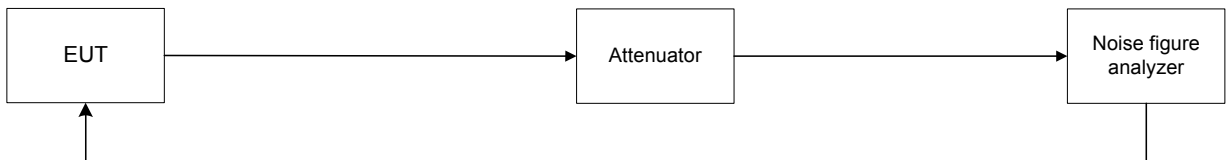



Test specification:	Section 90.219(e)(2), Noise figure		
Test procedure:	47 CFR, Sections 2.1051; KDB 935210 D02 v02, Appendix D		
Test mode:	Compliance	Verdict: PASS	
Date(s):	28-Aug-14		
Temperature: 23.2 °C	Air Pressure: 1005 hPa	Relative Humidity: 44 %	Power Supply: 120 VAC
Remarks:			

Table 7.5.2 Noise figure test results

Frequency, MHz	Noise figure, dB	Limit, dB	Margin, dB	Verdict
Frequency range, 758 – 775 MHz Downlink				
758.06	4.11	9.0	-4.89	Pass
769.03	3.17	9.0	-5.83	Pass
774.95	3.94	9.0	-5.06	Pass
Frequency range, 788 – 805 MHz Uplink				
788.04	2.12	9.0	-6.88	Pass
799.04	0.97	9.0	-8.03	Pass
804.94	0.93	9.0	-8.07	Pass
Frequency range, 851 – 861 MHz Downlink				
851.00	4.59	9.0	-4.41	Pass
856.06	3.55	9.0	-5.45	Pass
860.96	3.81	9.0	-5.19	Pass
Frequency range, 806 –816 MHz Uplink				
806.04	0.83	9.0	-8.17	Pass
811.00	0.74	9.0	-8.26	Pass
815.95	1.51	9.0	-7.49	Pass

Reference numbers of test equipment used

HL 3901	HL 3994	HL 4274				
---------	---------	---------	--	--	--	--

Full description is given in Appendix A.

Test specification: Section 90.219(e)(2), Noise figure			
Test procedure: 47 CFR, Sections 2.1051; KDB 935210 D02 v02, Appendix D			
Test mode: Compliance		Verdict: PASS	
Date(s): 28-Aug-14			
Temperature: 23.2 °C	Air Pressure: 1005 hPa	Relative Humidity: 44 %	Power Supply: 120 VAC
Remarks:			

Plot 7.5.1 Noise figure test results at low frequency

OPERATING FREQUENCY RANGE: 758 – 775 MHz
 DETECTOR USED: Average
 NOISE FIGURE: Within the passband
 CONFIGURATION: Downlink
 POWER SETTING: 33 dBm

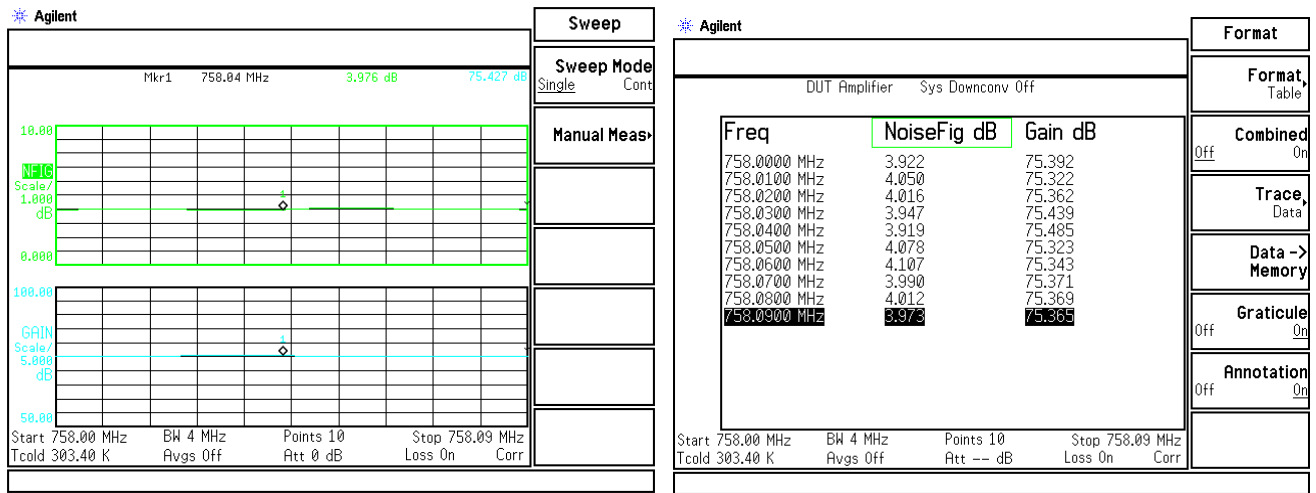

Plot 7.5.2 Noise figure test results at mid frequency

OPERATING FREQUENCY RANGE: 758 – 775 MHz
 DETECTOR USED: Average
 NOISE FIGURE: Within the passband
 CONFIGURATION: Downlink
 POWER SETTING: 33 dBm

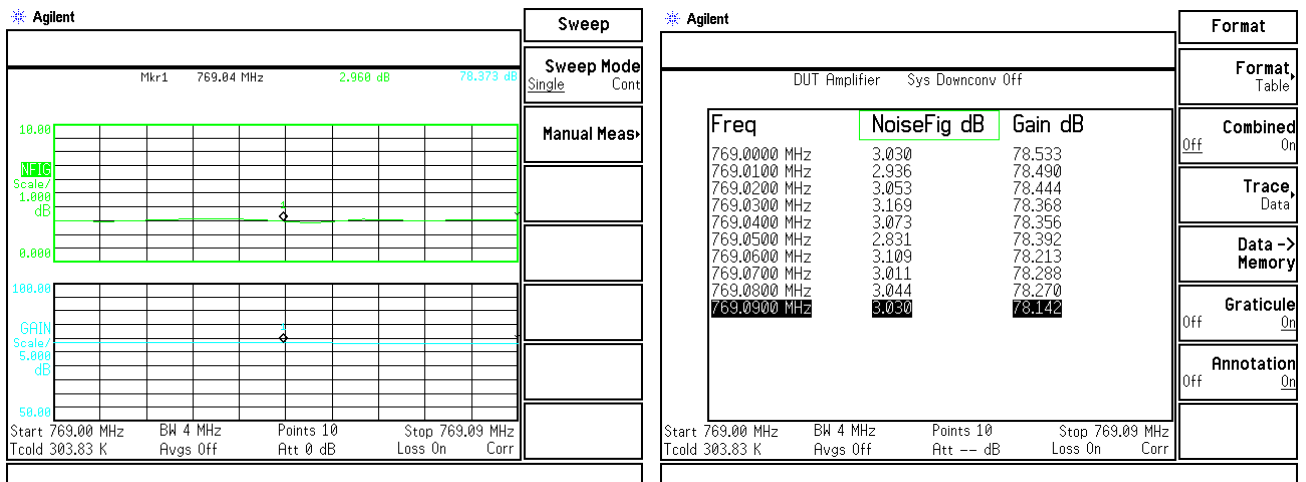

Test specification: Section 90.219(e)(2), Noise figure			
Test procedure: 47 CFR, Sections 2.1051; KDB 935210 D02 v02, Appendix D			
Test mode: Compliance	Verdict: PASS		
Date(s): 28-Aug-14			
Temperature: 23.2 °C	Air Pressure: 1005 hPa	Relative Humidity: 44 %	Power Supply: 120 VAC
Remarks:			

Plot 7.5.3 Noise figure test results at high frequency

OPERATING FREQUENCY RANGE: 758 – 775 MHz
 DETECTOR USED: Average
 NOISE FIGURE: Within the passband
 CONFIGURATION: Downlink
 POWER SETTING: 33 dBm

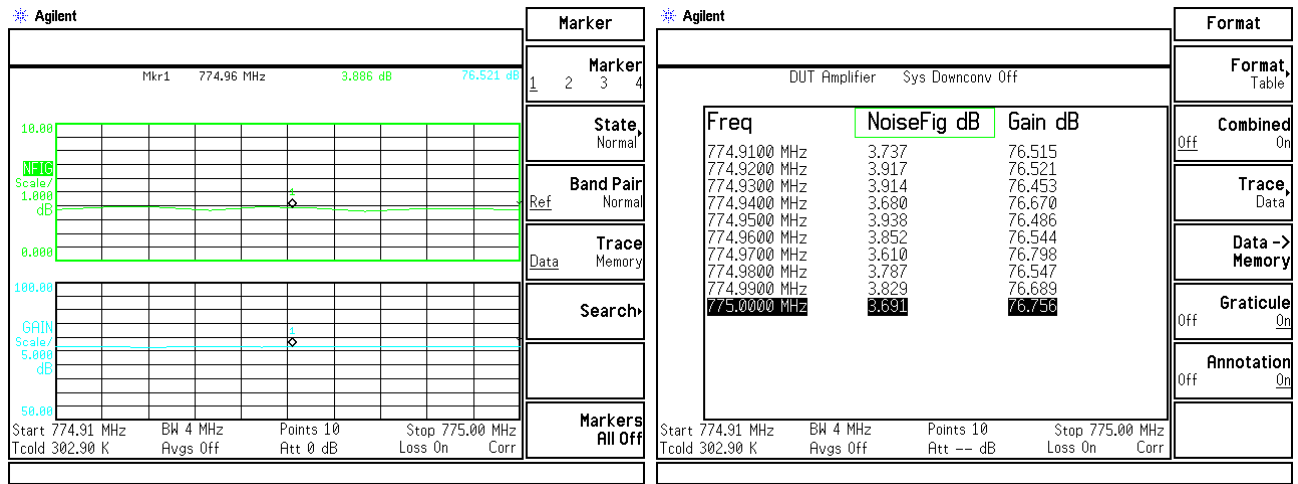

Plot 7.5.4 Noise figure test results at low frequency

OPERATING FREQUENCY RANGE: 851 – 861 MHz
 DETECTOR USED: Average
 NOISE FIGURE: Within the passband
 CONFIGURATION: Downlink
 POWER SETTING: 33 dBm

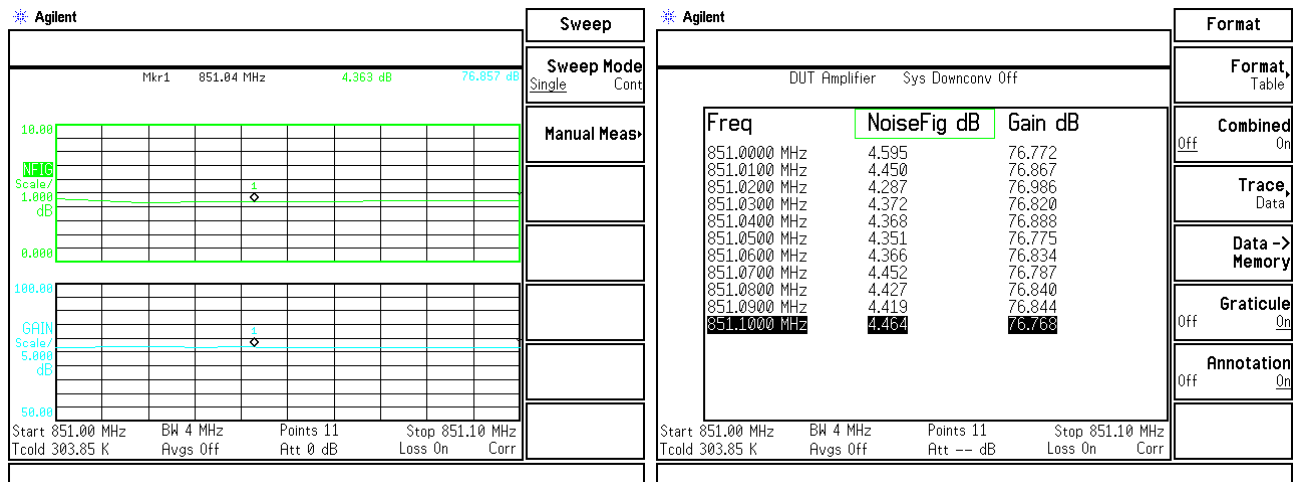

Test specification: Section 90.219(e)(2), Noise figure			
Test procedure: 47 CFR, Sections 2.1051; KDB 935210 D02 v02, Appendix D			
Test mode: Compliance	Verdict: PASS		
Date(s): 28-Aug-14			
Temperature: 23.2 °C	Air Pressure: 1005 hPa	Relative Humidity: 44 %	Power Supply: 120 VAC
Remarks:			

Plot 7.5.5 Noise figure test results at mid frequency

OPERATING FREQUENCY RANGE: 851 – 861 MHz
DETECTOR USED: Average
NOISE FIGURE: Within the passband
CONFIGURATION: Downlink
POWER SETTING: 33 dBm

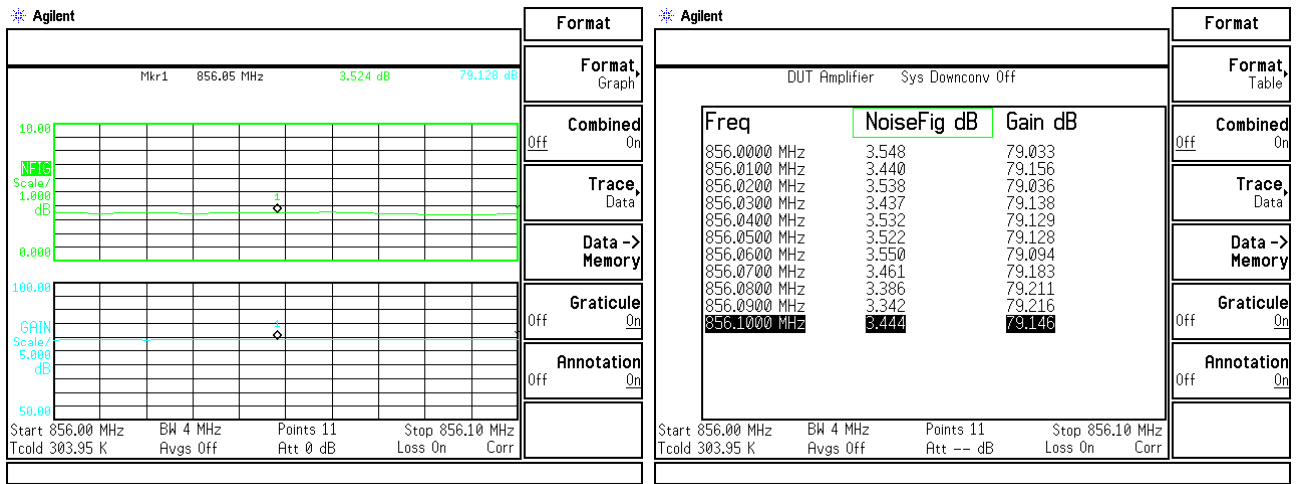

Plot 7.5.6 Noise figure test results at high frequency

OPERATING FREQUENCY RANGE: 851 – 861 MHz
DETECTOR USED: Average
NOISE FIGURE: Within the passband
CONFIGURATION: Downlink
POWER SETTING: 33 dBm

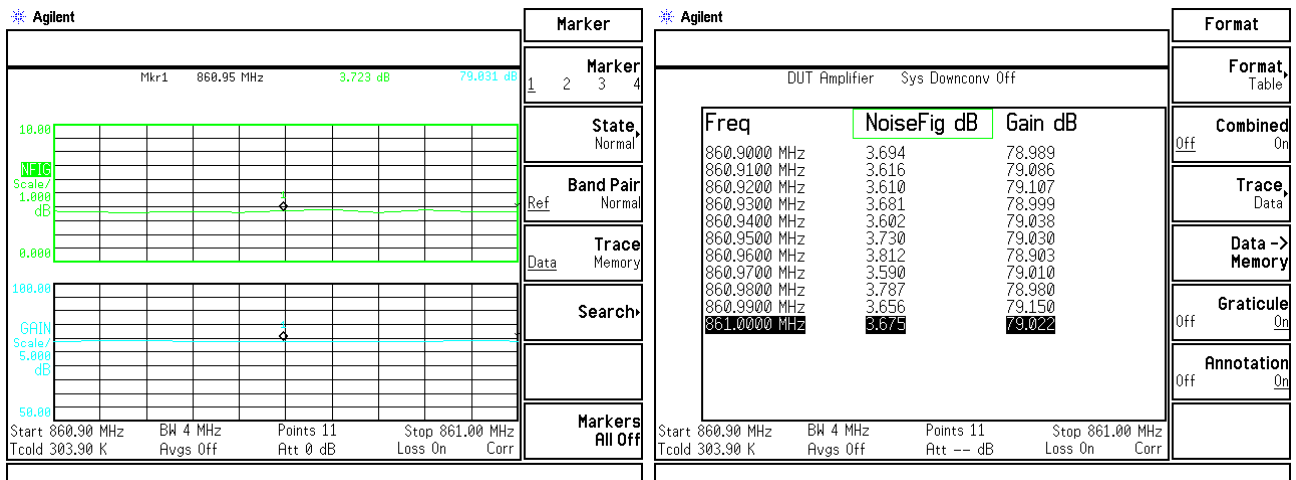

Test specification: Section 90.219(e)(2), Noise figure	
Test procedure: 47 CFR, Sections 2.1051; KDB 935210 D02 v02, Appendix D	
Test mode: Compliance	Verdict: PASS
Date(s): 28-Aug-14	
Temperature: 23.2 °C	Air Pressure: 1005 hPa
	Relative Humidity: 44 %
	Power Supply: 120 VAC
Remarks:	

Plot 7.5.7 Noise figure test results at frequency range 788 - 805 MHz

OPERATING FREQUENCY RANGE: 788 – 805 MHz
DETECTOR USED: Average
NOISE FIGURE: Within the passband
CONFIGURATION: Uplink
AMPLIFIER GAIN SETTING: 85 dB

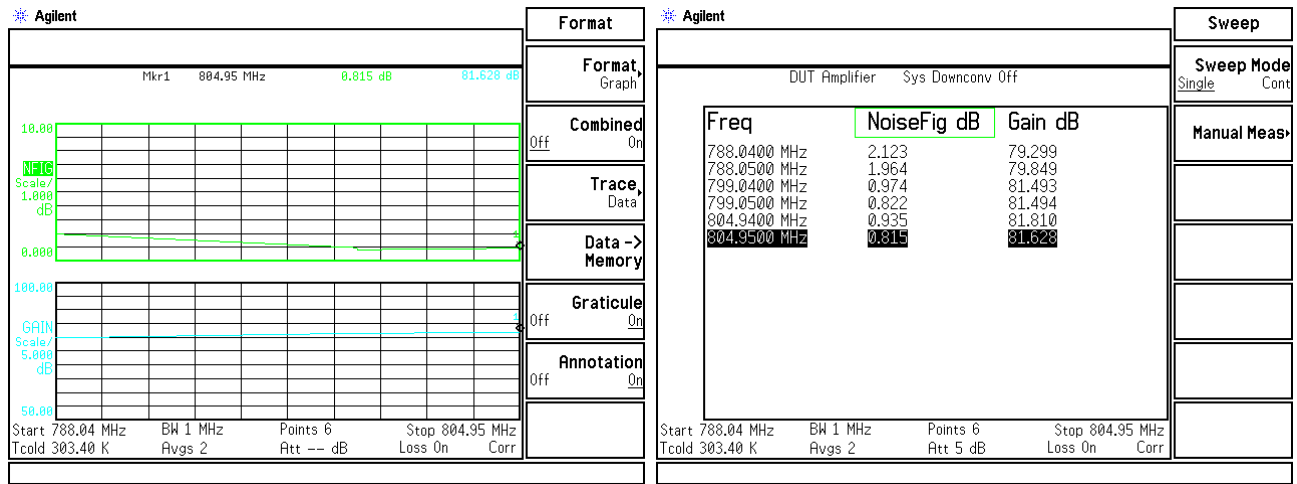

Plot 7.5.8 Noise figure test results at frequency range 806 - 816 MHz

OPERATING FREQUENCY RANGE: 806 – 816 MHz
DETECTOR USED: Average
NOISE FIGURE: Within the passband
CONFIGURATION: Uplink
AMPLIFIER GAIN SETTING: 85 dB

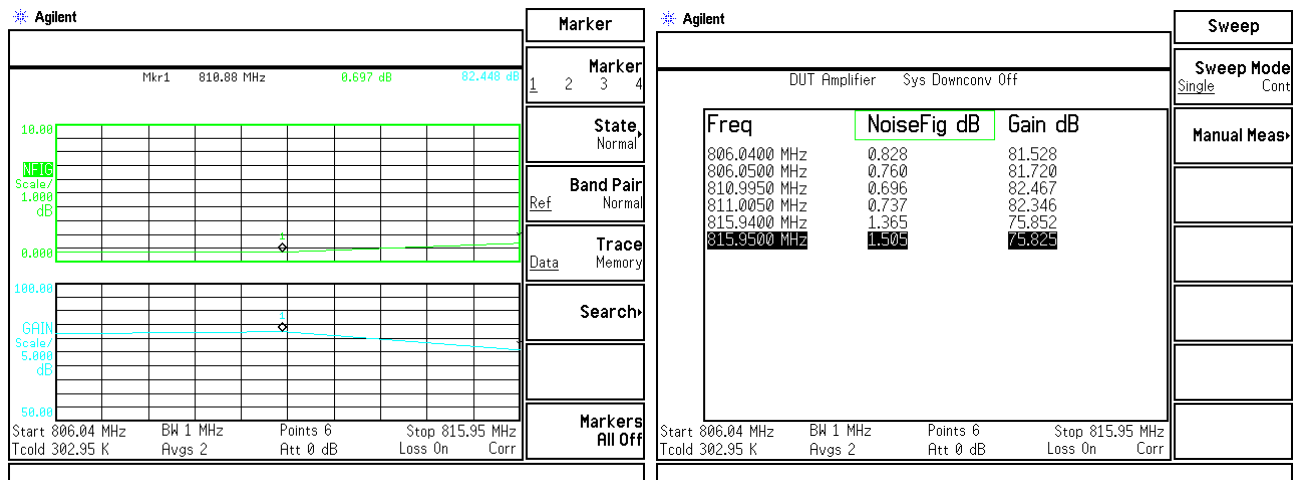



Test specification:	Section 90.210(h), Emission mask		
Test procedure:	47 CFR, Sections 2.1051; KDB 935210 D02 v02, Appendix D		
Test mode:	Compliance	Verdict:	PASS
Date(s):	31-Aug-14 – 1-Sep-14		
Temperature: 23.2 °C	Air Pressure: 1006 hPa	Relative Humidity: 43 %	Power Supply: 120 VAC
Remarks:			

7.6 Emission mask test according to section 90.210(h)

7.6.1 General

This test was performed to measure emission mask at RF antenna connector. Specification test limits are given in Table 7.6.1.

Table 7.6.1 Emission mask limits

Frequency displacement from carrier	Attenuation below carrier, dBc
Emission mask H (Channel bandwidth 8 kHz, authorized bandwidth 8 kHz)	
0 – 4.0 kHz	0
4.0 – 8.5 kHz	107 log (fd/4)
8.5 – 15.0 kHz	40.5 log (fd/1.16)
15.0 – 25.0 kHz	116 log (fd/6.1)
More than 25.0 kHz	43+10logP(W)

* - linearly increase with frequency

** - emission mask includes carrier modulation envelope within ± 250 % of the authorized bandwidth; the frequency range removed beyond ± 250 % of the authorized bandwidth from carrier was investigated as spurious emission

7.6.2 Test procedure

7.6.2.1 The EUT was set up as shown in Figure 7.6.1, energized and its proper operation was checked.

7.6.2.2 The emission mask was measured with spectrum analyzer as provided in the associated plots.

Figure 7.6.1 Emission mask test setup





HERMON LABORATORIES

Test specification: Section 90.210(h), Emission mask			
Test procedure: 47 CFR, Sections 2.1051; KDB 935210 D02 v02, Appendix D			
Test mode: Compliance	Verdict: PASS		
Date(s): 31-Aug-14 – 1-Sep-14			
Temperature: 23.2 °C	Air Pressure: 1006 hPa	Relative Humidity: 43 %	Power Supply: 120 VAC
Remarks:			

Plot 7.6.1 Reference level test results at low carrier frequency, Port 1

FRQUENCY RANGE:
REFERENCE LEVEL:
CONFIGURATION: Dual Band
INPUT POWER: -54 dBm

851 - 861 MHz
Unmodulated power
CONFIGURATION: Single Band
INPUT POWER: -51 dBm

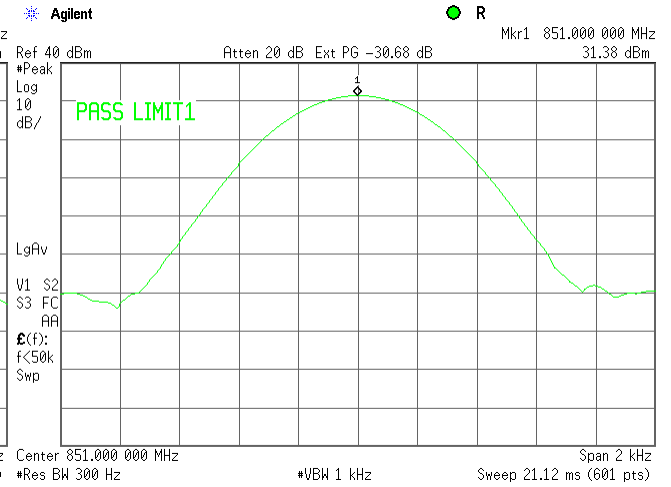
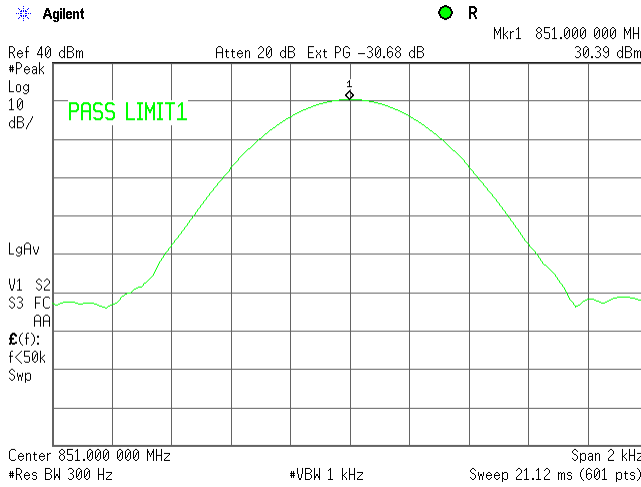

INPUT POWER: -24 dBm

INPUT POWER: -21 dBm

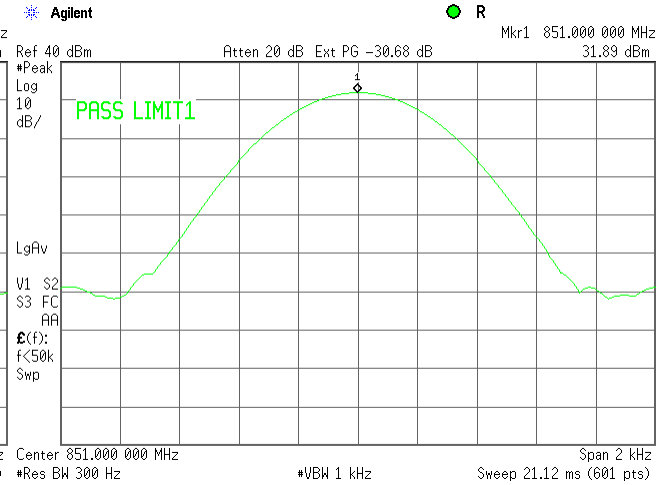
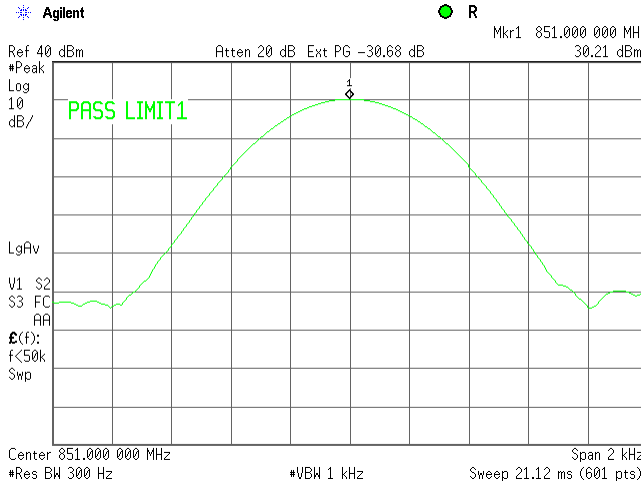



HERMON LABORATORIES

Test specification: Section 90.210(h), Emission mask			
Test procedure: 47 CFR, Sections 2.1051; KDB 935210 D02 v02, Appendix D			
Test mode: Compliance	Verdict: PASS		
Date(s): 31-Aug-14 – 1-Sep-14			
Temperature: 23.2 °C	Air Pressure: 1006 hPa	Relative Humidity: 43 %	Power Supply: 120 VAC
Remarks:			

Plot 7.6.2 Reference level test results at mid carrier frequency, Port 1

FRQUENCY RANGE:
REFERENCE LEVEL:
CONFIGURATION: Dual Band
INPUT POWER: -54 dBm

851 - 861 MHz
Unmodulated power
CONFIGURATION: Single Band
INPUT POWER: -51 dBm

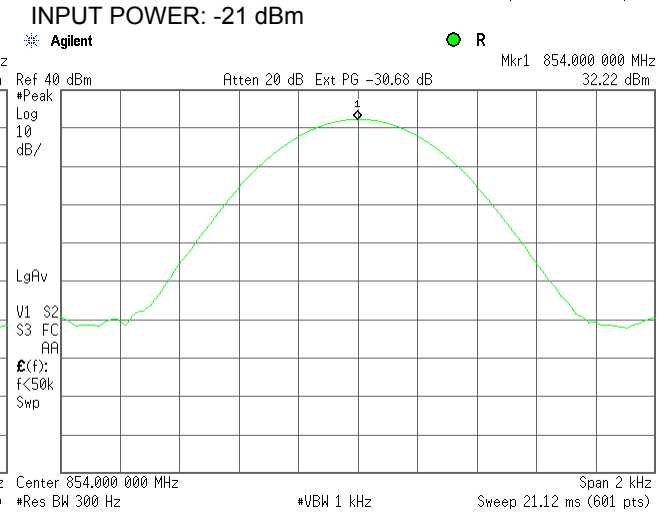
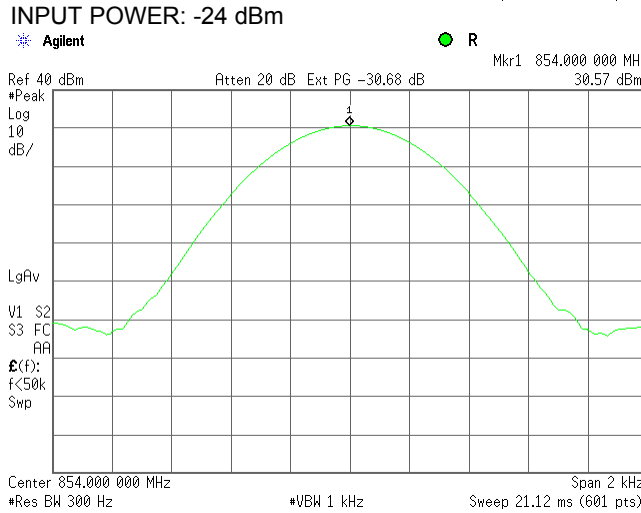
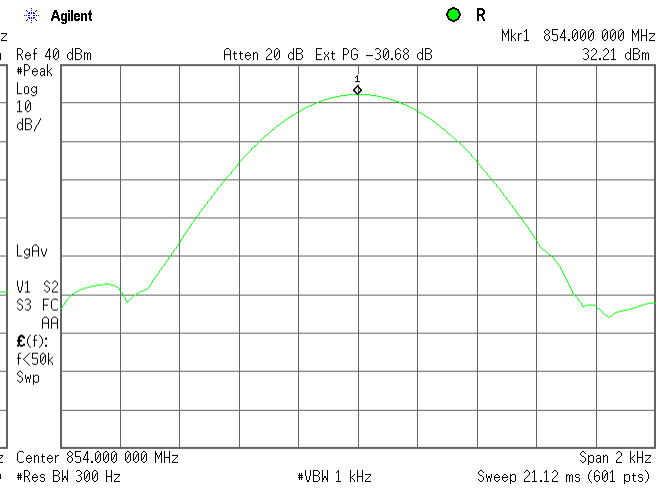
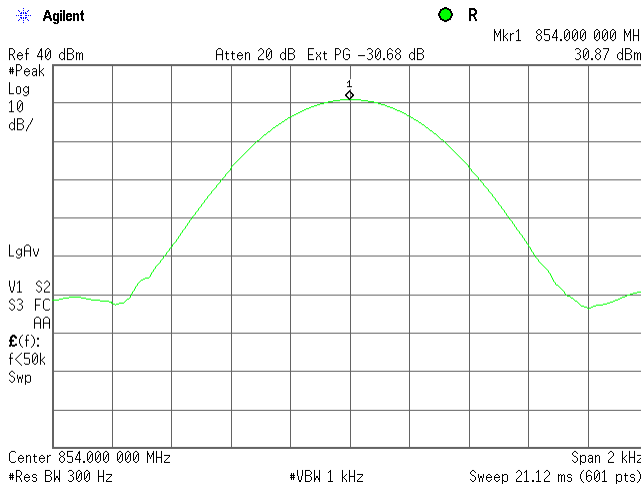



HERMON LABORATORIES

Test specification:	Section 90.210(h), Emission mask		
Test procedure:	47 CFR, Sections 2.1051; KDB 935210 D02 v02, Appendix D		
Test mode:	Compliance	Verdict:	PASS
Date(s):	31-Aug-14 – 1-Sep-14		
Temperature: 23.2 °C	Air Pressure: 1006 hPa	Relative Humidity: 43 %	Power Supply: 120 VAC
Remarks:			

Plot 7.6.3 Reference level test results at low carrier frequency, Port 1

FRQUENCY RANGE: 806 - 816 MHz
REFERENCE LEVEL: Unmodulated power
CONFIGURATION: Dual Band
INPUT POWER: -54 dBm

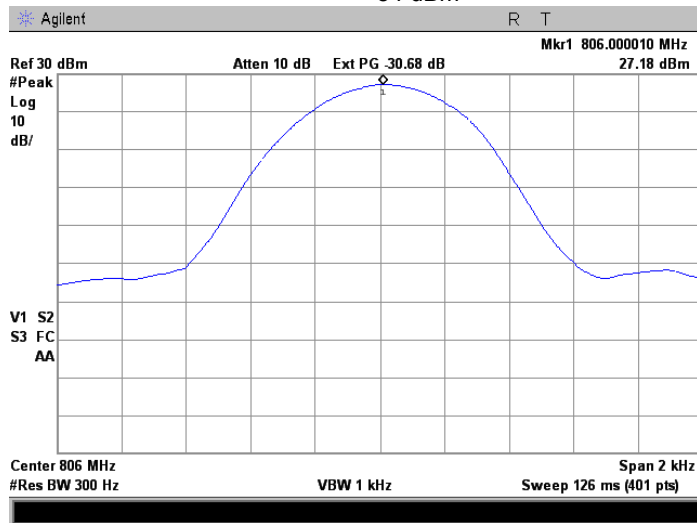

Plot 7.6.4 Reference level test results at mid carrier frequency, Port 1

FRQUENCY RANGE: 806 - 816 MHz
REFERENCE LEVEL: Unmodulated power
CONFIGURATION: Dual Band
INPUT POWER: -54 dBm

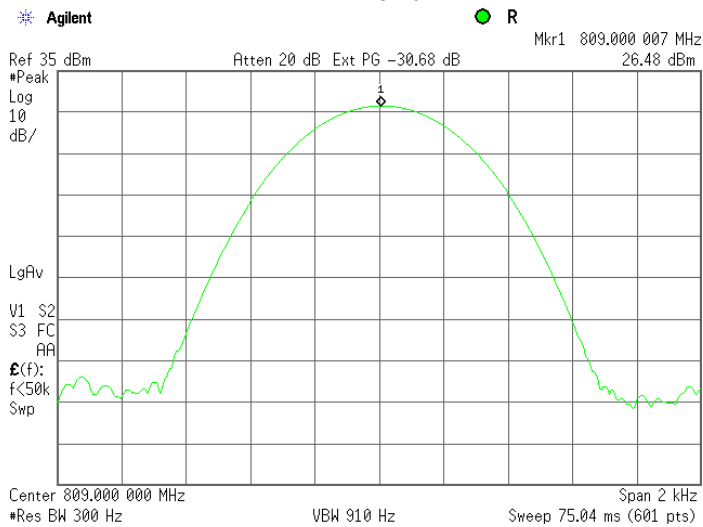



HERMON LABORATORIES

Test specification:		Section 90.210(h), Emission mask	
Test procedure:		47 CFR, Sections 2.1051; KDB 935210 D02 v02, Appendix D	
Test mode:		Compliance	
Date(s):		31-Aug-14 – 1-Sep-14	
Temperature: 23.2 °C		Air Pressure: 1006 hPa	
		Relative Humidity: 43 %	
		Power Supply: 120 VAC	
Remarks:			

Plot 7.6.5 Emission mask test result at low frequency carrier, Port 1

FREQUENCY RANGE:
OPERATIONAL MODE:
INPUT PORT:
EMISSION MASK:
CONFIGURATION:
INPUT POWER: -54 dBm

851 - 861 MHz
C4FM downlink transmit
Mobile
90.210(H)
Dual Band
INPUT POWER: -24 dBm

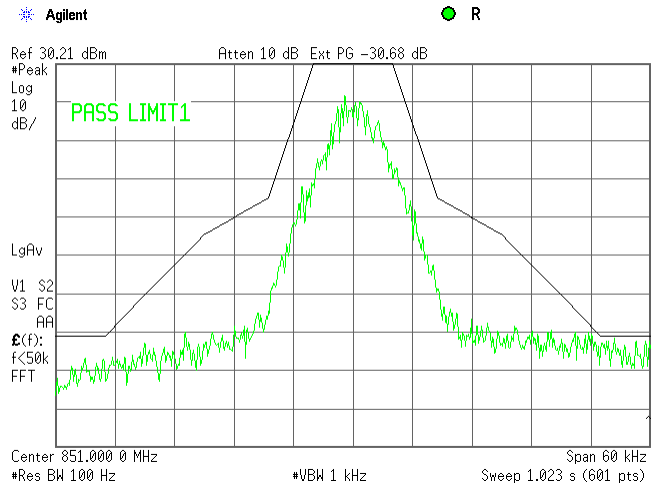
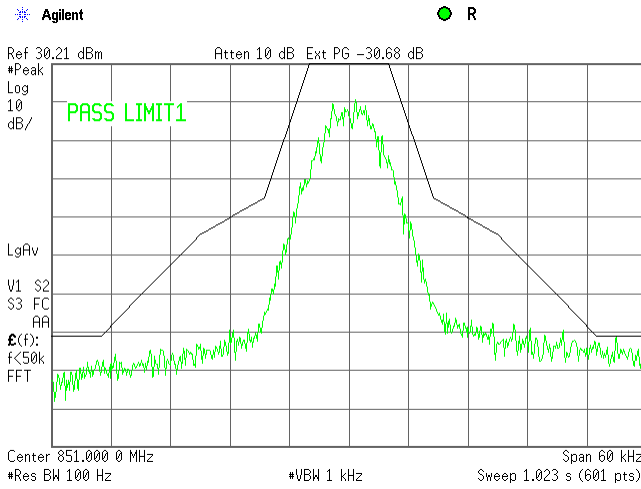

CONFIGURATION:
COMPOSITE INPUT POWER: -51 dBm

Single Band
COMPOSITE INPUT POWER: -21 dBm

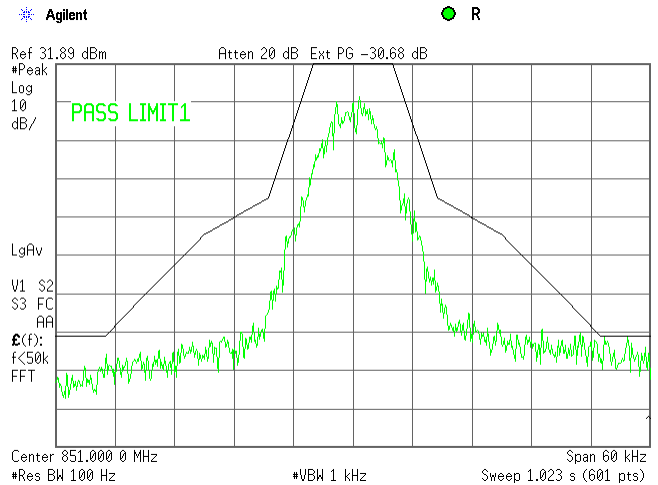
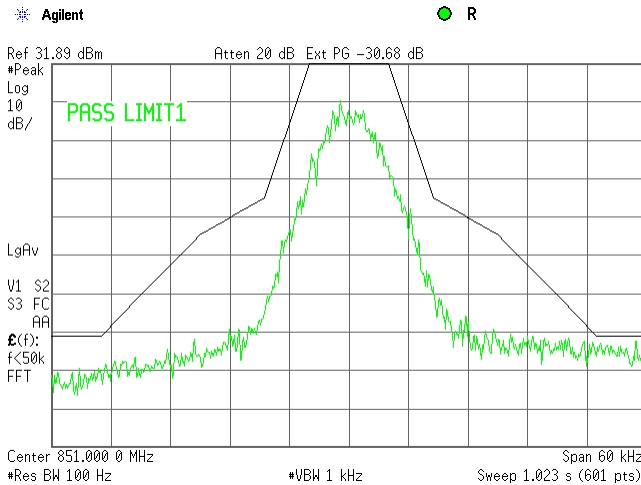



HERMON LABORATORIES

Test specification:		Section 90.210(h), Emission mask	
Test procedure:		47 CFR, Sections 2.1051; KDB 935210 D02 v02, Appendix D	
Test mode:		Compliance	
Date(s):		31-Aug-14 – 1-Sep-14	
Temperature: 23.2 °C		Air Pressure: 1006 hPa	
		Relative Humidity: 43 %	Power Supply: 120 VAC
Remarks:			
		Verdict: PASS	

Plot 7.6.6 Emission mask test result at mid frequency carrier, Port 1

FREQUENCY RANGE:
 OPERATIONAL MODE:
 INPUT PORT:
 EMISSION MASK:
 CONFIGURATION:
 INPUT POWER: -54 dBm

851 - 861 MHz
 C4FM downlink transmit
 Mobile
 90.210(H)
 Dual Band
 INPUT POWER: -24 dBm

Agilent

R

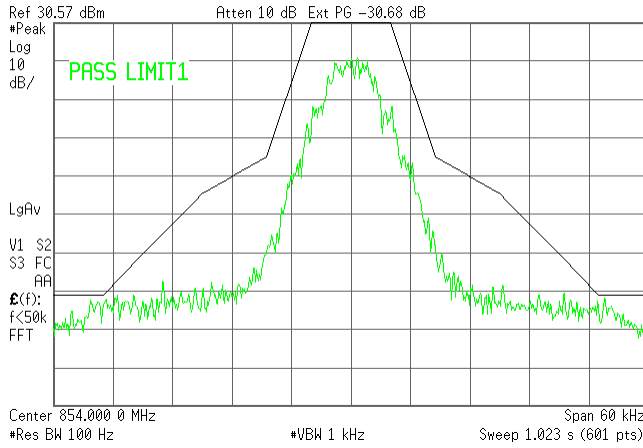

Agilent

R

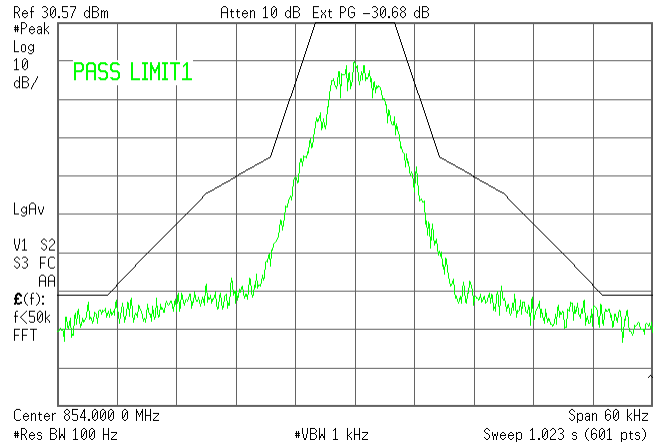

CONFIGURATION:
 COMPOSITE INPUT POWER: -51 dBm

Agilent

R

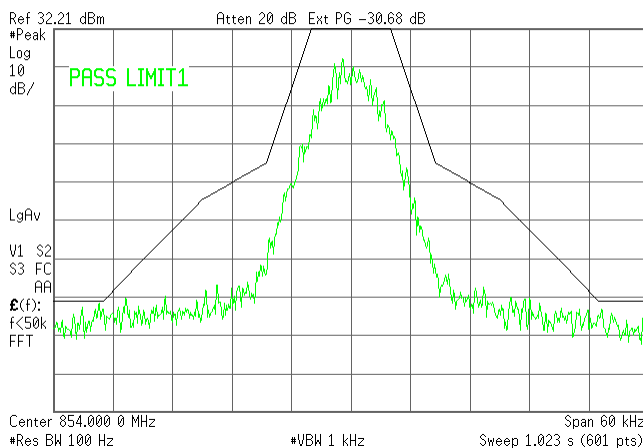

Single Band
 COMPOSITE INPUT POWER: -21 dBm

Agilent

R

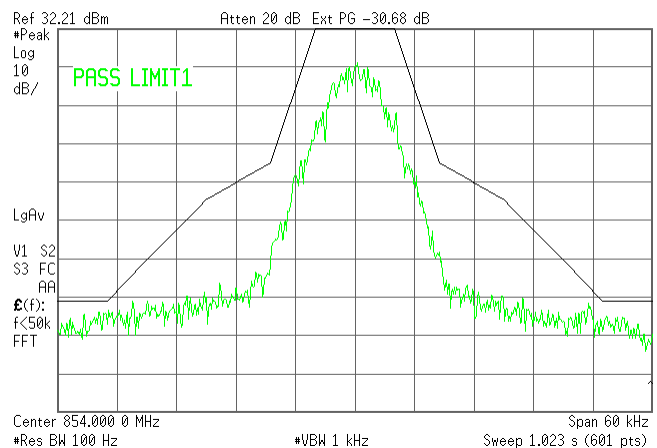



HERMON LABORATORIES

Test specification: Section 90.210(h), Emission mask			
Test procedure: 47 CFR, Sections 2.1051; KDB 935210 D02 v02, Appendix D			
Test mode: Compliance	Verdict: PASS		
Date(s): 31-Aug-14 – 1-Sep-14			
Temperature: 23.2 °C	Air Pressure: 1006 hPa	Relative Humidity: 43 %	Power Supply: 120 VAC
Remarks:			

Plot 7.6.7 Emission mask test result at low frequency carrier, Port 2

FRQUENCY RANGE:
OPERATIONAL MODE:
INPUT PORT:
COMPOSITE INPUT POWER:
EMISSION MASK:
INPUT POWER: -54 dBm

806 - 816 MHz
C4FM uplink transmit
Base
-54 dBm
90.210(H)
INPUT POWER: -24 dBm

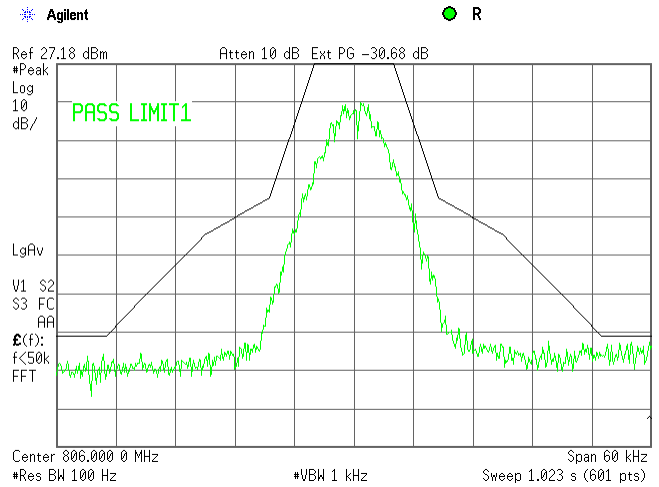
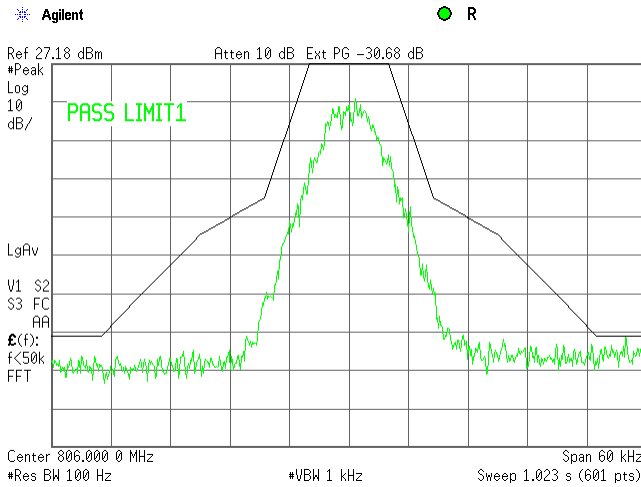

Plot 7.6.8 Emission mask test result at mid frequency carrier, Port 2

FRQUENCY RANGE:
OPERATIONAL MODE:
INPUT PORT:
COMPOSITE INPUT POWER:
EMISSION MASK:
INPUT POWER: -54 dBm

806 - 816 MHz
C4FM uplink transmit
Base
-54 dBm
90.210(H)
INPUT POWER: -24 dBm

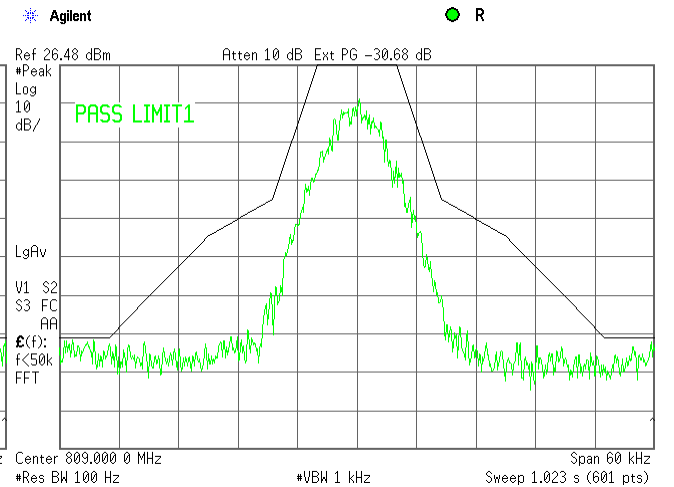
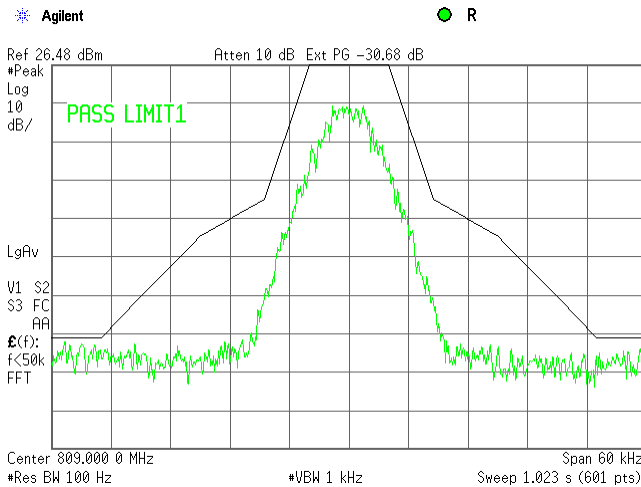



HERMON LABORATORIES

Test specification: Section 90.210(h), Emission mask			
Test procedure: 47 CFR, Sections 2.1051; KDB 935210 D02 v02, Appendix D			
Test mode: Compliance	Verdict: PASS		
Date(s): 31-Aug-14 – 1-Sep-14			
Temperature: 23.2 °C	Air Pressure: 1006 hPa	Relative Humidity: 43 %	Power Supply: 120 VAC
Remarks:			

Plot 7.6.9 Emission mask test result at low frequency carrier, Port 1

FREQUENCY RANGE:
 OPERATIONAL MODE:
 INPUT PORT:
 EMISSION MASK:
 CONFIGURATION:
 INPUT POWER: -54 dBm

851 - 861 MHz
 Analog FM downlink transmit
 Base
 90.210(H)
 Dual Band
 INPUT POWER: -24 dBm

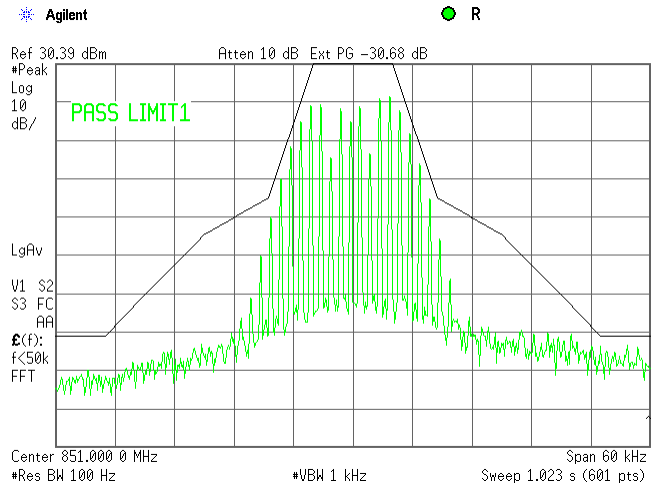
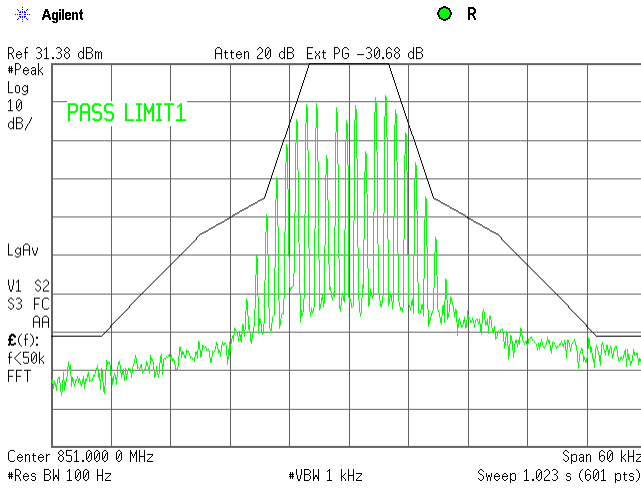

CONFIGURATION:
 COMPOSITE INPUT POWER: -51 dBm

Single Band
 COMPOSITE INPUT POWER: -21 dBm

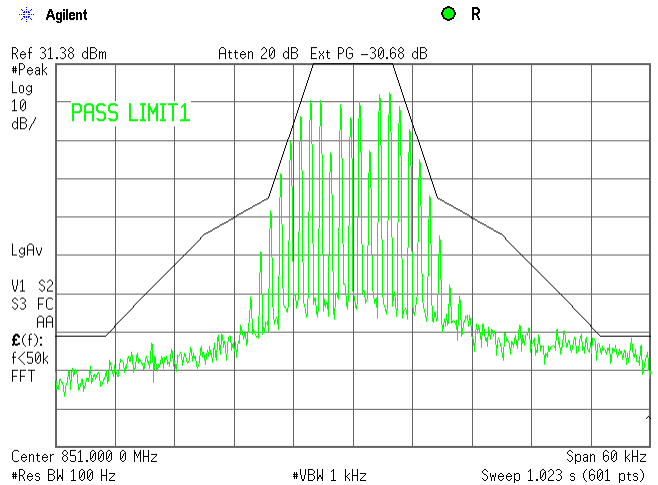
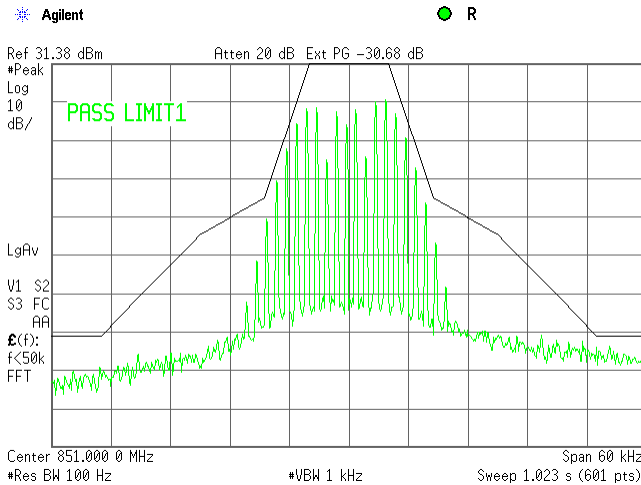



HERMON LABORATORIES

Test specification:		Section 90.210(h), Emission mask	
Test procedure:		47 CFR, Sections 2.1051; KDB 935210 D02 v02, Appendix D	
Test mode:		Compliance	
Date(s):		31-Aug-14 – 1-Sep-14	
Temperature: 23.2 °C		Air Pressure: 1006 hPa	
		Relative Humidity: 43 %	
		Power Supply: 120 VAC	
Remarks:			
		Verdict: PASS	

Plot 7.6.10 Emission mask test result at mid frequency carrier, Port 1

FREQUENCY RANGE:
OPERATIONAL MODE:
INPUT PORT:
EMISSION MASK:
CONFIGURATION:
INPUT POWER: -54 dBm

851 - 861 MHz
Analog FM downlink transmit
Base
90.210(H)
Dual Band
INPUT POWER: -24 dBm

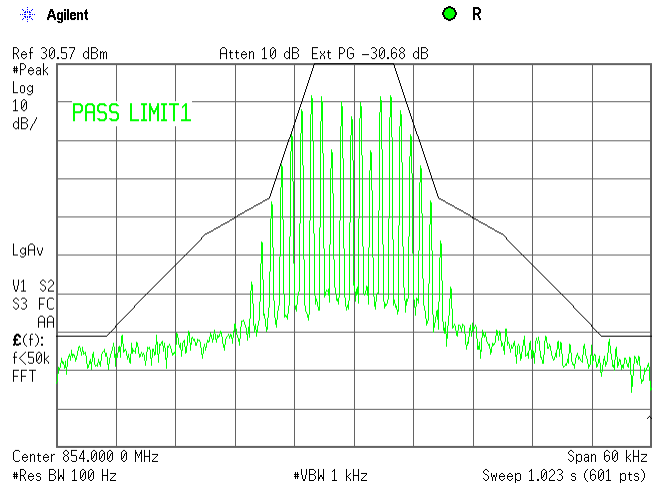
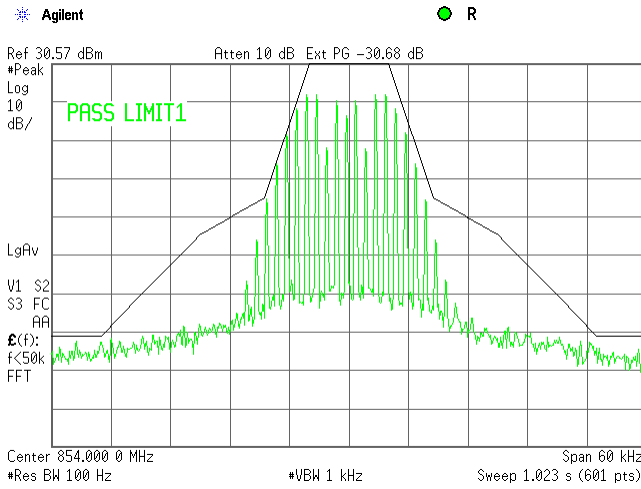

CONFIGURATION:
COMPOSITE INPUT POWER: -51 dBm

Single Band
COMPOSITE INPUT POWER: -21 dBm

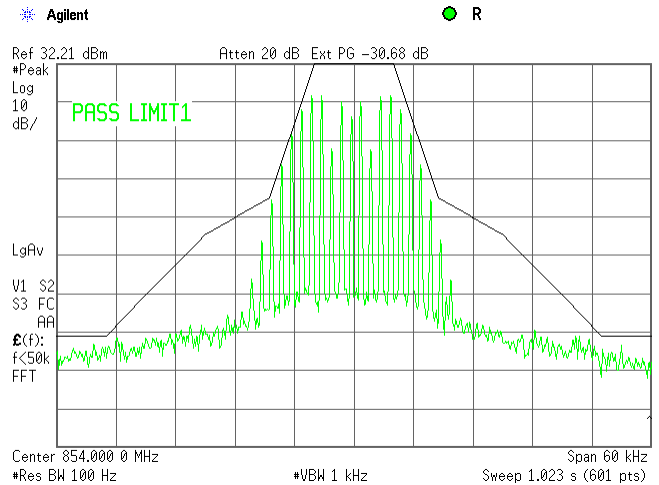
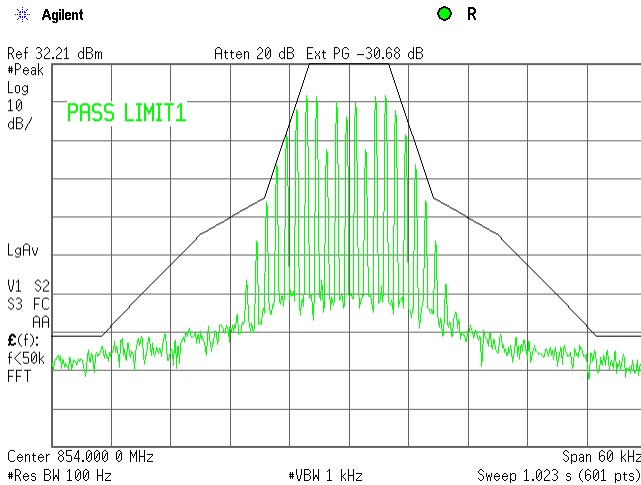



HERMON LABORATORIES

Test specification: Section 90.210(h), Emission mask			
Test procedure: 47 CFR, Sections 2.1051; KDB 935210 D02 v02, Appendix D			
Test mode: Compliance	Verdict: PASS		
Date(s): 31-Aug-14 – 1-Sep-14			
Temperature: 23.2 °C	Air Pressure: 1006 hPa	Relative Humidity: 43 %	Power Supply: 120 VAC
Remarks:			

Plot 7.6.11 Emission mask test result at low frequency carrier, Port 2

FRQUENCY RANGE:
 OPERATIONAL MODE:
 INPUT PORT:
 COMPOSITE INPUT POWER:
 EMISSION MASK:
 INPUT POWER: -54 dBm

806 - 816 MHz
 Analog FM downlink transmit
 Mobile
 -54 dBm
 90.210(B)
 INPUT POWER: -34 dBm

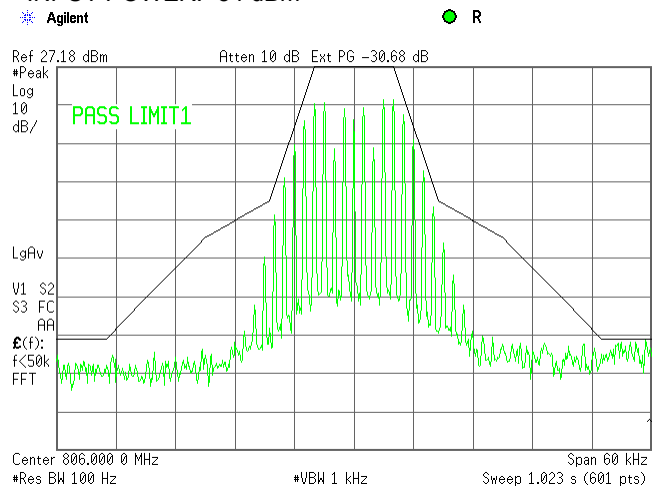
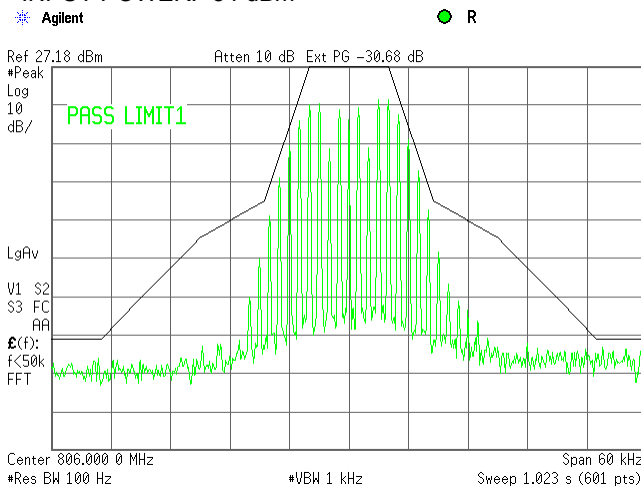

Plot 7.6.12 Emission mask test result at mid frequency carrier, Port 2

FRQUENCY RANGE:
 OPERATIONAL MODE:
 INPUT PORT:
 COMPOSITE INPUT POWER:
 EMISSION MASK:
 INPUT POWER: -54 dBm

806 - 816 MHz
 Analog FM downlink transmit
 Mobile
 -54 dBm
 90.210(B)
 INPUT POWER: -24 dBm

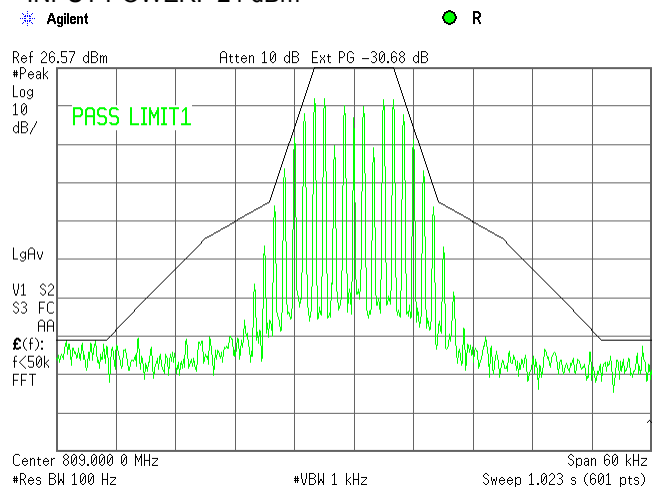
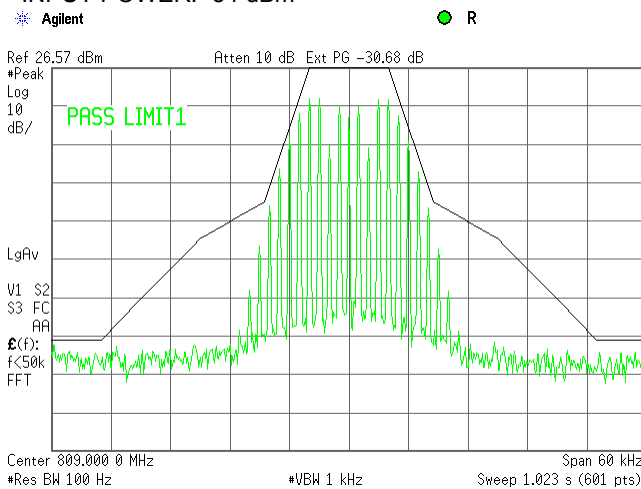



Test specification:	Section 90.219(e)(3), Radiated spurious emissions		
Test procedure:	47 CFR, Sections 2.1053; KDB 935210 D02 v02, Appendix D		
Test mode:	Compliance	Verdict:	PASS
Date(s):	05-Aug-14		
Temperature: 23.3 °C	Air Pressure: 1002 hPa	Relative Humidity: 41 %	Power Supply: 120 VAC
Remarks:			

7.7 Radiated spurious emission measurements

7.7.1 General

This test was performed to measure radiated spurious emissions from the EUT. Specification test limits are given in Table 7.7.1.

Table 7.7.1 Radiated spurious emission test limits

Frequency, MHz	Attenuation below carrier, dBc	ERP of spurious, dBm	Equivalent field strength limit @ 3m, dB(μ V/m) ^{***}
0.009 – 10 th harmonic*	43+10logP ^{**}	-13	84.4

* - Excluding the in band emission within \pm 250 % of the authorized bandwidth from the carrier

** - P is transmitter output power in Watts

*** - Equivalent field strength limit was calculated from maximum allowed ERP of spurious as follows: $E = \sqrt{(30 \times P \times 1.64)} / r$, where P is ERP in Watts, 1.64 is numeric gain of ideal dipole and r is antenna to EUT distance in meters

7.7.2 Test procedure for spurious emission field strength measurements in 9 kHz to 30 MHz band

7.7.2.1 The EUT was set up as shown in Figure 7.7.1, energized and the performance check was conducted.

7.7.2.2 The specified frequency range was investigated with antenna connected to spectrum analyzer. To find maximum radiation the turntable was rotated 360° and the measuring antenna was rotated around its vertical axis.

7.7.2.3 The worst test results (the lowest margins) were recorded in Table 7.7.2 and shown in the associated plots.

7.7.3 Test procedure for spurious emission field strength measurements above 30 MHz

7.7.3.1 The EUT was set up as shown in Figure 7.7.2, energized and the performance check was conducted.

7.7.3.2 The specified frequency range was investigated with antenna connected to spectrum analyzer. To find maximum radiation the turntable was rotated 360° and the measuring antenna height was swept from 1 to 4 m in both, vertical and horizontal, polarizations.

7.7.3.3 The worst test results (the lowest margins) were recorded in Table 7.7.2 and shown in the associated plots.



Test specification:	Section 90.219(e)(3), Radiated spurious emissions		
Test procedure:	47 CFR, Sections 2.1053; KDB 935210 D02 v02, Appendix D		
Test mode:	Compliance	Verdict:	PASS
Date(s):	05-Aug-14		
Temperature: 23.3 °C	Air Pressure: 1002 hPa	Relative Humidity: 41 %	Power Supply: 120 VAC
Remarks:			

7.7.3.4 Figure 7.7.1 Setup for spurious emission field strength measurements in 9 kHz to 30 MHz band

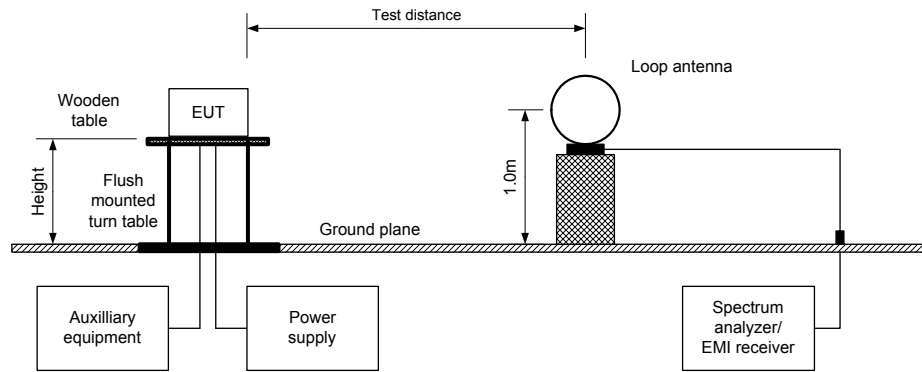
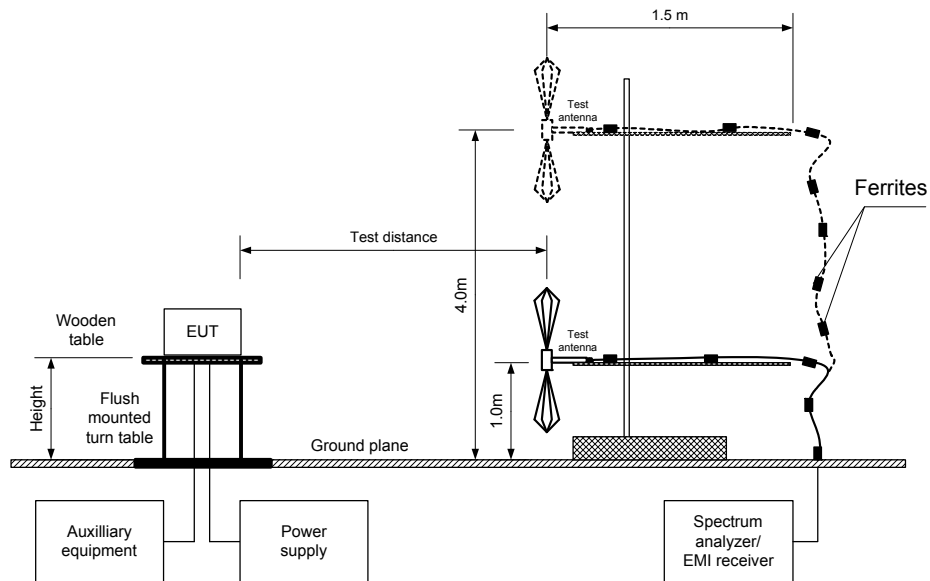

Figure 7.7.2 Setup for spurious emission field strength measurements above 30 MHz





HERMON LABORATORIES

Test specification:	Section 90.219(e)(3), Radiated spurious emissions		
Test procedure:	47 CFR, Sections 2.1053; KDB 935210 D02 v02, Appendix D		
Test mode:	Compliance	Verdict: PASS	
Date(s):	05-Aug-14		
Temperature: 23.3 °C	Air Pressure: 1002 hPa	Relative Humidity: 41 %	Power Supply: 120 VAC
Remarks:			

Table 7.7.2 Spurious emission field strength test results, dual band

ASSIGNED FREQUENCY RANGE: 758 - 775 MHz Downlink
788 - 805 MHz Uplink
851 - 861 MHz Downlink
806 - 816 MHz Uplink

TEST DISTANCE: 3 m

TEST SITE: Semi anechoic chamber

EUT HEIGHT: 0.8 m

INVESTIGATED FREQUENCY RANGE: 0.009 - 9000 MHz

DETECTOR USED: Peak

VIDEO BANDWIDTH: > Resolution bandwidth

TEST ANTENNA TYPE: Active loop (9 kHz - 30 MHz)
Biconilog (30 MHz - 1000 MHz)
Double ridged guide (above 1000 MHz)

MODULATION: Unmodulated

CONFIGURATION: Dual Band

BOOSTER OUTPUT POWER SETTINGS: 30 dBm

Frequency, MHz	SA reading, dBm	Attenuator, dB	Cable loss, dB	RBW, kHz	Spurious emission, dBm	Attenuation below carrier, dBc	Limit, dBc	Margin, dB*	Verdict
Low carrier frequency									
All emissions were found more than 20 dB below the limit									Pass
Mid carrier frequency									
All emissions were found more than 20 dB below the limit									Pass
High carrier frequency									
All emissions were found more than 20 dB below the limit									Pass

*- Margin = Field strength of spurious - calculated field strength limit.
**- EUT front panel refers to 0 degrees position of turntable.



Test specification:	Section 90.219(e)(3), Radiated spurious emissions		
Test procedure:	47 CFR, Sections 2.1053; KDB 935210 D02 v02, Appendix D		
Test mode:	Compliance	Verdict: PASS	
Date(s):	05-Aug-14		
Temperature: 23.3 °C	Air Pressure: 1002 hPa	Relative Humidity: 41 %	Power Supply: 120 VAC
Remarks:			

Table 7.7.3 Spurious emission field strength test results, single band

ASSIGNED FREQUENCY RANGES: 758 - 775 MHz Downlink
788 – 805 MHz Uplink
INVESTIGATED FREQUENCY RANGE: 0.009 – 8000 MHz
MODULATION: Unmodulated
CONFIGURATION: Single Band
DOWNLINK OUTPUT POWER SETTINGS: 33 dBm

Frequency, MHz	Field strength, dB(μ V/m)	Limit, dB(μ V/m)	Margin, dB*	RBW, kHz	Antenna polarization	Antenna height, m	Turn-table position**, degrees	Verdict
Low carrier frequency MHz								
All emissions were found more than 20 dB below the limit								Pass
Mid carrier frequency MHz								
All emissions were found more than 20 dB below the limit								Pass
High carrier frequency MHz								
889.902	63.94	84.4	-20.46	120	Vert	1.2	28	Pass

*- Margin = Spurious emission – specification limit.

ASSIGNED FREQUENCY RANGES: 851 – 861 MHz Downlink
806 – 816 MHz Uplink
INVESTIGATED FREQUENCY RANGE: 0.009 – 9000 MHz
MODULATION: Unmodulated
CONFIGURATION: Single Band
DOWNLINK OUTPUT POWER SETTINGS: 33 dBm

Frequency, MHz	SA reading, dBm	Attenuator, dB	Cable loss, dB	RBW, kHz	Spurious emission, dBm	Attenuation below carrier, dBc	Limit, dBc	Margin, dB*	Verdict
Low carrier frequency									
All emissions were found more than 20 dB below the limit									Pass
Mid carrier frequency									
All emissions were found more than 20 dB below the limit									Pass
High carrier frequency									
All emissions were found more than 20 dB below the limit									Pass

*- Margin = Spurious emission – specification limit.

Reference numbers of test equipment used

HL 0446	HL 0521	HL 0604	HL 1984	HL 2871	HL 2909	HL 4150	HL 4353
---------	---------	---------	---------	---------	---------	---------	---------

Full description is given in Appendix A.



HERMON LABORATORIES

Test specification: Section 90.219(e)(3), Radiated spurious emissions			
Test procedure: 47 CFR, Sections 2.1053; KDB 935210 D02 v02, Appendix D			
Test mode: Compliance	Verdict: PASS		
Date(s): 05-Aug-14			
Temperature: 23.3 °C	Air Pressure: 1002 hPa	Relative Humidity: 41 %	Power Supply: 120 VAC
Remarks:			

Plot 7.7.1 Radiated emission measurements in 9 - 150 kHz range

TEST SITE:
CONFIGURATION:

Semi anechoic chamber
Single Band Downlink 758 – 775 MHz
Uplink 788 – 805 MHz

ANTENNA POLARIZATION:
TEST DISTANCE:
CARRIER FREQUENCY: Low

Vertical and Horizontal
3 m
CARRIER FREQUENCY: Mid

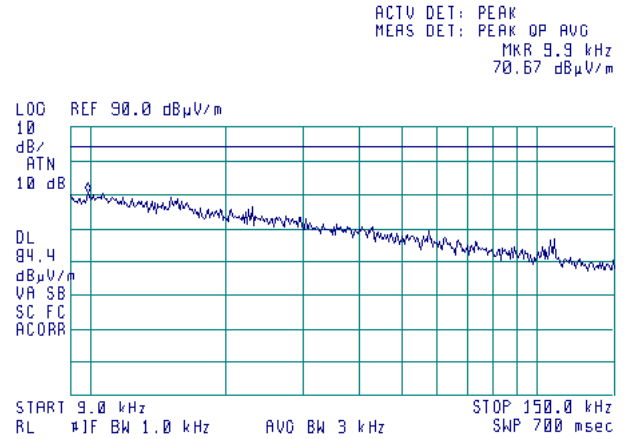
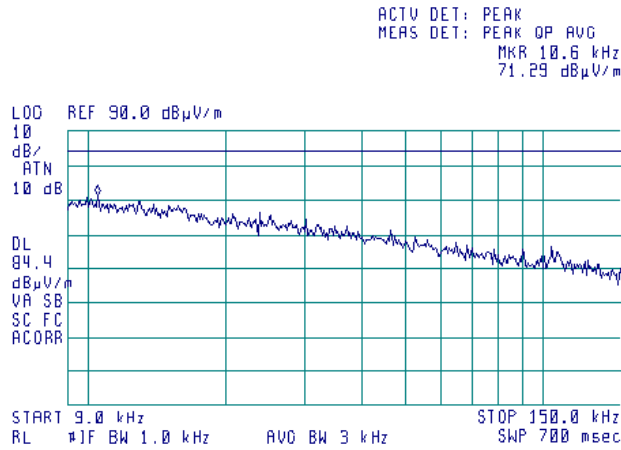

CARRIER FREQUENCY: High



ACTV DET: PEAK
MEAS DET: PEAK OP AVG
MKR 10.2 kHz
71.75 dBµV/m

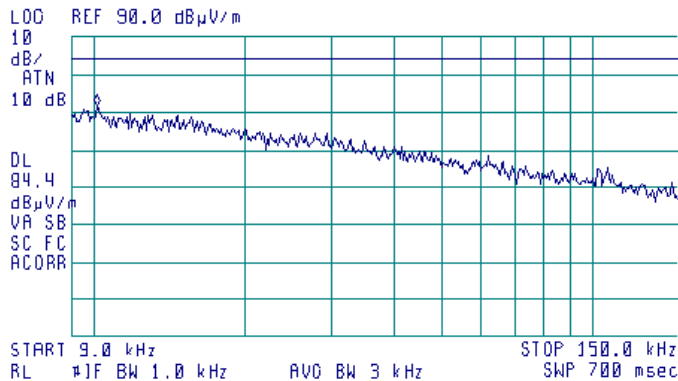



HERMON LABORATORIES

Test specification:	Section 90.219(e)(3), Radiated spurious emissions		
Test procedure:	47 CFR, Sections 2.1053; KDB 935210 D02 v02, Appendix D		
Test mode:	Compliance	Verdict:	PASS
Date(s):	05-Aug-14		
Temperature: 23.3 °C	Air Pressure: 1002 hPa	Relative Humidity: 41 %	Power Supply: 120 VAC
Remarks:			

Plot 7.7.2 Radiated emission measurements in 0.15 - 30 MHz range

TEST SITE:
CONFIGURATION:

ANTENNA POLARIZATION:
TEST DISTANCE:
CARRIER FREQUENCY: Low

Semi anechoic chamber
Single Band Downlink 758 – 775 MHz
Uplink 788 – 805 MHz
Vertical and Horizontal
3 m
CARRIER FREQUENCY: Mid

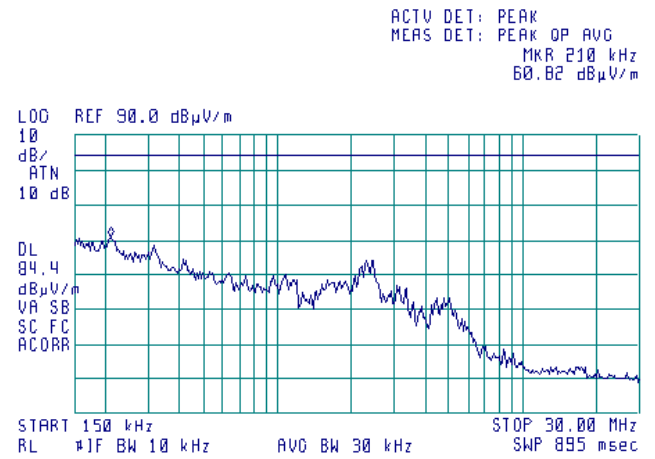
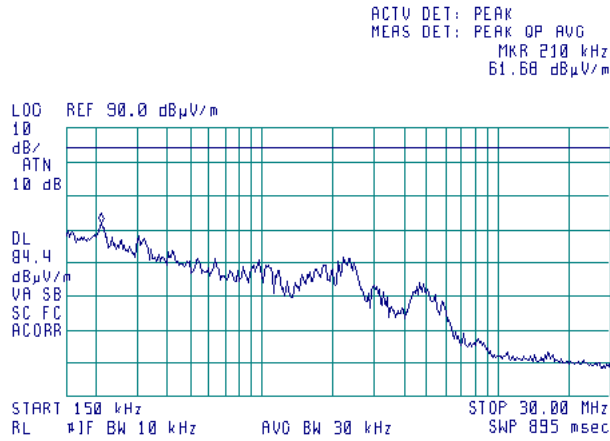

CARRIER FREQUENCY: High



ACTV DET: PEAK
MEAS DET: PEAK OP AVG
MKR 210 kHz
60.73 dBµV/m

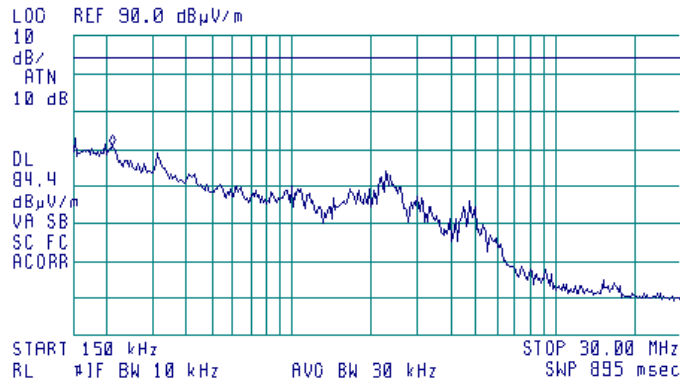



HERMON LABORATORIES

Test specification: Section 90.219(e)(3), Radiated spurious emissions			
Test procedure: 47 CFR, Sections 2.1053; KDB 935210 D02 v02, Appendix D			
Test mode: Compliance	Verdict: PASS		
Date(s): 05-Aug-14			
Temperature: 23.3 °C	Air Pressure: 1002 hPa	Relative Humidity: 41 %	Power Supply: 120 VAC
Remarks:			

Plot 7.7.3 Radiated emission measurements in 30 - 1000 MHz range

TEST SITE:
CONFIGURATION:

Semi anechoic chamber
Single Band Downlink 758 – 775 MHz
Uplink 788 – 805 MHz

ANTENNA POLARIZATION:
TEST DISTANCE:
CARRIER FREQUENCY: Low

Vertical and Horizontal
3 m
CARRIER FREQUENCY: Mid

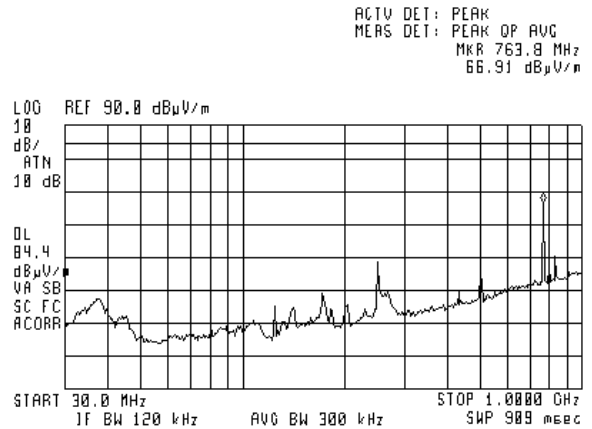
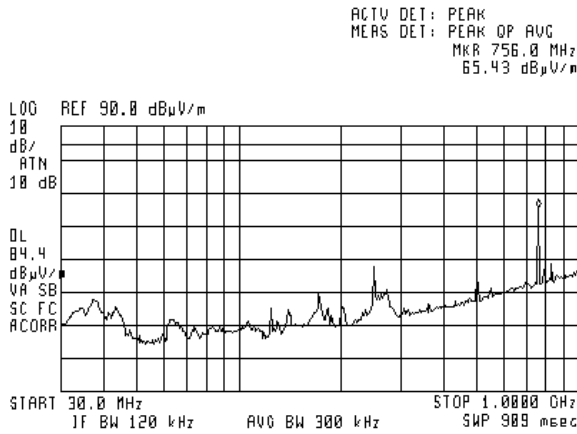

CARRIER FREQUENCY: High



ACTV DET: PEAK
MERS DET: PEAK OP AVG
MKR 771.6 MHz
69.94 dB μ V/m

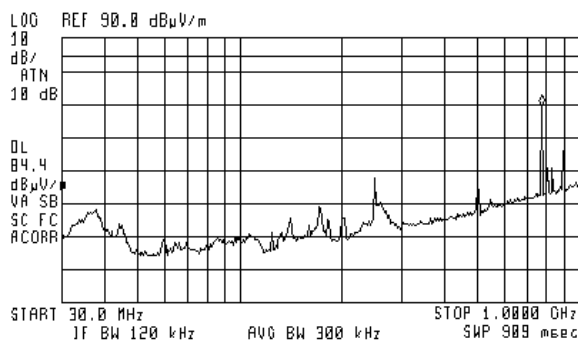



HERMON LABORATORIES

Test specification:	Section 90.219(e)(3), Radiated spurious emissions		
Test procedure:	47 CFR, Sections 2.1053; KDB 935210 D02 v02, Appendix D		
Test mode:	Compliance	Verdict: PASS	
Date(s):	05-Aug-14		
Temperature: 23.3 °C	Air Pressure: 1002 hPa	Relative Humidity: 41 %	Power Supply: 120 VAC
Remarks:			

Plot 7.7.4 Radiated emission measurements in 1000 – 6000 MHz range at low carrier frequency

TEST SITE: Semi anechoic chamber
CONFIGURATION: Single Band Downlink 758 – 775 MHz
Uplink 788 – 805 MHz
ANTENNA POLARIZATION: Vertical and Horizontal
TEST DISTANCE: 3 m

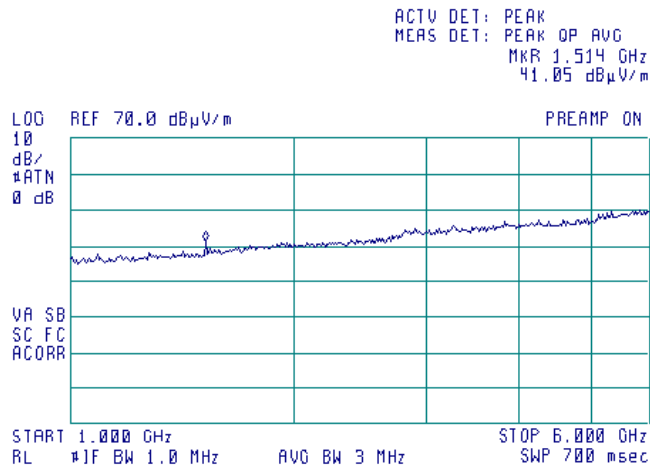

Limit 84.4 dBuV/m was applied

Plot 7.7.5 Radiated emission measurements in 1000 – 6000 MHz range at mid carrier frequency

TEST SITE: Semi anechoic chamber
CONFIGURATION: Single Band Downlink 758 – 775 MHz
Uplink 788 – 805 MHz
ANTENNA POLARIZATION: Vertical and Horizontal
TEST DISTANCE: 3 m

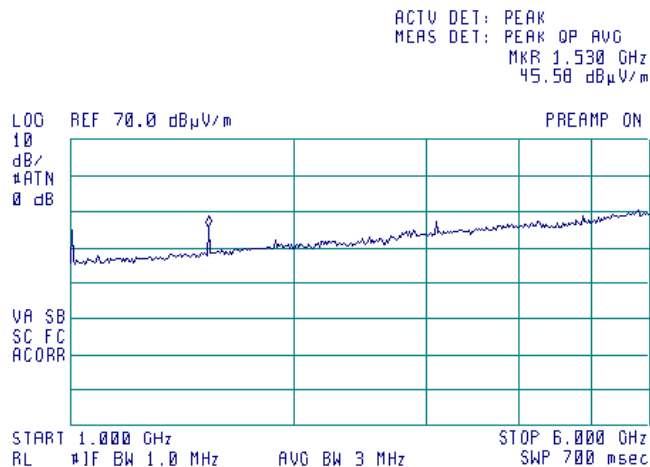

Limit 84.4 dBuV/m was applied



HERMON LABORATORIES

Test specification: Section 90.219(e)(3), Radiated spurious emissions			
Test procedure: 47 CFR, Sections 2.1053; KDB 935210 D02 v02, Appendix D			
Test mode: Compliance	Verdict: PASS		
Date(s): 05-Aug-14			
Temperature: 23.3 °C	Air Pressure: 1002 hPa	Relative Humidity: 41 %	Power Supply: 120 VAC
Remarks:			

Plot 7.7.6 Radiated emission measurements in 1000 – 6000 MHz range at high carrier frequency

TEST SITE: Semi anechoic chamber
CONFIGURATION: Single Band Downlink 758 – 775 MHz
Uplink 788 – 805 MHz
ANTENNA POLARIZATION: Vertical and Horizontal
TEST DISTANCE: 3 m

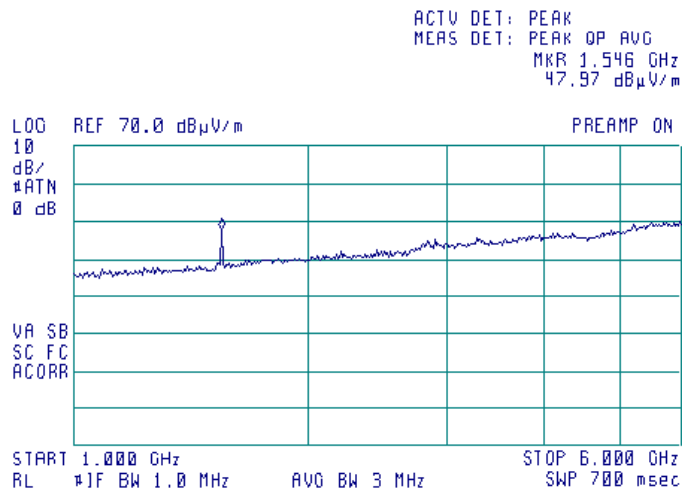

Limit 84.4 dBuV/m was applied



HERMON LABORATORIES

Test specification: Section 90.219(e)(3), Radiated spurious emissions			
Test procedure: 47 CFR, Sections 2.1053; KDB 935210 D02 v02, Appendix D			
Test mode: Compliance	Verdict: PASS		
Date(s): 05-Aug-14			
Temperature: 23.3 °C	Air Pressure: 1002 hPa	Relative Humidity: 41 %	Power Supply: 120 VAC
Remarks:			

Plot 7.7.7 Radiated emission measurements in 6000 – 9000 MHz range at low carrier frequency

TEST SITE: Semi anechoic chamber
CONFIGURATION: Single Band Downlink 758 – 775 MHz
Uplink 788 – 805 MHz
ANTENNA POLARIZATION: Vertical and Horizontal
TEST DISTANCE: 3 m

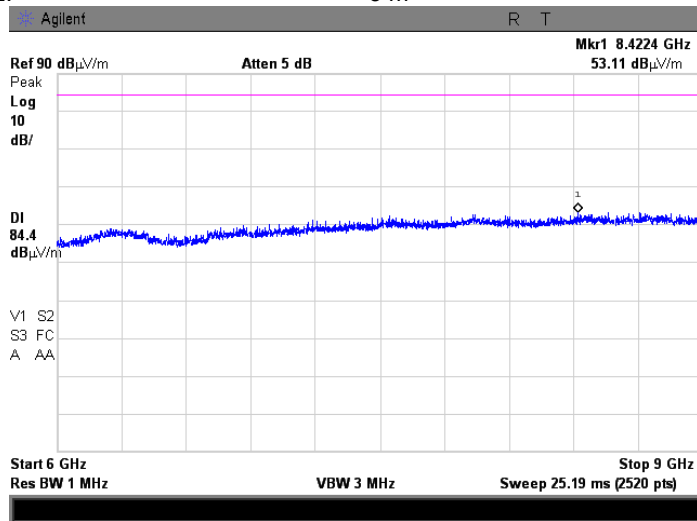

Plot 7.7.8 Radiated emission measurements in 6000 – 9000 MHz range at mid carrier frequency

TEST SITE: Semi anechoic chamber
CONFIGURATION: Single Band Downlink 758 – 775 MHz
Uplink 788 – 805 MHz
ANTENNA POLARIZATION: Vertical and Horizontal
TEST DISTANCE: 3 m

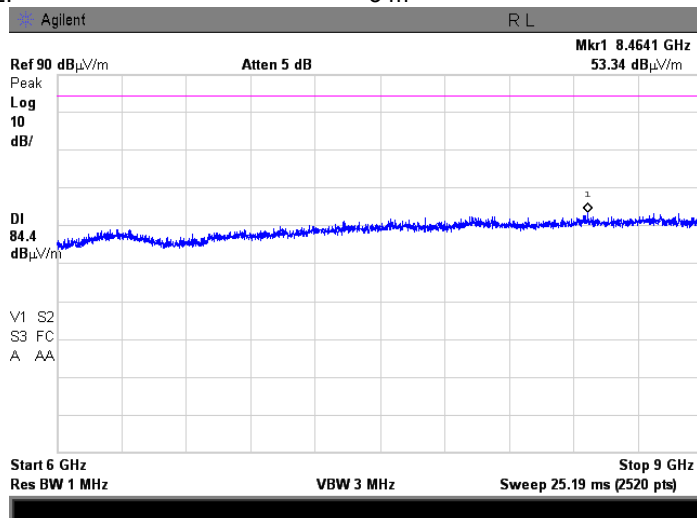



HERMON LABORATORIES

Test specification:	Section 90.219(e)(3), Radiated spurious emissions		
Test procedure:	47 CFR, Sections 2.1053; KDB 935210 D02 v02, Appendix D		
Test mode:	Compliance	Verdict: PASS	
Date(s):	05-Aug-14		
Temperature: 23.3 °C	Air Pressure: 1002 hPa	Relative Humidity: 41 %	Power Supply: 120 VAC
Remarks:			

Plot 7.7.9 Radiated emission measurements in 6000 – 9000 MHz range at high carrier frequency

TEST SITE: Semi anechoic chamber
 CONFIGURATION: Single Band Downlink 758 – 775 MHz
 Uplink 788 – 805 MHz
 ANTENNA POLARIZATION: Vertical and Horizontal
 TEST DISTANCE: 3 m

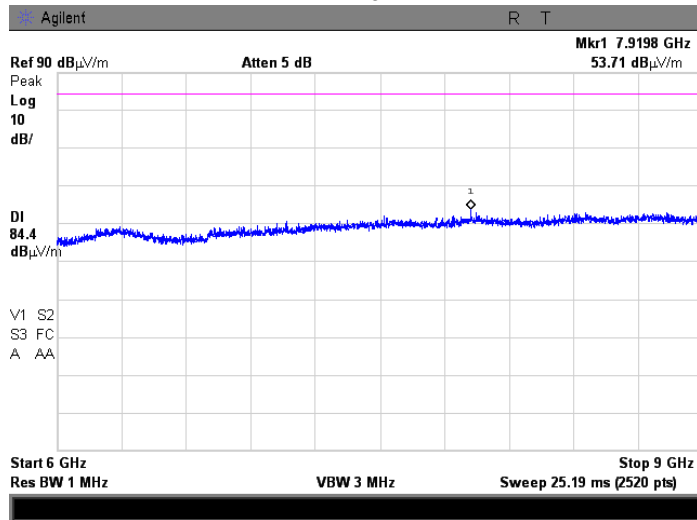



HERMON LABORATORIES

Test specification: Section 90.219(e)(3), Radiated spurious emissions			
Test procedure: 47 CFR, Sections 2.1053; KDB 935210 D02 v02, Appendix D			
Test mode: Compliance	Verdict: PASS		
Date(s): 05-Aug-14			
Temperature: 23.3 °C	Air Pressure: 1002 hPa	Relative Humidity: 41 %	Power Supply: 120 VAC
Remarks:			

Plot 7.7.10 Radiated emission measurements in 9 - 150 kHz range

TEST SITE:
CONFIGURATION:

Semi anechoic chamber
Single Band Downlink 851-861MHz
Uplink 806 – 816 MHz

ANTENNA POLARIZATION:
TEST DISTANCE:
CARRIER FREQUENCY: Low

Vertical and Horizontal
3 m
CARRIER FREQUENCY: Mid

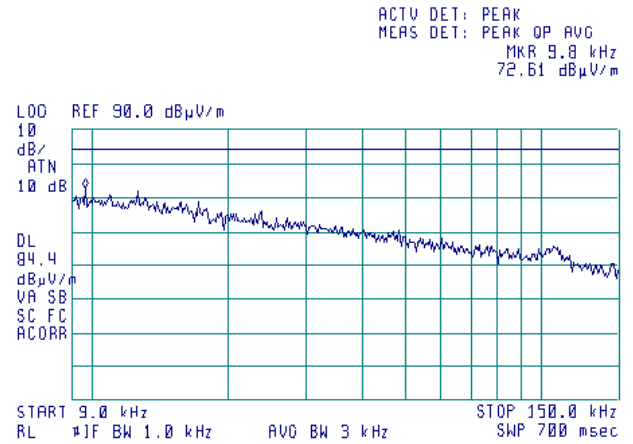
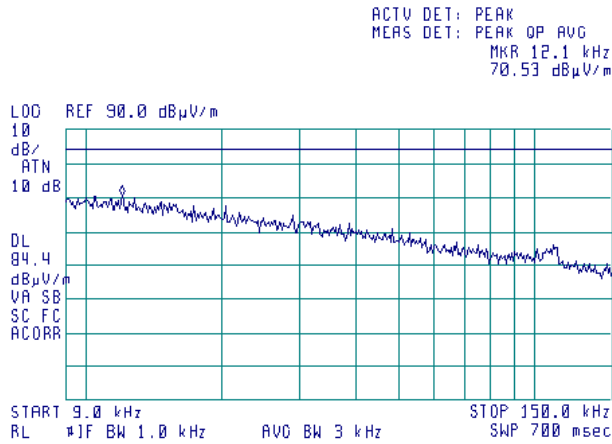

CARRIER FREQUENCY: High



ACTV DET: PEAK
MEAS DET: PEAK OP AVG
MKR 11.3 kHz
71.99 dBµV/m

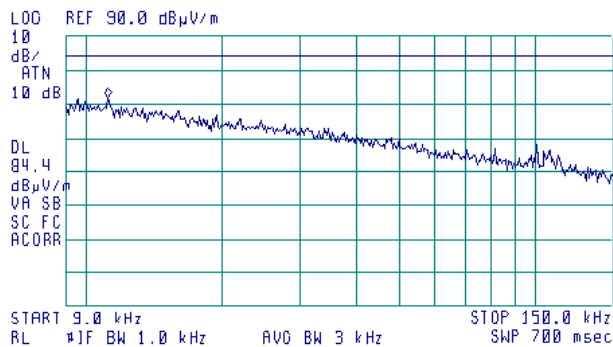



HERMON LABORATORIES

Test specification: Section 90.219(e)(3), Radiated spurious emissions			
Test procedure: 47 CFR, Sections 2.1053; KDB 935210 D02 v02, Appendix D			
Test mode: Compliance	Verdict: PASS		
Date(s): 05-Aug-14			
Temperature: 23.3 °C	Air Pressure: 1002 hPa	Relative Humidity: 41 %	Power Supply: 120 VAC
Remarks:			

Plot 7.7.11 Radiated emission measurements in 0.15 - 30 MHz range

TEST SITE:
CONFIGURATION:

ANTENNA POLARIZATION:
TEST DISTANCE:
CARRIER FREQUENCY: Low

Semi anechoic chamber
Single Band Downlink 851-861MHz
Uplink 806 – 816 MHz
Vertical and Horizontal
3 m
CARRIER FREQUENCY: Mid

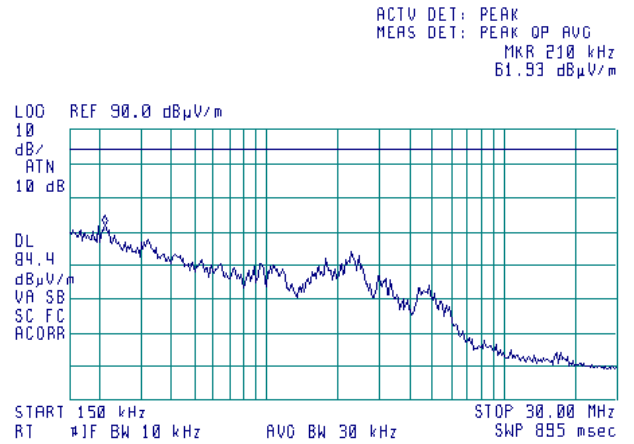
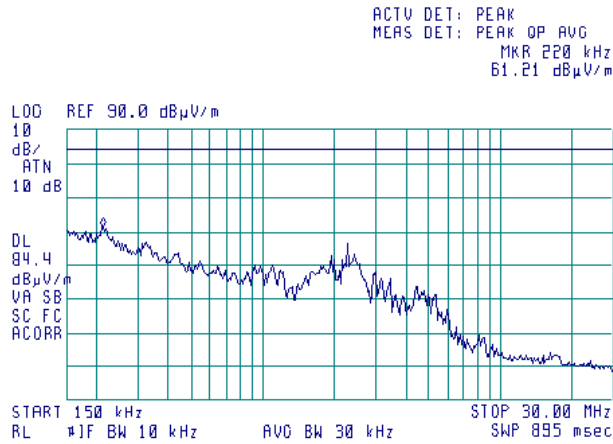

CARRIER FREQUENCY: High

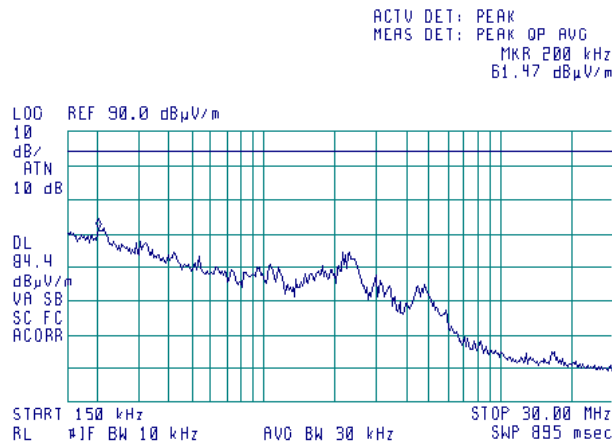



HERMON LABORATORIES

Test specification:	Section 90.219(e)(3), Radiated spurious emissions		
Test procedure:	47 CFR, Sections 2.1053; KDB 935210 D02 v02, Appendix D		
Test mode:	Compliance	Verdict: PASS	
Date(s):	05-Aug-14		
Temperature: 23.3 °C	Air Pressure: 1002 hPa	Relative Humidity: 41 %	Power Supply: 120 VAC
Remarks:			

Plot 7.7.12 Radiated emission measurements in 30 - 1000 MHz range

TEST SITE:
CONFIGURATION:

ANTENNA POLARIZATION:
TEST DISTANCE:
CARRIER FREQUENCY: Low

Semi anechoic chamber
Single Band Downlink 851 - 861 MHz
UpLink 806 - 816 MHz
Vertical and Horizontal
3 m
CARRIER FREQUENCY: Mid

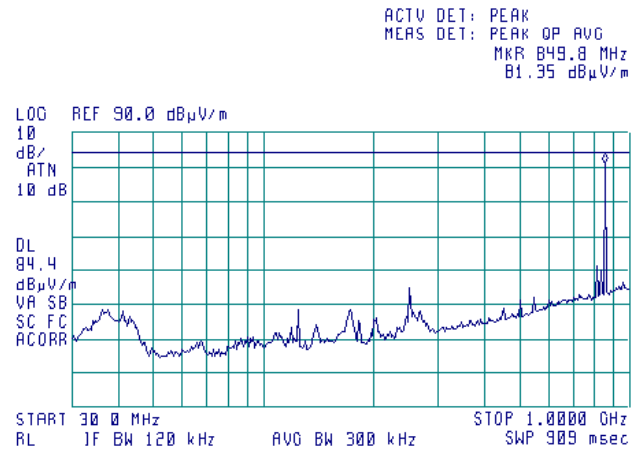
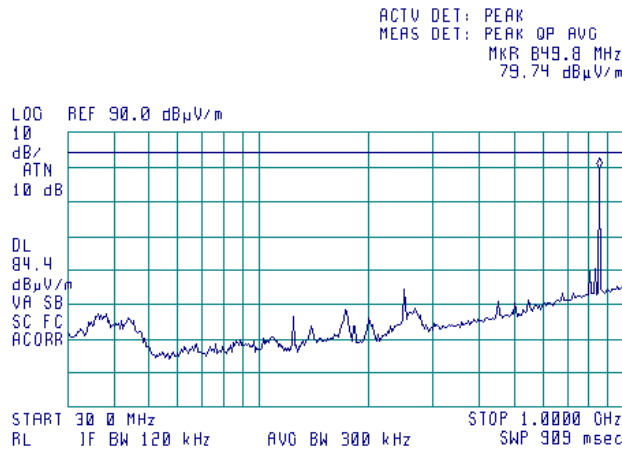

CARRIER FREQUENCY: High

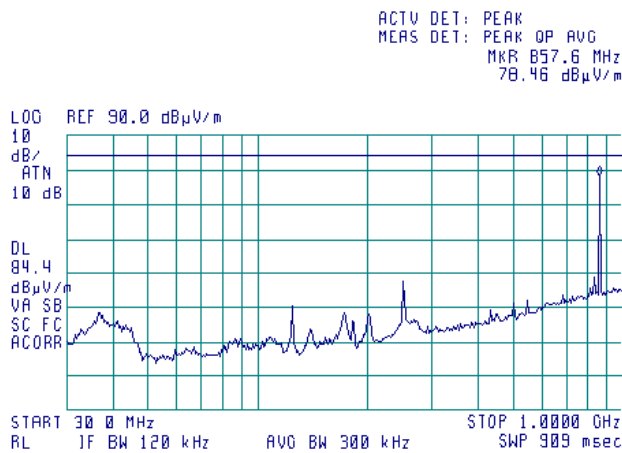



HERMON LABORATORIES

Test specification:	Section 90.219(e)(3), Radiated spurious emissions		
Test procedure:	47 CFR, Sections 2.1053; KDB 935210 D02 v02, Appendix D		
Test mode:	Compliance	Verdict: PASS	
Date(s):	05-Aug-14		
Temperature: 23.3 °C	Air Pressure: 1002 hPa	Relative Humidity: 41 %	Power Supply: 120 VAC
Remarks:			

Plot 7.7.13 Radiated emission measurements in 1000 – 6000 MHz range at low carrier frequency@3 m distance

TEST SITE: Semi anechoic chamber
 CONFIGURATION: Single Band Downlink 851-861MHz
 Uplink 806 – 816 MHz
 ANTENNA POLARIZATION: Vertical and Horizontal

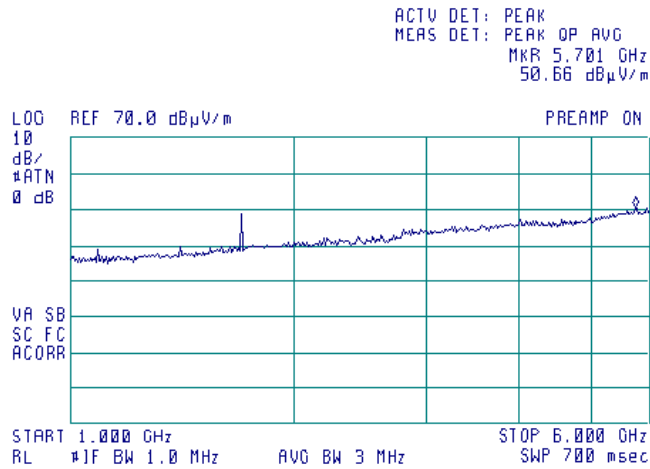

Limit 84.4 dBuV/m was applied

Plot 7.7.14 Radiated emission measurements in 1000 – 6000 MHz range at mid carrier frequency @3 m distance

TEST SITE: Semi anechoic chamber
 CONFIGURATION: Single Band Downlink 851-861MHz
 Uplink 806 – 816 MHz
 ANTENNA POLARIZATION: Vertical and Horizontal

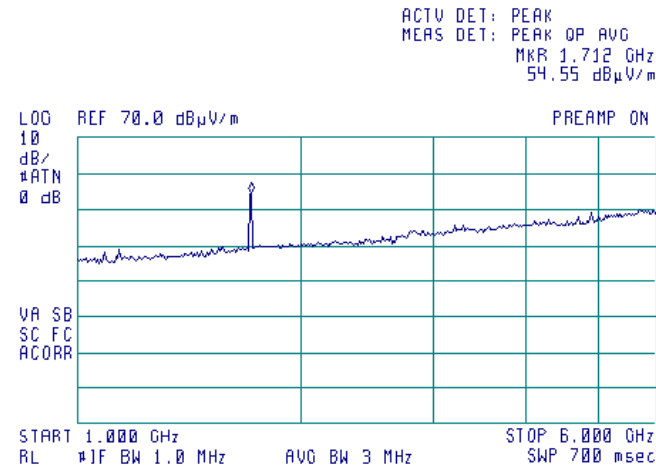

5

Limit 84.4 dBuV/m was applied



HERMON LABORATORIES

Test specification:	Section 90.219(e)(3), Radiated spurious emissions		
Test procedure:	47 CFR, Sections 2.1053; KDB 935210 D02 v02, Appendix D		
Test mode:	Compliance	Verdict: PASS	
Date(s):	05-Aug-14		
Temperature: 23.3 °C	Air Pressure: 1002 hPa	Relative Humidity: 41 %	Power Supply: 120 VAC
Remarks:			

Plot 7.7.15 Radiated emission measurements in 1000 – 6000 MHz range at high carrier frequency

TEST SITE: Semi anechoic chamber
 CONFIGURATION: Single Band Downlink 851-861MHz
 Uplink 806 – 816 MHz
 ANTENNA POLARIZATION: Vertical and Horizontal
 TEST DISTANCE: 3 m

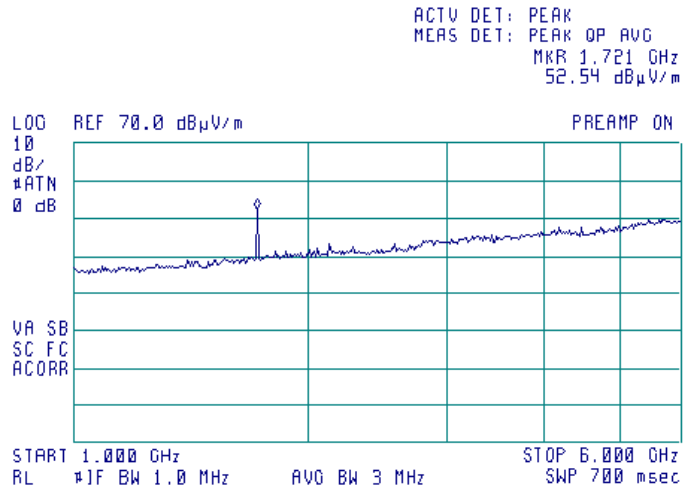

Limit 84.4 dBuV/m was applied



HERMON LABORATORIES

Test specification: Section 90.219(e)(3), Radiated spurious emissions			
Test procedure: 47 CFR, Sections 2.1053; KDB 935210 D02 v02, Appendix D			
Test mode: Compliance	Verdict: PASS		
Date(s): 05-Aug-14			
Temperature: 23.3 °C	Air Pressure: 1002 hPa	Relative Humidity: 41 %	Power Supply: 120 VAC
Remarks:			

Plot 7.7.16 Radiated emission measurements in 6000 – 9000 MHz range at low carrier frequency

TEST SITE: Semi anechoic chamber
CONFIGURATION: Single Band Downlink 851-861MHz
Uplink 806 – 816 MHz
ANTENNA POLARIZATION: Vertical and Horizontal
TEST DISTANCE: 3 m

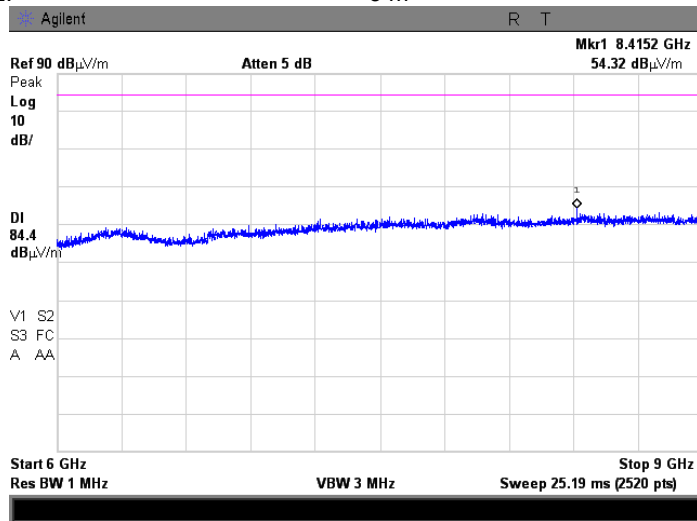

Plot 7.7.17 Radiated emission measurements in 6000 – 9000 MHz range at mid carrier frequency

TEST SITE: Semi anechoic chamber
CONFIGURATION: Single Band Downlink 851-861MHz
Uplink 806 – 816 MHz
ANTENNA POLARIZATION: Vertical and Horizontal
TEST DISTANCE: 3 m

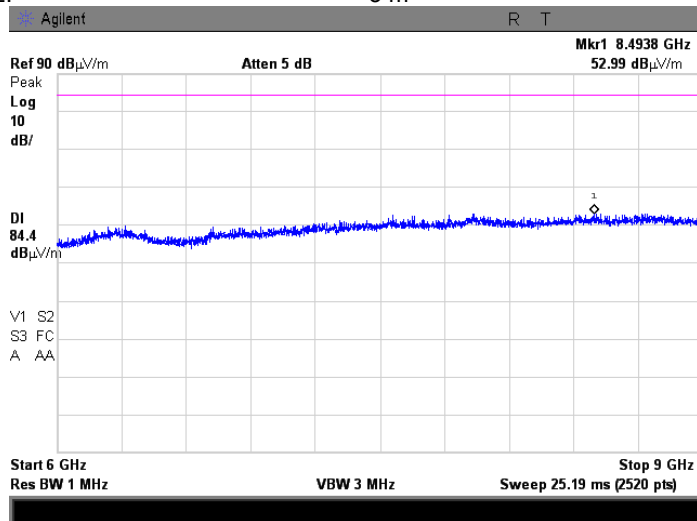



HERMON LABORATORIES

Test specification:	Section 90.219(e)(3), Radiated spurious emissions		
Test procedure:	47 CFR, Sections 2.1053; KDB 935210 D02 v02, Appendix D		
Test mode:	Compliance	Verdict: PASS	
Date(s):	05-Aug-14		
Temperature: 23.3 °C	Air Pressure: 1002 hPa	Relative Humidity: 41 %	Power Supply: 120 VAC
Remarks:			

Plot 7.7.18 Radiated emission measurements in 6000 – 9000 MHz range at high carrier frequency

TEST SITE: Semi anechoic chamber
 CONFIGURATION: Single Band Downlink 851-861MHz
 Uplink 806 – 816 MHz
 ANTENNA POLARIZATION: Vertical and Horizontal
 TEST DISTANCE: 3 m

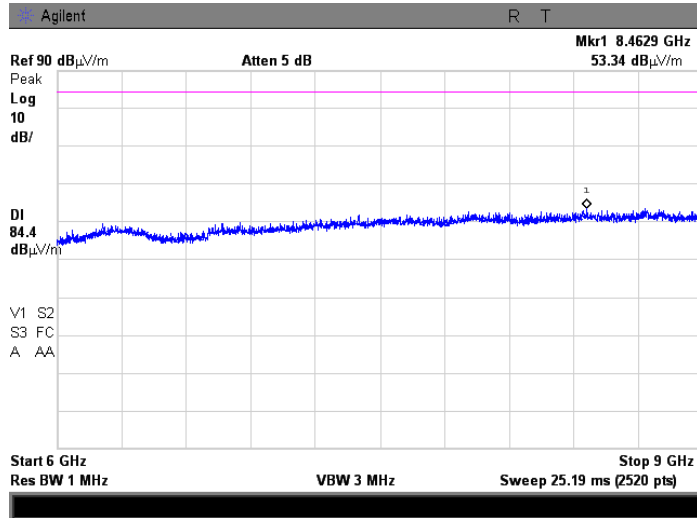

Test specification:		Section 90.219(e)(3), Conducted spurious emissions	
Test procedure:		47 CFR, Sections 2.1051; KDB 935210 D02 v02, Appendix D	
Test mode:		Verdict:	
Compliance		PASS	
Date(s):		06-Aug-14 - 10-Aug-14	
Temperature: 23.2 °C	Air Pressure: 1008 hPa	Relative Humidity: 46 %	Power Supply: 120 VAC
Remarks:			

7.8 Spurious emissions at RF antenna connector test

7.8.1 General

This test was performed to measure spurious emissions at RF antenna connector. Specification test limits are given in Table 7.8.1.

Table 7.8.1 Spurious emission limits

Frequency, MHz	Attenuation below carrier, dBc	ERP of spurious, dBm
0.009 – 10th harmonic*	43+10logP** (mask B)	-13.0

* - spurious emission limits do not apply to the in band emission within $\pm 250\%$ of the authorized bandwidth from the carrier; investigated in course of emission mask testing

** - P is transmitter output power in Watts

7.8.2 Test procedure

7.8.2.1 The EUT was set up as shown in Figure 7.8.1, energized and its proper operation was checked.

7.8.2.2 The EUT was adjusted to produce maximum available for end user RF output power.

7.8.2.3 The spurious emission was measured with spectrum analyzer as provided in Table 7.8.2, Table 7.8.3 and the associated plots.

Figure 7.8.1 Spurious emission test setup

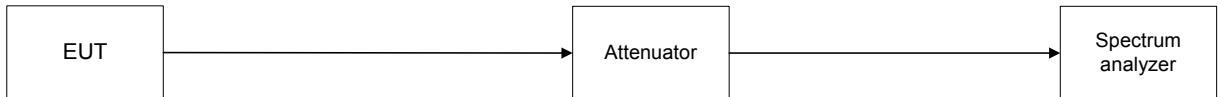



Test specification:	Section 90.219(e)(3), Conducted spurious emissions		
Test procedure:	47 CFR, Sections 2.1051; KDB 935210 D02 v02, Appendix D		
Test mode:	Compliance	Verdict: PASS	
Date(s):	06-Aug-14 - 10-Aug-14		
Temperature: 23.2 °C	Air Pressure: 1008 hPa	Relative Humidity: 46 %	Power Supply: 120 VAC
Remarks:			

Table 7.8.2 Spurious emission test results, single band

ASSIGNED FREQUENCY RANGES: 758 - 775 MHz Downlink
 INVESTIGATED FREQUENCY RANGE: 0.009 – 8000 MHz
 DETECTOR USED: Peak
 VIDEO BANDWIDTH: ≥ Resolution bandwidth
 MODULATION: C4FM/iDEN/Analog FM
 CONFIGURATION: Single band
 BOOSTER OUTPUT POWER SETTINGS: 33 dBm

Frequency, MHz	SA reading, dBm	Attenuator, dB	Cable loss, dB	RBW, kHz	Spurious emission, dBm	Attenuation below carrier, dBc	Limit, dBc	Margin, dB*	Verdict
Low carrier frequency									
All emissions were found more than 20 dB below the limit									Pass
Mid carrier frequency									
All emissions were found more than 20 dB below the limit									Pass
High carrier frequency									
All emissions were found more than 20 dB below the limit									Pass

*- Margin = Spurious emission – specification limit.

ASSIGNED FREQUENCY RANGES: 778 – 805 MHz Uplink
 INVESTIGATED FREQUENCY RANGE: 0.009 – 8200 MHz
 DETECTOR USED: Peak
 VIDEO BANDWIDTH: ≥ Resolution bandwidth
 MODULATION: C4FM/iDEN/Analog FM
 CONFIGURATION: Single band
 BOOSTER OUTPUT POWER SETTINGS: 27 dBm

Frequency, MHz	SA reading, dBm	Attenuator, dB	Cable loss, dB	RBW, kHz	Spurious emission, dBm	Attenuation below carrier, dBc	Limit, dBc	Margin, dB*	Verdict
Low carrier frequency									
All emissions were found more than 20 dB below the limit									Pass
Mid carrier frequency									
All emissions were found more than 20 dB below the limit									Pass
High carrier frequency									
All emissions were found more than 20 dB below the limit									Pass

*- Margin = Spurious emission – specification limit.



Test specification:		Section 90.219(e)(3), Conducted spurious emissions	
Test procedure:		47 CFR, Sections 2.1051; KDB 935210 D02 v02, Appendix D	
Test mode:		Compliance	
Date(s):		06-Aug-14 - 10-Aug-14	
Temperature: 23.2 °C		Air Pressure: 1008 hPa	
		Relative Humidity: 46 %	
		Power Supply: 120 VAC	
Remarks:			

Table 7.8.3 Spurious emission test results, single band

ASSIGNED FREQUENCY RANGES: 851 – 861 MHz Downlink
 INVESTIGATED FREQUENCY RANGE: 0.009 – 9000 MHz
 DETECTOR USED: Peak
 VIDEO BANDWIDTH: ≥ Resolution bandwidth
 MODULATION: C4FM/iDEN/Analog FM
 CONFIGURATION: Single band
 BOOSTER OUTPUT POWER SETTINGS: 33 dBm

Frequency, MHz	SA reading, dBm	Attenuator, dB	Cable loss, dB	RBW, kHz	Spurious emission, dBm	Attenuation below carrier, dBc	Limit, dBc	Margin, dB*	Verdict
Low carrier frequency									
All emissions were found more than 20 dB below the limit									Pass
Mid carrier frequency									
All emissions were found more than 20 dB below the limit									Pass
High carrier frequency									
All emissions were found more than 20 dB below the limit									Pass

*- Margin = Spurious emission – specification limit.

ASSIGNED FREQUENCY RANGES: 806 – 816 MHz Uplink
 INVESTIGATED FREQUENCY RANGE: 0.009 – 8200 MHz
 DETECTOR USED: Peak
 VIDEO BANDWIDTH: ≥ Resolution bandwidth
 MODULATION: C4FM/iDEN/Analog FM
 CONFIGURATION: Single band
 BOOSTER OUTPUT POWER SETTINGS: 27 dBm

Frequency, MHz	SA reading, dBm	Attenuator, dB	Cable loss, dB	RBW, kHz	Spurious emission, dBm	Attenuation below carrier, dBc	Limit, dBc	Margin, dB*	Verdict
Low carrier frequency									
All emissions were found more than 20 dB below the limit									Pass
Mid carrier frequency									
All emissions were found more than 20 dB below the limit									Pass
High carrier frequency									
All emissions were found more than 20 dB below the limit									Pass

*- Margin = Spurious emission – specification limit.

Reference numbers of test equipment used

HL 0539	HL 2909	HL 3301	HL 3302	HL 3768	HL 3770	HL 3776	HL 4273
HL 4275	HL 4354	HL 4413					

Full description is given in Appendix A.

Test specification:		Section 90.219(e)(3), Conducted spurious emissions	
Test procedure:		47 CFR, Sections 2.1051; KDB 935210 D02 v02, Appendix D	
Test mode:		Compliance	
Date(s):		06-Aug-14 - 10-Aug-14	
Temperature: 23.2 °C		Air Pressure: 1008 hPa	
		Relative Humidity: 46 %	
		Power Supply: 120 VAC	
Remarks:			
		Verdict: PASS	

Plot 7.8.1 Spurious emission measurements in 9 - 150 kHz range at low carrier frequency

FREQUENCY RANGE: 758 - 775 MHz
 OPERATIONAL MODE: C4FM downlink transmit
 INPUT PORT: Base
 INPUT POWER: -51 dBm
 CONFIGURATION: Single Band

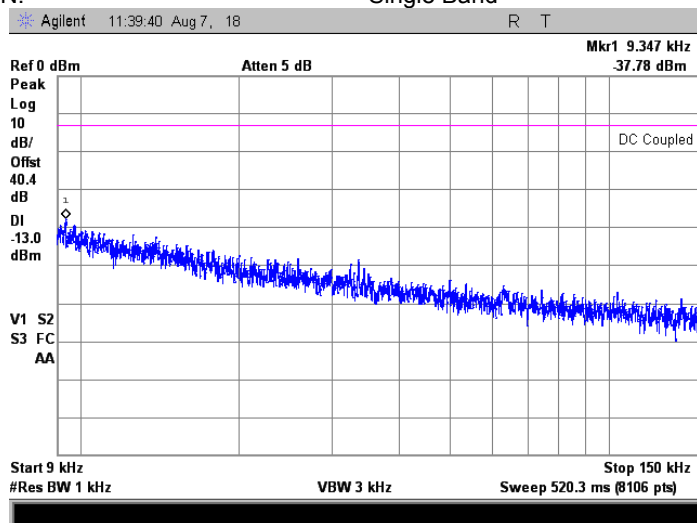

Plot 7.8.2 Spurious emission measurements in 9 - 150 kHz range at mid carrier frequency

FREQUENCY RANGE: 758 - 775 MHz
 OPERATIONAL MODE: C4FM downlink transmit
 INPUT PORT: Base
 INPUT POWER: -51 dBm
 CONFIGURATION: Single Band

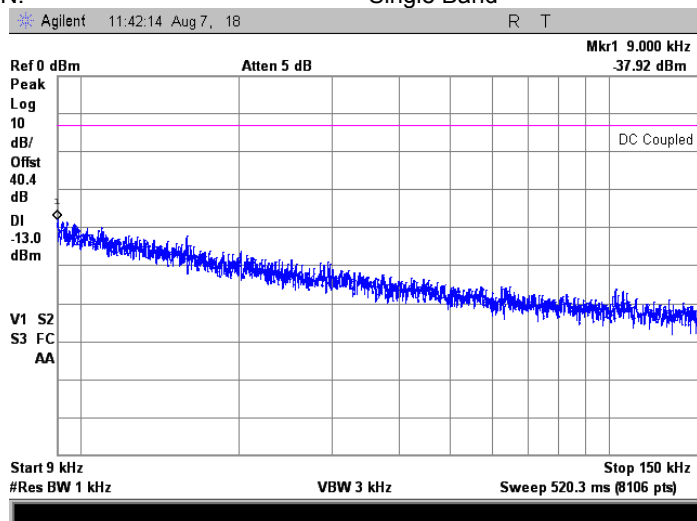

Test specification:		Section 90.219(e)(3), Conducted spurious emissions	
Test procedure:		47 CFR, Sections 2.1051; KDB 935210 D02 v02, Appendix D	
Test mode:		Compliance	
Date(s):		06-Aug-14 - 10-Aug-14	
Temperature: 23.2 °C		Air Pressure: 1008 hPa	
		Relative Humidity: 46 %	
		Power Supply: 120 VAC	
Remarks:			
		Verdict: PASS	

Plot 7.8.3 Spurious emission measurements in 9 - 150 kHz range at high carrier frequency

FREQUENCY RANGE: 758 - 775 MHz
 OPERATIONAL MODE: C4FM downlink transmit
 INPUT PORT: Base
 INPUT POWER: -51 dBm
 CONFIGURATION: Single Band

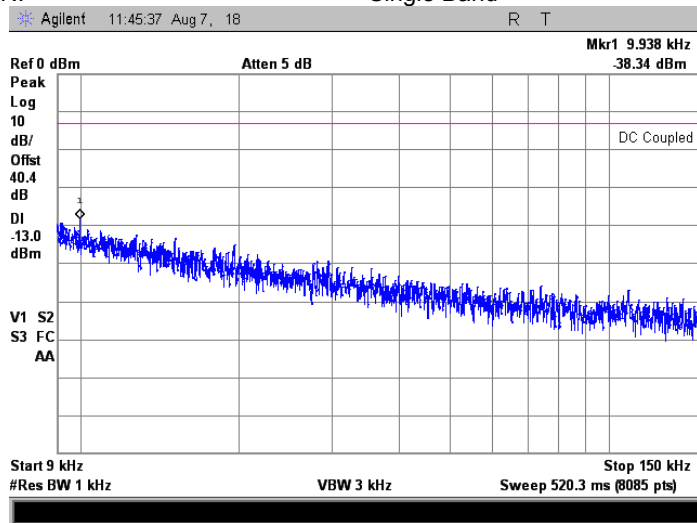

Plot 7.8.4 Spurious emission measurements in 0.15 - 30.0 MHz range at low carrier frequency

FREQUENCY RANGE: 758 - 775 MHz
 OPERATIONAL MODE: C4FM downlink transmit
 INPUT PORT: Base
 INPUT POWER: -51 dBm
 CONFIGURATION: Single Band

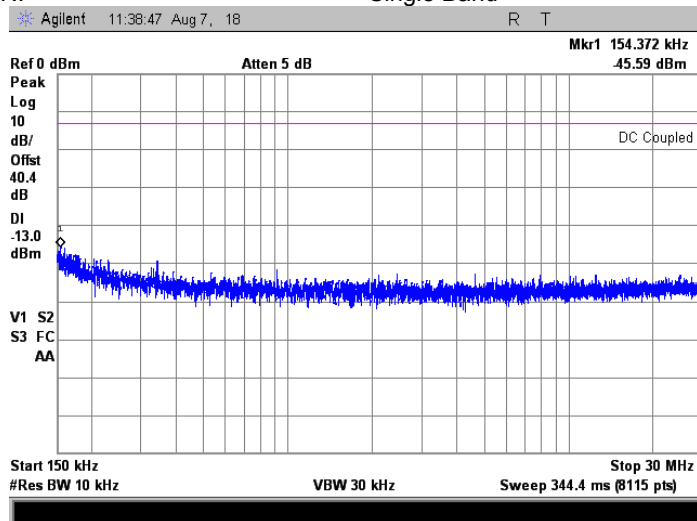

Test specification:		Section 90.219(e)(3), Conducted spurious emissions	
Test procedure:		47 CFR, Sections 2.1051; KDB 935210 D02 v02, Appendix D	
Test mode:		Compliance	
Date(s):		06-Aug-14 - 10-Aug-14	
Temperature: 23.2 °C		Air Pressure: 1008 hPa	
		Relative Humidity: 46 %	
		Power Supply: 120 VAC	
Remarks:			
		Verdict: PASS	

Plot 7.8.5 Spurious emission measurements in 0.15 - 30.0 MHz range at mid carrier frequency

FREQUENCY RANGE: 758 - 775 MHz
 OPERATIONAL MODE: C4FM downlink transmit
 INPUT PORT: Base
 INPUT POWER: -51 dBm
 CONFIGURATION: Single Band

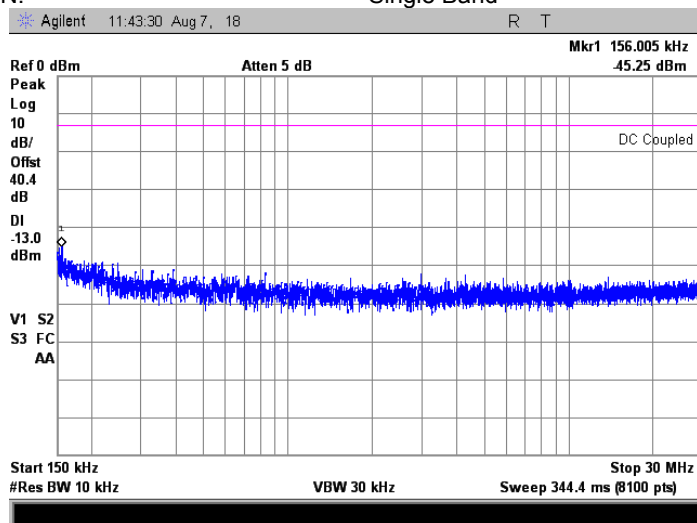

Plot 7.8.6 Spurious emission measurements in 0.15 – 30.0 MHz range at high carrier frequency

FREQUENCY RANGE: 758 - 775 MHz
 OPERATIONAL MODE: C4FM downlink transmit
 INPUT PORT: Base
 INPUT POWER: -51 dBm
 CONFIGURATION: Single Band

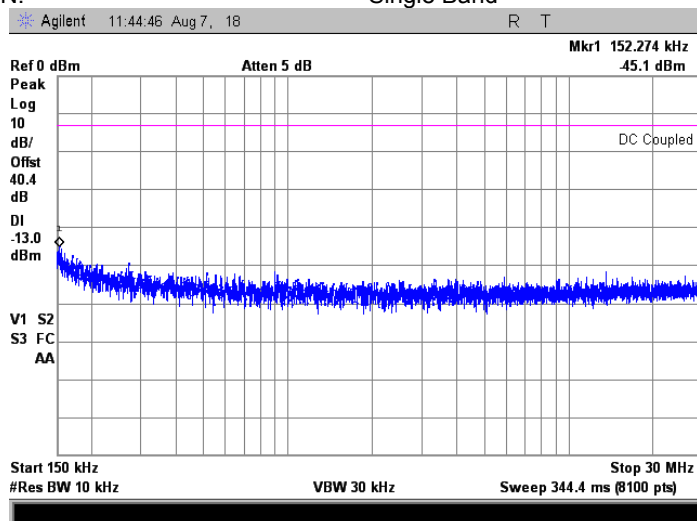

Test specification:		Section 90.219(e)(3), Conducted spurious emissions	
Test procedure:		47 CFR, Sections 2.1051; KDB 935210 D02 v02, Appendix D	
Test mode:		Verdict:	
Compliance		PASS	
Date(s):		06-Aug-14 - 10-Aug-14	
Temperature: 23.2 °C	Air Pressure: 1008 hPa	Relative Humidity: 46 %	Power Supply: 120 VAC
Remarks:			

Plot 7.8.7 Spurious emission measurements in 30.0 - 1000 MHz range at low carrier frequency

FREQUENCY RANGE:
OPERATIONAL MODE:
INPUT PORT:
INPUT POWER:
CONFIGURATION:

758 - 775 MHz
C4FM downlink transmit
Base
-51 dBm
Single Band

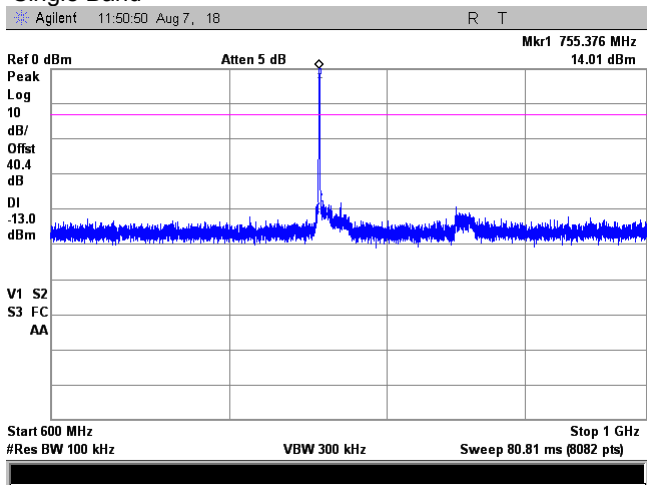
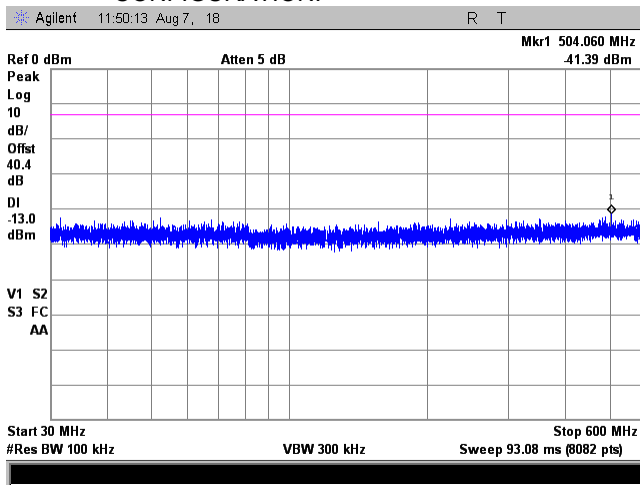

Plot 7.8.8 Spurious emission measurements in 30.0 - 1000 MHz range at mid carrier frequency

FREQUENCY RANGE:
OPERATIONAL MODE:
INPUT PORT:
INPUT POWER:
CONFIGURATION:

758 - 775 MHz
C4FM downlink transmit
Base
-51 dBm
Single Band

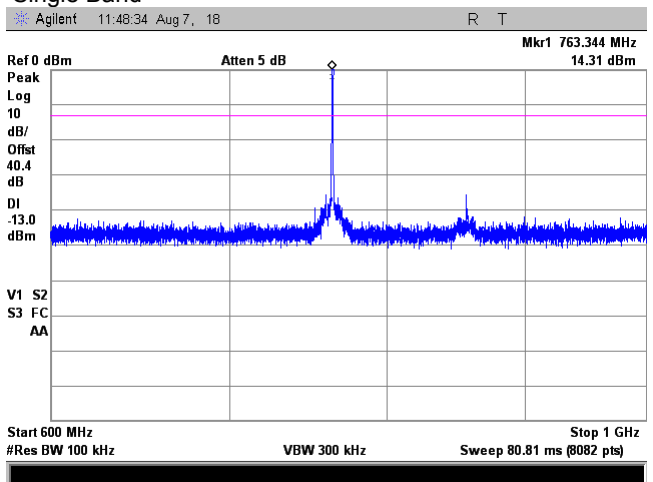
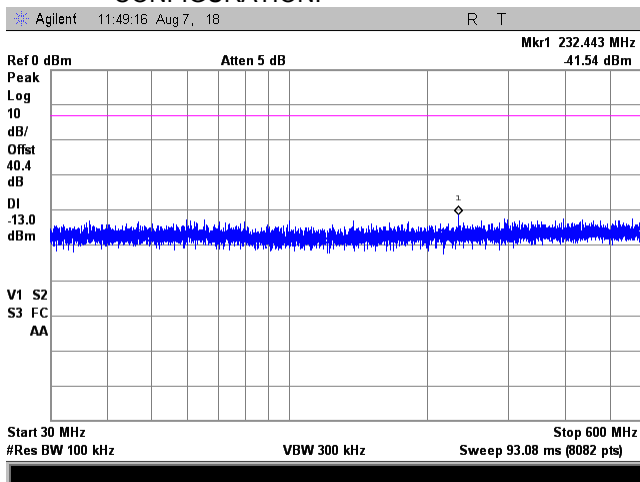

Test specification:		Section 90.219(e)(3), Conducted spurious emissions	
Test procedure:		47 CFR, Sections 2.1051; KDB 935210 D02 v02, Appendix D	
Test mode:		Verdict: PASS	
Date(s):		06-Aug-14 - 10-Aug-14	
Temperature: 23.2 °C	Air Pressure: 1008 hPa	Relative Humidity: 46 %	Power Supply: 120 VAC
Remarks:			

Plot 7.8.9 Spurious emission measurements in 30.0 - 1000 MHz range at high carrier frequency

FREQUENCY RANGE: 758 - 775 MHz
 OPERATIONAL MODE: C4FM downlink transmit
 INPUT PORT: Base
 INPUT POWER: -51 dBm
 CONFIGURATION: Single Band

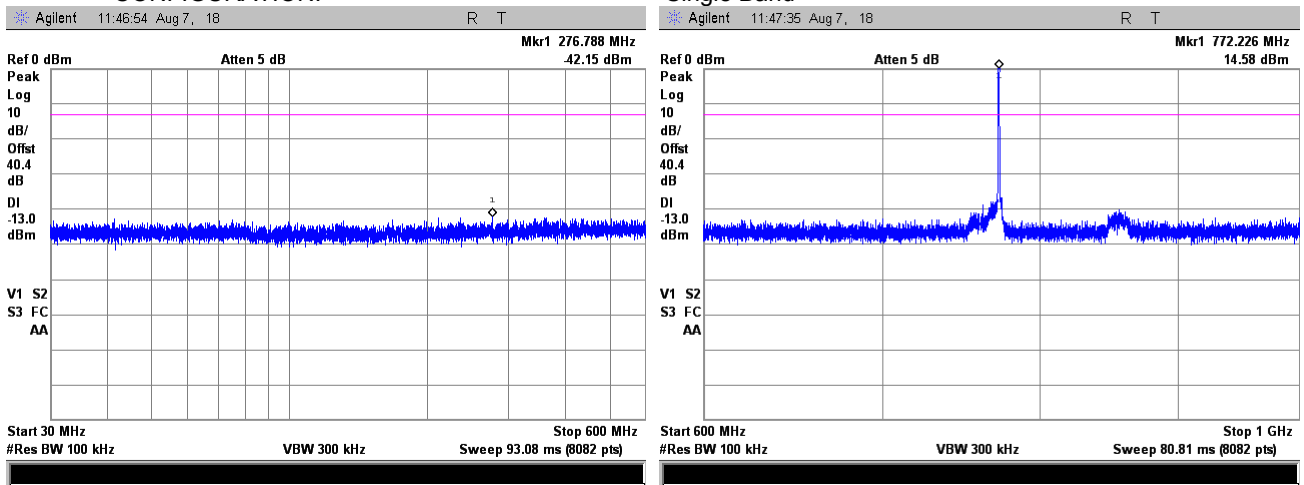

Plot 7.8.10 Spurious emission measurements in 1000 - 8000 MHz range at low carrier frequency

FREQUENCY RANGE: 758 - 775 MHz
 OPERATIONAL MODE: C4FM downlink transmit
 INPUT PORT: Base
 INPUT POWER: -51 dBm
 CONFIGURATION: Single Band

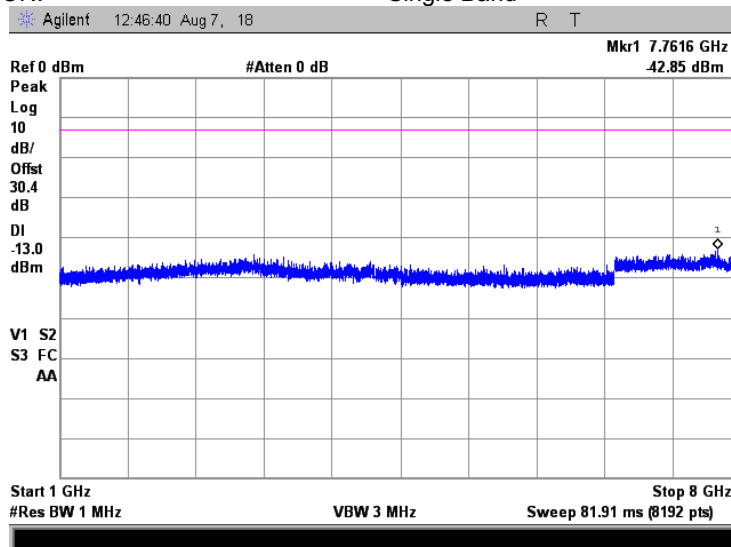

Test specification:		Section 90.219(e)(3), Conducted spurious emissions	
Test procedure:		47 CFR, Sections 2.1051; KDB 935210 D02 v02, Appendix D	
Test mode:		Compliance	
Date(s):		06-Aug-14 - 10-Aug-14	
Temperature: 23.2 °C		Air Pressure: 1008 hPa	
		Relative Humidity: 46 %	
		Power Supply: 120 VAC	
Remarks:			
		Verdict: PASS	

Plot 7.8.11 Spurious emission measurements in 1000 - 8000 MHz at mid carrier frequency

FREQUENCY RANGE: 758 - 775 MHz
 OPERATIONAL MODE: C4FM downlink transmit
 INPUT PORT: Base
 INPUT POWER: -51 dBm
 CONFIGURATION: Single Band

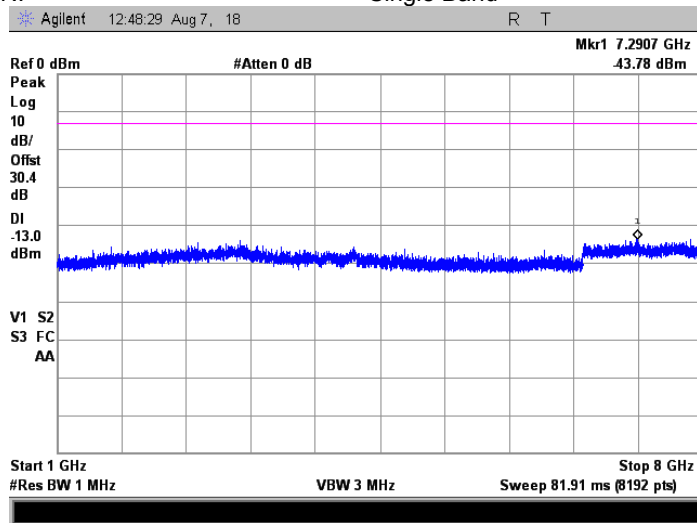

Plot 7.8.12 Spurious emission measurements in 1000 - 8000 MHz at high carrier frequency

FREQUENCY RANGE: 758 - 775 MHz
 OPERATIONAL MODE: C4FM downlink transmit
 INPUT PORT: Base
 INPUT POWER: -51 dBm
 CONFIGURATION: Single Band

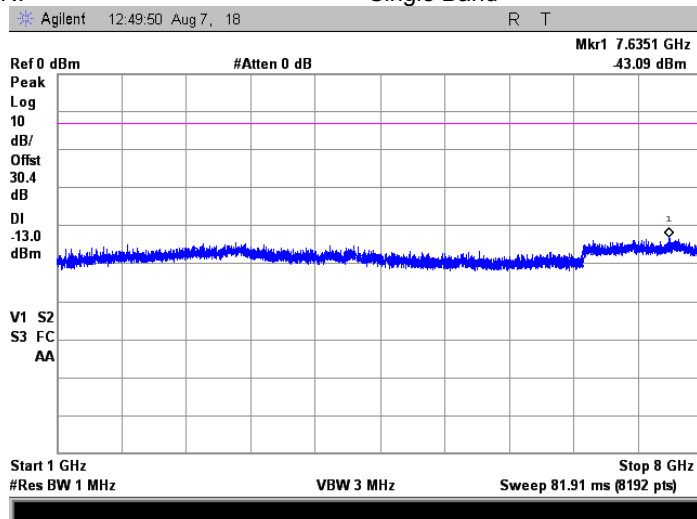

Test specification:		Section 90.219(e)(3), Conducted spurious emissions	
Test procedure:		47 CFR, Sections 2.1051; KDB 935210 D02 v02, Appendix D	
Test mode:		Compliance	
Date(s):		06-Aug-14 - 10-Aug-14	
Temperature: 23.2 °C		Air Pressure: 1008 hPa	
		Relative Humidity: 46 %	
		Power Supply: 120 VAC	
Remarks:			
		Verdict: PASS	

Plot 7.8.13 Spurious emission measurements in 9 - 150 kHz range at low carrier frequency

FREQUENCY RANGE: 758 - 775 MHz
 OPERATIONAL MODE: iDEN QAM downlink transmit
 INPUT PORT: Mobile
 INPUT POWER: -51 dBm
 CONFIGURATION: Single Band

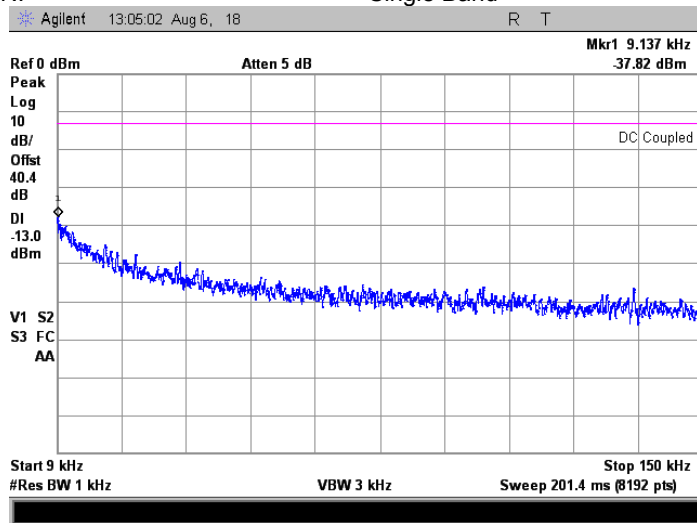

Plot 7.8.14 Spurious emission measurements in 9 - 150 kHz range at mid carrier frequency

FREQUENCY RANGE: 758 - 775 MHz
 OPERATIONAL MODE: iDEN QAM downlink transmit
 INPUT PORT: Mobile
 INPUT POWER: -51 dBm
 CONFIGURATION: Single Band

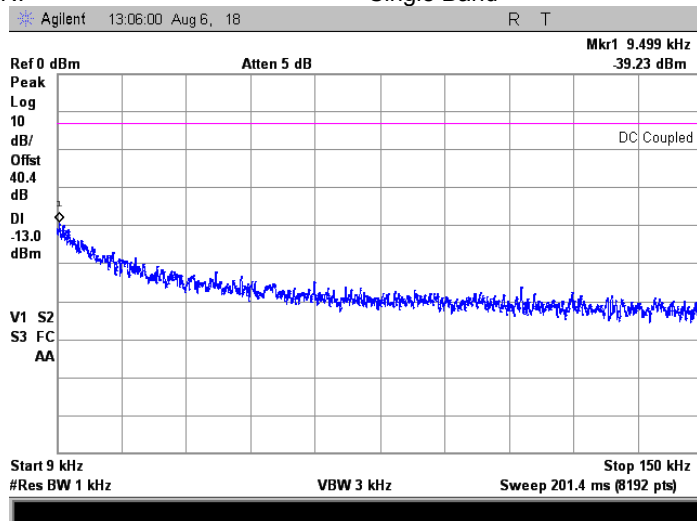

Test specification:	Section 90.219(e)(3), Conducted spurious emissions		
Test procedure:	47 CFR, Sections 2.1051; KDB 935210 D02 v02, Appendix D		
Test mode:	Compliance	Verdict:	PASS
Date(s):	06-Aug-14 - 10-Aug-14		
Temperature: 23.2 °C	Air Pressure: 1008 hPa	Relative Humidity: 46 %	Power Supply: 120 VAC
Remarks:			

Plot 7.8.15 Spurious emission measurements in 9 - 150 kHz range at high carrier frequency

FREQUENCY RANGE: 758 - 775 MHz
 OPERATIONAL MODE: iDEN QAM downlink transmit
 INPUT PORT: Mobile
 INPUT POWER: -51 dBm
 CONFIGURATION: Single Band

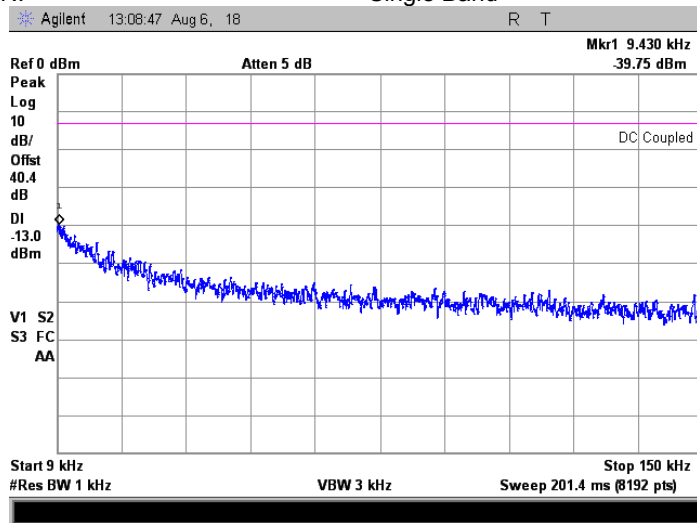

Plot 7.8.16 Spurious emission measurements in 0.15 - 30.0 MHz range at low carrier frequency

FREQUENCY RANGE: 758 - 775 MHz
 OPERATIONAL MODE: iDEN QAM downlink transmit
 INPUT PORT: Mobile
 INPUT POWER: -51 dBm
 CONFIGURATION: Single Band

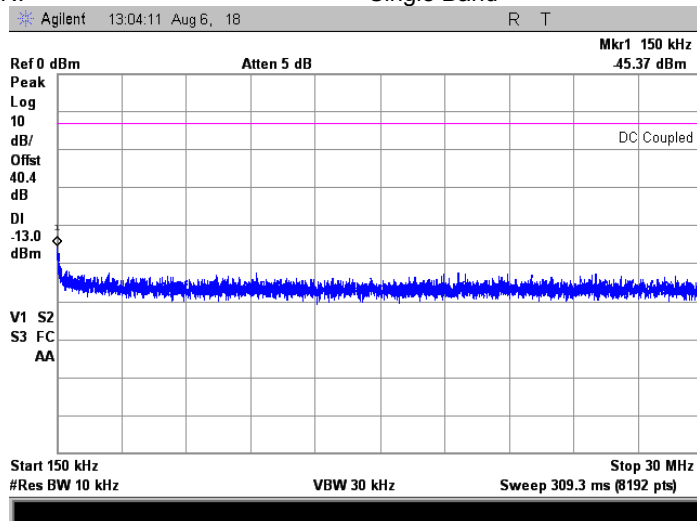

Test specification:		Section 90.219(e)(3), Conducted spurious emissions	
Test procedure:		47 CFR, Sections 2.1051; KDB 935210 D02 v02, Appendix D	
Test mode:		Compliance	
Date(s):		06-Aug-14 - 10-Aug-14	
Temperature: 23.2 °C		Air Pressure: 1008 hPa	
		Relative Humidity: 46 %	
		Power Supply: 120 VAC	
Remarks:			
		Verdict: PASS	

Plot 7.8.17 Spurious emission measurements in 0.15 - 30.0 MHz range at mid carrier frequency

FREQUENCY RANGE: 758 - 775 MHz
 OPERATIONAL MODE: iDEN QAM downlink transmit
 INPUT PORT: Mobile
 INPUT POWER: -51 dBm
 CONFIGURATION: Single Band

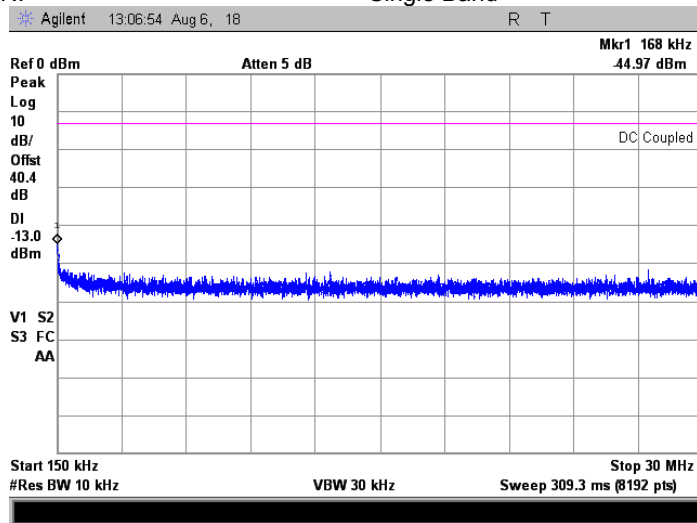

Plot 7.8.18 Spurious emission measurements in 0.15 - 30.0 MHz range at high carrier frequency

FREQUENCY RANGE: 758 - 775 MHz
 OPERATIONAL MODE: iDEN QAM downlink transmit
 INPUT PORT: Mobile
 INPUT POWER: -51 dBm
 CONFIGURATION: Single Band

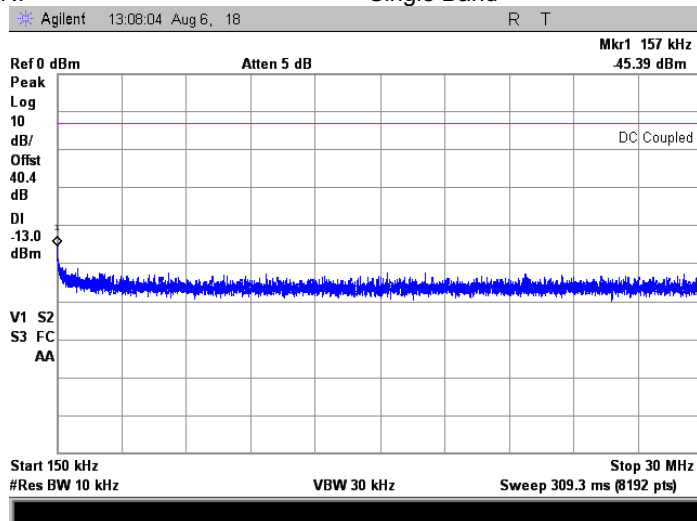

Test specification:		Section 90.219(e)(3), Conducted spurious emissions	
Test procedure:		47 CFR, Sections 2.1051; KDB 935210 D02 v02, Appendix D	
Test mode:		Verdict:	
Compliance		PASS	
Date(s):		06-Aug-14 - 10-Aug-14	
Temperature: 23.2 °C	Air Pressure: 1008 hPa	Relative Humidity: 46 %	Power Supply: 120 VAC
Remarks:			

Plot 7.8.19 Spurious emission measurements in 30.0 - 1000 MHz range at low carrier frequency

FREQUENCY RANGE:
OPERATIONAL MODE:
INPUT PORT:
INPUT POWER:
CONFIGURATION:

758 - 775 MHz
iDEN QAM downlink transmit
Mobile
-51 dBm
Single Band

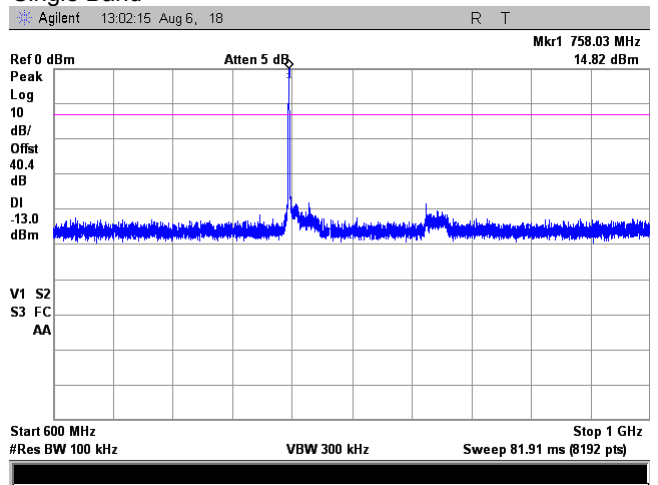
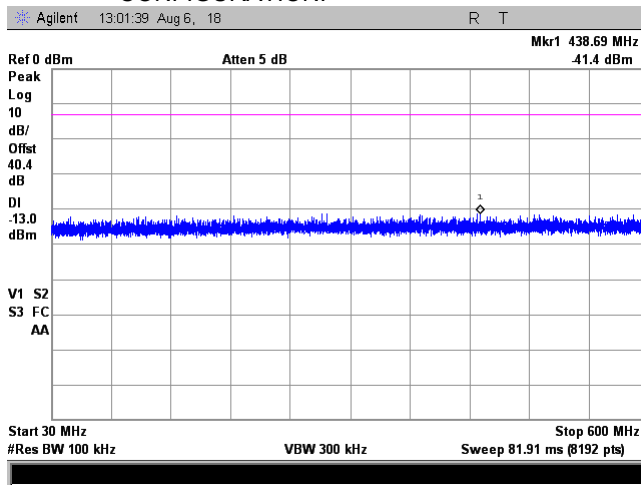

Plot 7.8.20 Spurious emission measurements in 30.0 - 1000 MHz range at mid carrier frequency

FREQUENCY RANGE:
OPERATIONAL MODE:
INPUT PORT:
INPUT POWER:
CONFIGURATION:

758 - 775 MHz
iDEN QAM downlink transmit
Mobile
-51 dBm
Single Band

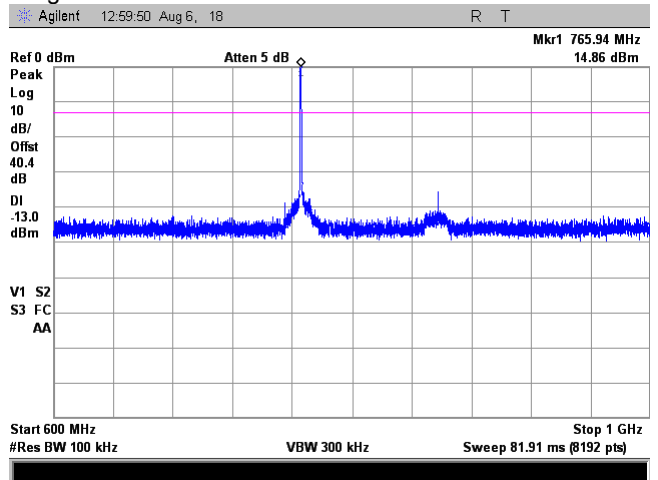
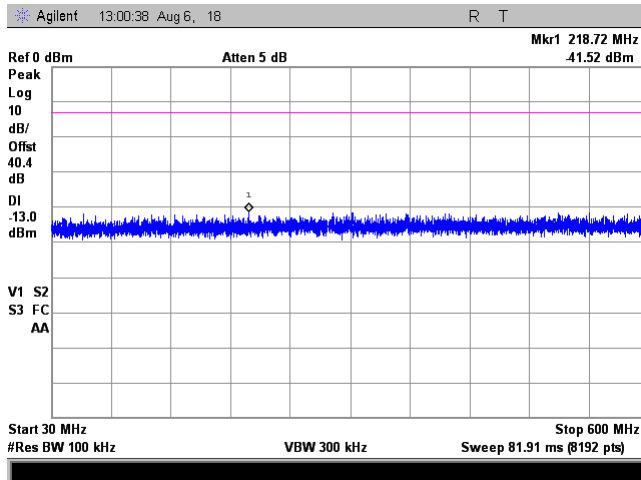

Test specification:		Section 90.219(e)(3), Conducted spurious emissions	
Test procedure:		47 CFR, Sections 2.1051; KDB 935210 D02 v02, Appendix D	
Test mode:		Compliance	
Date(s):		06-Aug-14 - 10-Aug-14	
Temperature: 23.2 °C		Air Pressure: 1008 hPa	
		Relative Humidity: 46 %	
		Power Supply: 120 VAC	
Remarks:			
		Verdict: PASS	

Plot 7.8.21 Spurious emission measurements in 30.0 - 1000 MHz range at high carrier frequency

FREQUENCY RANGE: 758 - 775 MHz
 OPERATIONAL MODE: iDEN QAM downlink transmit
 INPUT PORT: Mobile
 INPUT POWER: -51 dBm
 CONFIGURATION: Single Band

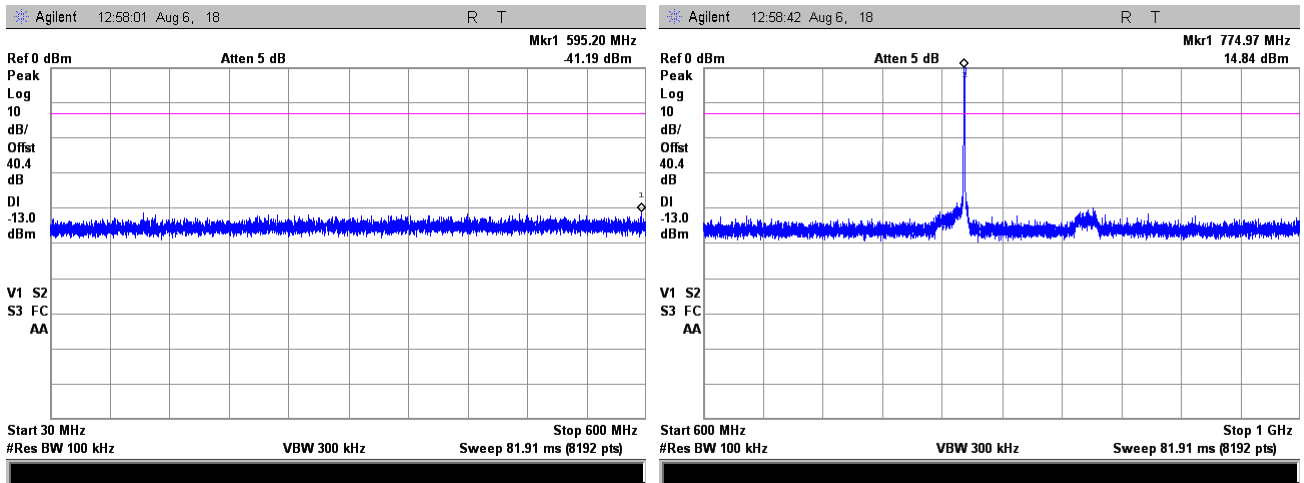

Plot 7.8.22 Spurious emission measurements in 1000 - 8000 MHz range at low carrier frequency

FREQUENCY RANGE: 758 - 775 MHz
 OPERATIONAL MODE: iDEN QAM downlink transmit
 INPUT PORT: Mobile
 INPUT POWER: -51 dBm
 CONFIGURATION: Single Band

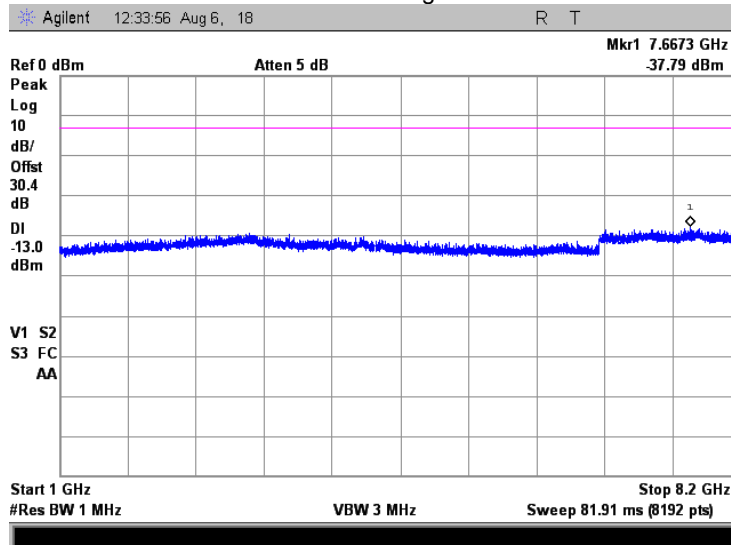

Test specification:		Section 90.219(e)(3), Conducted spurious emissions	
Test procedure:		47 CFR, Sections 2.1051; KDB 935210 D02 v02, Appendix D	
Test mode:		Compliance	
Date(s):		06-Aug-14 - 10-Aug-14	
Temperature: 23.2 °C		Air Pressure: 1008 hPa	
		Relative Humidity: 46 %	
		Power Supply: 120 VAC	
Remarks:			
		Verdict: PASS	

Plot 7.8.23 Spurious emission measurements in 1000 - 8000 MHz at mid carrier frequency

FREQUENCY RANGE: 758 - 775 MHz
 OPERATIONAL MODE: iDEN QAM downlink transmit
 INPUT PORT: Mobile
 INPUT POWER: -51 dBm
 CONFIGURATION: Single Band

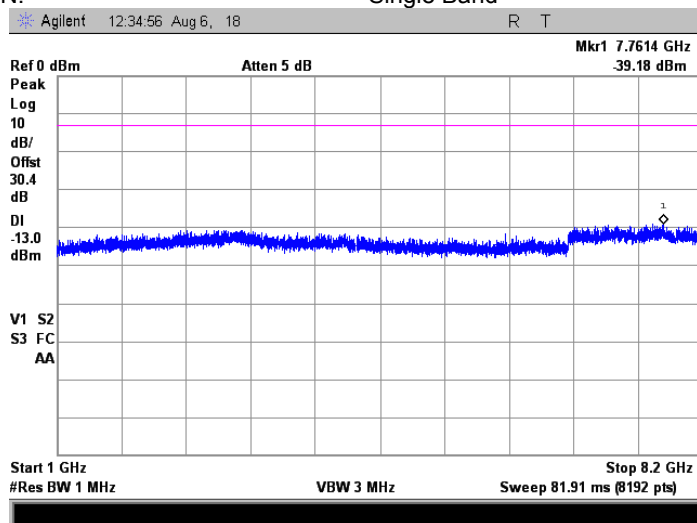

Plot 7.8.24 Spurious emission measurements in 1000 - 8000 MHz at high carrier frequency

FREQUENCY RANGE: 758 - 775 MHz
 OPERATIONAL MODE: iDEN QAM downlink transmit
 INPUT PORT: Mobile
 INPUT POWER: -51 dBm
 CONFIGURATION: Single Band

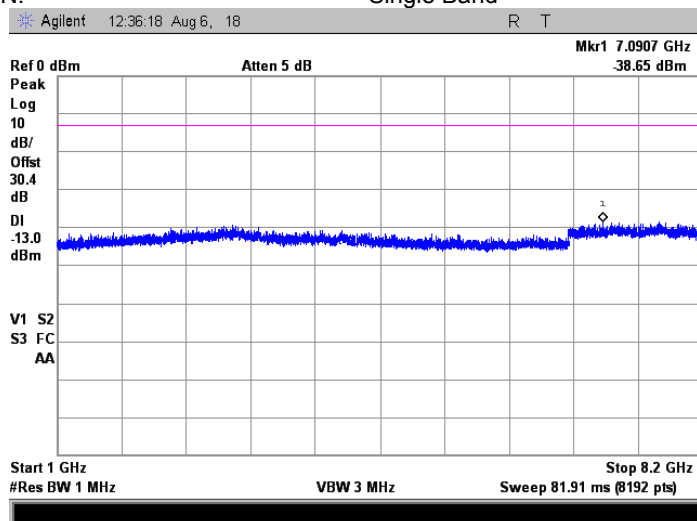

Test specification:		Section 90.219(e)(3), Conducted spurious emissions	
Test procedure:		47 CFR, Sections 2.1051; KDB 935210 D02 v02, Appendix D	
Test mode:		Compliance	
Date(s):		06-Aug-14 - 10-Aug-14	
Temperature: 23.2 °C		Air Pressure: 1008 hPa	
		Relative Humidity: 46 %	
		Power Supply: 120 VAC	
Remarks:			
		Verdict: PASS	

Plot 7.8.25 Spurious emission measurements in 9 - 150 kHz range at low carrier frequency

FREQUENCY RANGE: 758 - 775 MHz
 OPERATIONAL MODE: Analog FM downlink transmit
 INPUT PORT: Base
 INPUT POWER: -51 dBm
 CONFIGURATION: Single Band

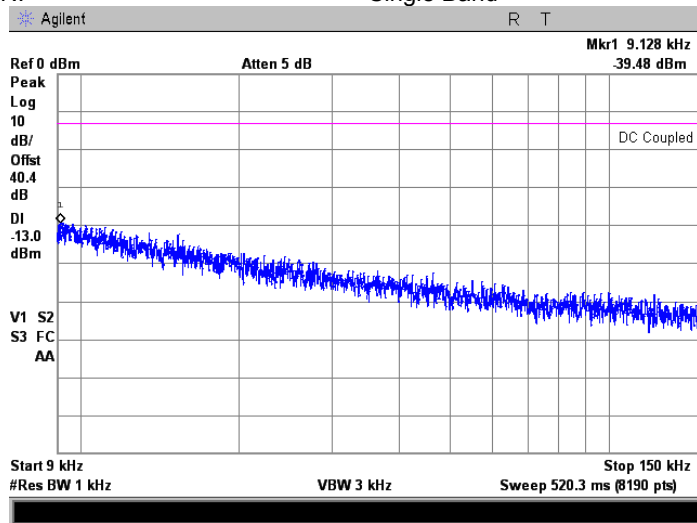

Plot 7.8.26 Spurious emission measurements in 9 - 150 kHz range at mid carrier frequency

FREQUENCY RANGE: 758 - 775 MHz
 OPERATIONAL MODE: Analog FM downlink transmit
 INPUT PORT: Base
 INPUT POWER: -51 dBm
 CONFIGURATION: Single Band

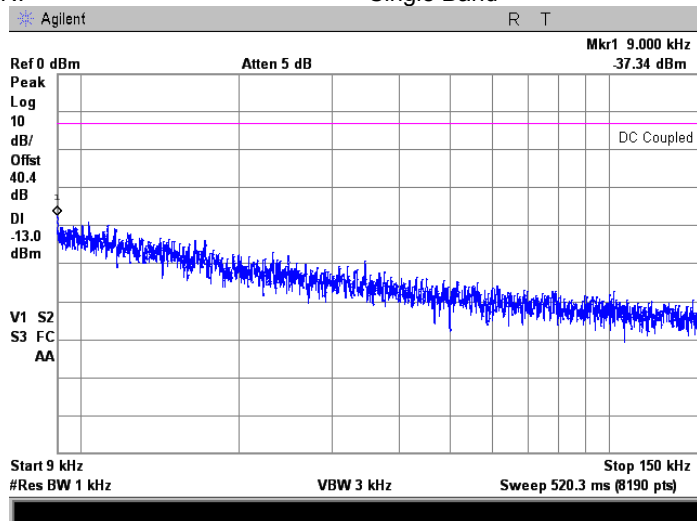

Test specification:		Section 90.219(e)(3), Conducted spurious emissions	
Test procedure:		47 CFR, Sections 2.1051; KDB 935210 D02 v02, Appendix D	
Test mode:		Compliance	
Date(s):		06-Aug-14 - 10-Aug-14	
Temperature: 23.2 °C		Air Pressure: 1008 hPa	
		Relative Humidity: 46 %	
		Power Supply: 120 VAC	
Remarks:			
		Verdict: PASS	

Plot 7.8.27 Spurious emission measurements in 9 - 150 kHz range at high carrier frequency

FREQUENCY RANGE: 758 - 775 MHz
 OPERATIONAL MODE: Analog FM downlink transmit
 INPUT PORT: Base
 INPUT POWER: -51 dBm
 CONFIGURATION: Single Band

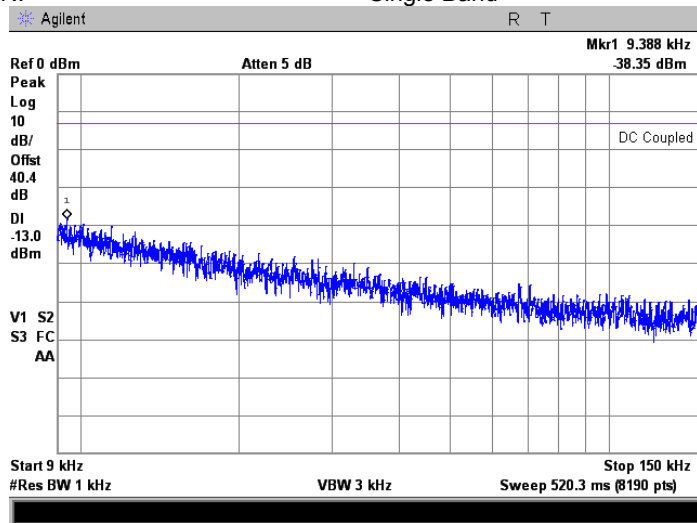

Plot 7.8.28 Spurious emission measurements in 0.15 - 30.0 MHz range at low carrier frequency

FREQUENCY RANGE: 758 - 775 MHz
 OPERATIONAL MODE: Analog FM downlink transmit
 INPUT PORT: Base
 INPUT POWER: -51 dBm
 CONFIGURATION: Single Band

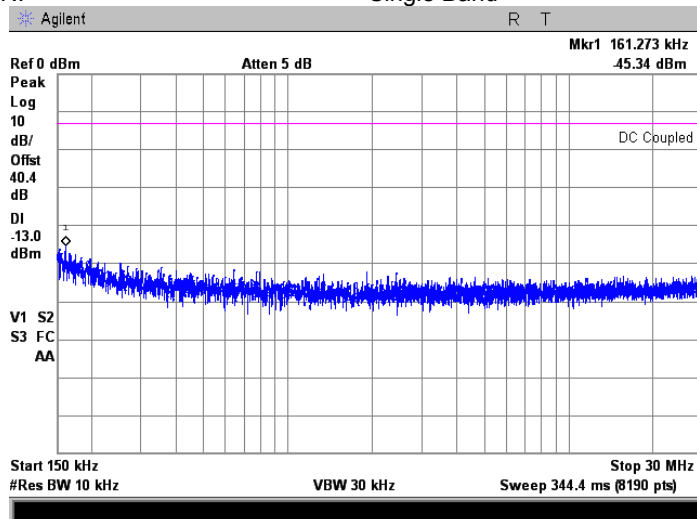

Test specification:		Section 90.219(e)(3), Conducted spurious emissions	
Test procedure:		47 CFR, Sections 2.1051; KDB 935210 D02 v02, Appendix D	
Test mode:		Compliance	
Date(s):		06-Aug-14 - 10-Aug-14	
Temperature: 23.2 °C		Air Pressure: 1008 hPa	
		Relative Humidity: 46 %	
		Power Supply: 120 VAC	
Remarks:			
		Verdict: PASS	

Plot 7.8.29 Spurious emission measurements in 0.15 - 30.0 MHz range at mid carrier frequency

FREQUENCY RANGE: 758 - 775 MHz
 OPERATIONAL MODE: Analog FM downlink transmit
 INPUT PORT: Base
 INPUT POWER: -51 dBm
 CONFIGURATION: Single Band

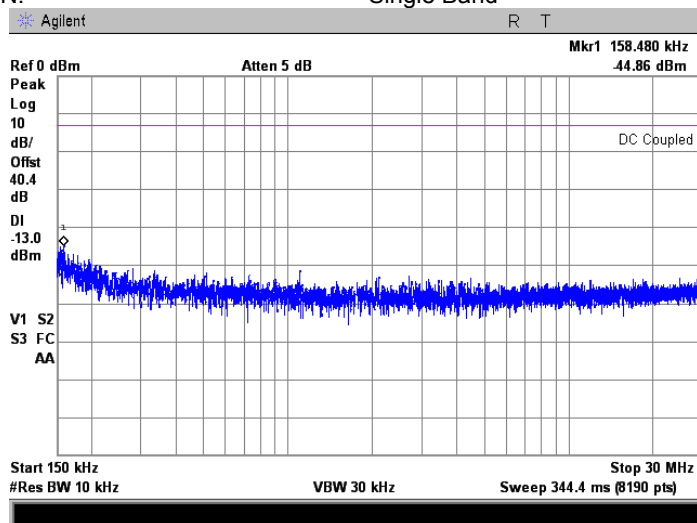

Plot 7.8.30 Spurious emission measurements in 0.15 - 30.0 MHz range at high carrier frequency

FREQUENCY RANGE: 758 - 775 MHz
 OPERATIONAL MODE: Analog FM downlink transmit
 INPUT PORT: Base
 INPUT POWER: -51 dBm
 CONFIGURATION: Single Band

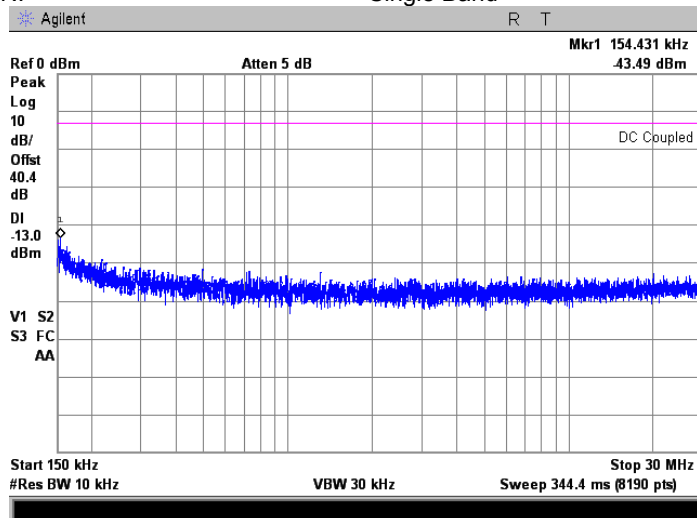

Test specification:		Section 90.219(e)(3), Conducted spurious emissions	
Test procedure:		47 CFR, Sections 2.1051; KDB 935210 D02 v02, Appendix D	
Test mode:		Verdict:	
Compliance		PASS	
Date(s):		06-Aug-14 - 10-Aug-14	
Temperature: 23.2 °C	Air Pressure: 1008 hPa	Relative Humidity: 46 %	Power Supply: 120 VAC
Remarks:			

Plot 7.8.31 Spurious emission measurements in 30.0 - 1000 MHz range at low carrier frequency

FREQUENCY RANGE:
OPERATIONAL MODE:
INPUT PORT:
INPUT POWER:
CONFIGURATION:

758 - 775 MHz
Analog FM downlink transmit
Base
-51 dBm
Single Band

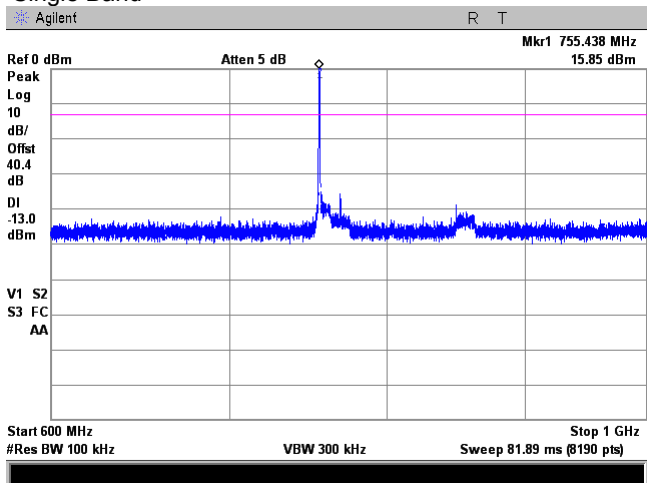
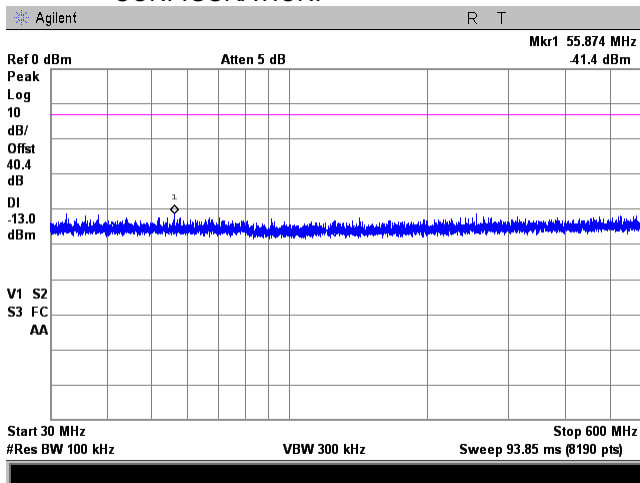

Plot 7.8.32 Spurious emission measurements in 30.0 - 1000 MHz range at mid carrier frequency

FREQUENCY RANGE:
OPERATIONAL MODE:
INPUT PORT:
INPUT POWER:
CONFIGURATION:

758 - 775 MHz
Analog FM downlink transmit
Base
-51 dBm
Single Band

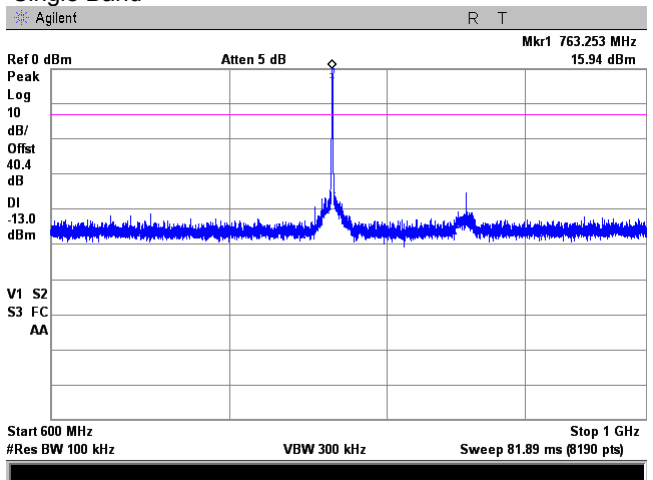
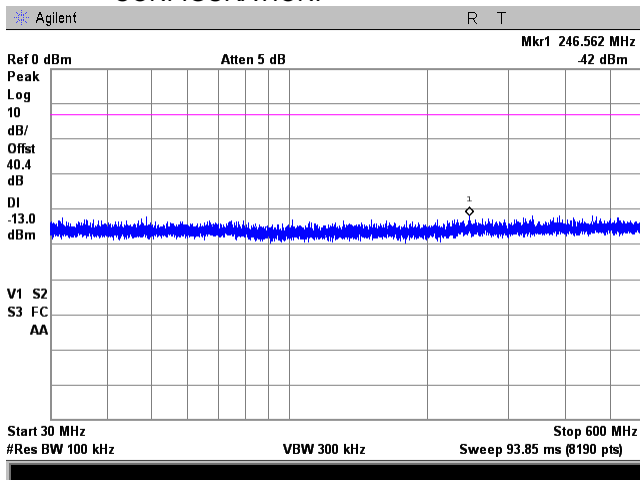

Test specification:		Section 90.219(e)(3), Conducted spurious emissions	
Test procedure:		47 CFR, Sections 2.1051; KDB 935210 D02 v02, Appendix D	
Test mode:		Verdict:	
Compliance		PASS	
Date(s):		06-Aug-14 - 10-Aug-14	
Temperature: 23.2 °C	Air Pressure: 1008 hPa	Relative Humidity: 46 %	Power Supply: 120 VAC
Remarks:			

Plot 7.8.33 Spurious emission measurements in 30.0 - 1000 MHz range at high carrier frequency

FREQUENCY RANGE: 758 - 775 MHz
 OPERATIONAL MODE: Analog FM downlink transmit
 INPUT PORT: Base
 INPUT POWER: -51 dBm
 CONFIGURATION: Single Band

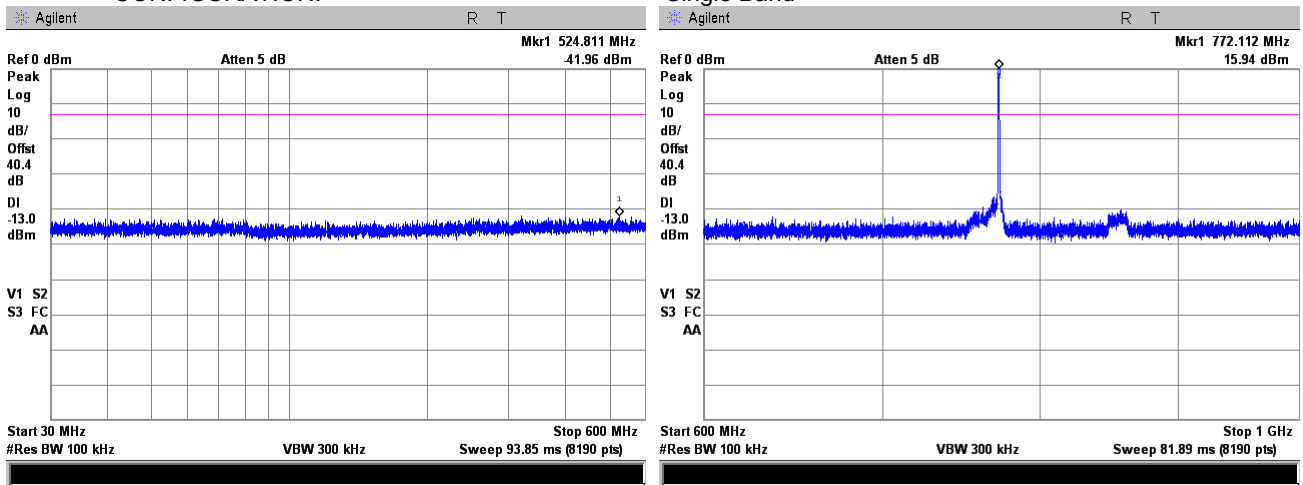

Plot 7.8.34 Spurious emission measurements in 1000 - 8000 MHz range at low carrier frequency

FREQUENCY RANGE: 758 - 775 MHz
 OPERATIONAL MODE: Analog FM downlink transmit
 INPUT PORT: Base
 INPUT POWER: -51 dBm
 CONFIGURATION: Single Band

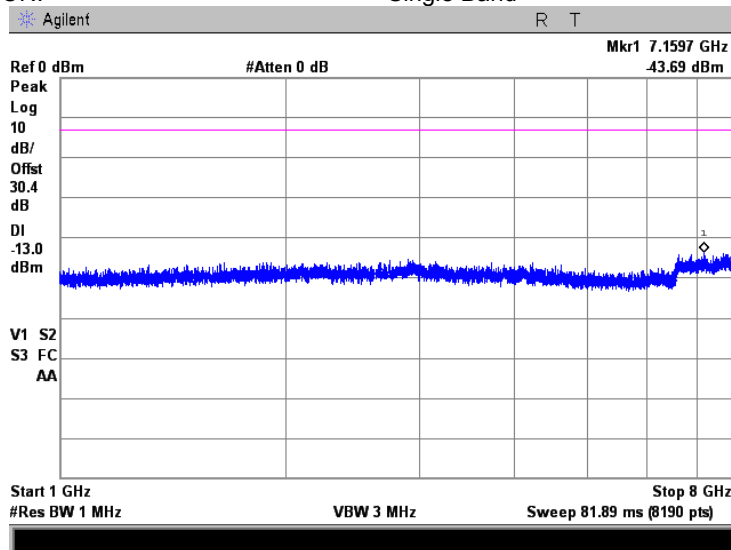

Test specification:		Section 90.219(e)(3), Conducted spurious emissions	
Test procedure:		47 CFR, Sections 2.1051; KDB 935210 D02 v02, Appendix D	
Test mode:		Compliance	
Date(s):		06-Aug-14 - 10-Aug-14	
Temperature: 23.2 °C		Air Pressure: 1008 hPa	
		Relative Humidity: 46 %	
		Power Supply: 120 VAC	
Remarks:			

Plot 7.8.35 Spurious emission measurements in 1000 – 8000 MHz at mid carrier frequency

FREQUENCY RANGE: 758 - 775 MHz
 OPERATIONAL MODE: Analog FM downlink transmit
 INPUT PORT: Base
 INPUT POWER: -51 dBm
 CONFIGURATION: Single Band

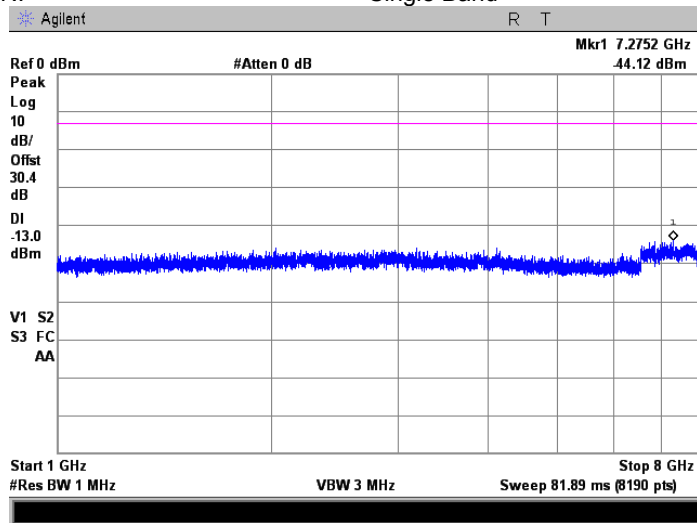

Plot 7.8.36 Spurious emission measurements in 1000 – 8000 MHz at high carrier frequency

FREQUENCY RANGE: 758 - 775 MHz
 OPERATIONAL MODE: Analog FM downlink transmit
 INPUT PORT: Base
 INPUT POWER: -51 dBm
 CONFIGURATION: Single Band

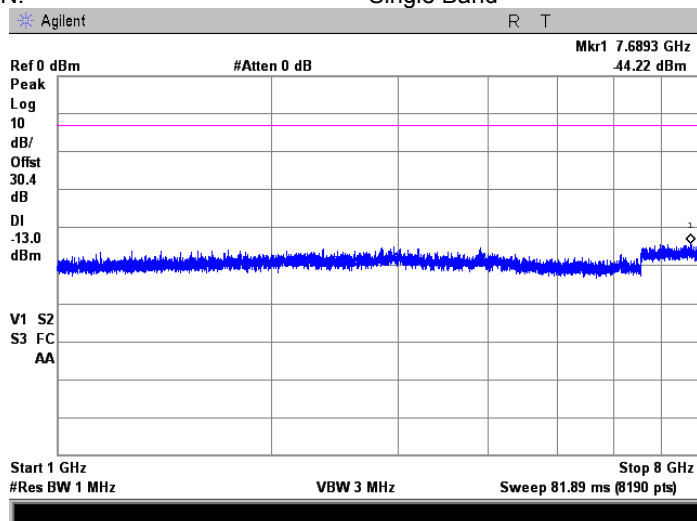

Test specification:		Section 90.219(e)(3), Conducted spurious emissions	
Test procedure:		47 CFR, Sections 2.1051; KDB 935210 D02 v02, Appendix D	
Test mode:		Compliance	
Date(s):		06-Aug-14 - 10-Aug-14	
Temperature: 23.2 °C		Air Pressure: 1008 hPa	
		Relative Humidity: 46 %	
		Power Supply: 120 VAC	
Remarks:			
		Verdict: PASS	

Plot 7.8.37 Spurious emission measurements in 9 - 150 kHz range at low carrier frequency

FREQUENCY RANGE: 788 - 805 MHz
 OPERATIONAL MODE: C4FM uplink transmit
 INPUT PORT: Mobile
 INPUT POWER: -54 dBm
 CONFIGURATION: Single Band

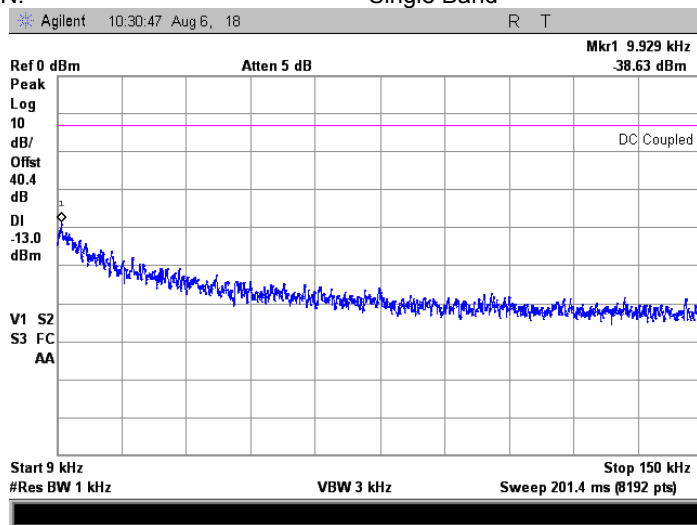

Plot 7.8.38 Spurious emission measurements in 9 - 150 kHz range at mid carrier frequency

FREQUENCY RANGE: 788 - 805 MHz
 OPERATIONAL MODE: C4FM uplink transmit
 INPUT PORT: Mobile
 INPUT POWER: -54 dBm
 CONFIGURATION: Single Band

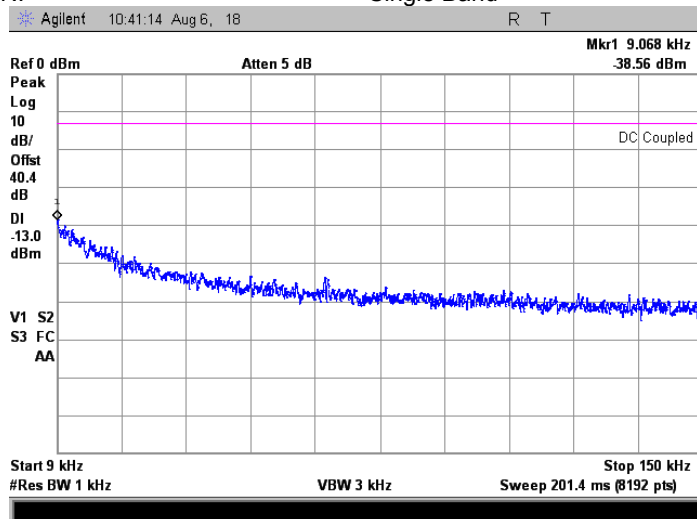

Test specification:	Section 90.219(e)(3), Conducted spurious emissions		
Test procedure:	47 CFR, Sections 2.1051; KDB 935210 D02 v02, Appendix D		
Test mode:	Compliance	Verdict:	PASS
Date(s):	06-Aug-14 - 10-Aug-14		
Temperature: 23.2 °C	Air Pressure: 1008 hPa	Relative Humidity: 46 %	Power Supply: 120 VAC
Remarks:			

Plot 7.8.39 Spurious emission measurements in 9 - 150 kHz range at high carrier frequency

FREQUENCY RANGE: 788 - 805 MHz
 OPERATIONAL MODE: C4FM uplink transmit
 INPUT PORT: Mobile
 INPUT POWER: -54 dBm
 CONFIGURATION: Single Band

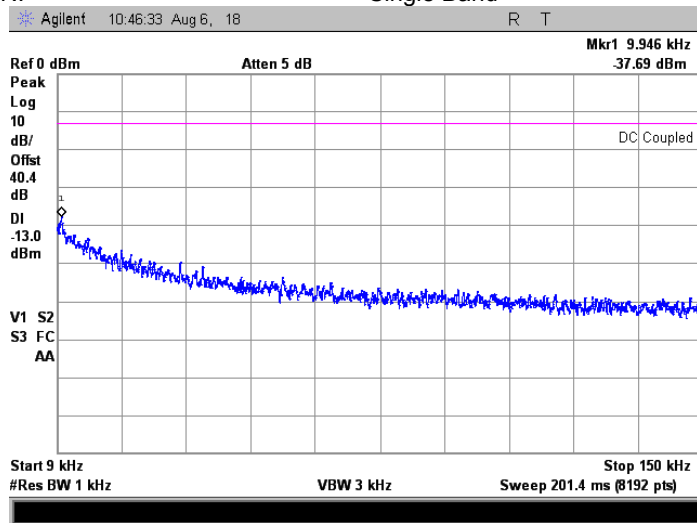

Plot 7.8.40 Spurious emission measurements in 0.15 - 30.0 MHz range at low carrier frequency

FREQUENCY RANGE: 788 - 805 MHz
 OPERATIONAL MODE: C4FM uplink transmit
 INPUT PORT: Mobile
 INPUT POWER: -54 dBm
 CONFIGURATION: Single Band

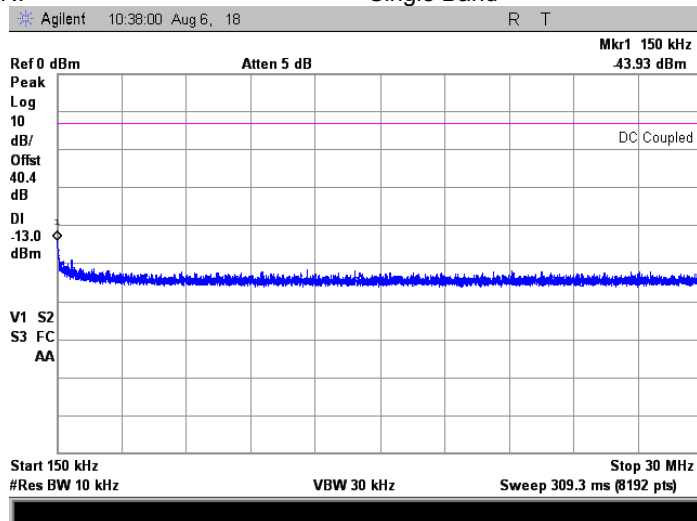

Test specification:		Section 90.219(e)(3), Conducted spurious emissions	
Test procedure:		47 CFR, Sections 2.1051; KDB 935210 D02 v02, Appendix D	
Test mode:		Compliance	
Date(s):		06-Aug-14 - 10-Aug-14	
Temperature: 23.2 °C		Air Pressure: 1008 hPa	
		Relative Humidity: 46 %	
		Power Supply: 120 VAC	
Remarks:			
		Verdict: PASS	

Plot 7.8.41 Spurious emission measurements in 0.15 - 30.0 MHz range at mid carrier frequency

FREQUENCY RANGE: 788 - 805 MHz
 OPERATIONAL MODE: C4FM uplink transmit
 INPUT PORT: Mobile
 INPUT POWER: -54 dBm
 CONFIGURATION: Single Band

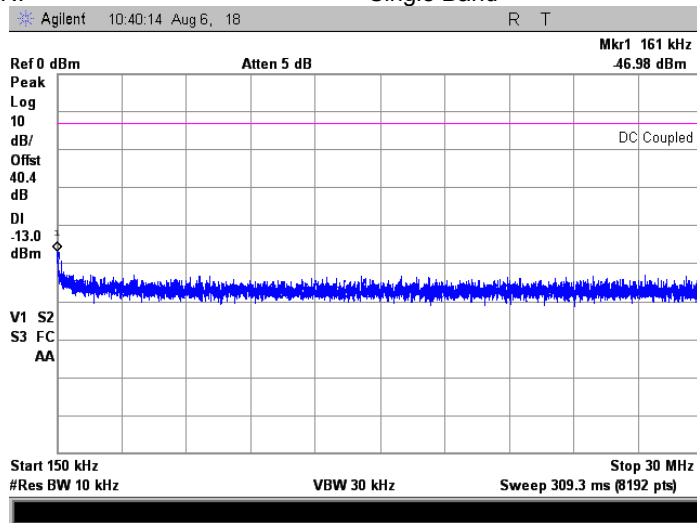

Plot 7.8.42 Spurious emission measurements in 0.15 - 30.0 MHz range at high carrier frequency

FREQUENCY RANGE: 788 - 805 MHz
 OPERATIONAL MODE: C4FM uplink transmit
 INPUT PORT: Mobile
 INPUT POWER: -54 dBm
 CONFIGURATION: Single Band

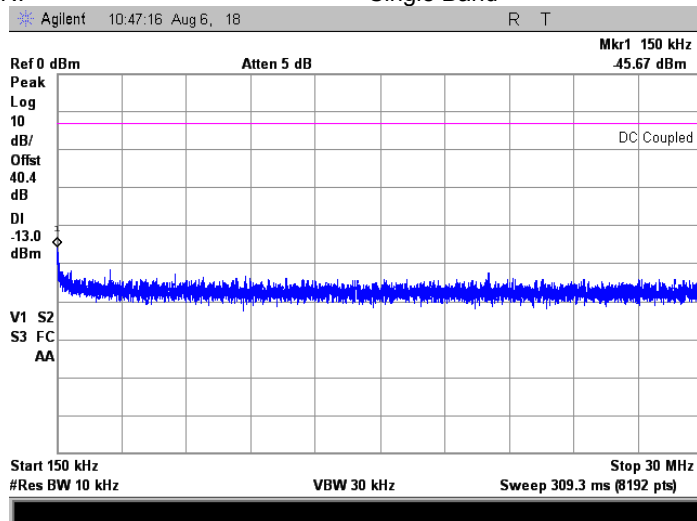

Test specification:		Section 90.219(e)(3), Conducted spurious emissions	
Test procedure:		47 CFR, Sections 2.1051; KDB 935210 D02 v02, Appendix D	
Test mode:		Verdict:	
Compliance		PASS	
Date(s):		06-Aug-14 - 10-Aug-14	
Temperature: 23.2 °C	Air Pressure: 1008 hPa	Relative Humidity: 46 %	Power Supply: 120 VAC
Remarks:			

Plot 7.8.43 Spurious emission measurements in 30.0 - 1000 MHz range at low carrier frequency

FREQUENCY RANGE: 788 - 805 MHz
 OPERATIONAL MODE: C4FM uplink transmit
 INPUT PORT: Mobile
 INPUT POWER: -54 dBm
 CONFIGURATION: Single Band

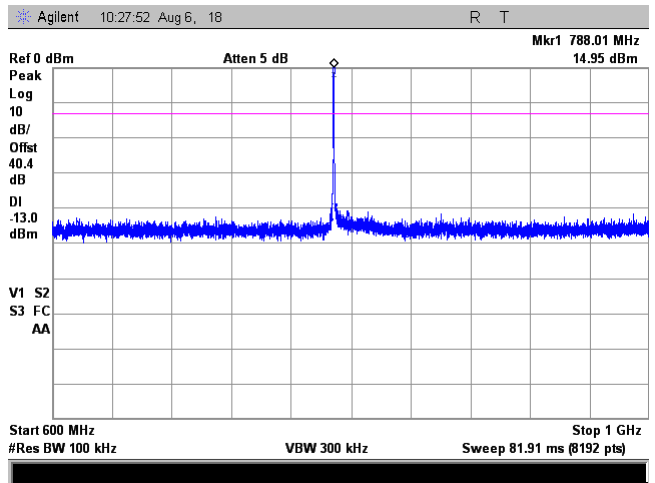
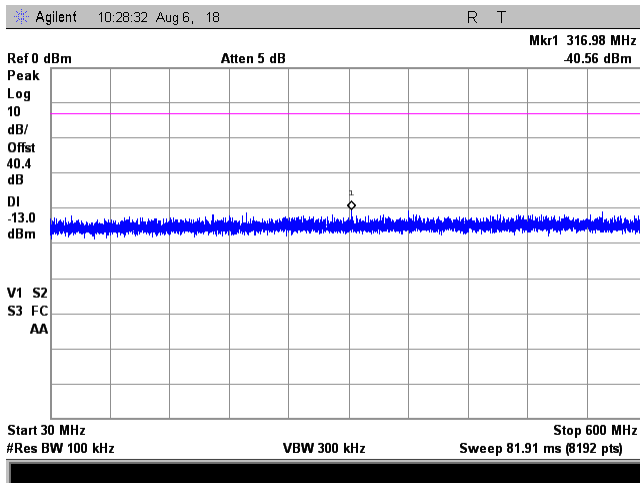

Plot 7.8.44 Spurious emission measurements in 30.0 - 1000 MHz range at mid carrier frequency

FREQUENCY RANGE: 788 - 805 MHz
 OPERATIONAL MODE: C4FM uplink transmit
 INPUT PORT: Mobile
 INPUT POWER: -54 dBm
 CONFIGURATION: Single Band

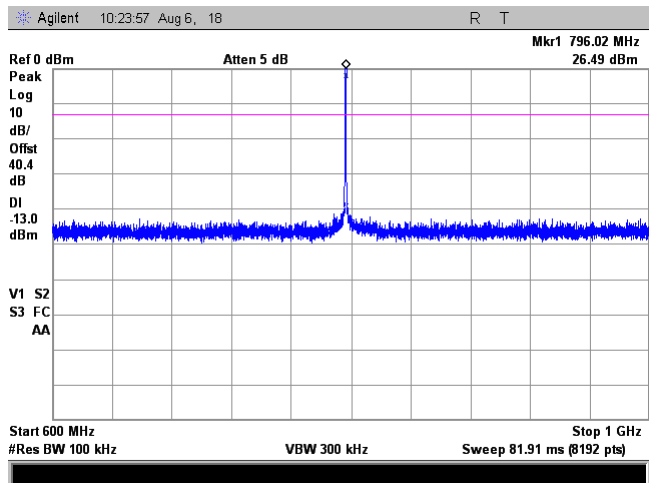
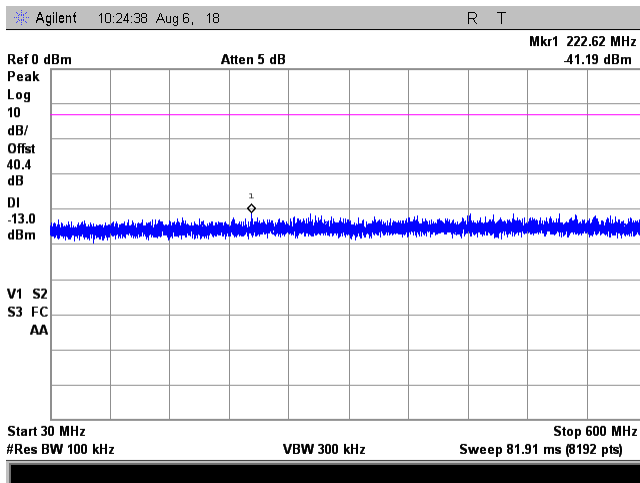

Test specification:		Section 90.219(e)(3), Conducted spurious emissions	
Test procedure:		47 CFR, Sections 2.1051; KDB 935210 D02 v02, Appendix D	
Test mode:		Compliance	
Date(s):		06-Aug-14 - 10-Aug-14	
Temperature: 23.2 °C		Air Pressure: 1008 hPa	
		Relative Humidity: 46 %	
		Power Supply: 120 VAC	
Remarks:			
		Verdict: PASS	

Plot 7.8.45 Spurious emission measurements in 30.0 - 1000 MHz range at high carrier frequency

FREQUENCY RANGE: 788 - 805 MHz
 OPERATIONAL MODE: C4FM uplink transmit
 INPUT PORT: Mobile
 INPUT POWER: -54 dBm
 CONFIGURATION: Single Band

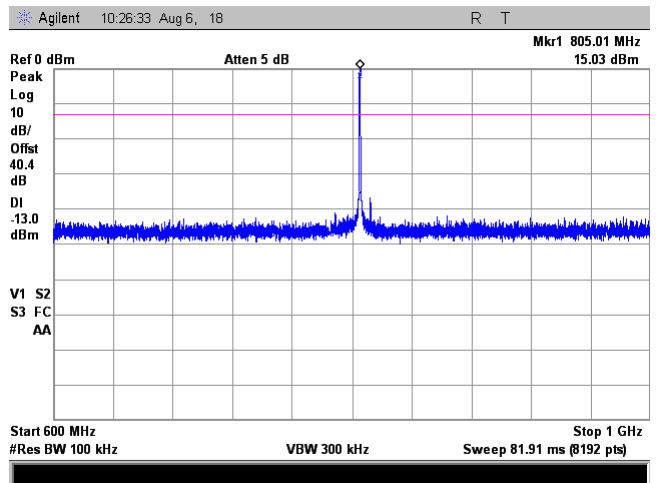
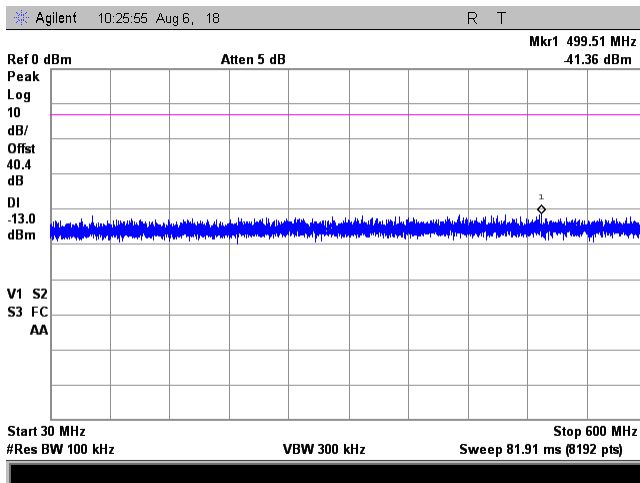

Test specification:		Section 90.219(e)(3), Conducted spurious emissions	
Test procedure:		47 CFR, Sections 2.1051; KDB 935210 D02 v02, Appendix D	
Test mode:		Compliance	
Date(s):		06-Aug-14 - 10-Aug-14	
Temperature: 23.2 °C		Air Pressure: 1008 hPa	
		Relative Humidity: 46 %	
		Power Supply: 120 VAC	
Remarks:			
		Verdict: PASS	

Plot 7.8.46 Spurious emission measurements in 1000 - 8100 MHz range at low carrier frequency

FREQUENCY RANGE: 788 - 805 MHz
 OPERATIONAL MODE: C4FM uplink transmit
 INPUT PORT: Mobile
 INPUT POWER: -54 dBm
 CONFIGURATION: Single Band

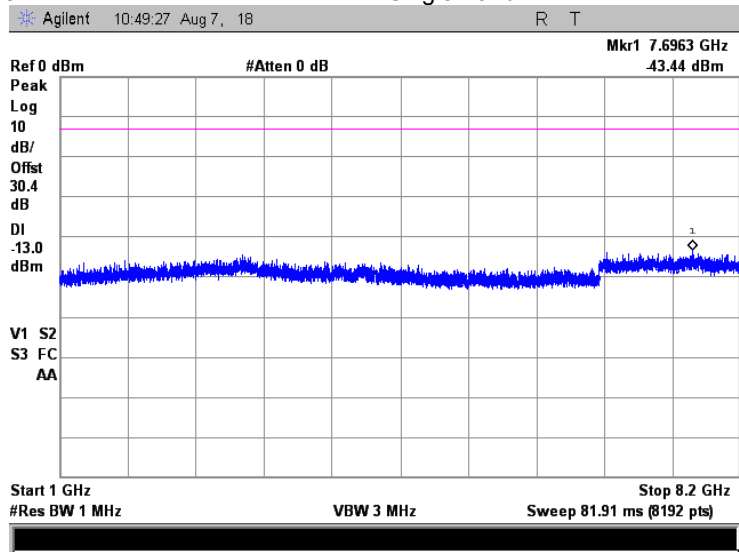

Test specification:		Section 90.219(e)(3), Conducted spurious emissions	
Test procedure:		47 CFR, Sections 2.1051; KDB 935210 D02 v02, Appendix D	
Test mode:		Compliance	
Date(s):		06-Aug-14 - 10-Aug-14	
Temperature: 23.2 °C		Air Pressure: 1008 hPa	
		Relative Humidity: 46 %	
		Power Supply: 120 VAC	
Remarks:			
		Verdict: PASS	

Plot 7.8.47 Spurious emission measurements in 1000 - 8100 MHz at mid carrier frequency

FREQUENCY RANGE: 788 - 805 MHz
 OPERATIONAL MODE: C4FM uplink transmit
 INPUT PORT: Mobile
 INPUT POWER: -54 dBm
 CONFIGURATION: Single Band

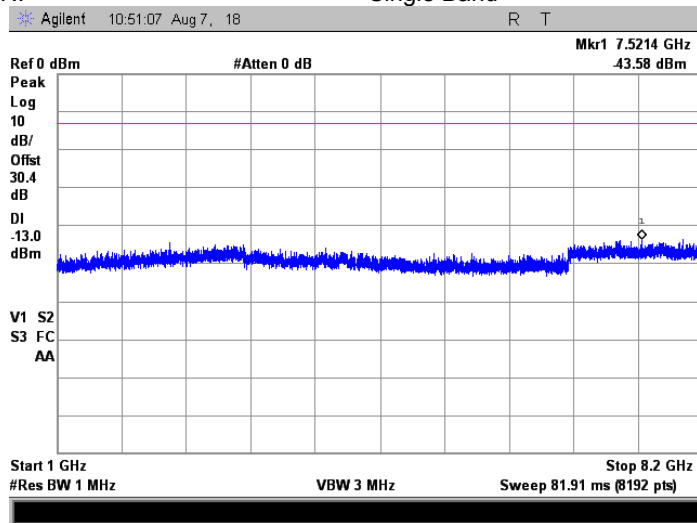

Plot 7.8.48 Spurious emission measurements in 1000 - 8100 MHz at high carrier frequency

FREQUENCY RANGE: 788 - 805 MHz
 OPERATIONAL MODE: C4FM uplink transmit
 INPUT PORT: Mobile
 INPUT POWER: -54 dBm
 CONFIGURATION: Single Band

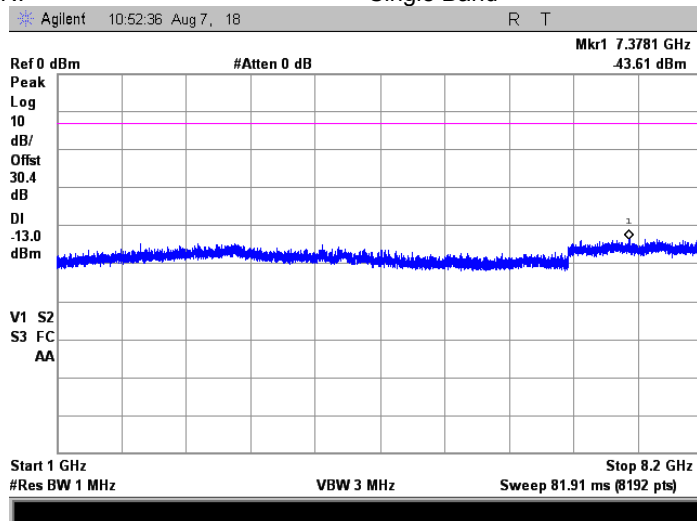

Test specification:		Section 90.219(e)(3), Conducted spurious emissions	
Test procedure:		47 CFR, Sections 2.1051; KDB 935210 D02 v02, Appendix D	
Test mode:		Compliance	
Date(s):		06-Aug-14 - 10-Aug-14	
Temperature: 23.2 °C		Air Pressure: 1008 hPa	
		Relative Humidity: 46 %	
		Power Supply: 120 VAC	
Remarks:			
		Verdict: PASS	

Plot 7.8.49 Spurious emission measurements in 9 - 150 kHz range at low carrier frequency

FREQUENCY RANGE: 788 - 805 MHz
 OPERATIONAL MODE: iDEN QAM uplink transmit
 INPUT PORT: Mobile
 INPUT POWER: -54 dBm
 CONFIGURATION: Single Band

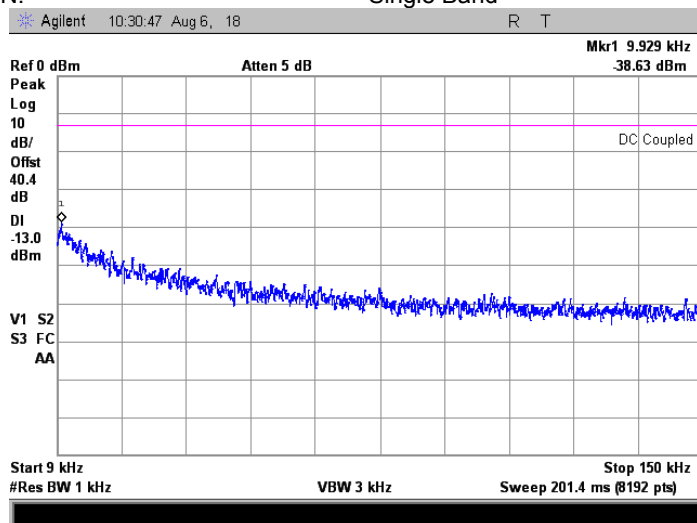

Plot 7.8.50 Spurious emission measurements in 9 - 150 kHz range at mid carrier frequency

FREQUENCY RANGE: 788 - 805 MHz
 OPERATIONAL MODE: iDEN QAM uplink transmit
 INPUT PORT: Mobile
 INPUT POWER: -54 dBm
 CONFIGURATION: Single Band

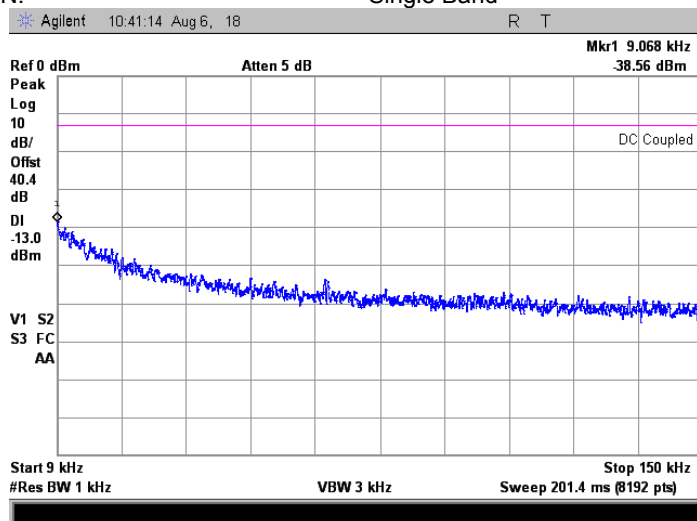

Test specification:	Section 90.219(e)(3), Conducted spurious emissions		
Test procedure:	47 CFR, Sections 2.1051; KDB 935210 D02 v02, Appendix D		
Test mode:	Compliance	Verdict:	PASS
Date(s):	06-Aug-14 - 10-Aug-14		
Temperature: 23.2 °C	Air Pressure: 1008 hPa	Relative Humidity: 46 %	Power Supply: 120 VAC
Remarks:			

Plot 7.8.51 Spurious emission measurements in 9 - 150 kHz range at high carrier frequency

FREQUENCY RANGE: 788 - 805 MHz
 OPERATIONAL MODE: iDEN QAM uplink transmit
 INPUT PORT: Mobile
 INPUT POWER: -54 dBm
 CONFIGURATION: Single Band

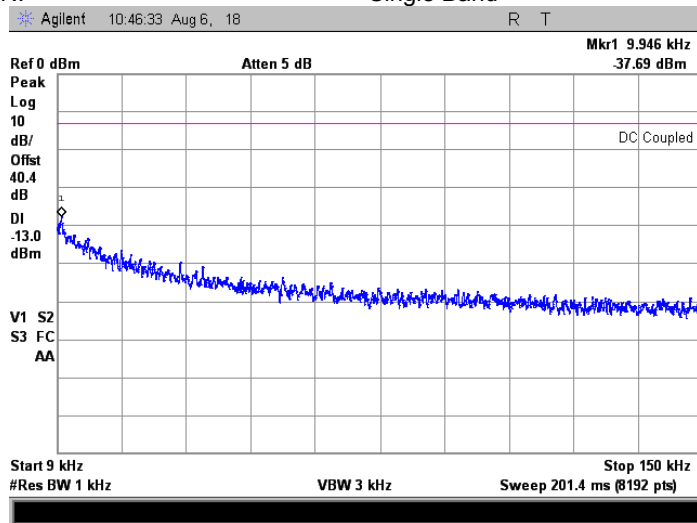

Plot 7.8.52 Spurious emission measurements in 0.15 - 30.0 MHz range at low carrier frequency

FREQUENCY RANGE: 788 - 805 MHz
 OPERATIONAL MODE: iDEN QAM uplink transmit
 INPUT PORT: Mobile
 INPUT POWER: -54 dBm
 CONFIGURATION: Single Band

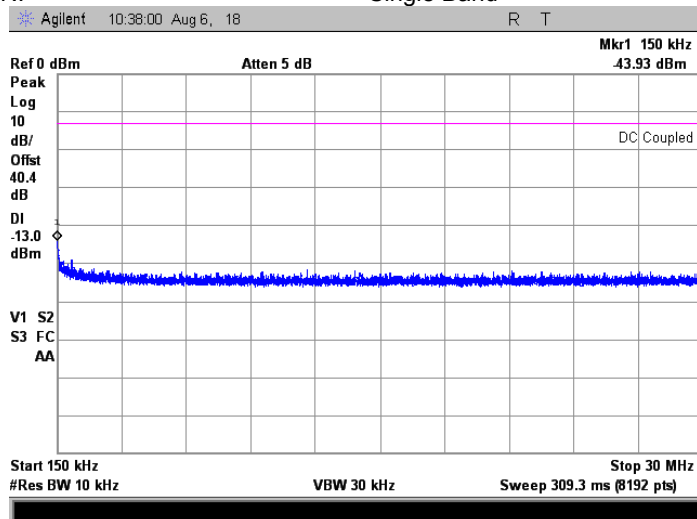

Test specification:		Section 90.219(e)(3), Conducted spurious emissions	
Test procedure:		47 CFR, Sections 2.1051; KDB 935210 D02 v02, Appendix D	
Test mode:		Compliance	
Date(s):		06-Aug-14 - 10-Aug-14	
Temperature: 23.2 °C		Air Pressure: 1008 hPa	
		Relative Humidity: 46 %	
		Power Supply: 120 VAC	
Remarks:			
		Verdict: PASS	

Plot 7.8.53 Spurious emission measurements in 0.15 - 30.0 MHz range at mid carrier frequency

FREQUENCY RANGE: 788 - 805 MHz
 OPERATIONAL MODE: iDEN QAM uplink transmit
 INPUT PORT: Mobile
 INPUT POWER: -54 dBm
 CONFIGURATION: Single Band

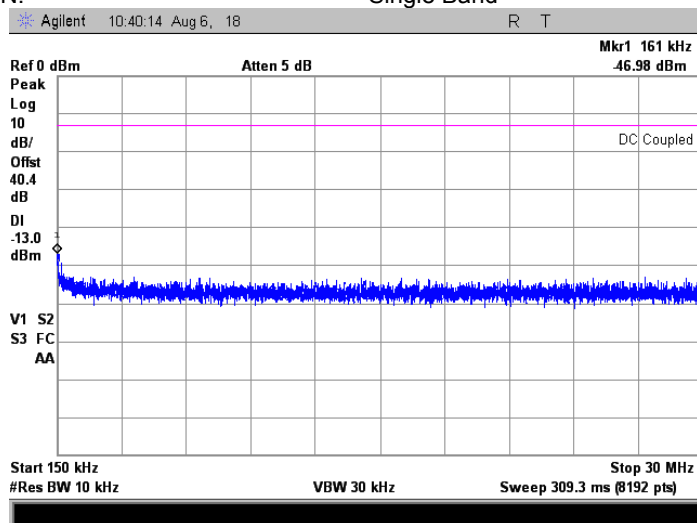

Plot 7.8.54 Spurious emission measurements in 0.15 - 30.0 MHz range at high carrier frequency

FREQUENCY RANGE: 788 - 805 MHz
 OPERATIONAL MODE: iDEN QAM uplink transmit
 INPUT PORT: Mobile
 INPUT POWER: -54 dBm
 CONFIGURATION: Single Band

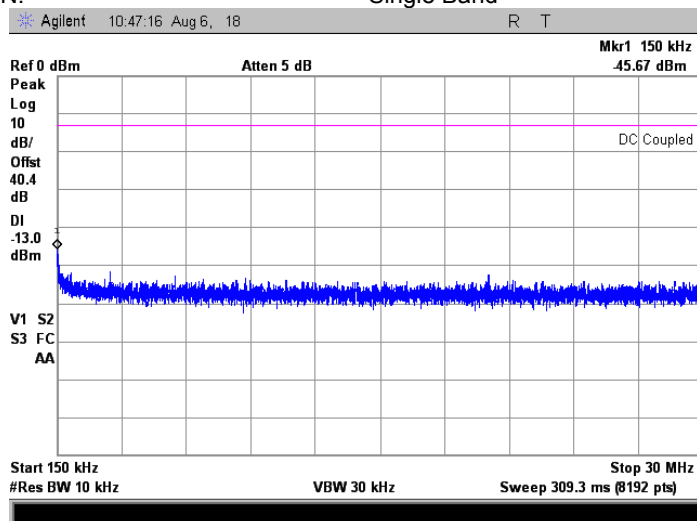

Test specification:		Section 90.219(e)(3), Conducted spurious emissions	
Test procedure:		47 CFR, Sections 2.1051; KDB 935210 D02 v02, Appendix D	
Test mode:		Verdict:	
Compliance		PASS	
Date(s):		06-Aug-14 - 10-Aug-14	
Temperature: 23.2 °C	Air Pressure: 1008 hPa	Relative Humidity: 46 %	Power Supply: 120 VAC
Remarks:			

Plot 7.8.55 Spurious emission measurements in 30.0 - 1000 MHz range at low carrier frequency

FREQUENCY RANGE: 788 - 805 MHz
 OPERATIONAL MODE: iDEN QAM uplink transmit
 INPUT PORT: Mobile
 INPUT POWER: -54 dBm
 CONFIGURATION: Single Band

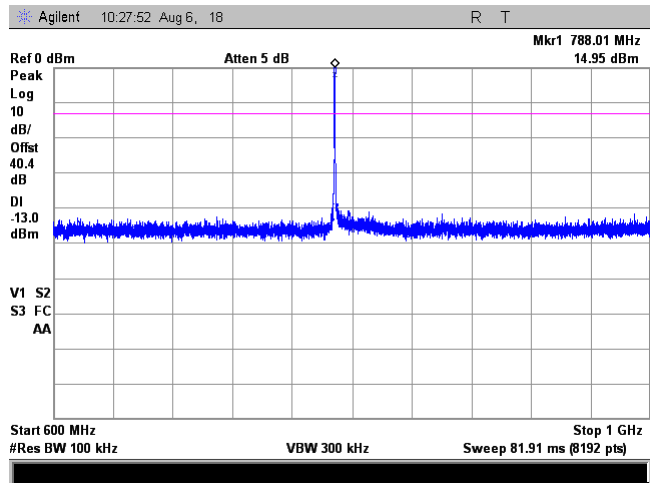
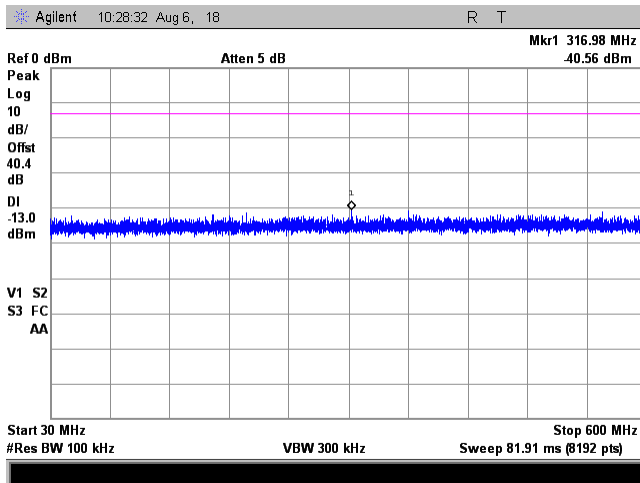

Plot 7.8.56 Spurious emission measurements in 30.0 - 1000 MHz range at mid carrier frequency

FREQUENCY RANGE: 788 - 805 MHz
 OPERATIONAL MODE: iDEN QAM uplink transmit
 INPUT PORT: Mobile
 INPUT POWER: -54 dBm
 CONFIGURATION: Single Band

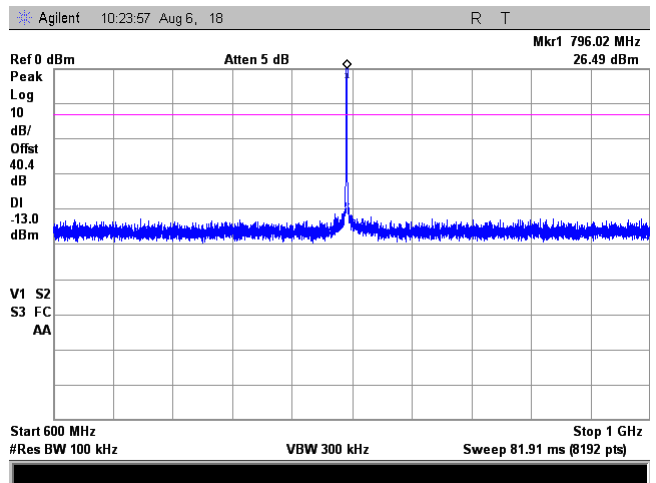
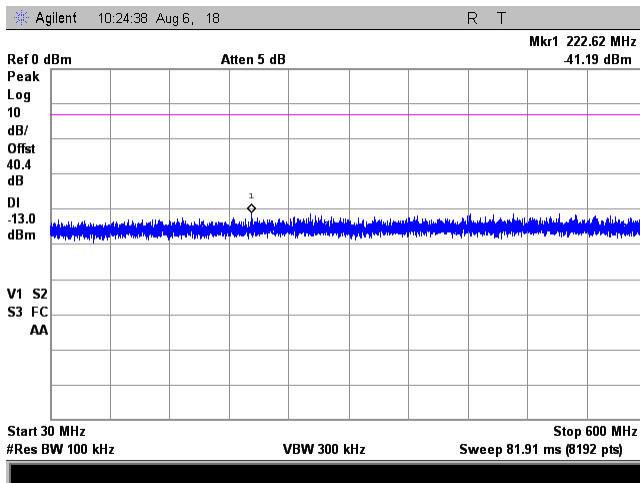

Test specification:		Section 90.219(e)(3), Conducted spurious emissions	
Test procedure:		47 CFR, Sections 2.1051; KDB 935210 D02 v02, Appendix D	
Test mode:		Verdict:	
Compliance		PASS	
Date(s):		06-Aug-14 - 10-Aug-14	
Temperature: 23.2 °C	Air Pressure: 1008 hPa	Relative Humidity: 46 %	Power Supply: 120 VAC
Remarks:			

Plot 7.8.57 Spurious emission measurements in 30.0 - 1000 MHz range at high carrier frequency

FREQUENCY RANGE: 788 - 805 MHz
 OPERATIONAL MODE: iDEN QAM uplink transmit
 INPUT PORT: Mobile
 INPUT POWER: -54 dBm
 CONFIGURATION: Single Band

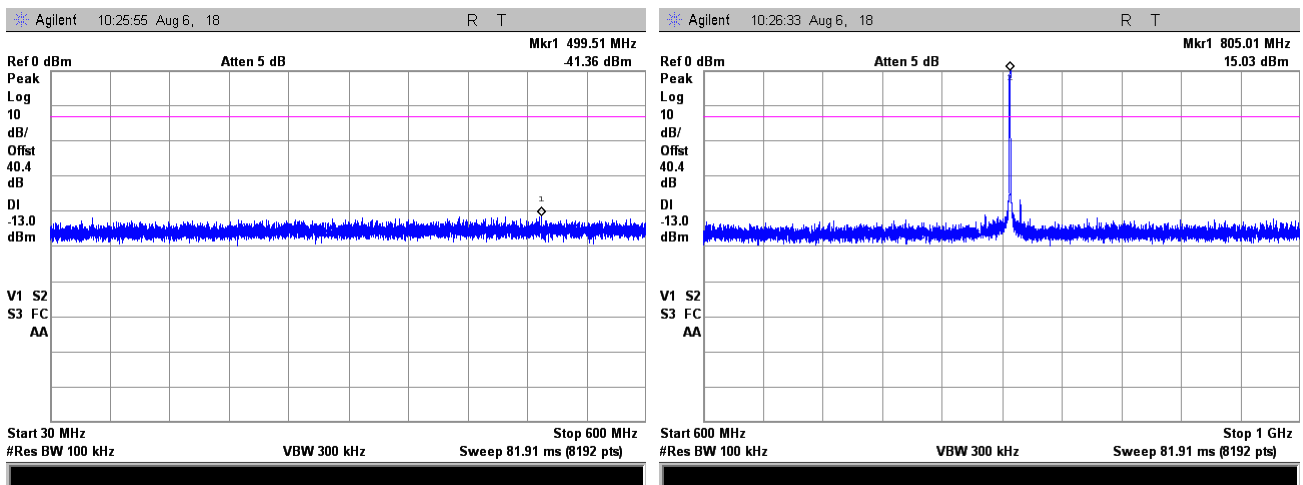

Plot 7.8.58 Spurious emission measurements in 1000 - 8100 MHz range at low carrier frequency

FREQUENCY RANGE: 788 - 805 MHz
 OPERATIONAL MODE: iDEN QAM uplink transmit
 INPUT PORT: Mobile
 INPUT POWER: -54 dBm
 CONFIGURATION: Single Band

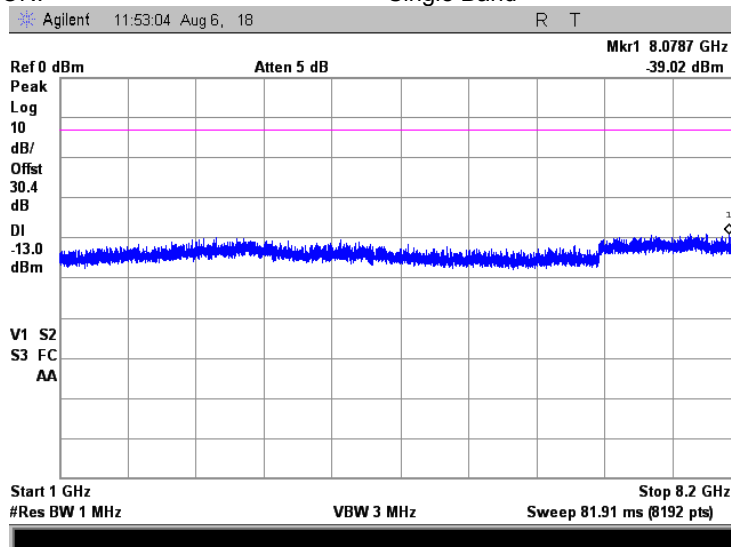

Test specification:		Section 90.219(e)(3), Conducted spurious emissions	
Test procedure:		47 CFR, Sections 2.1051; KDB 935210 D02 v02, Appendix D	
Test mode:		Compliance	
Date(s):		06-Aug-14 - 10-Aug-14	
Temperature: 23.2 °C		Air Pressure: 1008 hPa	
		Relative Humidity: 46 %	
		Power Supply: 120 VAC	
Remarks:			
		Verdict: PASS	

Plot 7.8.59 Spurious emission measurements in 1000 - 8100 MHz at mid carrier frequency

FREQUENCY RANGE: 788 - 805 MHz
 OPERATIONAL MODE: iDEN QAM uplink k transmit
 INPUT PORT: Mobile
 INPUT POWER: -54 dBm
 CONFIGURATION: Single Band

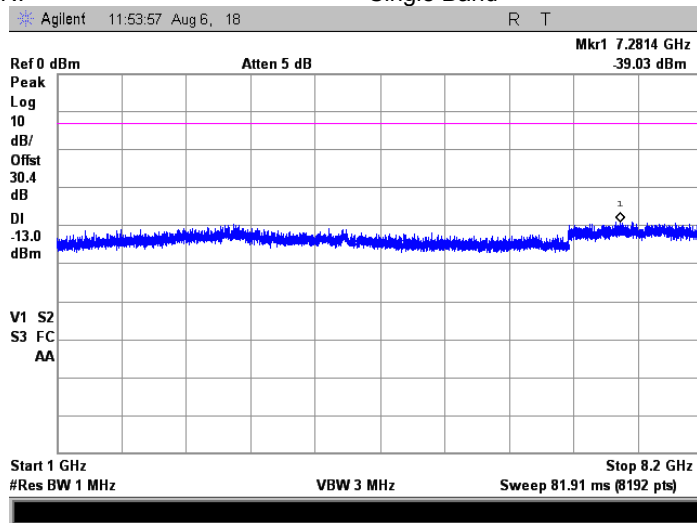

Plot 7.8.60 Spurious emission measurements in 1000 - 8100 MHz at high carrier frequency

FREQUENCY RANGE: 788 - 805 MHz
 OPERATIONAL MODE: iDEN QAM uplink transmit
 INPUT PORT: Mobile
 INPUT POWER: -54 dBm
 CONFIGURATION: Single Band

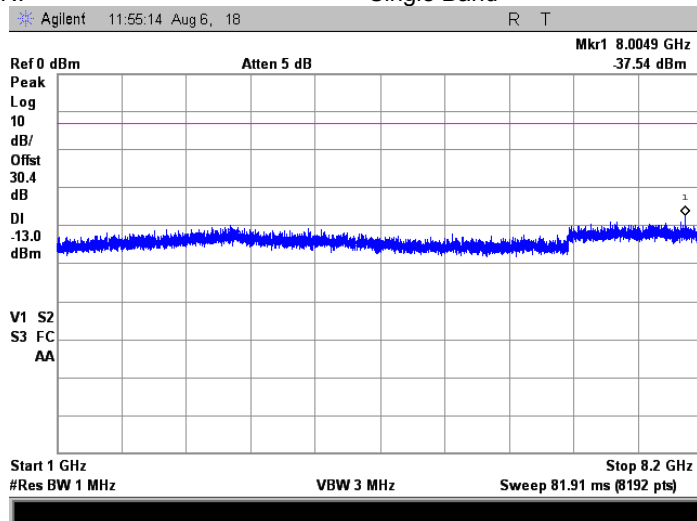

Test specification:		Section 90.219(e)(3), Conducted spurious emissions	
Test procedure:		47 CFR, Sections 2.1051; KDB 935210 D02 v02, Appendix D	
Test mode:		Compliance	
Date(s):		06-Aug-14 - 10-Aug-14	
Temperature: 23.2 °C		Air Pressure: 1008 hPa	
		Relative Humidity: 46 %	
		Power Supply: 120 VAC	
Remarks:			
		Verdict: PASS	

Plot 7.8.61 Spurious emission measurements in 9 - 150 kHz range at low carrier frequency

FREQUENCY RANGE: 788 - 805 MHz
 OPERATIONAL MODE: Analog FM uplink transmit
 INPUT PORT: Mobile
 INPUT POWER: -54 dBm
 CONFIGURATION: Single Band

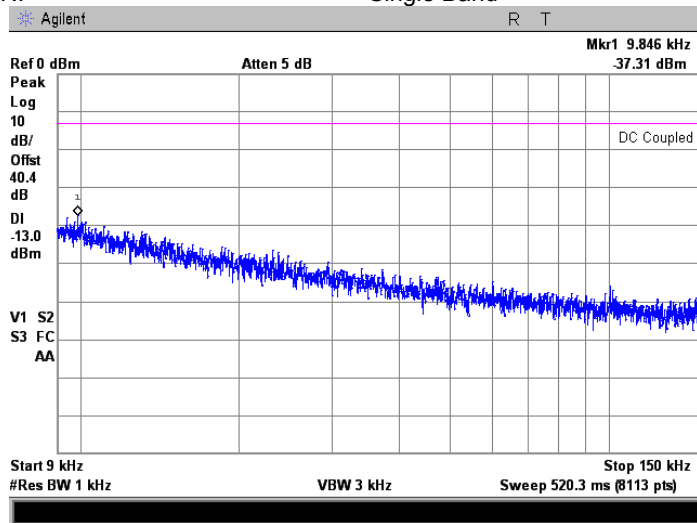

Plot 7.8.62 Spurious emission measurements in 9 - 150 kHz range at mid carrier frequency

FREQUENCY RANGE: 788 - 805 MHz
 OPERATIONAL MODE: Analog FM uplink transmit
 INPUT PORT: Mobile
 INPUT POWER: -54 dBm
 CONFIGURATION: Single Band

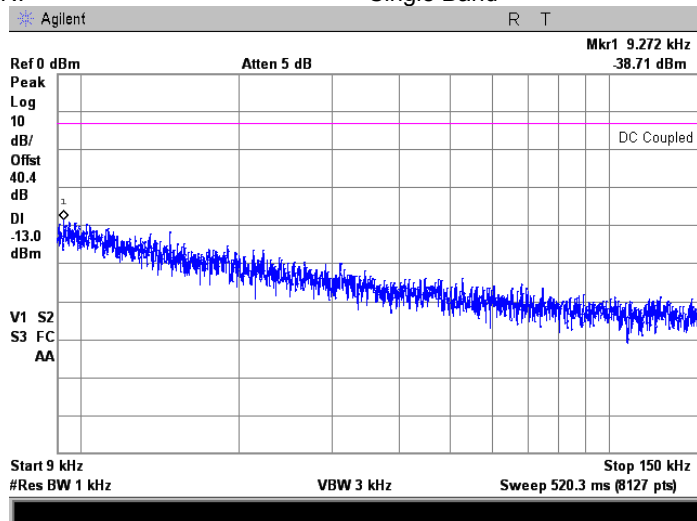

Test specification:	Section 90.219(e)(3), Conducted spurious emissions		
Test procedure:	47 CFR, Sections 2.1051; KDB 935210 D02 v02, Appendix D		
Test mode:	Compliance	Verdict:	PASS
Date(s):	06-Aug-14 - 10-Aug-14		
Temperature: 23.2 °C	Air Pressure: 1008 hPa	Relative Humidity: 46 %	Power Supply: 120 VAC
Remarks:			

Plot 7.8.63 Spurious emission measurements in 9 - 150 kHz range at high carrier frequency

FREQUENCY RANGE: 788 - 805 MHz
 OPERATIONAL MODE: Analog FM uplink transmit
 INPUT PORT: Mobile
 INPUT POWER: -54 dBm
 CONFIGURATION: Single Band

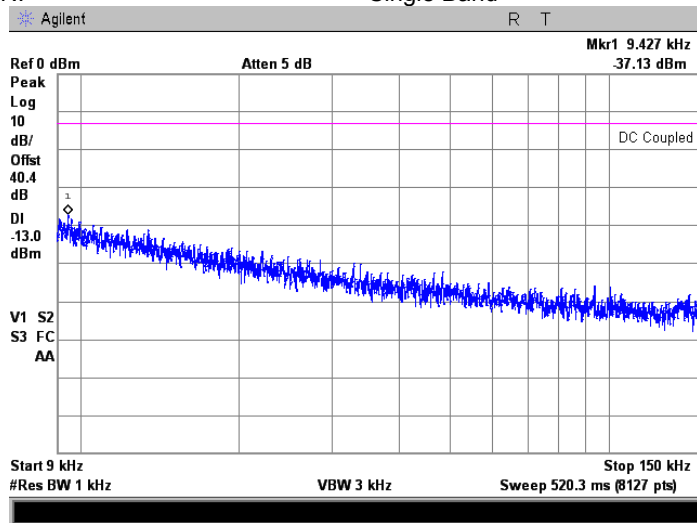

Plot 7.8.64 Spurious emission measurements in 0.15 - 30.0 MHz range at low carrier frequency

FREQUENCY RANGE: 788 - 805 MHz
 OPERATIONAL MODE: Analog FM uplink transmit
 INPUT PORT: Mobile
 INPUT POWER: -54 dBm
 CONFIGURATION: Single Band

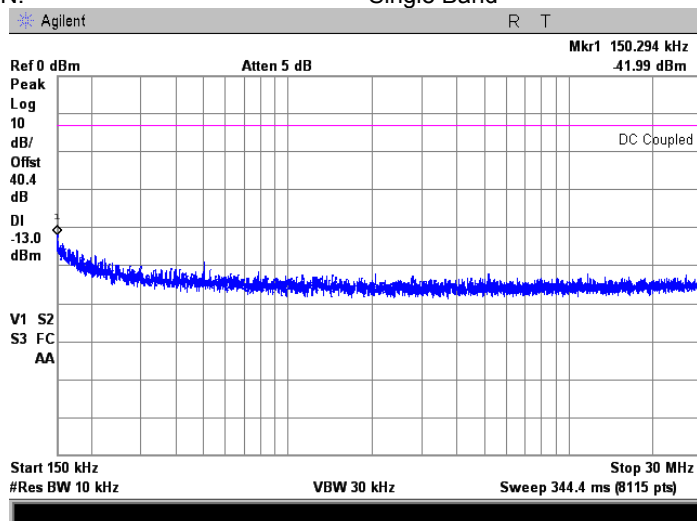

Test specification:		Section 90.219(e)(3), Conducted spurious emissions	
Test procedure:		47 CFR, Sections 2.1051; KDB 935210 D02 v02, Appendix D	
Test mode:		Compliance	
Date(s):		06-Aug-14 - 10-Aug-14	
Temperature: 23.2 °C		Air Pressure: 1008 hPa	
		Relative Humidity: 46 %	
		Power Supply: 120 VAC	
Remarks:			
		Verdict: PASS	

Plot 7.8.65 Spurious emission measurements in 0.15 - 30.0 MHz range at mid carrier frequency

FREQUENCY RANGE: 788 - 805 MHz
 OPERATIONAL MODE: Analog FM uplink transmit
 INPUT PORT: Mobile
 INPUT POWER: -54 dBm
 CONFIGURATION: Single Band

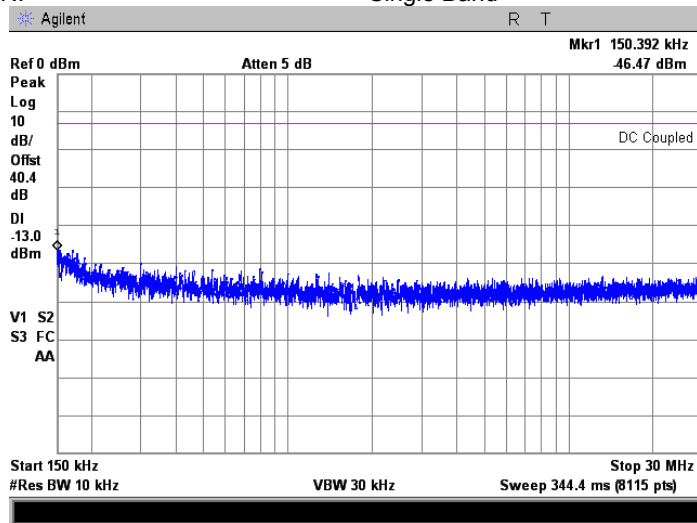

Plot 7.8.66 Spurious emission measurements in 0.15 - 30.0 MHz range at high carrier frequency

FREQUENCY RANGE: 788 - 805 MHz
 OPERATIONAL MODE: Analog FM uplink transmit
 INPUT PORT: Mobile
 INPUT POWER: -54 dBm
 CONFIGURATION: Single Band

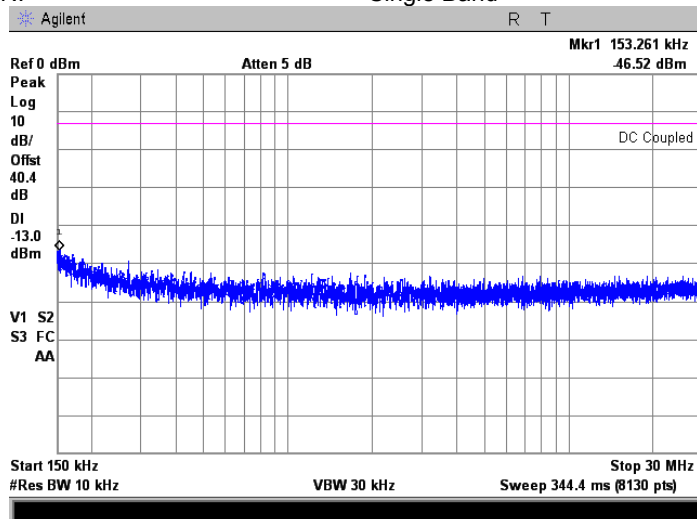

Test specification:		Section 90.219(e)(3), Conducted spurious emissions	
Test procedure:		47 CFR, Sections 2.1051; KDB 935210 D02 v02, Appendix D	
Test mode:		Verdict: PASS	
Date(s):		06-Aug-14 - 10-Aug-14	
Temperature: 23.2 °C	Air Pressure: 1008 hPa	Relative Humidity: 46 %	Power Supply: 120 VAC
Remarks:			

Plot 7.8.67 Spurious emission measurements in 30.0 - 1000 MHz range at low carrier frequency

FREQUENCY RANGE: 788 - 805 MHz
 OPERATIONAL MODE: Analog FM uplink transmit
 INPUT PORT: Mobile
 INPUT POWER: -54 dBm
 CONFIGURATION: Single Band

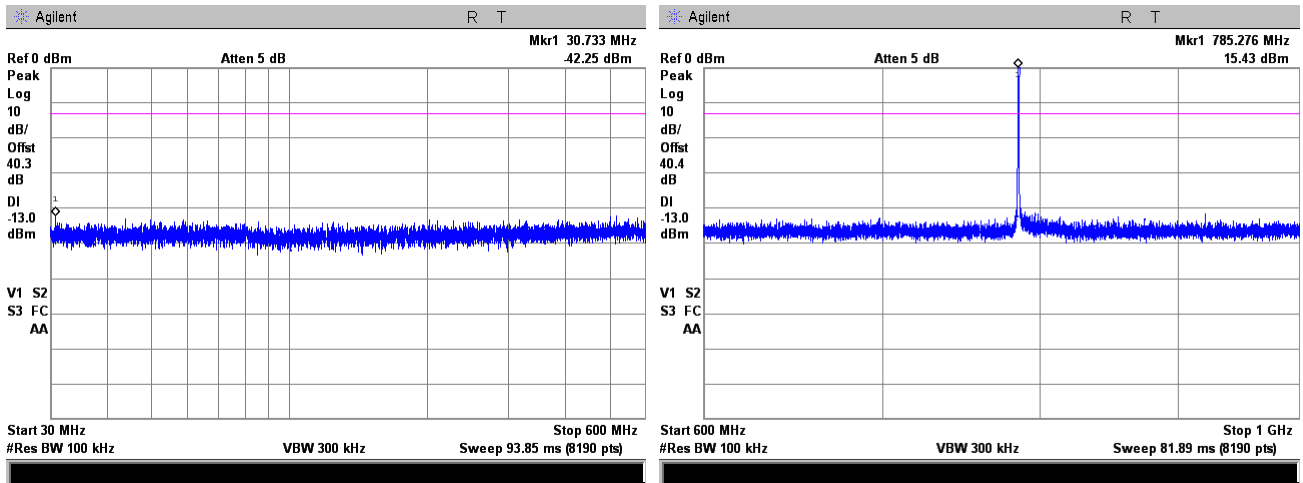

Plot 7.8.68 Spurious emission measurements in 30.0 - 1000 MHz range at mid carrier frequency

FREQUENCY RANGE: 788 - 805 MHz
 OPERATIONAL MODE: Analog FM uplink transmit
 INPUT PORT: Mobile
 INPUT POWER: -54 dBm
 CONFIGURATION: Single Band

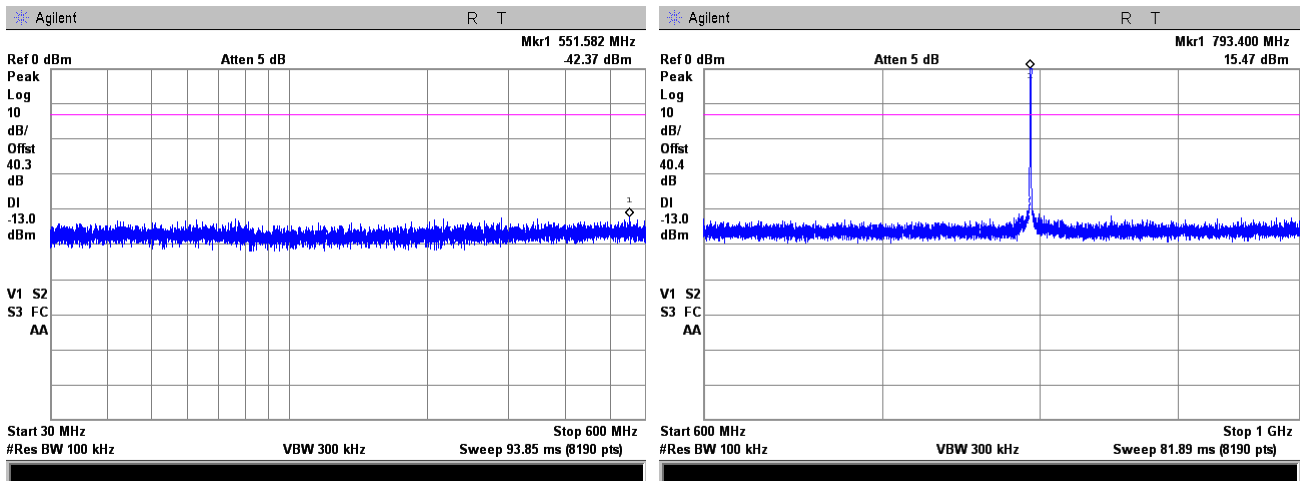

Test specification:		Section 90.219(e)(3), Conducted spurious emissions	
Test procedure:		47 CFR, Sections 2.1051; KDB 935210 D02 v02, Appendix D	
Test mode:		Compliance	
Date(s):		06-Aug-14 - 10-Aug-14	
Temperature: 23.2 °C		Air Pressure: 1008 hPa	
		Relative Humidity: 46 %	
		Power Supply: 120 VAC	
Remarks:			
		Verdict: PASS	

Plot 7.8.69 Spurious emission measurements in 30.0 - 1000 MHz range at high carrier frequency

FREQUENCY RANGE: 788 - 805 MHz
 OPERATIONAL MODE: Analog FM uplink transmit
 INPUT PORT: Mobile
 INPUT POWER: -54 dBm
 CONFIGURATION: Single Band

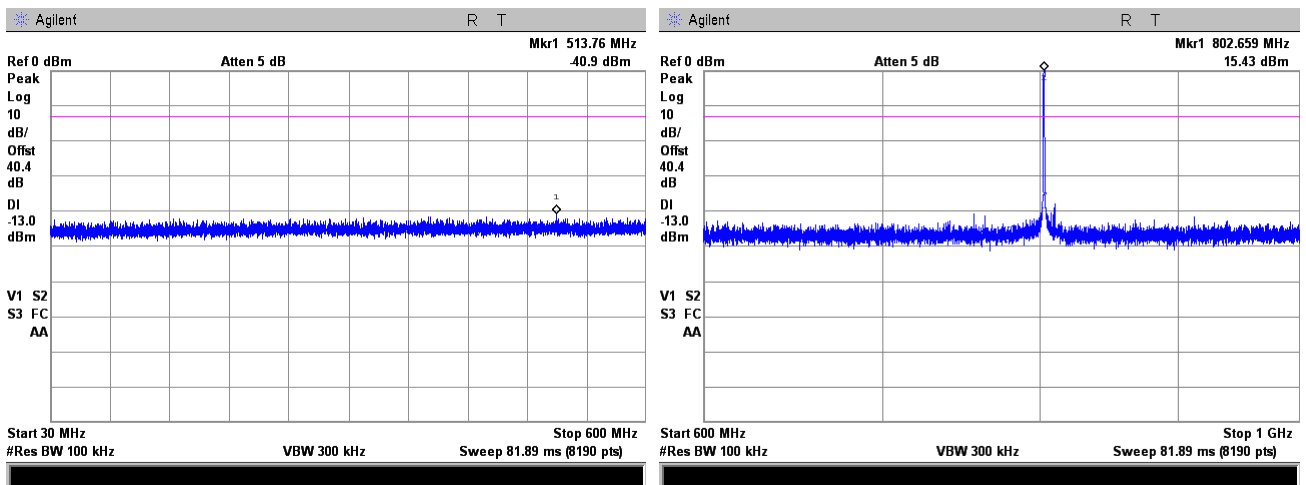

Plot 7.8.70 Spurious emission measurements in 1000 - 8100 MHz range at low carrier frequency

FREQUENCY RANGE: 788 - 805 MHz
 OPERATIONAL MODE: Analog FM uplink transmit
 INPUT PORT: Mobile
 INPUT POWER: -54 dBm
 CONFIGURATION: Single Band

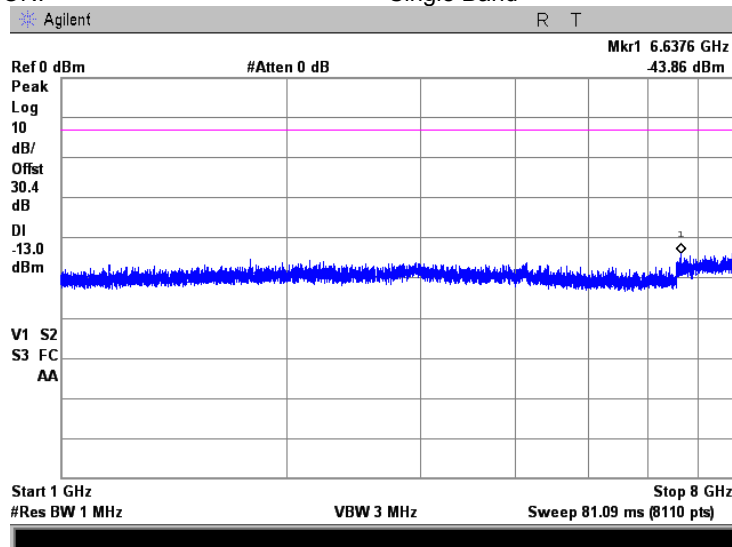

Test specification:		Section 90.219(e)(3), Conducted spurious emissions	
Test procedure:		47 CFR, Sections 2.1051; KDB 935210 D02 v02, Appendix D	
Test mode:		Compliance	
Date(s):		06-Aug-14 - 10-Aug-14	
Temperature: 23.2 °C		Air Pressure: 1008 hPa	
		Relative Humidity: 46 %	
		Power Supply: 120 VAC	
Remarks:			
		Verdict: PASS	

Plot 7.8.71 Spurious emission measurements in 1000 - 8100 MHz at mid carrier frequency

FREQUENCY RANGE: 788 - 805 MHz
 OPERATIONAL MODE: Analog FM uplink transmit
 INPUT PORT: Mobile
 INPUT POWER: -54 dBm
 CONFIGURATION: Single Band

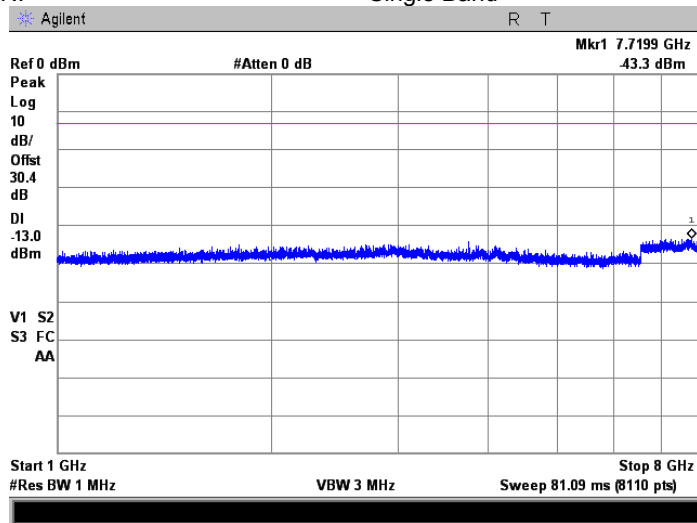

Plot 7.8.72 Spurious emission measurements in 1000 - 8100 MHz at high carrier frequency

FREQUENCY RANGE: 788 - 805 MHz
 OPERATIONAL MODE: Analog FM uplink transmit
 INPUT PORT: Mobile
 INPUT POWER: -54 dBm
 CONFIGURATION: Single Band

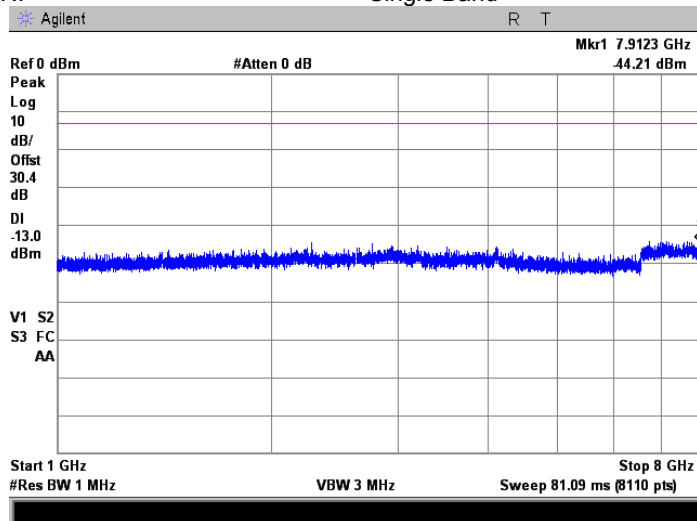

Test specification:		Section 90.219(e)(3), Conducted spurious emissions	
Test procedure:		47 CFR, Sections 2.1051; KDB 935210 D02 v02, Appendix D	
Test mode:		Compliance	
Date(s):		06-Aug-14 - 10-Aug-14	
Temperature: 23.2 °C		Air Pressure: 1008 hPa	
		Relative Humidity: 46 %	
		Power Supply: 120 VAC	
Remarks:			
		Verdict: PASS	

Plot 7.8.73 Spurious emission measurements in 9 - 150 kHz range at low carrier frequency

FREQUENCY RANGE: 851 - 861 MHz
 OPERATIONAL MODE: C4FM downlink transmit
 INPUT PORT: Base
 INPUT POWER: -51 dBm
 CONFIGURATION: Single Band

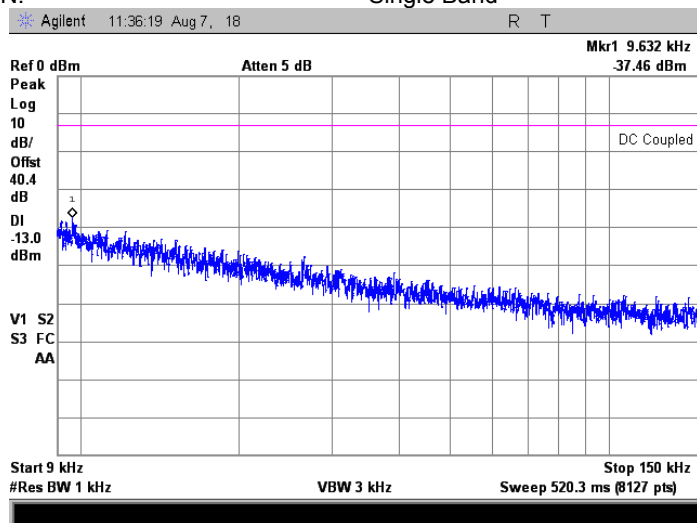

Plot 7.8.74 Spurious emission measurements in 9 - 150 kHz range at mid carrier frequency

FREQUENCY RANGE: 851 - 861 MHz
 OPERATIONAL MODE: C4FM downlink transmit
 INPUT PORT: Base
 INPUT POWER: -51 dBm
 CONFIGURATION: Single Band

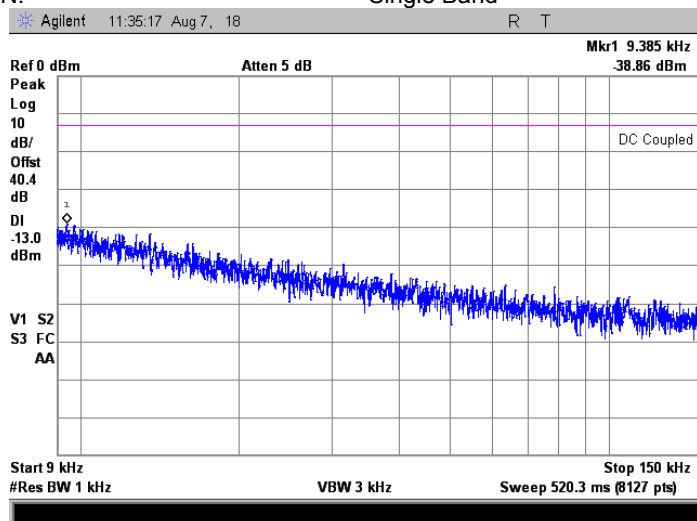

Test specification:		Section 90.219(e)(3), Conducted spurious emissions	
Test procedure:		47 CFR, Sections 2.1051; KDB 935210 D02 v02, Appendix D	
Test mode:		Compliance	
Date(s):		06-Aug-14 - 10-Aug-14	
Temperature: 23.2 °C		Air Pressure: 1008 hPa	
		Relative Humidity: 46 %	
		Power Supply: 120 VAC	
Remarks:			
		Verdict: PASS	

Plot 7.8.75 Spurious emission measurements in 9 - 150 kHz range at high carrier frequency

FREQUENCY RANGE: 851 - 861 MHz
 OPERATIONAL MODE: C4FM downlink transmit
 INPUT PORT: Base
 INPUT POWER: -51 dBm
 CONFIGURATION: Single Band

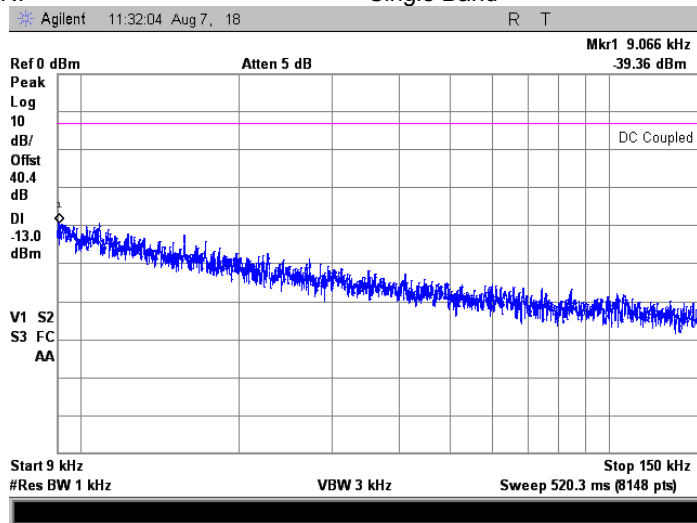

Plot 7.8.76 Spurious emission measurements in 0.15 – 30.0 MHz range at low carrier frequency

FREQUENCY RANGE: 851 - 861 MHz
 OPERATIONAL MODE: C4FM downlink transmit
 INPUT PORT: Base
 INPUT POWER: -51 dBm
 CONFIGURATION: Single Band

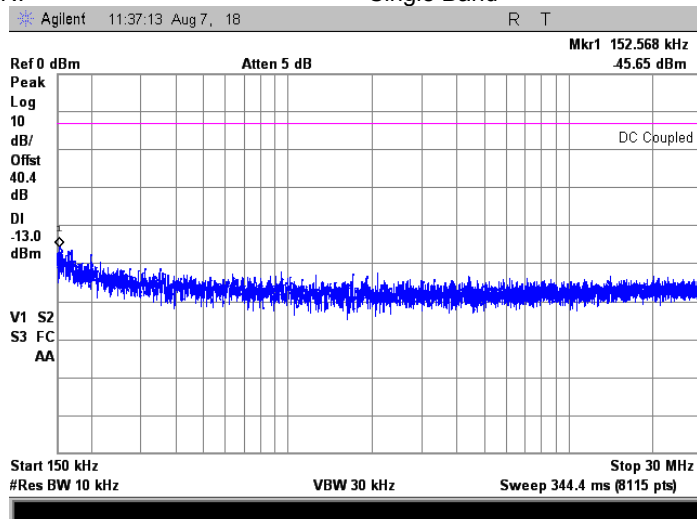

Test specification:		Section 90.219(e)(3), Conducted spurious emissions	
Test procedure:		47 CFR, Sections 2.1051; KDB 935210 D02 v02, Appendix D	
Test mode:		Compliance	
Date(s):		06-Aug-14 - 10-Aug-14	
Temperature: 23.2 °C		Air Pressure: 1008 hPa	
		Relative Humidity: 46 %	
		Power Supply: 120 VAC	
Remarks:			
		Verdict: PASS	

Plot 7.8.77 Spurious emission measurements in 0.15 – 30.0 MHz range at mid carrier frequency

FREQUENCY RANGE: 851 - 861 MHz
 OPERATIONAL MODE: C4FM downlink transmit
 INPUT PORT: Base
 INPUT POWER: -51 dBm
 CONFIGURATION: Single Band

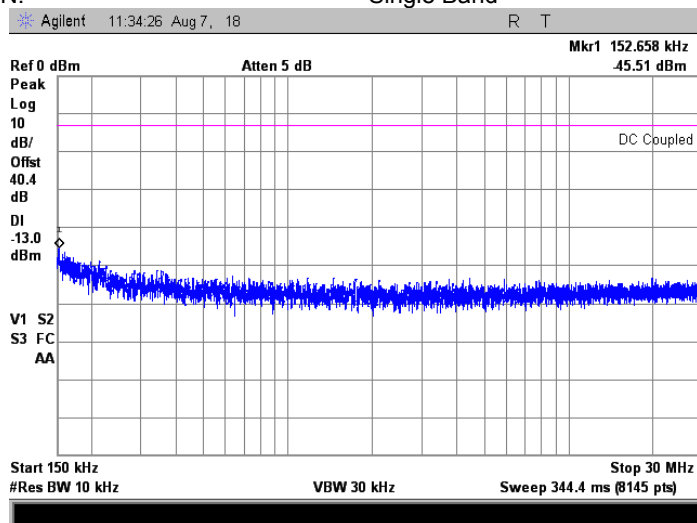

Plot 7.8.78 Spurious emission measurements in 0.15 – 30.0 MHz range at high carrier frequency

FREQUENCY RANGE: 851 - 861 MHz
 OPERATIONAL MODE: C4FM downlink transmit
 INPUT PORT: Base
 INPUT POWER: -51 dBm
 CONFIGURATION: Single Band

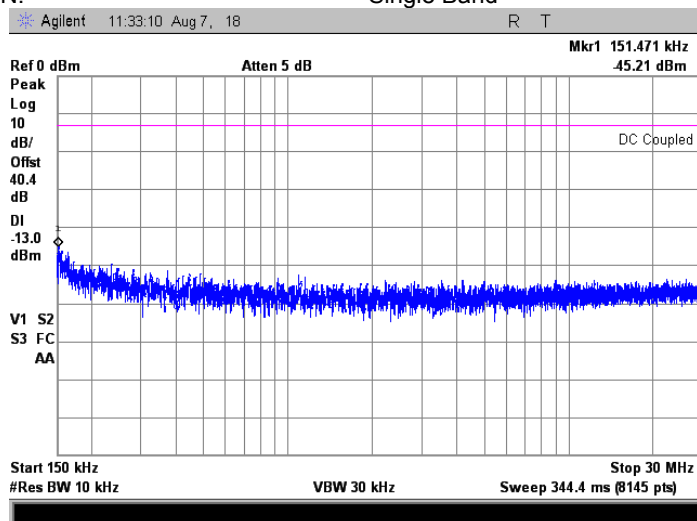

Test specification:		Section 90.219(e)(3), Conducted spurious emissions	
Test procedure:		47 CFR, Sections 2.1051; KDB 935210 D02 v02, Appendix D	
Test mode:		Verdict:	
Compliance		PASS	
Date(s):		06-Aug-14 - 10-Aug-14	
Temperature: 23.2 °C	Air Pressure: 1008 hPa	Relative Humidity: 46 %	Power Supply: 120 VAC
Remarks:			

Plot 7.8.79 Spurious emission measurements in 30.0 - 1000 MHz range at low carrier frequency

FREQUENCY RANGE:
OPERATIONAL MODE:
INPUT PORT:
INPUT POWER:
CONFIGURATION:

851 - 861 MHz
C4FM downlink transmit
Base
-51 dBm
Single Band

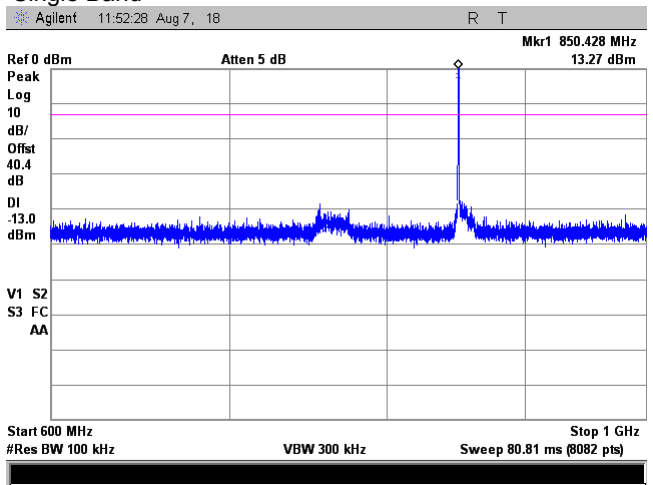
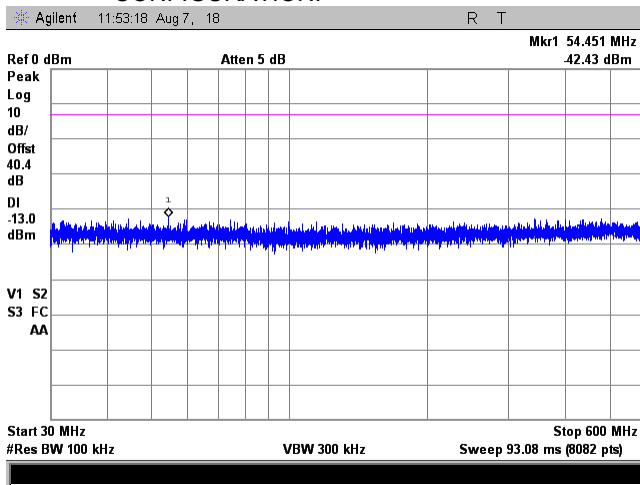

Plot 7.8.80 Spurious emission measurements in 30.0 - 1000 MHz range at mid carrier frequency

FREQUENCY RANGE:
OPERATIONAL MODE:
INPUT PORT:
INPUT POWER:
CONFIGURATION:

851 - 861 MHz
C4FM downlink transmit
Base
-51 dBm
Single Band

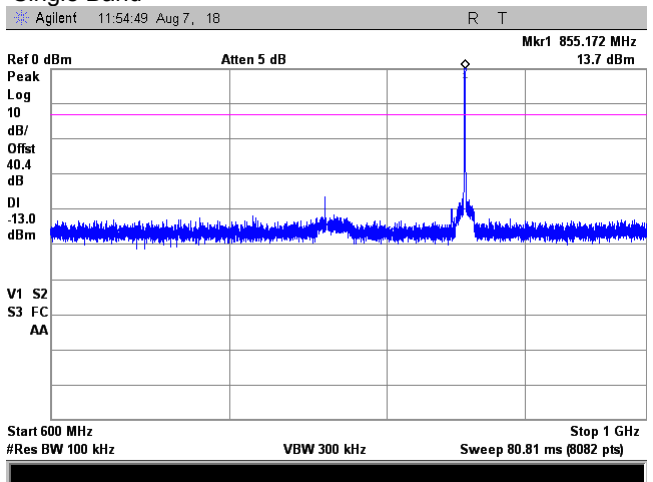
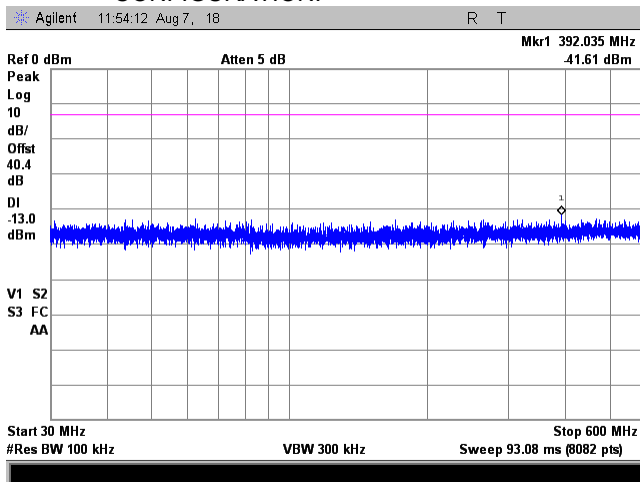

Test specification:		Section 90.219(e)(3), Conducted spurious emissions	
Test procedure:		47 CFR, Sections 2.1051; KDB 935210 D02 v02, Appendix D	
Test mode:		Verdict: PASS	
Date(s):		06-Aug-14 - 10-Aug-14	
Temperature: 23.2 °C	Air Pressure: 1008 hPa	Relative Humidity: 46 %	Power Supply: 120 VAC
Remarks:			

Plot 7.8.81 Spurious emission measurements in 30.0 - 1000 MHz range at high carrier frequency

FREQUENCY RANGE: 851 - 861 MHz
 OPERATIONAL MODE: C4FM downlink transmit
 INPUT PORT: Base
 INPUT POWER: -51 dBm
 CONFIGURATION: Single Band

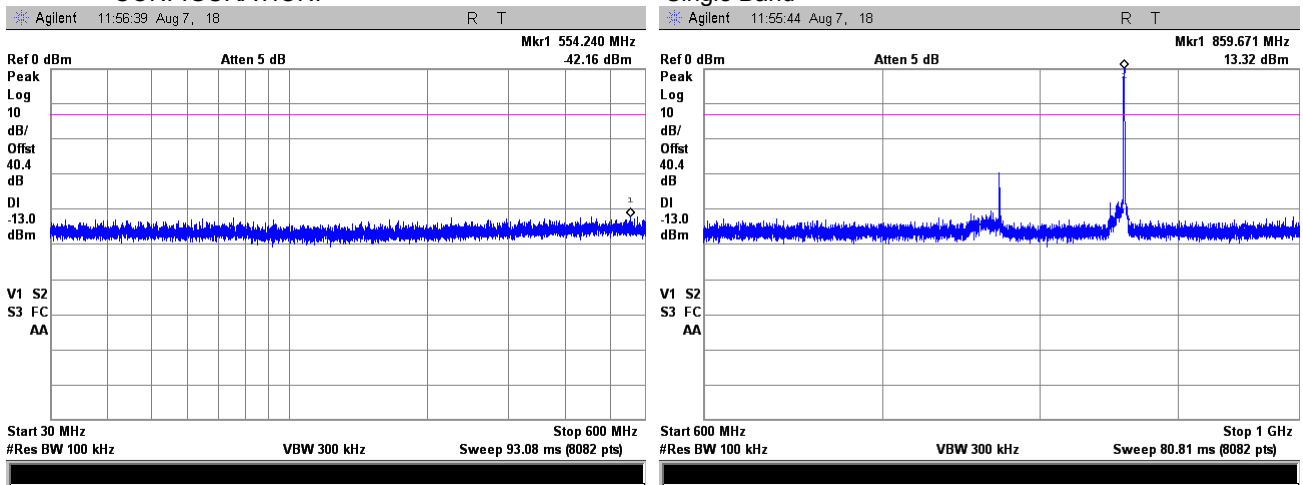

Plot 7.8.82 Spurious emission measurements in 1000 - 9000 MHz range at low carrier frequency

FREQUENCY RANGE: 851 - 861 MHz
 OPERATIONAL MODE: C4FM downlink transmit
 INPUT PORT: Base
 INPUT POWER: -51 dBm
 CONFIGURATION: Single Band

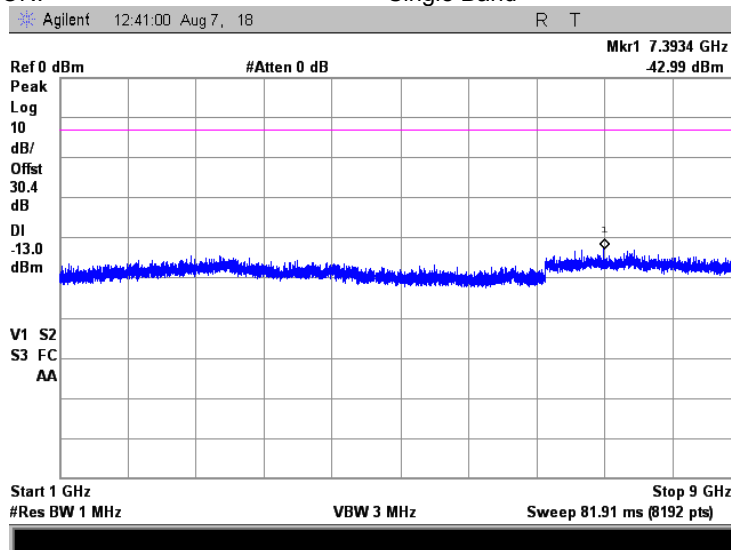

Test specification:		Section 90.219(e)(3), Conducted spurious emissions	
Test procedure:		47 CFR, Sections 2.1051; KDB 935210 D02 v02, Appendix D	
Test mode:		Compliance	
Date(s):		06-Aug-14 - 10-Aug-14	
Temperature: 23.2 °C		Air Pressure: 1008 hPa	
		Relative Humidity: 46 %	
		Power Supply: 120 VAC	
Remarks:			
		Verdict: PASS	

Plot 7.8.83 Spurious emission measurements in 1000 - 9000 MHz at mid carrier frequency

FREQUENCY RANGE: 851 - 861 MHz
 OPERATIONAL MODE: C4FM downlink transmit
 INPUT PORT: Base
 INPUT POWER: -51 dBm
 CONFIGURATION: Single Band

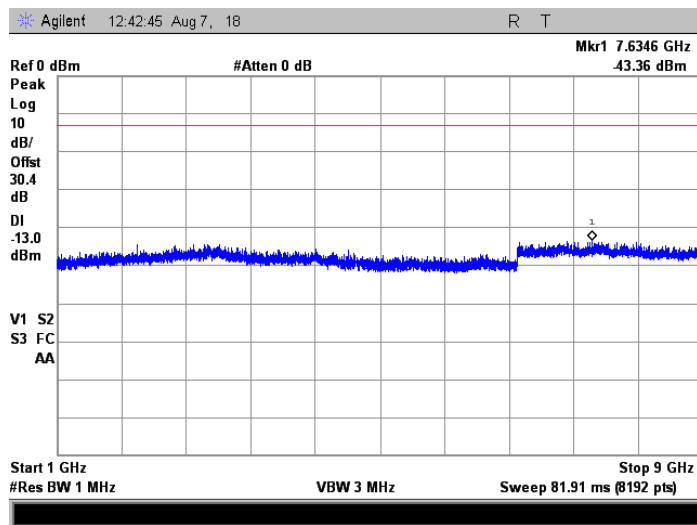

Plot 7.8.84 Spurious emission measurements in 1000 - 9000 MHz at high carrier frequency

FREQUENCY RANGE: 851 - 861 MHz
 OPERATIONAL MODE: C4FM downlink transmit
 INPUT PORT: Base
 INPUT POWER: -51 dBm
 CONFIGURATION: Single Band

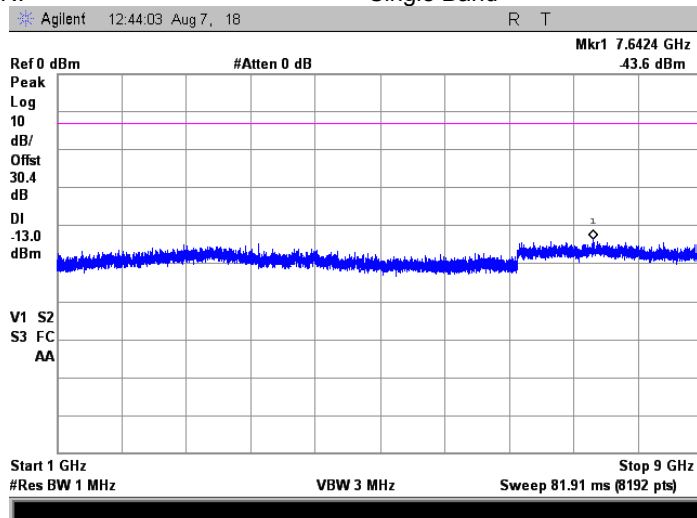

Test specification:		Section 90.219(e)(3), Conducted spurious emissions	
Test procedure:		47 CFR, Sections 2.1051; KDB 935210 D02 v02, Appendix D	
Test mode:		Compliance	
Date(s):		06-Aug-14 - 10-Aug-14	
Temperature: 23.2 °C		Air Pressure: 1008 hPa	
		Relative Humidity: 46 %	
		Power Supply: 120 VAC	
Remarks:			
		Verdict: PASS	

Plot 7.8.85 Spurious emission measurements in 9 - 150 kHz range at low carrier frequency

FREQUENCY RANGE: 851 - 861 MHz
 OPERATIONAL MODE: iDEN QAM downlink transmit
 INPUT PORT: Base
 INPUT POWER: -51 dBm
 CONFIGURATION: Single Band

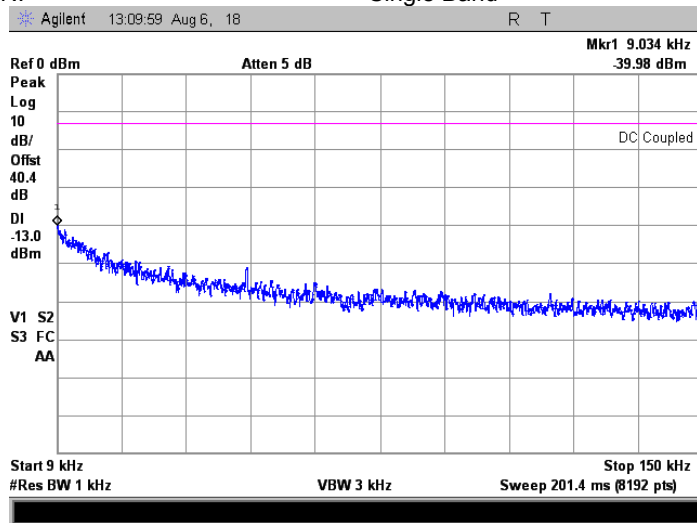

Plot 7.8.86 Spurious emission measurements in 9 - 150 kHz range at mid carrier frequency

FREQUENCY RANGE: 851 - 861 MHz
 OPERATIONAL MODE: iDEN QAM downlink transmit
 INPUT PORT: Base
 INPUT POWER: -51 dBm
 CONFIGURATION: Single Band

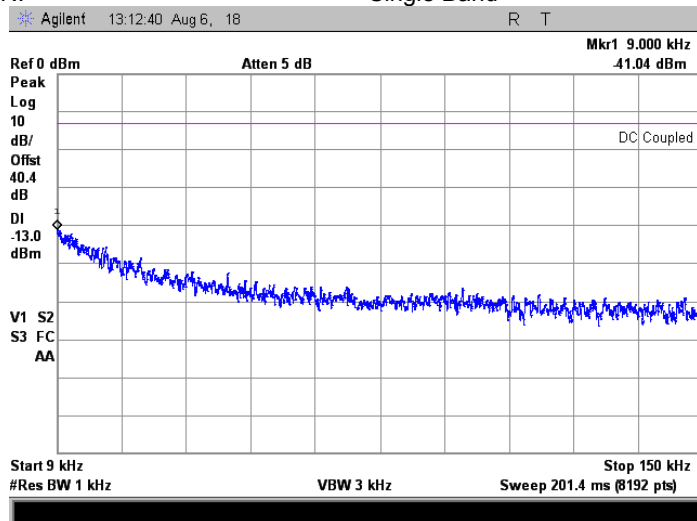

Test specification:		Section 90.219(e)(3), Conducted spurious emissions	
Test procedure:		47 CFR, Sections 2.1051; KDB 935210 D02 v02, Appendix D	
Test mode:		Compliance	
Date(s):		06-Aug-14 - 10-Aug-14	
Temperature: 23.2 °C		Air Pressure: 1008 hPa	
		Relative Humidity: 46 %	
		Power Supply: 120 VAC	
Remarks:			
		Verdict: PASS	

Plot 7.8.87 Spurious emission measurements in 9 - 150 kHz range at high carrier frequency

FREQUENCY RANGE: 851 - 861 MHz
 OPERATIONAL MODE: iDEN QAM downlink transmit
 INPUT PORT: Base
 INPUT POWER: -51 dBm
 CONFIGURATION: Single Band

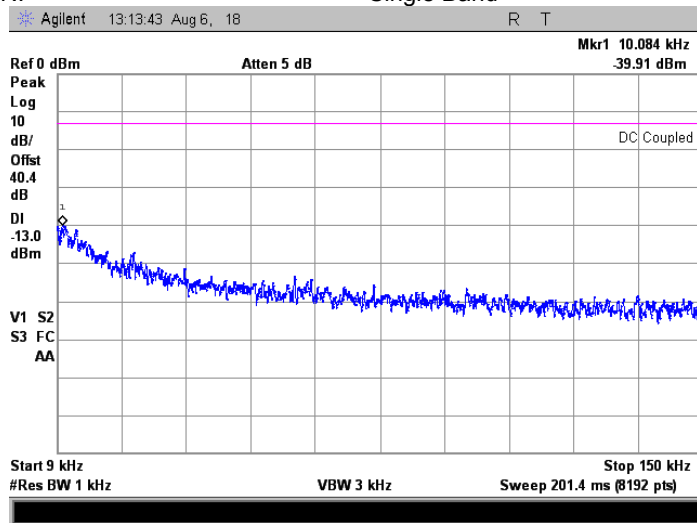

Plot 7.8.88 Spurious emission measurements in 0.15 - 30.0 MHz range at low carrier frequency

FREQUENCY RANGE: 851 - 861 MHz
 OPERATIONAL MODE: iDEN QAM downlink transmit
 INPUT PORT: Base
 INPUT POWER: -51 dBm
 CONFIGURATION: Single Band

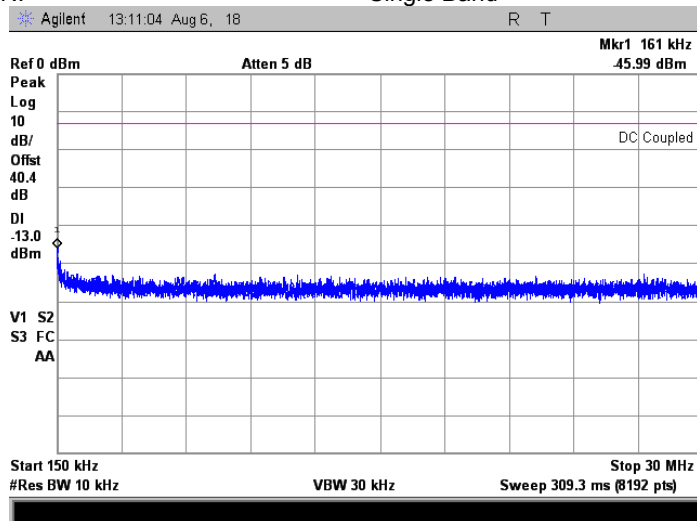

Test specification:		Section 90.219(e)(3), Conducted spurious emissions	
Test procedure:		47 CFR, Sections 2.1051; KDB 935210 D02 v02, Appendix D	
Test mode:		Compliance	
Date(s):		06-Aug-14 - 10-Aug-14	
Temperature: 23.2 °C		Air Pressure: 1008 hPa	
		Relative Humidity: 46 %	
		Power Supply: 120 VAC	
Remarks:			
		Verdict: PASS	

Plot 7.8.89 Spurious emission measurements in 0.15 - 30.0 MHz range at mid carrier frequency

FREQUENCY RANGE: 851 - 861 MHz
 OPERATIONAL MODE: iDEN QAM downlink transmit
 INPUT PORT: Base
 INPUT POWER: -51 dBm
 CONFIGURATION: Single Band

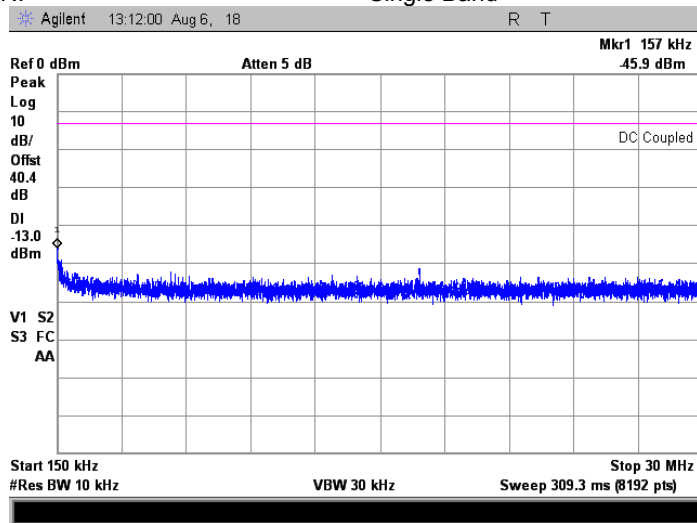

Plot 7.8.90 Spurious emission measurements in 0.15 - 30.0 MHz range at high carrier frequency

FREQUENCY RANGE: 851 - 861 MHz
 OPERATIONAL MODE: iDEN QAM downlink transmit
 INPUT PORT: Base
 INPUT POWER: -51 dBm
 CONFIGURATION: Single Band

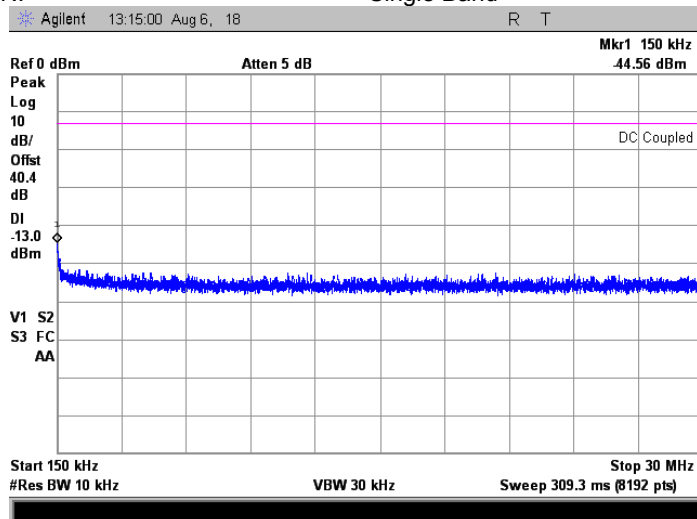

Test specification:		Section 90.219(e)(3), Conducted spurious emissions	
Test procedure:		47 CFR, Sections 2.1051; KDB 935210 D02 v02, Appendix D	
Test mode:		Verdict: PASS	
Date(s):		06-Aug-14 - 10-Aug-14	
Temperature: 23.2 °C	Air Pressure: 1008 hPa	Relative Humidity: 46 %	Power Supply: 120 VAC
Remarks:			

Plot 7.8.91 Spurious emission measurements in 30.0 - 1000 MHz range at low carrier frequency

FREQUENCY RANGE: 851 - 861 MHz
 OPERATIONAL MODE: iDEN QAM downlink transmit
 INPUT PORT: Base
 INPUT POWER: -51 dBm
 CONFIGURATION: Single Band

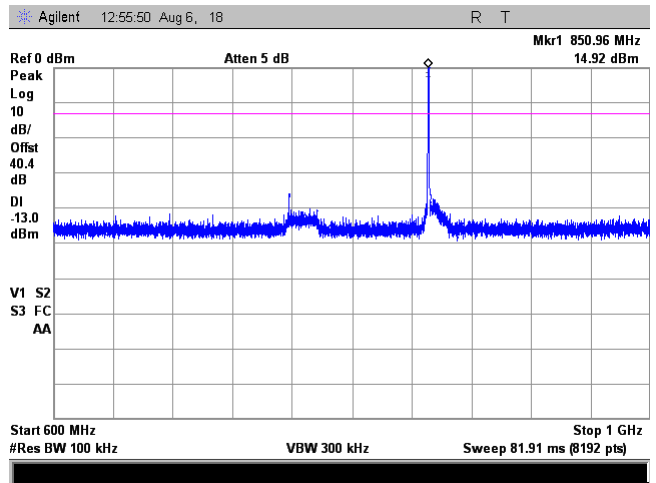
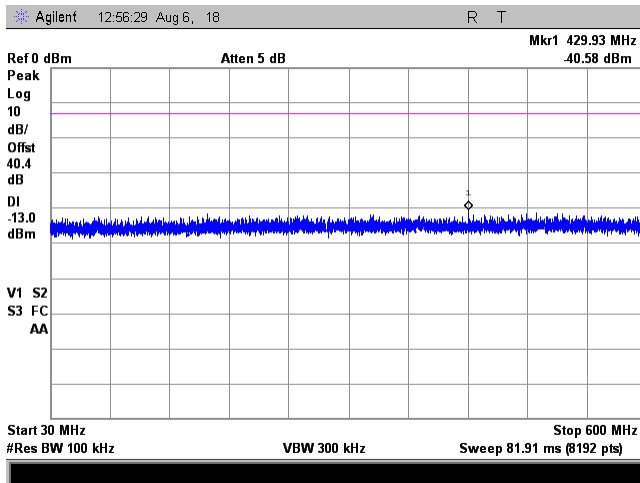

Plot 7.8.92 Spurious emission measurements in 30.0 - 1000 MHz range at mid carrier frequency

FREQUENCY RANGE: 851 - 861 MHz
 OPERATIONAL MODE: iDEN QAM downlink transmit
 INPUT PORT: Base
 INPUT POWER: -51 dBm
 CONFIGURATION: Single Band

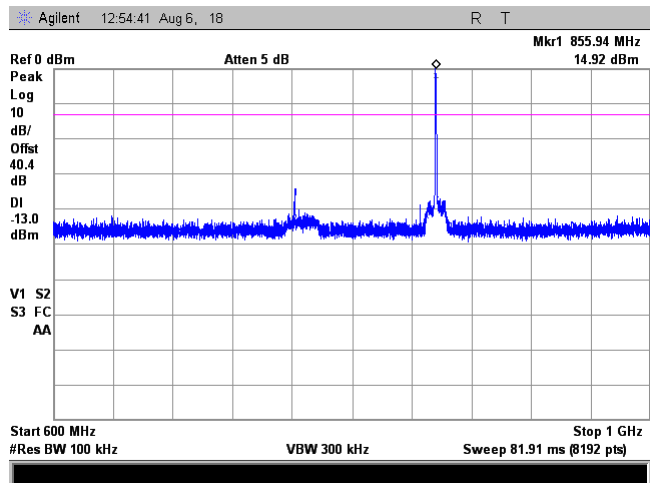
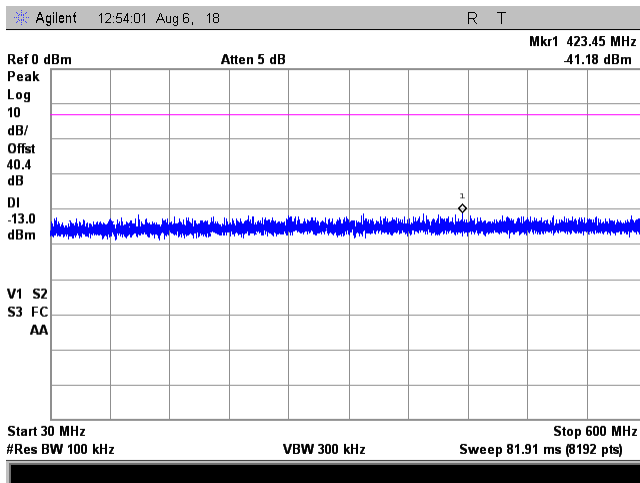

Test specification:		Section 90.219(e)(3), Conducted spurious emissions	
Test procedure:		47 CFR, Sections 2.1051; KDB 935210 D02 v02, Appendix D	
Test mode:		Compliance	
Date(s):		06-Aug-14 - 10-Aug-14	
Temperature: 23.2 °C		Air Pressure: 1008 hPa	
Relative Humidity: 46 %		Power Supply: 120 VAC	
Remarks:			
		Verdict: PASS	

Plot 7.8.93 Spurious emission measurements in 30.0 - 1000 MHz range at high carrier frequency

FREQUENCY RANGE: 851 - 861 MHz
 OPERATIONAL MODE: iDEN QAM downlink transmit
 INPUT PORT: Base
 INPUT POWER: -51 dBm
 CONFIGURATION: Single Band

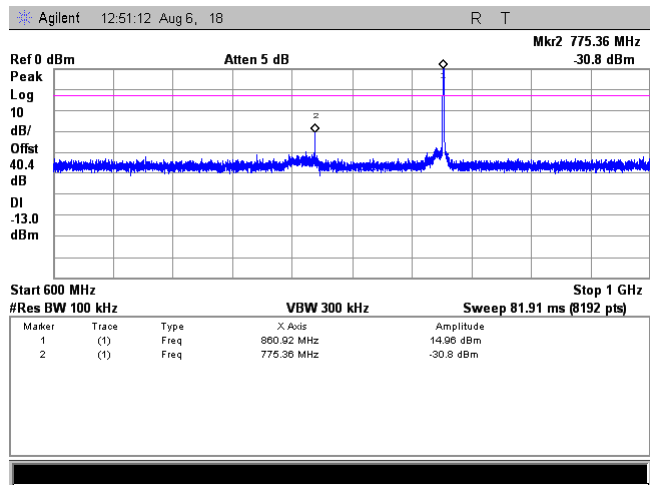
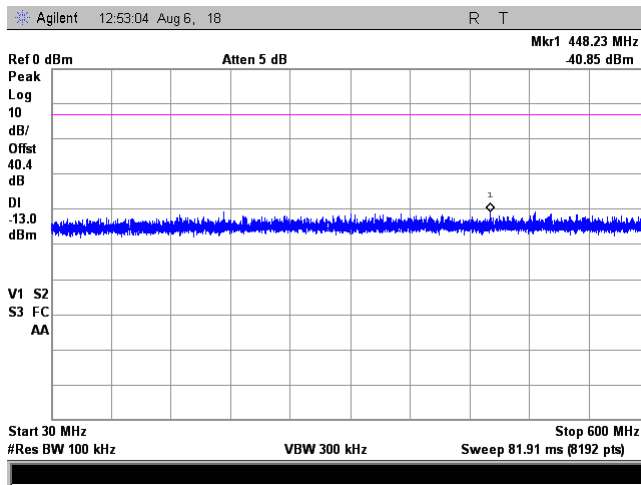

Plot 7.8.94 Spurious emission measurements in 1000 - 9000 MHz range at low carrier frequency

FREQUENCY RANGE: 851 - 861 MHz
 OPERATIONAL MODE: iDEN QAM downlink transmit
 INPUT PORT: Base
 INPUT POWER: -51 dBm
 CONFIGURATION: Single Band

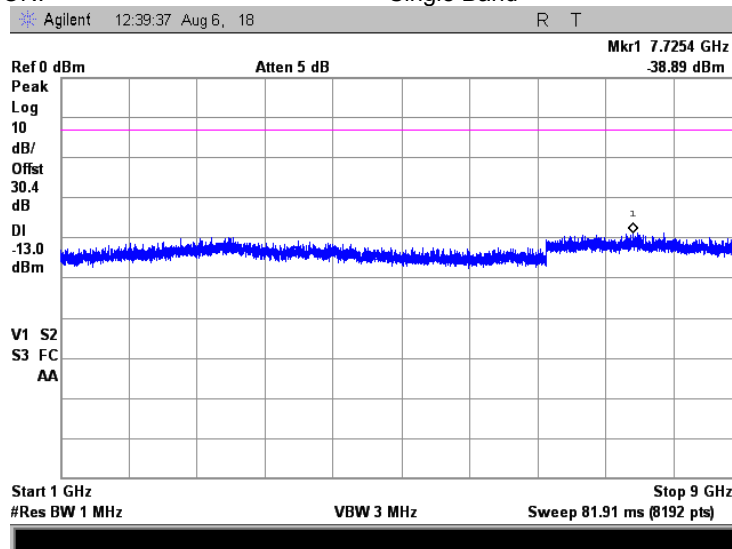

Test specification:		Section 90.219(e)(3), Conducted spurious emissions	
Test procedure:		47 CFR, Sections 2.1051; KDB 935210 D02 v02, Appendix D	
Test mode:		Compliance	
Date(s):		06-Aug-14 - 10-Aug-14	
Temperature: 23.2 °C		Air Pressure: 1008 hPa	
		Relative Humidity: 46 %	
		Power Supply: 120 VAC	
Remarks:			
		Verdict: PASS	

Plot 7.8.95 Spurious emission measurements in 1000 - 9000 MHz at mid carrier frequency

FREQUENCY RANGE: 851 - 861 MHz
 OPERATIONAL MODE: iDEN QAM downlink transmit
 INPUT PORT: Base
 INPUT POWER: -51 dBm
 CONFIGURATION: Single Band

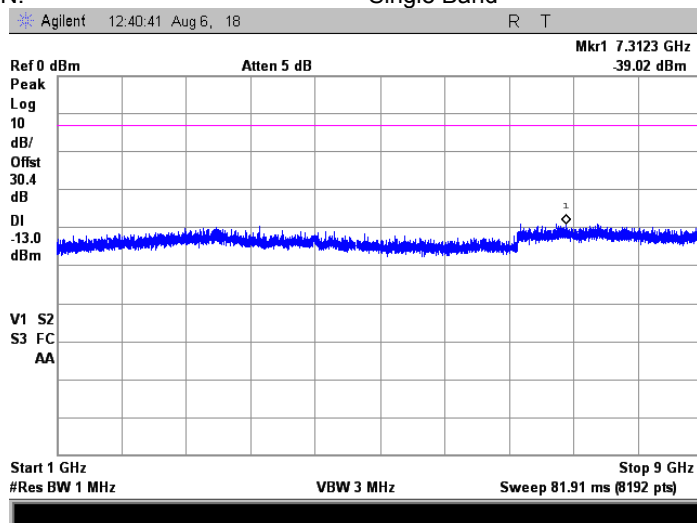

Plot 7.8.96 Spurious emission measurements in 1000 - 9000 MHz at high carrier frequency

FREQUENCY RANGE: 851 - 861 MHz
 OPERATIONAL MODE: iDEN QAM downlink transmit
 INPUT PORT: Base
 INPUT POWER: -51 dBm
 CONFIGURATION: Single Band

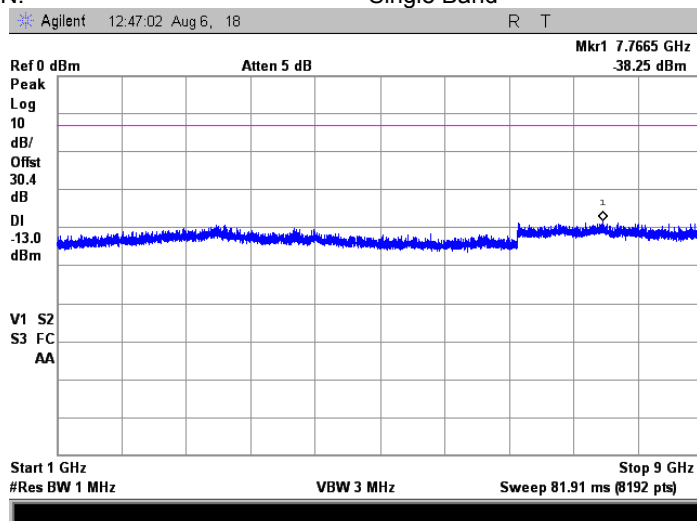

Test specification:		Section 90.219(e)(3), Conducted spurious emissions	
Test procedure:		47 CFR, Sections 2.1051; KDB 935210 D02 v02, Appendix D	
Test mode:		Compliance	
Date(s):		06-Aug-14 - 10-Aug-14	
Temperature: 23.2 °C		Air Pressure: 1008 hPa	
		Relative Humidity: 46 %	
		Power Supply: 120 VAC	
Remarks:			
		Verdict: PASS	

Plot 7.8.97 Spurious emission measurements in 9 - 150 kHz range at low carrier frequency

FREQUENCY RANGE: 851 - 861 MHz
 OPERATIONAL MODE: Analog FM downlink transmit
 INPUT PORT: Base
 INPUT POWER: -51 dBm
 CONFIGURATION: Single Band

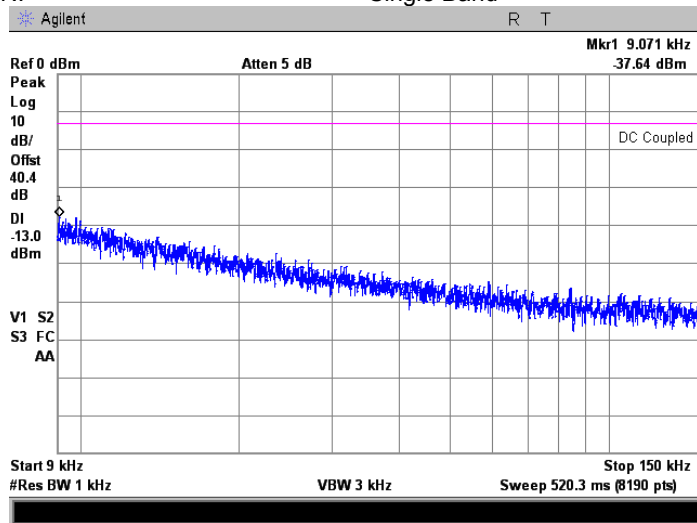

Plot 7.8.98 Spurious emission measurements in 9 - 150 kHz range at mid carrier frequency

FREQUENCY RANGE: 851 - 861 MHz
 OPERATIONAL MODE: Analog FM downlink transmit
 INPUT PORT: Base
 INPUT POWER: -51 dBm
 CONFIGURATION: Single Band

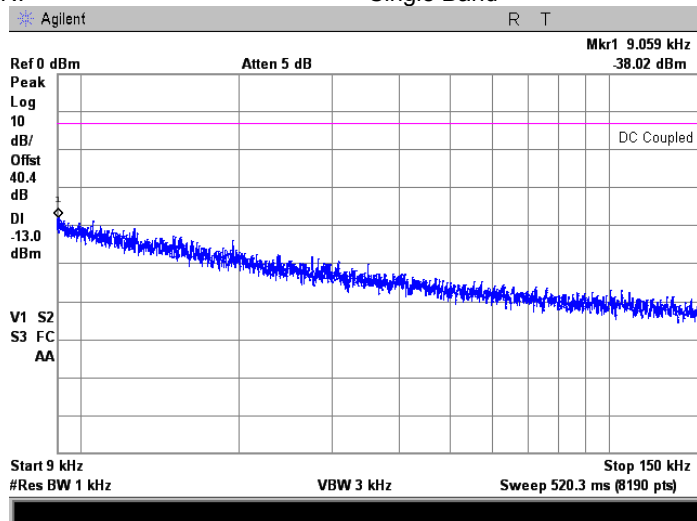

Test specification:	Section 90.219(e)(3), Conducted spurious emissions		
Test procedure:	47 CFR, Sections 2.1051; KDB 935210 D02 v02, Appendix D		
Test mode:	Compliance	Verdict:	PASS
Date(s):	06-Aug-14 - 10-Aug-14		
Temperature: 23.2 °C	Air Pressure: 1008 hPa	Relative Humidity: 46 %	Power Supply: 120 VAC
Remarks:			

Plot 7.8.99 Spurious emission measurements in 9 - 150 kHz range at high carrier frequency

FREQUENCY RANGE: 851 - 861 MHz
 OPERATIONAL MODE: Analog FM downlink transmit
 INPUT PORT: Base
 INPUT POWER: -51 dBm
 CONFIGURATION: Single Band

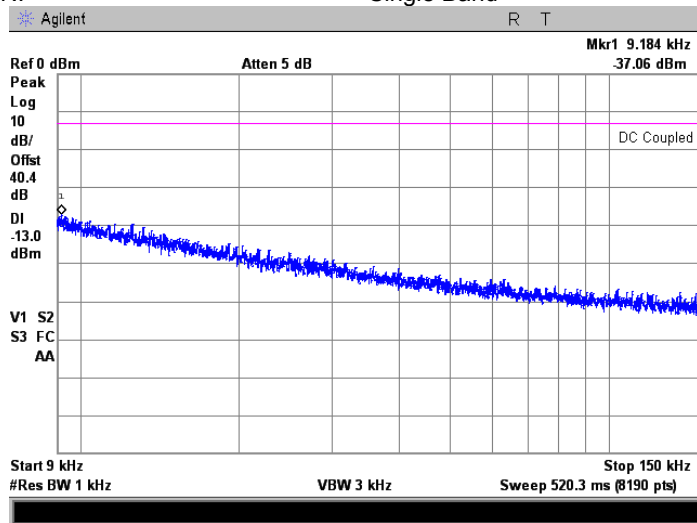

Plot 7.8.100 Spurious emission measurements in 0.15 - 30.0 MHz range at low carrier frequency

FREQUENCY RANGE: 851 - 861 MHz
 OPERATIONAL MODE: Analog FM downlink transmit
 INPUT PORT: Base
 INPUT POWER: -51 dBm
 CONFIGURATION: Single Band

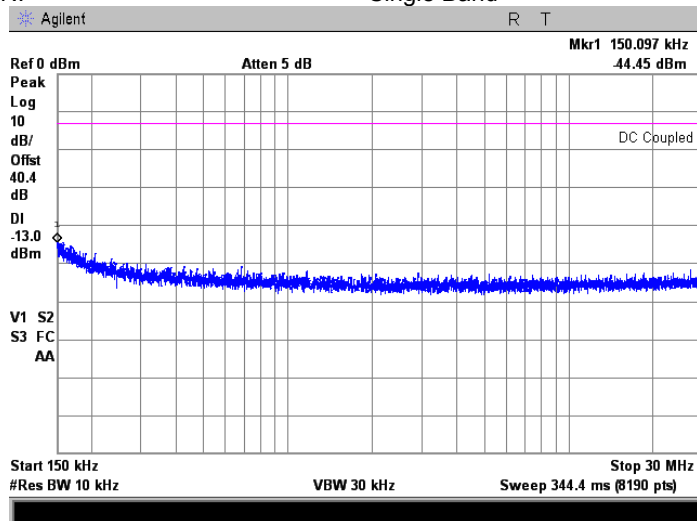

Test specification:		Section 90.219(e)(3), Conducted spurious emissions	
Test procedure:		47 CFR, Sections 2.1051; KDB 935210 D02 v02, Appendix D	
Test mode:		Compliance	
Date(s):		06-Aug-14 - 10-Aug-14	
Temperature: 23.2 °C		Air Pressure: 1008 hPa	
		Relative Humidity: 46 %	
		Power Supply: 120 VAC	
Remarks:			
		Verdict: PASS	

Plot 7.8.101 Spurious emission measurements in 0.15 - 30.0 MHz range at mid carrier frequency

FREQUENCY RANGE: 851 - 861 MHz
 OPERATIONAL MODE: Analog FM downlink transmit
 INPUT PORT: Base
 INPUT POWER: -51 dBm
 CONFIGURATION: Single Band

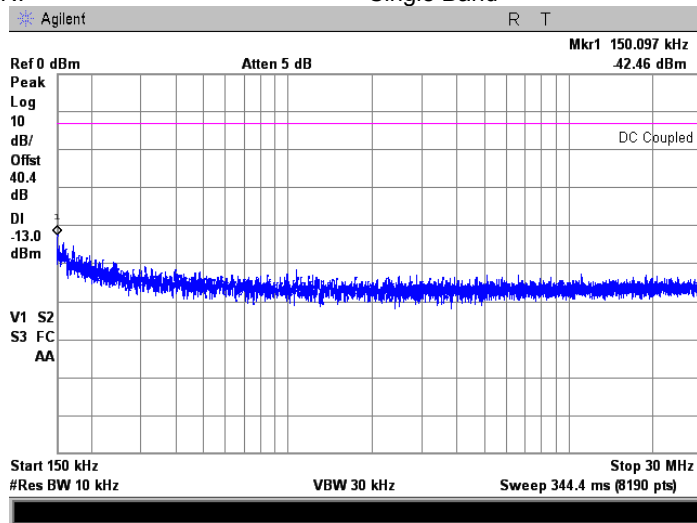

Plot 7.8.102 Spurious emission measurements in 0.15 - 30.0 MHz range at high carrier frequency

FREQUENCY RANGE: 851 - 861 MHz
 OPERATIONAL MODE: Analog FM downlink transmit
 INPUT PORT: Base
 INPUT POWER: -51 dBm
 CONFIGURATION: Single Band

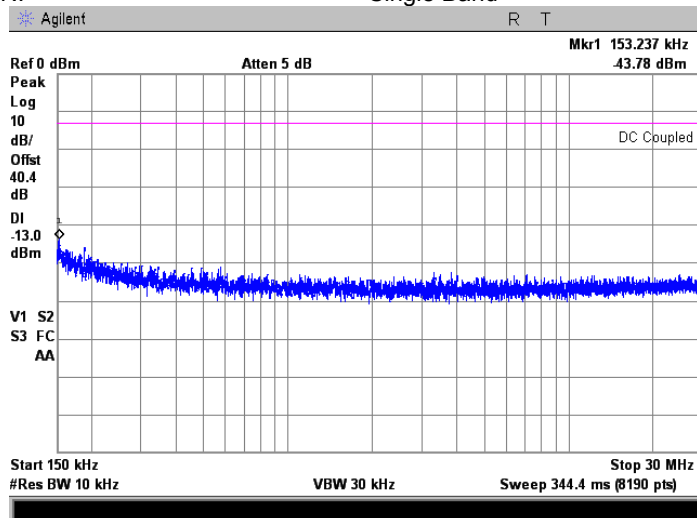

Test specification:		Section 90.219(e)(3), Conducted spurious emissions	
Test procedure:		47 CFR, Sections 2.1051; KDB 935210 D02 v02, Appendix D	
Test mode:		Verdict:	
Compliance		PASS	
Date(s):		06-Aug-14 - 10-Aug-14	
Temperature: 23.2 °C	Air Pressure: 1008 hPa	Relative Humidity: 46 %	Power Supply: 120 VAC
Remarks:			

Plot 7.8.103 Spurious emission measurements in 30.0 - 1000 MHz range at low carrier frequency

FREQUENCY RANGE:
OPERATIONAL MODE:
INPUT PORT:
INPUT POWER:
CONFIGURATION:

851 - 861 MHz
Analog FM downlink transmit
Base
-51 dBm
Single Band

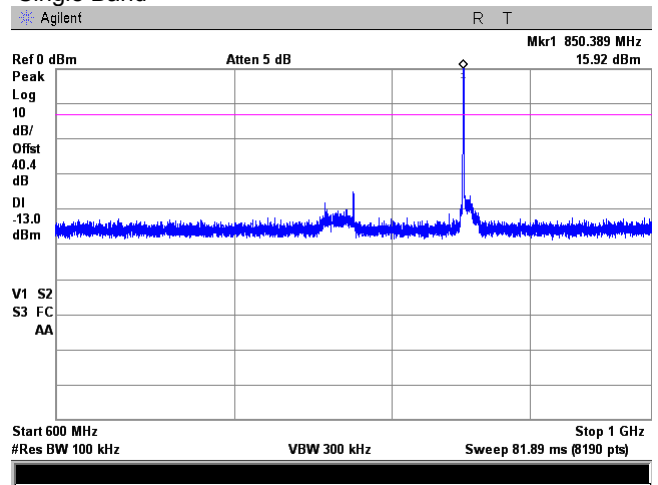
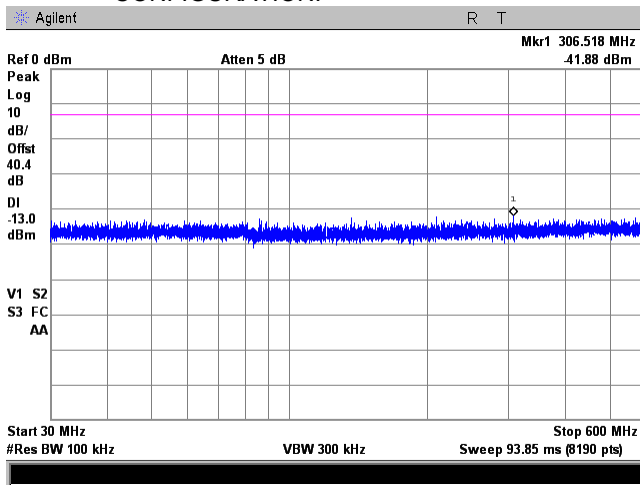

Plot 7.8.104 Spurious emission measurements in 30.0 - 1000 MHz range at mid carrier frequency

FREQUENCY RANGE:
OPERATIONAL MODE:
INPUT PORT:
INPUT POWER:
CONFIGURATION:

851 - 861 MHz
Analog FM downlink transmit
Base
-51 dBm
Single Band

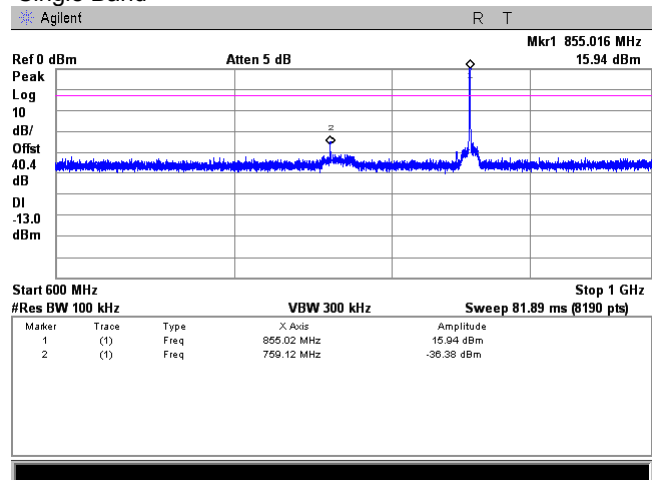
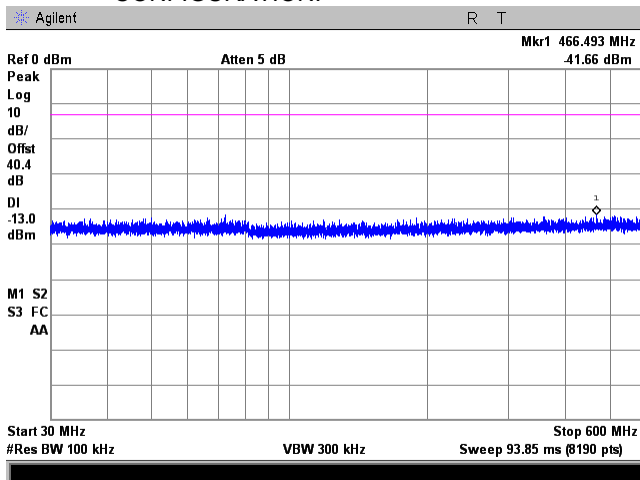

Test specification:		Section 90.219(e)(3), Conducted spurious emissions	
Test procedure:		47 CFR, Sections 2.1051; KDB 935210 D02 v02, Appendix D	
Test mode:		Compliance	
Date(s):		06-Aug-14 - 10-Aug-14	
Temperature: 23.2 °C		Air Pressure: 1008 hPa	
Remarks:		Verdict: PASS	
		Relative Humidity: 46 %	
		Power Supply: 120 VAC	

Plot 7.8.105 Spurious emission measurements in 30.0 - 1000 MHz range at high carrier frequency

FREQUENCY RANGE: 851 - 861 MHz
 OPERATIONAL MODE: Analog FM downlink transmit
 INPUT PORT: Base
 INPUT POWER: -51 dBm
 CONFIGURATION: Single Band

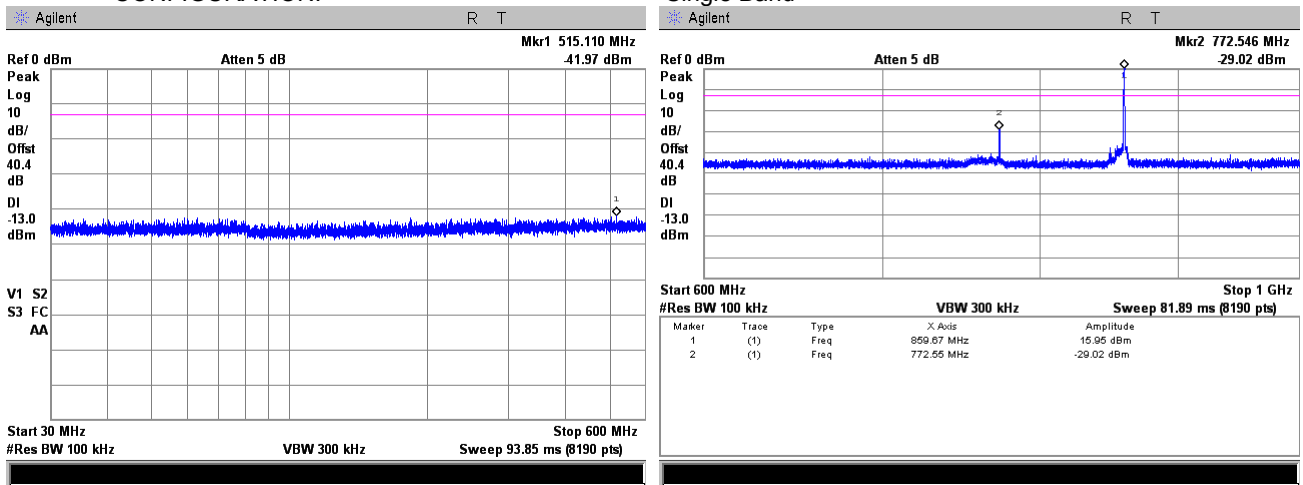

Plot 7.8.106 Spurious emission measurements in 1000 - 9000 MHz range at low carrier frequency

FREQUENCY RANGE: 851 - 861 MHz
 OPERATIONAL MODE: Analog FM downlink transmit
 INPUT PORT: Base
 INPUT POWER: -51 dBm
 CONFIGURATION: Single Band

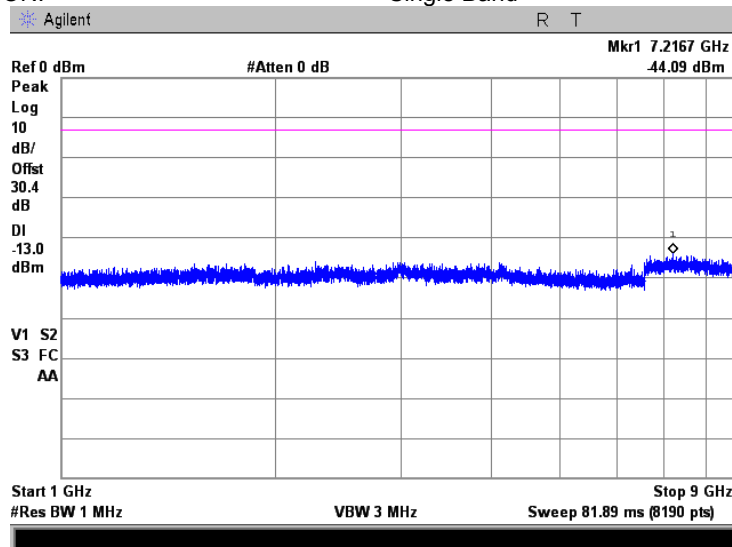

Test specification:		Section 90.219(e)(3), Conducted spurious emissions	
Test procedure:		47 CFR, Sections 2.1051; KDB 935210 D02 v02, Appendix D	
Test mode:		Compliance	
Date(s):		06-Aug-14 - 10-Aug-14	
Temperature: 23.2 °C		Air Pressure: 1008 hPa	
		Relative Humidity: 46 %	
		Power Supply: 120 VAC	
Remarks:			
		Verdict: PASS	

Plot 7.8.107 Spurious emission measurements in 1000 - 9000 MHz at mid carrier frequency

FREQUENCY RANGE: 851 - 861 MHz
 OPERATIONAL MODE: Analog FM downlink transmit
 INPUT PORT: Base
 INPUT POWER: -51 dBm
 CONFIGURATION: Single Band

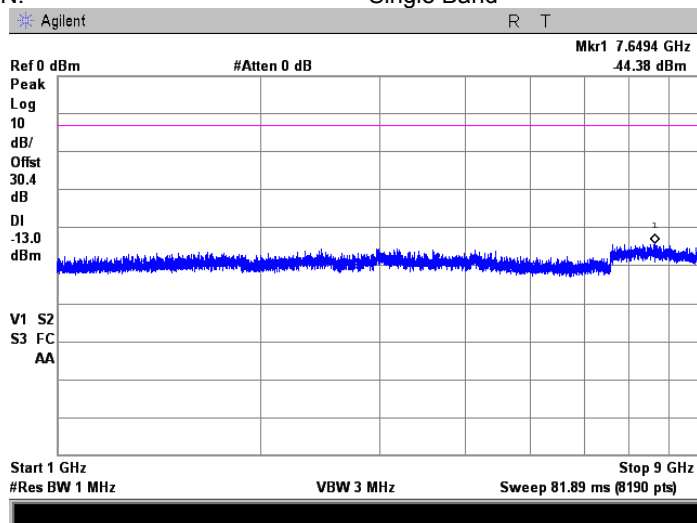

Plot 7.8.108 Spurious emission measurements in 1000 - 9000 MHz at high carrier frequency

FREQUENCY RANGE: 851 - 861 MHz
 OPERATIONAL MODE: Analog FM downlink transmit
 INPUT PORT: Base
 INPUT POWER: -51 dBm
 CONFIGURATION: Single Band

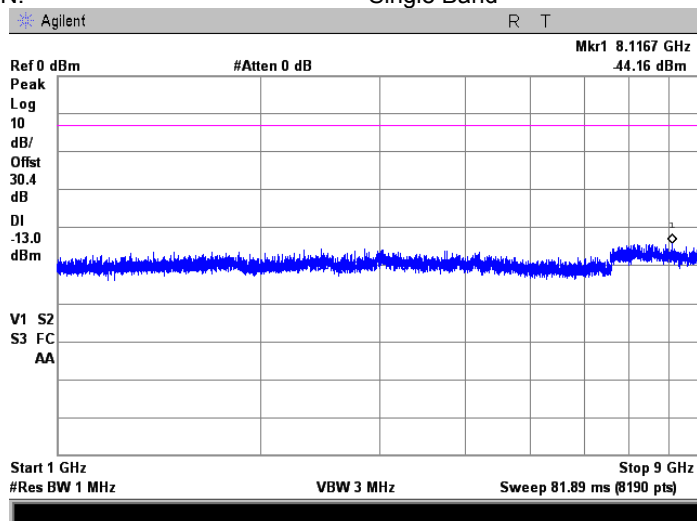

Test specification:		Section 90.219(e)(3), Conducted spurious emissions	
Test procedure:		47 CFR, Sections 2.1051; KDB 935210 D02 v02, Appendix D	
Test mode:		Compliance	
Date(s):		06-Aug-14 - 10-Aug-14	
Temperature: 23.2 °C		Air Pressure: 1008 hPa	
		Relative Humidity: 46 %	
		Power Supply: 120 VAC	
Remarks:			
		Verdict: PASS	

Plot 7.8.109 Spurious emission measurements in 9 - 150 kHz range at low carrier frequency

FREQUENCY RANGE: 806 - 816 MHz
 OPERATIONAL MODE: C4FM uplink transmit
 INPUT PORT: Mobile
 INPUT POWER: -54 dBm
 CONFIGURATION: Single Band

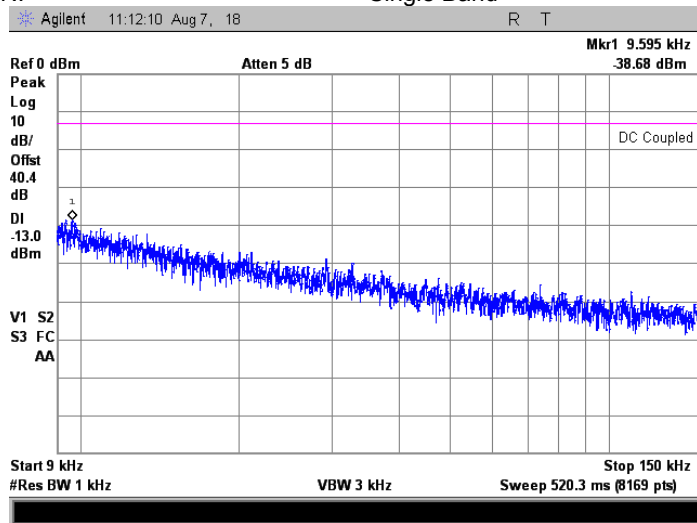

Plot 7.8.110 Spurious emission measurements in 9 - 150 kHz range at mid carrier frequency

FREQUENCY RANGE: 806 - 816 MHz
 OPERATIONAL MODE: C4FM uplink transmit
 INPUT PORT: Mobile
 INPUT POWER: -54 dBm
 CONFIGURATION: Single Band

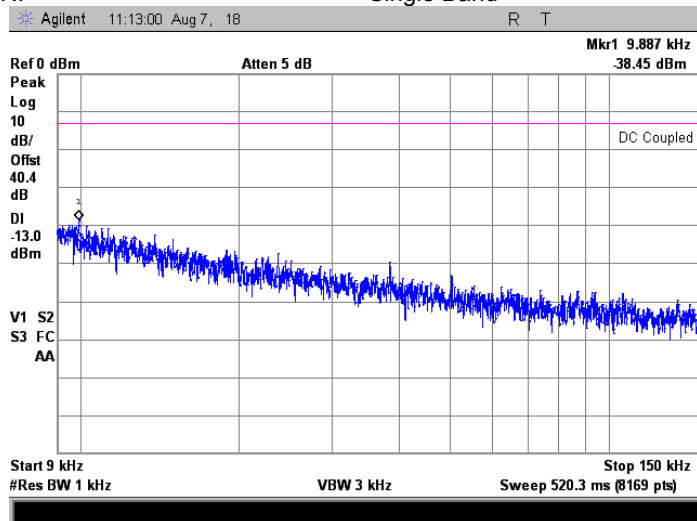

Test specification:		Section 90.219(e)(3), Conducted spurious emissions	
Test procedure:		47 CFR, Sections 2.1051; KDB 935210 D02 v02, Appendix D	
Test mode:		Compliance	
Date(s):		06-Aug-14 - 10-Aug-14	
Temperature: 23.2 °C		Air Pressure: 1008 hPa	
		Relative Humidity: 46 %	
		Power Supply: 120 VAC	
Remarks:			
		Verdict: PASS	

Plot 7.8.111 Spurious emission measurements in 9 - 150 kHz range at high carrier frequency

FREQUENCY RANGE: 806 - 816 MHz
 OPERATIONAL MODE: C4FM uplink transmit
 INPUT PORT: Mobile
 INPUT POWER: -54 dBm
 CONFIGURATION: Single Band

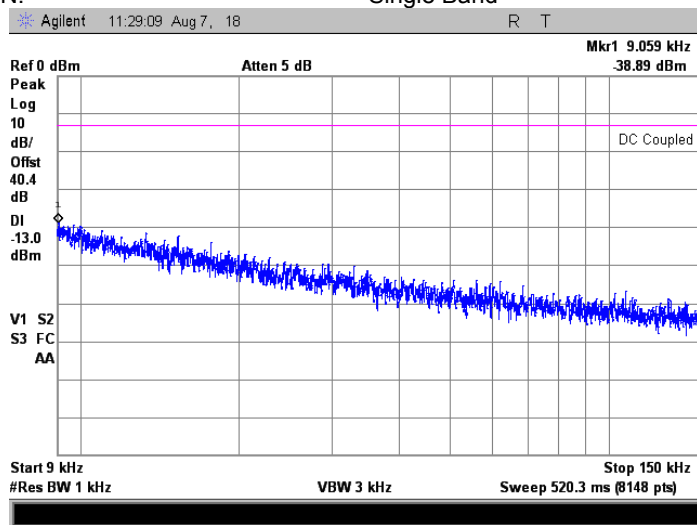

Plot 7.8.112 Spurious emission measurements 0.15 – 30.0 MHz range at low carrier frequency

FREQUENCY RANGE: 806 - 816 MHz
 OPERATIONAL MODE: C4FM uplink transmit
 INPUT PORT: Mobile
 INPUT POWER: -54 dBm
 CONFIGURATION: Single Band

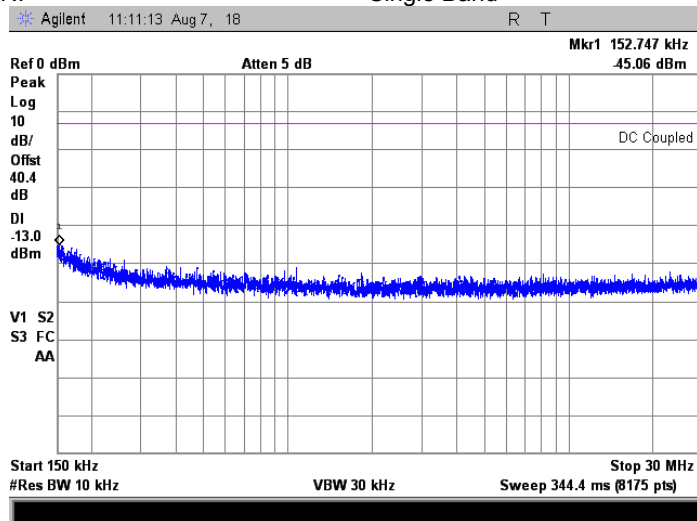

Test specification:		Section 90.219(e)(3), Conducted spurious emissions	
Test procedure:		47 CFR, Sections 2.1051; KDB 935210 D02 v02, Appendix D	
Test mode:		Compliance	
Date(s):		06-Aug-14 - 10-Aug-14	
Temperature: 23.2 °C		Air Pressure: 1008 hPa	
		Relative Humidity: 46 %	
		Power Supply: 120 VAC	
Remarks:			
		Verdict: PASS	

Plot 7.8.113 Spurious emission measurements 0.15 – 30.0 MHz range at mid carrier frequency

FREQUENCY RANGE: 806 - 816 MHz
 OPERATIONAL MODE: C4FM uplink transmit
 INPUT PORT: Mobile
 INPUT POWER: -54 dBm
 CONFIGURATION: Single Band

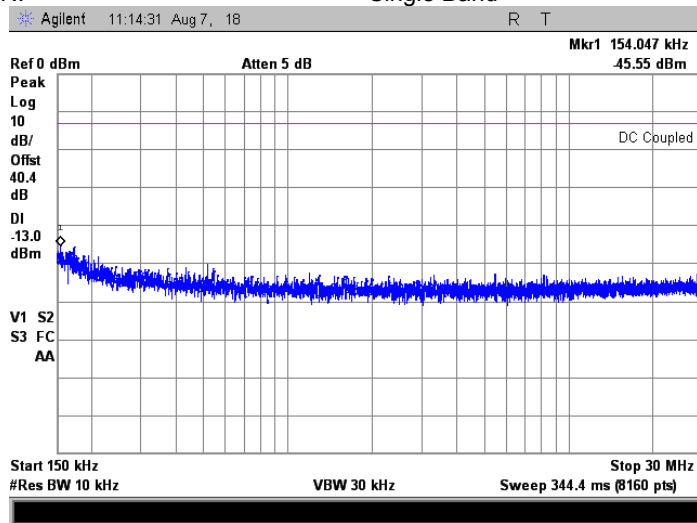

Plot 7.8.114 Spurious emission measurements in 0.15 – 30.0 MHz range at high carrier frequency

FREQUENCY RANGE: 806 - 816 MHz
 OPERATIONAL MODE: C4FM uplink transmit
 INPUT PORT: Mobile
 INPUT POWER: -54 dBm
 CONFIGURATION: Single Band

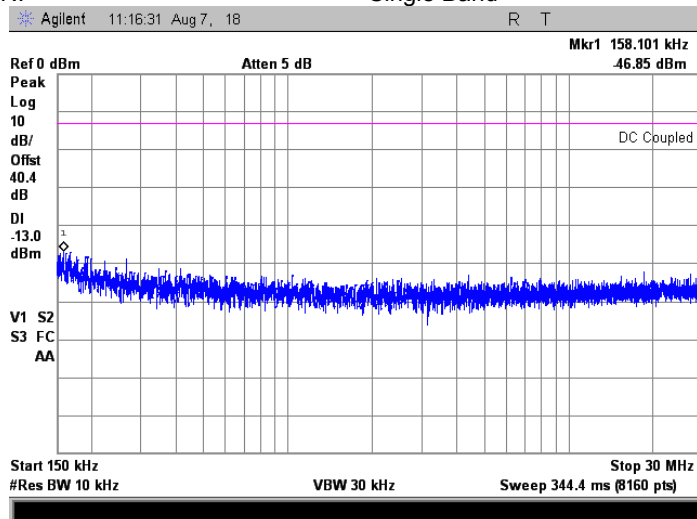

Test specification:		Section 90.219(e)(3), Conducted spurious emissions	
Test procedure:		47 CFR, Sections 2.1051; KDB 935210 D02 v02, Appendix D	
Test mode:		Verdict:	
Compliance		PASS	
Date(s):		06-Aug-14 - 10-Aug-14	
Temperature: 23.2 °C	Air Pressure: 1008 hPa	Relative Humidity: 46 %	Power Supply: 120 VAC
Remarks:			

Plot 7.8.115 Spurious emission measurements in 30.0 - 1000 MHz range at low carrier frequency

FREQUENCY RANGE: 806 - 816 MHz
 OPERATIONAL MODE: C4FM uplink transmit
 INPUT PORT: Mobile
 INPUT POWER: -54 dBm
 CONFIGURATION: Single Band

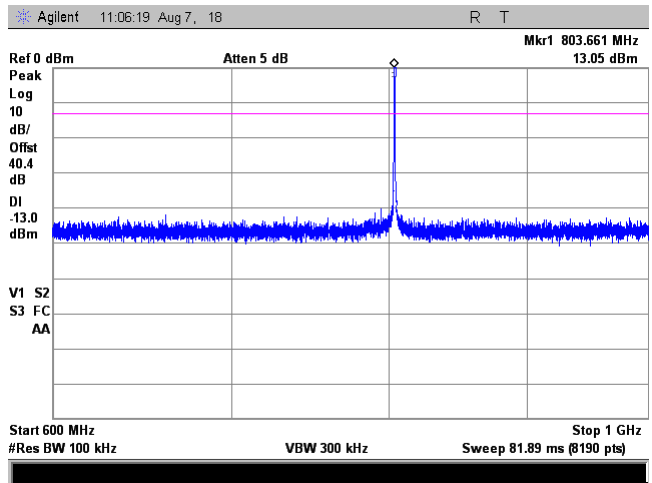
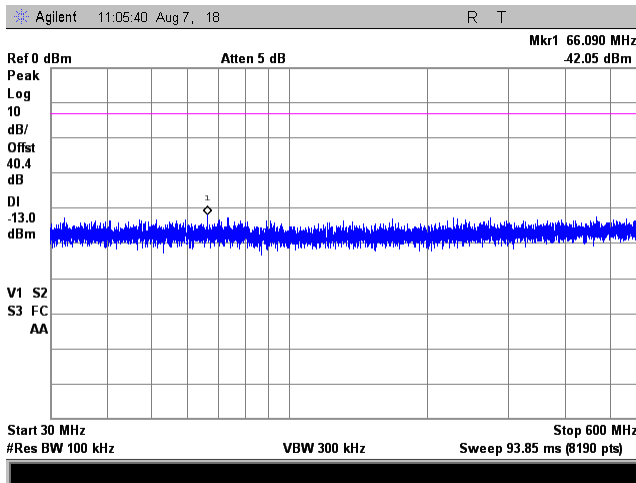

Plot 7.8.116 Spurious emission measurements in 30.0 - 1000 MHz range at mid carrier frequency

FREQUENCY RANGE: 806 - 816 MHz
 OPERATIONAL MODE: C4FM uplink transmit
 INPUT PORT: Mobile
 INPUT POWER: -54 dBm
 CONFIGURATION: Single Band

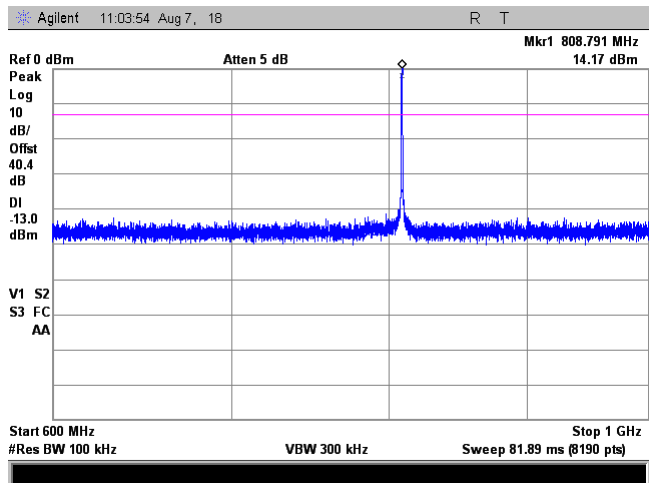
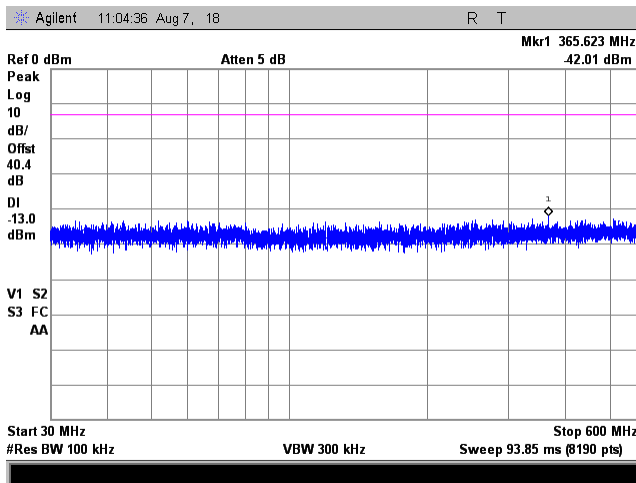

Test specification:		Section 90.219(e)(3), Conducted spurious emissions	
Test procedure:		47 CFR, Sections 2.1051; KDB 935210 D02 v02, Appendix D	
Test mode:		Compliance	
Date(s):		06-Aug-14 - 10-Aug-14	
Temperature: 23.2 °C		Air Pressure: 1008 hPa	
		Relative Humidity: 46 %	
		Power Supply: 120 VAC	
Remarks:			
		Verdict: PASS	

Plot 7.8.117 Spurious emission measurements in 30.0 - 1000 MHz range at high carrier frequency

FREQUENCY RANGE: 806 - 816 MHz
 OPERATIONAL MODE: C4FM uplink transmit
 INPUT PORT: Mobile
 INPUT POWER: -54 dBm
 CONFIGURATION: Single Band

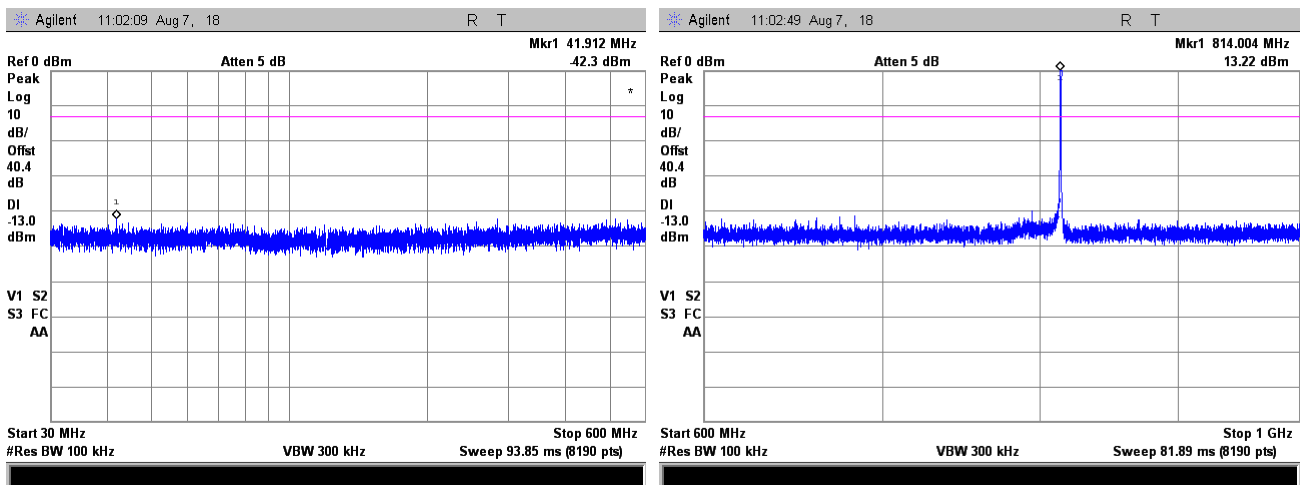

Plot 7.8.118 Spurious emission measurements in 1000 - 8200 MHz range at low carrier frequency

FREQUENCY RANGE: 806 - 816 MHz
 OPERATIONAL MODE: C4FM uplink transmit
 INPUT PORT: Mobile
 INPUT POWER: -54 dBm
 CONFIGURATION: Single Band

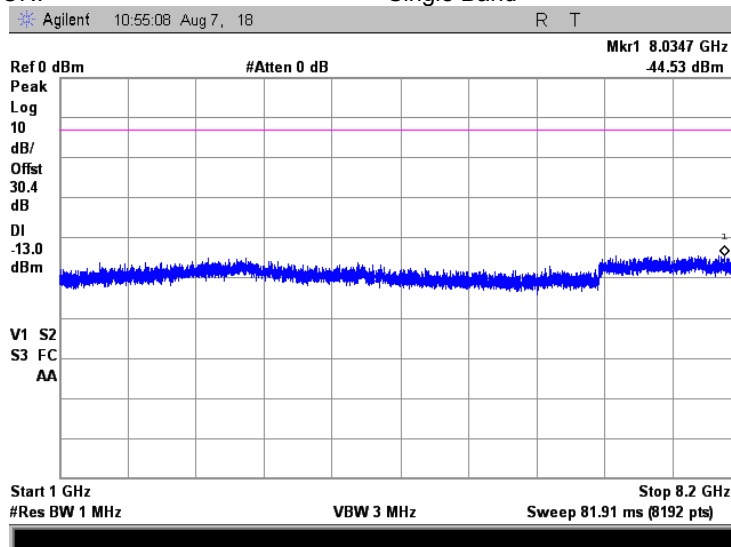

Test specification:		Section 90.219(e)(3), Conducted spurious emissions	
Test procedure:		47 CFR, Sections 2.1051; KDB 935210 D02 v02, Appendix D	
Test mode:		Compliance	
Date(s):		06-Aug-14 - 10-Aug-14	
Temperature: 23.2 °C		Air Pressure: 1008 hPa	
		Relative Humidity: 46 %	
		Power Supply: 120 VAC	
Remarks:			
		Verdict: PASS	

Plot 7.8.119 Spurious emission measurements in 1000 - 8200 MHz at mid carrier frequency

FREQUENCY RANGE: 806 - 816 MHz
 OPERATIONAL MODE: C4FM uplink transmit
 INPUT PORT: Mobile
 INPUT POWER: -54 dBm
 CONFIGURATION: Single Band

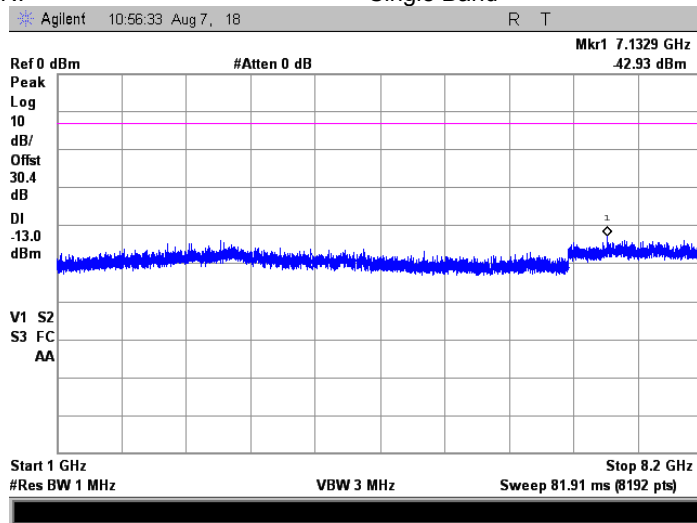

Plot 7.8.120 Spurious emission measurements in 1000 - 8200 MHz at high carrier frequency

FREQUENCY RANGE: 806 - 816 MHz
 OPERATIONAL MODE: C4FM uplink transmit
 INPUT PORT: Mobile
 INPUT POWER: -54 dBm
 CONFIGURATION: Single Band

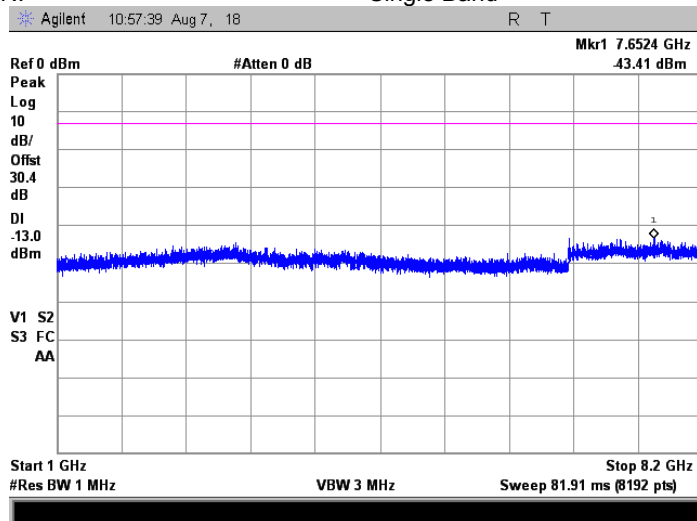

Test specification:	Section 90.219(e)(3), Conducted spurious emissions		
Test procedure:	47 CFR, Sections 2.1051; KDB 935210 D02 v02, Appendix D		
Test mode:	Compliance	Verdict:	PASS
Date(s):	06-Aug-14 - 10-Aug-14		
Temperature: 23.2 °C	Air Pressure: 1008 hPa	Relative Humidity: 46 %	Power Supply: 120 VAC
Remarks:			

Plot 7.8.121 Spurious emission measurements in 9 - 150 kHz range at low carrier frequency

FREQUENCY RANGE: 806 - 816 MHz
 OPERATIONAL MODE: iDEN QAM uplink transmit
 INPUT PORT: Mobile
 INPUT POWER: -54 dBm
 CONFIGURATION: Single Band

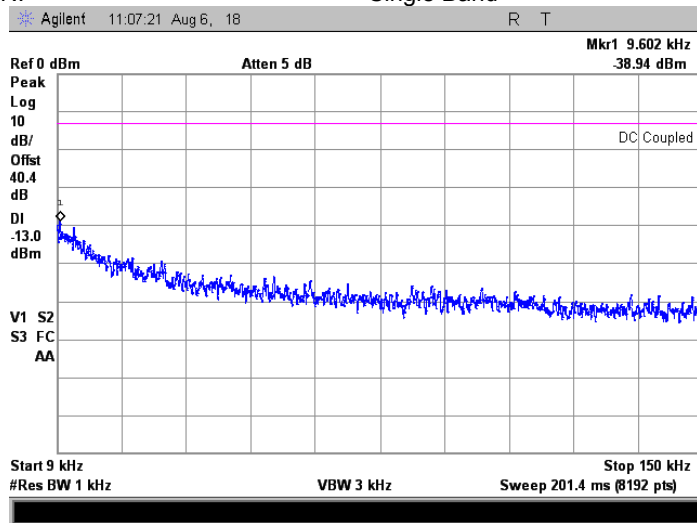

Plot 7.8.122 Spurious emission measurements in 9 - 150 kHz range at mid carrier frequency

FREQUENCY RANGE: 806 - 816 MHz
 OPERATIONAL MODE: iDEN QAM uplink transmit
 INPUT PORT: Mobile
 INPUT POWER: -54 dBm
 CONFIGURATION: Single Band

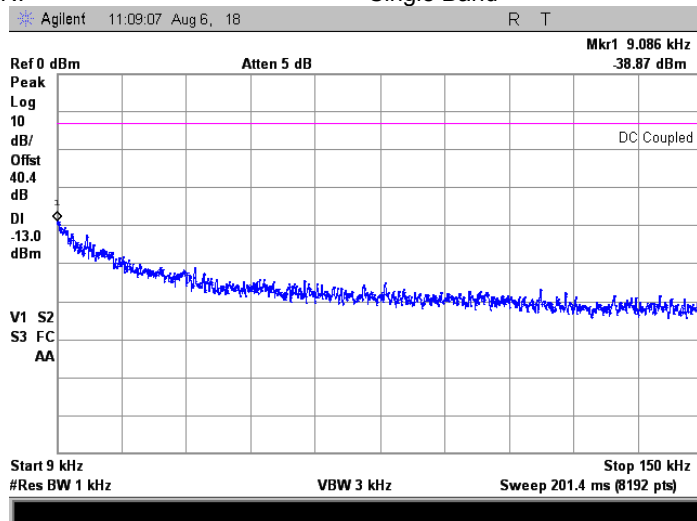

Test specification:	Section 90.219(e)(3), Conducted spurious emissions		
Test procedure:	47 CFR, Sections 2.1051; KDB 935210 D02 v02, Appendix D		
Test mode:	Compliance	Verdict:	PASS
Date(s):	06-Aug-14 - 10-Aug-14		
Temperature: 23.2 °C	Air Pressure: 1008 hPa	Relative Humidity: 46 %	Power Supply: 120 VAC
Remarks:			

Plot 7.8.123 Spurious emission measurements in 9 - 150 kHz range at high carrier frequency

FREQUENCY RANGE: 806 - 816 MHz
 OPERATIONAL MODE: iDEN QAM uplink transmit
 INPUT PORT: Mobile
 INPUT POWER: -54 dBm
 CONFIGURATION: Single Band

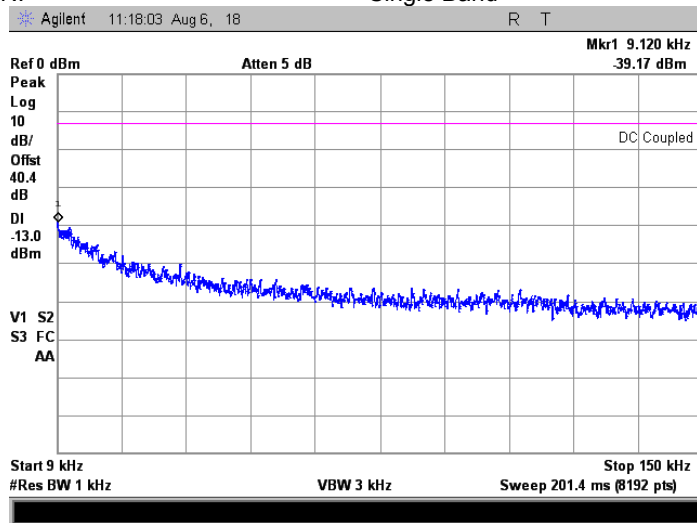

Plot 7.8.124 Spurious emission measurements in 0.15 – 30.0 MHz range at low carrier frequency

FREQUENCY RANGE: 806 - 816 MHz
 OPERATIONAL MODE: iDEN QAM uplink transmit
 INPUT PORT: Mobile
 INPUT POWER: -54 dBm
 CONFIGURATION: Single Band

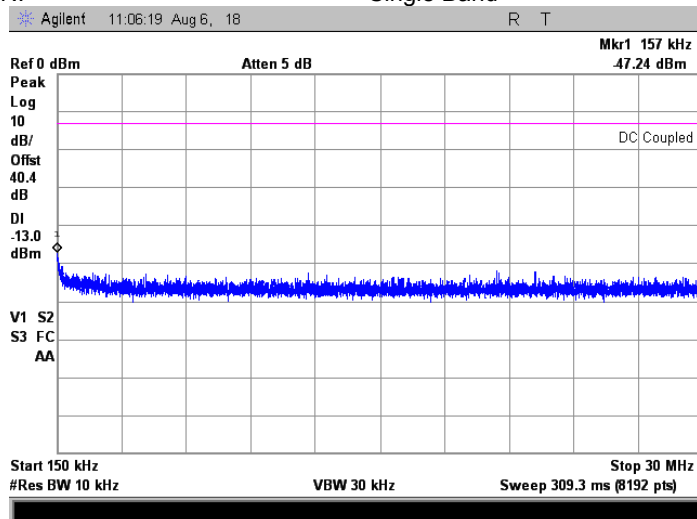

Test specification:		Section 90.219(e)(3), Conducted spurious emissions	
Test procedure:		47 CFR, Sections 2.1051; KDB 935210 D02 v02, Appendix D	
Test mode:		Compliance	
Date(s):		06-Aug-14 - 10-Aug-14	
Temperature: 23.2 °C		Air Pressure: 1008 hPa	
		Relative Humidity: 46 %	
		Power Supply: 120 VAC	
Remarks:			
		Verdict: PASS	

Plot 7.8.125 Spurious emission measurements in 0.15 – 30.0 MHz range at mid carrier frequency

FREQUENCY RANGE: 806 - 816 MHz
 OPERATIONAL MODE: iDEN QAM uplink transmit
 INPUT PORT: Mobile
 INPUT POWER: -54 dBm
 CONFIGURATION: Single Band

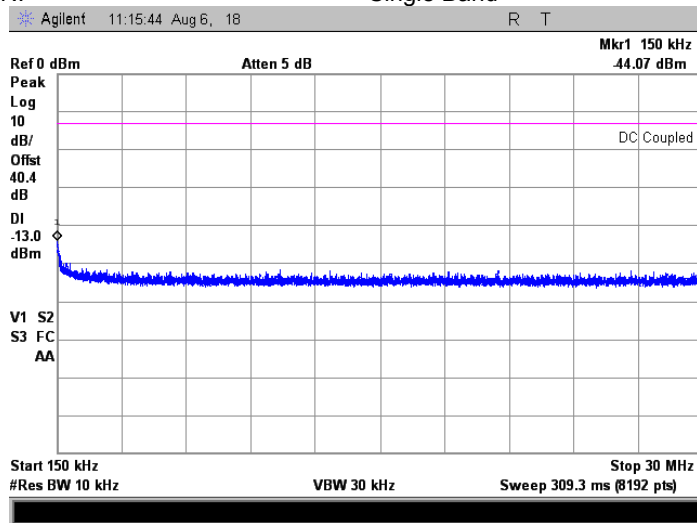

Plot 7.8.126 Spurious emission measurements in 0.15 – 30.0 MHz range at high carrier frequency

FREQUENCY RANGE: 806 - 816 MHz
 OPERATIONAL MODE: iDEN QAM uplink transmit
 INPUT PORT: Mobile
 INPUT POWER: -54 dBm
 CONFIGURATION: Single Band

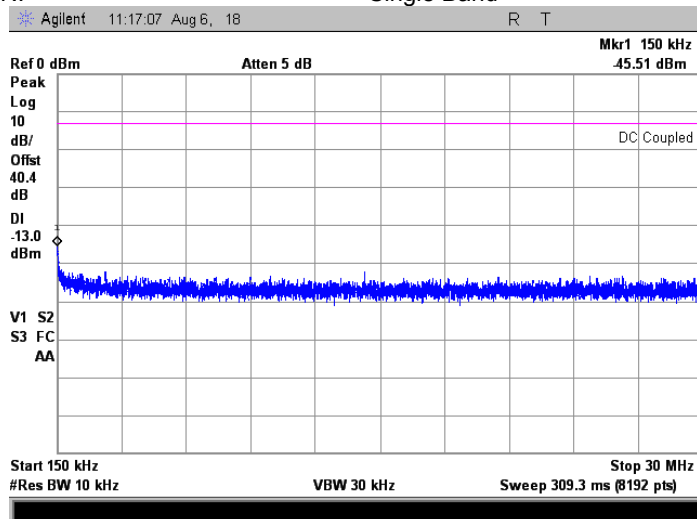

Test specification: Section 90.219(e)(3), Conducted spurious emissions	
Test procedure: 47 CFR, Sections 2.1051; KDB 935210 D02 v02, Appendix D	
Test mode: Compliance	Verdict: PASS
Date(s): 06-Aug-14 - 10-Aug-14	
Temperature: 23.2 °C	Air Pressure: 1008 hPa
Relative Humidity: 46 %	Power Supply: 120 VAC
Remarks:	

Plot 7.8.127 Spurious emission measurements in 30.0 - 1000 MHz range at low carrier frequency

FREQUENCY RANGE:
OPERATIONAL MODE:
INPUT PORT:
INPUT POWER:
CONFIGURATION:

806 - 816 MHz
iDEN QAM uplink transmit
Mobile
-54 dBm
Single Band

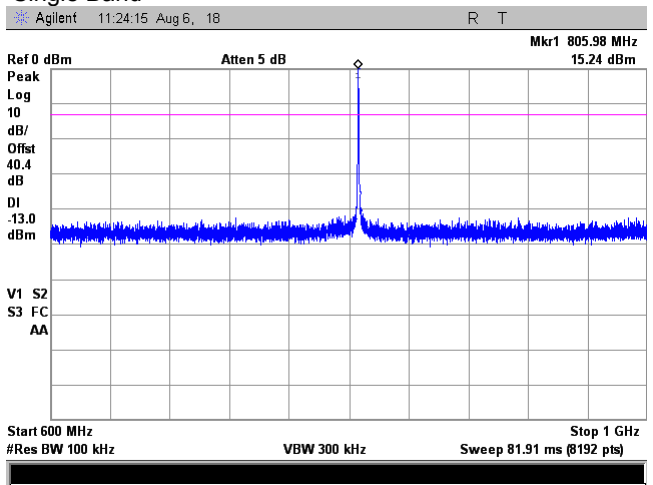
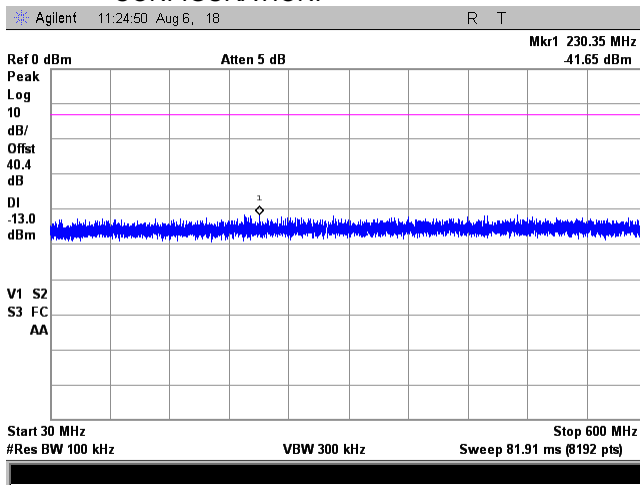

Plot 7.8.128 Spurious emission measurements in 30.0 - 1000 MHz range at mid carrier frequency

FREQUENCY RANGE:
OPERATIONAL MODE:
INPUT PORT:
INPUT POWER:
CONFIGURATION:

806 - 816 MHz
iDEN QAM uplink transmit
Mobile
-54 dBm
Single Band

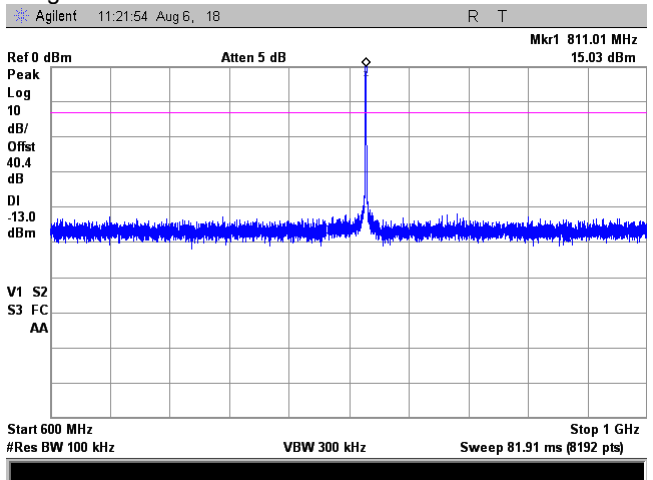
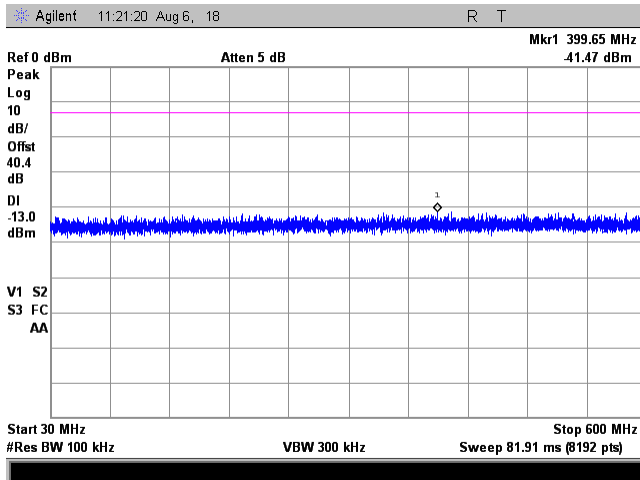

Test specification:		Section 90.219(e)(3), Conducted spurious emissions	
Test procedure:		47 CFR, Sections 2.1051; KDB 935210 D02 v02, Appendix D	
Test mode:		Verdict:	
Compliance		PASS	
Date(s):		06-Aug-14 - 10-Aug-14	
Temperature: 23.2 °C	Air Pressure: 1008 hPa	Relative Humidity: 46 %	Power Supply: 120 VAC
Remarks:			

Plot 7.8.129 Spurious emission measurements in 30.0 - 1000 MHz range at high carrier frequency

FREQUENCY RANGE: 806 - 816 MHz
 OPERATIONAL MODE: iDEN QAM uplink transmit
 INPUT PORT: Mobile
 INPUT POWER: -54 dBm
 CONFIGURATION: Single Band

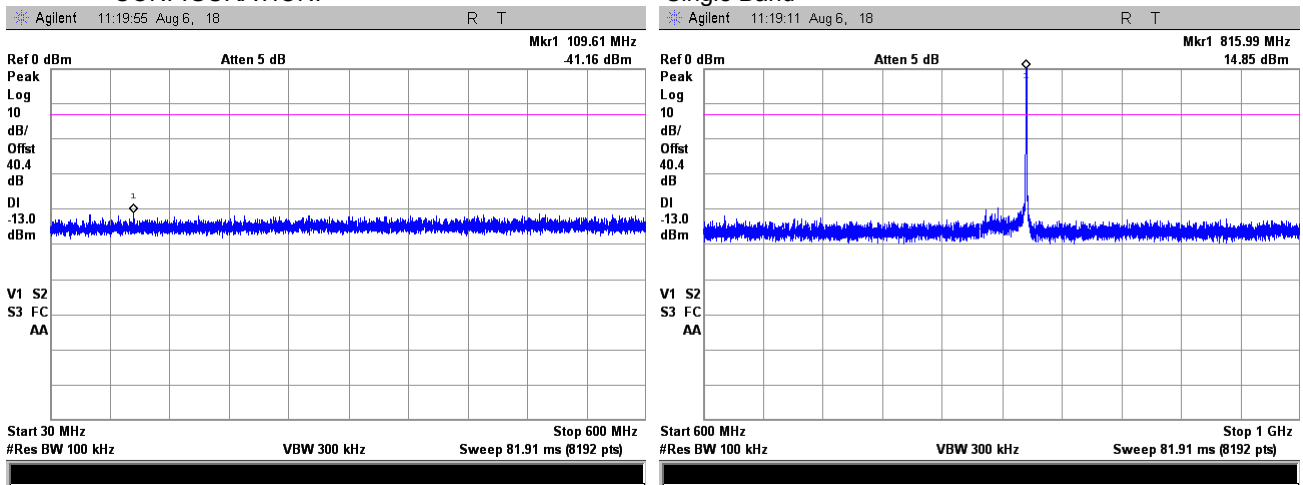

Plot 7.8.130 Spurious emission measurements in 1000 - 8200 MHz range at low carrier frequency

FREQUENCY RANGE: 806 - 816 MHz
 OPERATIONAL MODE: iDEN QAM uplink transmit
 INPUT PORT: Mobile
 INPUT POWER: -54 dBm
 CONFIGURATION: Single Band

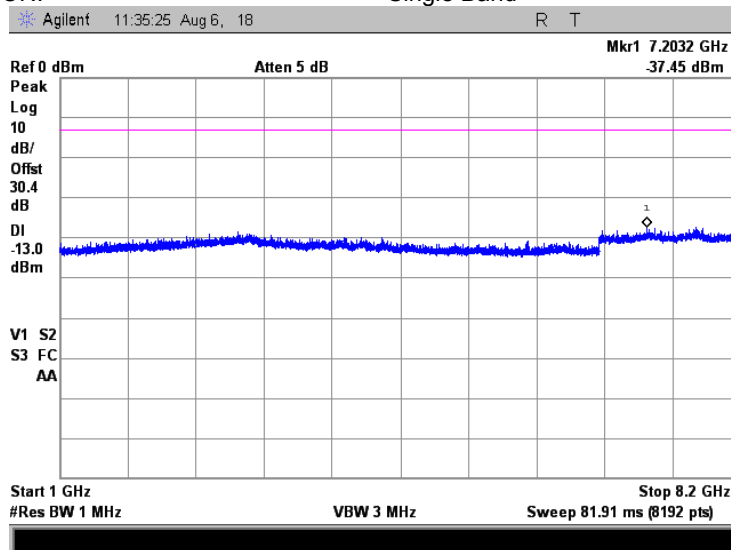

Test specification:		Section 90.219(e)(3), Conducted spurious emissions	
Test procedure:		47 CFR, Sections 2.1051; KDB 935210 D02 v02, Appendix D	
Test mode:		Compliance	
Date(s):		06-Aug-14 - 10-Aug-14	
Temperature: 23.2 °C		Air Pressure: 1008 hPa	
		Relative Humidity: 46 %	
		Power Supply: 120 VAC	
Remarks:			
		Verdict: PASS	

Plot 7.8.131 Spurious emission measurements in 1000 - 8200 MHz at mid carrier frequency

FREQUENCY RANGE: 806 - 816 MHz
 OPERATIONAL MODE: iDEN QAM uplink transmit
 INPUT PORT: Mobile
 INPUT POWER: -54 dBm
 CONFIGURATION: Single Band

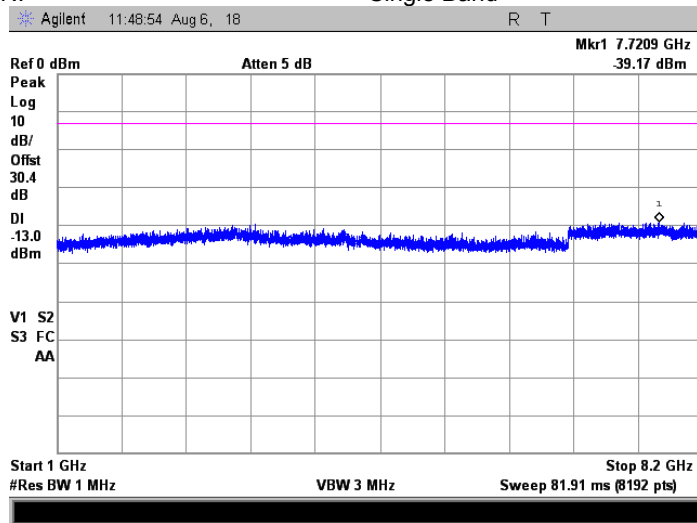

Plot 7.8.132 Spurious emission measurements in 1000 - 8200 MHz at high carrier frequency

FREQUENCY RANGE: 806 - 816 MHz
 OPERATIONAL MODE: iDEN QAM uplink transmit
 INPUT PORT: Mobile
 INPUT POWER: -54 dBm
 CONFIGURATION: Single Band

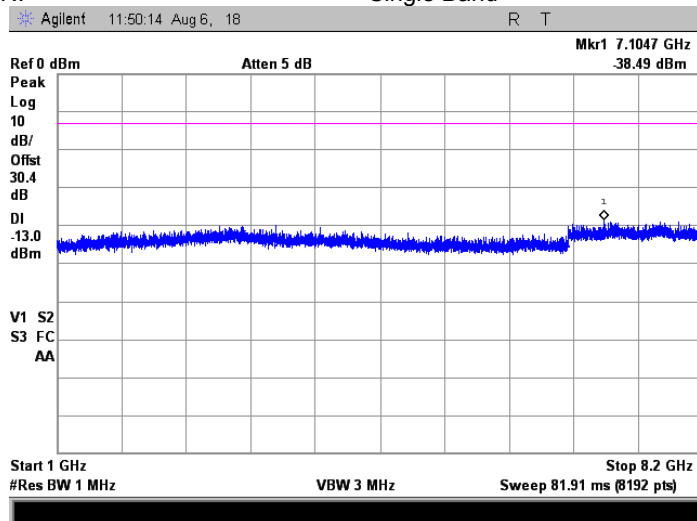

Test specification:		Section 90.219(e)(3), Conducted spurious emissions	
Test procedure:		47 CFR, Sections 2.1051; KDB 935210 D02 v02, Appendix D	
Test mode:		Compliance	
Date(s):		06-Aug-14 - 10-Aug-14	
Temperature: 23.2 °C		Air Pressure: 1008 hPa	
		Relative Humidity: 46 %	
		Power Supply: 120 VAC	
Remarks:			
		Verdict: PASS	

Plot 7.8.133 Spurious emission measurements in 9 - 150 kHz range at low carrier frequency

FREQUENCY RANGE: 806 - 816 MHz
 OPERATIONAL MODE: Analog FM uplink transmit
 INPUT PORT: Mobile
 INPUT POWER: -54 dBm
 CONFIGURATION: Single Band

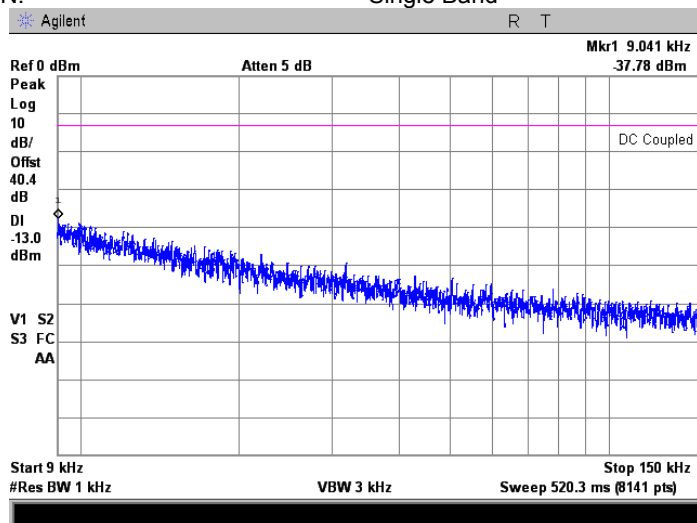

Plot 7.8.134 Spurious emission measurements in 9 - 150 kHz range at mid carrier frequency

FREQUENCY RANGE: 806 - 816 MHz
 OPERATIONAL MODE: Analog FM uplink transmit
 INPUT PORT: Mobile
 INPUT POWER: -54 dBm
 CONFIGURATION: Single Band

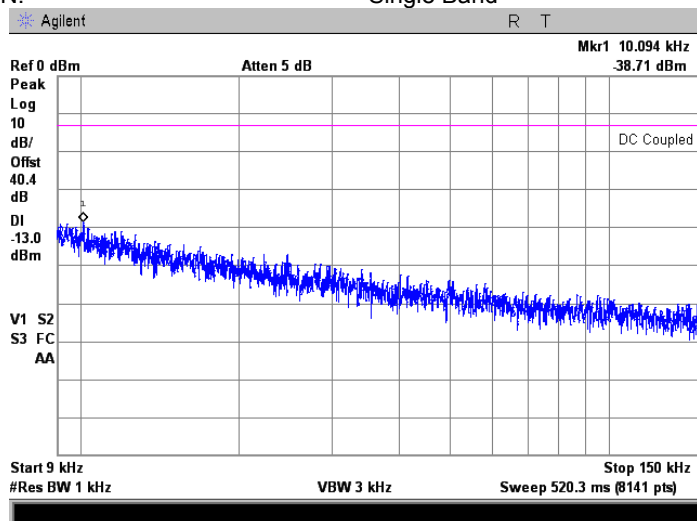

Test specification:	Section 90.219(e)(3), Conducted spurious emissions		
Test procedure:	47 CFR, Sections 2.1051; KDB 935210 D02 v02, Appendix D		
Test mode:	Compliance	Verdict:	PASS
Date(s):	06-Aug-14 - 10-Aug-14		
Temperature: 23.2 °C	Air Pressure: 1008 hPa	Relative Humidity: 46 %	Power Supply: 120 VAC
Remarks:			

Plot 7.8.135 Spurious emission measurements in 9 - 150 kHz range at high carrier frequency

FREQUENCY RANGE: 806 - 816 MHz
 OPERATIONAL MODE: Analog FM uplink transmit
 INPUT PORT: Mobile
 INPUT POWER: -54 dBm
 CONFIGURATION: Single Band

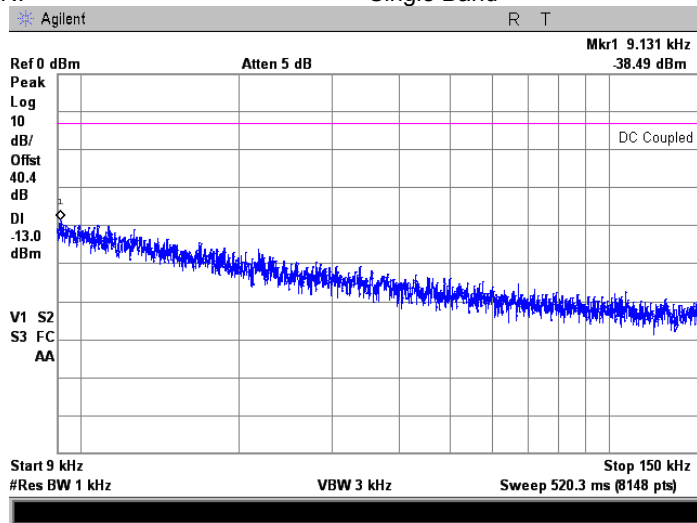

Plot 7.8.136 Spurious emission measurements in 0.15 – 30.0 MHz range at low carrier frequency

FREQUENCY RANGE: 806 - 816 MHz
 OPERATIONAL MODE: Analog FM uplink transmit
 INPUT PORT: Mobile
 INPUT POWER: -54 dBm
 CONFIGURATION: Single Band

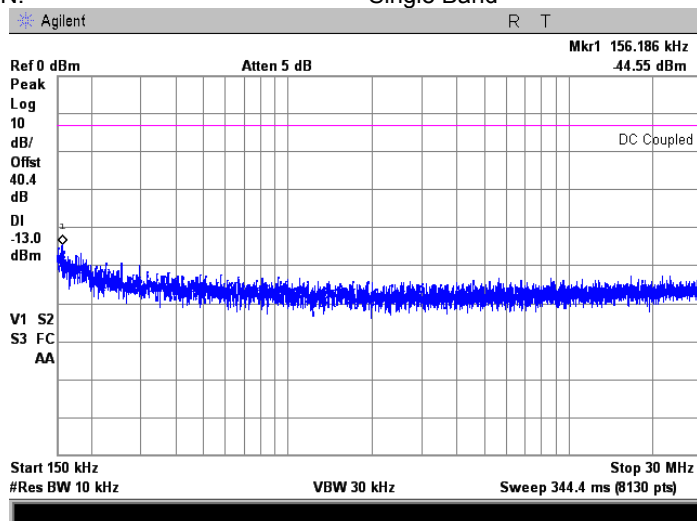

Test specification:		Section 90.219(e)(3), Conducted spurious emissions	
Test procedure:		47 CFR, Sections 2.1051; KDB 935210 D02 v02, Appendix D	
Test mode:		Compliance	
Date(s):		06-Aug-14 - 10-Aug-14	
Temperature: 23.2 °C		Air Pressure: 1008 hPa	
		Relative Humidity: 46 %	
		Power Supply: 120 VAC	
Remarks:			
		Verdict: PASS	

Plot 7.8.137 Spurious emission measurements in 0.15 – 30.0 MHz range at mid carrier frequency

FREQUENCY RANGE: 806 - 816 MHz
 OPERATIONAL MODE: Analog FM uplink transmit
 INPUT PORT: Mobile
 INPUT POWER: -54 dBm
 CONFIGURATION: Single Band

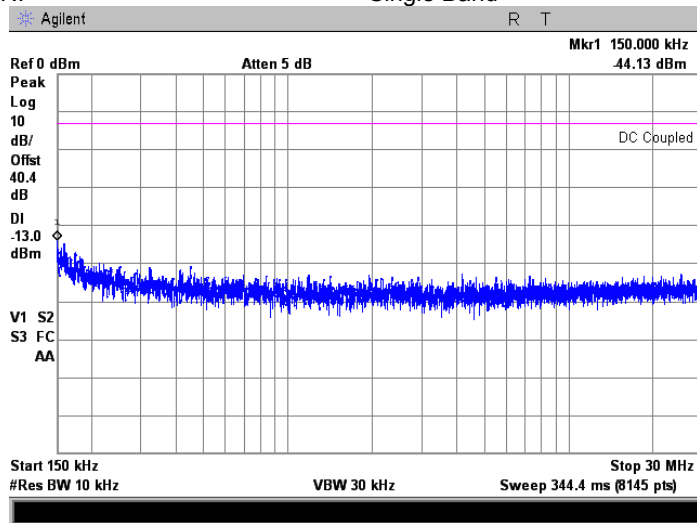

Plot 7.8.138 Spurious emission measurements in 0.15 – 30.0 MHz range at high carrier frequency

FREQUENCY RANGE: 806 - 816 MHz
 OPERATIONAL MODE: Analog FM uplink transmit
 INPUT PORT: Mobile
 INPUT POWER: -54 dBm
 CONFIGURATION: Single Band

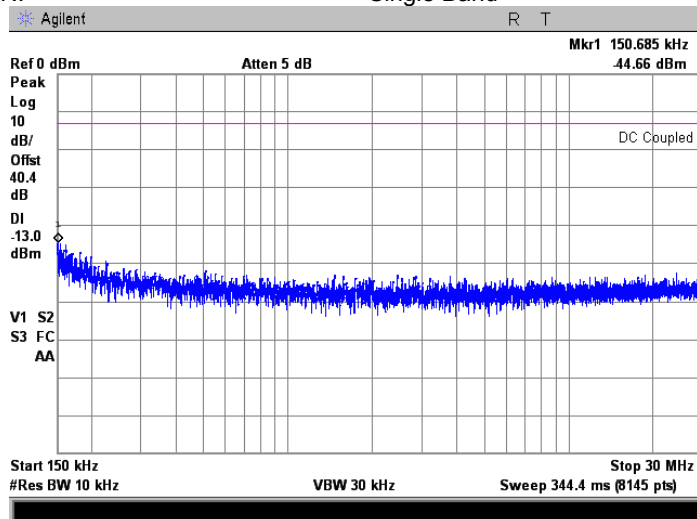

Test specification:		Section 90.219(e)(3), Conducted spurious emissions	
Test procedure:		47 CFR, Sections 2.1051; KDB 935210 D02 v02, Appendix D	
Test mode:		Verdict:	
Compliance		PASS	
Date(s):		06-Aug-14 - 10-Aug-14	
Temperature: 23.2 °C	Air Pressure: 1008 hPa	Relative Humidity: 46 %	Power Supply: 120 VAC
Remarks:			

Plot 7.8.139 Spurious emission measurements in 30.0 - 1000 MHz range at low carrier frequency

FREQUENCY RANGE: 806 - 816 MHz
 OPERATIONAL MODE: Analog FM uplink transmit
 INPUT PORT: Mobile
 INPUT POWER: -54 dBm
 CONFIGURATION: Single Band

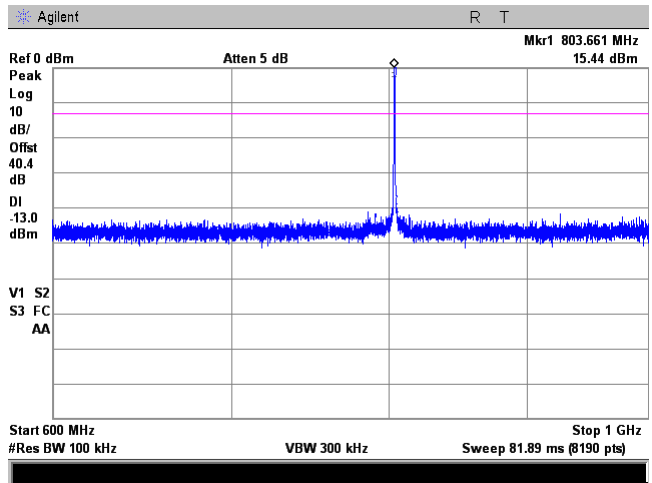
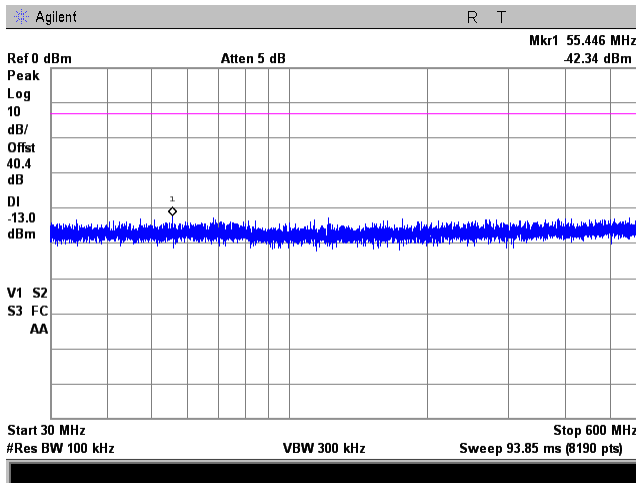

Plot 7.8.140 Spurious emission measurements in 30.0 - 1000 MHz range at mid carrier frequency

FREQUENCY RANGE: 806 - 816 MHz
 OPERATIONAL MODE: Analog FM uplink transmit
 INPUT PORT: Mobile
 INPUT POWER: -54 dBm
 CONFIGURATION: Single Band

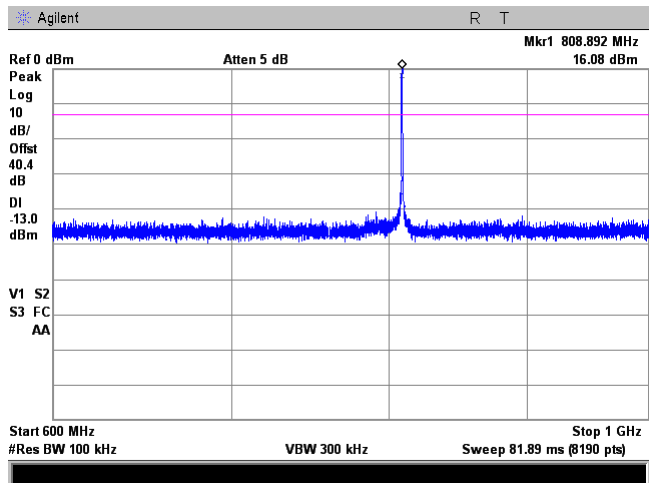
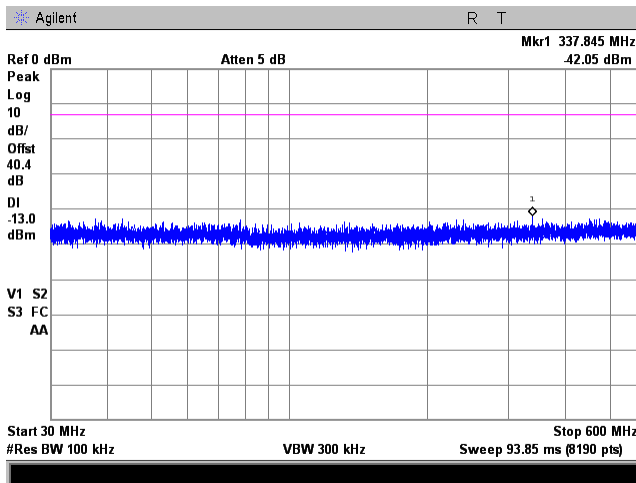

Test specification:		Section 90.219(e)(3), Conducted spurious emissions	
Test procedure:		47 CFR, Sections 2.1051; KDB 935210 D02 v02, Appendix D	
Test mode:		Compliance	
Date(s):		06-Aug-14 - 10-Aug-14	
Temperature: 23.2 °C		Air Pressure: 1008 hPa	
		Relative Humidity: 46 %	
		Power Supply: 120 VAC	
Remarks:			
		Verdict: PASS	

Plot 7.8.141 Spurious emission measurements in 30.0 - 1000 MHz range at high carrier frequency

FREQUENCY RANGE: 806 - 816 MHz
 OPERATIONAL MODE: Analog FM uplink transmit
 INPUT PORT: Mobile
 INPUT POWER: -54 dBm
 CONFIGURATION: Single Band

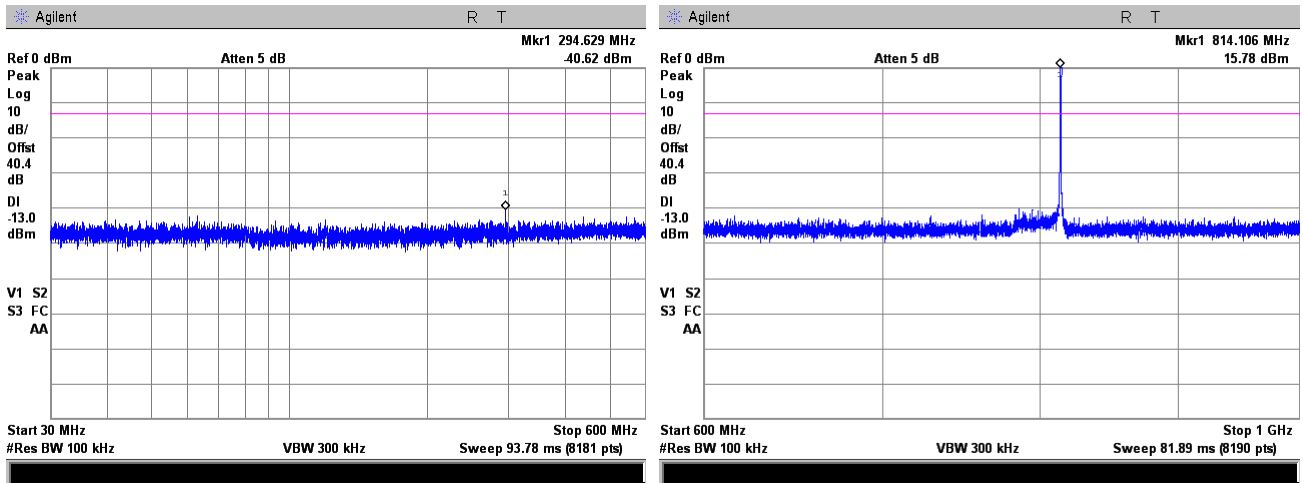

Plot 7.8.142 Spurious emission measurements in 1000 - 8200 MHz range at low carrier frequency

FREQUENCY RANGE: 806 - 816 MHz
 OPERATIONAL MODE: Analog FM uplink transmit
 INPUT PORT: Mobile
 INPUT POWER: -54 dBm
 CONFIGURATION: Single Band

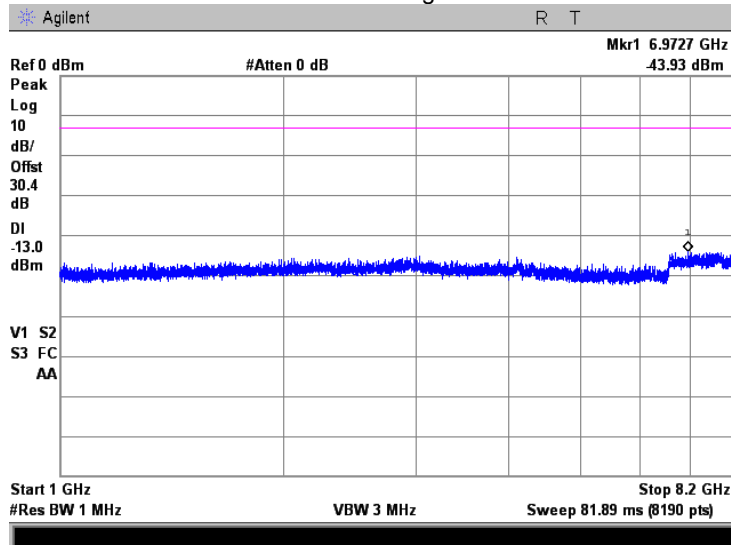

Test specification:		Section 90.219(e)(3), Conducted spurious emissions	
Test procedure:		47 CFR, Sections 2.1051; KDB 935210 D02 v02, Appendix D	
Test mode:		Compliance	
Date(s):		06-Aug-14 - 10-Aug-14	
Temperature: 23.2 °C		Air Pressure: 1008 hPa	
		Relative Humidity: 46 %	
		Power Supply: 120 VAC	
Remarks:			

Plot 7.8.143 Spurious emission measurements in 1000 - 8200 MHz at mid carrier frequency

FREQUENCY RANGE: 806 - 816 MHz
 OPERATIONAL MODE: Analog FM uplink transmit
 INPUT PORT: Mobile
 INPUT POWER: -54 dBm
 CONFIGURATION: Single Band

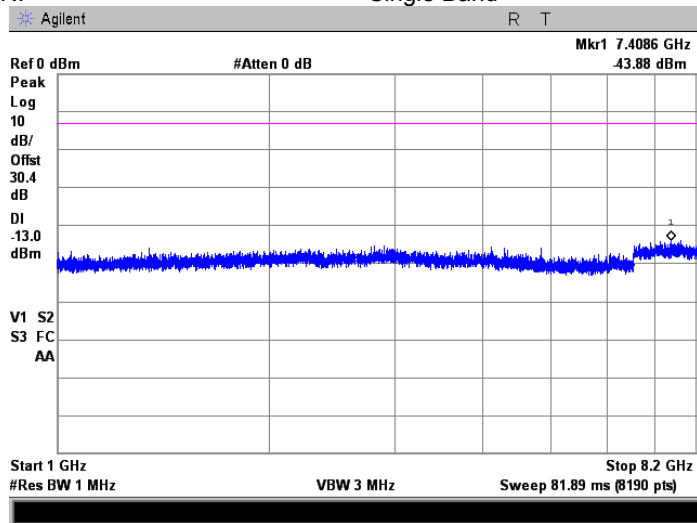

Plot 7.8.144 Spurious emission measurements in 1000 -8200 MHz at high carrier frequency

FREQUENCY RANGE: 806 - 816 MHz
 OPERATIONAL MODE: Analog FM uplink transmit
 INPUT PORT: Mobile
 INPUT POWER: -54 dBm
 CONFIGURATION: Single Band

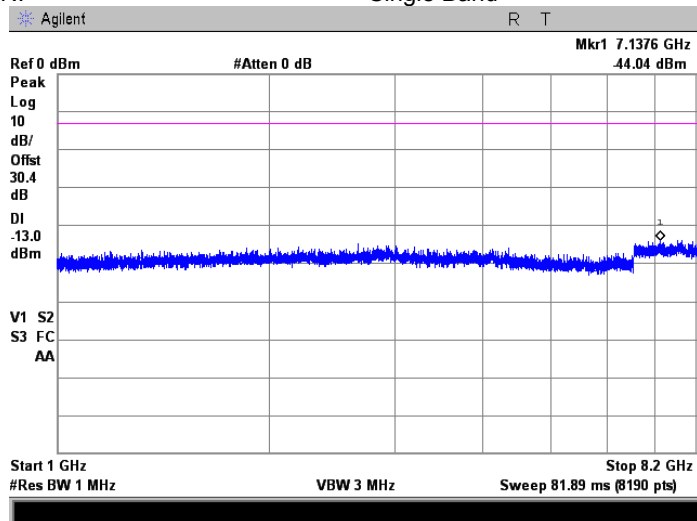

8 APPENDIX A Test equipment and ancillaries used for tests

HL No	Description	Manufacturer	Model	Ser. No.	Last Cal. / Check*	Due Cal. / Check*
0446	Antenna, Loop, Active, 10 kHz - 30 MHz	EMCO	6502	2857	21-Jan-14	21-Jan-15
0521	EMI Receiver (Spectrum Analyzer) with RF filter section 9 kHz-6.5 GHz	Hewlett Packard	8546A	3617A 00319, 3448A002 53	28-Oct-13	28-Oct-14
0539	Generator Signal, 10 kHz - 1.2 GHz	Marconi Instruments	2023	112121/04 1	31-Aug-14	31-Aug-15
0604	Antenna BiconiLog Log-Periodic/T Bow-TIE, 26 - 2000 MHz	EMCO	3141	9611-1011	22-May-14	22-May-15
0789	Power Divider / Combiner 0.5 to 2 GHz	A.E.L. Israel	MW 1225	1023	02-Jul-12	02-Jul-15
1182	Generator, Signal, AM/FM 10 kHz-1000MHz	Marconi Instruments	2022	119019/23 7	04-Mar-14	04-Mar-15
1984	Antenna, Double-Ridged Waveguide Horn, 1-18 GHz, 300 W	EMC Test Systems	3115	9911-5964	03-Jan-14	03-Jan-15
2871	Microwave Cable Assembly, 18 GHz, 6.4 m, SMA - SMA	Huber-Suhner	198-8155-00	2871	04-Dec-13	04-Dec-14
2909	Spectrum analyzer, ESA-E, 100 Hz to 26.5 GHz	Agilent Technologies	E4407B	MY414447 62	23-Dec-13	23-Dec-14
3174	Attenuator, N-type, 10 dB, DC to 18 GHz, 5 W	Mini-Circuits	BW-N10W5+	NA	10-Apr-14	10-Apr-15
3301	Power Meter, P-series, 50 MHz to 40 GHz	Agilent Technologies	N1911A	MY451010 57	12-Feb-14	12-Feb-15
3302	Power sensor, P-Series, 50 MHz to 40 GHz, -35/30 to 20 dBm	Agilent Technologies	N1922A	MY452405 86	12-Feb-14	12-Feb-15
3768	Attenuator, N-type, 20 dB, DC to 18 GHz, 5 W	Mini-Circuits	BW-N20W5+	NA	17-Aug-14	17-Aug-15
3770	Attenuator, N-type, 20 dB, DC to 18 GHz, 5 W	Mini-Circuits	BW-N20W5+	NA	17-Aug-14	17-Aug-15
3776	Attenuator, N-type, 10 dB, DC to 18 GHz, 5 W	Mini-Circuits	BW-N10W5+	NA	17-Aug-14	17-Aug-15
3790	Precision Fixed Attenuator, 50 Ohm, 5 W, 10 dB, DC to 18 GHz	Mini-Circuits	BW-S10W5+	NA	05-Dec-13	05-Dec-14
3818	PSA Series Spectrum Analyzer, 3 Hz- 44 GHz	Agilent Technologies	E4446A	MY482502 88	20-May-14	20-May-15
3901	Microwave Cable Assembly, 40.0 GHz, 3.5 m, SMA/SMA	Huber-Suhner	SUCOFLEX 102A	1225/2A	06-Feb-14	06-Feb-15
3994	Attenuator, N-type, 20 dB, DC to 18 GHz, 5 W	Mini-Circuits	BW-N20W5+	NA	17-Aug-14	17-Aug-15
4150	Preamplifier, 0.1 to 18 GHz, Gain 25 dB, N-type(f) in, N-type(m) out.	Agilent Technologies	87405C	MY470105 91	30-Dec-13	30-Dec-14
4224	Precision Fixed Attenuator, 50 Ohm, 5W, 10dB, DC to 18000 MHz	Mini-Circuits	BW-N10W5+	NA	09-Mar-14	09-Mar-15
4273	Test Cable , DC-18 GHz, 1.8 m, SMA/M - N/M	Mini-Circuits	CBL-6FT-SMNM+	70045	27-Nov-13	27-Nov-14
4274	Test Cable , DC-18 GHz, 1.8 m, SMA/M - N/M	Mini-Circuits	CBL-6FT-SMNM+	70047	27-Nov-13	27-Nov-14

HL No	Description	Manufacturer	Model	Ser. No.	Last Cal. / Check*	Due Cal. / Check*
4275	Test Cable , DC-18 GHz, 1.8 m, SMA/M - N/M	Mini-Circuits	CBL-6FT-SMNM+	70050	27-Nov-13	27-Nov-14
4353	Low Loss Armored Test Cable, DC - 18 GHz, 6.2 m, N type-M/N type-M	MegaPhase	NC29-N1N1-244	12025101003	16-Mar-14	16-Mar-15
4354	Vector Signal Generator,100 kHz to 6.0 GHz	Rohde & Schwarz	SMJ 100A	1403.4507 K02-101777-rc	27-Jun-14	27-Jun-15
4413	Resistive divider, DC to 1.5 GHz, 2 W	Microlab	DA-3FN	NA	15-Jul-14	15-Jul-16

*-the calibration was valid at the testing time

8.1 Test equipment and ancillaries used for tests

HL No.	Description	Manufacturer	Model	Ser. No.	Last Cal./ Check	Due Cal./ Check
NA	Noise Figure Analyzer	Agilent	N8973A	GB39490364	11-Jun-13	10-Jun-15
NA	Noise Source	Agilent	N4000A	MY44420199	11-Jun-13	10-Jun-15

9 APPENDIX B Measurement uncertainties

Expanded uncertainty at 95% confidence in Hermon Labs EMC measurements

Test description	Expanded uncertainty
Transmitter tests	
Carrier power conducted at antenna connector	± 1.7 dB
Carrier power radiated (substitution method)	± 4.5 dB
Occupied bandwidth	±8%
Conducted emissions at RF antenna connector	9 kHz to 2.9 GHz: ± 2.6 dB 2.9 GHz to 6.46 GHz: ± 3.5 dB 6.46 GHz to 13.2 GHz: ± 4.3 dB 13.2 GHz to 22.0 GHz: ± 5.0 dB 22.0 GHz to 26.8 GHz: ± 5.5 dB 26.8 GHz to 40.0 GHz: ± 4.8 dB
Spurious emissions radiated 30 MHz – 40 GHz (substitution method)	± 4.5 dB
Frequency error	30 – 300 MHz: ± 50.5 Hz (1.68 ppm) 300 – 1000 MHz: ± 168 Hz (0.56 ppm)
Transient frequency behaviour	187 Hz ± 13.9 %
Duty cycle, timing (Tx ON / OFF) and average factor measurements	± 1.0 %

Hermon Laboratories is accredited by A2LA for calibration according to present requirements of ISO/IEC 17025 and NCSL Z540-1. The accreditation is granted to perform calibration of parameters that are listed in the Scope of Hermon Laboratories Accreditation.

Hermon Laboratories calibrates its reference and transfer standards by calibration laboratories accredited to ISO/IEC 17025 by a mutually recognized Accreditation Body or by a recognized national metrology institute. All reference and transfer standards used in the calibration system are traceable to national or international standards.

In-house calibration of all test and measurement equipment is performed on a regular basis according to Hermon Laboratories calibration procedures, manufacturer calibration/verification procedures or procedures defined in the relevant standards. The Hermon Laboratories test and measurement equipment is calibrated within the tolerances specified by the manufacturers and/or by the relevant standards.

10 APPENDIX C Test facility description

Tests were performed at Hermon Laboratories Ltd., which is a fully independent, private, EMC, safety, environmental and telecommunication testing facility.

Hermon Laboratories is listed by the Federal Communications Commission (USA) for all parts of Code of Federal Regulations 47 (CFR 47), Registration Numbers 90624 for OATS and 90623 for the anechoic chamber; by Industry Canada for electromagnetic emissions (file numbers IC 2186A-1 for OATS, IC 2186A-2 for anechoic chamber, IC 2186A-3 for full-anechoic chamber for RE measurements above 1 GHz), certified by VCCI, Japan (the registration numbers are R-808 for OATS, R-1082 for anechoic chamber, G-27 for full-anechoic chamber for RE measurements above 1 GHz, C-845 for conducted emissions site, T-1606 for conducted emissions at telecommunication ports), has a status of a Telefication - Listed Testing Laboratory, Certificate No. L138/00. The laboratory is accredited by American Association for Laboratory Accreditation (USA) according to ISO/IEC 17025 for electromagnetic compatibility, product safety, telecommunications testing and environmental simulation (for exact scope please refer to Certificate No. 839.01). The FCC Designation Number is US1003.

Address: P.O. Box 23, Binyamina 30500, Israel.
Telephone: +972 4628 8001
Fax: +972 4628 8277
e-mail: mail@hermonlabs.com
website: www.hermonlabs.com

Person for contact: Mr. Alex Usoskin, CEO.

11 APPENDIX D Specification references

47CFR part 90: 2013	Private land mobile radio services
47CFR part 2: 2013	Frequency allocations and radio treaty matters; general rules and regulations
ANSI C63.2: 1996	American National Standard for Instrumentation-Electromagnetic Noise and Field Strength, 10 kHz to 40 GHz-Specifications.
ANSI C63.4: 2003	American National Standard for Methods of Measurement of Radio-Noise Emissions from Low-Voltage Electrical and Electronic Equipment in the Range of 9 kHz to 40 GHz.
ANSI/TIA/EIA-603-C:2004	Land Mobile FM or PM Communications Equipment Measurement and Performance Standards
KDB 935210 D02 v02:4.04.2014	Signal Boosters Certification

12 APPENDIX E Test equipment correction factors

Antenna factor
Active loop antenna
Model 6502, S/N 2857, HL 0446

Frequency, MHz	Magnetic antenna factor, dB	Electric antenna factor, dB
0.009	-32.8	18.7
0.010	-33.8	17.7
0.020	-38.3	13.2
0.050	-41.1	10.4
0.075	-41.3	10.2
0.100	-41.6	9.9
0.150	-41.7	9.8
0.250	-41.6	9.9
0.500	-41.8	9.8
0.750	-41.9	9.7
1.000	-41.4	10.1
2.000	-41.5	10.0
3.000	-41.4	10.2
4.000	-41.4	10.1
5.000	-41.5	10.1
10.000	-41.9	9.6
15.000	-41.9	9.6
20.000	-42.2	9.3
25.000	-42.8	8.7
30.000	-44.0	7.5

Antenna factor in dB(1/m) is to be added to receiver meter reading in dB(μ V) to convert it into field strength in dB(μ V/m).

**Antenna factor
Biconilog antenna EMCO Model 3141
Ser.No.1011, HL 0604**

Frequency, MHz	Antenna factor, dB(1/m)	Frequency, MHz	Antenna factor, dB(1/m)	Frequency, MHz	Antenna factor, dB(1/m)
26	7.8	580	20.6	1320	27.8
28	7.8	600	21.3	1340	28.3
30	7.8	620	21.5	1360	28.2
40	7.2	640	21.2	1380	27.9
60	7.1	660	21.4	1400	27.9
70	8.5	680	21.9	1420	27.9
80	9.4	700	22.2	1440	27.8
90	9.8	720	22.2	1460	27.8
100	9.7	740	22.1	1480	28.0
110	9.3	760	22.3	1500	28.5
120	8.8	780	22.6	1520	28.9
130	8.7	800	22.7	1540	29.6
140	9.2	820	22.9	1560	29.8
150	9.8	840	23.1	1580	29.6
160	10.2	860	23.4	1600	29.5
170	10.4	880	23.8	1620	29.3
180	10.4	900	24.1	1640	29.2
190	10.3	920	24.1	1660	29.4
200	10.6	940	24.0	1680	29.6
220	11.6	960	24.1	1700	29.8
240	12.4	980	24.5	1720	30.3
260	12.8	1000	24.9	1740	30.8
280	13.7	1020	25.0	1760	31.1
300	14.7	1040	25.2	1780	31.0
320	15.2	1060	25.4	1800	30.9
340	15.4	1080	25.6	1820	30.7
360	16.1	1100	25.7	1840	30.6
380	16.4	1120	26.0	1860	30.6
400	16.6	1140	26.4	1880	30.6
420	16.7	1160	27.0	1900	30.6
440	17.0	1180	27.0	1920	30.7
460	17.7	1200	26.7	1940	30.9
480	18.1	1220	26.5	1960	31.2
500	18.5	1240	26.5	1980	31.6
520	19.1	1260	26.5	2000	32.0
540	19.5	1280	26.6		
560	19.8	1300	27.0		

Antenna factor in dB(1/m) is to be added to receiver meter reading in dB(μ V) to convert it into field strength in dB(μ V/m).

Antenna factor
Double-ridged wave guide horn antenna
Model 3115, S/N 9911-5964, HL1984

Frequency, MHz	Antenna factor, dB(1/m)
1000.0	24.7
1500.0	25.7
2000.0	27.6
2500.0	28.9
3000.0	31.2
3500.0	32.0
4000.0	32.5
4500.0	32.7
5000.0	33.6
5500.0	35.1
6000.0	35.4
6500.0	34.9
7000.0	36.1
7500.0	37.8
8000.0	38.0
8500.0	38.1
9000.0	39.1
9500.0	38.3
10000.0	38.6
10500.0	38.2
11000.0	38.7
11500.0	39.5
12000.0	40.0
12500.0	40.4
13000.0	40.5
13500.0	41.1
14000.0	41.6
14500.0	41.7
15000.0	38.7
15500.0	38.2
16000.0	38.8
16500.0	40.5
17000.0	42.5
17500.0	45.9
18000.0	49.4

Antenna factor in dB(1/m) is to be added to receiver meter reading in dB(μ V) to convert it into field strength in dB(μ V/m).



Cable loss
Cable coaxial, Huber-Suhner, 18 GHz, 6.4 m, SMA - SMA, model 198-8155-00,
HL 2871

Frequency, MHz	Cable loss, dB	Frequency, MHz	Cable loss, dB	Frequency, MHz	Cable loss, dB
10	0.12	5750	2.34	12000	3.55
30	0.14	6000	2.39	12250	3.61
100	0.27	6250	2.46	12500	3.67
250	0.45	6500	2.52	12750	3.74
500	0.63	6750	2.58	13000	3.79
750	0.76	7000	2.64	13250	3.82
1000	0.89	7250	2.68	13500	3.83
1250	1.01	7500	2.73	13750	3.83
1500	1.12	7750	2.78	14000	3.88
1750	1.23	8000	2.83	14250	3.93
2000	1.32	8250	2.88	14500	3.96
2250	1.41	8500	2.94	14750	4.01
2500	1.49	8750	2.97	15000	4.00
2750	1.58	9000	3.02	15250	4.01
3000	1.66	9250	3.07	15500	4.00
3250	1.73	9500	3.13	15750	4.13
3500	1.80	9750	3.18	16000	4.22
3750	1.87	10000	3.21	16250	4.29
4000	1.93	10250	3.26	16500	4.29
4250	2.01	10500	3.30	16750	4.32
4500	2.06	10750	3.36	17000	4.37
4750	2.12	11000	3.39	17250	4.45
5000	2.17	11250	3.44	17500	4.49
5250	2.24	11500	3.48	17750	4.53
5500	2.29	11750	3.52	18000	4.55

Cable loss
Microwave Cable Assembly, Huber-Suhner, 40 GHz, 3.5 m, SMA-SMA, S/N 1225/2A
HL 3901

Frequency, MHz	Cable loss, dB	Frequency, MHz	Cable loss, dB	Frequency, MHz	Cable loss, dB
10	0.09	9500	4.29	21000	6.67
100	0.41	10000	4.40	22000	6.92
500	0.93	10500	4.52	23000	7.00
1000	1.33	11000	4.64	24000	7.18
1500	1.63	11500	4.76	25000	7.29
2000	1.90	12000	4.87	26000	7.55
2500	2.12	12500	4.99	27000	7.70
3000	2.33	13000	5.11	28000	7.88
3500	2.50	13500	5.20	29000	8.02
4000	2.67	14000	5.31	30000	8.15
4500	2.82	14500	5.42	31000	8.35
5000	2.99	15000	5.51	32000	8.40
5500	3.16	15500	5.58	33000	8.62
6000	3.32	16000	5.68	34000	8.73
6500	3.51	16500	5.78	35000	8.78
7000	3.65	17000	5.91	36000	8.94
7500	3.79	17500	5.99	37000	9.21
8000	3.92	18000	6.07	38000	9.37
8500	4.04	19000	6.36	39000	9.45
9000	4.18	20000	6.49	40000	9.52



Cable loss
Test cable, Mini-Circuits, S/N 70045, 18 GHz, 1.8 m, SMA/M - N/M
CBL-6FT-SMNM+, HL 4273

Frequency, MHz	Cable loss, dB	Frequency, MHz	Cable loss, dB	Frequency, MHz	Cable loss, dB	Frequency, MHz	Cable loss, dB
10	0.09	4800	1.76	9800	2.70	14800	3.59
30	0.11	4900	1.78	9900	2.71	14900	3.59
50	0.14	5000	1.81	10000	2.73	15000	3.60
100	0.20	5100	1.82	10100	2.75	15100	3.63
200	0.30	5200	1.86	10200	2.76	15200	3.67
300	0.38	5300	1.89	10300	2.79	15300	3.70
400	0.45	5400	1.92	10400	2.81	15400	3.68
500	0.50	5500	1.96	10500	2.82	15500	3.70
600	0.55	5600	2.00	10600	2.83	15600	3.71
700	0.60	5700	2.03	10700	2.87	15700	3.77
800	0.65	5800	2.04	10800	2.87	15800	3.75
900	0.69	5900	2.07	10900	2.88	15900	3.77
1000	0.73	6000	2.10	11000	2.89	16000	3.79
1100	0.77	6100	2.10	11100	2.91	16100	3.85
1200	0.80	6200	2.11	11200	2.92	16200	3.82
1300	0.84	6300	2.11	11300	2.94	16300	3.83
1400	0.88	6400	2.14	11400	2.95	16400	3.88
1500	0.92	6500	2.15	11500	2.98	16500	3.89
1600	0.95	6600	2.15	11600	3.00	16600	3.92
1700	0.98	6700	2.16	11700	3.02	16700	3.88
1800	1.01	6800	2.19	11800	3.04	16800	3.95
1900	1.04	6900	2.22	11900	3.08	16900	3.91
2000	1.07	7000	2.24	12000	3.09	17000	3.97
2100	1.09	7100	2.26	12100	3.12	17100	3.92
2200	1.13	7200	2.29	12200	3.13	17200	3.94
2300	1.15	7300	2.32	12300	3.16	17300	3.94
2400	1.18	7400	2.36	12400	3.17	17400	3.98
2500	1.21	7500	2.39	12500	3.19	17500	3.93
2600	1.24	7600	2.41	12600	3.20	17600	3.95
2700	1.27	7700	2.43	12700	3.21	17700	3.96
2800	1.30	7800	2.46	12800	3.21	17800	3.97
2900	1.34	7900	2.49	12900	3.22	17900	3.96
3000	1.36	8000	2.52	13000	3.22	18000	3.97
3100	1.38	8100	2.52	13100	3.24		
3200	1.41	8200	2.54	13200	3.24		
3300	1.45	8300	2.59	13300	3.27		
3400	1.46	8400	2.61	13400	3.28		
3500	1.49	8500	2.60	13500	3.31		
3600	1.51	8600	2.63	13600	3.31		
3700	1.55	8700	2.65	13700	3.35		
3800	1.34	8800	2.65	13800	3.37		
3900	1.36	8900	2.65	13900	3.40		
4000	1.38	9000	2.66	14000	3.43		
4100	1.41	9100	2.66	14100	3.45		
4200	1.45	9200	2.67	14200	3.46		
4300	1.46	9300	2.67	14300	3.46		
4400	1.49	9400	2.67	14400	3.49		
4500	1.51	9500	2.68	14500	3.50		
4600	1.55	9600	2.69	14600	3.50		
4700	1.34	9700	2.69	14700	3.52		



Cable loss
Test cable, Mini-Circuits, S/N 70047, 18 GHz, 1.8 m, SMA/M - N/M
CBL-6FT-SMNM+, HL 4274

Frequency, MHz	Cable loss, dB	Frequency, MHz	Cable loss, dB	Frequency, MHz	Cable loss, dB	Frequency, MHz	Cable loss, dB
10	0.07	4800	1.69	9800	2.62	14800	3.42
30	0.11	4900	1.70	9900	2.63	14900	3.39
50	0.14	5000	1.72	10000	2.64	15000	3.38
100	0.21	5100	1.75	10100	2.64	15100	3.40
200	0.26	5200	1.76	10200	2.66	15200	3.41
300	0.30	5300	1.77	10300	2.67	15300	3.40
400	0.37	5400	1.79	10400	2.68	15400	3.39
500	0.44	5500	1.82	10500	2.68	15500	3.41
600	0.49	5600	1.85	10600	2.70	15600	3.44
700	0.54	5700	1.86	10700	2.71	15700	3.46
800	0.58	5800	1.87	10800	2.73	15800	3.45
900	0.63	5900	1.91	10900	2.74	15900	3.47
1000	0.67	6000	1.94	11000	2.76	16000	3.51
1100	0.71	6100	1.97	11100	2.77	16100	3.56
1200	0.75	6200	1.98	11200	2.78	16200	3.55
1300	0.78	6300	1.99	11300	2.79	16300	3.54
1400	0.81	6400	2.02	11400	2.80	16400	3.57
1500	0.85	6500	2.05	11500	2.82	16500	3.62
1600	0.88	6600	2.06	11600	2.83	16600	3.61
1700	0.91	6700	2.06	11700	2.84	16700	3.60
1800	0.94	6800	2.08	11800	2.85	16800	3.62
1900	0.97	6900	2.10	11900	2.87	16900	3.68
2000	1.00	7000	2.12	12000	2.88	17000	3.70
2100	1.03	7100	2.12	12100	2.89	17100	3.68
2200	1.06	7200	2.13	12200	2.90	17200	3.70
2300	1.08	7300	2.16	12300	2.92	17300	3.80
2400	1.11	7400	2.19	12400	2.94	17400	3.84
2500	1.14	7500	2.22	12500	2.95	17500	3.83
2600	1.16	7600	2.23	12600	2.96	17600	3.83
2700	1.19	7700	2.26	12700	2.98	17700	3.86
2800	1.21	7800	2.30	12800	3.00	17800	3.86
2900	1.27	7900	2.33	12900	3.02	17900	3.80
3000	1.29	8000	2.35	13000	3.03	18000	3.79
3100	1.32	8100	2.37	13100	3.06		
3200	1.35	8200	2.41	13200	3.08		
3300	1.37	8300	2.44	13300	3.09		
3400	1.38	8400	2.47	13400	3.10		
3500	1.41	8500	2.48	13500	3.13		
3600	1.43	8600	2.51	13600	3.17		
3700	1.46	8700	2.53	13700	3.17		
3800	1.47	8800	2.55	13800	3.18		
3900	1.49	8900	2.56	13900	3.22		
4000	1.52	9000	2.57	14000	3.26		
4100	1.55	9100	2.58	14100	3.28		
4200	1.56	9200	2.59	14200	3.30		
4300	1.58	9300	2.59	14300	3.35		
4400	1.60	9400	2.60	14400	3.39		
4500	1.63	9500	2.60	14500	3.39		
4600	1.65	9600	2.61	14600	3.39		
4700	1.67	9700	2.61	14700	3.41		



Cable loss
Test cable, Mini-Circuits, S/N 70050, 18 GHz, 1.8 m, SMA/M - N/M
CBL-6FT-SMNM+, HL 4275

Frequency, MHz	Cable loss, dB	Frequency, MHz	Cable loss, dB	Frequency, MHz	Cable loss, dB	Frequency, MHz	Cable loss, dB
10	0.08	5000	1.71	10200	2.64	15400	3.46
30	0.11	5100	1.73	10300	2.65	15500	3.47
50	0.14	5200	1.75	10400	2.66	15600	3.52
100	0.21	5300	1.76	10500	2.67	15700	3.55
200	0.30	5400	1.77	10600	2.70	15800	3.55
300	0.37	5500	1.82	10700	2.71	15900	3.55
400	0.43	5600	1.84	10800	2.72	16000	3.61
500	0.49	5700	1.86	10900	2.73	16100	3.62
600	0.54	5800	1.86	11000	2.75	16200	3.63
700	0.58	5900	1.89	11100	2.77	16300	3.62
800	0.62	6000	1.94	11200	2.78	16400	3.66
900	0.66	6100	1.95	11300	2.80	16500	3.71
1000	0.70	6200	1.96	11400	2.82	16600	3.71
1100	0.74	6300	1.97	11500	2.83	16700	3.67
1200	0.78	6400	2.01	11600	2.84	16800	3.69
1300	0.81	6500	2.03	11700	2.86	16900	3.74
1400	0.84	6600	2.02	11800	2.88	17000	3.73
1500	0.88	6700	2.02	11900	2.89	17100	3.71
1600	0.91	6800	2.05	12000	2.90	17200	3.73
1700	0.94	6900	2.06	12100	2.92	17300	3.77
1800	0.97	7000	2.07	12200	2.93	17400	3.77
1900	1.00	7100	2.07	12300	2.94	17500	3.76
2000	1.02	7200	2.08	12400	2.96	17600	3.76
2100	1.05	7300	2.11	12500	2.98	17700	3.78
2200	1.07	7400	2.13	12600	2.99	17800	3.80
2300	1.10	7500	2.15	12700	3.01	17900	3.79
2400	1.13	7600	2.16	12800	3.03	18000	3.78
2500	1.15	7700	2.18	12900	3.05		
2600	1.18	7800	2.21	13000	3.07		
2700	1.20	7900	2.24	13100	3.09		
2800	1.24	8000	2.25	13200	3.12		
2900	1.26	8100	2.26	13300	3.13		
3000	1.28	8200	2.29	13400	3.14		
3100	1.30	8300	2.31	13500	3.16		
3200	1.33	8400	2.33	13600	3.18		
3300	1.36	8500	2.33	13700	3.19		
3400	1.37	8600	2.34	13800	3.21		
3500	1.39	8700	2.36	13900	3.23		
3600	1.42	8800	2.38	14000	3.25		
3700	1.45	8900	2.39	14100	3.26		
3800	1.46	9000	2.40	14200	3.27		
3900	1.48	9100	2.42	14300	3.30		
4000	1.50	9200	2.45	14400	3.32		
4100	1.53	9300	2.46	14500	3.33		
4200	1.55	9400	2.48	14600	3.34		
4300	1.57	9500	2.50	14700	3.36		
4400	1.59	9600	2.52	14800	3.39		
4500	1.61	9700	2.54	14900	3.40		
4600	1.64	9800	2.56	15000	3.41		
4700	1.66	9900	2.58	15100	3.41		
4800	1.67	10000	2.60	15200	3.44		
4900	1.69	10100	2.61	15300	3.46		

Cable loss
Low Loss Armored Test Cable, MegaPhase, 18 GHz, 6.2 m, N type-M/N type-M,
NC29-N1N1-244S/N 12025101 003,
HL 4353

Frequency, MHz	Cable loss, dB	Frequency, MHz	Cable loss, dB
50	0.20	9000	2.71
100	0.27	9500	2.81
300	0.47	10000	2.90
500	0.61	10500	2.97
1000	0.87	11000	3.06
1500	1.07	11500	3.13
2000	1.24	12000	3.20
2500	1.39	12500	3.26
3000	1.53	13000	3.34
3500	1.65	13500	3.39
4000	1.77	14000	3.47
4500	1.89	14500	3.54
5000	1.99	15000	3.62
5500	2.07	15500	3.69
6000	2.20	16000	3.76
6500	2.30	16500	3.83
7000	2.39	17000	3.86
7500	2.51	17500	3.94
8000	2.58	18000	4.02
8500	2.65		

13 APPENDIX F Abbreviations and acronyms

A	ampere
AC	alternating current
AM	amplitude modulation
AVRG	average (detector)
BB	broad band
cm	centimeter
dB	decibel
dBm	decibel referred to one milliwatt
dB(μ V)	decibel referred to one microvolt
dB(μ V/m)	decibel referred to one microvolt per meter
dB(μ A)	decibel referred to one microampere
DC	direct current
EIRP	equivalent isotropically radiated power
ERP	effective radiated power
EUT	equipment under test
F	frequency
GHz	gigahertz
GND	ground
H	height
HL	Hermon laboratories
Hz	hertz
k	kilo
kHz	kilohertz
LO	local oscillator
m	meter
MHz	megahertz
min	minute
mm	millimeter
ms	millisecond
μ s	microsecond
NA	not applicable
NB	narrow band
OATS	open area test site
Ω	Ohm
QP	quasi-peak
RE	radiated emission
RF	radio frequency
rms	root mean square
Rx	receive
s	second
T	temperature
Tx	transmit
V	volt

END OF DOCUMENT