



TEST REPORT NO: RU1189/6441  
COPY NO: 2  
ISSUE NO: 2  
FCC ID: NEOCCE-470N3

**REPORT ON THE CERTIFICATION TESTING OF  
AERIAL FACILITIES LIMITED  
60-055901  
DOWNLINK ONLY  
WITH RESPECT TO  
THE FCC RULES CFR 47, PART 90 SUBPART I**

TEST DATE: 11<sup>th</sup> – 13<sup>th</sup> July 2005

TESTED BY: \_\_\_\_\_ J CHARTERS

APPROVED BY: \_\_\_\_\_ P GREEN  
PRODUCT MANAGER  
EMC

DATE: 2<sup>nd</sup> August 2005  
\_\_\_\_\_

Distribution:

- Copy Nos:
1. Aerial Facilities Limited
  2. TCB: CKC Certification Services
  3. TRL EMC

THIS DOCUMENT MAY BE REPRODUCED ONLY IN ITS ENTIRETY AND WITHOUT CHANGE



## CONTENTS

	<b>PAGE</b>		
CERTIFICATE OF CONFORMITY & COMPLIANCE	3		
APPLICANT'S SUMMARY	4		
EQUIPMENT TEST CONDITIONS	5		
TESTS REQUIRED	5		
TEST RESULTS	6-26		
		<b>ANNEX</b>	
PHOTOGRAPHS		A	
PHOTOGRAPH No. 1: Test setup			
PHOTOGRAPH No. 2: Test setup			
TEST EQUIPMENT CALIBRATION DETAILS		B	
<b>Notes:</b>			
1. Component failure during test	YES		[ ]
	NO		[X]
2. If Yes, details of failure:			
3. The facilities used for the testing of the product contain in this report are FCC Listed.			



**CERTIFICATE OF CONFORMITY & COMPLIANCE**

FCC IDENTITY:	NEOCCE-470N3
PURPOSE OF TEST:	Certification
TEST SPECIFICATION:	FCC RULES CFR 47, PART 90 SUBPART I
TEST RESULT:	Compliant to Specification
EQUIPMENT UNDER TEST:	60-055901(Downlink only)
EQUIPMENT TYPE:	Booster
MAXIMUM GAIN	58.5dB Downlink
MAXIMUM INPUT	-72.0dBm Downlink
MAXIMUM OUTPUT	-13.5dBm Downlink
ANTENNA TYPE:	Not applicable
CHANNEL SPACING:	25kHz
NUMBER OF CHANNELS:	482.2375MHz 470.2625MHz 470.2125MHz
FREQUENCY GENERATION:	N/A
MODULATION TYPE:	F3E
POWER SOURCE(s):	110Vac
TEST DATE(s):	11 <sup>th</sup> – 13 <sup>th</sup> July 2005
ORDER No(s):	31474
APPLICANT:	Aerial Facilities Limited
ADDRESS:	Aerial House Asheridge Road Chesham Buckinghamshire HP5 1TU United Kingdom
TESTED BY:	----- J CHARTERS
APPROVED BY:	----- P GREEN PRODUCT MANAGER EMC



**EQUIPMENT TEST / EXAMINATIONS REQUIRED**

1.	TEST/EXAMINATION	RULE PART	APPLICABILITY	RESULT
	RF Gain	90.205 2.1046	Yes	Complies
	Audio Frequency Response	TIA EIA-603.3.2.6	N/A	N/A
	Audio Low-Pass Filter Response	TIA EIA-603.3.2.6	N/A	N/A
	Modulation Limiting	TIA EIA-603.3.2.6	N/A	N/A
	Occupied Bandwidth	90.210 2.1049	Yes	Complies
	Spurious Emissions at Antenna Terminals	90.210	Yes	Complies
	Field Strength of Spurious Emissions	90.210 2.1053	Yes	Complies
	Frequency Stability	90.213	N/A	N/A (Note 1)
	Transient behaviour	90.214	N/A	N/A (Note 1)

Notes:

1 The EUT does not contain modulation circuitry, therefore the test was not performed.

2 The EUT does not contain any switching circuitry, therefore the test was not performed.

- 2. Product Use: Cell enhancer
- 3. Emission Designator: F3E
- 4. Temperatures: Ambient (Tnom) 26°C
- 5. Supply Voltages: Vnom 110Vac

Note: Vnom voltages are as stated above unless otherwise shown on the test report page

- 6. Equipment Category:
  - Single channel [ ]
  - Two channel [ ]
  - Multi-channel [X]
- 7. Channel spacing:
  - Narrowband [X]
  - Wideband [ ]
- 8. Test Location
  - TRL Compliance Services
  - Up Holland [X]
  - Long Green [ ]

- 9. Modifications made during test program No modifications were performed.

**COMPLIANCE TESTS**

**TRANSMITTER TEST – GAIN – CONDUCTED – PART 2.1046 – DOWNLINK**

Ambient temperature = 26°C Radio Laboratory  
 Relative humidity = 40%  
 Supply voltage = 110Vac  
 Channel number = See test results

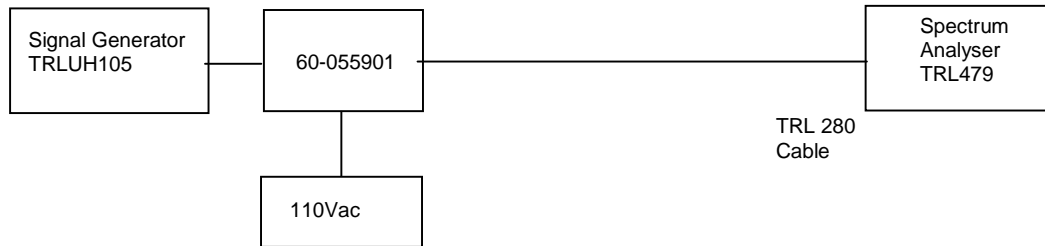

Frequency MHz	Signal Generator Input Level dBm	Cable Loss dB	Level at Spectrum Analyser dBm	Gain dB	Gain after 10dB increase input signal level dBm	Measured Output power dBm
470.2125	-72.0	0.5	-17.5	-55.0	-52.2	-17.0
470.2625	-72.0	0.5	-14.32	- 58.18	-52.7	-13.82
482.2375	-72.0	0.5	-13.95	-58.55	-53.9	-13.45

The test was setup as above. The signal generator was to simulate an input signal to the system from a transmitter and the analyzer used to obtain the output level from the system.

TYPE OF EQUIPMENT	MAKER/SUPPLIER	MODEL No	SERIAL No	TRL No	ACTUAL EQUIPMENT USED
SPECTRUM ANALYSER	ANRITSU	MS2665C	MT26089	479	<b>X</b>
ATTENUATOR	BIRD	8304-200	N/A	103	
ATTENUATOR	BIRD	8304-300-N	N/A	220	
CABLE	ROSENBERGER	MICRO COAX	N/A	280	<b>X</b>
SIGNAL GENERATOR	MARCONI	2023	112224/040	UH105	<b>X</b>

**TRANSMITTER TEST - INTERMODULATION SPURIOUS EMISSIONS – CONDUCTED – PART 2.1053–  
DOWNLINK**

Ambient temperature = 24°C  
 Relative humidity = 43%  
 Supply voltage = 110Vac

Radio Laboratory

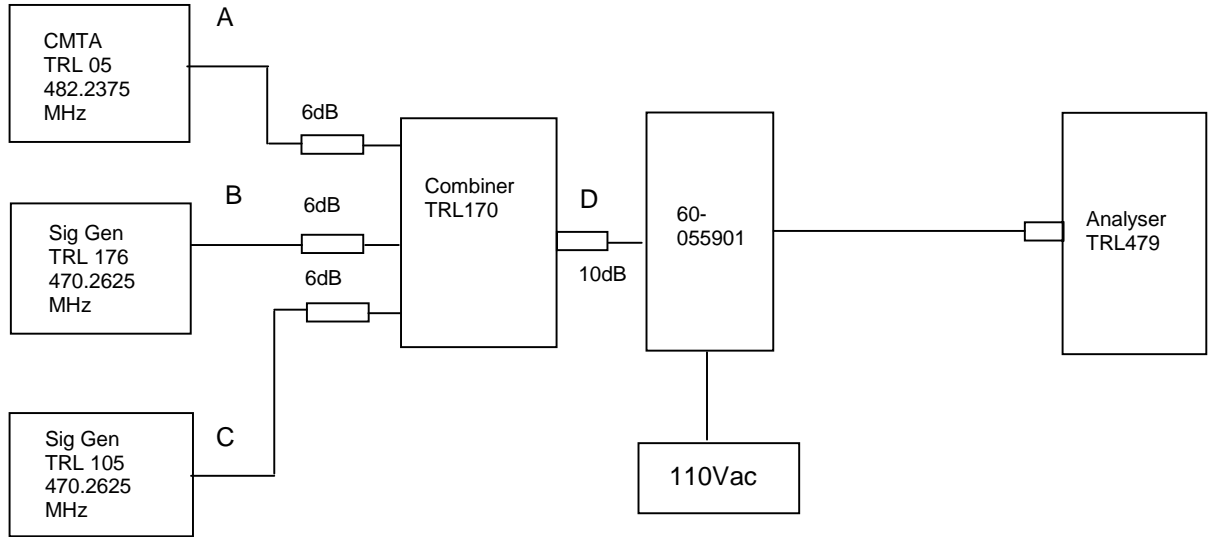

The intermodulation and spurious products were measured with the fibre optic system operating at maximum input level. A three tone test was conducted using the equipment as above. The input power level was adjusted so the level at point D was the maximum input of -72.0dBm.

Sweep data is shown on the next page:

Test equipment used for intermodulation test

TYPE OF EQUIPMENT	MAKER/SUPPLIER	MODEL No	SERIAL No	TRL No	ACTUAL EQUIPMENT USED
SPECTRUM ANALYSER	ANRITSU	MS2665C	MT26089	479	<b>X</b>
SIGNAL GENERATOR	MARCONI	2042	119562/02	254	<b>X</b>
CMTA	ROHDE & SCHWARZ	CMTA52	894715/033	05	<b>X</b>
SIGNAL GENERATOR	MARCONI	2023	112224/040	UH105	<b>X</b>
COMBINER	ELCOM	RC-4-50	N/A	170	<b>x</b>

### Intermodulation Inband

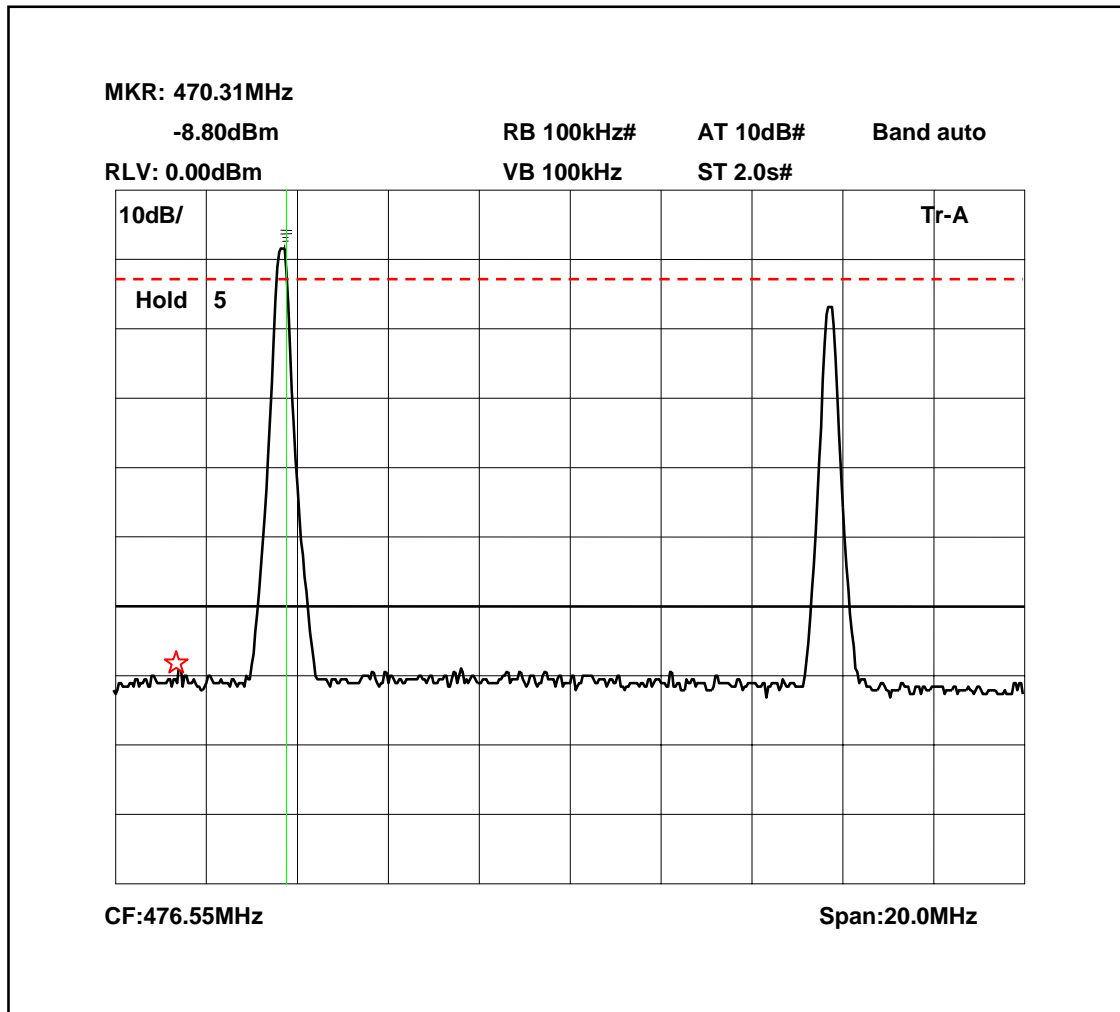

The above plot shows that all products (designated by☆) are at least 50dB below the spurious limit. Based on the maximum input to the system.





**TRANSMITTER TESTS**

**MODULATED BANDWIDTH TEST – CONDUCTED – Part 2.1049– DOWNLINK**

Ambient temperature = 26°C Radio Laboratory  
 Relative humidity = 40%  
 Supply voltage = 110Vac  
 Channel number = See test results

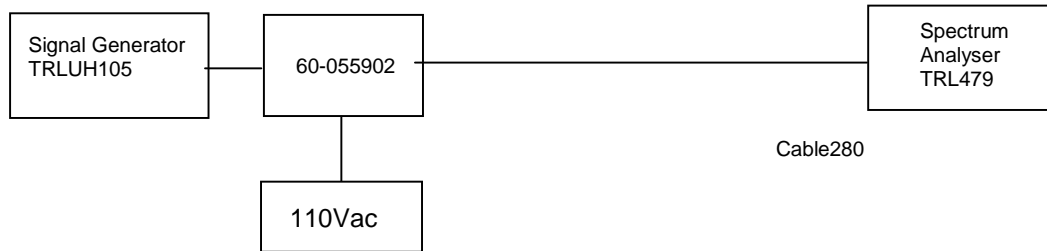

This test was performed to show that the fibre optic system does not alter the input signal in any way. The input signal was set to the maximum input level (-72dBm) and modulated with a 2500Hz tone. The plots show the signal measured at the signal generator and the signal measured at the output of the EUT.

Note: The cables and attenuators had the following losses.

1. Cable TRL280 and Attenuator TRL220 between EUT and spectrum analyser= 0.5dB
2. Cable between signal generator and EUT = 0.22dB

TYPE OF EQUIPMENT	MAKER/SUPPLIER	MODEL No	SERIAL No	TRL No	ACTUAL EQUIPMENT USED
SPECTRUM ANALYSER	ANRITSU	MS2665C	MT26089	479	<b>X</b>
ATTENUATOR	BIRD	8304-200	N/A	103	
ATTENUATOR	BIRD	8304-300-N	N/A	220	<b>X</b>
CABLE	ROSENBERGER	MICRO COAX	N/A	280	<b>X</b>
SIGNAL GENERATOR	MARCONI	2023	112224/040	UH105	<b>X</b>

470.2125MHz Signal Generator deviation set to 5kHz

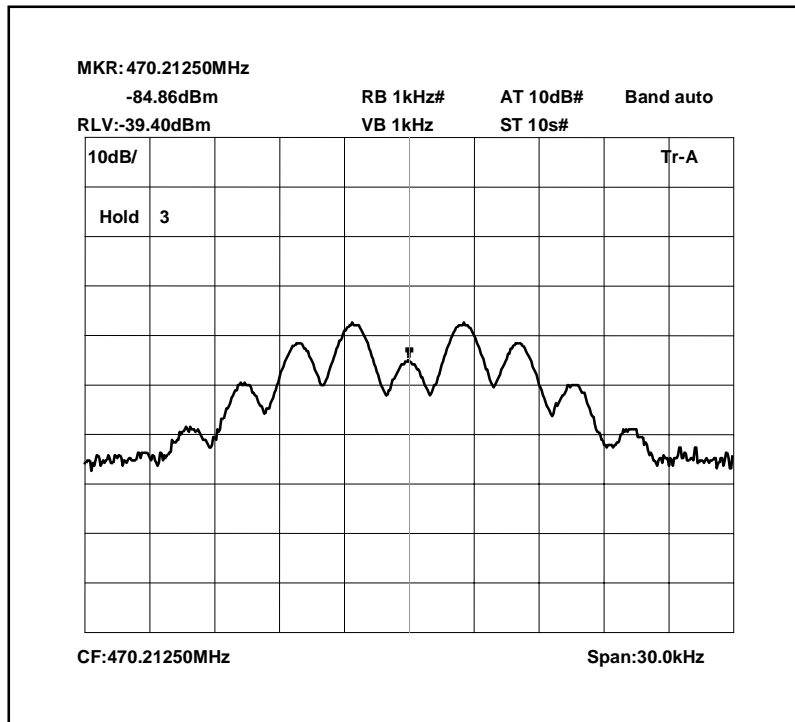

470.2125MHz Signal Generator and amplifier deviation set to 5kHz

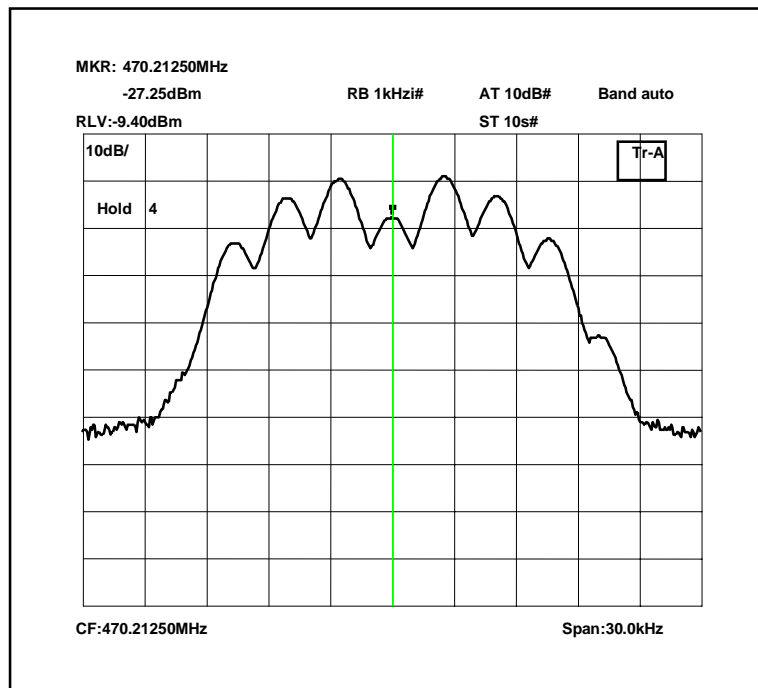

The above plots depicting the output waveshape show no measurable distortion visible when compared to the input signal.

470.2625MHz Signal Generator deviation set to 5kHz

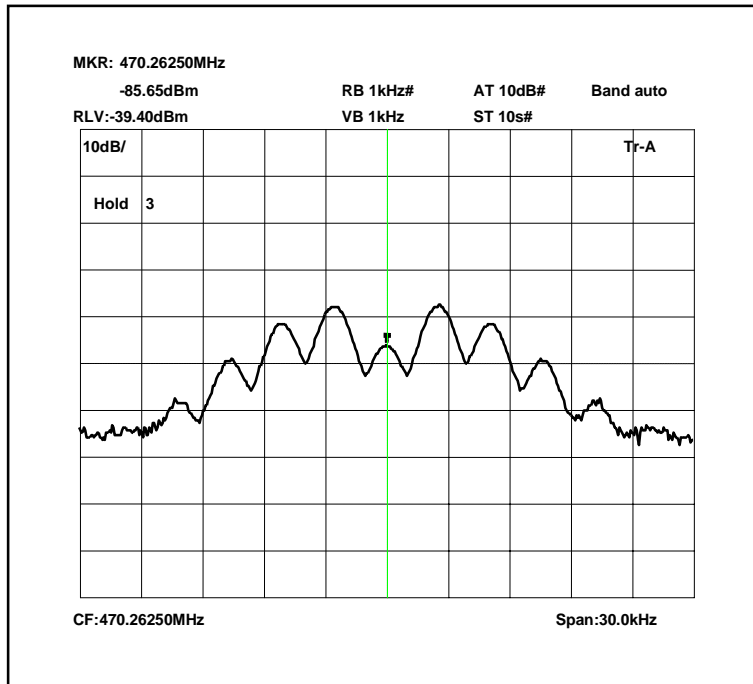

470.2625MHz Signal Generator and amplifier deviation set to 5kHz

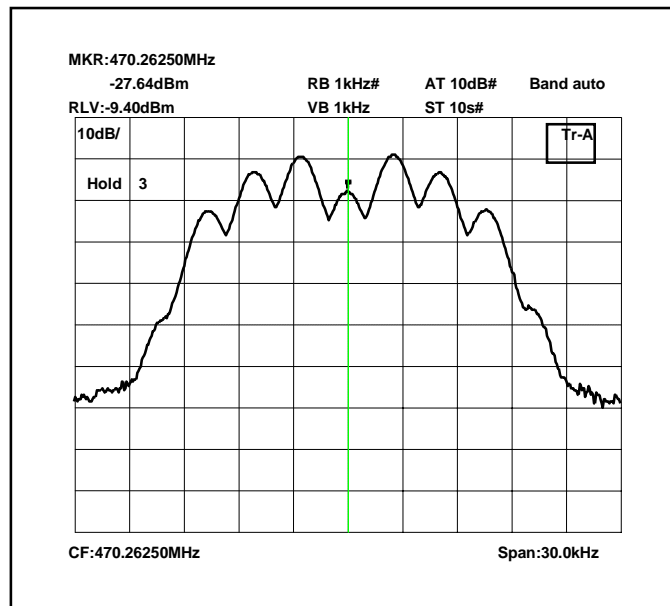

The above plots depicting the output wavsshape show no measurable distortion visible when compared to the input signal.

482.2375MHz Signal Generator deviation set to 5kHz

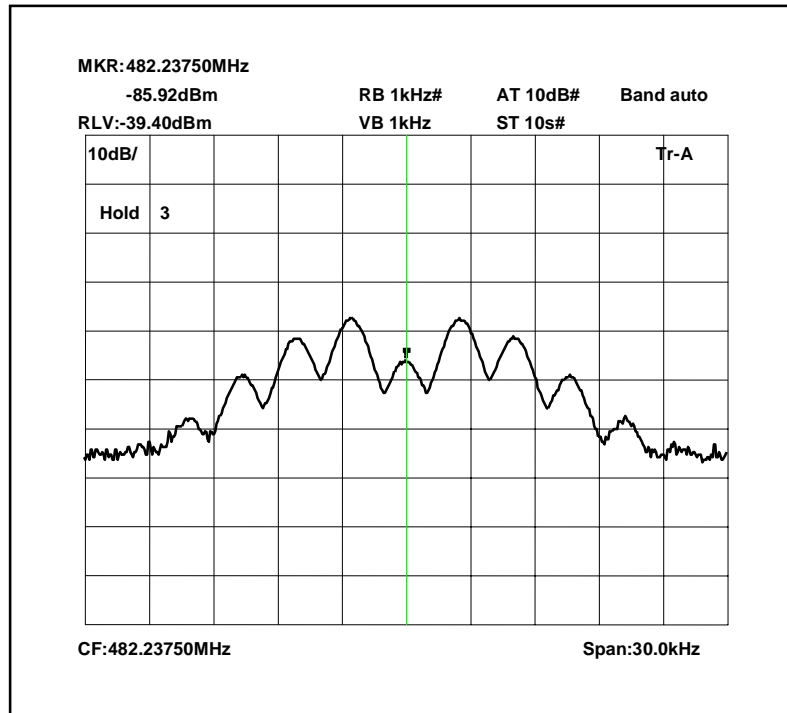

482.2375MHz Signal Generator and amplifier system deviation set to 5kHz

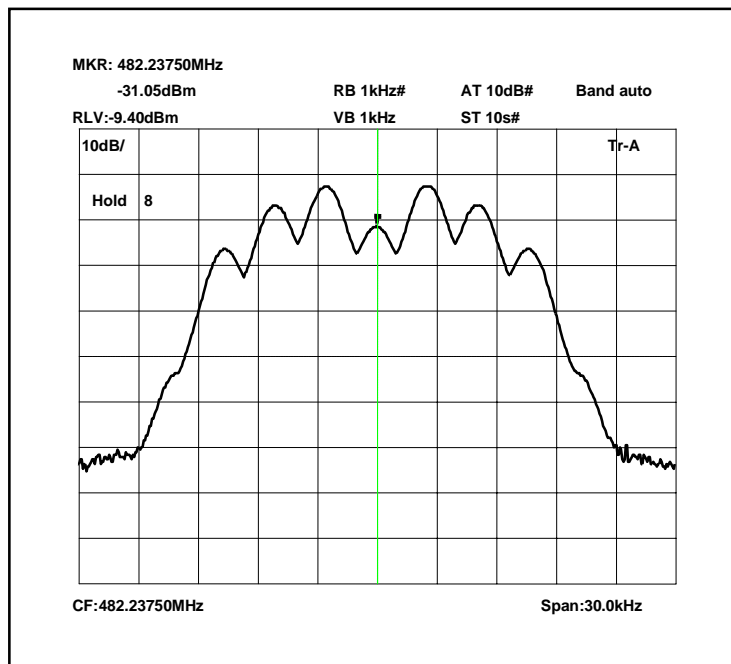

The above plots depicting the output waveshape show no measurable distortion visible when compared to the input signal.

**TRANSMITTER TESTS**

**FIBRE OPTIC SYSTEM SPURIOUS EMISSIONS – CONDUCTED – Part 2.1053 – DOWNLINK**

Ambient temperature = 26°C  
 Relative humidity = 40%  
 Supply voltage = 110Vac

Radio Laboratory  
 Test Signal = F3E

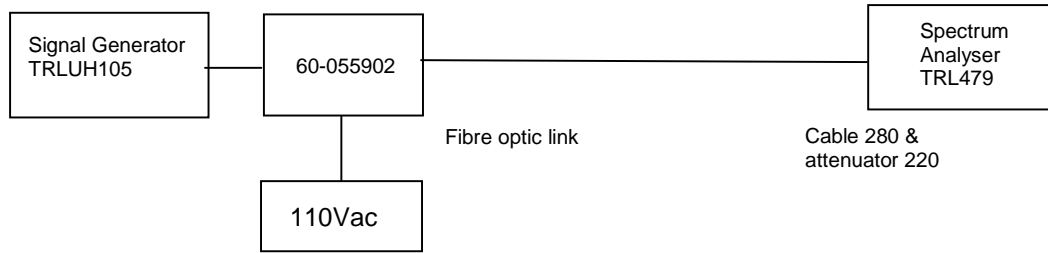

The test was set up as per the diagram. The level at the input was adjusted to compensate for the loss of the interconnecting cable. The unit was tested operating at maximum power and on three test frequencies.

The spurious limit was calculated as follows:

On any frequency removed from the assigned frequency by more that 250% of the authorised bandwidth

At least 43 + 10 log PdB

$$(10\log P_{\text{watts}}) - (43+10\log (P_{\text{watts}} * 1000)) = \text{LIMIT } = -13 \text{ dBm}$$

**Results**

No significant emissions we detected within 20dBm of limit.

The test equipment used for the Transmitter Conducted Emissions:

TYPE OF EQUIPMENT	MAKER/ SUPPLIER	MODEL No	SERIAL No	TRL No	ACTUAL EQUIPMENT USED
SPECTRUM ANALYSER	ANRITSU	MS2665C	MT26089	479	<b>X</b>
ATTENUATOR	BIRD	8304-200	N/A	103	
ATTENUATOR	BIRD	8304-300-N	N/A	220	
CABLE	ROSENBERGER	MICRO COAX	N/A	280	<b>X</b>
SIGNAL GENERATOR	MARCONI	2023	112224/040	UH105	<b>X</b>

Conducted emissions 470.2125 MHz 0 – 2 GHz

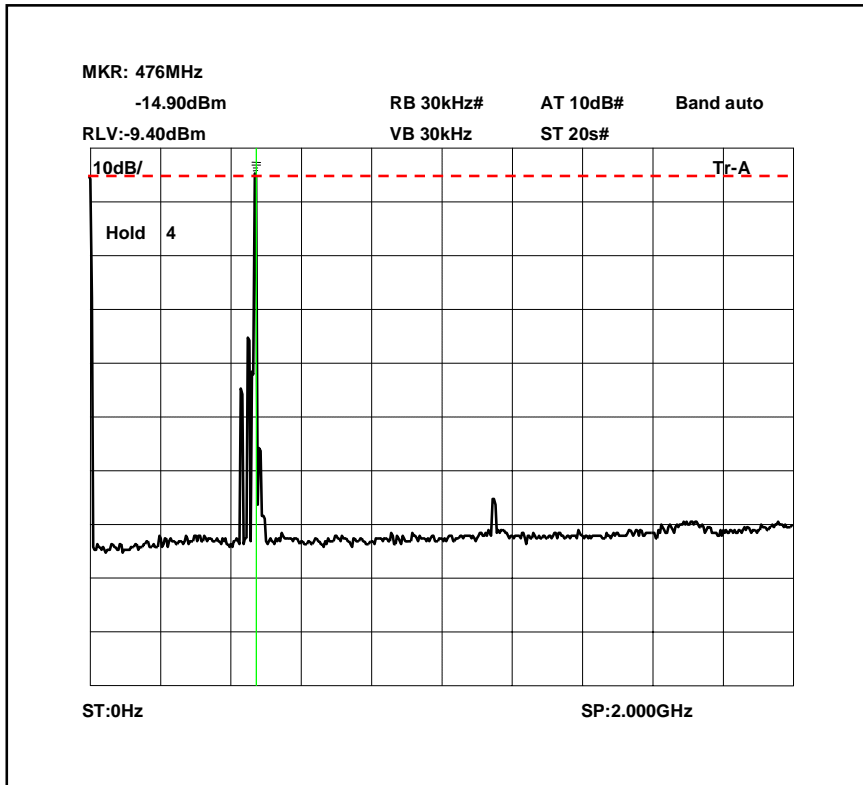

Conducted emissions 470.2125 MHz 2 – 5 GHz

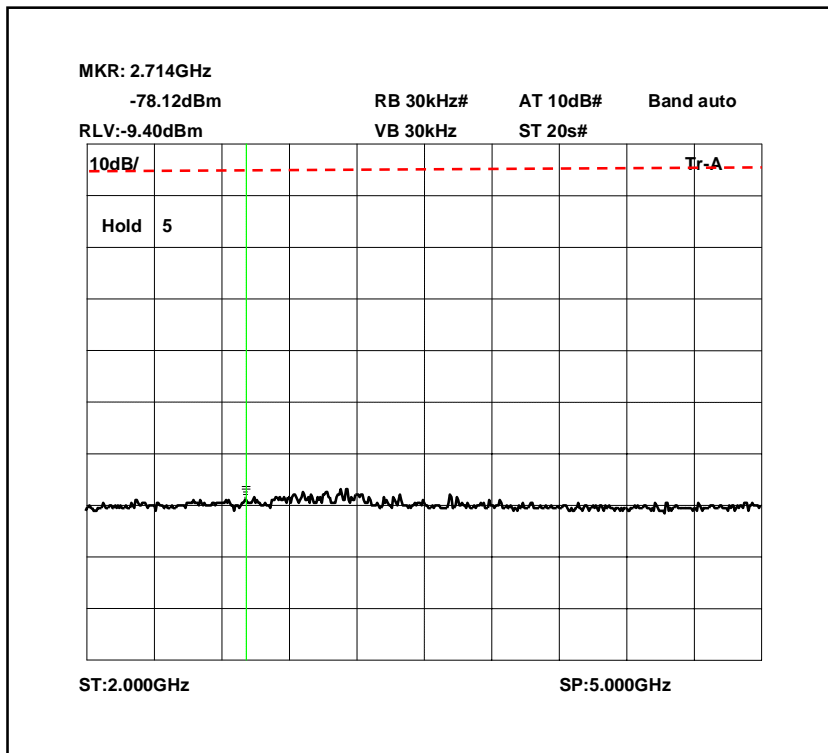

Conducted emissions 470.2625 MHz 0 – 2.0 GHz

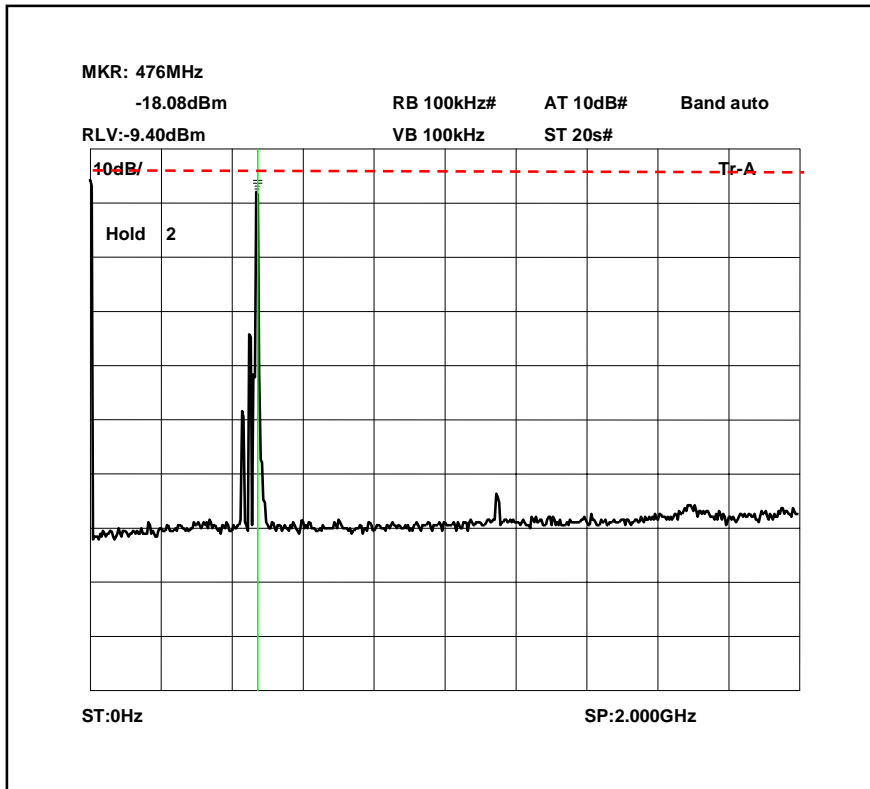

Conducted emissions 470.2625 MHz 2.0 – 5.0 GHz

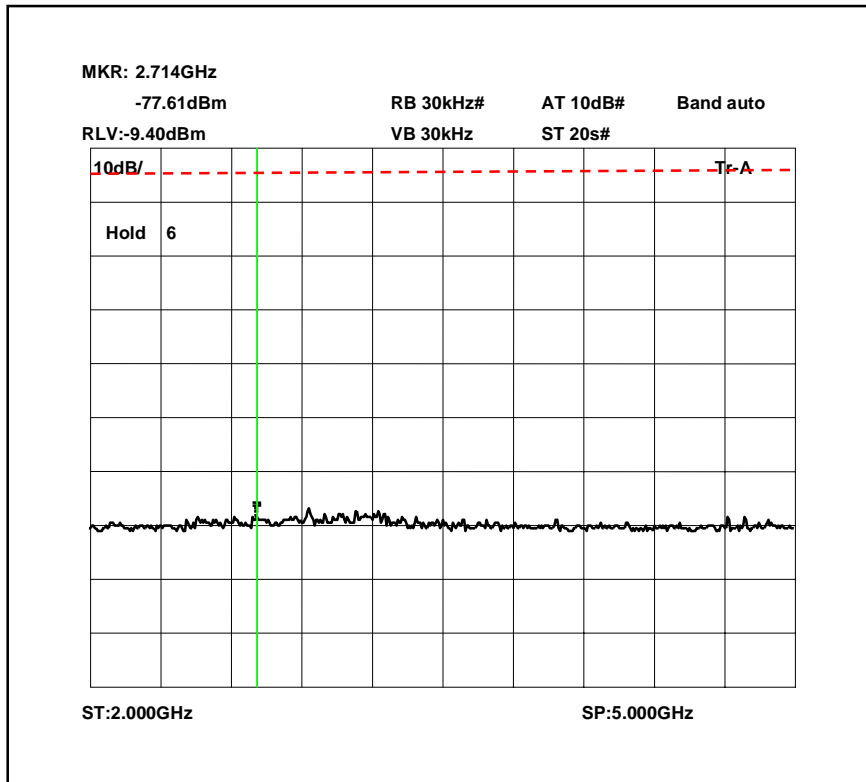



Conducted emissions 482.2375 MHz 0 – 2 GHz

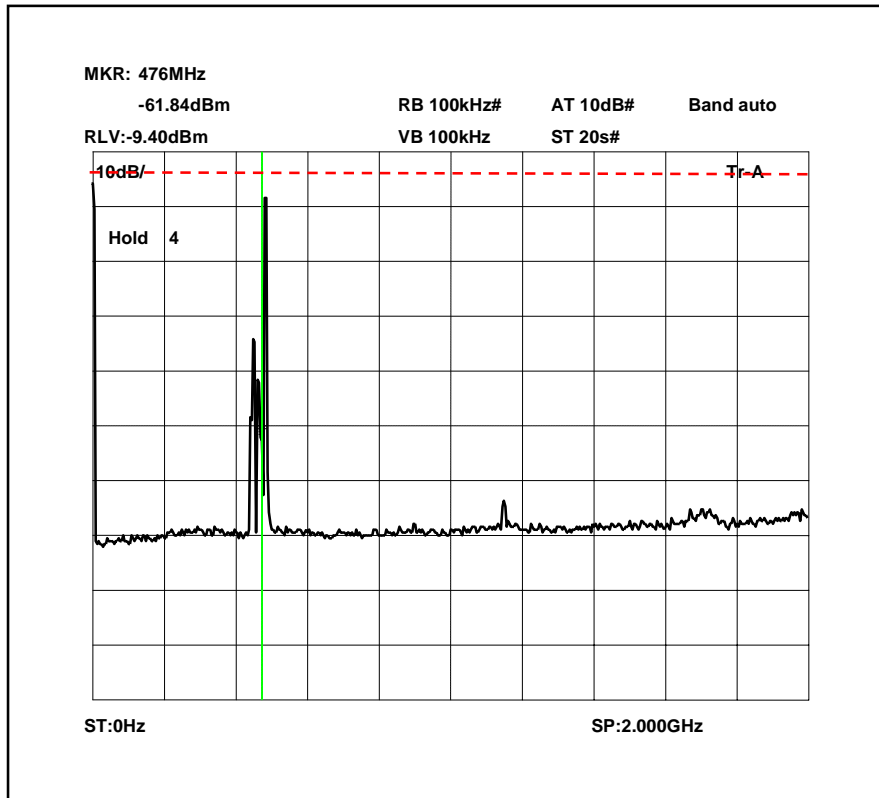

Conducted emissions 482.2375 MHz 2 – 5 GHz

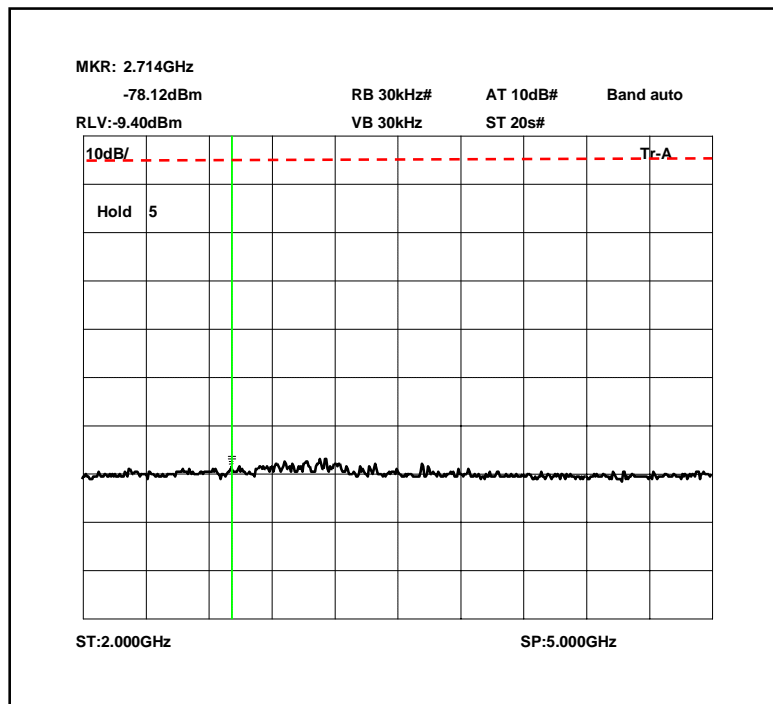

**TRANSMITTER TESTS**

**TRANSMITTER SPURIOUS EMISSIONS – RADIATED – Part 2.1053– DOWNLINK**

Ambient temperature = 26°C  
 Relative humidity = 34%  
 Conditions = OATS  
 Supply voltage = 110Vac  
 Supply Frequency = N/A

Test Signal = F3E

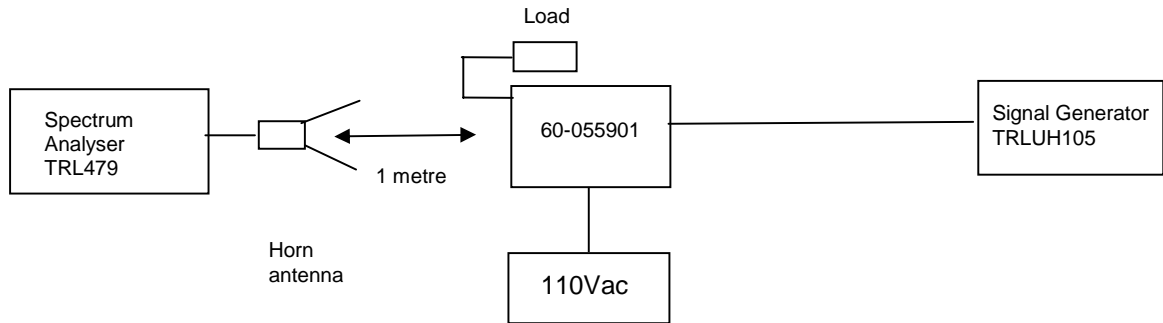

The test was set up as per the diagram. The level at the input was adjusted to compensate for the loss of the interconnecting cable. The unit was tested operating maximum power on three test frequencies with a 50 ohm load on the output. The unit was also tested with the signal generator replaced by another 50ohm load.

The Spurious limit was calculated as follows:

On any frequency removed from the assigned frequency by more that 250% of the authorised bandwidth

At least 43 + 10 log PdB

$$(10\log P_{\text{watts}}) - (43+10\log (P_{\text{watts}} * 1000)) = \text{LIMIT} = -13 \text{ dBm}$$

Test result

No significant emissions with 20dBm of limit.

The test equipment used for the Transmitter Spurious Emissions:

TYPE OF EQUIPMENT	MAKER/ SUPPLIER	MODEL No	SERIAL No	TRL No	ACTUAL EQUIPMENT USED
SPECTRUM ANALYSER	ANRITSU	MS2665C	MT26089	479	<b>X</b>
HORN	EMCO	3115	9010-3581	139	<b>X</b>
ATTENUATOR	BIRD	8304-300-N	N/A	220	<b>X</b>
ATTENUATOR	BIRD	8308-100	N/A	112	<b>X</b>
CABLE	ROSENBERGER	MICRO COAX	N/A	280	<b>X</b>
SIGNAL GENERATOR	MARCONI	2023	112224/040	UH105	<b>X</b>

Radiated emissions 470.2125 MHz 0 – 1 GHz

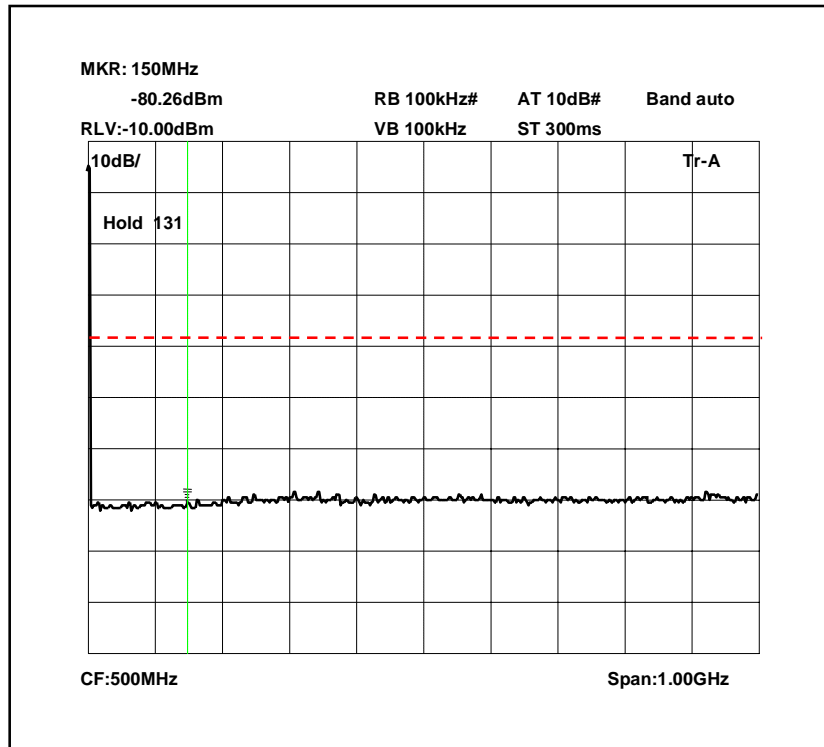

Radiated emissions 470.2125 MHz 1 – 2GHz

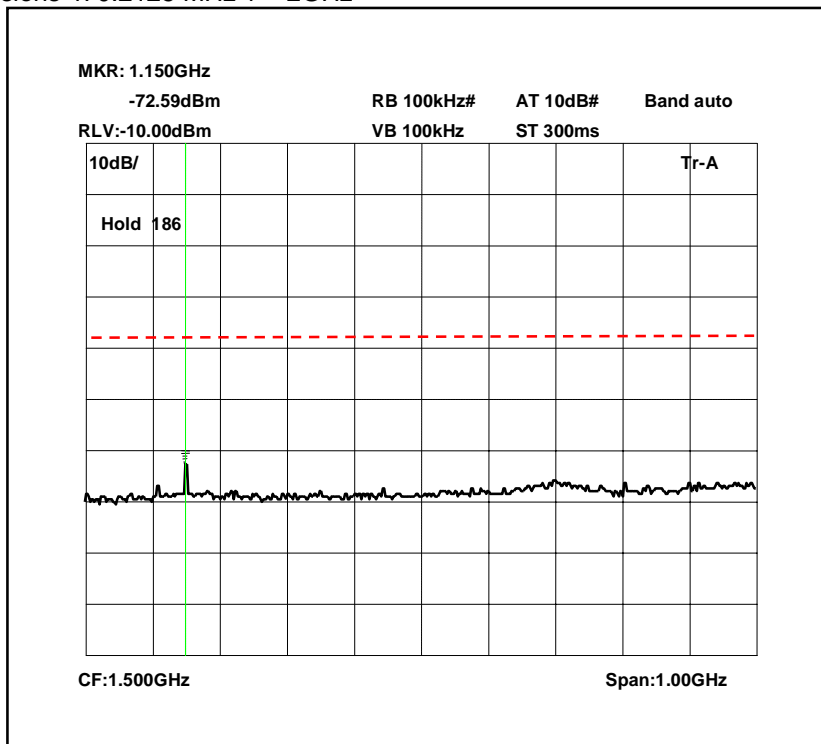

The above test results show that there were no emissions within 20dBs of the -13dBm limit.

Radiated emissions 470.2125 MHz 2-5GHz

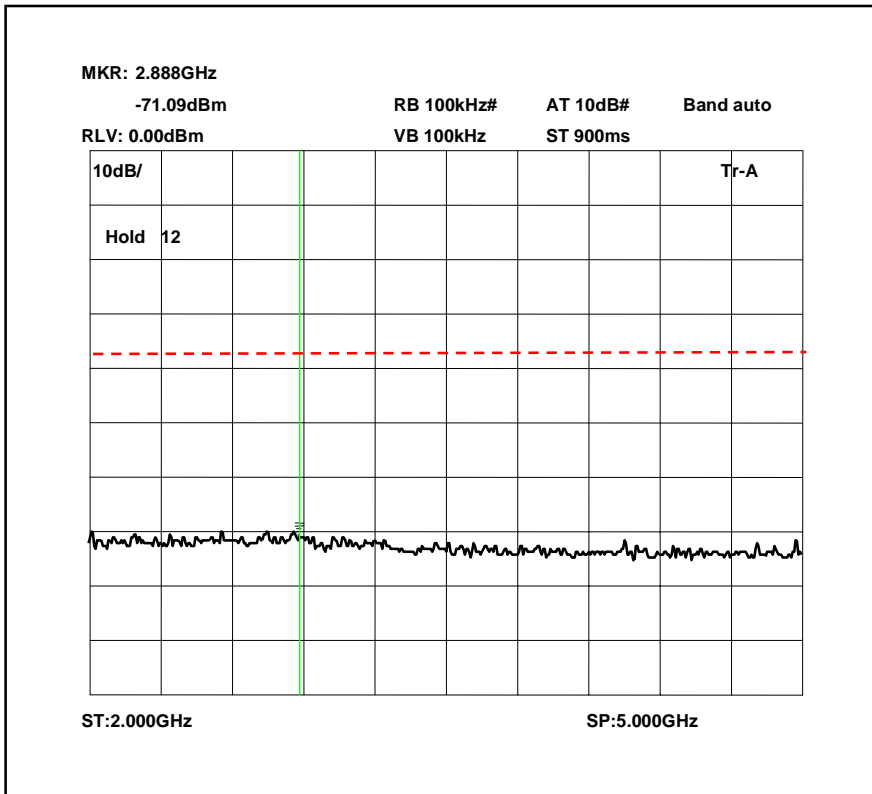

The above test results show that there were no emissions within 20dBs of the -13dBm limit.

Radiated emissions 470.2625 MHz 0 -1 GHz

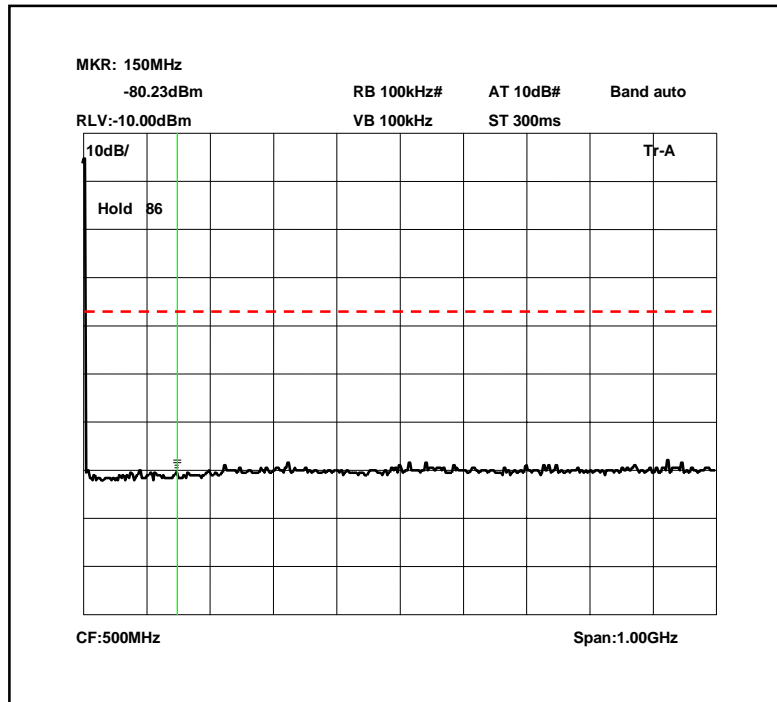

Radiated emissions 470.2625 MHz 1 – 2 GHz

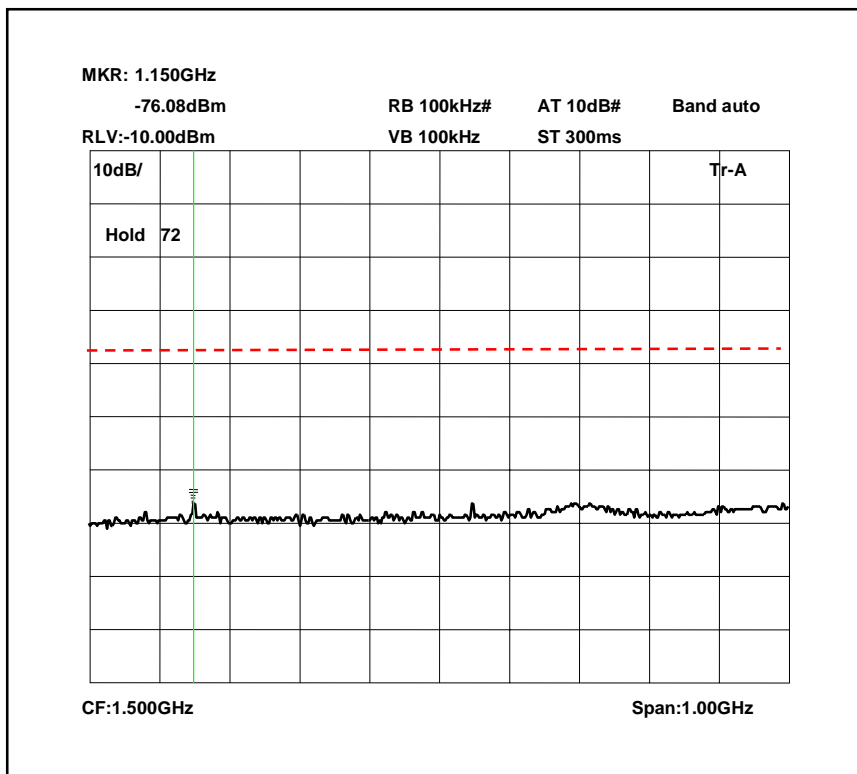

The above test results show that there were no emissions within 20dBs of the -13dBm limit.

Radiated emissions 470.2625 MHz 2-5GHz

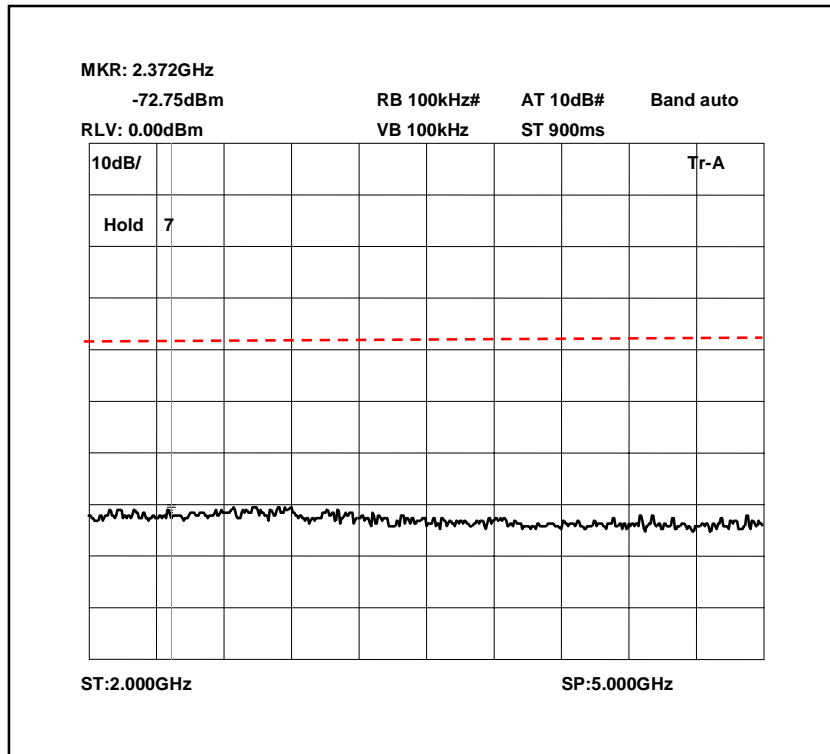

The above test results show that there were no emissions within 20dBs of the -13dBm limit.

Radiated emissions 482.2375 MHz 0 -1 GHz

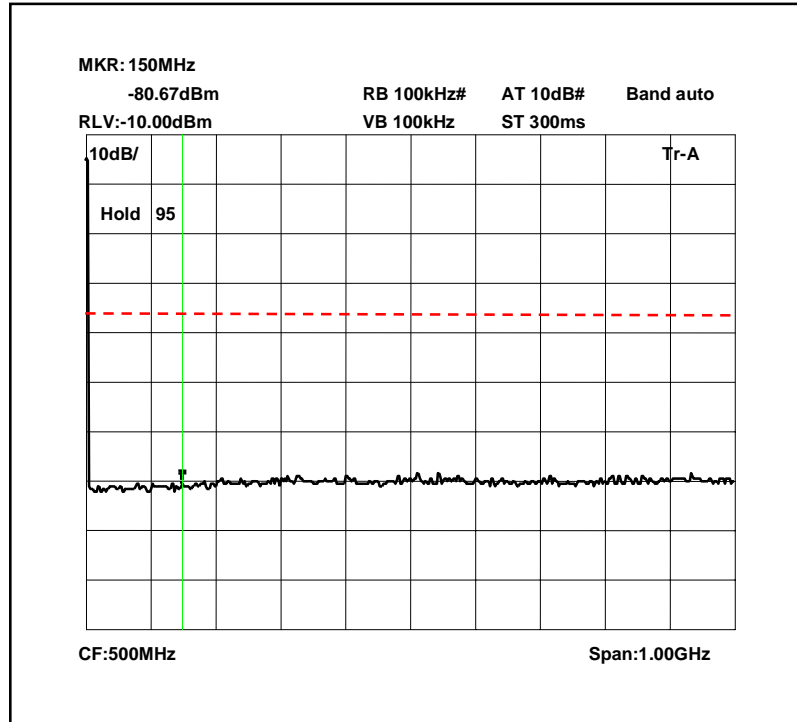

Radiated emissions 482.2375 MHz 1 – 2 GHz

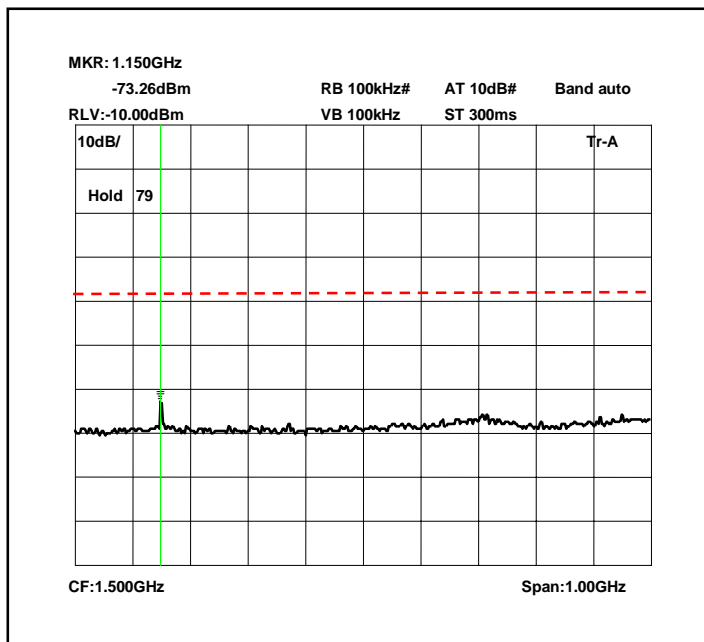

The above test results show that there were no emissions within 20dBs of the -13dBm limit.

Radiated emissions 482.2375 MHz 2-5GHz

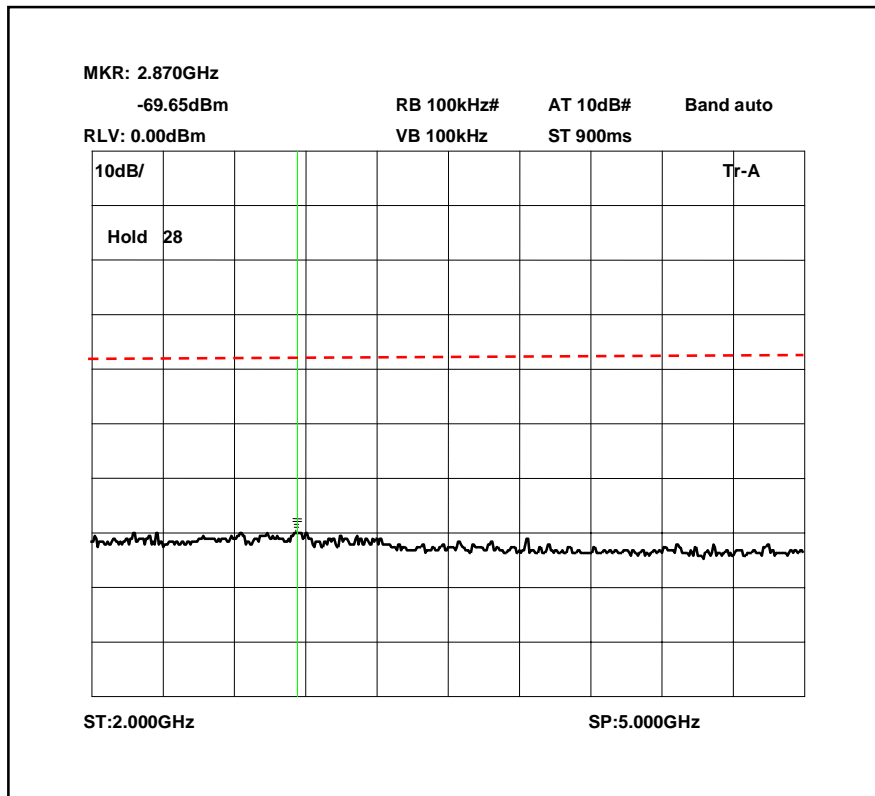

The above test results show that there were no emissions within 20dBs of the -13dBm limit.



Radiated emissions no input signal 0 – 1GHz

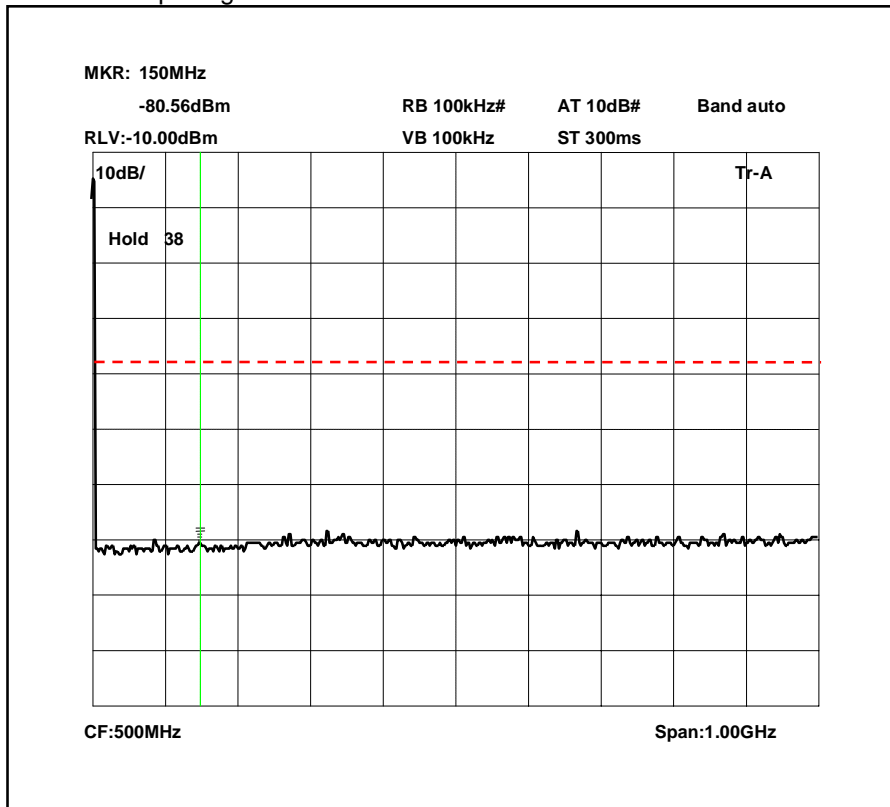

Radiated emissions no signal 1 – 2 GHz

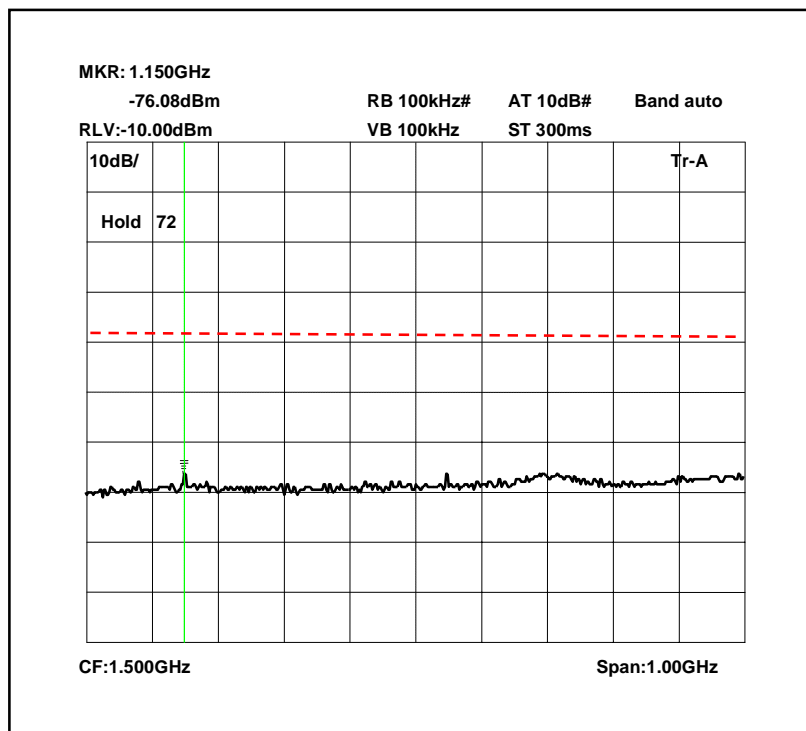

The above test results show that there were no emissions within 20dBs of the -13dBm limit.

Radiated emissions no signal 2-5GHz

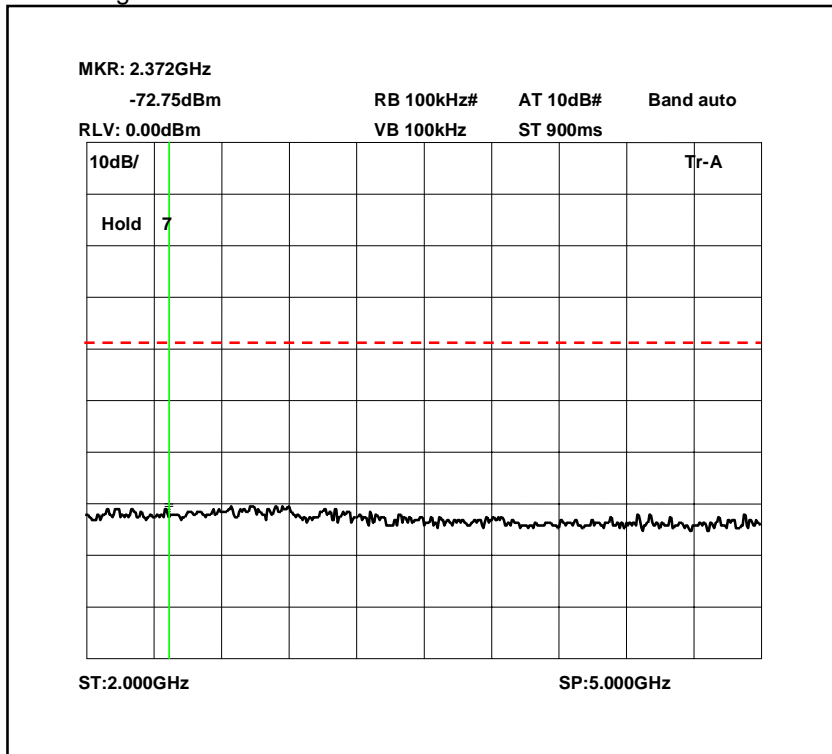

The above test results show that there were no emissions within 20dBs of the -13dBm limit.

**ANNEX A**  
**PHOTOGRAPHS**

PHOTOGRAPH No. 1

TEST SETUP



PHOTOGRAPH No. 2

TEST SETUP



**ANNEX B**  
**TEST EQUIPMENT CALIBRATION DETAILS**

### TEST EQUIPMENT CALIBRATION DETAILS

TRL Number	Equipment Type	Manufacturer	Last Cal Calibration	Calibration Period
	3m Range ERP			
UH006	CAL	TRL	01/03/05	12
UH028	Log Periodic Ant	Schwarbeck	28/04/05	24
UH029	Bicone Antenna	Schwarbeck	27/04/05	24
UH041	Multimeter	AVOmeter	14/12/04	12
UH120	Spectrum Analyser	Marconi	15/03/05	12
UH122	Oscilloscope	Tektronix	07/06/05	24
UH162	ERP Cable Cal	TRL	23/05/05	12
UH179	Power Sensor	Marconi	14/12/04	12
UH228	Power Sensor	Marconi	17/01/05	12
UH253	1m Cable N type	TRL	10/01/05	12
UH254	1m Cable N type	TRL	10/01/05	12
L005	CMTA	R&S	22/10/04	12
L007	Loop Antenna	R&S	29/03/05	24
L138	1-18GHz Horn	EMCO	15/04/05	24
L139	1-18GHz Horn	EMCO	03/05/05	24
L176	Signal Generator	Marconi	31/01/05	12
L193	Bicone Antenna	Chase	12/10/03	24
L203	Log Periodic Ant	Chase	21/10/03	24
L254	Signal Generator	Marconi	13/12/04	12
L280	18GHz Cable	Rosenberger	10/01/05	12
L343	CCIR Noise Filter	TRL	07/06/05	12
	Temperature			
L426	Indicator	Fluke	14/12/04	12
L478	Signal Generator	R&S	19/05/04	12
L479	Analyser	Anritsu	05/10/04	12
L552	Signal Generator	Agilent	25/04/05	12