

Pasedena Metro Radio System

Maintenance Handbook
For Canam Technology Inc.

AFL Works Order No.: Q107519

AFL product part No's.:

60-055900 **PBL Location One UHF1 & UHF2 (This document)**
60-056000 Tunnels 1 & 2
60-056100 PBL location TWO & 800MHz BDA

 Aerial Facilities Limited www.AerialFacilities.com Technical Literature	PBL UHF 1 & 2 Air Interface Maintenance Handbook		
	H/book Number:- 60-055900HBKM	Issue No:-1	Date:- 13/02/2003

Table of Contents

AMENDMENT LIST RECORD SHEET	5
INTRODUCTION.....	6
SCOPE	6
PURPOSE	6
GLOSSARY OF TERMS.....	7
AFL DRAWING SYMBOL KEYS.....	8
1. SAFETY CONSIDERATIONS.....	ERROR! BOOKMARK NOT DEFINED.
1.1 ELECTRIC SHOCK HAZARD.....	ERROR! BOOKMARK NOT DEFINED.
1.2 RF RADIATION HAZARD	ERROR! BOOKMARK NOT DEFINED.
1.3 CHEMICAL HAZARD.....	9
1.4 EMERGENCY CONTACT NUMBERS	10
2. OVERVIEW/SYSTEM DESCRIPTION.....	11
3. SPECIFICATIONS	12
3.1 PARTS LISTS.....	12
3.1.1 UHF1 & UHF2 Location ONE 60-055900 Parts List.....	12
3.1.1.1 F/O Air Interface 60-055901 Location ONE-UHF1 Parts List	12
3.1.1.2 F/O Air Interface 60-055902 Location ONE, UHF2 Parts List.....	14
3.2 TECHNICAL SPECIFICATIONS	16
3.2.1 UHF ONE to Tunnels 1 & 2 Technical Specification	16
3.2.2 UHF ONE to Location TWO Technical Specification	17
3.2.3 UHF TWO to Tunnels 1 & 2 Technical Specification	18
3.2.4 UHF TWO to Location TWO Technical Specification.....	19
3.2.5 800MHz Bi-directional Amplifier to Location TWO Technical Specification.....	20
3.3 MECHANICAL SPECIFICATION (UHF 1 & 2 WALL CASES).....	21
4. SYSTEM DRAWINGS.....	22
4.1 DRG. No. 60-055990, LOCATION ONE, UHF 1 CASE OUTLINE DRAWING.....	22
4.2 DRG. No. 60-055991, LOCATION ONE, UHF 2 CASE OUTLINE DRAWING.....	23
4.3 COMPLETE SYSTEM SKETCH	24
5. SUB-UNIT MODULES	25
5.1 UHF 1 AIR INTERFACE (60-055901)	25
5.1.1 Bandpass Duplexers (02-013401)	25
5.1.1.1 Description	25
5.1.1.2 Technical Specification.....	25
5.1.2 2 & 4 Way UHF Splitters (05-002603 & 05-003401)	26
5.1.2.1 Description	26
5.1.2.2 Technical Specification (05-002603).....	26
5.1.2.3 Technical Specification 05-003401	26
5.1.3 ¼Watt 0- -30dB Switched Attenuator (10-000701).....	27
5.1.3.1 General Application.....	27
5.1.3.2 Switched Attenuators	27
5.1.4 Low Noise Amplifiers (11-006102, 11-007302 & 11-007402).....	27
5.1.4.1 Description	27
5.1.4.2 Technical Specification (11-006102).....	27
5.1.4.3 Drg. No. 11-006102, Low Noise Amplifier General Assembly	28
5.1.4.4 Drg. No. 11-006170, LNA RF Circuit Diagram	29
5.1.4.5 Drg. No. 11-006171, LNA DC Wiring Diagram	30
5.1.4.6 Drg. No. 11-003971, LNA DC Schematic Diagram.....	31
5.1.4.7 Technical Specification (11-007302).....	32
5.1.4.8 Drg. No. 11-007302, LNA Assembly With Alarm Relay.....	33
5.1.4.9 Drg. No. 11-007370, LNA RF Circuit Diagram	34

5.1.4.10	Drg. No. 11-007371, LNA DC Wiring Diagram.....	35
5.1.4.11	Technical Specification (11-007402).....	36
5.1.4.12	Drg. No. 11-007402, LNA General Assembly	37
5.1.4.13	Drg. No. 11-007470, LNA RF Circuit Diagram.....	38
5.1.4.14	Drg. No. 11-007471 LNA DC Wiring Diagram.....	39
5.1.5	5Watt Power Amplifier (12-001801).....	40
5.1.5.1	Description	40
5.1.5.2	Technical Specification.....	40
5.1.5.3	Drg. No. 12-001801, 5Watt PA General Assembly Drawing	41
5.1.5.4	Drg. No. 12-001870, 5Watt PA Circuit Diagram.....	42
5.1.5.5	Drg. No. 12-001870C1, 5W PA Component List(1)	43
5.1.5.6	Drg. No. 12-001870C2, 5W PA Component List(2)	44
5.1.5.7	Drg. No. 80-008450, Power Amplifier/Alarm Board DC Wiring Details.....	45
5.1.6	3 Stage Amplifier Alarm Boards (12-002201).....	46
5.1.6.1	Description	46
5.1.6.2	Technical Specification.....	47
5.1.6.3	Drg. No. 12-002201, 3 Stage Alarm Board Assembly Drawing & Parts List.....	48
5.1.6.4	Drg. No. 12-002270, 3 Stage Alarm Board Circuit Diagram	49
5.1.6.5	Generic Wall Enclosure Alarm Wiring Sketch.....	50
5.1.7	DC/DC Converter, 24V in, 12V 8A out (13-003011).....	51
5.1.7.1	Description	51
5.1.7.2	Technical Specification.....	51
5.1.8	Channel Selective & Channel Control Modules (17-003012 & 17-002101).....	52
5.1.8.1	Channel Selective Module Description.....	52
5.1.8.2	Drg. No. 17-003080, Generic Channel Module Block Diagram.....	53
5.1.8.3	Channel Selectivity Control Module Description.....	54
5.1.8.4	Channel Controller DIP Switch Configuration Frequencies.....	54
5.1.8.5	UHF1 Downlink Channel Module Configuration Table.....	55
5.1.8.6	UHF1 Uplink Channel Module Configuration Table	55
5.1.8.7	UHF2 Downlink Channel Module Configuration Table.....	55
5.1.8.8	UHF2 Uplink Channel Module Configuration Table	55
5.1.9	Single & Dual 24Volt Relay Boards (20-001602 & 80-008902).....	56
5.1.9.1	24V Relay Boards (20-001602 & 80-008902) Description.....	56
5.1.9.2	Drg. No. 20-001602, Dual 24V Relay Board Assembly Drawing.....	57
5.1.9.3	Drg. No. 20-001671, Dual 24V Relay Board Circuit Diagram.....	58
5.1.9.4	Drg. No. 80-008970, Single Relay Board Circuit Diagram	59
5.1.10	SMA coaxial termination (93-930003).....	60
5.1.10.1	Description.....	60
5.1.11	24V 400W Flat-Pack Power Supply (96-300011).....	60
5.1.11.1	Description.....	60
5.1.11.2	Technical Specification	60
5.2	UHF 2 AIR INTERFACE (60-055902).....	61
5.2.1	Bandpass Filter (02-013401) See section 5.1.1.....	61
5.2.2	4 Port Tx Hybrid Combiner (05-003019)	61
5.2.2.1	Description	61
5.2.2.2	Technical Specification.....	61
5.2.3	Four Way Low Power Splitter (05-003401) See section 5.1.2.....	62
5.2.4	¼Watt 0- -30dB Switched Attenuator (10-000701) See section 5.1.3	62
5.2.5	Low Noise Amplifiers (11-007302 & 11-007402) See section 5.1.4	62
5.2.6	3 Stage Amplifier Alarm Boards (12-002201) See section 5.1.6.....	62
5.2.7	20Watt Power Amplifier (12-004201).....	62
5.2.7.1	Description	62
5.2.7.2	Technical Specification.....	62
5.2.7.3	Drg. No. 12-004201, PA General Assembly	63
5.2.7.4	Drg. No. 12-004270, PA Circuit Diagram.....	64
5.2.7.5	Drg. No. 12-004270C1, PA Parts List(1).....	65

5.2.7.6	Drg. No. 12-004270C2, PA Parts List(2).....	66
5.2.7.7	Drg. No. 12-003670, PA to Alarm Wiring Details.....	67
5.2.8	DC/DC Converter, 24V in, 12V 8A out (13-003011) See section 5.1.7	68
5.2.9	Chan. Selec. & Chan. Contr. Mdls (17-003012 & 17-002101) See section 5.1.8	68
5.2.10	21MHz IF Filter Board (17-002502)	68
5.2.10.1	Description.....	68
5.2.11	Single & Dual 24Volt Relay Boards (20-001602 & 80-008902) See section 5.1.9	68
5.2.12	SMA Coaxial Termination (93-930003) See section 5.1.10.....	68
5.2.13	24V 400W Flat-Pack Power Supply (96-300011) See section 5.1.11	68
5.2.14	JWS75-15/A PSU (96-300045)	68
5.2.14.1	Description.....	68
5.2.14.2	Technical Specification	68
5.2.15	Single Mode Optical Coupler (98-100001).....	69
5.2.15.1	Description.....	69
5.2.16.	Fibre Optic Receiver & Transmitter (98-200003 & 98-300003).....	69
5.2.16.1	Description.....	69
5.2.16.2	Technical Specification	70
6.	INSTALLATION	74
6.1	INITIAL INSTALLATION RECORD	74
6.2	GENERAL	74
6.3	ELECTRICAL CONNECTIONS	74
6.4	OPTICAL CONNECTIONS	74
6.5	RF CONNECTIONS	75
6.6	COMMISSIONING.....	75
7.	MAINTENANCE.....	76
7.1	GENERAL PROCEDURES	76
7.1.1	Fault Finding.....	76
7.1.2	Downlink	77
7.1.3	Uplink	77
7.1.4	Fault repair.....	77
7.1.5	Checking service	78
7.1.6	Service Support	78
7.2	TOOLS & TEST EQUIPMENT.....	78
7.3	CARE OF MODULES.....	79
7.3.1	General Comments	79
7.3.2	Module Removal (LNA's, general procedure):.....	79
7.3.3	Module Replacement (general):	79
7.3.4	Power Amplifiers.....	79
7.3.5	Low Power Amplifier Replacement.....	80
7.3.6	Module Transportation:	80
APPENDIX A INITIAL EQUIPMENT SET-UP CALCULATIONS		81

INTRODUCTION

Scope

This handbook is for use solely with the equipment identified by the AFL Part Number shown on the front cover. It is not to be used with any other equipment unless specifically authorised by Aerial Facilities Limited. This is a controlled release document and, as such, becomes a part of Aerial Facilities' Total Quality Management System. Alterations and modification may therefore only be performed by Aerial Facilities Ltd.

Purpose

The purpose of this handbook is to provide the user/maintainer with sufficient information to service and repair the equipment to the level agreed. Maintenance and adjustments to any deeper level must be performed by AFL, normally at the company's repair facility in Chesham, England.

This handbook has been prepared in accordance with BS 4884, and AFL's Quality procedures, which maintain the company's registration to ISO 9001: 1994 and to the R&TTE Directive of the European Parliament. Copies of the relevant certificates and the company Quality Manual can be supplied on application to the Quality Manager. This document fulfils the relevant requirements of Article 6 of the R&TTE Directive.

Limitation of Information Notice

This manual is written for the use of technically competent operators/service persons. No liability is accepted by AFL for use or misuse of this manual, the information contained therein, or the consequences of any actions resulting from the use of the said information, including, but not limited to, descriptive, procedural, typographical, arithmetical, or listing errors.

Furthermore, AFL does not warrant the absolute accuracy of the information contained within this manual, or it's completeness, fitness for purpose, or scope.

AFL has a policy of continuous product development and enhancement, and as such, reserves the right to amend, alter, update and generally change the contents, appearance and pertinence of this document without notice.

All AFL products carry a twelve month warranty from date of shipment. The warranty is expressly on a return to base repair or exchange basis and the warranty cover does not extend to on-site repair or complete unit exchange.

 Aerial Facilities Limited www.AerialFacilities.com Technical Literature	PBL UHF 1 & 2 Air Interface Maintenance Handbook		
	H/book Number:- 60-055900HBKM	Issue No:-1	Date:- 13/02/2003

Glossary of Terms

Repeater or Cell Enhancer	A Radio Frequency (RF) amplifier which can simultaneously amplify and re-broadcast Mobile Station (MS) and Base Transceiver Station (BTS) signals.
Band Selective Repeater	A Cell Enhancer designed for operation on a range of channels within a specified frequency band.
Channel Selective Repeater	A Cell Enhancer, designed for operation on specified channel(s) within a specified frequency band. Channel frequencies may be factory set or on-site programmable.
BTS	Base Transceiver Station
C/NR	Carrier-to-Noise Ratio
Downlink (D.L.)	RF signals transmitted from the BTS and to the MS
Uplink (U.L.)	RF signals transmitted from the MS to the BTS
EMC	Electromagnetic Compatibility
GND	Ground
DC	Direct Current
AC	Alternating Current
ID	Identification Number
OIP3	Output Third Order Intercept Point = $RF_{out} + (C/I)/2$
LED	Light Emitting Diode
M.S.	Mobile Station
N/A	Not Applicable
N/C	No Connection
NF	Noise Figure
RF	Radio Frequency
Rx	Receiver
Tx	Transmitter
S/N	Serial Number

AFL Drawing Symbol Keys

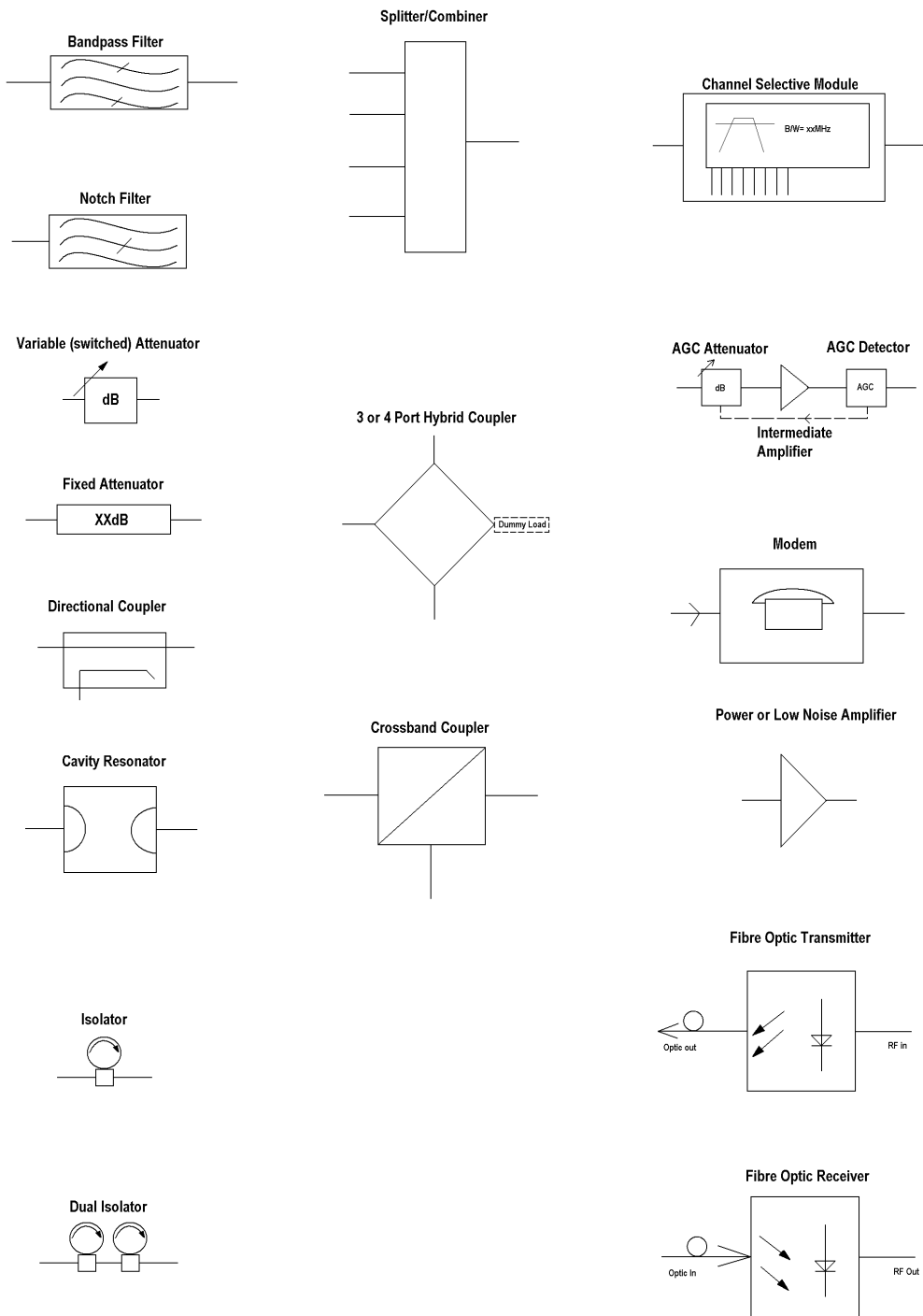

Key to AFL RF Modules

 <p>Aerial Facilities Limited www.AerialFacilities.com Technical Literature</p>	<p>PBL UHF 1 & 2 Air Interface Maintenance Handbook</p>		
	H/book Number:- 60-055900HBKM	Issue No:-1	Date:- 13/02/2003

1. SAFETY CONSIDERATIONS

1.1 Electric Shock Hazard

Electrical shocks due to faulty mains driven power supplies.

Whilst ever potentially present in any electrical equipment, such a condition would be minimised by quality installation practice and thorough testing at:

- a) Original assembly.
- b) Commissioning.
- c) Regular intervals, thereafter.

All test equipment to be in good working order prior to its use. High current power supplies can be dangerous because of the possibility of substantial arcing. Always switch off during disconnection and reconnection.

1.2 RF Radiation Hazard

“CAUTION: This equipment is approved for antennas mounted on fixed outdoor permanent structures. A minimum separation distance of 2 metres must be maintained between the radiating elements and any nearby persons. A maximum antenna gain of 21 dBi may be used. Operating this equipment without regard to these restrictions will result in RF exposure levels above the limits allowed by FCC rules.”

This equipment complies with part 90 of the FCC rules. Any changes or modifications not expressly approved by the manufacturer could void the user’s authority to operate the equipment.

RF radiation, (especially at UHF frequencies) arising from transmitter outputs connected to AFL’s equipment, must be considered a safety hazard.

This condition might only occur in the event of cable disconnection, or because a ‘spare’ output has been left unterminated. Either of these conditions would impair the system’s efficiency. No investigation should be carried out until all RF power sources have been removed. This would always be a wise precaution, despite the severe mismatch between the impedance of an N type connector at 50 Ω , and that of free space at 377 Ω , which would severely mitigate against the efficient radiation of RF power. Radio frequency burns could also be a hazard, if any RF power carrying components were to be carelessly touched!

Antenna positions should be chosen to comply with requirements (both local & statutory) regarding exposure of personnel to RF radiation. When connected to an antenna, the unit is capable of producing RF field strengths, which may exceed guideline safe values especially if used with antennas having appreciable gain. In this regard the use of directional antennas with backscreens and a strict site rule that personnel must remain behind the screen while the RF power is on, is strongly recommended.

Where the equipment is used near power lines, or in association with temporary masts not having lightning protection, the use of a safety earth connected to the case-earthing bolt is strongly advised.

 Aerial Facilities Limited www.AerialFacilities.com Technical Literature	PBL UHF 1 & 2 Air Interface Maintenance Handbook		
	H/book Number:- 60-055900HBKM	Issue No:-1	Date:- 13/02/2003

1.3 Chemical Hazard



Beryllium Oxide, also known as Beryllium Monoxide, or Thermalox™, is sometimes used in devices within equipment produced by Aerial Facilities Ltd. Beryllium oxide dust can be toxic if inhaled, leading to chronic respiratory problems. It is harmless if ingested or by contact.

Products that contain beryllium are load terminations (dummy loads) and some power amplifiers. These products can be identified by a yellow and black “skull and crossbones” danger symbol (shown above). They are marked as hazardous in line with international regulations, but pose no threat under normal circumstances. Only if a component containing beryllium oxide has suffered catastrophic failure, or exploded, will there be any danger of the formation of dust. Any dust that has been created will be contained within the equipment module as long as the module remains sealed. For this reason, any module carrying the yellow and black danger sign should not be opened. If the equipment is suspected of failure, or is at the end of its life-cycle, it must be returned to Aerial Facilities Ltd for disposal.

To return such equipment, please contact the Quality Department, who will give you a Returned Materials Authorisation (RMA) number. Please quote this number on the packing documents, and on all correspondence relating to the shipment.

PolyTetraFluoroEthylene, (P.T.F.E.) and P.T.F.E. Composite Materials

Many modules/components in AFL equipment contain P.T.F.E. as part of the RF insulation barrier.

This material should never be heated to the point where smoke or fumes are evolved. Any person feeling drowsy after coming into contact with P.T.F.E. especially dust or fumes should seek medical attention.

1.4 Emergency Contact Numbers

The AFL Quality Department can be contacted on:

Telephone +44 (0)1494 777000
Fax +44 (0)1494 777002
e-mail qa@aerial.co.uk

 Aerial Facilities Limited www.AerialFacilities.com Technical Literature	PBL UHF 1 & 2 Air Interface Maintenance Handbook		
	H/book Number:- 60-055900HBKM	Issue No:-1	Date:- 13/02/2003

2. OVERVIEW/SYSTEM DESCRIPTION

The AFL Off air Amplifiers for the Pasadena Blue line project are 2 way on-band RF amplifiers. Their application is as an interface between the donor radio sites and the Fibre optic receivers and transmitters which will extend coverage to the locations via the fibre optic link. There are two units one designated for the 'UHF1' frequencies the other for the 'UHF2' frequencies.

Each unit is housed in an environmentally protected IP65 steel wall-mount case. Handles are provided for carrying the unit and the door is fitted with locks. The unit interfaces with 'N' type female connectors for RF connections and heavy duty connectors for routing of AC power supply input and alarm output wiring. Cable glands are provided for routing of the Fibre optic cable in to the unit.

To provide adequate selectivity in the Downlink and Uplink paths, combine design bandpass quadplexers and duplexers are used at the air interface ports. In addition each channel to be passed is selected by a 15kHz or 25KHz Channel module which provides a high level of rejection at adjacent channels. To provide the required gain to reach the required signal levels, low-noise amplifiers (LNA's) are used in each path, these being followed by power amplifier modules in the uplink to provide the required intermodulation performance. Gain adjustment is available locally using switched attenuators.

Note that "Downlink" refers to the RF path from the base station (donor site) to the FO transmitter and that "Uplink" refers to the RF path from the FO receiver to the remote base station.

 Aerial Facilities Limited www.AerialFacilities.com Technical Literature	PBL UHF 1 & 2 Air Interface Maintenance Handbook		
	H/book Number:- 60-055900HBKM	Issue No:-1	Date:- 13/02/2003

3. SPECIFICATIONS

3.1 Parts Lists

3.1.1 UHF1 & UHF2 Location ONE 60-055900 Parts List

60-055901	PBL F/O AIR INTERFACE LOC1 UHF1	1
60-055902	PBL F/O AIR INTERFACE LOC1 UHF2	1

3.1.1.1 F/O Air Interface 60-055901 Location ONE-UHF1 Parts List

02-013401	6P CL FILTER (0.5 min BW) LARGE SMA ASSY	4
05-002603	UHF 3dB SPLITTER SMA	2
05-003401	4 WAY SPLITTER LOW POWER	2
10-000701	1/4W0-30dB SWITCHED ATTENUATOR	6
11-006102	LNA 380-500MHz 1W WITH RELAY	1
11-007302	LNA. 380-500MHz 20dB (C/W RELAY) GA	5
11-007402	LNA. 380-500MHz 30dB (C/W RELAY) GA	2
12-001801	UHF PWR AMP.450MHz 5W SMA ALARMS	1
12-002201	3 STAGE AMPLIFIER ALARM BOARD	1
12-002220	3 STAGE ALARM PCB COVER	1
12-002826	ALARM BOARD ACRYLIC LENS	1
13-003011	DC-DC CONVTR 24-12V 8A PCB SUB-ASS	1
17-000126	CELL ENHANCER LABEL 6 DIGIT	1
17-001523	GREY C.E. HEATSINK BLANKING PLATE	1
17-002020	CASE 620x620x250 SCHROFF CUSTOM	1
17-002021	BASE PLATE 585x570mm FOR 17-002020	1
17-002101	CHANNEL CONTROL MODULE	2
17-002103	26WAY RIBBON CABLE LEAD	0
17-003012	CHAN MOD 450MHz, 15kHz B/W	6
17-003022	MODULE PATTERNED LEAVE	6
17-003023	SUBRACK SIDE PANEL	2
17-003024	SUBRACK REAR BRACKET	6
17-003025	BOTTOM MODULE GUIDE	6
17-003028	MODULE SQUARE LEAVE	6
17-003029	TOP MODULE GUIDE	6
17-009723	EQUIP. MTG PLATE No.4	8
17-009727	EQUIP. MTG PLATE No.8	1
20-001602	24V RELAY BOARD	1
80-008902	24V RELAY PCB ASSEMBLY	1
80-032320	POWER AMP HEATSINK 10W 900MHz	1
80-032322	POWER SUPPLY HEATSINK 10W	1
90-010021	RF CABLE SUPFLEX SMA R/A MALE 100mm	15

90-010022	RF CABLE SUPFLEX SMA R/A MALE 200mm	2
90-010026	RF CABLE HIFLEX SMA R/A MALE 150mm	6
90-010027	RF CABLE HIFLEX SMA R/A MALE 250mm	2
90-010028	RF CABLE HIFLEX SMA R/A MALE 350mm	1
90-010130	RF CABLE SMA R/A-N PANEL JACK 100mm	1
90-010131	RF CABLE SMA R/A-N PANEL JACK 200mm	3
90-010134	RF CABLE SMA R/A-N PANEL JACK 400mm	1
90-010135	RF CABLE SMA R/A-N PANEL JACK 500mm	2
91-030002	N ADAPTOR PANEL FEMALE:FEMALE	0
91-500011	PWR 3POLE PNL PLUG SEALED IP68	1
91-500015	PWR CON CAP SEALED with INT. THREAD	2
91-500016	PWR 6POLE PNL PLUG SEALED IP68	1
91-510010	PWR 3POLE FREE SOC.SEALED IP68	1
91-510013	PWR CON CAP SEALED with Ext. THREAD	2
91-510014	PWR 6POLE FREE SOC.SEALED IP68	1
91-600005	'D' 9 WAY SOCKET S/B TERM	0
91-600007	'D' 9 WAY BLACK SHELL	0
91-600014	'D' 9 WAY SOCKET S/B (NON FILTERED)	8
91-620002	'D' 25 WAY SOCKET/IDC TERMS	6
91-640003	MISC 26 WAY RIBBON CABLE SOCK.	6
91-700017	ICD 15 WAY 0.1' CONNECTOR	2
92-280033	Captive Screw	12
92-400017	GASKET FOR N TYPE CONNECTOR	3
93-540035	1K3 0.25W 1% RES MRS25 M:F	2
93-930003	SMA COAX TERMINATION [RADIAL]	2
96-300011	24 V 400 W FLATPACK PWR SUPPLY	1
96-500003	AC FILTER 110V 5A	1
96-500005	DC INPUT FILTERS	1
96-700002	LED.GREEN 5mm SEALED IP66	1
96-700005	LED.RED 5mm SEALED IP66	1
96-900018	AC TRIP SWITCH (5 AMP M.C.B.)	1
96-920011	PROXIMITY SWITCH	1
96-920012	PROXIMITY SWITCH MAGNET	1
97-000002	BLACK MODULE CAGE RUNNER	12
97-300010	SUPPLY I/P COVERS	1
97-400010	BLACK PLASTIC HANDLE 37311	2
97-600001	SUBRACK FRONT HORIZ	2
97-600002	SUBRACK M2.5 STD TAP	8
97-900004	RUBBER FOOT FOR CELL ENHANCERS	4

3.1.1.2 F/O Air Interface 60-055902 Location ONE, UHF2 Parts List

02-013401	6P CL FLTR(0.5 min BW) LARGE SMA ASSY	2
05-002603	UHF 3dB SPLITTER SMA	1
05-003019	4 PORT THC 3dB 450MHz SMA TYPE	1
05-003401	4 WAY SPLITTER LOW POWER	4
10-000701	1/4W0-30dB SWITCHED ATTENUATOR	2
11-007302	LNA. 380-500MHz 20dB (C/W RELAY) GA	1
11-007402	LNA. 380-500MHz 30dB (C/W RELAY) GA	5
12-002201	3 STAGE AMPLIFIER ALARM BOARD	1
12-002220	3 STAGE ALARM PCB COVER	1
12-002826	ALARM BOARD ACRYLIC LENS	1
12-004201	PWR AMP.450MHz 20W version CLASS A	1
13-003011	DC/DC CONVERTER 24-12V 8A PCB SUB-ASS	1
17-000126	CELL ENHANCER LABEL 6 DIGIT	1
17-002020	CASE 620x620x250 SCHROFF CUSTOM	1
17-002021	BASE PLATE 585x570mm FOR 17-002020	1
17-002101	CHANNEL CONTROL MODULE	1
17-002103	26WAY RIBBON CABLE LEAD	0
17-002502	IF FILTER BOARD 21.4MHz 30kHz	1
17-003012	CHAN MOD 450MHz, 15kHz B/W	8
17-003022	MODULE PATTERNED LEAVE	7
17-003023	SUBRACK SIDE PANEL	2
17-003024	SUBRACK REAR BRACKET	8
17-003025	BOTTOM MODULE GUIDE	8
17-003028	MODULE SQUARE LEAVE	8
17-003029	TOP MODULE GUIDE	8
17-009723	EQUIP. MTG PLATE No.4	6
17-009726	EQUIP. MTG PLATE No.7	1
20-001602	24V RELAY BOARD	0
80-008902	24V RELAY PCB ASSEMBLY	1
80-031820	POWER AMP HEATSINK 20W 900MHz	1
80-032320	POWER AMP HEATSINK 10W 900MHz	0
80-032322	POWER SUPPLY HEATSINK 10W	2
90-010021	RF CABLE SUPFLEX SMA R/A MALE 100mm	20
90-010022	RF CABLE SUPFLEX SMA R/A MALE 200mm	3
90-010024	RF CABLE SUPFLEX SMA R/A MALE 400mm	1
90-010025	RF CABLE SUPFLEX SMA R/A MALE 500mm	3
90-010026	RF CABLE HIFLEX SMA R/A MALE 150mm	8
90-010027	RF CABLE HIFLEX SMA R/A MALE 250mm	2
90-010028	RF CABLE HIFLEX SMA R/A MALE 350mm	2
90-010030	RF CABLE HIFLEX SMA R/A MALE 600mm	3
90-010131	RF CABLE SMA R/A-N PANEL JACK 200mm	1
90-010135	RF CABLE SMA R/A-N PANEL JACK 500mm	2

91-030002	N ADAPTOR PANEL FEMALE:FEMALE	0
91-500011	PWR 3POLE PNL PLUG SEALED IP68	1
91-500015	PWR CON CAP SEALED with INT. THREAD	2
91-500016	PWR 6POLE PNL PLUG SEALED IP68	1
91-510010	PWR 3POLE FREE SOC.SEALED IP68	1
91-510013	PWR CON CAP SEALED with Ext. THREAD	2
91-510014	PWR 6POLE FREE SOC.SEALED IP68	1
91-600005	'D' 9 WAY SOCKET S/B TERM	0
91-600007	'D' 9 WAY BLACK SHELL	0
91-600014	'D' 9 WAY SOCKET S/B (NON FILTERED)	6
91-620002	'D' 25 WAY SOCKET/IDC TERMS	8
91-640003	MISC 26 WAY RIBBON CABLE SOCK.	8
91-700017	ICD 15 WAY 0.1' CONNECTOR	2
91-800014	3 WAY TERMINAL BLOCK	1
91-800019	OPTICAL BARREL ADAPT	4
92-120009	M20 IP68 CABLE GLAND	2
92-280033	Captive Screw	16
92-400017	GASKET FOR N TYPE CONNECTOR	3
93-540035	1K3 0.25W 1% RES MRS25 M:F	2
93-930003	SMA COAX TERMINATION [RADIAL]	0
96-300011	24 V 400 W FLATPACK PWR SUPPLY	1
96-300045	JWS75-15/A PSU (COUTANT LAMBDA)	1
96-500003	AC FILTER 110V 5A	1
96-500005	DC INPUT FILTERS	1
96-700002	LED.GREEN 5mm SEALED IP66	1
96-700005	LED.RED 5mm SEALED IP66	1
96-900018	AC TRIP SWITCH (5 AMP M.C.B.)	1
96-920011	PROXIMITY SWITCH	1
96-920012	PROXIMITY SWITCH MAGNET	1
97-000002	BLACK MODULE CAGE RUNNER	16
97-300010	SUPPLY I/P COVERS	1
97-400010	BLACK PLASTIC HANDLE 37311	2
97-600001	SUBRACK FRONT HORIZ	2
97-600002	SUBRACK M2.5 STD TAP	8
97-900004	RUBBER FOOT FOR CELL ENHANCERS	4
98-100001	1x2 SINGLE MODE OPTICAL COUPLR 1310	1
98-200003	FIBRE OPTIC RX 6325 1310nm <2.2GHz	2
98-300003	FIBRE OPTIC TX 6325 1310nm <2.2GHz	1
98-500004	FC/APC-FC/APC FIBREOPTIC CABLE 0.5M	2

3.2 Technical Specifications

3.2.1 UHF ONE to Tunnels 1 & 2 Technical Specification

Frequency Range:	Downlink Channels: 470.2125MHz 470.2625MHz 482.2375MHz	Uplink Channels: 473.2125MHz 473.2625MHz 485.2375MHz
Band Width	Downlink :15kHz Uplink : 25kHz	
No. of Paths	2	
Downlink Gain	82 dB min	
Uplink Gain	70 dB min	
RF Connector	N type female	
RF Impedance	50Ω	
VSWR	Better than 1.5:1	
Gain Adjustment	0 to 30 in 2dB steps	
Downlink PA	470.2125MHz, 470.2125MHz: 5W Class A Linear PA 482.2375MHz :20W Class A Linear PA	
Uplink PA	485.2375MHz : 1W Class A Linear 473.2625MHz, 473.2125MHz : 5W Class A Linear	
Duplexer UP/DN Isolation	>80 dB	
Passband Ripple	<±1.5 dB	
Noise Figure	Downlink <7 dB at maximum gain	
Noise Figure	Uplink <18 dB at maximum gain	
In-Band Spurious	Better than -13dBm downlink Better than -13dBm uplink (measure with 30KHz BW & max gain setting)	
Out-band Spurious up to 3GHz:	Better than -90dBc	

3.2.2 UHF ONE to Location TWO Technical Specification

Frequency Range:	Downlink Channels: 470.2125MHz 470.2625MHz 482.2375MHz	Uplink Channels: 473.2125MHz 473.2625MHz 485.2375MHz
Band Width:	Downlink :15kHz Uplink : 25kHz	
No. of Paths	2	
Downlink Gain	82 dB min	
Uplink Gain	80 dB min	
RF Connector	N type female	
RF Impedance	50Ω	
VSWR	Better than 1.5:1	
Gain Adjustment	0 to 30dB in 2dB steps	
Downlink PA	470.2125MHz, 470.2125MHz: 5W Class A Linear PA 482.2375MHz :20W Class A Linear PA	
Uplink PA	485.2375MHz : 1W Class A Linear 473.2625MHz, 473.2125MHz : 5W Class A Linear	
Duplexer UP/DN Isolation	>80 dB	
Passband Ripple	<±1.5 dB	
Noise Figure	Downlink <7dB at maximum gain	
Noise Figure	Uplink <12dB	
In-Band Spurious	Better than -13dBm downlink Better than -13dBm uplink (measure with 30KHz BW with max gain setting)	
Out-band Spurious up to 3GHz	Better than -90dBc	

3.2.3 UHF TWO to Tunnels 1 & 2 Technical Specification

Frequency Range:	Downlink Channels: 483.0625MHz 483.2875MHz 483.3125MHz 483.5625MHz	Uplink Channels: 486.0625MHz 486.2875MHz 486.3125MHz 486.5625MHz
Band Width:	Downlink :15kHz Uplink : 25kHz ,486.0625MHz, 486.5625MHz 15kHz ,486.2875MHz, 486.3125MHz	
No. of Paths:	2	
RF Connector:	N type female	
RF Impedance:	50Ω	
VSWR:	Better than 1.5:1	
Downlink Gain:	90 dB min	
Uplink Gain:	68 dB min	
Gain Adjustment:	0 to 30 in 2dB steps	
Downlink PA:	20W Class A Linear	
Uplink PA:	20W Class A Linear	
Duplexer UP/DN Isolation:	>80 dB	
Passband Ripple:	<±1.5 dB	
Noise Figure:	Downlink <5 dB at maximum gain	
Noise Figure:	Uplink <12dB at maximum gain	
In-Band Spurious:	Better than -13dBm downlink Better than -13dBm uplink (measure with 30KHz BW with max gain setting)	
Out-band Spurious up to 3GHz:	Better than -90dBc	

3.2.4 UHF TWO to Location TWO Technical Specification

Frequency Range:	Downlink Channels: 483.0625MHz 483.2875MHz 483.3125MHz 483.5625MHz	Uplink Channels: 486.0625MHz 486.2875MHz 486.3125MHz 486.5625MHz
Band Width:	Downlink :15kHz Uplink : 25kHz ,486.0625MHz, 486.5625MHz 15kHz ,486.2875MHz, 486.3125MHz	
No. of Paths:	2	
RF Connector:	N type female	
RF Impedance:	50Ω	
VSWR:	Better than 1.5:1	
Downlink Gain:	90 dB min	
Uplink Gain:	78 dB min	
Gain Adjustment:	0 to 30 in 2dB steps	
Downlink PA:	20W Class A Linear	
Uplink PA:	20W Class A Linear	
Duplexer UP/DN Isolation:	>80 dB	
Passband Ripple:	<±1.5 dB	
Noise Figure:	Downlink <5 dB at maximum gain	
Noise Figure:	Uplink <12 dB at maximum gain	
In-Band Spurious:	Better than -13dBm downlink Better than -13dBm uplink (measure with 30KHz BW & max gain setting)	
Out-band Spurious up to 3GHz:	Better than -90dBc	

3.2.5 800MHz Bi-directional Amplifier to Location TWO Technical Specification

Frequency Range:	Downlink Channels: 857.9375MHz 859.7625MHz	Uplink Channels: 812.9375MHz 814.7625MHz
Band Width:	Downlink :15kHz Uplink : 25kHz	
No. of Paths:	2	
No. of RF Ports:	2	
No. of Fibre Connections:	N/A	
RF Connector:	N type female	
RF Impedance:	50Ω	
VSWR:	Better than 1.5:1	
Downlink Gain:	78 dB min	
Uplink Gain:	80 dB min	
Gain Adjustment:	0 to 30 in 2dB steps	
Downlink PA:	5W Class A Linear	
Downlink Power:	2 Carriers at +18dBm	
Uplink PA:	5W Class A Linear	
Uplink Power:	2 Carriers at +18dBm	
Duplexer UP/DN Isolation:	>80 dB	
Passband Ripple:	<±1.5 dB	
Noise Figure:	Uplink <6 dB at maximum gain Downlink <5 dB at maximum gain	
In-Band Spurious:	Better than -13dBm downlink Better than -13dBm uplink (measure with 30KHz BW with max gain setting)	
MTBF:	>50,000 hours	
Supply Input Voltage:	110V AC	
Alarms Fitted:	Alarm:- Volts free contacts Alarm indicator:- Red LED Power Indicator:-Green LED Door Intrusion:- Magnetic proximity switch	

3.3 Mechanical Specification (UHF 1 & 2 Wall Cases)

Case size	Height:	620mm
	Width:	620mm
	Depth:	250mm
(excluding heatsinks, connectors, handles and feet)		
	Fixings:	4 holes on 670(w) x 557(h) mm
Temperature Range	operational:	-10°C to +55°C
	storage:	-40°C to +70°C
	Weight:	70kg (approximately)
	RF Connectors:	N type female
	Environmental Protection:	IP65 (with door closed and all ports terminated)
Finish:	Case:	To RAL 7032
	Heatsinks:	Matt black (where fitted)
	Handles:	Black plastic
Supply Cable:	Unit supplied with suitable supply input leads with connector and appropriate length of cable	

4. SYSTEM DRAWINGS

4.1 Drg. No. 60-055990, Location ONE, UHF 1 Case Outline Drawing

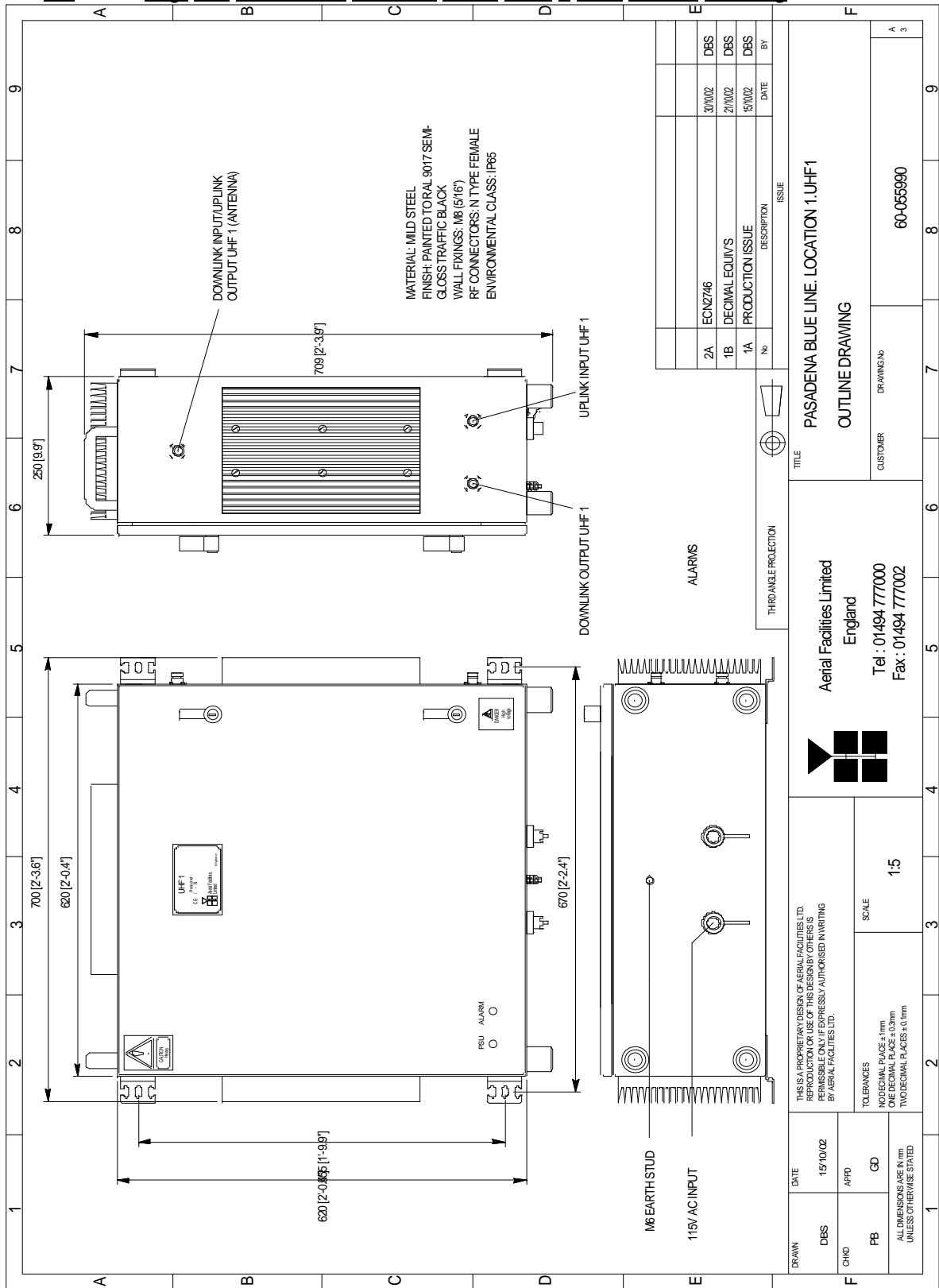

4.2 Drg. No. 60-055991, Location One, UHF 2 Case Outline Drawing

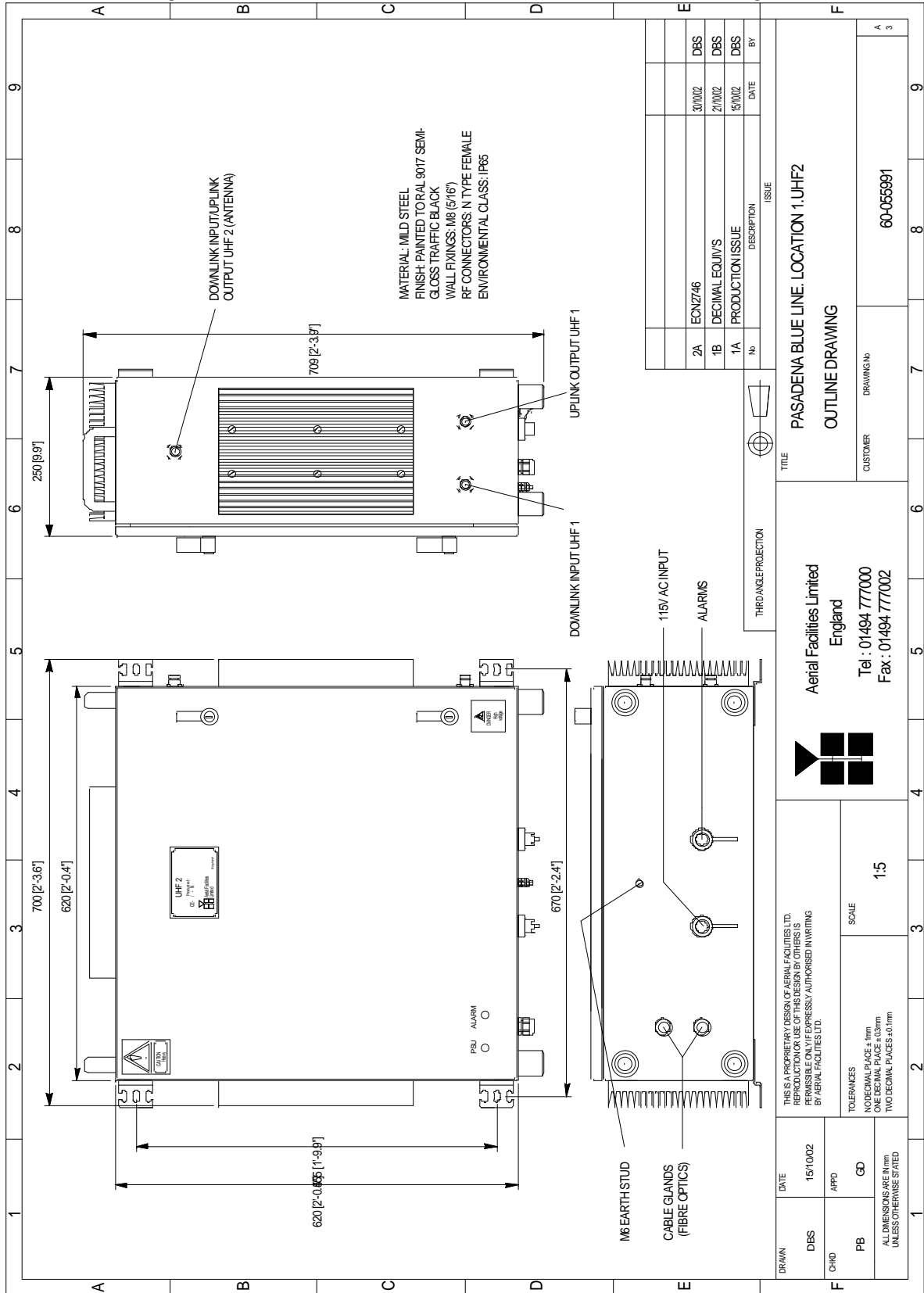

4.3 Complete System Sketch

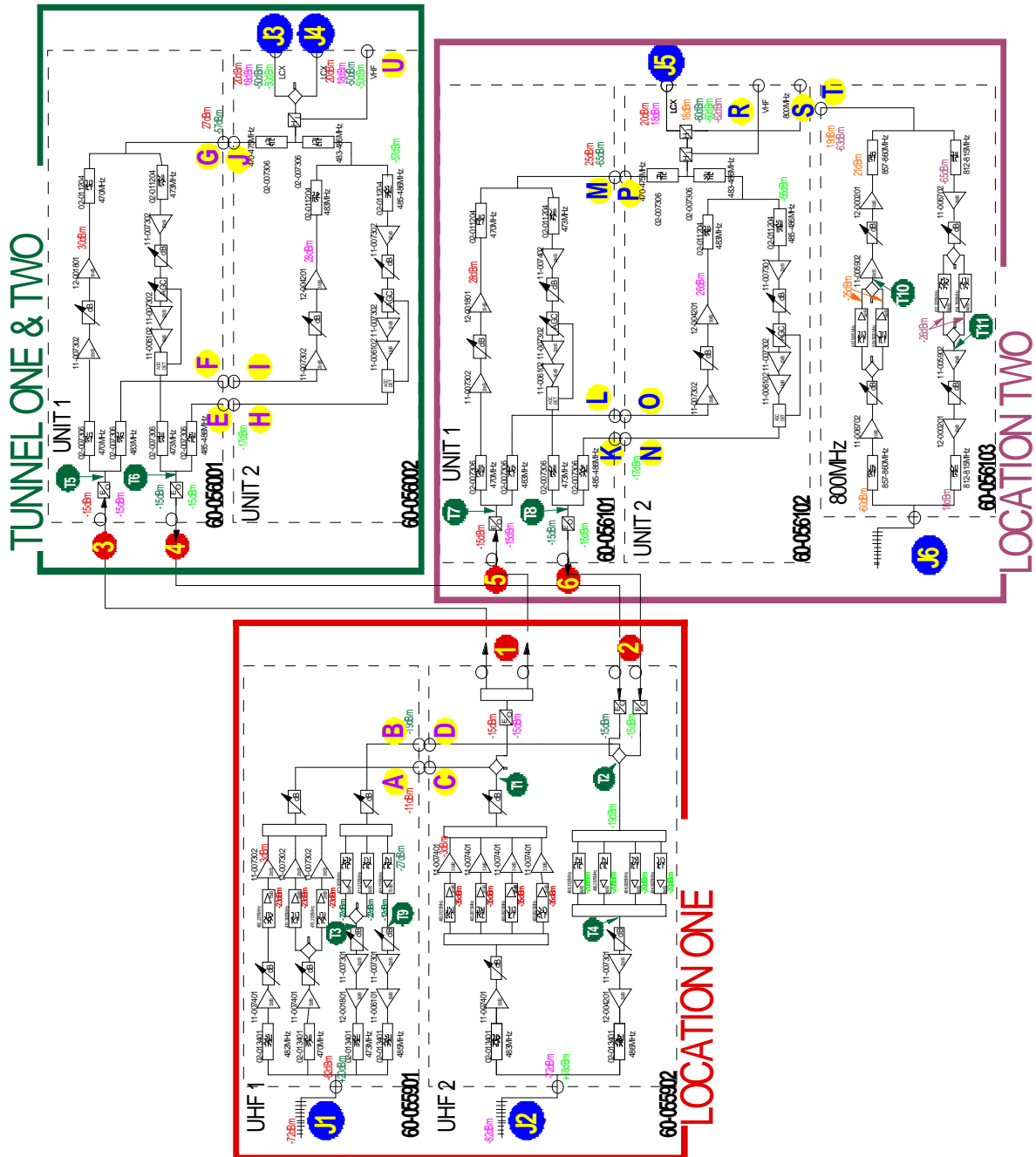

5. SUB-UNIT MODULES

5.1 UHF 1 Air Interface (60-055901)

5.1.1 Bandpass Duplexers (02-013401)

5.1.1.1 Description

The bandpass filters are multi-section designs with a bandwidth dependent upon the passband frequencies, (both tuned to customer requirements). The response shape is basically Chebyshev with a passband design ripple of 0.1dB. The filters are of combline design, and are carefully aligned during manufacture in order to optimise the insertion loss, VSWR and intermodulation characteristics of the unit. The tuned elements are silver-plated to reduce surface ohmic losses and maintain a good VSWR figure and 50 Ω load at the input and output ports. Note that the same filter is used for both UHF 1 & 2, but tuned differently depending on the required frequencies and bandwidth for each air interface.

Being passive devices, the bandpass filters should have an extremely long operational life and require no maintenance. Should a filter be suspect, it is usually most time efficient to replace the module rather than attempt repair or re-tuning.

No adjustments should be attempted without full network sweep analysis facilities to monitor both insertion loss and VSWR simultaneously.

5.1.1.2 Technical Specification

Passband	FILTER 1	483.2-483.6 MHz
	FILTER 2	486.2-486.6 MHz
Insertion Loss	FILTER 1	2.7 dB typical
	FILTER 2	2.7 dB typical
Rejection	FILTER 1	483.2-483.6 MHz > 80 dB
	FILTER 2	486.2-486.6 MHz > 80 dB
Power Rating		250 Watt
Impedance		50 ohm
VSWR		Better than 1.2:1
Connectors		SMA female

5.1.2 2 & 4 Way UHF Splitters (05-002603 & 05-003401)

5.1.2.1 Description

The Splitter/Combiners used are UHF (300-500MHz) devices for accurately matching two or more RF signals to single or multiple ports, whilst maintaining an accurate 50Ω load to all inputs/outputs and ensuring that the VSWR and insertion losses are kept to a minimum. Any unused ports will be terminated with an appropriate 50Ω load.

5.1.2.2 Technical Specification (05-002603)

Frequency Range:	380 - 520 MHz
Bandwidth:	140 MHz
Inputs:	1
Outputs:	2
Insertion Loss:	3.5 dB (typical)
Isolation:	>18 dB
Return Loss (VSWR) – Input:	Better than 1.3:1
Return Loss (VSWR) – Output:	Better than 1.3:1
Impedance:	50 Ω
Power Rating – Splitter:	20 Watts
Power Rating – Combiner:	0.5 Watt
Connectors:	SMA female
Size:	54 x 44 x 21 mm (including connectors)
Weight:	200 g

5.1.2.3 Technical Specification 05-003401

Frequency range:	70 – 250MHz	
Bandwidth:	180MHz	
Rejection:	>14dB	
Insertion loss:	(in band)	
Connectors:	SMA	
Weight:	<1.5Kgm	
Temperature range:	operational:	-10°C to +55°C
	storage	-40°C to +70°C

5.1.3 ¼Watt 0- -30dB Switched Attenuator (10-000701)

5.1.3.1 General Application

In many practical applications for Cell Enhancers etc., the gain in each path is found to be excessive. Therefore, provision is made within the unit for the setting of attenuation in each path, to reduce the gain.

5.1.3.2 Switched Attenuators

The AFL switched attenuators are available in two different types; 0 – 30dB in 2 dB steps (as in this case), or 0 – 15dB in 1 dB steps. The attenuation is simply set using the four miniature toggle switches on the top of each unit. Each switch is clearly marked with the attenuation it provides, and the total attenuation in line is the sum of the values switched in. They are designed to maintain an accurate 50 Ω impedance over their operating

5.1.4 Low Noise Amplifiers (11-006102, 11-007302 & 11-007402)

5.1.4.1 Description

The low noise amplifiers used are double or single stage solid-state low-noise amplifiers. Class A circuitry is used in the units to ensure excellent linearity over a very wide dynamic range. The active devices are very moderately rated to provide a long trouble-free working life. There are no adjustments on these amplifiers, and in the unlikely event of failure then the entire amplifier should be replaced. Note that all three amplifiers use similar DC power circuit boards.

5.1.4.2 Technical Specification (11-006102)

Frequency range:	70 – 500MHz	
Bandwidth:	<430MHz	
Gain:	15.5dB (typical)	
1dB Compression Point:	+31dBm (typical)	
3rd order intercept:	+46dBm (typical)	
Input return loss:	>20dB	
Output return loss:	>20dB	
VSWR:	Better than 1.5:1	
Noise figure:	<4.8dB	
Connectors:	SMA female	
Supply:	530mA @ 10 to 24V DC (typical)	
Temperature range:	operational:	-10°C to +60°C
	storage:	-40°C to +70°C
Weight:	260gms	

5.1.4.3 Drg. No. 11-006102, Low Noise Amplifier General Assembly

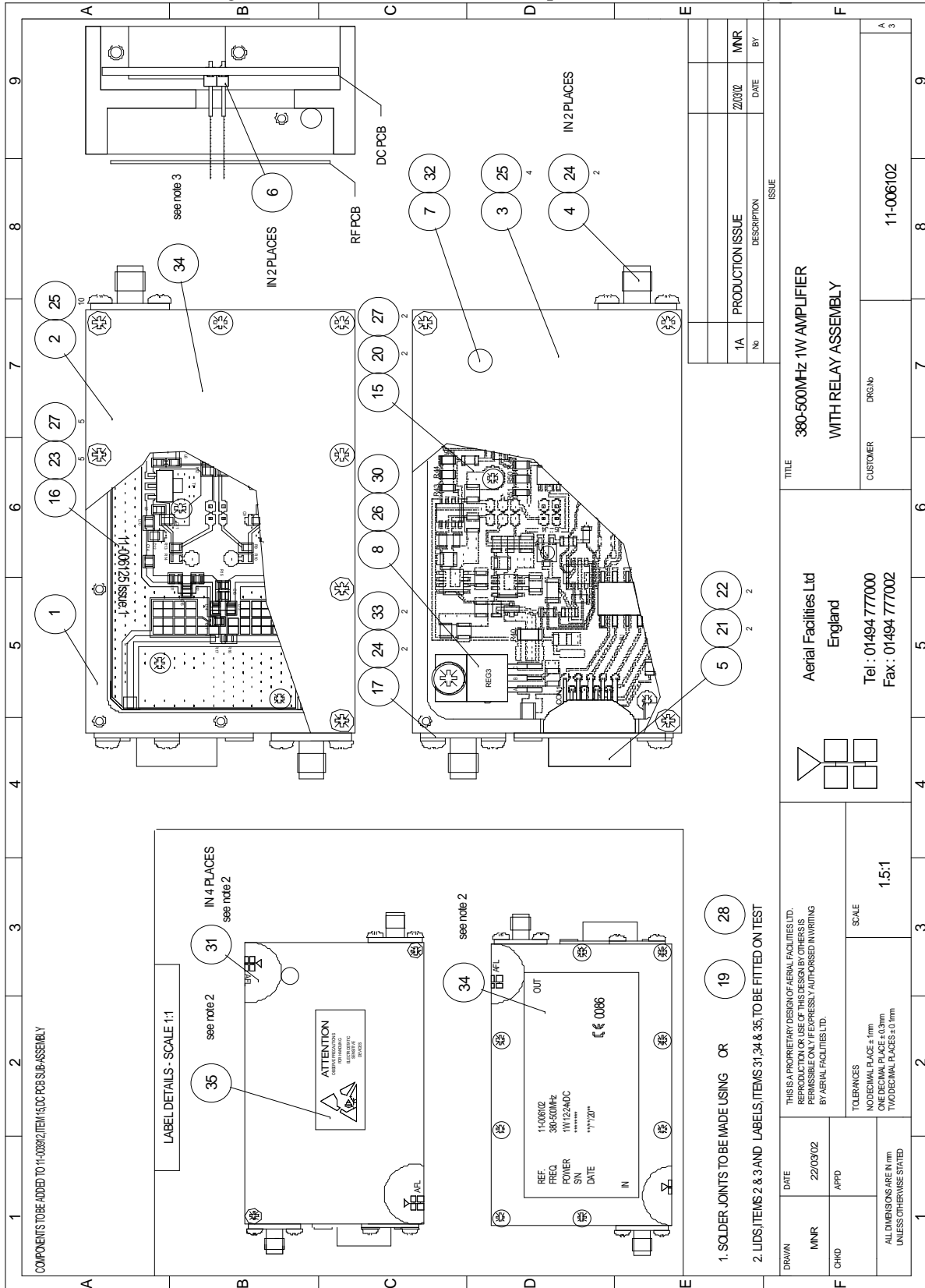

COMPONENTS TO BE ADDED TO 11-00892 ITEM 15 DC PCB SUB-ASSEMBLY

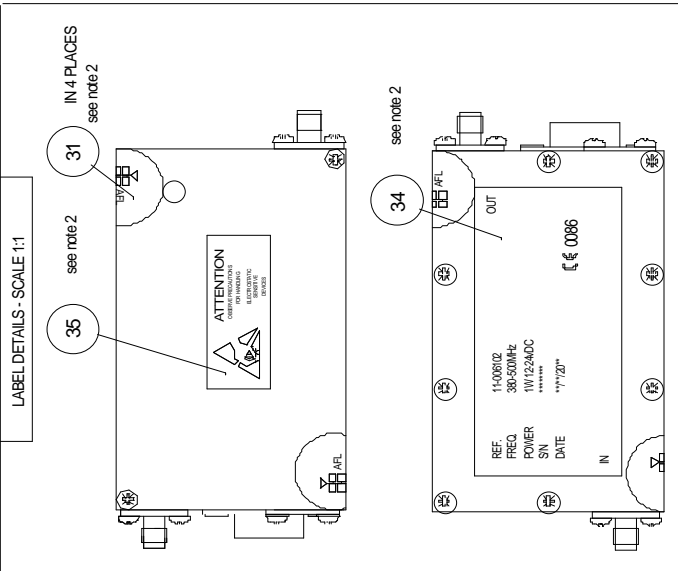

- 1. SOLDER JOINTS TO BE MADE USING OR 19 28
- 2. LIDS/ITEMS 2 & 3 AND LABELS/ITEMS 31,34 & 35, TO BE FITTED ON TEST

DATE	22/03/02	TITLE		380-500MHz 1W AMPLIFIER	
DRAWN	MNR	PRODUCTION ISSUE	DESCRIPTION	ISSUE	
CHKD	APPD	No	DATE	BY	
TOLERANCES			CUSTOMER		
NOMINAL PLACE ± 1mm			DRG No		
ONE DECIMAL PLACE ± 0.3mm			11-006102		
TWO DECIMAL PLACES ± 0.1mm			WITH RELAY ASSEMBLY		
SCALE			A		
1.5:1			3		
ALL DIMENSIONS ARE IN mm UNLESS OTHERWISE STATED					

5.1.4.4 Drg. No. 11-006170, LNA RF Circuit Diagram

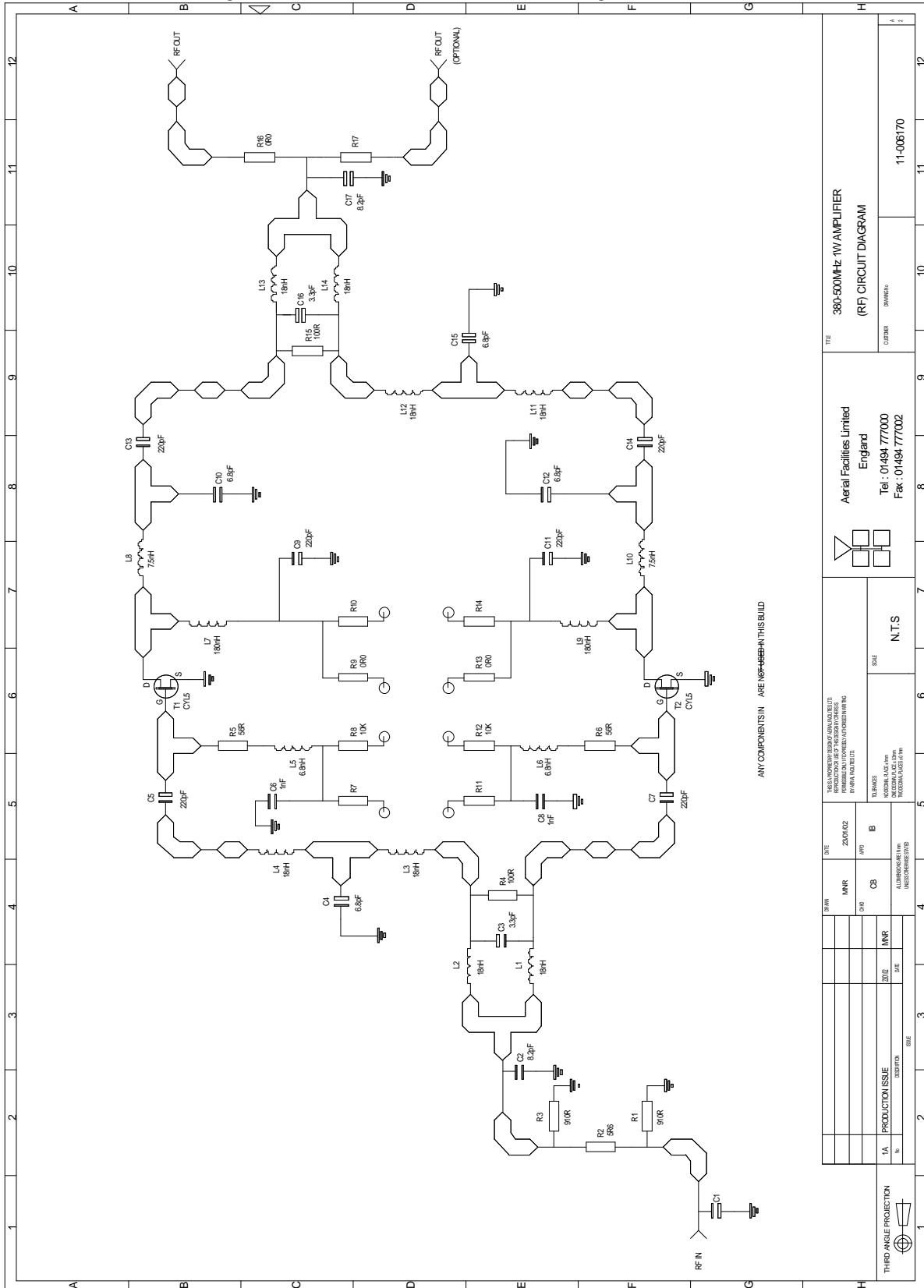

ANY COMPONENTS ARE ISE4684 THIS BUILD

		TITLE 380-500MHz 1W AMPLIFIER (RF) CIRCUIT DIAGRAM		Dwg No. 11-006170	
DRAWN MNR		DATE 28/07/02		Aerial Facilities Limited England Tel: 01484 777000 Fax: 01484 777002	
CHECKED MNR		APPROVED IB		SCALE N.T.S	
ISSUE 01		REVISION 01		THIS DRAWING IS THE PROPERTY OF AERIAL FACILITIES LIMITED AND IS NOT TO BE REPRODUCED OR TRANSMITTED IN ANY FORM OR BY ANY MEANS, ELECTRONIC OR MECHANICAL, INCLUDING PHOTOCOPYING, RECORDING, OR BY ANY INFORMATION STORAGE AND RETRIEVAL SYSTEM.	
THIRD ANGLE PROJECTION		T/A PRODUCTION/ISSUE 01		DIMENSIONS IN MILLIMETERS UNLESS OTHERWISE SPECIFIED	

5.1.4.5 Drg. No. 11-006171, LNA DC Wiring Diagram

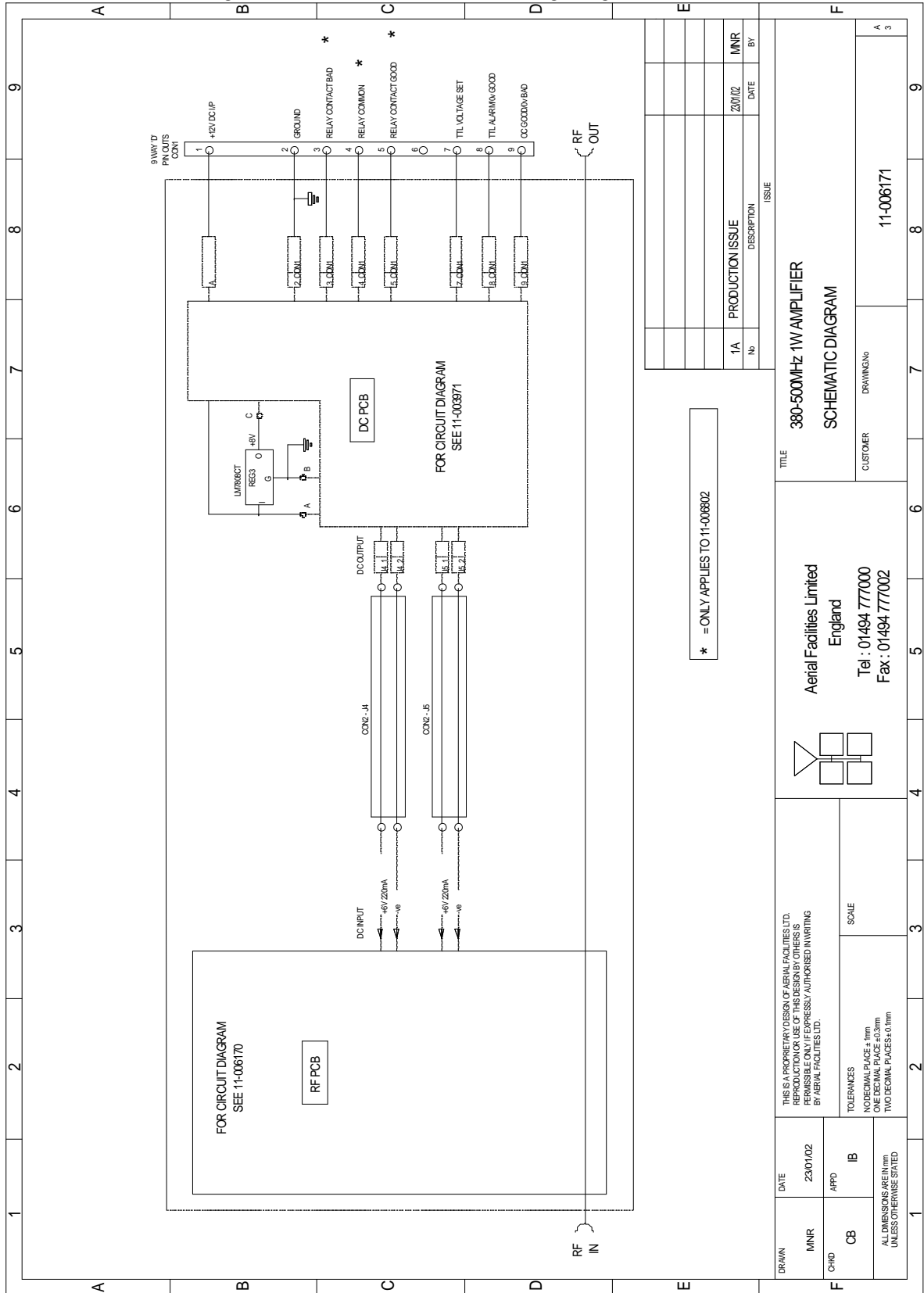

* = ONLY APPLIES TO 11-006802

1A	PRODUCTION ISSUE	DESCRIPTION	DATE	BY
No			23/01/02	MNR

TITLE
380-500MHz 1W AMPLIFIER
SCHEMATIC DIAGRAM

Aerial Facilities Limited
England
Tel : 01494 777000
Fax : 01494 777002

THIS IS A PROPRIETARY DESIGN OF AERIAL FACILITIES LTD.
REPRODUCTION OR USE OF THIS DESIGN BY OTHERS IS
STRICTLY PROHIBITED WITHOUT THE WRITTEN
CONSENT OF AERIAL FACILITIES LTD.

TOLEANCES
NODECIMAL PLACE ± 1mm
ONE DECIMAL PLACE ± 0.3mm
TWO DECIMAL PLACES ± 0.1mm

SCALE

DRAWN	DATE	23/01/02
MNR	APPD	IB
CB	ALL DIMENSIONS ARE IN mm UNLESS OTHERWISE STATED	

5.1.4.6 Drg. No. 11-003971, LNA DC Schematic Diagram

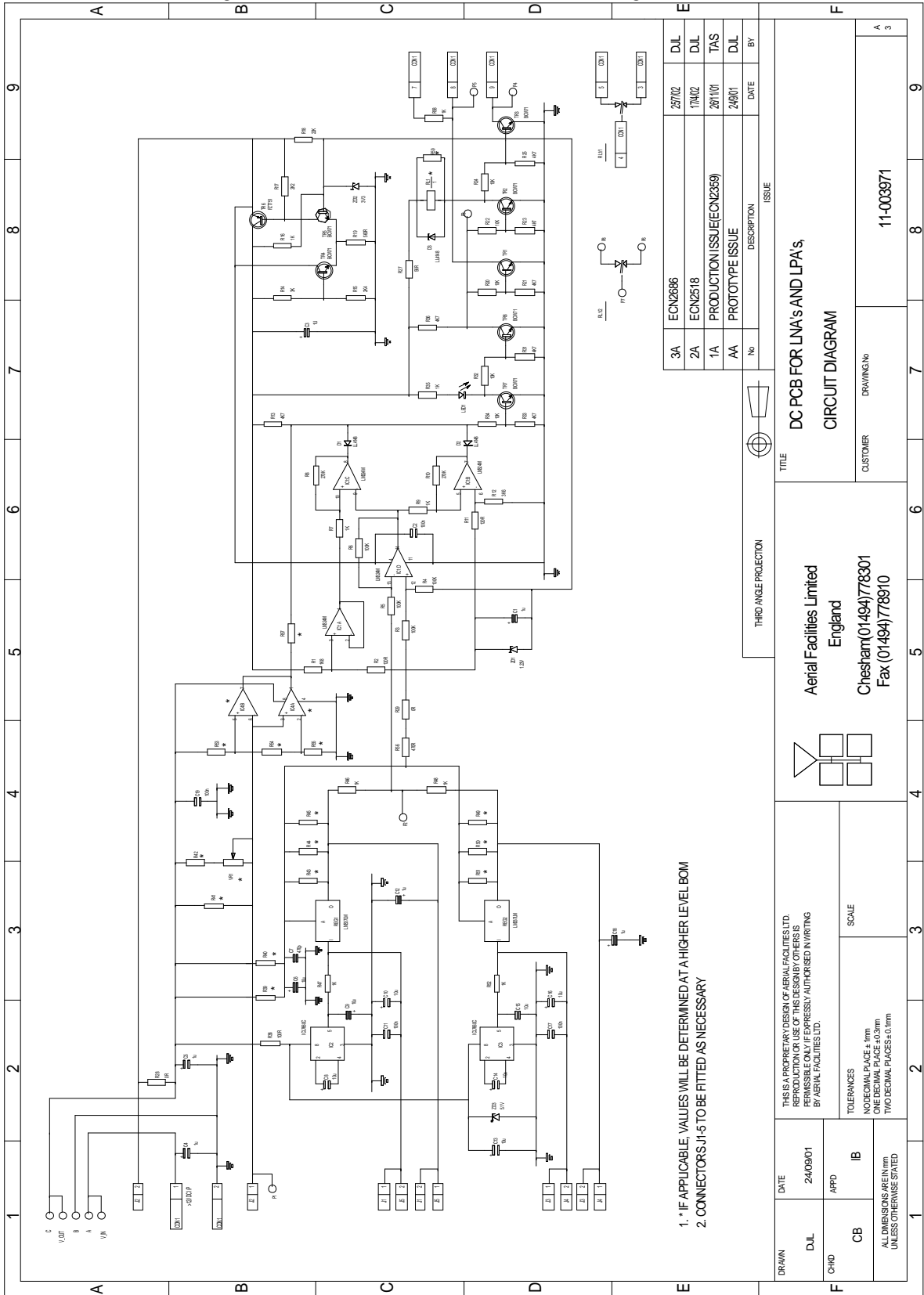

5.1.4.7 Technical Specification (11-007302)

Frequency range:	380-500MHz	
Bandwidth:	<140MHz	
Gain:	20-22dB	
1dB Compression Point:	+23.5dB (typical)	
3rd order intercept:	+36dB (typical)	
Input/Output return loss:	>20dB	
Noise figure:	<1.3dB	
Connectors:	SMA female	
Supply:	200-230mA @ 24V DC	
Temperature range:	operational:	-10°C to +55°C
	storage:	-30°C to +70°C
Weight:	<300gms	
Size:	90 x 55 x 30.2 (case only)	

5.1.4.8 Drg. No. 11-007302, LNA Assembly With Alarm Relay

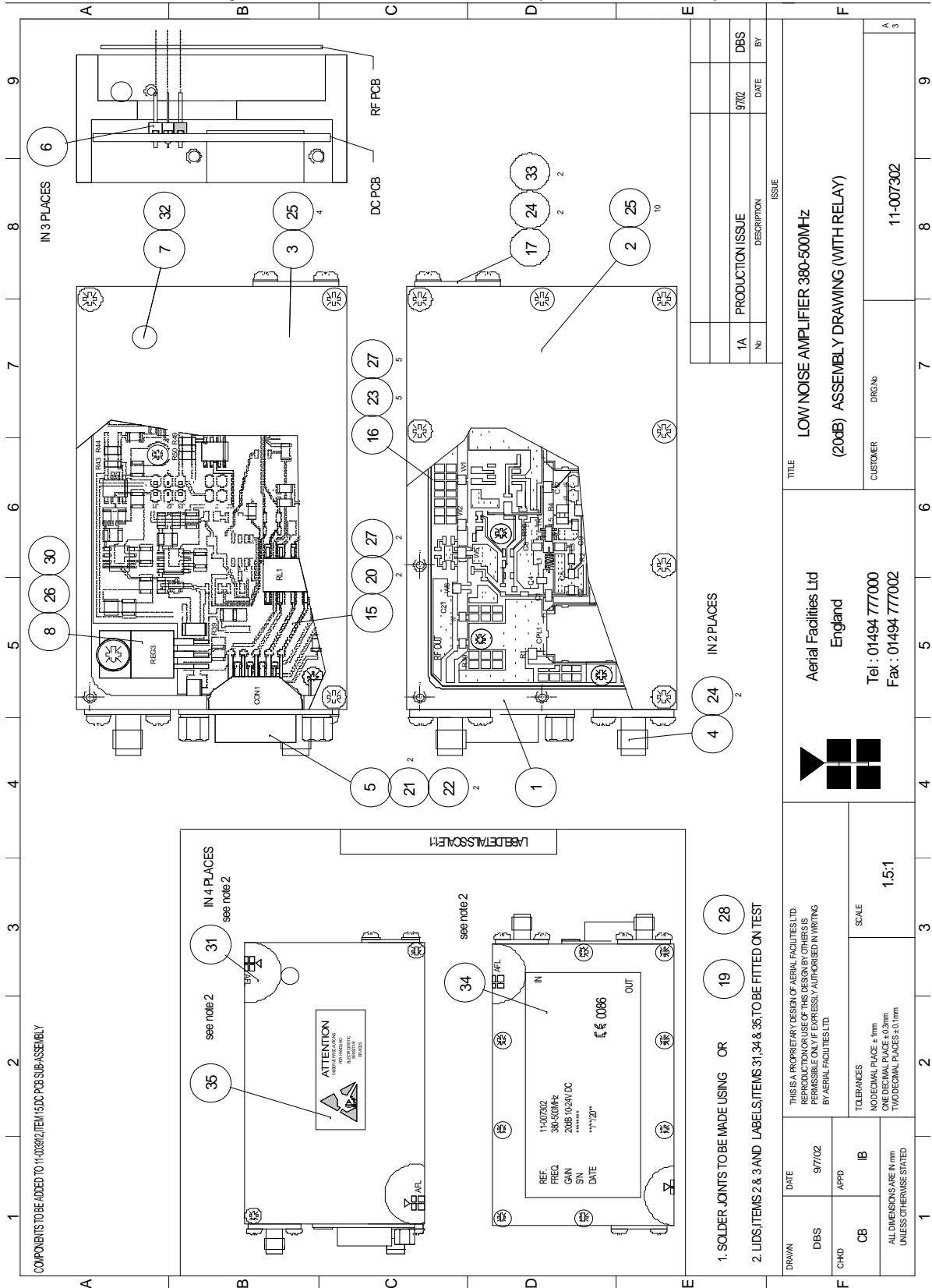

1A	PRODUCTION ISSUE	9702	DBS
No	DESCRIPTION	DATE	BY
ISSUE			

TITLE		LOW NOISE AMPLIFIER 380-500MHZ
DESCRIPTION		(20dB) ASSEMBLY DRAWING (WITH RELAY)
CUSTOMER	DRGN No	11-007302
A		3

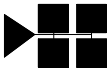
Aerial Facilities Ltd
 England
 Tel : 01494 777000
 Fax : 01494 777002

DATE	9/7/02	SCALE	1.5:1
APPD	IB	TOLERANCES	
ALL DIMENSIONS ARE IN mm UNLESS OTHERWISE STATED		NOMINAL PLACE ±.1mm DIMENSIONAL PLACES ±.01mm TWO DECIMAL PLACES ±.01mm	

5.1.4.9 Drg. No. 11-007370, LNA RF Circuit Diagram

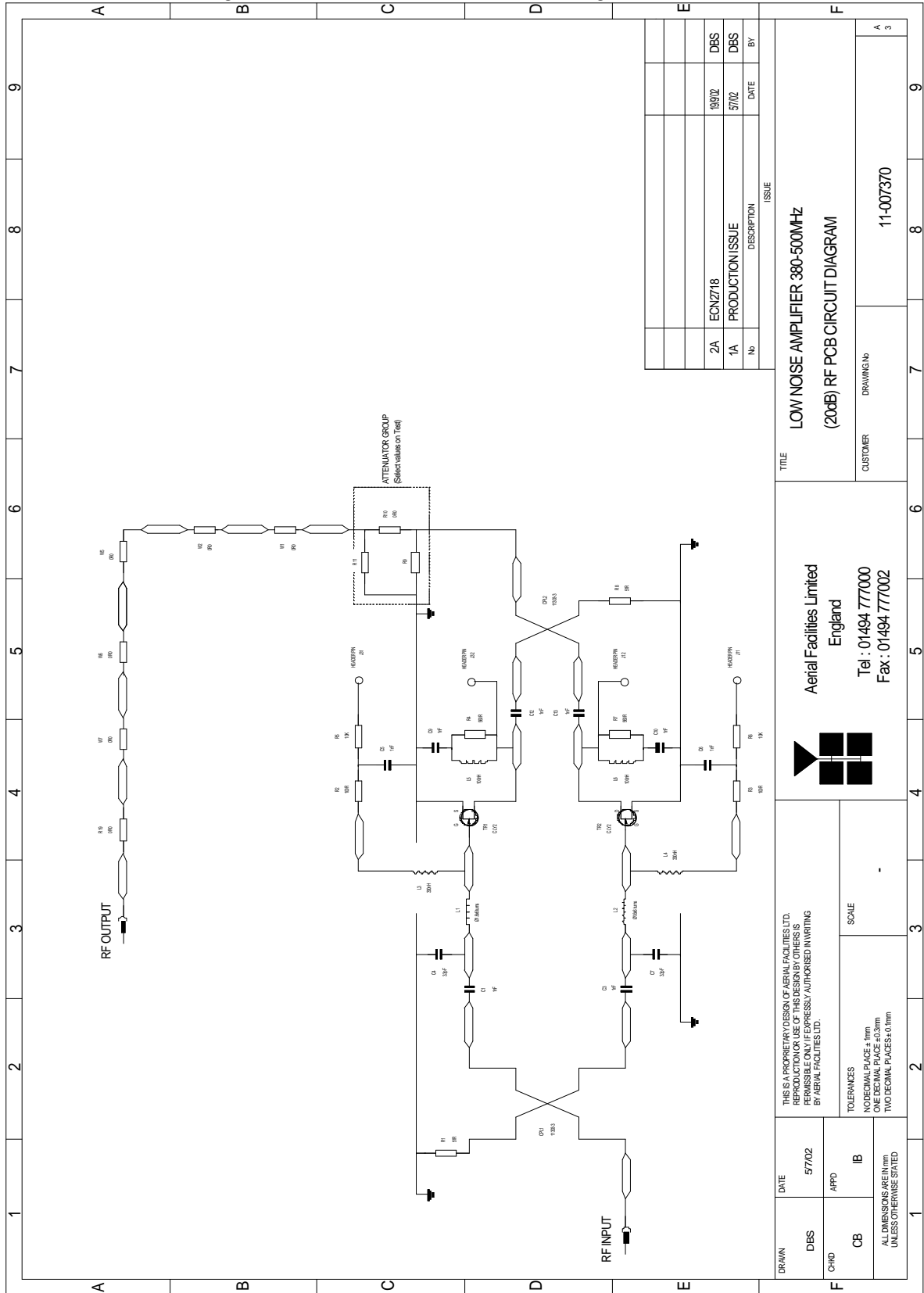

2A	ECNZ718	19/02	DBS
1A	PRODUCTION ISSUE	5/02	DBS
No	DESCRIPTION	DATE	BY

TITLE		LOW NOISE AMPLIFIER 380-500MHz (20dB) RF PCB CIRCUIT DIAGRAM
CUSTOMER	DRAWING No	11-007370

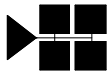
Aerial Facilities Limited
 England
 Tel : 01494 777000
 Fax : 01494 777002

THIS IS A PROPRIETARY DESIGN OF AERIAL FACILITIES LTD. REPRODUCTION, USE OF THIS DESIGN OR OTHERS IS STRICTLY PROHIBITED UNLESS EXPRESSLY AUTHORISED IN WRITING BY AERIAL FACILITIES LTD.

TOLERANCES
 NODECIMAL PLACE ± 0.1mm
 ONE DECIMAL PLACE ± 0.2mm
 TWO DECIMAL PLACES ± 0.1mm

SCALE
 -

DRAWN	DATE	5/7/02
DBS	APPD	IB
CB	ALL DIMENSIONS ARE IN mm UNLESS OTHERWISE STATED	

5.1.4.10 Drg. No. 11-007371, LNA DC Wiring Diagram

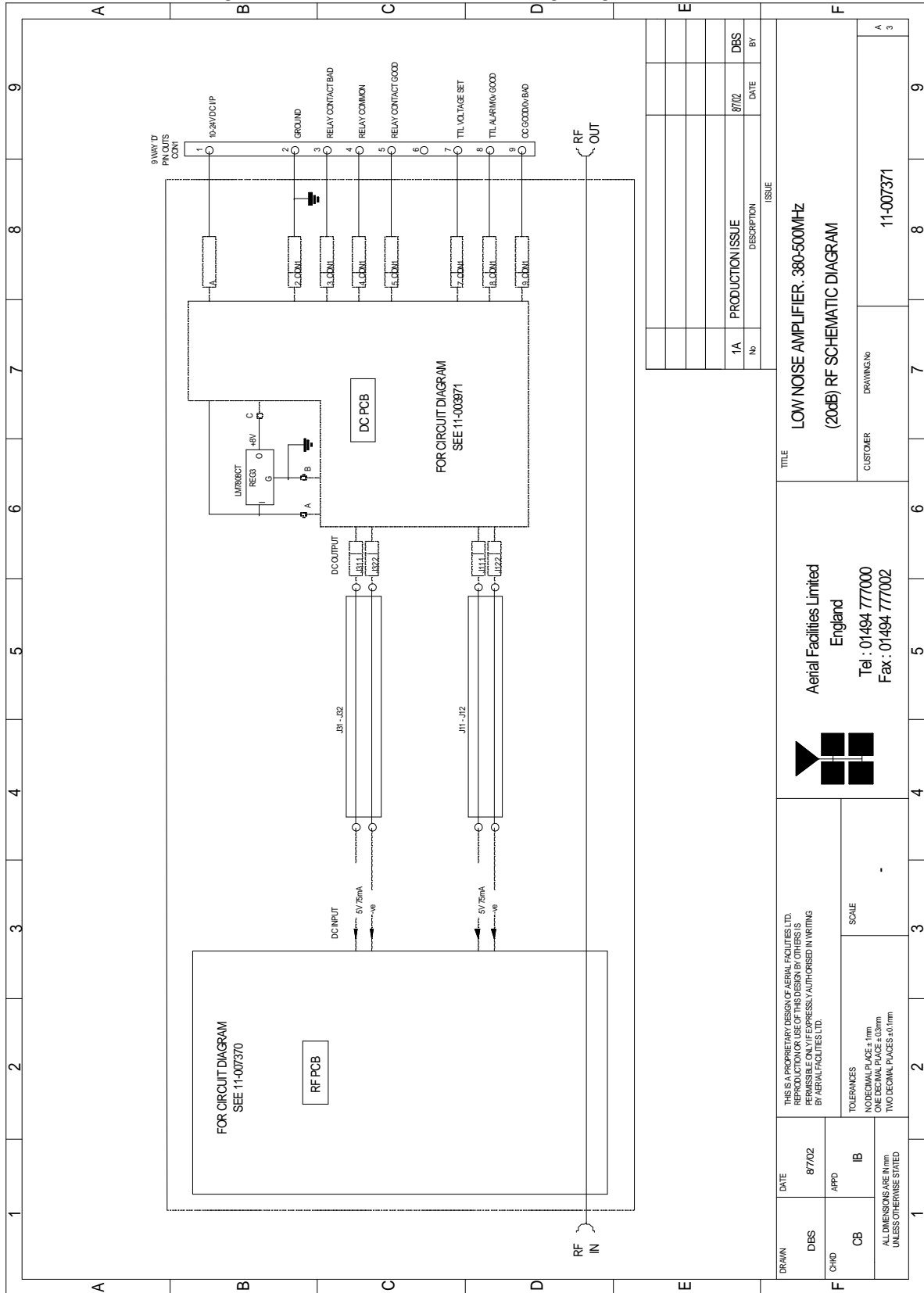

 Aerial Facilities Limited England Tel : 01494 777000 Fax : 01494 777002		TITLE LOW NOISE AMPLIFIER, 380-500MHz (20dB) RF SCHEMATIC DIAGRAM	
THIS IS A PROPRIETARY DESIGN OF AERIAL FACILITIES LTD. REPRODUCTION OR USE OF THIS DESIGN BY OTHERS IS EXPRESSLY FORBIDDEN WITHOUT THE EXPRESS AUTHORITY IN WRITING BY AERIAL FACILITIES LTD.		SCALE -	
DATE	87/02	TOLERANCES	
DBS	IB	NOMINAL PLACE: ± 1mm	
CB		ONE DECIMAL PLACE: ± 0.2mm	
ALL DIMENSIONS ARE IN mm UNLESS OTHERWISE STATED		TWO DECIMAL PLACES: ± 0.1mm	
CUSTOMER DRAWING No 11-007371		ISSUE No DESCRIPTION DATE BY	

5.1.4.11 Technical Specification (11-007402)

Frequency range:	380-500MHz	
Bandwidth:	<140MHz	
Gain:	30-32dB	
1dB Compression Point:	+22dB (typical)	
3rd order intercept:	+34dB (typical)	
Input/Output return loss:	>19dB	
Noise figure:	<1.3dB	
Connectors:	SMA female	
Supply:	300-330mA @ 10-24V DC	
Temperature range:	operational:	-10°C to +55°C
	storage:	-30°C to +70°C
Weight:	<300gms	
Size:	90 x 55 x 30.2 (case only)	

5.1.4.12 Drg. No. 11-007402, LNA General Assembly

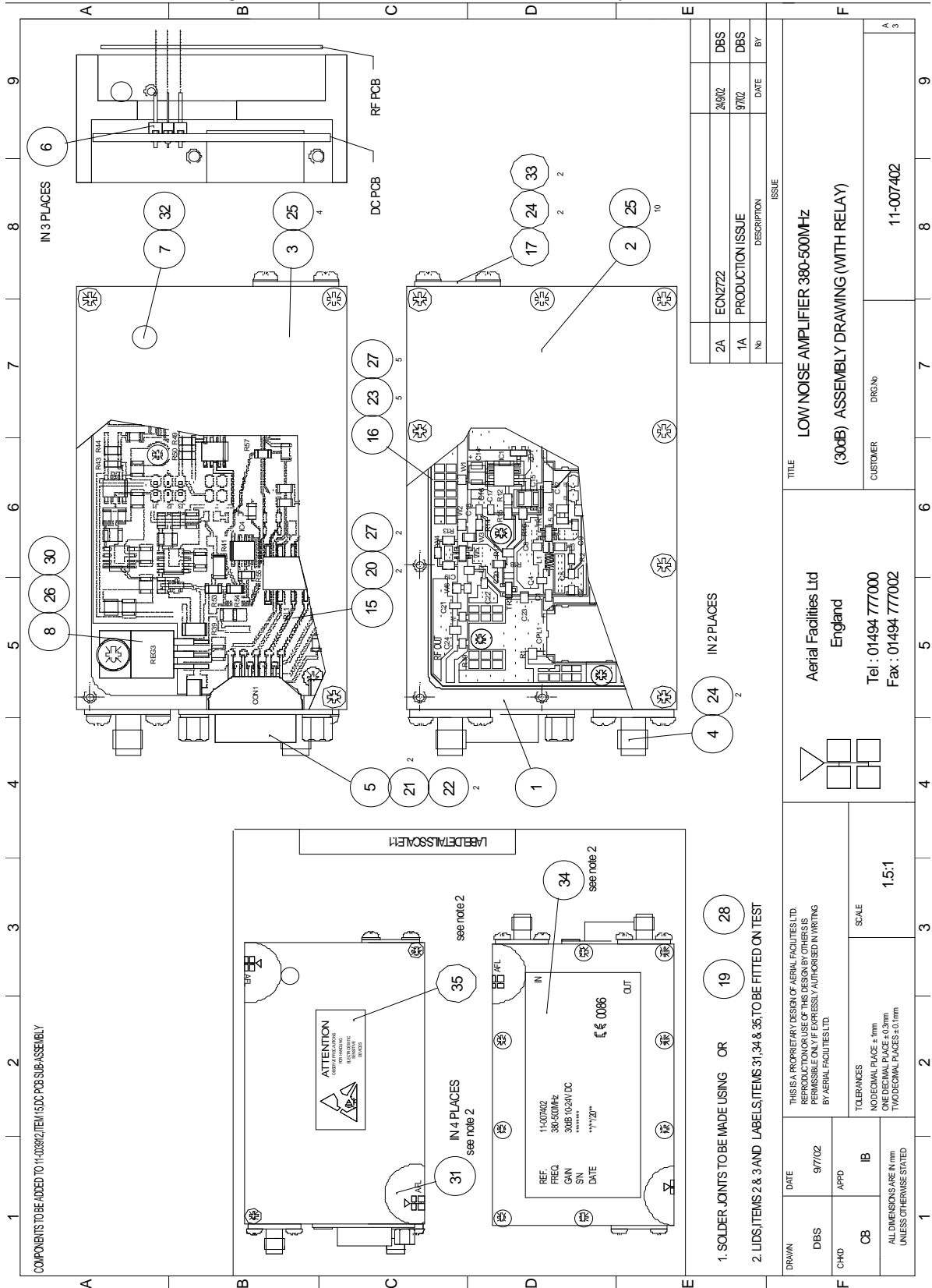

2A	ECN2722	24/02	DBS
1A	PRODUCTION ISSUE	97/02	DBS
No		DATE	BY

TITLE		LOW NOISE AMPLIFIER 380-500MHZ
DESCRIPTION		(30dB) ASSEMBLY DRAWING (WITH RELAY)
CUSTOMER	DRGN No	11-007402
		1 3

Aerial Facilities Ltd England		Tel : 01494 777000 Fax : 01494 777002
		SCALE 1.5:1

DATE	9/7/02	SCALE	1.5:1
APPD	IB	TOLERANCES	NOMINAL PLACE ±.1mm DIMENSIONAL PLACES ±.05mm TWO DECIMAL PLACES ±.01mm UNLESS OTHERWISE STATED

5.1.4.13 Drg. No. 11-007470, LNA RF Circuit Diagram

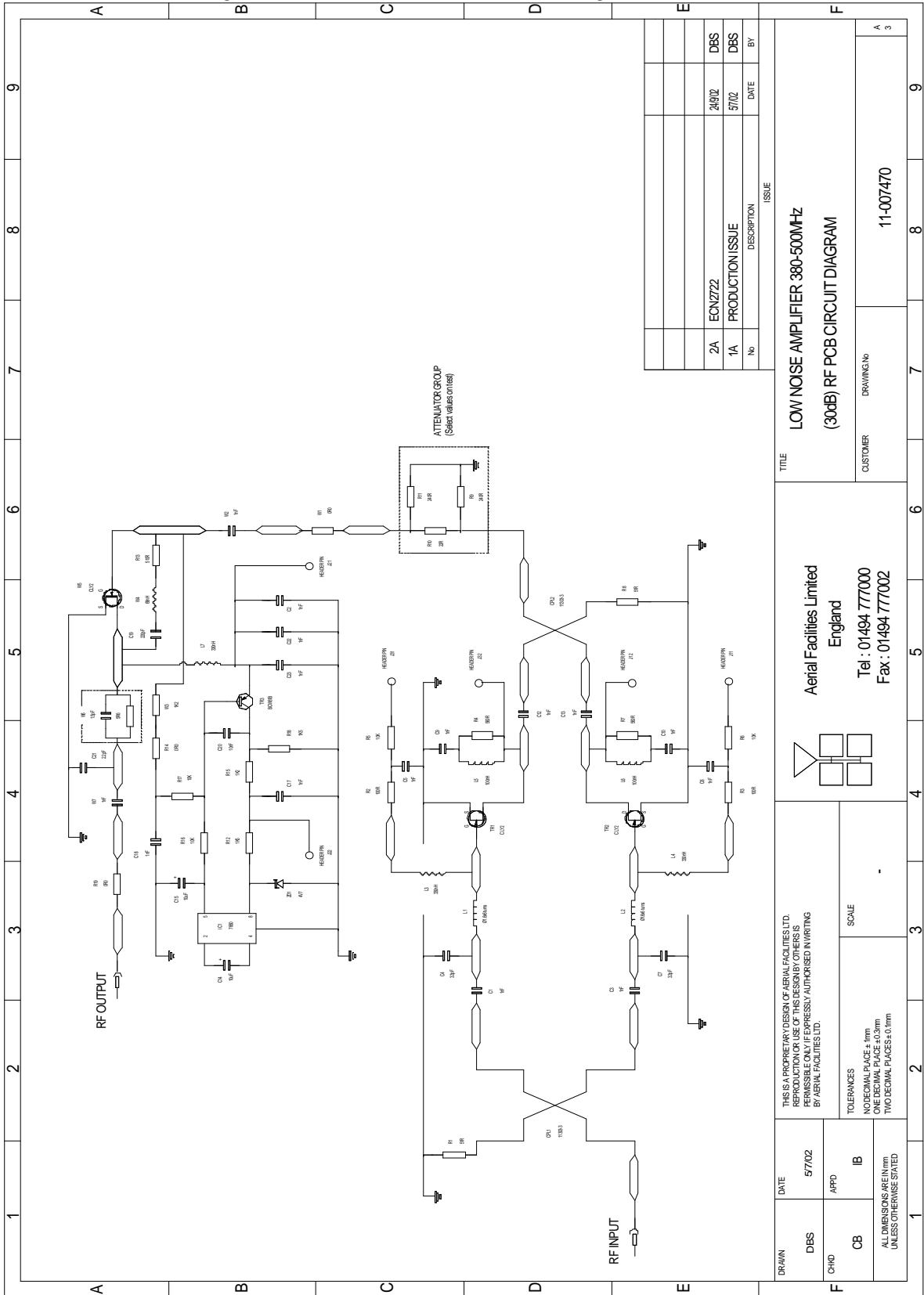

5.1.4.14 Drg. No. 11-007471 LNA DC Wiring Diagram

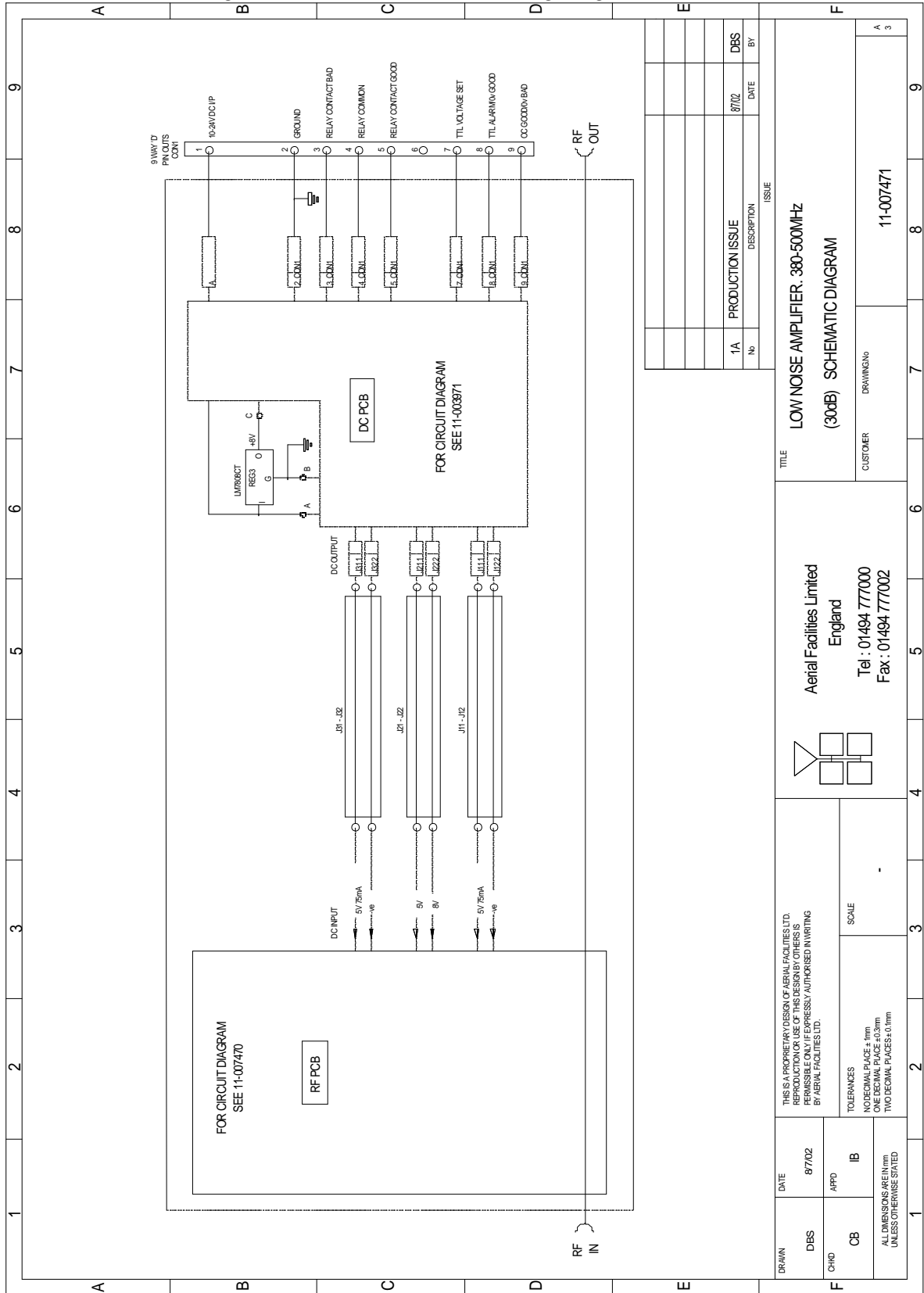

1A	PRODUCTION ISSUE	87/02	DBS
No	DESCRIPTION	DATE	BY
ISSUE			

TITLE
LOW NOISE AMPLIFIER, 380-500MHZ
(30dB) SCHEMATIC DIAGRAM

Aerial Facilities Limited
England
Tel : 01494 777000
Fax : 01494 777002

THIS IS A PROPRIETARY DESIGN OF AERIAL FACILITIES LTD.
REPRODUCTION OR USE OF THIS DESIGN BY OTHERS IS
STRICTLY PROHIBITED WITHOUT THE WRITTEN
CONSENT OF AERIAL FACILITIES LTD.

TOLERANCES
NODECIMAL PLACE ± 1mm
ONE DECIMAL PLACE ± 0.3mm
TWO DECIMAL PLACES ± 0.1mm

SCALE

DRAWN	DATE	87/02
DBS	APPD	IB
ALL DIMENSIONS ARE IN mm UNLESS OTHERWISE STATED		

5.1.5 5Watt Power Amplifier (12-001801)

5.1.5.1 Description

The power amplifier fitted to this unit is a multi-stage, solid state class A power amplifier. All the semi-conductor devices are very conservatively rated to ensure low device junction temperatures and a long, trouble free working lifetime.

The power amplifier should require no maintenance over its operating life. Under no circumstances should the cover be removed or the side adjustments disturbed unless it is certain that the amplifier has failed; since it is critically aligned during manufacture and any re-alignment will require extensive test equipment.

5.1.5.2 Technical Specification

Frequency Range:	400 - 500MHz (tuned to spec.)
Bandwidth:	20MHz (typical, tuneable)
Maximum Output Power:	>5W
Gain:	30dB
3rd Order Intercept Point:	<+37dBm
1dB Compression Point:	<+48dBm
VSWR:	better than 1.45:1
Connectors:	SMA female
Supply:	1.25A @ 24V DC
Temperature range:	operational: -10°C to +55°C
	storage: -40°C to +70°C
Size:	276 x 78 x 40mm (case only)
Weight:	1.5 kg (excluding heatsink)

5.1.5.3 Drg. No. 12-001801_5Watt PA General Assembly Drawing

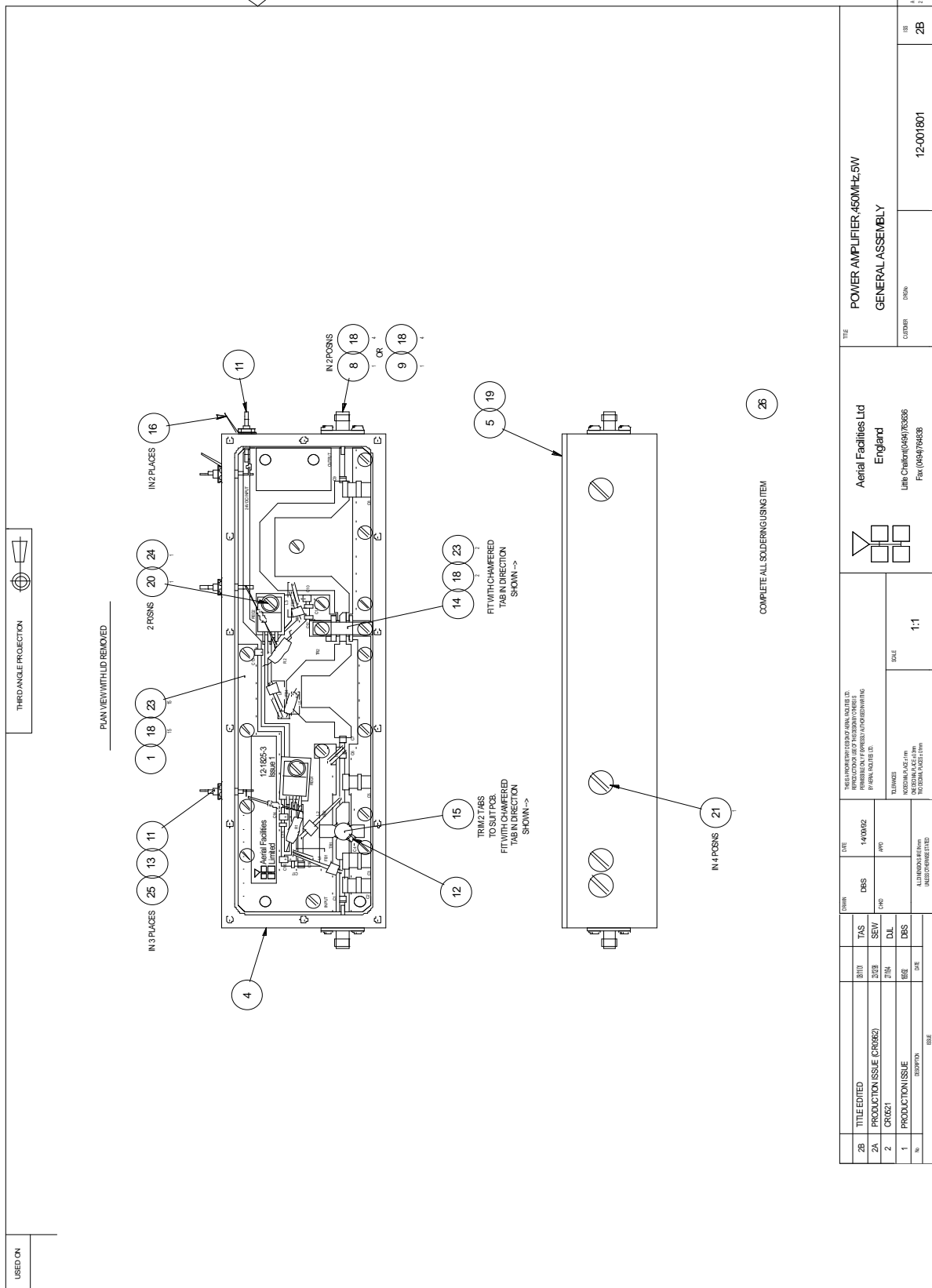

USED ON

	Aerial Facilities Ltd Erigland Little Chobon (0491) 76366 Fax: (0491) 76438		TITLE POWER AMPLIFIER 450MHz 5W GENERAL ASSEMBLY		CUSTOMER 12-001801	DRAWN 2B	ISSUE 2B
THIS DRAWING IS THE PROPERTY OF AERIAL FACILITIES LIMITED. IT IS NOT TO BE REPRODUCED OR TRANSMITTED IN ANY FORM OR BY ANY MEANS, ELECTRONIC OR MECHANICAL, INCLUDING PHOTOCOPYING, RECORDING, OR BY ANY INFORMATION STORAGE AND RETRIEVAL SYSTEM, WITHOUT THE WRITTEN PERMISSION OF AERIAL FACILITIES LIMITED.		SCALE 1:1					
DATE 14/04/02	DESIGNED BY DBS	DRAWN BY DBS	CHECKED BY DBS				
TITLE PRODUCTION ISSUE (CR062)	DATE 27/08	DRAWN DBS	CHECKED DBS				
TITLE PRODUCTION ISSUE	DATE 27/08	DRAWN DBS	CHECKED DBS				

5.1.5.5 Drg. No. 12-001870C1, 5W PA Component List(1)

USED ON	CIRC. REF.	AFL STOCK REF.	DESCRIPTION								
12-1801	C1	CAP0705	56pF CHIP CAP 10% TOL. (MIN)								
	C2	CAP0650	P.C.B MOUNT AIR TRIMMER 1 - 14pF								
	C3	CAP0650	P.C.B MOUNT AIR TRIMMER 1 - 14pF								
	C4	CAP0711	27pF CHIP CAP 10% TOL (MIN)								
	C5	CAP0650	P.C.B MOUNT AIR TRIMMER 1 - 14pF								
	C6	CAP0705	56pF CHIP CAP 10% TOL. (MIN)								
	C7	CAP0713	120pF CHIP CAP 10% TOL. (MIN)								
	C8	CAP0650	P.C.B MOUNT AIR TRIMMER 1 - 14pF								
	C9	CAP0705	56pF CHIP CAP 10% TOL. (MIN)								
	C10	CAP0820	1uF TANTALUM CHIP CAPACITOR								
	C11	CAP0714	220pF CHIP CAP 10% TOL. (MIN)								
	C12	CAP0719	10 nF 63V 10% CHIP CAPACITOR								
	C13	CAP0820	1uF TANTALUM CHIP CAPACITOR								
	C14	CAP0820	1uF TANTALUM CHIP CAPACITOR								
	C15	CAP0719	10 nF 63V 10% CHIP CAPACITOR								
	C16	CAP0820	1uF TANTALUM CHIP CAPACITOR								
	C17	CAP0714	220pF CHIP CAP 10% TOL. (MIN)								
	C18	CAP0708	560pF CHIP CAP 10% TOL. (MIN)								
	C19	CAP0500	1000pF FEED THROUGH CAPACITOR								
	C20	CAP0500	1000pF FEED THROUGH CAPACITOR								
	C21	CAP0500	1000pF FEED THROUGH CAPACITOR								
	C22	CAP0500	1000pF FEED THROUGH CAPACITOR								
	FB1	FEC0001	FERROX BEAD 3S1 5 x 2 x 4 (FX4008)								
	FB2	FEC0001	FERROX BEAD 3S1 5 x 2 x 4 (FX4008)								
	FB3	FEC0001	FERROX BEAD 3S1 5 x 2 x 4 (FX4008)								
	FB4	FEC0001	FERROX BEAD 3S1 5 x 2 x 4 (FX4008)								
	L1	WIRO101	1.25 ENAMELLED COPPER WIRE								
	L2	WIRO101	1.25 ENAMELLED COPPER WIRE								
	L3	WIRO101	1.25 ENAMELLED COPPER WIRE								
	L4	WIRO101	1.25 ENAMELLED COPPER WIRE								
	L5	CHK0013	1.0uH CHOKE SIGMA SC10 SERIES								
	L6	WIRO006	18 S.W.G. TINNED COPPER WIRE								
2	27/1/94	CRO 521									
1	14/9/92	Prod. Issue									
ISSUE	DATE	CHANGE No.	ISSUE	DATE	CHANGE No.	ISSUE	DATE	CHANGE No.	ISSUE	DATE	CHANGE No.
		Aerial Facilities Limited				TITLE POWER AMPLIFIER, 450MHz 10W CIRCUIT COMPONENT LIST					
DRAWN	DATE	CHKD	APPD.	CUSTOMER	DRG. Nõ.						
DBS	14/9/92				12 - 001870C1						

5.1.5.6 Drg. No. 12-001870C2, 5W PA Component List(2)

USED ON	CIRC. REF.	AFL STOCK REF.	DESCRIPTION
12 - 1801	R1	RES 0515	5R6 WELWYN W21 V:E W:W 2.5W
	R2	RES 0510	1R2 WELWYN W21 V:E W:W 2.5W
	R3	RES 0071	1K M:F 0.25W MRS25 RESISTOR
	R4	RES 0071	1K M:F 0.25W MRS25 RESISTOR
	R5	RES 0071	1K M:F 0.25W MRS25 RESISTOR
	REG1	VLR0002	LM337T. VOLTAGE REGULATOR
	REG2	VLR0002	LM337T. VOLTAGE REGULATOR
	TR1	TRN0208	TPV596A/SD1439 / TCC596 PWR. TRANSISTOR
	TR2	TRN0204	TP 5015 R.F. POWER TRANSISTOR

2	27 / 1 / 94	CR 0521										
1	14 / 9 / 92	Prod. Issue										
ISSUE	DATE	Change No.	ISSUE	DATE	Change No.	ISSUE	DATE	Change No.	ISSUE	DATE	Change No.	
 Aerial Facilities Limited						TITLE POWER AMPLIFIER 450MHz, 10 Watt CIRCUIT COMPONENT LIST						
DRAWN DBS	DATE 14 / 9 / 92	CHKD.	APPD.	CUSTOMER			Drg. No. 12 - 001870C2			Iss. 2A		

5.1.5.7 Drg. No. 80-008450, Power Amplifier/Alarm Board DC Wiring Details

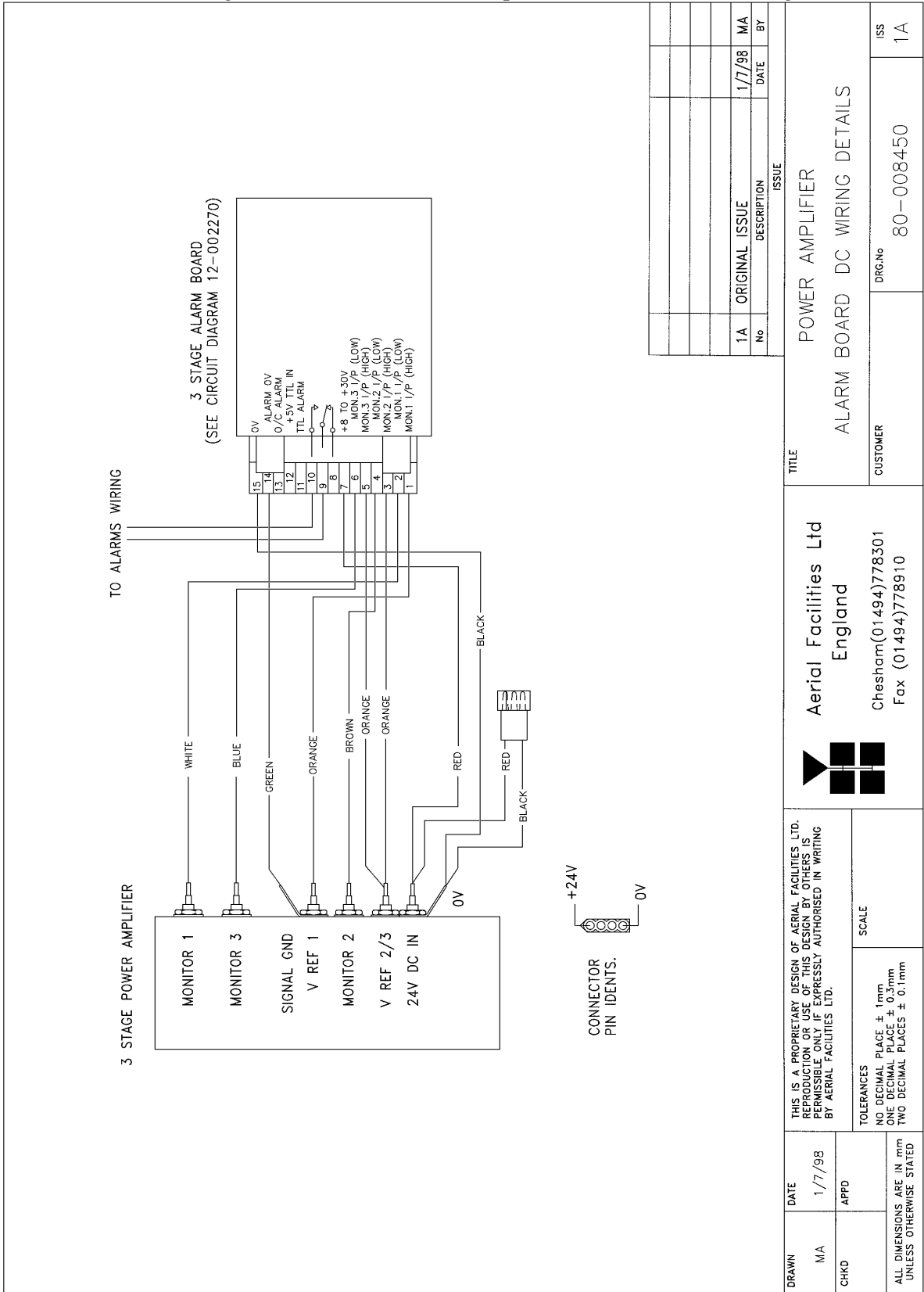

No	DESCRIPTION	DATE	BY
1A	ORIGINAL ISSUE	1/7/98	MA

DRAWN MA	DATE 1/7/98	TITLE POWER AMPLIFIER	
	CHKD APPD	ALARM BOARD DC WIRING DETAILS	
ALL DIMENSIONS ARE IN mm UNLESS OTHERWISE STATED		CUSTOMER Aerial Facilities Ltd England Chesham(01494)778301 Fax (01494)778910	ISS 1A
TOLERANCES NO DECIMAL PLACE ± 1mm ONE DECIMAL PLACE ± 0.3mm TWO DECIMAL PLACES ± 0.1mm		DRG.No 80-008450	
THIS IS A PROPRIETARY DESIGN OF AERIAL FACILITIES, LTD. REPRODUCTION OR USE OF THIS DESIGN BY OTHERS IS PERMISSIBLE ONLY IF EXPRESSLY AUTHORISED IN WRITING BY AERIAL FACILITIES LTD.		SCALE	

5.1.6 3 Stage Amplifier Alarm Boards (12-002201)

5.1.6.1 Description

Amplifier Alarm Boards are fitted to monitor the bias conditions of AFL Class A amplifiers which remain constant in normal operation. Any departure from normal bias conditions is a result of device failure, excess temperature, over-driving or oscillation (excessive power).

In normal operation, the Class A bias circuit of the amplifier develops a constant voltage of 1.20V across the collector current setting resistor. The Amplifier Alarm Board is a window comparator device, which is adjusted to sense a departure from this condition. Several different alarm outputs are provided to simplify interfacing, (Relay Contact, Open Collector, and TTL Logic Levels)

The basic version of the Alarm Board (12-002801) monitors a single amplifier stage. A three-stage version (12-002201) is used on complex amplifiers where three separate comparators have their outputs logically combined to a common output stage. Failure of any one stage will activate the alarms.

Note that the alarm board has a green Light Emitting Diode located near to the centre of the printed circuit board, which is illuminated on 'Good', and extinguished on 'Alarm'. It is therefore a simple matter to identify an active module failure, by searching for an Alarm Board which has its green LED extinguished. A simple test of the alarm board is possible by shorting across the monitor inputs, pins 1 and 2, 3 and 4 or across pins 5 and 6. This last monitor input is inactive if the board has been converted to a two way alarm board. (Refer to relevant amplifier alarm wiring diagram.)

- 1) Volt-free change over relay contacts.
- 2) Open collector NPN transistor pulls low on alarm.
- 3) TTL driver.

The use of precision voltage sources and resistors has eliminated the need for initial adjustment or calibration, and the board will function correctly with a wide variation in power supply voltage (8 to 30 volts, nominal supply is 12 or 24Volts).

There are two selectable link options on the three-way board:

LINK1 - Removed to convert to two-way alarm board.

LINK2 - Removed to isolate 0V from chassis earth.

The one way alarm board only has the 0V isolation link (LINK2) fitted.

 Aerial Facilities Limited www.AerialFacilities.com Technical Literature	PBL UHF 1 & 2 Air Interface Maintenance Handbook		
	H/book Number:- 60-055900HBKM	Issue No:-1	Date:- 13/02/2003

5.1.6.2 Technical Specification

Operating voltage:		8 to 30V (floating earth)
Alarm Threshold:		V _{cc} - 1.20 volt \pm 15%
Alarm output relay contacts:		
Max. switch current:		1.0Amp
Max. switch volts:		120Vdc/60VA
Max. switch power:		24W/60VA
Min. switch load:		10.0 μ A/10.0mV
Relay isolation:		1.5kV
Mechanical life:		>2x10 ⁷ operations
Relay approval:		BT type 56
Connector details:		15-way 0.1" pitch
Temperature range:	operational:	:-10°C to +55°C
	storage:	:-40°C to +70°C
PCB Size:		74 x 56mm (3 stage)
		54 x 56mm (1 stage)

5.1.6.3 Drg. No. 12-002201, 3 Stage Alarm Board Assembly Drawing & Parts List

REF. NO.	AFL STOCK REF.	DESCRIPTION	REF. NO.	AFL STOCK REF.	DESCRIPTION
R1	93-530040	1.00K 0.125W 2% CHIP RESISTOR	TR4	94-200007	80W71 NPN TRANSISTOR SMD
R2	93-530024	1.00K 0.125W 2% CHIP RESISTOR	TR5	94-200007	80W71 NPN TRANSISTOR SMD
R3	93-530024	1.00K 0.125W 2% CHIP RESISTOR	TR6	94-200010	F7751/755 PNP TRAM SMD
R4	93-530024	1.00K 0.125W 2% CHIP RESISTOR	IC1	94-210001	LM324AN SMD QUAD OP AMP
R5	93-530024	1.00K 0.125W 2% CHIP RESISTOR	IC2	94-210001	LM324AN SMD QUAD OP AMP
R6	93-530024	1.00K 0.125W 2% CHIP RESISTOR	IC3	94-210001	LM324AN SMD QUAD OP AMP
R7	93-530024	1.00K 0.125W 2% CHIP RESISTOR	RL1	98-900004	8V DPDT NON LATCHING RELAY
R8	93-530024	1.00K 0.125W 2% CHIP RESISTOR	H1	91-700016	15 WAY 0.1" LOCKING HEADER PCB
R9	93-530024	1.00K 0.125W 2% CHIP RESISTOR			
R10	93-530024	1.00K 0.125W 2% CHIP RESISTOR			
R11	93-530024	1.00K 0.125W 2% CHIP RESISTOR			
R12	93-530024	1.00K 0.125W 2% CHIP RESISTOR			
R13	93-530024	1.00K 0.125W 2% CHIP RESISTOR			
R14	93-530024	1.00K 0.125W 2% CHIP RESISTOR			
R15	93-530024	1.00K 0.125W 2% CHIP RESISTOR			
R16	93-530024	1.00K 0.125W 2% CHIP RESISTOR			
R17	93-530024	1.00K 0.125W 2% CHIP RESISTOR			
R18	93-530024	1.00K 0.125W 2% CHIP RESISTOR			
R19	93-530024	1.00K 0.125W 2% CHIP RESISTOR			
R20	93-530024	1.00K 0.125W 2% CHIP RESISTOR			
R21	93-530024	1.00K 0.125W 2% CHIP RESISTOR			
R22	93-530024	1.00K 0.125W 2% CHIP RESISTOR			
R23	93-530024	1.00K 0.125W 2% CHIP RESISTOR			
R24	93-530024	1.00K 0.125W 2% CHIP RESISTOR			
R25	93-530024	1.00K 0.125W 2% CHIP RESISTOR			
R26	93-530024	1.00K 0.125W 2% CHIP RESISTOR			
R27	93-530024	1.00K 0.125W 2% CHIP RESISTOR			
R28	93-530024	1.00K 0.125W 2% CHIP RESISTOR			
R29	93-530024	1.00K 0.125W 2% CHIP RESISTOR			
R30	93-530024	1.00K 0.125W 2% CHIP RESISTOR			
R31	93-530024	1.00K 0.125W 2% CHIP RESISTOR			
R32	93-530024	1.00K 0.125W 2% CHIP RESISTOR			
R33	93-530024	1.00K 0.125W 2% CHIP RESISTOR			
R34	93-530024	1.00K 0.125W 2% CHIP RESISTOR			
R35	93-530024	1.00K 0.125W 2% CHIP RESISTOR			
R36	93-530024	1.00K 0.125W 2% CHIP RESISTOR			
R37	93-530024	1.00K 0.125W 2% CHIP RESISTOR			
R38	93-530024	1.00K 0.125W 2% CHIP RESISTOR			
R39	93-530024	1.00K 0.125W 2% CHIP RESISTOR			
R40	93-530024	1.00K 0.125W 2% CHIP RESISTOR			
R41	93-530024	1.00K 0.125W 2% CHIP RESISTOR			
R42	93-530024	1.00K 0.125W 2% CHIP RESISTOR			
C1	93-240004	1UF TANTALUM CHIP CAP 35V SMD			
C2	93-200021	100NF 63V 10X CHIP CAPACITOR			
C3	93-200021	100NF 63V 10X CHIP CAPACITOR			
C4	93-200021	100NF 63V 10X CHIP CAPACITOR			
C5	93-200021	100NF 63V 10X CHIP CAPACITOR			
C6	93-200021	100NF 63V 10X CHIP CAPACITOR			
C7	93-240004	1UF TANTALUM CHIP CAP 35V SMD			
C8	93-240004	1UF TANTALUM CHIP CAP 35V SMD			
D1	94-150003	1.25V VOLTAGE REFERENCE DIODE			
D2	94-150001	LM4148 GP JMMHELY DIODE SMD			
D3	94-150001	LM4148 GP JMMHELY DIODE SMD			
D4	94-150001	LM4148 GP JMMHELY DIODE SMD			
D5	94-150001	LM4148 GP JMMHELY DIODE SMD			
D6	94-150001	LM4148 GP JMMHELY DIODE SMD			
D7	94-150001	LM4148 GP JMMHELY DIODE SMD			
D8	94-150001	LM4148 GP JMMHELY DIODE SMD			
D9	94-150001	LM4148 GP JMMHELY DIODE SMD			
LED1	98-200008	GREEN LED SMD			
TR1	94-200007	80W71 NPN TRANSISTOR SMD			
TR2	94-200007	80W71 NPN TRANSISTOR SMD			
TR3	94-200010	F7751/755 PNP TRAM SMD			

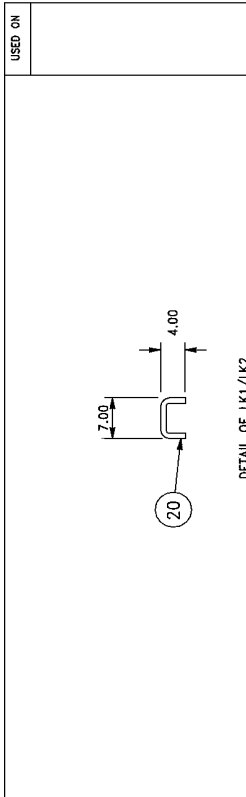

USED ON

12-002225

REPERITL FACILITIES LTD

NOTES:

- COMPONENTS SHOULD BE POSITIONED USING SILK SCREEN REFERENCES IN CONJUNCTION WITH COMPONENT LIST
- WHERE INDIVIDUAL ITEMS ARE NOT BALLOONED THE COMPONENT IS IDENTIFIED ON BOTH THE COMPONENT LIST AND THE DRAWING BY ITS COMPONENT REF. (SEE B.O.M FOR BALLOON IDENTIS)
- ALL SOLDERING TO BE COMPLETED USING ITEM (27) (HAND SOLDERING) OR ITEM (28) (MACHINE SOLDERING)
- USE WITH CIRCUIT DIAGRAM 12-002270

Aerial Facilities Ltd
England
Tel: (01494) 777000
Fax (01494) 777002

3 STAGE AMPLIFIER ALARM BOARD ASSEMBLY

SCALE: 2:1

THIS IS A PROPRIETARY DESIGN OF AERIAL FACILITIES LTD. PERMISSION IS GRANTED TO REPRODUCE THIS DRAWING FOR REFERENCE ONLY. IT IS EXPRESSLY AUTHORISED BY WRITING BY AERIAL FACILITIES LTD.

TOLERANCES UNLESS OTHERWISE SPECIFIED:
DIMENSIONS ARE IN mm
ONE DECIMAL PLACE ± 0.2mm
TWO DECIMAL PLACES ± 0.1mm

DATE: 14/6/94
DRAWN: MJB
CHECKED: CHD
APPD: GB
REVISIONS: DB

ISSUE: 2A

5.1.6.5 Generic Wall Enclosure Alarm Wiring Sketch

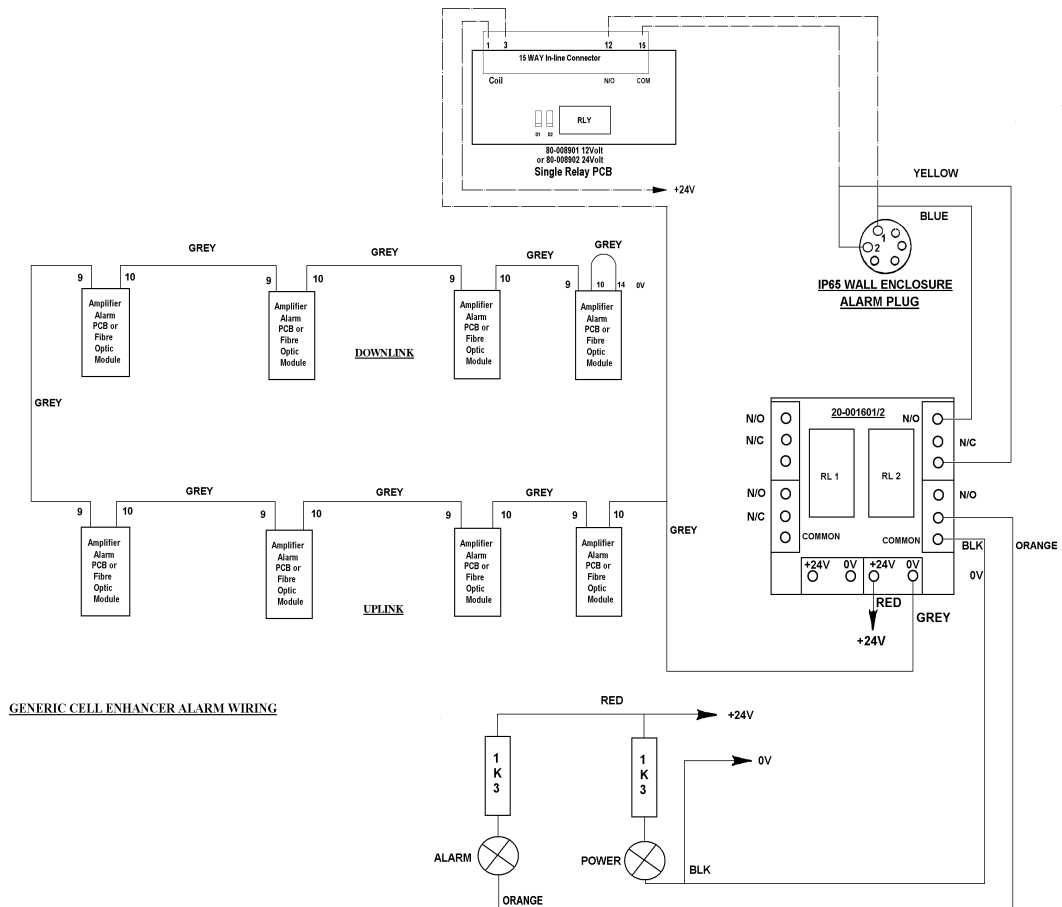

5.1.7 DC/DC Converter, 24V in, 12V 8A out (13-003011)

5.1.7.1 Description

The DC/DC converter fitted is an AFL assembled, high power PCB unit with an 8 amp @ 12V output capability. The circuit is basically an O.E.M semiconductor regulator (one side of which has a heatsink mounting plate, that is usually bolted to the casing of a Cell Enhancer) and smoothing components built onto a printed circuit board with screw block terminations.

Note: no circuit diagram of the O.E.M. regulator is available. This unit should not be repaired, only replaced.

5.1.7.2 Technical Specification

Input Voltage Range:		18-28V DC
Output Voltage:		12V±0.5V
Max. Current Load:		8.0Amps
Temperature Range:	Operation:	-10°C to +55°C
	Storage:	-40°C to +70°C
Size(PCB):		190 x 63mm
Weight (Loaded PCB):		291gms

5.1.8 Channel Selective & Channel Control Modules (17-003012 & 17-002101)

5.1.8.1 Channel Selective Module Description

The channel selectivity module is employed when the Cell Enhancer requirement dictates that very narrow bandwidths (single operating channels), must be selected from within the operating passband. One channel selectivity module is required for each channel.

The Channel Selectivity Module is an Up/Down frequency converter that mixes the incoming channel frequency with a synthesised local oscillator, so that it is down-converted to an Intermediate Frequency (IF) in the upper HF range. An eight pole crystal filter in the IF amplifier provides the required selectivity to define the operating passband of the Cell Enhancer to a single PMR channel. The same local oscillator then converts the selected IF signal back to the channel frequency.

Selectivity is obtained from a fixed bandwidth block filter operating at an intermediate frequency (IF) in the low VHF range. This filter may be internal to the channel selectivity module (Crystal or SAW filter) or an externally mounted bandpass filter, (LC or Helical Resonator). Various IF bandwidths can therefore be accommodated. A synthesized Local Oscillator is employed in conjunction with high performance frequency mixers, to translate between the signal frequency and IF.

The operating frequency of each channel selectivity module is set by the programming of channel selectivity module frequencies and is achieved digitally, via hard wired links, banks of DIP switches, or via an onboard RS232 control module, providing the ability to remotely set channel frequencies.

Automatic Level Control (ALC) is provided within each channel selectivity module such that the output level is held constant for high level input signals. This feature prevents saturation of the output mixer and of the associated amplifiers.

Alarms within the module inhibit the channel if the synthesised frequency is not locked. The synthesiser will not usually go out of lock unless a frequency far out of band is programmed.

The channel selectivity module is extremely complex and, with the exception of channel frequency programming within the design bandwidth, it cannot be adjusted or repaired without extensive laboratory facilities and the necessary specialised personnel. If a fault is suspected with any channel selectivity module it should be tested by substitution and the complete, suspect module should then be returned to AFL for investigation.

 Aerial Facilities Limited www.AerialFacilities.com Technical Literature	PBL UHF 1 & 2 Air Interface Maintenance Handbook		
	H/book Number:- 60-055900HBKM	Issue No:-1	Date:- 13/02/2003

5.1.8.2

Drg. No. 17-003080, Generic Channel Module Block Diagram

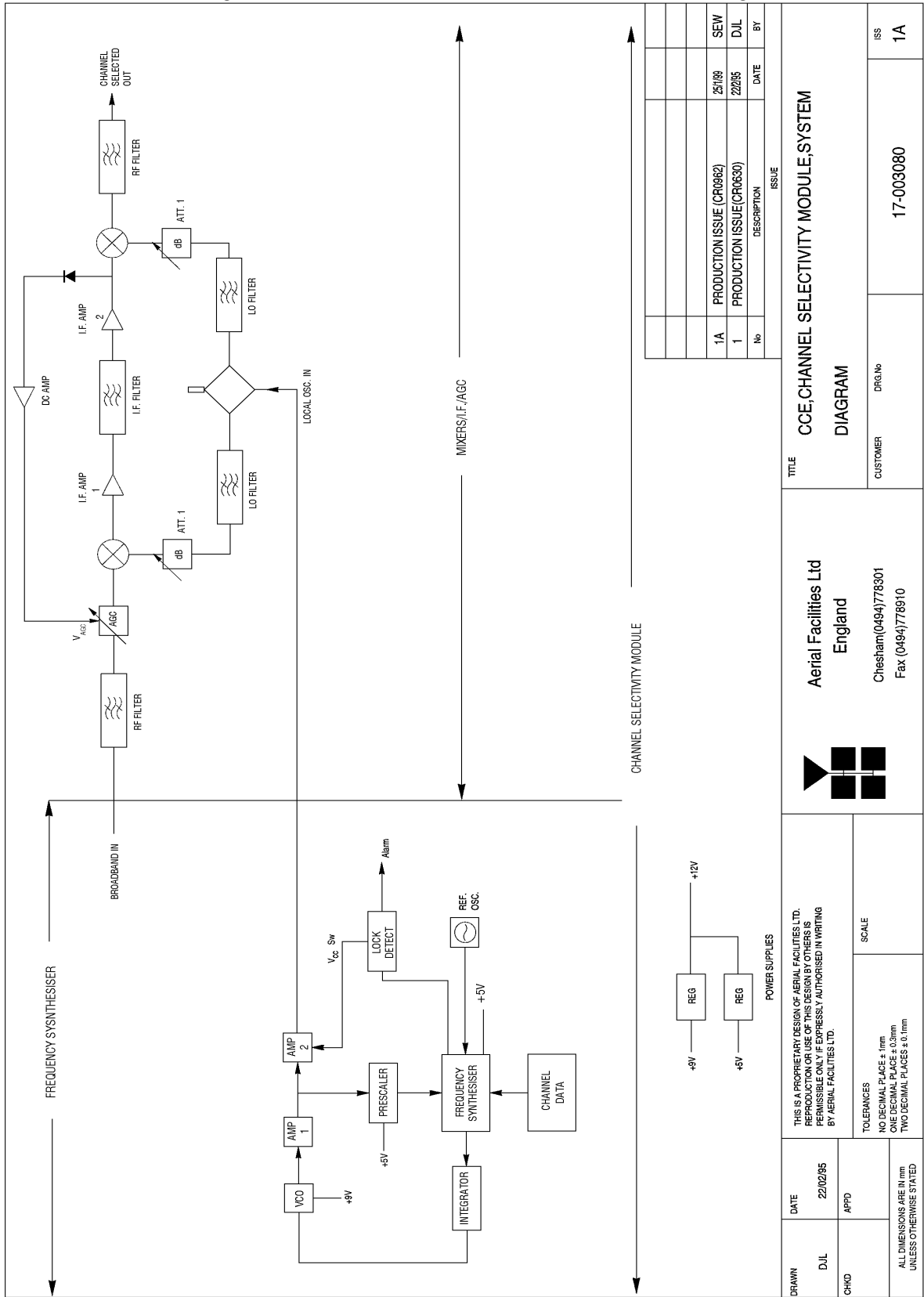

ISSUE		DATE	BY
1A	PRODUCTION ISSUE (CR0662)	25/09	SEW
1	PRODUCTION ISSUE (CR0630)	22/85	DJL
No			

TITLE
CCE, CHANNEL SELECTIVITY MODULE, SYSTEM
DIAGRAM

CUSTOMER
Aerial Facilities Ltd
England
Chesham(0494)778301
Fax (0494)778910

DRG.No
17-003080

ISS
1A

DATE 22/02/95	SCALE
APPD	SCALE
<p>THIS IS A PROPRIETARY DESIGN OF AERIAL FACILITIES LTD. REPRODUCTION IS STRICTLY PROHIBITED WITHOUT THE EXPRESS AUTHORITY IN WRITING BY AERIAL FACILITIES LTD.</p> <p>TOLERANCES NO DECIMAL PLACES = 1mm ONE DECIMAL PLACE = 0.2mm TWO DECIMAL PLACES = 0.1mm UNLESS OTHERWISE STATED</p>	

5.1.8.3 Channel Selectivity Control Module Description

The control module consists of a bank of four, in-line data switches each of which control one channel module frequency setting. One controller can therefore control four channel modules. The following list shows the frequencies available for each switch setting.

5.1.8.4 Channel Controller DIP Switch Configuration Frequencies

IDC PIN	25-way Connector	Function
1	13	Freq. bit 1 (12.5kHz)
2	25	Freq. bit 2 (25kHz)
3	12	Freq. bit 3 (50kHz)
4	24	Freq. bit 4 (100kHz)
5	11	Freq. bit 5 (200kHz)
6	23	Freq. bit 6 (400kHz)
7	10	Freq. bit 7 (800kHz)
8	22	Freq. bit 8 (1.6MHz)
9	9	Freq. bit 9 (3.2MHz)
10	21	Freq. bit 10 (6.4MHz)
11	8	Freq. bit 11 (12.8MHz)
12	20	Freq. bit 12 (25.6MHz)
13	7	Freq. bit 13 (51.2MHz)
14	19	Freq. bit 14 (102.4MHz)
15	6	Freq. bit 15 (204.8MHz)
16	18	Freq. bit 16 (409.6MHz)
17	5	Module alarm
18	17	Gain bit 1
19	4	Gain bit 2
20	16	Gain bit 3
21	3	Gain bit 4
22	15	+5V
23	2	0V
24	14	Switched 12V
25	1	0V
26	---	---

5.1.8.5 UHF1 Downlink Channel Module Configuration Table

Setting	D/L(1)	D/L(2)	D/L(3)
Frequency	482.2375MHz	470.2625MHz	470.2125MHz
Gain	15dB	20dB	20dB
ALC	-23dB	-23dB	-23dB
DIP (off) No.'s	1,2,13,16	1,3,7,11,12,16	1,7,11,12,16
B/W	15KHz	15KHz	15KHz

5.1.8.6 UHF1 Uplink Channel Module Configuration Table

Setting	U/L(1)	U/L(2)	U/L(3)
Frequency	473.2625MHz	470.2125MHz	485.2375MHz
Gain	5dB	5dB	15dB
ALC	-22dBm	-22dBm	-12dBm
DIP (off) No.'s	1,3,5,6,9,11,12,16	1,5,6,9,11,12,16	1,2,5,6,7,8,13,16
B/W	30KHz	30KHz	30KHz

5.1.8.7 UHF2 Downlink Channel Module Configuration Table

Setting	D/L(1)	D/L(2)	D/L(3)	D/L(4)
Frequency	483.3125MHz	483.2875MHz	483.0625MHz	483.5265MHz
Gain	20dB	20dB	20dB	20dB
ALC	-35dBm	-35dBm	-35dBm	-35dBm
DIP (off) No.'s	1,4,5,7,13,16	1,2,3,5,7,13,16	1,3,7,13,16	1,3,4,6,7,13,16
B/W	15KHz	15KHz	15KHz	15KHz

5.1.8.8 UHF2 Uplink Channel Module Configuration Table

Setting	D/L(1)	D/L(2)	D/L(3)	D/L(4)
Frequency	486.3125MHz	486.2875MHz	486.0625MHz	486.5265MHz
Gain	6dB	6dB	6dB	6dB
ALC	-20dBm	-20dBm	-20dBm	-20dBm
DIP (off) No.'s	1,4,7,9,13,16	1,2,3,7,9,13,16	1,3,5,6,9,13,16	1,3,4,5,7,9,13,16
B/W	15KHz	15KHz	15KHz	15KHz

5.1.9 Single & Dual 24Volt Relay Boards (20-001602 & 80-008902)

5.1.9.1 24V Relay Boards (20-001602 & 80-008902) Description

The General Purpose Dual Relay Board (20-001602) allows the inversion of signals and the isolation of circuits. It is equipped with two dual pole change-over relays RL1 and RL2, with completely isolated wiring, accessed via screw terminals.

Both relays are provided with polarity protection diodes and diodes for suppressing the transients caused by "flywheel effect" which can destroy switching transistors or induce spikes on neighbouring circuits. It's common use is to amalgamate all the alarm signals into one, volts-free relay contact pair for the main alarm system.

Note that the board is available for different voltages (12 or 24V) depending on the type of relays fitted at RL1 and RL2.

The single relay board (80-008902) is electrically identical to the dual version but is proportionately smaller in size. It also has a single in-line IDC connector in place of the screw terminal blocks of the dual model and performs similar summary alarm functions.

 Aerial Facilities Limited www.AerialFacilities.com Technical Literature	PBL UHF 1 & 2 Air Interface Maintenance Handbook		
	H/book Number:- 60-055900HBKM	Issue No:-1	Date:- 13/02/2003

5.1.9.2 Drg. No. 20-001602, Dual 24V Relay Board Assembly Drawing

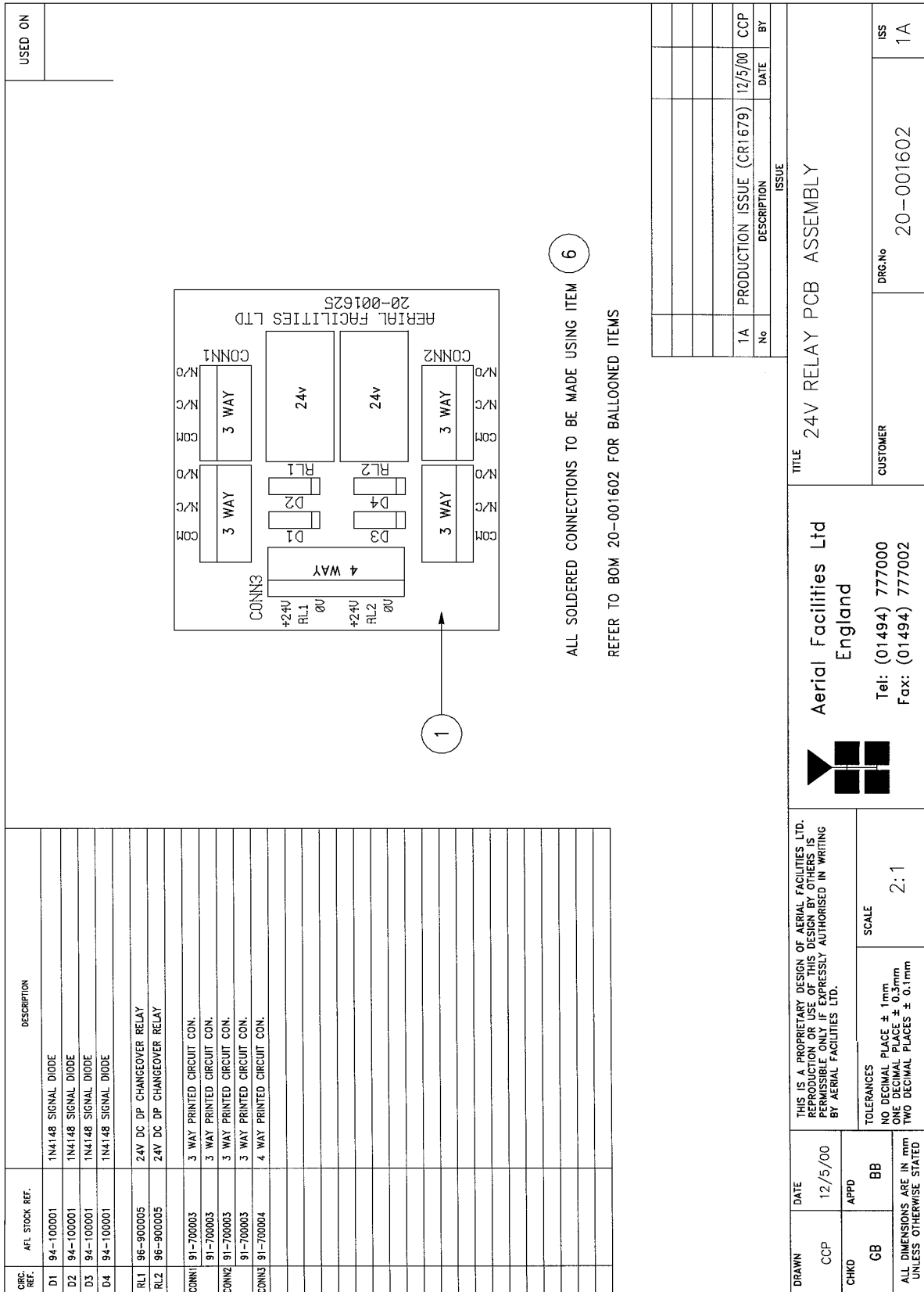

6

ALL SOLDERED CONNECTIONS TO BE MADE USING ITEM

REFER TO BOM 20-001602 FOR BALLOONED ITEMS

DRAWN		DATE	TITLE	
CCP	12/5/00	24V RELAY PCB ASSEMBLY		ISS
CHKD	APPD	BB	CUSTOMER	1A
ALL DIMENSIONS ARE IN mm UNLESS OTHERWISE STATED		Aerial Facilities Ltd England		DRG.No
TOLERANCES		Tel: (01494) 777000		20-001602
NO DECIMAL PLACE ± 1mm		Fax: (01494) 777002		ISS
ONE DECIMAL PLACE ± 0.5mm		SCALE		1A
TWO DECIMAL PLACES ± 0.1mm		2:1		
THIS IS A PROPRIETARY DESIGN OF AERIAL FACILITIES LTD. REPRODUCTION OR USE OF THIS DESIGN BY OTHERS IS PERMISSIBLE ONLY IF EXPRESSLY AUTHORISED IN WRITING BY AERIAL FACILITIES LTD.				
No		DESCRIPTION	DATE	BY
1A	PRODUCTION ISSUE (CR1679)	12/5/00	CCP	

5.1.9.3 Drg. No. 20-001671, Dual 24V Relay Board Circuit Diagram

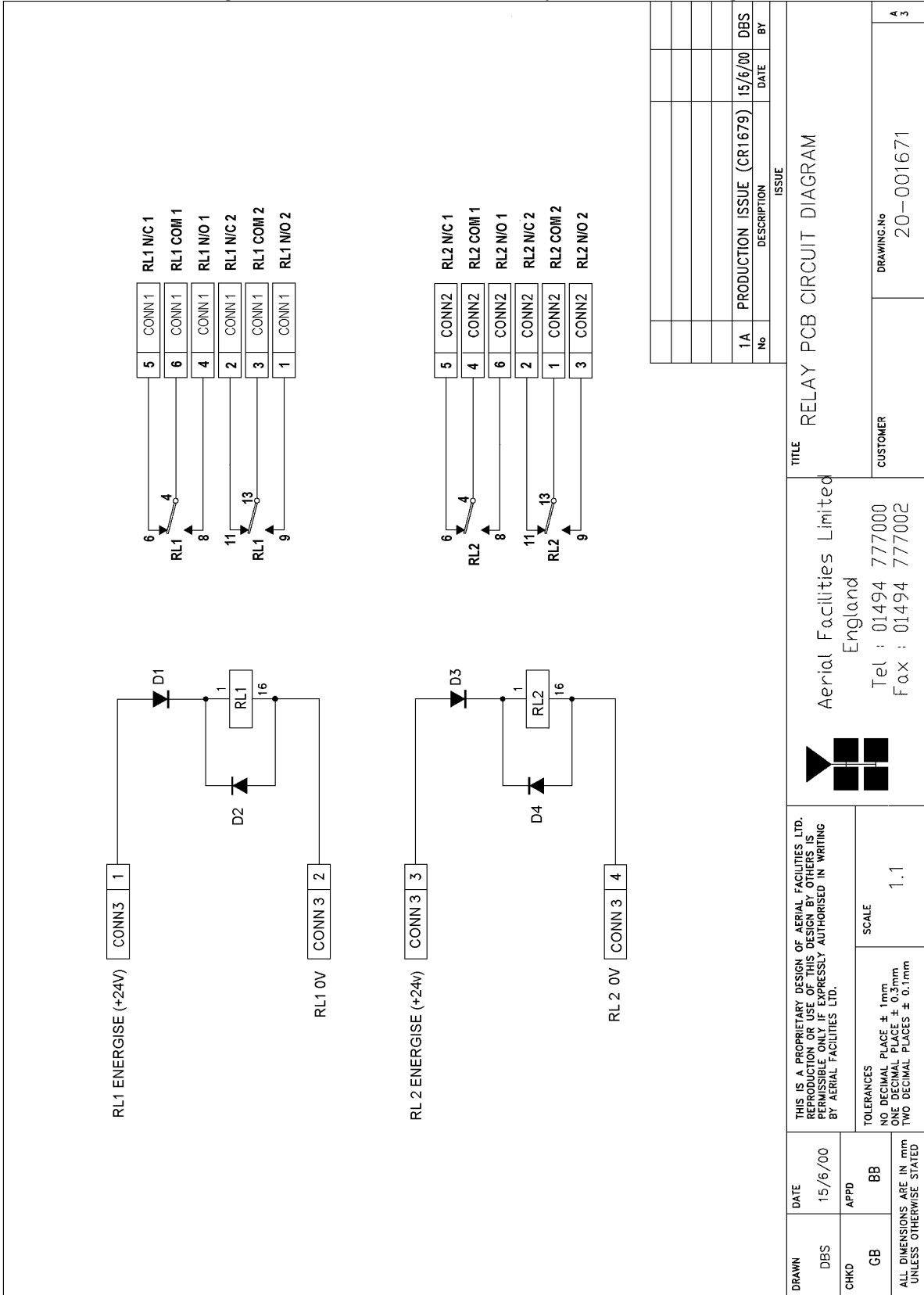

No	DESCRIPTION	DATE	BY
1A	PRODUCTION ISSUE (CR1679)	15/6/00	DBS

TITLE RELAY PCB CIRCUIT DIAGRAM	
CUSTOMER Aerial Facilities Limited England Tel : 01494 777000 F.o.x : 01494 777002	DRAWING.No 20-001671

THIS IS A PROPRIETARY DESIGN OF AERIAL FACILITIES LTD. REPRODUCTION OR USE OF THIS DESIGN BY OTHERS IS PERMISSIBLE ONLY IF EXPRESSLY AUTHORISED IN WRITING BY AERIAL FACILITIES LTD.	SCALE 1.1
TOLERANCES NO DECIMAL PLACES ± 1mm ONE DECIMAL PLACE ± 0.5mm TWO DECIMAL PLACES ± 0.1mm	
DRAWN DATE DBS 15/6/00	APPD BB
CHKO GB	ALL DIMENSIONS ARE IN mm UNLESS OTHERWISE STATED

5.1.9.4 Drg. No. 80-008970, Single Relay Board Circuit Diagram

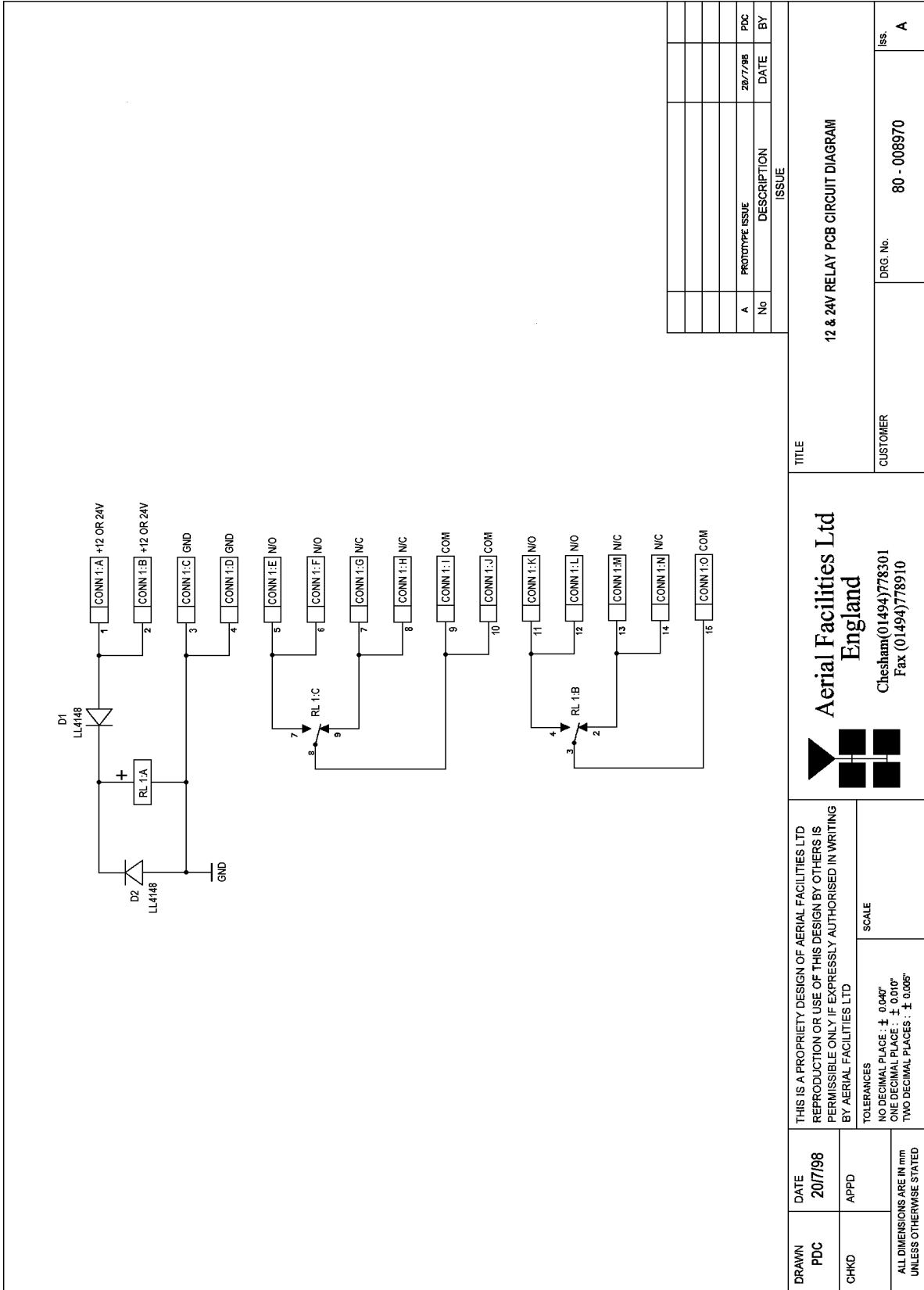

No	PROTOTYPE ISSUE	DATE	BY
A	28/7/98		PDC

ISSUE	
DESCRIPTION	DATE

TITLE	
12 & 24V RELAY PCB CIRCUIT DIAGRAM	
CUSTOMER	DRG. No. 80 - 008970
	ISS. A

Aerial Facilities Ltd
England
 Chesham(01494)778301
 Fax (01494)778910

DRAWN PDC	DATE 20/7/98	THIS IS A PROPRIETY DESIGN OF AERIAL FACILITIES LTD REPRODUCTION OR USE OF THIS DESIGN BY OTHERS IS PERMISSIBLE ONLY IF EXPRESSLY AUTHORISED IN WRITING BY AERIAL FACILITIES LTD	SCALE
CHKD	APPD		
ALL DIMENSIONS ARE IN mm UNLESS OTHERWISE STATED		TOLERANCES	NO DECIMAL PLACES - ± 0.040" ONE DECIMAL PLACE - ± 0.010" TWO DECIMAL PLACES - ± 0.005"

5.1.10. SMA coaxial termination (93-930003)

5.1.10.1 Description

When a combiner system is used to split or combine RF signals, in many cases it is most cost effective to use a standard stock item 4, 6 or 8 port device where, in fact, only a 3 - 6 port device is needed. In this case the splitter/combiner module has one of its ports terminated (both uplink & downlink) with an appropriate load in order to preserve the correct impedance of the device over the specified frequency range. This has the advantage of allowing future expansion capability should extra channels or other functions become necessary. Terminations are available for every type of RF connector that may be used, N type, 7/16th or SMA, in this case SMA.

5.1.11. 24V 400W Flat-Pack Power Supply (96-300011)

5.1.11.1 Description

The power supply unit is a switched-mode type capable of supplying 24V DC at 16.0Amps continuously. Equipment of this type typically requires approximately 10.0 Amps at 24V DC, so the PSU will be used conservatively ensuring a long operational lifetime.

No routine maintenance of the PSU is required. If a fault is suspected, then the output voltage from the power supply may be measured on its output terminals. This is typically set to 24.5V.

All the PSU's used in AFL Cell Enhancers are capable of operation from either 110 or 220V nominal AC supplies. The line voltage is sensed automatically, so no adjustment or link setting is needed by the operator. No drawings of the PSU are available.

5.1.11.2 Technical Specification

AC Input Supply:		
Voltage:	110 or 220V nominal - 90 to 132 or 180 to 264V (single phase, absolute limits)	
Frequency:	47 to 63Hz	
DC Output Supply:		
Voltage:	24V DC (nominal), 22 to 26V (absolute limits)	
Current:	16.0A	
Temperature range:	operational:	-10 BC to +55 BC
	storage:	-40 BC to +70 BC

5.2 UHF 2 Air Interface (60-055902)

5.2.1 Bandpass Filter (02-013401) See section 5.1.1

5.2.2 4 Port Tx Hybrid Combiner (05-003019)

5.2.2.1 Description

The 3dB Hybrid Combiner used is a device for accurately matching two or more RF signals to single or multiple ports, whilst maintaining an accurate 50Ω load to all inputs/outputs and ensuring that the VSWR and insertion losses are kept to a minimum. Any unused ports will be terminated with an appropriate 50Ω load. In UHF 2 this hybrid is used to combine the signals from the channel selective modules (from both UHF 1 & 2) in the downlink direction for onward transmission by fibre, and similar signals for both UHF 1 & 2 are combined before being further split into the uplink channel modules.

5.2.2.2 Technical Specification

Frequency Range:	$f_o \pm 10\%$ (50 – 500 MHz)	
Bandwidth:	$f_o \pm 10\%$	
Inputs:	2	
Outputs:	2	
Insertion Loss:	<3.5 dB	
Isolation between Input or Output ports:	>27 dB	
Return Loss (VSWR) – Input:	1.3:1	
Return Loss (VSWR) – Output:	1.3:1	
Impedance:	50 ?	
Temperature Range	operation:	-10°C to +55°C
	storage:	-20°C to +70°C
MTBF:	>180,000 hours	
Power Rating – Splitter:	Up to 150 Watts (load dependant)	
Power Rating – Combiner:	Available up to 100 Watts	
Environmental:	IP54	
Connectors:	‘N’ female	
Dimensions:	118 x 102 x 35 mm (including connectors)	
Weight:	0.5 kg	

5.2.3 Four Way Low Power Splitter (05-003401) See section 5.1.2

5.2.4 ¼Watt 0- -30dB Switched Attenuator (10-000701) See section 5.1.3

5.2.5 Low Noise Amplifiers (11-007302 & 11-007402) See section 5.1.4

5.2.6 3 Stage Amplifier Alarm Boards (12-002201) See section 5.1.6

5.2.7 20Watt Power Amplifier (12-004201)

5.2.7.1 Description

The power amplifiers fitted to this unit are multi-stage, solid state power amplifiers. Class A circuitry is employed throughout the units to ensure excellent linearity over a wide dynamic frequency range. All the semi-conductor devices are very conservatively rated to ensure low device junction temperatures and a long, trouble free working lifetime.

The power amplifiers should require no maintenance over their operating lives. Under no circumstances should the cover be removed or the side adjustments disturbed unless it is certain that an amplifier has failed; since they are critically aligned during manufacture and any re-alignment will require extensive test equipment.

5.2.7.2 Technical Specification

Frequency Range:	350 – 550MHz (tuned to spec.)
Bandwidth:	20MHz (tuned to spec.)
Maximum Output Power:	>20W
Gain:	30dB
1dB Compression Point:	<+43dBm
3rd Order Intercept Point:	<+54dBm
VSWR:	better than 1.45:1
Connectors:	SMA female
Supply:	3.50A @ 24V DC
Size:	276 x 78 x 40mm (ex. connectors & heatsink)
Weight:	1.5 kg (approximately, excluding heatsink)
Temperature range:	operational: -10°C to +55°C
	storage: -40°C to +70°C

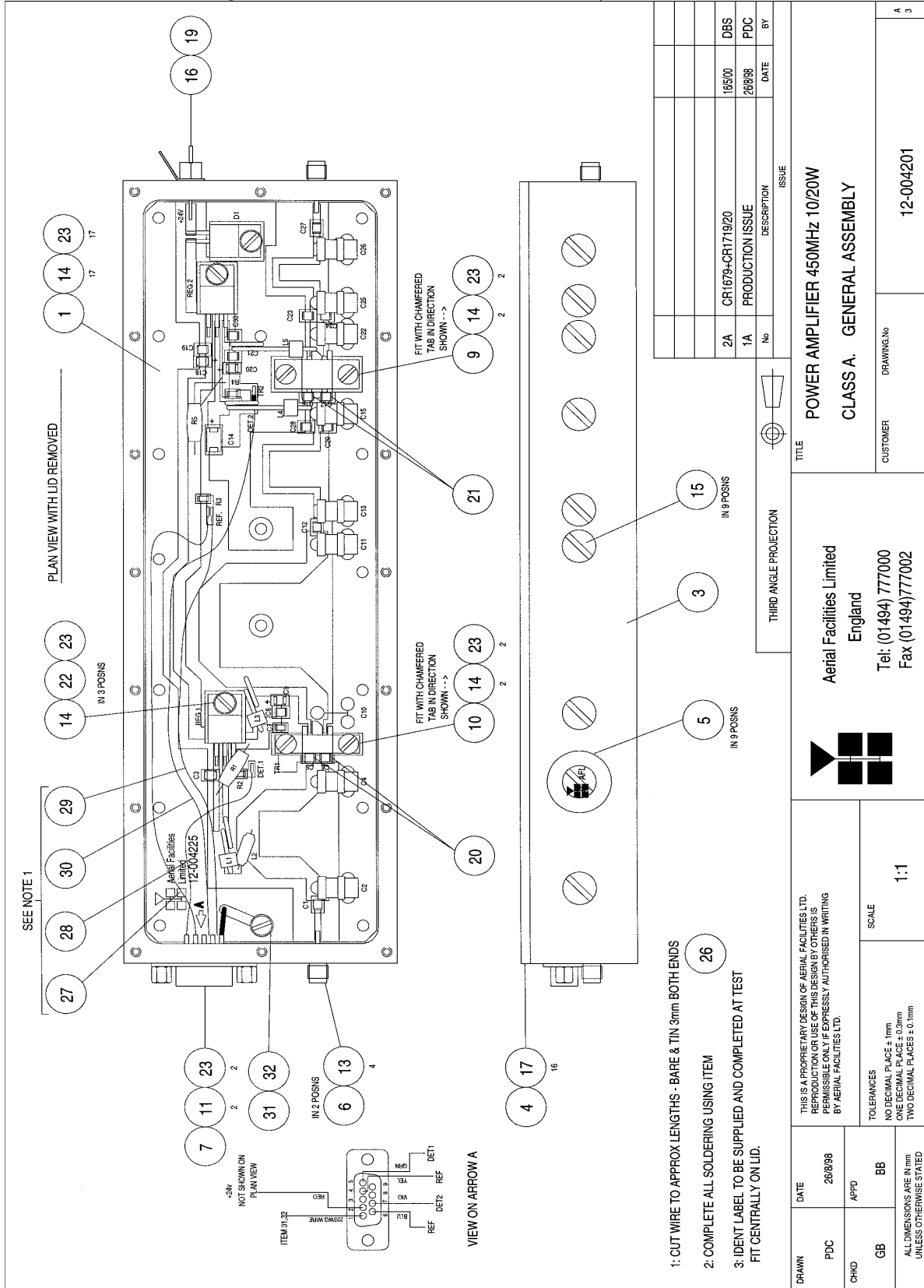

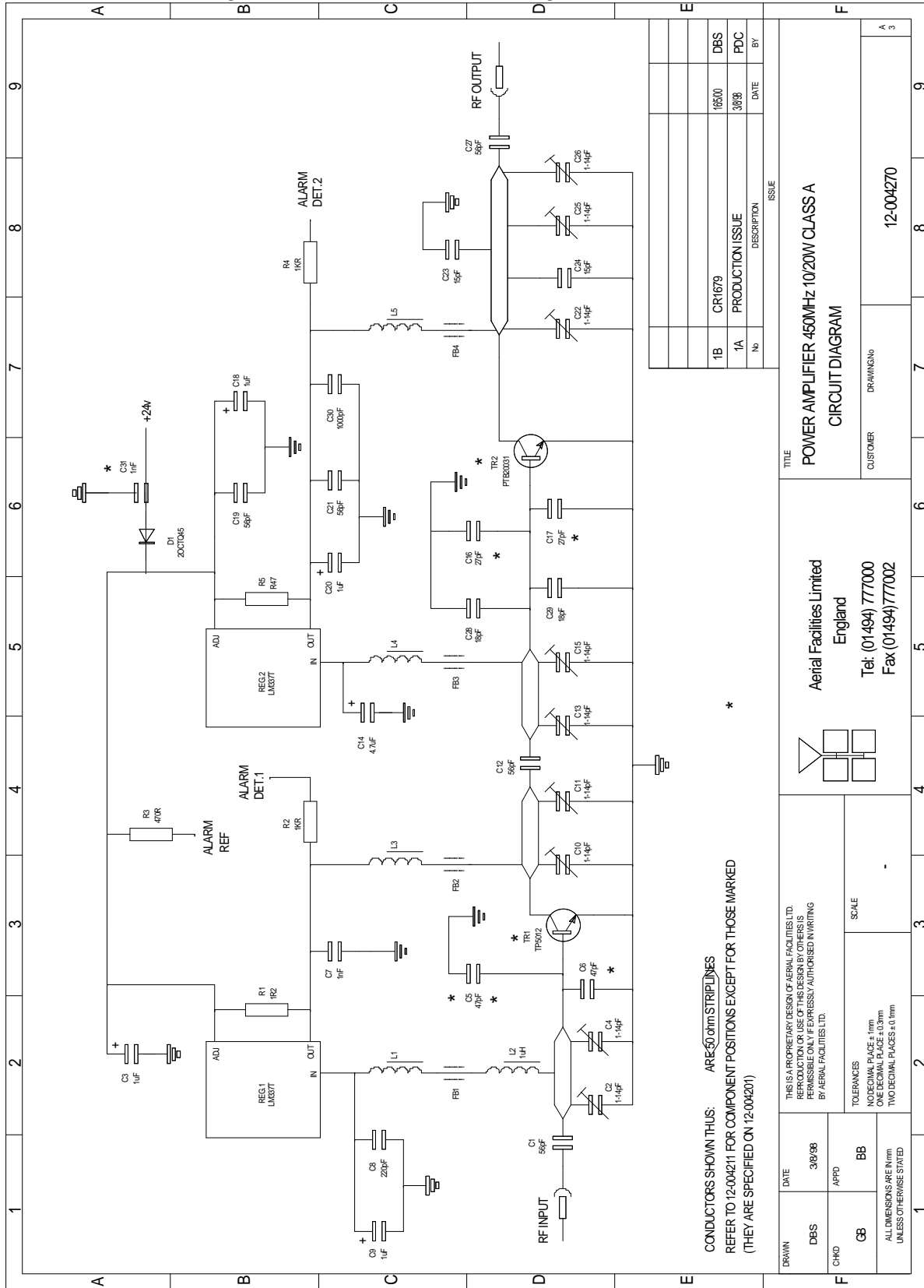

5.2.7.4 Drg. No. 12-004270, PA Circuit Diagram



CONDUCTORS SHOWN THUS: ARE 50.0mm STRIPLINES
 REFER TO 12-004211 FOR COMPONENT POSITIONS EXCEPT FOR THOSE MARKED
 (THEY ARE SPECIFIED ON 12-004201)

DATE	3/9/98	SCALE	
DRAWN	DBS	APPD	BB
CHKD	GB	ALL DIMENSIONS ARE IN mm UNLESS OTHERWISE STATED	
TOLERANCES		NO DECIMAL PLACE = 1mm ONE DECIMAL PLACE = 0.3mm TWO DECIMAL PLACES = 0.1mm	
THIS IS A PROPRIETARY DESIGN OF AERIAL FACILITIES LTD. REPRODUCTION OR USE OF THIS DESIGN BY OTHERS IS PERMISSIBLE ONLY IF EXPRESSLY AUTHORISED IN WRITING BY AERIAL FACILITIES LTD.			
Aerial Facilities Limited England		Tel: (01494) 777000 Fax: (01494) 777002	
TITLE		POWER AMPLIFIER 450MHz 10/20W CLASS A	
CUSTOMER		DRAWING No	
No		DESCRIPTION	
1B		CR1679	
1A		PRODUCTION ISSUE	
No		DATE	
		BY	
		DBS	
		3/9/98	
		PDC	
		DATE	
		BY	
		12-004270	

5.2.7.5 Drg. No. 12-004270C1, PA Parts List(1)

1	2		3			4			5																																																		
CIRC. REF.	AFL STOCK REF.		DESCRIPTION																																																								
A	C1	93-200006	56pF CHIP CAP 10% TOL.(MIN)									A																																															
	C2	93-130023	PCB MOUNT AIR TRIMMER 1-14pF																																																								
	C3	93-240003	1uF TANTALUM CHIP CAP 35V																																																								
	C4	93-130023	PCB MOUNT AIR TRIMMER 1-14pF																																																								
B	C5	REFER TO GA 12-004201 FOR DETAILS										B																																															
	C6	REFER TO GA 12-004201 FOR DETAILS																																																									
	C7	93-200020	1nF CHIP CAP 63V 10%																																																								
	C8	93-200014	220pF CHIP CAP 10% TOL (MIN)																																																								
	C9	93-240004	1uF TANTALUM CHIP CAP 35V																																																								
	C10	NOT FITTED		NOT FITTED																																																							
C	C11	93-130023	PCB MOUNT AIR TRIMMER 1-14pF									C																																															
	C12	93-200006	56pF CHIP CAP 10% TOL.(MIN)																																																								
	C13	93-130023	PCB MOUNT AIR TRIMMER 1-14pF																																																								
	C14	93-240006	4.7uF TANTALUM CHIP CAP 35V																																																								
	C15	93-130023	PCB MOUNT AIR TRIMMER 1-14pF																																																								
	C16	REFER TO GA 12-004201 FOR DETAILS																																																									
	C17	REFER TO GA 12-004201 FOR DETAILS																																																									
D	C18	93-240003	1uF TANTALUM CHIP CAP 35V									D																																															
	C19	93-200006	56pF CHIP CAP 10% TOL.(MIN)																																																								
	C20	93-240004	1uF TANTALUM CHIP CAP 35V																																																								
	C21	93-200006	56pF CHIP CAP 10% TOL.(MIN)																																																								
	C22	93-130023	PCB MOUNT AIR TRIMMER 1-14pF																																																								
	C23	93-200005	15pF CHIP CAP 10% TOL.(MIN)																																																								
E	C24	93-200005	15pF CHIP CAP 10% TOL.(MIN)									E																																															
	C25	93-130023	PCB MOUNT AIR TRIMMER 1-14pF																																																								
	C26	93-130023	PCB MOUNT AIR TRIMMER 1-14pF																																																								
	C27	93-200006	56pF CHIP CAP 10% TOL.(MIN)																																																								
	C28	93-200004	18pF CHIP CAP 10% TOL.(MIN)																																																								
	C29	93-200004	18pF CHIP CAP 10% TOL.(MIN)																																																								
F	C30	93-200016	1000pF (1nF) CHIP CAP 10% TOL.(MIN)									F																																															
	C31	REFER TO GA 12-004201 FOR DETAILS																																																									
<table border="1"> <tr> <td>2A</td> <td>5/5/00</td> <td>CR1679</td> <td></td> <td></td> <td></td> <td></td> <td></td> <td></td> <td></td> <td></td> <td></td> </tr> <tr> <td>1A</td> <td>5/8/98</td> <td>PROD. ISS.</td> <td></td> <td></td> <td></td> <td></td> <td></td> <td></td> <td></td> <td></td> <td></td> </tr> </table>												2A	5/5/00	CR1679										1A	5/8/98	PROD. ISS.																																	
2A	5/5/00	CR1679																																																									
1A	5/8/98	PROD. ISS.																																																									
<table border="1"> <thead> <tr> <th>ISSUE</th> <th>DATE</th> <th>CHANGE No</th> <th>ISSUE</th> <th>DATE</th> <th>CHANGE No</th> <th>ISSUE</th> <th>DATE</th> <th>CHANGE No</th> <th>ISSUE</th> <th>DATE</th> <th>CHANGE No</th> </tr> </thead> <tbody> <tr> <td colspan="6">  Aerial Facilities Limited </td> <td colspan="6"> TITLE POWER AMPLIFIER,450MHz,10/20W CIRCUIT COMPONENT LIST </td> </tr> <tr> <td>DRAWN</td> <td>DATE</td> <td>CHKD</td> <td>APPD</td> <td colspan="4">CUSTOMER</td> <td colspan="4">COMPONENT LIST FOR</td> </tr> <tr> <td>PDC</td> <td>5/8/98</td> <td>GB</td> <td>BB</td> <td colspan="4"></td> <td colspan="4">12-004270C1</td> </tr> </tbody> </table>												ISSUE	DATE	CHANGE No	ISSUE	DATE	CHANGE No	ISSUE	DATE	CHANGE No	ISSUE	DATE	CHANGE No	 Aerial Facilities Limited						TITLE POWER AMPLIFIER,450MHz,10/20W CIRCUIT COMPONENT LIST						DRAWN	DATE	CHKD	APPD	CUSTOMER				COMPONENT LIST FOR				PDC	5/8/98	GB	BB					12-004270C1			
ISSUE	DATE	CHANGE No	ISSUE	DATE	CHANGE No	ISSUE	DATE	CHANGE No	ISSUE	DATE	CHANGE No																																																
 Aerial Facilities Limited						TITLE POWER AMPLIFIER,450MHz,10/20W CIRCUIT COMPONENT LIST																																																					
DRAWN	DATE	CHKD	APPD	CUSTOMER				COMPONENT LIST FOR																																																			
PDC	5/8/98	GB	BB					12-004270C1																																																			
1	2		3			4			5																																																		

5.2.7.6 Drg. No. 12-004270C2. PA Parts List(2)

1	2		3			4			5			
CIRC. REF.	AFL STOCK REF.		DESCRIPTION									
A	TR1	REFER TO GA 12-004201 FOR DETAILS										A
	TR2	REFER TO GA 12-004201 FOR DETAILS										
	REG1	94-300002	LM337T, VOLTAGE REGULATOR									
	REG2	94-300002	LM337T, VOLTAGE REGULATOR									
B	D1	94-120006	20TQ45 45V DUAL SCHOTTKY DIODE									B
	R1	93-540075	1R2 2.5W RESISTOR									
	R2	93-630037	1KR CHIP RESISTOR									
	R3	93-630032	470R CHIP RESISTOR									
	R4	93-630037	1KR CHIP RESISTOR									
C	R5	93-540083	47R 6W RESISTOR									C
	L1	90-500012	1.25 ENAMELLED COPPER WIRE									
		93-910001	FERRITE BEAD									
	L2	93-400004	1.0uH CHOKE SIGMA SC10 SERIES									
D	L3	90-500012	1.25 ENAMELLED COPPER WIRE									D
		93-910001	FERRITE BEAD									
	L4	90-500012	1.25 ENAMELLED COPPER WIRE									
		93-910001	FERRITE BEAD									
	L5	90-500012	1.25 ENAMELLED COPPER WIRE									
		93-910001	FERRITE BEAD									
E												E
F												F
	2A	5/5/00	CR1679									
	1A	5/8/98	PROD. ISS.									
	ISSUE	DATE	CHANGE No	ISSUE	DATE	CHANGE No	ISSUE	DATE	CHANGE No	ISSUE	DATE	CHANGE No
G	 Aerial Facilities Limited					TITLE POWER AMPLIFIER,450MHZ,10\20W CIRCUIT COMPONENT LIST						G
	DRAWN PDC	DATE 5/8/98	CHKD GB	APPD BB	CUSTOMER	COMPONENT LIST FOR 12-004270C2						

5.2.7.7 Drg. No. 12-003670, PA to Alarm Wiring Details

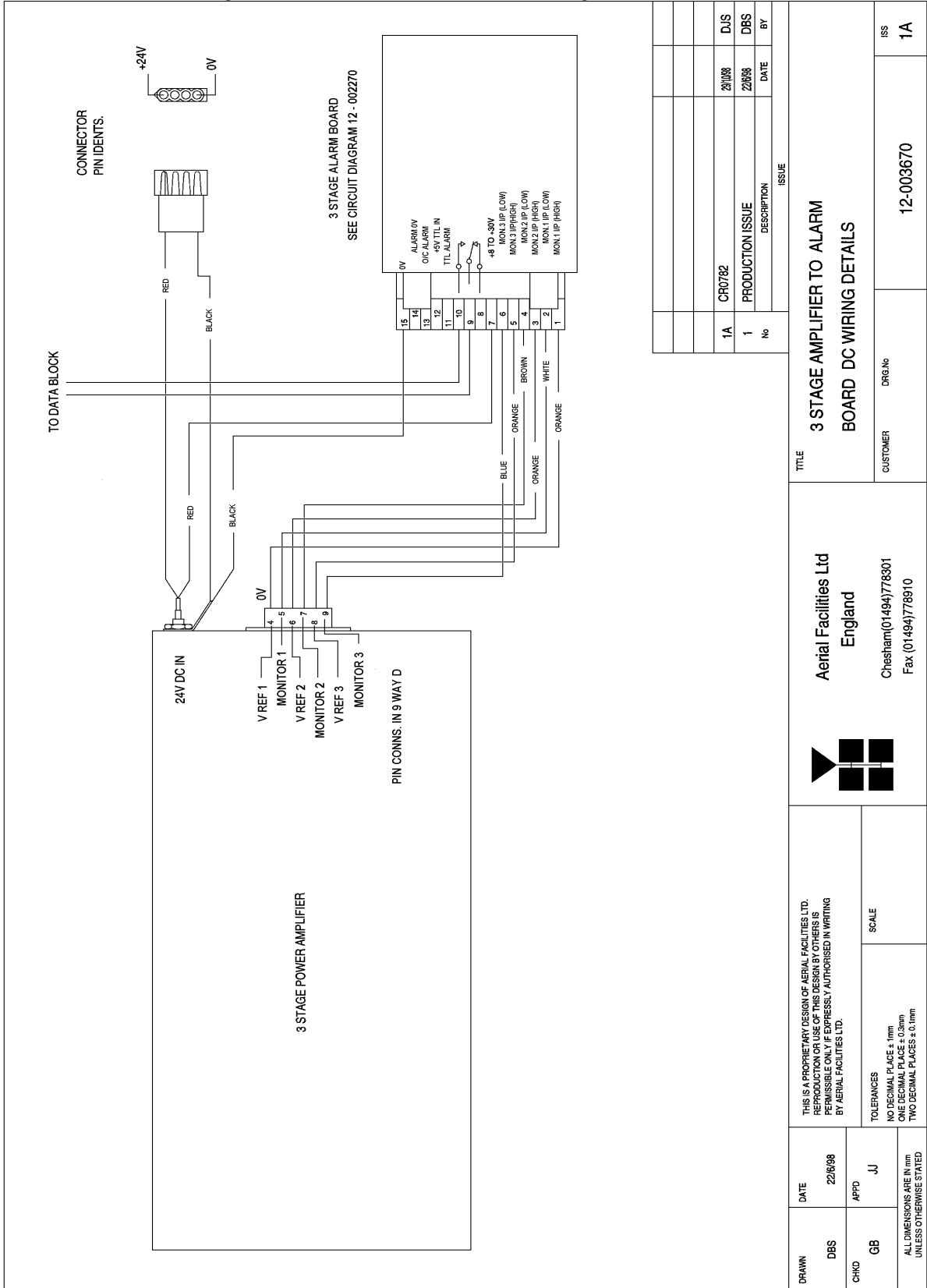

5.2.8 DC/DC Converter, 24V in, 12V 8A out (13-003011) See section 5.1.7

5.2.9 Chan. Selec. & Chan. Contr. Mdls (17-003012 & 17-002101) See section 5.1.8

5.2.10 21MHz IF Filter Board (17-002502)

5.2.10.1 Description

The above channel selective modules are fitted with a 21MHz filter board to narrow the channel bandwidth from 30kHz to 15kHz.

5.2.11 Single & Dual 24Volt Relay Boards (20-001602 & 80-008902) See section 5.1.9

5.2.12 SMA Coaxial Termination (93-930003) See section 5.1.10

5.2.13 24V 400W Flat-Pack Power Supply (96-300011) See section 5.1.11

5.2.14 JWS75-15/A PSU (96-300045)

5.2.14.1 Description

The power supply unit is a switched-mode type capable of supplying 24V DC at 6.25Amps continuously. This PSU is used to provide power for the fibre optic modules which will typically require approximately 3.0 Amps at 24V DC, so the PSU will be used conservatively ensuring a long operational lifetime.

No routine maintenance of the PSU is required. If a fault is suspected, then the output voltage from the power supply may be measured on its output terminals. This is typically set to 24.5V.

All the PSU's used in AFL Cell Enhancers are capable of operation from either 110 or 220V nominal AC supplies. The line voltage is sensed automatically, so no adjustment or link setting is needed by the operator.

5.2.14.2 Technical Specification

AC Input Supply:	
Voltage:	110 or 220V nominal
	90 to 132 or 180 to 264V (absolute limits)
Frequency:	47 to 63Hz
DC Output Supply:	
Voltage:	24V DC (nominal)
	22 to 26V (absolute limits)
Current:	6.25A

5.2.15. Single Mode Optical Coupler (98-100001)

5.2.15.1 Description

Single or dual optical couplers are used whenever it is required to split optical signals for transmission to more than one destination or combine them to a single common input. The couplers are O.E.M devices and are not considered repairable. Any suspected faulty coupler should be replaced.

5.2.16. Fibre Optic Receiver & Transmitter (98-200003 & 98-300003)

5.2.16.1 Description

The F/O units consist of a receiver & transmitter, which modulates the RF signal onto a laser carrier and transmits it via fibre/optic cable to a receiver unit some distance away where it is demodulated back to the original RF signal with very small values of accrued attenuation. Both transmitter and receiver modules have their own dedicated alarm outputs (volt-free relay contacts) which are integrated into the main alarm system. Being O.E.M devices, no drawings or circuit diagrams are available.

Caution: The FO units are NOT weather proof.

 Aerial Facilities Limited www.AerialFacilities.com Technical Literature	PBL UHF 1 & 2 Air Interface Maintenance Handbook		
	H/book Number:- 60-055900HBKM	Issue No:-1	Date:- 13/02/2003

5.2.16.2 Technical Specification

Power Consumption:	Tx:	120mA @ 15V DC (320mA @ -10BC)
	Rx:	330mA @ 15V DC
Frequency Range:		0.1 – 2.2GHz
Link noise figure:		40dB (typical)
Link noise figure (max.):		<45dB
Total link gain:		0dB
CNR @ 5 Km link length:	@30KHz B/W:	>84dB
	@200KHz B/W:	>76dB
	@1.2MHz B/W:	>69dB
RF total input power:		0dBm
Input IP3:		26dBm
Optical budget:		2 – 9.0dB
Max. link length:		20Km
Response Flatness:		<±1.0 dB
Optical Output Power (Tx):		2.4 – 4.0mW
Optical Wavelength:		1310±10nm
Fibre loss:		0.38dB/Km
Optical return loss:		-60dB
Optical Connector loss:		0.5dB per mated pair

Rx 'D' Type Female Connector

Pin No.	Signal Description
1	+15V DC Power
2	Optional Data Output
3	Power Ground
4	RF Signal Strength Monitor
5	Optical Power Monitor
6	O.C. Alarm
7	Optional Data Output
8	Relay Alarm Contact 1
9	Relay Alarm Contact 2

Tx 'D' Type Female Connector

Pin No.	Signal Description
1	+15V DC Power
2	Optional Data Input
3	Power Ground
4	RF Signal Strength Monitor
5	Laser Photodiode Current Monitor
6	Laser Current Monitor
7	Optional Data Input
8	Relay Alarm Contact 1
9	Relay Alarm Contact 2

 <p>Aerial Facilities Limited www.AerialFacilities.com Technical Literature</p>	<p>PBL UHF 1 & 2 Air Interface Maintenance Handbook</p>		
H/book Number:- 60-055900HBKM	Issue No:-1	Date:- 13/02/2003	Page:-71 of 71

 <p>Aerial Facilities Limited www.AerialFacilities.com Technical Literature</p>	<p>PBL UHF 1 & 2 Air Interface Maintenance Handbook</p>		
H/book Number:- 60-055900HBKM	Issue No:-1	Date:- 13/02/2003	Page:-72 of 72

 <p>Aerial Facilities Limited www.AerialFacilities.com Technical Literature</p>	<p>PBL UHF 1 & 2 Air Interface Maintenance Handbook</p>		
H/book Number:- 60-055900HBKM	Issue No:-1	Date:- 13/02/2003	Page:-73 of 73

6. INSTALLATION

6.1 Initial Installation Record

When this equipment is initially commissioned, please use the equipment set-up record sheet in Appendix A. This will help both the installation personnel and AFL should these figures be needed for future reference or diagnosis.

6.2 General

The size and weight of the wall units mean that they represent a significant health hazard unless they are mechanically installed in the correct manner. In the interests of safety this should be done before any electrical, RF, or optical connections are made.

It is important in determining the location of the wall units that space is allowed for access to the front and underneath of the equipment. To enable maintenance to be carried out, the door must be able to fully open. The location must be served with a duct to allow the entry of cables into the unit.

6.3 Electrical Connections

The mains power supply and the alarms are connected through an IP65 connector which should need no further attention once connected. It is recommended that the AC power connection is approved by a qualified electrician, who must satisfy himself that the supply will be the correct voltage and of sufficient capacity.

All electrical and RF connection should be completed and checked prior to power being applied for the first time.

6.4 Optical Connections

The optical input and output ports are be located on a bracket fixed to the lower inside of the case. The optical fibres from the tunnels enter through a cable gland on the case underside. The ports are supplied with a green plastic cover, which must be removed prior to the connection of the fibre cable. Ensure that transmitter and receiver fibre cable are identified to prevent misconnection. At the master site, the fibre transmitters are in the downlink path with the receivers in the uplink. At the remote sites the fibre transmitters are in the uplink with the receivers in the downlink. Where some of the fibre optic transmitter outputs are split with optical couplers to provide a connection to more than one remote site, care must be taken to ensure that the correct connections are made.

Ensure that connections are kept clean and are fully tightened.

 Aerial Facilities Limited www.AerialFacilities.com Technical Literature	PBL UHF 1 & 2 Air Interface Maintenance Handbook		
	H/book Number:- 60-055900HBKM	Issue No:-1	Date:- 13/02/2003

6.5 RF Connections

All RF connections are made to the cable termination, located on the right-hand side of the wall enclosure. Care must be taken to ensure that the correct connections are made with particular attention made to the base station TX/RX ports. In the event that the base transmitter is connected to the RX output of the rack, damage to the equipment may be done if the base station transmitter is then keyed. If the environment where the equipment is installed is deemed to be 'wet' i.e. water seepage through roofs or walls, then suitable methods to seal the RF N type connectors should be used, for example self amalgamating sealant tape.

Ensure that connections are kept clean and are fully tightened.

6.6 Commissioning

Once all connections are made the equipment is ready for commissioning.

To commission the system the test equipment detailed in section 7.2 will be required. Using the system diagrams and the end-to-end test specification, the equipment should be tested to ensure correct operation. Typical RF levels that are not listed in the end-to-end specification, such as input levels to the fibre transmitters are detailed in the whole system diagram in section 4.

On initial power up the system alarm indicators on the door of the equipment should be checked. A red LED illuminated indicates a fault and that particular module must be investigated before proceeding with the commissioning. A green LED illuminates, to indicate that the power supply is connected and valid.

The individual fibre optic units are fitted with a pair of status indicators on their front panels. One is a green LED, which indicates that the unit is connected to a 15 Volt power supply. This indicator is common to both transmit and receive units. The second LED on the transmitter indicates that the laser is operating. On the receive unit the second LED indicates that a light signal is being received.

When all the fibre connections are completed and power to each site is connected each fibre unit should show two illuminated indicators.

In the event that any part of the system does not function correctly as expected, check all connections to ensure that they are to the correct port, that the interconnecting cables are not faulty and that they are tightened. The majority of commissioning difficulties arise from problems with the interconnecting cables and connectors.

 Aerial Facilities Limited www.AerialFacilities.com Technical Literature	PBL UHF 1 & 2 Air Interface Maintenance Handbook		
	H/book Number:- 60-055900HBKM	Issue No:-1	Date:- 13/02/2003

7. MAINTENANCE

7.1 General Procedures

7.1.1 Fault Finding

In the event that the performance of the system is suspect, a methodical and logical approach to the problem will reveal the cause of the difficulty. The System consists of modules within a wall mounted, environmentally protected enclosure.

Transmissions from the main base stations are passed through the system to the mobile radio equipment; this could be a handheld walkie-talkie, mobile telephone or a transceiver in a vehicle. This path is referred to as the downlink. The return signal path from the mobile radio equipment to the base station is referred to as the uplink.

The first operation is to check the (optional) alarms of each of the active units and determine that the power supplies to the equipment are connected and active.

This can be achieved remotely (via CEMS, the digital RS232 Cell Enhancer Management System, if fitted), or locally with the front door LED's. The green LED on the front door should be illuminated, while the red alarm indicator should be off.

If an Alarm is on, then that individual module must be removed and tested against the original test specification.

The individual amplifier units have a green LED showing through a hole in their piggy-back alarm board (or directly through a hole in the the amplifier lid), which is illuminated if the unit is working correctly.

If an amplifier is suspect, check the DC power supply to the unit. If no other fault is apparent use a spectrum analyser to measure the incoming signal level at the input and then after reconnecting the amplifier input, measure the output level. Consult with the system diagram and amplifier specification to determine the expected gain and compare result.

In the event that there are no alarms on and all units appear to be functioning it will be necessary to test the system in a logical manner to confirm correct operation.

 Aerial Facilities Limited www.AerialFacilities.com Technical Literature	PBL UHF 1 & 2 Air Interface Maintenance Handbook		
	H/book Number:- 60-055900HBKM	Issue No:-1	Date:- 13/02/2003

7.1.2 Downlink

Confirm that there is a signal at the expected frequency and strength from the base station. If this is not present then the fault may lay outside the system. To confirm this, inject a downlink frequency signal from a known source at the master site BTS input and check for output at the remote site feeder output.

If a signal is not received at the output it will be necessary to follow the downlink path through the system to find a point at which the signal is lost. The expected downlink output for the given input can be found in the end-to-end test specification.

7.1.3 Uplink

Testing the uplink involves a similar procedure to the downlink except that the frequencies used are those transmitted by the mobile equipment.

7.1.4 Fault repair

Once a faulty component has been identified, a decision must be made on the appropriate course to carry out a repair. A competent engineer can quickly remedy typical faults such as faulty connections or cables. The exceptions to this are cable assemblies connecting bandpass filter assemblies that are manufactured to critical lengths to maintain a 50-ohm system. Care should be taken when replacing cables or connectors to ensure that items are of the correct specification. The repair of component modules such as amplifiers, tuned cavities or bandpass filters will not usually be possible in the field, as they frequently require specialist knowledge and test equipment to ensure correct operation. It is recommended that items of this type are replaced with a spare unit and the faulty unit returned to AFL for repair. If spare parts need to be ordered from AFL, be sure to quote the serial number of the Cell Enhancer/Repeater and the serial number [and frequencies] of the module(s) to be replaced.

 Aerial Facilities Limited www.AerialFacilities.com Technical Literature	PBL UHF 1 & 2 Air Interface Maintenance Handbook		
	H/book Number:- 60-055900HBKM	Issue No:-1	Date:- 13/02/2003

7.1.5 Checking service

Following the repair of any part of the system it is recommended that a full end-to-end test is carried out in accordance with the test specification and that the coverage is checked by survey.

It is important to bear in mind that the system includes a radiating cable network and base stations that may be faulty or may have been damaged.

7.1.6 Service Support

Advice and assistance with maintaining and servicing this system are available by contacting Aerial Facilities Ltd.

7.2 Tools & Test Equipment

The minimum tools and test equipment needed to successfully service this AFL product are as follows:-

Spectrum analyser:	100kHz to 2GHz (Dynamic range = 90dB).
Signal Generator:	30MHz to 2GHz (-120dBm to 0dBm o/p level).
Attenuator:	20dB, 10W, DC-2GHz, (N male – N female).
Test Antenna:	Yagi or dipole for operating frequency.
Optical power meter:	1310 – 1550nm (-40 - +10dB)
Digital multi-meter:	Universal Volt-Ohm-Amp meter.
Test cable x 2:	N male – N male, 2M long RG214.
Test cable x 2:	SMA male – N male, 1m long RG223.
Hand tools:	Philips #1&2 tip screwdriver. 3mm flat bladed screwdriver. SMA spanner and torque setter.

 Aerial Facilities Limited www.AerialFacilities.com Technical Literature	PBL UHF 1 & 2 Air Interface Maintenance Handbook		
	H/book Number:- 60-055900HBKM	Issue No:-1	Date:- 13/02/2003

7.3 Care of Modules

7.3.1 General Comments

Many of the active modules contain semiconductor devices utilising MOS technology, which can be damaged by electrostatic discharge. Correct handling of such modules is mandatory to ensure their long-term reliability.

To prevent damage to a module, it must be withdrawn/inserted with care. The module may have connectors on its underside, which might not be visible to the service operative.

7.3.2 Module Removal (LNA's, general procedure):

The following *general* rules should be followed to remove a module:

- 1 Remove power to the unit
- 2 Remove all visible connectors (RF, DC & alarm)
- 3 Release module retaining screws.
- 4 Slowly but firmly, pull the module straight out of its position. Take care not to twist/turn the module during withdrawal. (When the module is loose, care may be needed, as there may be concealed connections underneath).

7.3.3 Module Replacement (general):

- 1 Carefully align the module into its location then slowly push the module directly straight into its position, taking care not to twist/turn it during insertion.
- 2 Reconnect all connectors, RF, alarm, power etc.,(concealed connectors may have to be connected first).
- 3 Replace retaining screws (if any).
- 4 Double-check all connections before applying power.

7.3.4 Power Amplifiers

- 1) Remove power to the unit. (Switch off @ mains/battery, or remove DC in connector)
- 2) Remove alarm wires from alarm screw terminal block or disconnect multi-way alarm connector.
- 3) Carefully disconnect the RF input and output coaxial connectors (usually SMA)

If alarm board removal is not required, go to step 5.

- 4) There is (usually) a plate attached to the alarm board which fixes it to the amplifier, remove its retaining screws and the alarm board can be withdrawn from the amplifier in its entirety. On certain types of amplifier the alarm board is not mounted on a dedicated mounting plate; in this case it will have to firstly be removed by unscrewing it from the mounting pillars, in most cases, the pillars will not have to be removed before lifting the amplifier.

 Aerial Facilities Limited www.AerialFacilities.com Technical Literature	PBL UHF 1 & 2 Air Interface Maintenance Handbook		
	H/book Number:- 60-055900HBKM	Issue No:-1	Date:- 13/02/2003

- 5) If the amplifier to be removed has a heatsink attached, there may be several different ways it can have been assembled. The most commonly used method, is screws through the front of the heatsink to threaded screw holes (or nuts and bolts), into the amplifier within the main case. If the heatsink is mounted on the rear of the main case (e.g., against a wall in the case of wall mounted enclosures), then the fixing method for the heatsink will be from within the case, (otherwise the enclosure would have to be removed from the wall in order to remove the heatsink).

When the heatsink has been removed, the amplifier may be unscrewed from the main casing by its four corner fixings and gently withdrawn.

Fitting a new power amplifier module will be the exact reverse of the above.

Note: Do not forget to apply fresh heatsink compound to the heatsink/main case joint and also between the amplifier and the main case.

7.3.5 Low Power Amplifier Replacement

- 1 Disconnect the mains power supply and disconnect the 24V dc supply connector for the LPA.
- 2 Disconnect the RF input and output cables from the LPA.
- 3 Disconnect the alarm connector.
- 4 Remove the alarm monitoring wires from (D type connector) pins 9 and 10.
- 5 Remove the LPA module by removing the four retaining screws, replace with a new LPA module and secure it with the screws.
- 6 Connect the RF cables to the LPA input and output connectors. Reconnect the wires to the alarm board connector pins 9 and 10.
- 7 Reconnect the DC supply connector and turn the mains switch on.

Note: Tighten SMA connectors using only a dedicated SMA torque spanner. If SMA connectors are over-tightened, irreparable damage will occur. . Do not use adjustable pliers to loosen/tighten SMA connectors.

Also take care not to drop or knock the module as this can damage (or misalign in the case of tuned passive modules) sensitive internal components. Always store the modules in an environmentally friendly location

7.3.6 Module Transportation:

To maintain the operation, performance and reliability of any module it must be stored and transported correctly. Any module not installed in a whole system must be kept in an anti-static bag or container. These bags or containers are normally identified by being pink or black, and are often marked with an ESD label. Any module sent back to AFL for investigation/repair must be so protected. Please contact AFL's quality department before returning a module.

 Aerial Facilities Limited www.AerialFacilities.com Technical Literature	PBL UHF 1 & 2 Air Interface Maintenance Handbook		
	H/book Number:- 60-055900HBKM	Issue No:-1	Date:- 13/02/2003

APPENDIX A INITIAL EQUIPMENT SET-UP CALCULATIONS

GENERAL INFORMATION			
Site Name:		Client Name:	
Date:		AFL Equip. Model No.	

ANTENNA SYSTEMS				
	Model	Gain	Azimuth	Comments
A - Service Antenna				
B - Donor Antenna				
	Type	Loss	Length	Comments
C - Service Feeder				
D - Donor Feeder				

INITIAL PARAMETERS	
E - CE Output Power	dBm
F - Antenna Isolation	dB
G - Input signal level from donor BTS	dBm
Operating Voltage	V

DOWNLINK CALCULATIONS		
Parameter	Comments	Value
Input signal level (G)		dBm
CE max. o/p power (E)		dBm
Gain setting	E - G	dB
Isolation required	(Gain + 10dB)	dB
Service antenna gain (A)		dB
Service antenna feeder loss (C)		dB
Effective radiated power (ERP)	E+A-C	dBm
Attenuator setting	CE gain-gain setting	dB

If the input signal level in the uplink path is known and steady, use the following calculation table to determine the gain setting. If the CE features Automatic Gain Control the attenuator should be set to zero and if not, then the attenuation setting for both uplink and downlink should be similar.

UPLINK CALCULATIONS		
Parameter	Comments	Value
Input signal level		dBm
CE max. o/p power (E)		dBm
Gain setting		dB
Required isolation		dB
Donor antenna gain (B)		dB
Donor antenna feeder loss (D)		dB
Effective radiated power (ERP)	E+B-D	dBm
Attenuator setting	(CE gain-gain setting)	dB