



A RADIO TEST REPORT

FOR

AXELL WIRELESS

ON

D-CSR-3604-4

DOCUMENT NO. TRA-020328-47-00-C

HULL

Unit E, South Orbital Trading Park, Hedon Road, Hull, HU9 1NJ, UK.

T +44 (0)1482 801801 **F** +44 (0)1482 801806 **E** test@tracglobal.com

www.tracglobal.com

TRaC Wireless Test Report : TRA-020328-47-00-C

Applicant : Axell Wireless

Apparatus : D-CSR-3604-4

Specification(s) : CFR47 Part 90 & RSS-131

Purpose of Test : **Certification**

FCCID : **NEOA284SERIES**

Authorised by :



: Radio Product Manager

Issue Date : **15th May 2014**

Authorised Copy Number : *PDF*

Contents

Section 1:	Introduction	4
1.1	General	4
1.2	Tests Requested By	5
1.3	Manufacturer	5
1.4	Apparatus Assessed	5
1.5	Test Result Summary	6
1.6	Equipment Test Conditions	7
1.7	Standard References	8
1.8	Notes Relating To Assessment	9
1.9	Deviations from Test Standards	9
Section 2:	Measurement Uncertainty	10
2.1	Measurement Uncertainty Values	10
Section 3:	Modifications	12
3.1	Modifications Performed During Assessment	12
Appendix A:	Uplink Formal Emission Test Results	13
A1	RF Gain and Output Power	14
A2	Amplifier Intermodulation Spurious Emissions	16
A3	Amplifier Modulated Channel Test	19
A4	Spurious Emissions at Antenna Terminals Less than 1MHz	21
A5	Spurious Emissions at Antenna Terminals Greater than 1MHz	23
A6	Noise at Antenna Terminals	27
A7	Radiated Electric Field Emissions	29
A8	Passband Gain & Bandwidth	34
Appendix B:	Downlink Formal Emission Test Results	35
B1	RF Gain and Output Power	36
B2	Amplifier Intermodulation Spurious Emissions	38
B3	Amplifier Modulated Channel Test	41
B4	Spurious Emissions at Antenna Terminals Less than 1MHz	43
B5	Spurious Emissions at Antenna Terminals Greater than 1MHz	45
B6	Noise at Antenna Terminals	49
B7	Radiated Electric Field Emissions	51
B8	Passband Gain & Bandwidth	56
Appendix C:	Additional Test and Sample Details	57
Appendix D:	Additional Information	63
Appendix E:	Good Engineering Information from Manual	64
Appendix G:	Photographs and Figures	65

Section 1:**Introduction****1.1 General**

This report contains an assessment of an apparatus against Electromagnetic Compatibility Standards based upon tests carried out on samples submitted to the Laboratory.

Test performed by: TRaC Global []
Unit E
South Orbital Trading Park
Hedon Road
Hull, HU9 1NJ.
United Kingdom.

Telephone: +44 (0) 1482 801801
Fax: +44 (0) 1482 801427

TRaC Global [X]
Unit 1
Pendle Place
Skelmersdale
West Lancashire, WN8 9PN
United Kingdom

Telephone: +44 (0) 1695 556666
Fax: +44 (0) 1695 577077

Email: test@tracglobal.com
Web site: <http://www.tracglobal.com>

Tests performed by: D. Winstanley

Report author: D. Winstanley

This report must not be reproduced except in full without prior written permission from TRaC Global.

1.2 Tests Requested By

This testing in this report was requested by :

Aerial House
Asheridge Road
Chesham
Buckinghamshire
HP5 1TU

1.3 Manufacturer

Aerial House
Asheridge Road
Chesham
Buckinghamshire
HP5 1TU

1.4 Apparatus Assessed

The following apparatus was assessed between 19th February – 5th March:

D-CSR-3604-4

The Axell D-CSR-3604-4 is a booster that supports the following bands

Uplink	-	427.0 – 430.0MHz
Downlink	-	421.0 – 424.5MHz

1.5 Test Result Summary

Full details of test results are contained within Appendix A. The following table summarises the results of the assessment.

The statements relating to compliance with the standards below apply ONLY as qualified in the notes and deviations stated in sections 1.6 to 1.7 of this test report.

Full details of test results are contained within Appendix A. The following table summarises the results of the assessment.

Test Type	FCC Part	RSS-131 Rule Part	Appendix in Report	Result
RF Power Output	90.219(e)(1)	4.3	A1 & B1	Pass
Intermodulation Spurious Emissions	90.219(e)(3)	N/A	A2 & B2	Pass
Occupied Bandwidth & Modulation	90.219(a), 90.219(e)(4)(ii)	N/A	A3 & B3	Pass
Spurious Emissions at Antenna Terminals	90.219(e)(3)	N/A	A4 & B4	Pass
Field Strength of Spurious Emissions	90.219(e)(3)	4.3.2	A5 & B5	Pass
Frequency Stability	90.213	4.4	N/A(note 1)	N/A
Transient behaviour	90.214	4.4	N/A(note 2)	N/A
Passband Gain & 20dB bandwidth	N/A	4.2	A6 & B6	Pass
Audio Frequency Response (a)	TIA EIA-603.3.2.6	4.5	N/A	N/A
Modulation Limiting	TIA EIA-603.3.2.6	N/A	N/A	N/A
Label requirement	90.219(e)(5)(4)	N/A	N/A	Pass

Notes:

1 The EUT does not contain modulation circuitry, therefore the test was not performed.

2 The EUT is not a keyed carrier system, therefore the test was not performed.

Abbreviations used in the above table:

CFR : Code of Federal Regulations
 REFE : Radiated Electric Field Emissions
 A Uplink Results Appendix

ANSI : American National Standards Institution
 PLCE : Power Line Conducted Emissions
 B Downlink Results Appendix

1.6 Equipment Test Conditions

Product class:	Uplink	Class A <input type="checkbox"/> Class B <input checked="" type="checkbox"/>
	Downlink	Class A <input type="checkbox"/> Class B <input checked="" type="checkbox"/>
Product Use:	Private Land Mobile Repeater	
Supply Voltages:	Vnom	+110Vac
Note: Vnom voltages are as stated above unless otherwise shown on the test report page		
Equipment Category:	Single channel	<input type="checkbox"/>
	Two channel	<input type="checkbox"/>
	Multi-channel	<input checked="" type="checkbox"/>
Channel spacing:	Wideband	Uplink
	Wideband	Downlink
Test Location	TRaC Global	
	Skelmersdale	<input checked="" type="checkbox"/>
	Hull	<input type="checkbox"/>
	Other	<input type="checkbox"/> Please Specify

1.7 Standard References

47 CFR 2	Code of Federal Regulations, Title 47, Part 2, "Frequency allocations and Radio Telemetry Matters; General Rules and Regulations"
47 CFR 90	Code of Federal Regulations, Title 47, Part 90, "Land Mobile Radio Service"
47 CFR 15	Code of Federal Regulations, Title 47, Part 15, "Radio Frequency Devices" Subpart B, "Unintentional Radiators"
C63.4-2003	American National Standards Institute (ANSI), "Methods of Measurement of Radio Noise Emissions from Low Voltage Electrical and Electronic Equipment in the Range 9 kHz to 40 GHz"
RSS-131	Zone Enhancers for the Land Mobile Service
RSS-GEN	General Requirements and Information for the Certification of Radio Apparatus

1.8 Notes Relating To Assessment

With regard to this assessment, the following points should be noted:

The results contained in this report relate only to the items tested and were obtained in the period between the date of initial receipt of samples and the date of issue of the report.

The apparatus was set up and exercised using the configurations, modes of operation and arrangements defined in this report only.

Particular operating modes, apparatus monitoring methods and performance criteria required by the standards tested to have been performed except where identified in Section 1.7 of this test report (Deviations from Test Standards).

For emissions testing, throughout this test report, "Pass" indicates that the results for the sample as tested were below the specified limit (refer also to Section 2, Measurement Uncertainty).

Where relevant, the apparatus was only assessed using the monitoring methods and susceptibility criteria defined in this report.

All testing with the exception of testing at the Open Area Test Site was performed under the following environmental conditions:

Temperature	: 17 to 23 °C
Humidity	: 45 to 75 %
Barometric Pressure	: 86 to 106 kPa

All dates used in this report are in the format dd/mm/yy.

This assessment has been performed in accordance with the requirements of ISO/IEC 17025.

1.9 Deviations from Test Standards

There were no deviations from the standards tested to.

Section 2:**Measurement Uncertainty****2.1 Measurement Uncertainty Values**

For the test data recorded the following measurement uncertainty was calculated:

Radio Testing – General Uncertainty Schedule

All statements of uncertainty are expanded standard uncertainty using a coverage factor of 1.96 to give a 95% confidence where no required test level exists.

[1] Adjacent Channel Power

Uncertainty in test result = **1.86dB**

[2] Carrier Power

Uncertainty in test result (Power Meter) = **1.08dB**

Uncertainty in test result (Spectrum Analyser) = **2.48dB**

[3] Effective Radiated Power

Uncertainty in test result = **4.71dB**

[4] Spurious Emissions

Uncertainty in test result = **4.75dB**

[5] Maximum frequency error

Uncertainty in test result (Frequency Counter) = **0.113ppm**

Uncertainty in test result (Spectrum Analyser) = **0.265ppm**

[6] Radiated Emissions, field strength OATS 14kHz-18GHz Electric Field

Uncertainty in test result (14kHz – 30MHz) = **4.8dB**,

Uncertainty in test result (30MHz – 1GHz) = **4.6dB**,

Uncertainty in test result (1GHz – 18GHz) = **4.7dB**

[7] Frequency deviation

Uncertainty in test result = **3.2%**

[8] Magnetic Field Emissions

Uncertainty in test result = **2.3dB**

[9] Conducted Spurious

Uncertainty in test result – Up to 8.1GHz = **3.31dB**

Uncertainty in test result – 8.1GHz – 15.3GHz = **4.43dB**

Uncertainty in test result – 15.3GHz – 21GHz = **5.34dB**

Uncertainty in test result – Up to 26GHz = **3.14dB**

[10] Channel Bandwidth

Uncertainty in test result = **15.5%**

[11] Amplitude and Time Measurement – Oscilloscope

Uncertainty in overall test level = **2.1dB**,
Uncertainty in time measurement = **0.59%**,
Uncertainty in Amplitude measurement = **0.82%**

[12] Power Line Conduction

Uncertainty in test result = **3.4dB**

[13] Spectrum Mask Measurements

Uncertainty in test result = **2.59% (frequency)**
Uncertainty in test result = **1.32dB (amplitude)**

[14] Adjacent Sub Band Selectivity

Uncertainty in test result = **1.24dB**

[15] Receiver Blocking – Listen Mode, Radiated

Uncertainty in test result = **3.42dB**

[16] Receiver Blocking – Talk Mode, Radiated

Uncertainty in test result = **3.36dB**

[17] Receiver Blocking – Talk Mode, Conducted

Uncertainty in test result = **1.24dB**

[18] Receiver Threshold

Uncertainty in test result = **3.23dB**

[19] Transmission Time Measurement

Uncertainty in test result = **7.98%**

Section 3:

Modifications

3.1 Modifications Performed During Assessment

No modifications were performed during the assessment

Appendix A:**Uplink Formal Emission Test Results**

Abbreviations used in the tables in this appendix:

Spec	: Specification	ALSR	: Absorber Lined Screened Room
Mod	: Modification	OATS	: Open Area Test Site
EUT	: Equipment Under Test	ATS	: Alternative Test Site
SE	: Support Equipment	Ref	: Reference
L	: Live Power Line	Freq	: Frequency
N	: Neutral Power Line	MD	: Measurement Distance
E	: Earth Power Line	SD	: Spec Distance
Pk	: Peak Detector	Pol	: Polarisation
QP	: Quasi-Peak Detector	H	: Horizontal Polarisation
Av	: Average Detector	V	: Vertical Polarisation
CDN	: Coupling & decoupling network		

A1 RF Gain and Output Power

Test Details:	
Measurement standard	Part 2.1046, Part 90.219(e)(1),RSS-131 Section 4.3
EUT sample number	S01
Modification state	0
SE in test environment	None
SE isolated from EUT	None
Temperature °C	22
Humidity %	48
EUT set up	Refer to Appendix C

Frequency MHz	Signal Generator input level dBm	Input Cable Loss dB	Level at Spectrum Analyser dBm	Output Cable & Attenuator loss dB	Gain dB	Conducted Output Power dBm	Gain after 10dB input level increase dB
427.0	-44.00	0.20	-1.67	36.2	78.73	34.53	68.79
428.5	-47.00	0.20	-0.83	36.2	82.57	35.37	73.03
430.0	-47.00	0.20	-0.84	36.2	82.56	35.36	73.85

Notes: 1.The signal generator input was increased by 10dBs and the level of the output signal remeasured.

As per D.3 Policies + Procedures (k) of KDB 935210 D02 Signal Boosters Certification v02 the EUT was tested at compression and 10dB into compression to show AGC operation

A2 Amplifier Intermodulation Spurious Emissions

Test Details:	
Measurement standard	Part 2.1053, 90.219(e)(3)
EUT sample number	S01
Modification state	0
SE in test environment	None
SE isolated from EUT	None
EUT set up	Refer to Appendix C

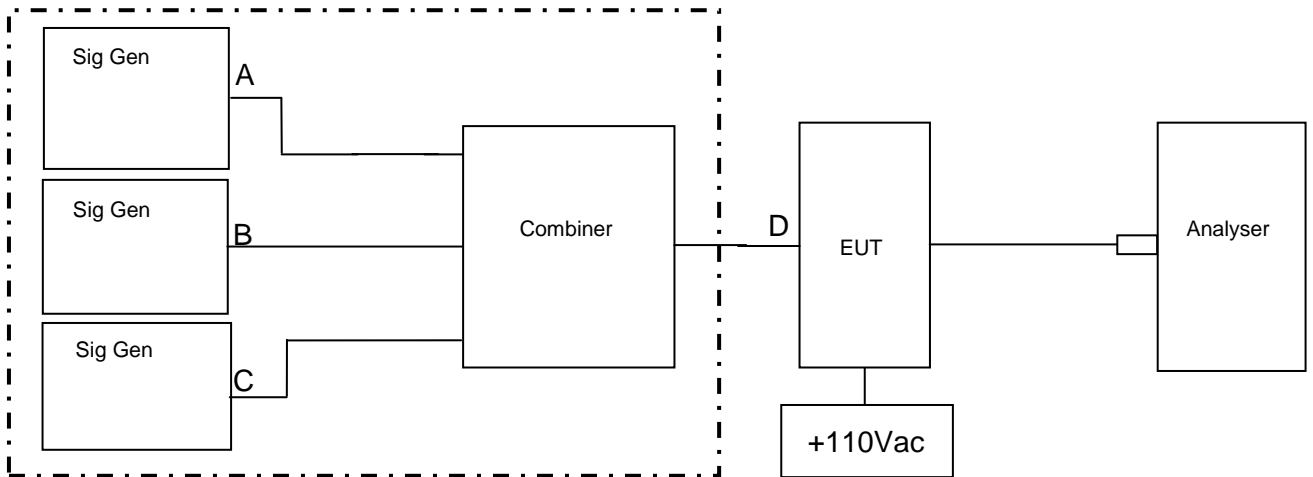

Signal Generator B was varied in frequency to check if intermodulation products were produced.

RF Input Frequency (MHz)			Highest Intermodulation Product Level (dBm)	Limit (dBm)
427.0	429.0	430.0	-23.88 dBm @ 428.0 MHz	-13

Sweep data is shown on the next page:

Results

The EUT was found to comply with the limits

See plots below

As per D.3 Policies + Procedures (k) of KDB 935210 D02 Signal Boosters Certification v02 the EUT was tested at compression and 10dB into compression to show AGC operation, worst case results taken.

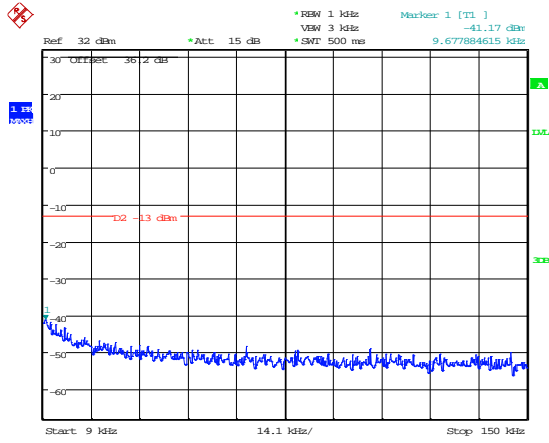

Date: 20.FEB.2014 10:30:57

9-150kHz

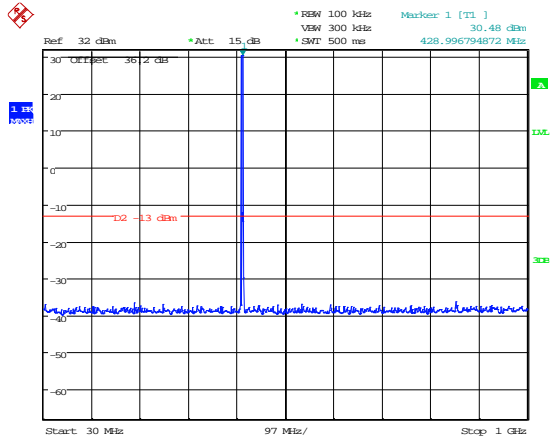

Date: 20.FEB.2014 10:28:45

150kHz – 30MHz

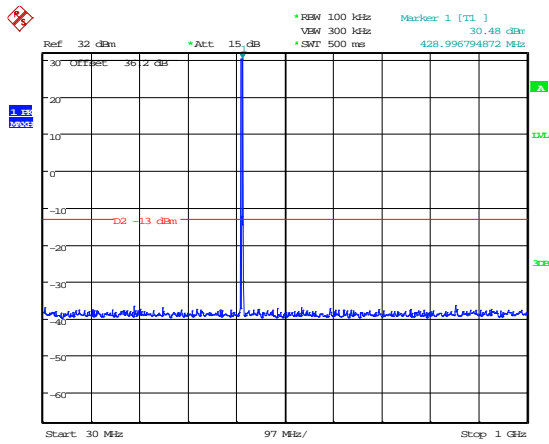

Date: 20.FEB.2014 10:28:45

30MHz – 1GHz

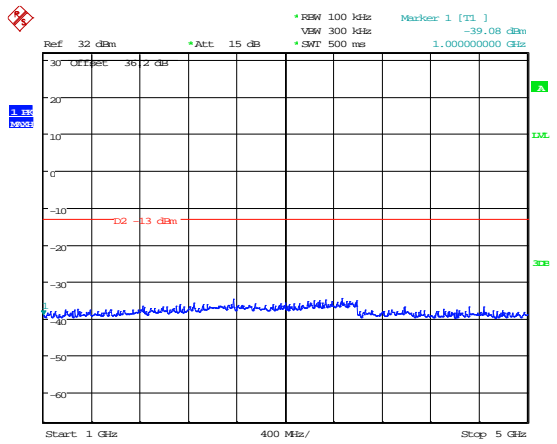

Date: 20.FEB.2014 10:29:10

1GHz – 5GHz

A3 Amplifier Modulated Channel Test

Test Details:	
Measurement standard	Part 2.1049, Part 219(a) Part 90.219(e)(4)(ii), 90.210(c), 90.210(d) and 90.210(e)
EUT sample number	S01
Modification state	0
SE in test environment	None
SE isolated from EUT	None
EUT set up	Refer to Appendix C

Modulation Type	Frequency Of Operation Channel (MHz)		
	427.0	428.5	430.0
Analogue	10.128 kHz	10.128 kHz	10.128 kHz

As per D.3 Policies + Procedures (k) of KDB 935210 D02 Signal Boosters Certification v02 the EUT was tested at compression and 10dB into compression to show AGC operation, worst case results taken.

427.0 MHz FM Signal Generator and EUT

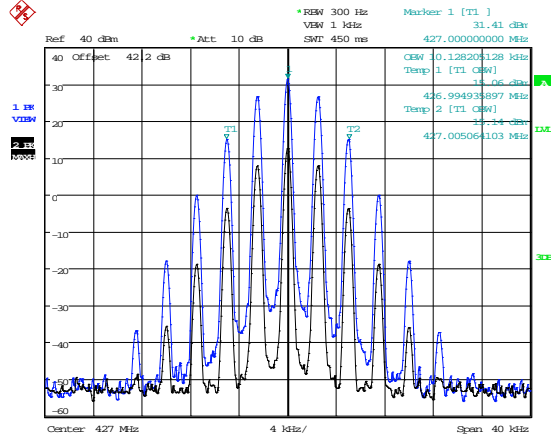

Date: 20.FEB.2014 16:15:07

428.5 MHz FM Signal Generator and EUT

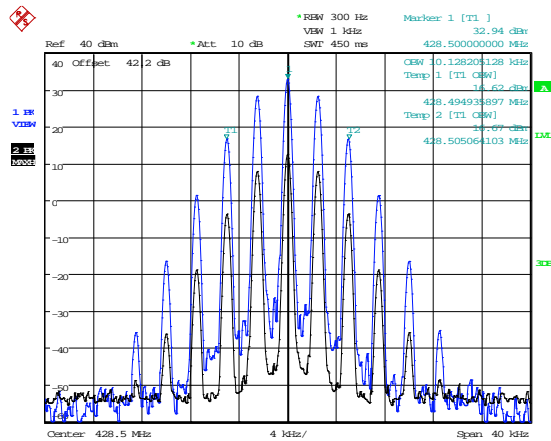

Date: 20.FEB.2014 16:16:54

430.0 MHz FM Signal Generator and EUT

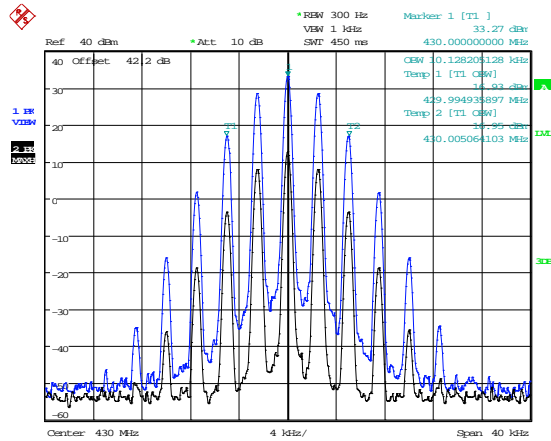

Date: 20.FEB.2014 16:19:56

The above plots depicting the output waveshape show no measurable distortion visible when compared to the input signal.

A4 Spurious Emissions at Antenna Terminals Less than 1MHz

Test Details:	
Measurement standard	Part 2.1053, 90.219(e)(3), 90.210(c), 90.210(d) and 90.210(e)
EUT sample number	S01
Modification state	0
SE in test environment	None
SE isolated from EUT	None
EUT set up	Refer to Appendix C

Modulation Type	Bandedge	Carrier Frequency (MHz)	Max Level @ bandedge (dBm)
Analogue	Lower	427.0125	-48.23
	Upper	429.9875	-47.37

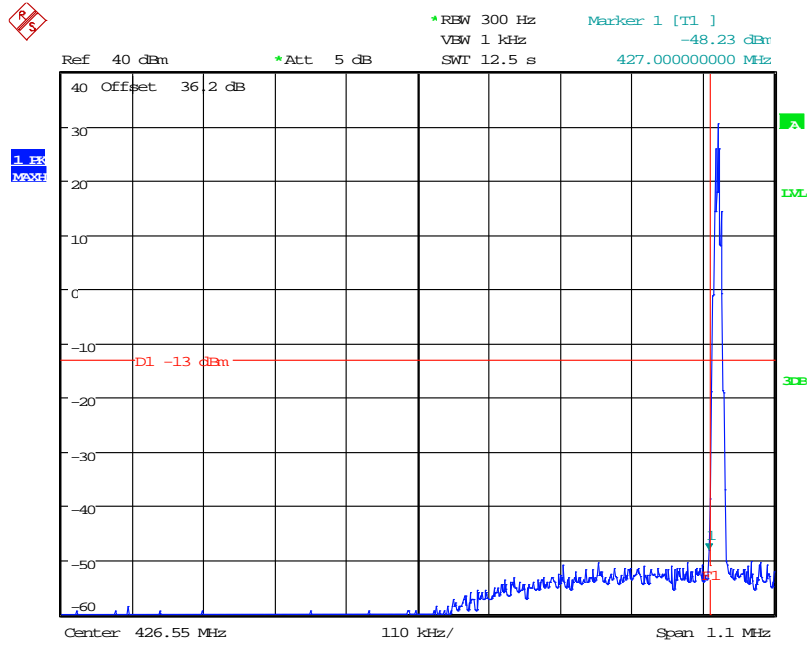

Date: 5.MAR.2014 11:40:11

Analogue Signal – Lower Bandedge

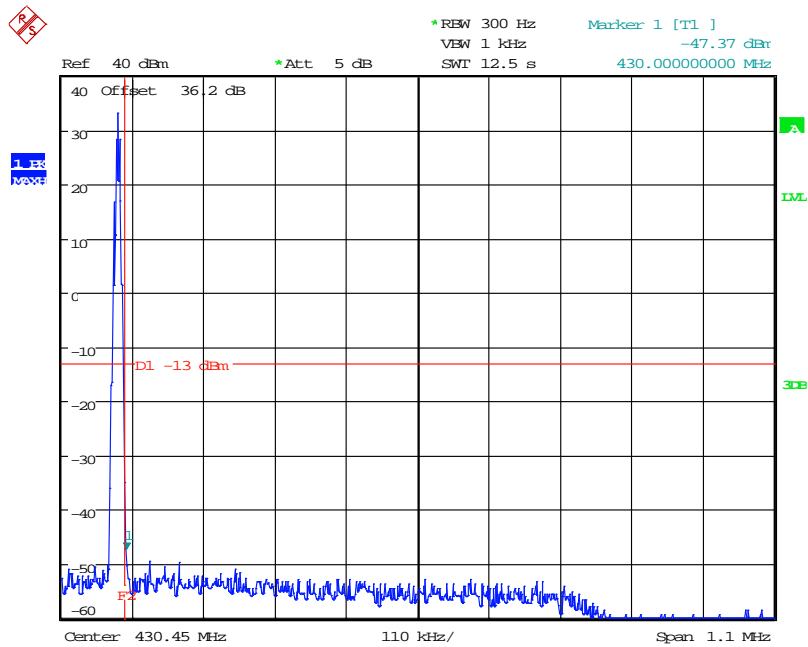

Date: 5.MAR.2014 11:39:03

Analogue Signal – Upper Bandedge

A5 Spurious Emissions at Antenna Terminals Greater than 1MHz

Test Details:	
Measurement standard	Part 2.1053, 90.219(e)(3)
EUT sample number	S01
Modification state	0
SE in test environment	None
SE isolated from EUT	None
EUT set up	Refer to Appendix C

Bottom Channel

Frequency Range (MHz)	Freq. of Emission (MHz)	Measured Level (dBm)	Attenuator & Cable Losses (dB)	Spurious Emission Level (dBm)	Limit dBm
9 kHz - 5 GHz	No Significant Emissions Within 20 dB of the Limit				-13

Middle Channel

Frequency Range (MHz)	Freq. of Emission (MHz)	Measured Level (dBm)	Attenuator & Cable Losses (dB)	Spurious Emission Level (dBm)	Limit dBm
9 kHz - 5 GHz	No Significant Emissions Within 20 dB of the Limit				-13

Top channel

Frequency Range (MHz)	Freq. of Emission (MHz)	Measured Level (dBm)	Attenuator & Cable Losses (dB)	Spurious Emission Level (dBm)	Limit dBm
9 kHz - 5 GHz	No Significant Emissions Within 20 dB of the Limit				-13

Limit is determined by the outermost step of the emissions mask and is calculated as follows:

At least $43 + 10 \log P$ dB

$$(10 \log P_{\text{watts}}) - (43 + 10 \log (P_{\text{watts}} * 1000)) = \text{LIMIT} = -13 \text{ dBm}$$

Result

The EUT was found to comply with the limits

Spurious Emissions at Antenna Terminals Greater than 1MHz

427.0 MHz

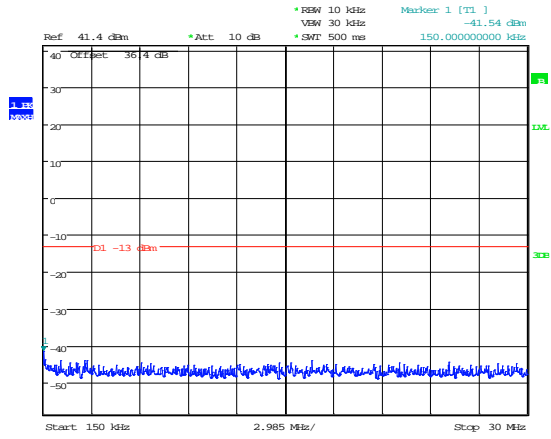
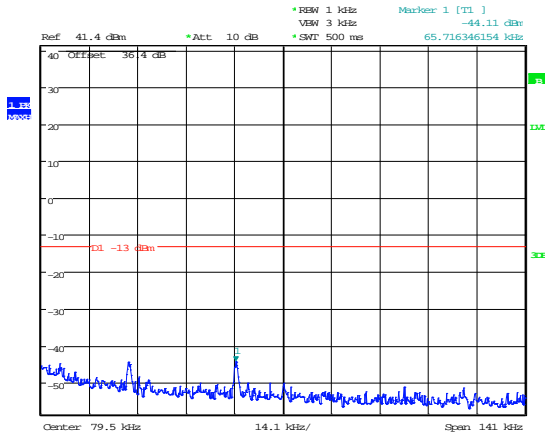

Date: 19.FEB.2014 15:55:15

Date: 19.FEB.2014 16:10:27

9-150kHz

150kHz – 30MHz

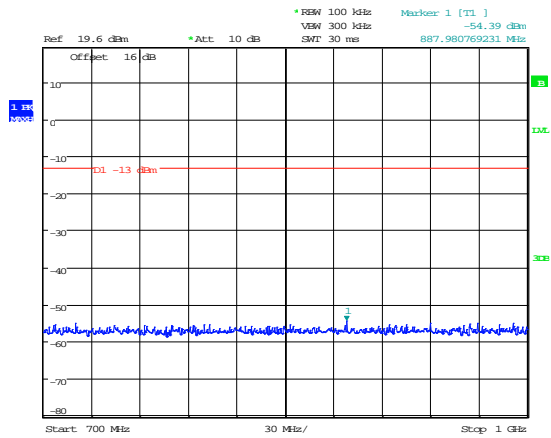
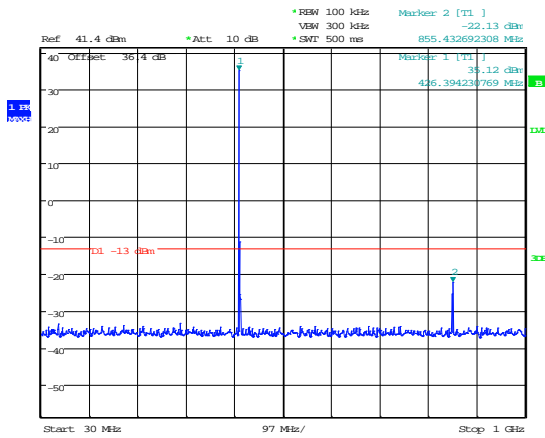

Date: 19.FEB.2014 16:11:03

Date: 19.FEB.2014 16:33:46

30MHz – 1GHz

700MHz – 1 GHz with High pas filter

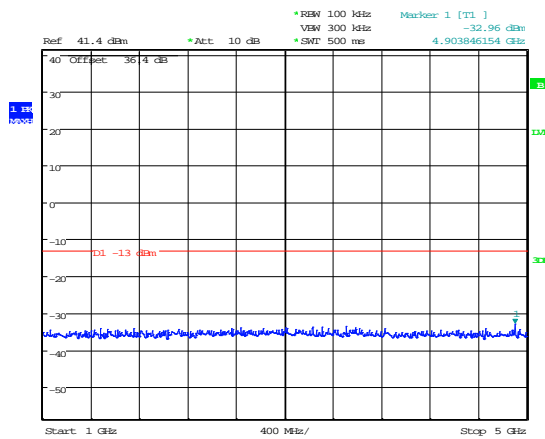

Date: 19.FEB.2014 16:11:27

1GHz – 5GHz

Spurious Emissions at Antenna Terminals Greater than 1MHz

428.5 MHz

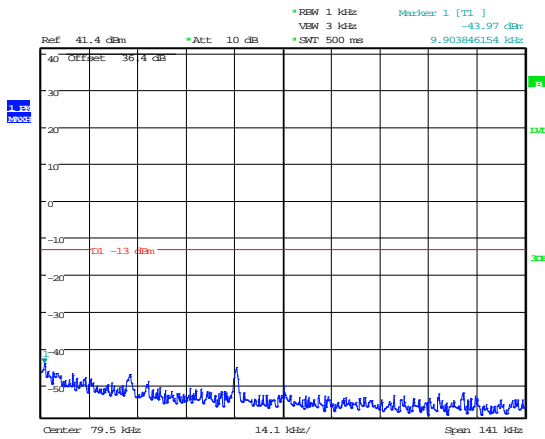

Date: 19.FEB.2014 15:56:35

9-150kHz

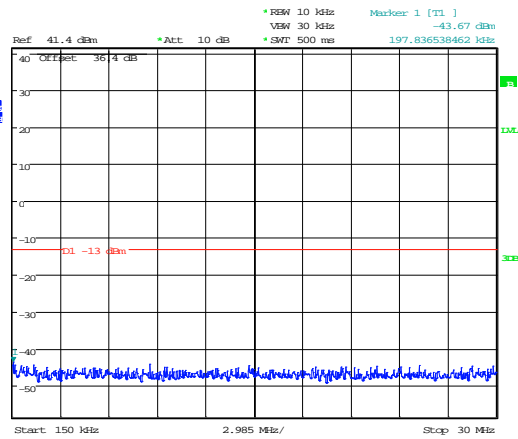

Date: 19.FEB.2014 16:20:50

150kHz – 30MHz

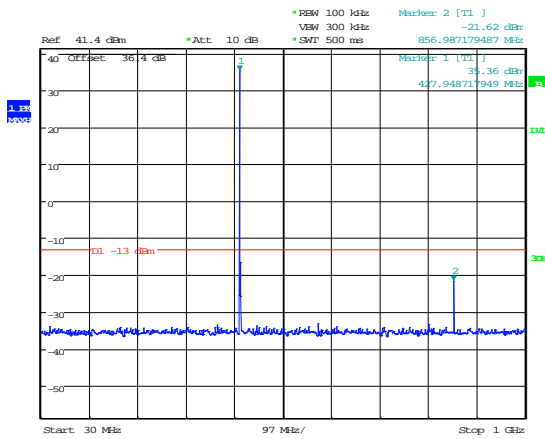

Date: 19.FEB.2014 16:19:52

30MHz – 1GHz

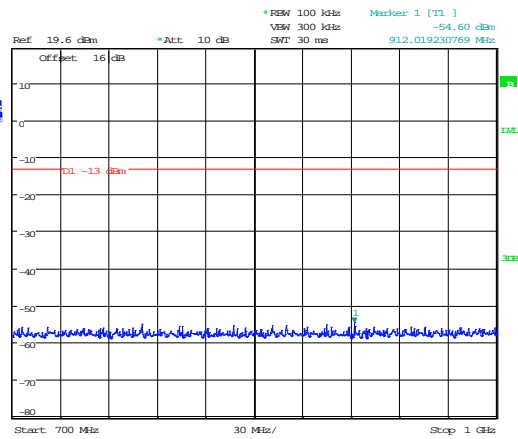

Date: 19.FEB.2014 16:36:02

700MHz – 1 GHz with High pas filter

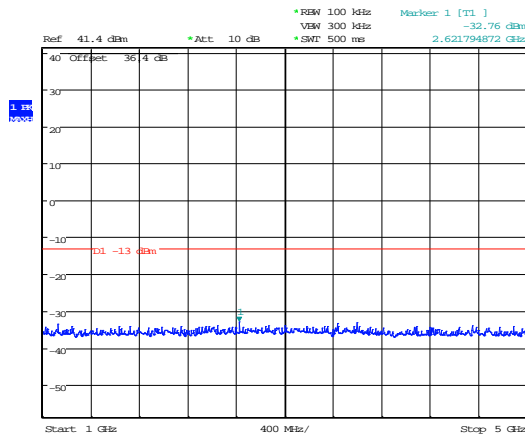

Date: 19.FEB.2014 16:20:15

1GHz – 5GHz

Spurious Emissions at Antenna Terminals Greater than 1MHz

430.0 MHz

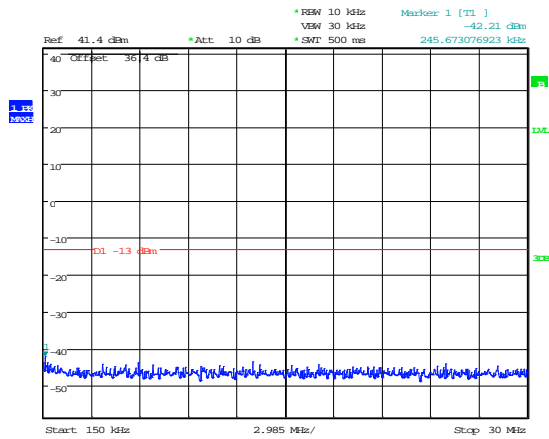
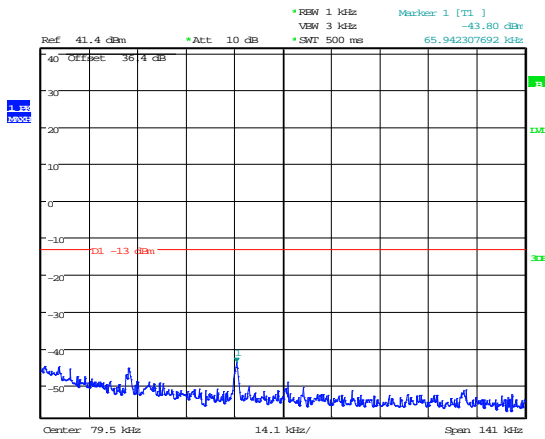

Date: 19.FEB.2014 15:57:40

Date: 19.FEB.2014 16:17:10

9-150kHz

150kHz – 30MHz

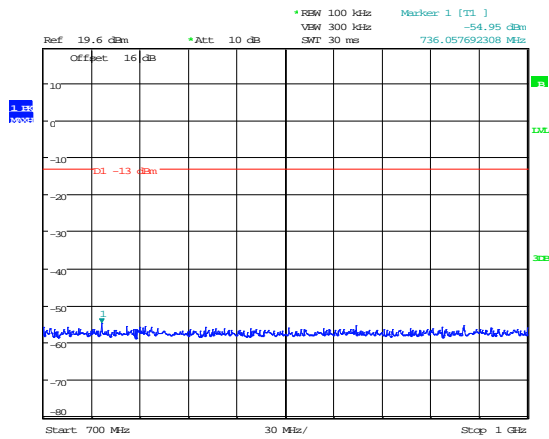
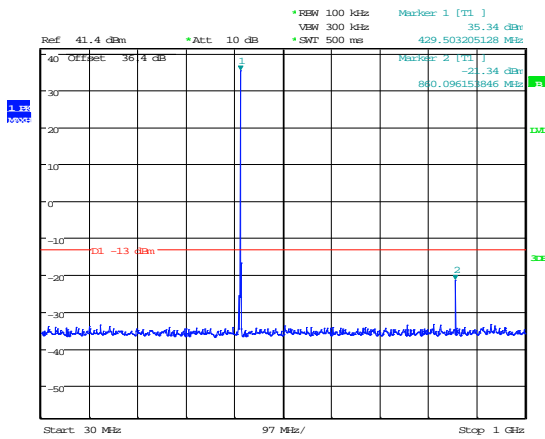

Date: 19.FEB.2014 16:19:04

Date: 19.FEB.2014 16:37:43

30MHz – 1GHz

700MHz – 1 GHz with High pas filter

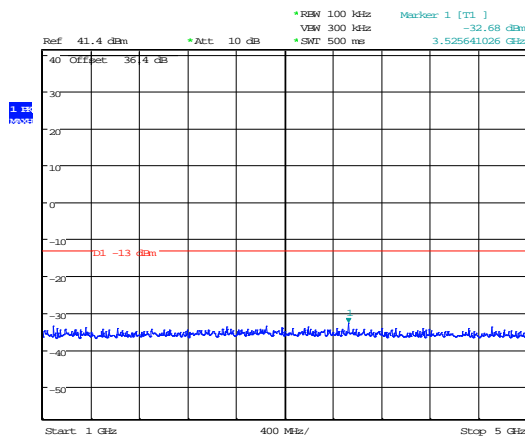

Date: 19.FEB.2014 16:18:38

1GHz – 5GHz

A6 Noise at Antenna Terminals

Test Details:	
Measurement standard	90.219(e)(2), 90.219(e)(3)
EUT sample number	S01
Modification state	0
SE in test environment	None
SE isolated from EUT	None
EUT set up	Refer to Appendix C

Compliance with these levels will be deemed satisfaction of the good engineering practice requirement. In a 10 kHz measurement bandwidth:

- (1) the ERP of noise within the signal booster passband should not exceed -43dBm ;
- and
- (2) the ERP of noise on spectrum more than 1 MHz outside of the signal booster passband should not exceed -70 dBm .
- (3) The noise figure of a signal booster must not exceed 9 dB in either direction

See appendix E for declaration of good engineering practice

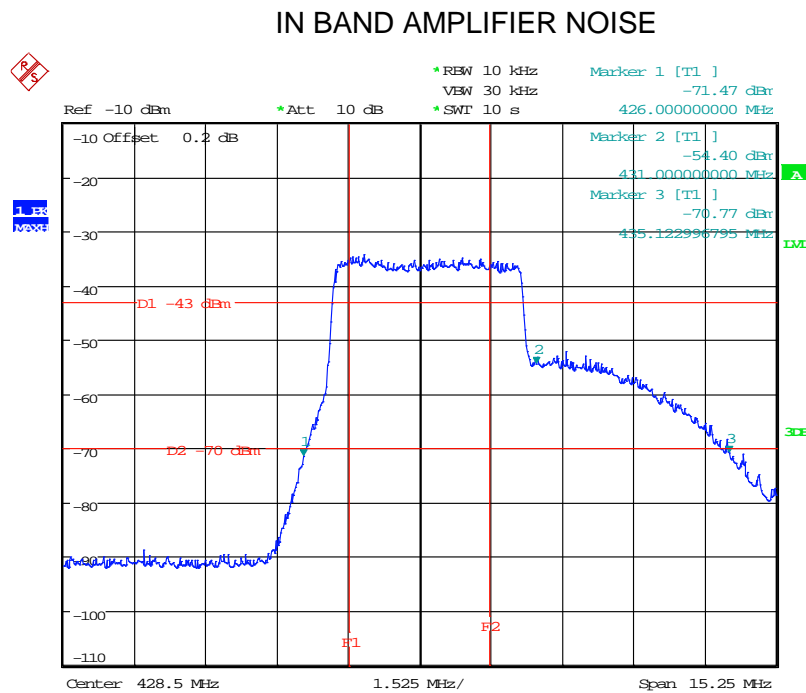

Date: 20.FEB.2014 15:38:29

Signal booster noise figure

Test equipment set up:-

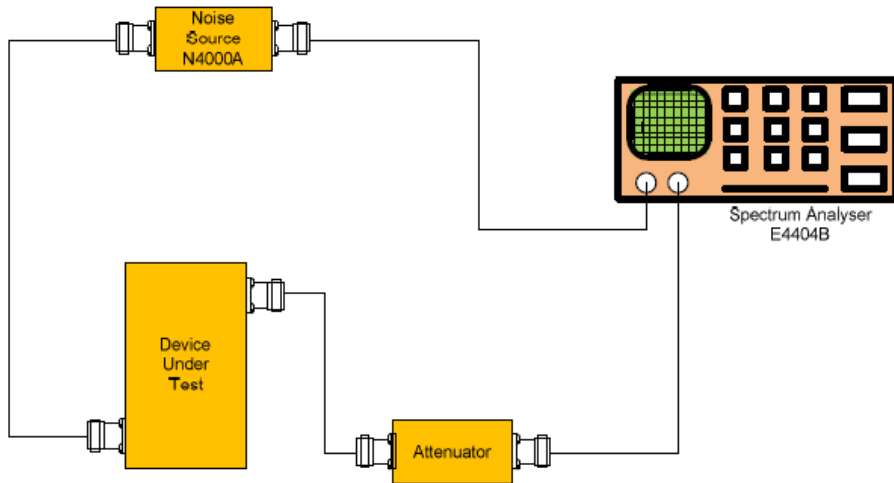

Result

Plots for noise figure, taken with the 18MHz filter applied at maximum gain with 70dB external attenuators in the test set up

Frequency (MHz)	Noise Figure dB
428.5	4.2703 dB

General notes about measurement setup:

- 1) The spectrum analyser has the noise figure measurement personality enabled.

Noise Figure – 428.5 MHz

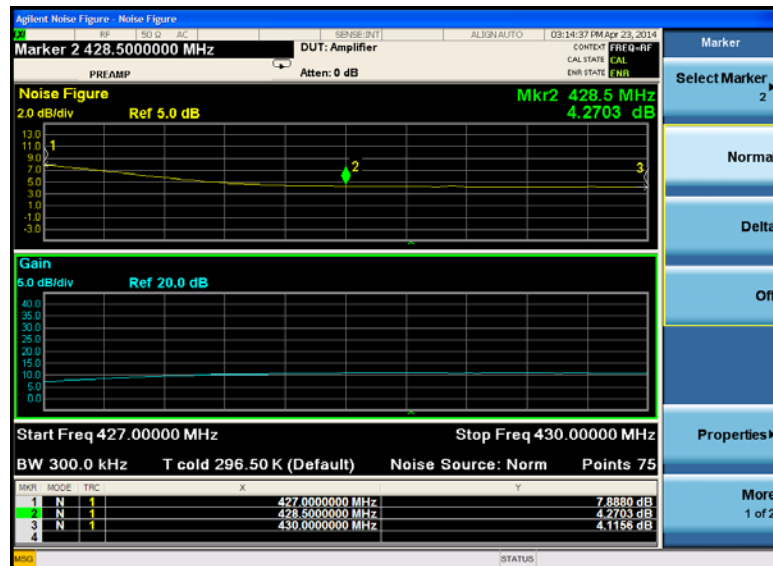

A7 Radiated Electric Field Emissions

Preliminary scans were performed using a peak detector with the RBW = 100kHz. The radiated electric field emission test applies to all spurious and harmonic emissions. The EUT was set to transmit as required.

The following test site was used for final measurements as specified by the standard tested to:

3m open area test site : 3m alternative test site :

The effect of the EUT set-up on the measurements is summarised in note (c) below.

Test Details:	
Measurement standard	Title 47 of the CFR: Part 2.1053, RSS-131 Section 4.3.2
Frequency range	30MHz – 5GHz
EUT sample number	S01
Modification state	0
SE in test environment	None
SE isolated from EUT	None
EUT set up	Refer to Appendix C
Photographs (Appendix F)	

Bottom Frequency

FREQUENCY RANGE	FREQ. (MHz)	ERP/EIRP (dBm)	LIMIT (dBm)
30MHz - 5GHz	No Significant Emissions Within 20dB of the Limit		-13

Middle Frequency

FREQUENCY RANGE	FREQ. (MHz)	ERP/EIRP (dBm)	LIMIT (dBm)
30MHz - 5GHz	No Significant Emissions Within 20dB of the Limit		-13

Top Frequency

FREQUENCY RANGE	FREQ. (MHz)	ERP/EIRP (dBm)	LIMIT (dBm)
30MHz - 5GHz	No Significant Emissions Within 20dB of the Limit		-13

Result

The EUT was found to comply with the limits

Notes:

1. Emissions Checked up to 10 times Fc.
2. The unit was mounted on a turntable and rotated through 360° and in 3 orthogonal planes to find the worst case emission.
3. For Frequencies below 1 GHz, RBW = 120 kHz, testing was performed with CISPR16 compliant test receiver with QP detector. Above 1 GHz tests were performed using a spectrum analyser using the following settings:

Peak Detector RBW = 1MHz; VBW = ≥RBW

4. Limit is determined as the outermost step of the emissions mask and is calculated as follows.

At least 43 + 10 log P dB

$$(10\log P_{\text{watts}}) - (43 + 10\log (P_{\text{watts}} * 1000)) = \text{LIMIT} = -13 \text{ dBm}$$

The upper and lower frequency of the measurement range was decided according to 47 CFR Part 2.1057.

- (a) Where results have been measured at one distance, and a signal level displayed at another, the results have been extrapolated using the following formula:

$$\text{Extrapolation (dB)} = 20 \log_{10} \left(\frac{\text{measurement distance}}{\text{specification distance}} \right)$$

- (b) The levels may have been rounded for display purposes.
- (c) The following table summarises the effect of the EUT operating mode, internal configuration and arrangement of cables / samples on the measured emission levels :

	See (i)	See (ii)	See (iii)	See (iv)
Effect of EUT operating mode on emission levels	✓			
Effect of EUT internal configuration on emission levels	✓			
Effect of Position of EUT cables & samples on emission levels	✓			
(i) Parameter defined by standard and / or single possible, refer to Appendix D (ii) Parameter defined by client and / or single possible, refer to Appendix D (iii) Parameter had a negligible effect on emission levels, refer to Appendix D (iv) Worst case determined by initial measurement, refer to Appendix D				

Radiated Electric Field Emissions

427.0 MHz

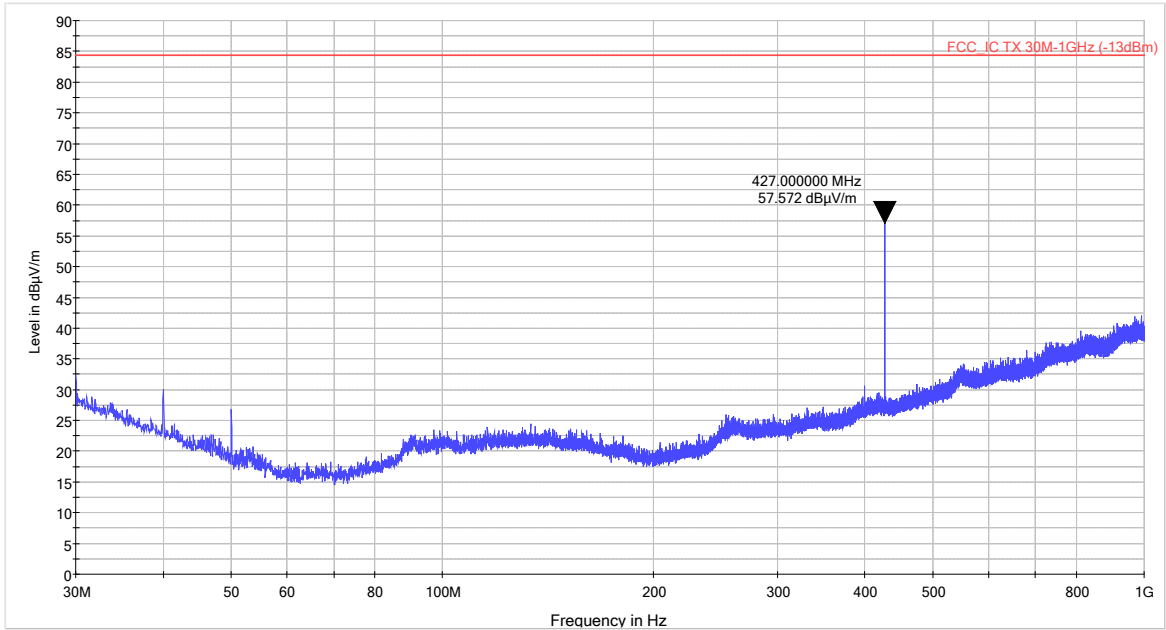

30MHz – 1GHz

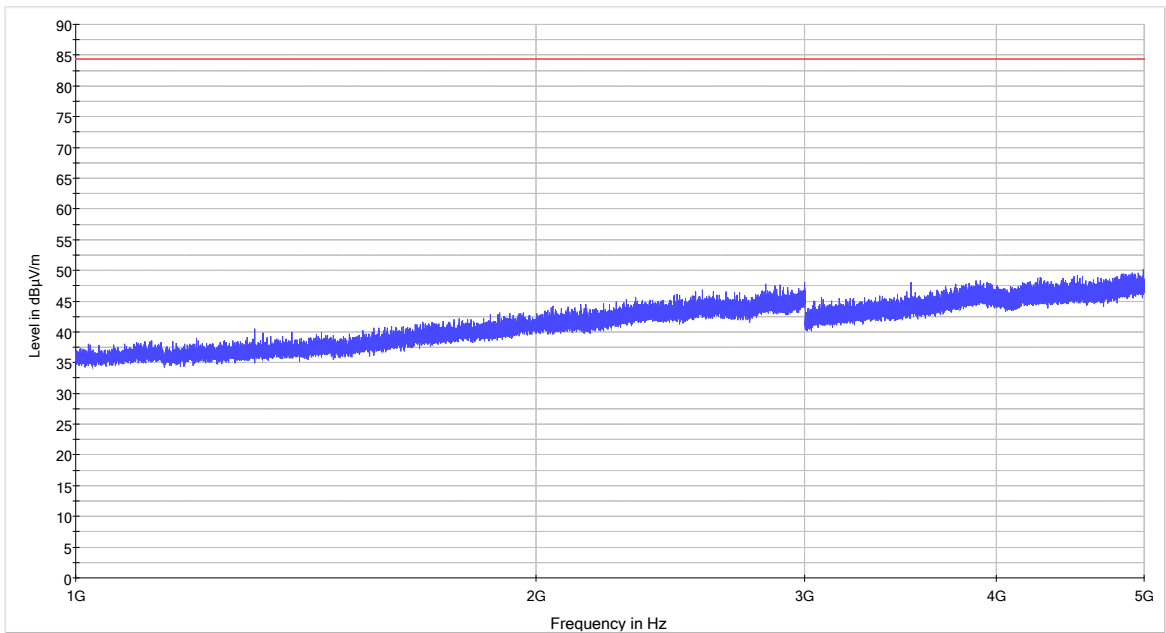

1GHz – 5GHz

Radiated Electric Field Emissions

428.5 MHz

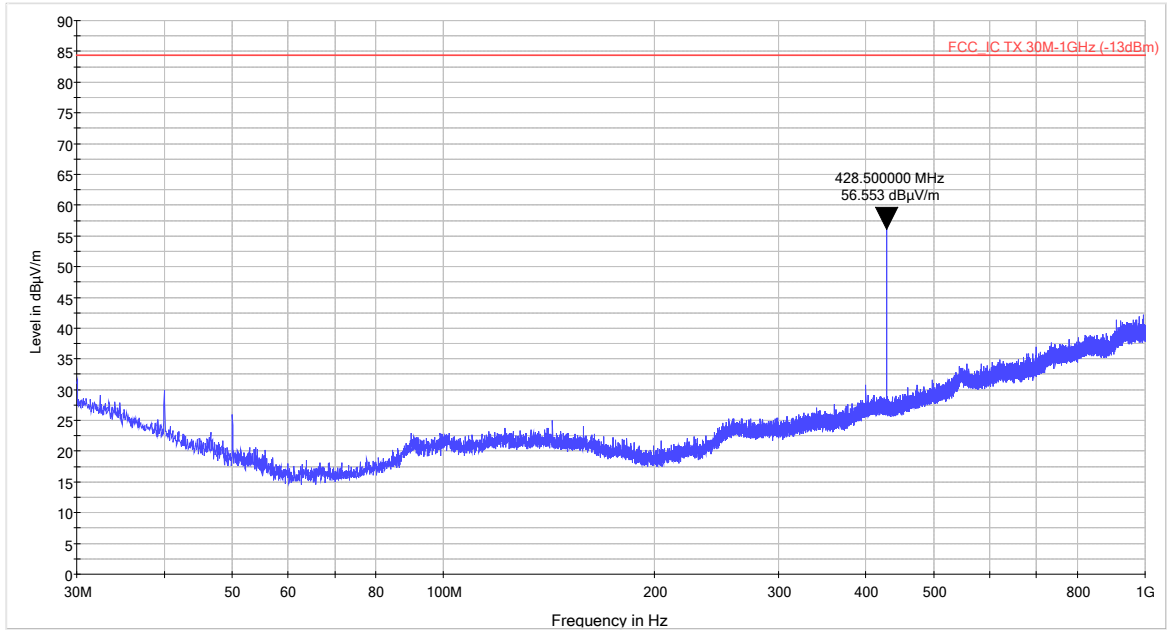

30MHz – 1GHz

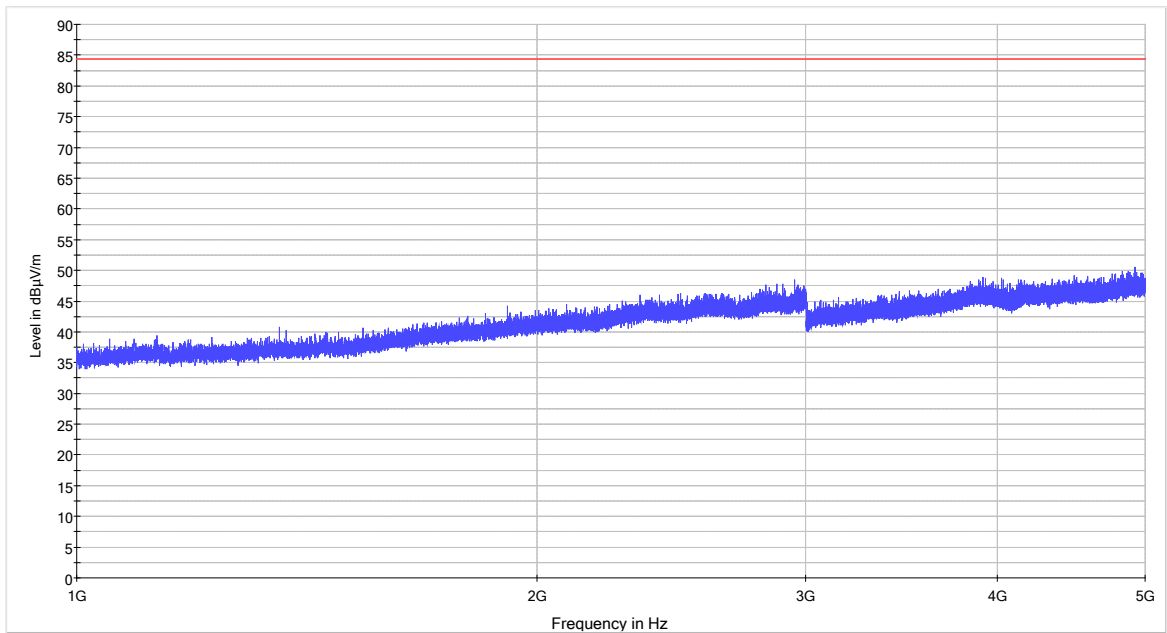

1GHz – 5GHz

Radiated Electric Field Emissions

430.0 MHz

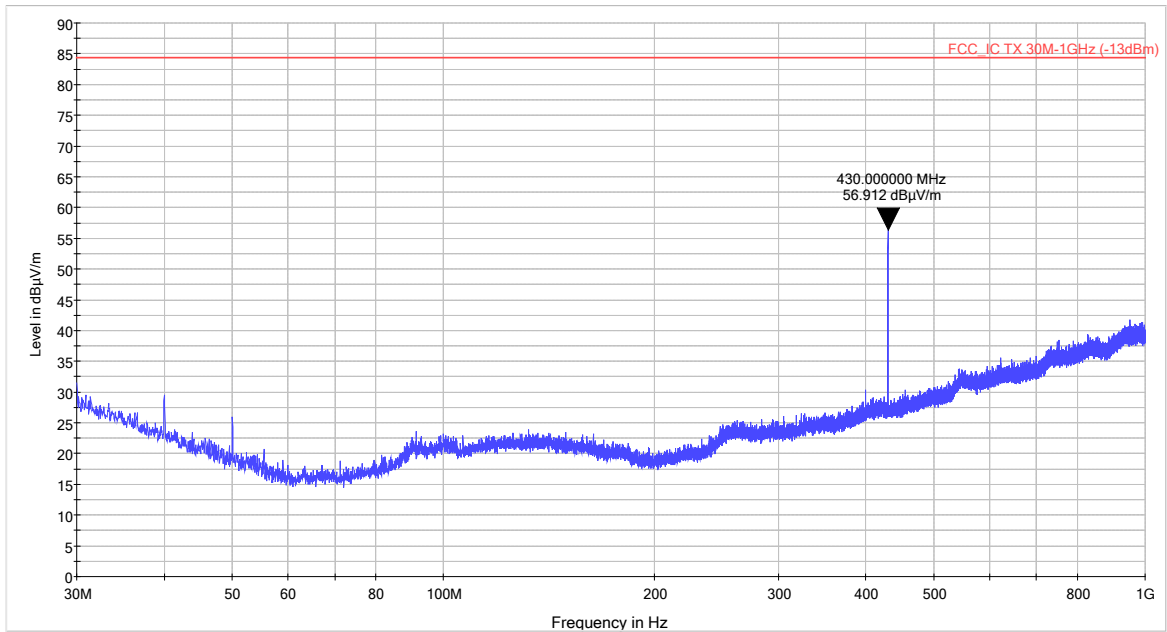

30MHz – 1GHz

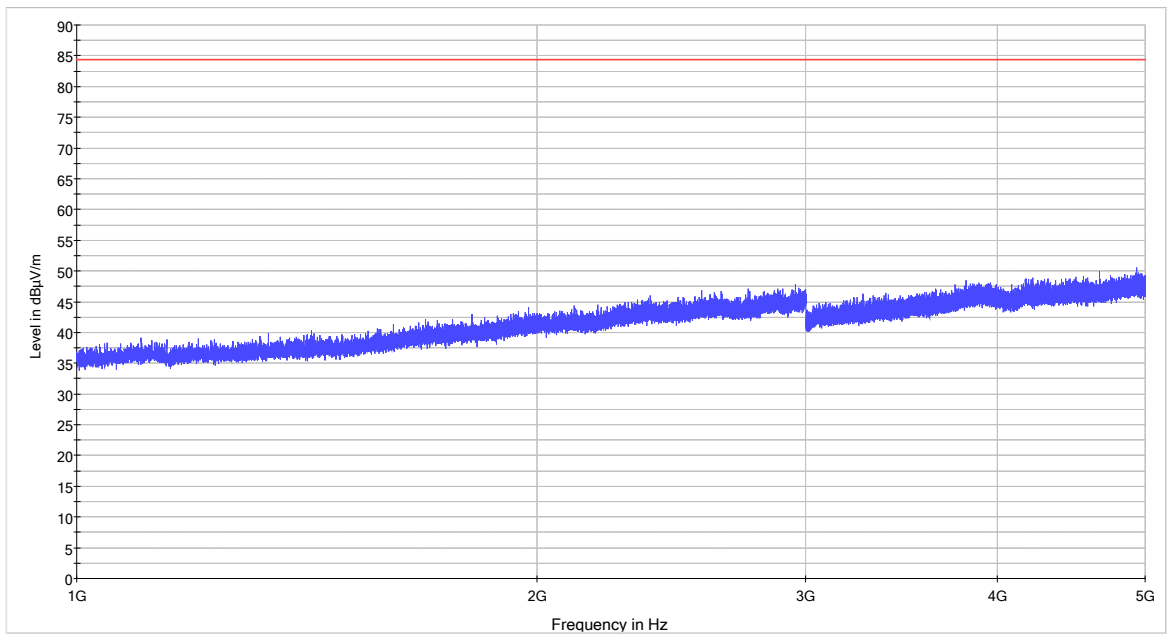

1GHz – 5GHz

A8 Passband Gain & Bandwidth

Test Details:	
Measurement standard	RSS-131 Section 4.2 D.3 Policies + Procedures (k) of KDB 935210 D02 Signal Boosters Certification v02
EUT sample number	S01
Modification state	0
SE in test environment	None
SE isolated from EUT	None
EUT set up	Refer to Appendix C

Frequency MHz	fl	fh	20 dB Bandwidth
427.0 – 430.0	426.552 MHz	430.807 MHz	4.25 MHz

1. See below for plots showing passband gain & bandwidth

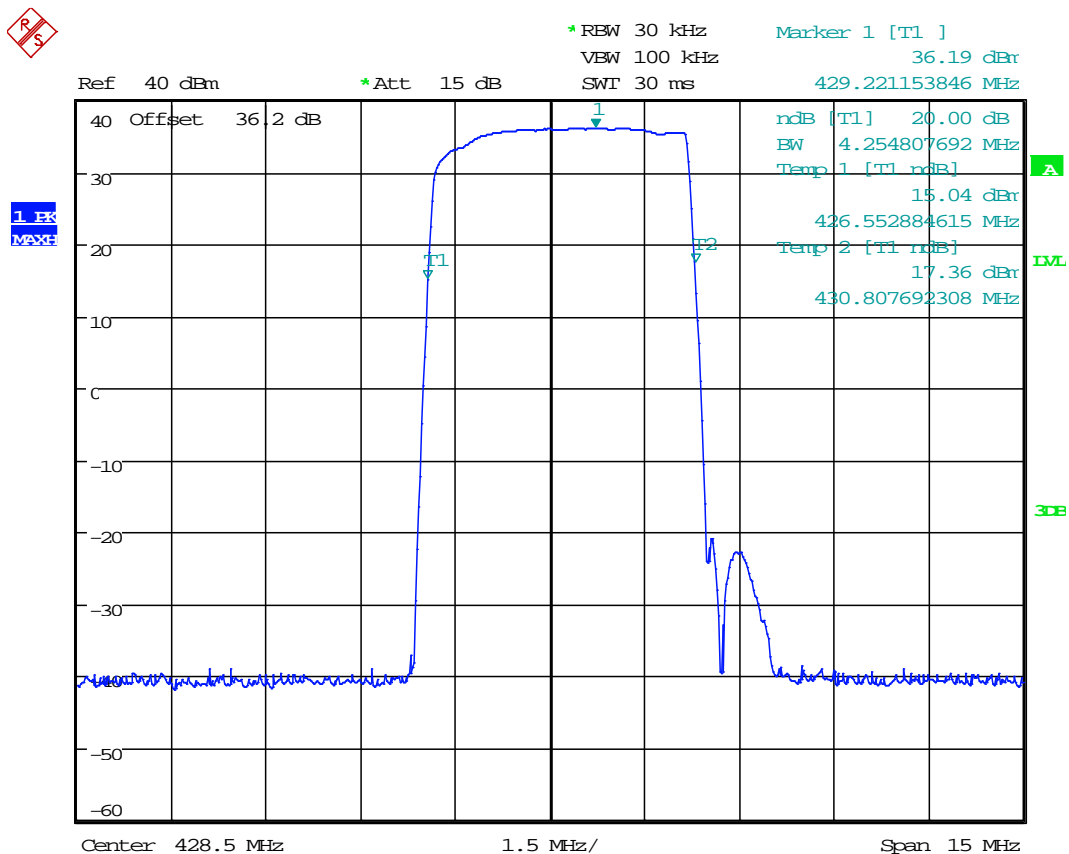

With the aid of a CW Swept signal generator and spectrum analyser, the bandwidth and frequency response of the passband (i.e. at the point where the gain has fallen by 20 dB) is measured. This measurement shows the gain-versus-frequency response of the passband from the midband frequency f_0 of the channel up to at least $f_0 + 250\%$ of the 20 dB bandwidth.

Appendix B:**Downlink Formal Emission Test Results**

Abbreviations used in the tables in this appendix:

Spec	: Specification	ALSR	: Absorber Lined Screened Room
Mod	: Modification	OATS	: Open Area Test Site
EUT	: Equipment Under Test	ATS	: Alternative Test Site
SE	: Support Equipment	Ref	: Reference
L	: Live Power Line	Freq	: Frequency
N	: Neutral Power Line	MD	: Measurement Distance
E	: Earth Power Line	SD	: Spec Distance
Pk	: Peak Detector	Pol	: Polarisation
QP	: Quasi-Peak Detector	H	: Horizontal Polarisation
Av	: Average Detector	V	: Vertical Polarisation
CDN	: Coupling & decoupling network		

B1 RF Gain and Output Power

Test Details:	
Measurement standard	Part 2.1046, Part 90.219(e)(1), RSS-131 Section 4.3
EUT sample number	S01
Modification state	0
SE in test environment	None
SE isolated from EUT	None
EUT set up	Refer to Appendix C

Frequency MHz	Signal Generator input level dBm	Input Cable Loss dB	Level at Spectrum Analyser dBm	Output Cable & Attenuator loss dB	Gain dB	Conducted Output Power dBm	Gain after 10dB input level increase dB
421.0	-48.00	0.20	-0.27	36.2	84.13	35.93	75.05
422.75	-48.00	0.20	-0.06	36.2	84.34	36.14	74.50
424.5	-45.00	0.20	-2.44	36.2	78.96	33.76	68.92

Notes: 1.The signal generator input was increased by 10dBs and the level of the output signal remeasured.

As per D.3 Policies + Procedures (k) of KDB 935210 D02 Signal Boosters Certification v02 the EUT was tested at compression and 10dB into compression to show AGC operation

Frequency	Frequency (MHz)	P _o	Level at Spectrum Analyser (dBm)	Output Cable & Attenuator loss (dB)	Power At Output Point (dBm)
f ₁	423.13	P _{o1}	-3.11	36.2	33.09
f ₂	422.38	P _{o2}	-3.12	36.2	33.08
f ₃	421.63	P _{o3}	-60.55	36.2	-24.35
f ₄	423.88	P _{o4}	-59.39	36.2	-23.19

$$P_{\text{mean}} = P_{o1} + 3\text{dB}$$

$$P_{\text{mean}} = P_{o1} + 3\text{dB}$$

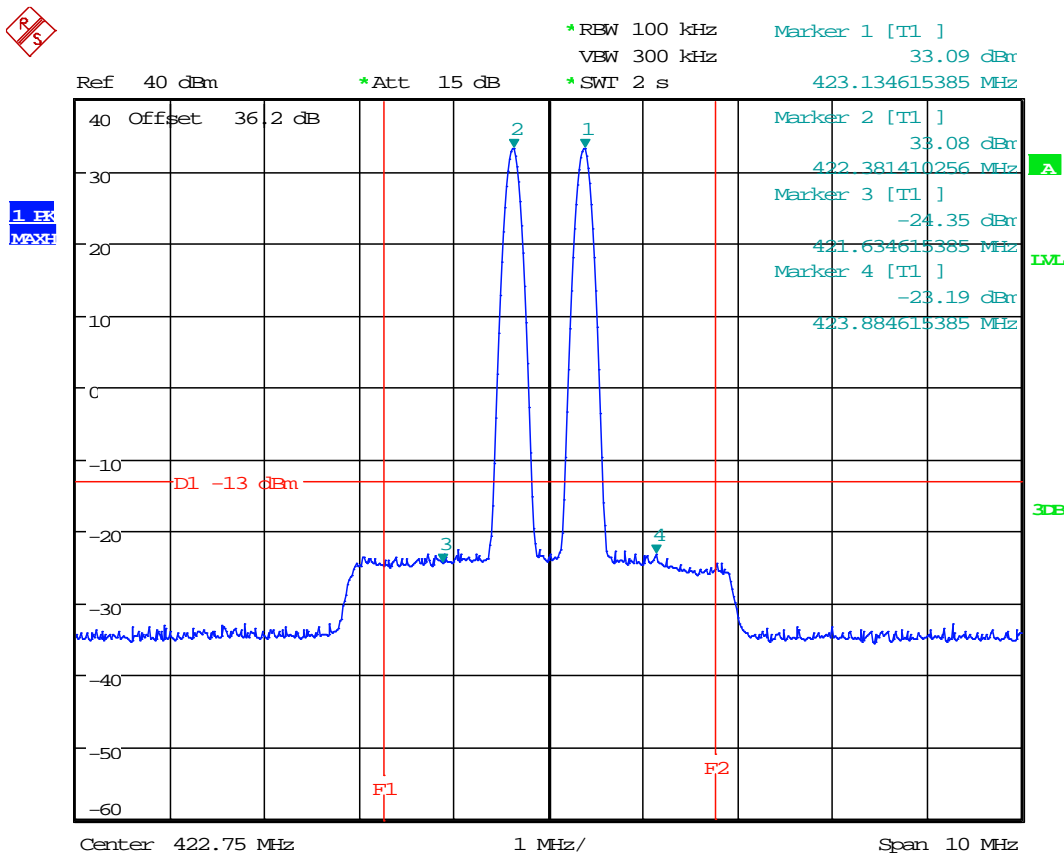

Date: 20.FEB.2014 13:42:36

B2 Amplifier Intermodulation Spurious Emissions

Test Details:	
Measurement standard	Part 2.1053, Part 90.219(e)(3)
EUT sample number	S01
Modification state	0
SE in test environment	None
SE isolated from EUT	None
EUT set up	Refer to Appendix C

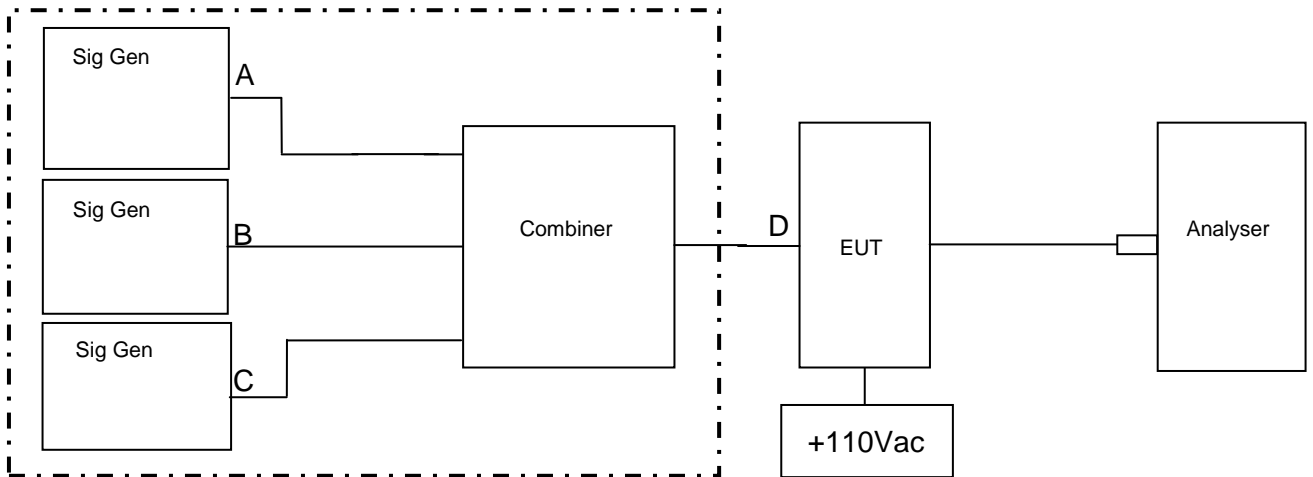

Signal Generator B was varied in frequency to check if intermodulation products were produced.

RF Input Frequency (MHz)			Highest Intermodulation Product Level (dBm)	Limit (dBm)
421.0	422.16	424.5	-22.34 dBm @ 423.3 MHz	-13

Sweep data is shown on the next page:

Results

The EUT was found to comply with the limits

See plots below

As per D.3 Policies + Procedures (k) of KDB 935210 D02 Signal Boosters Certification v02 the EUT was tested at compression and 10dB into compression to show AGC operation

Intermodulation Close View

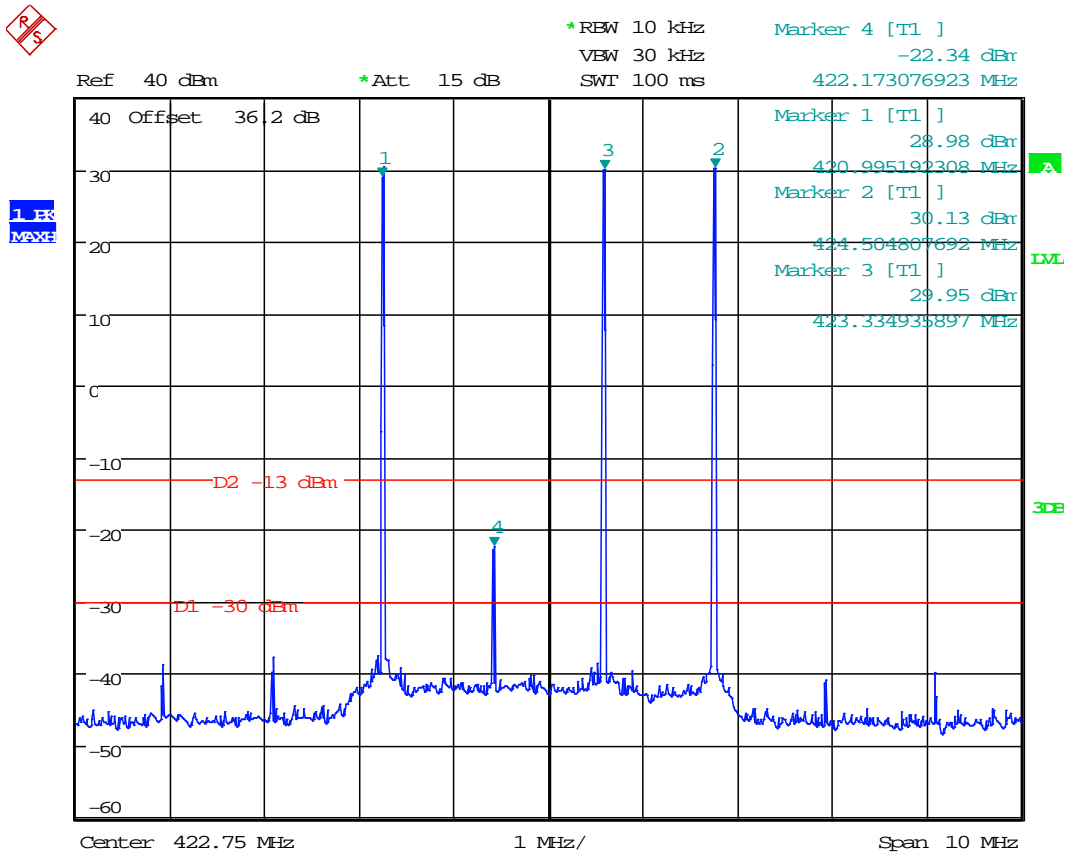

Date: 20.FEB.2014 09:57:16

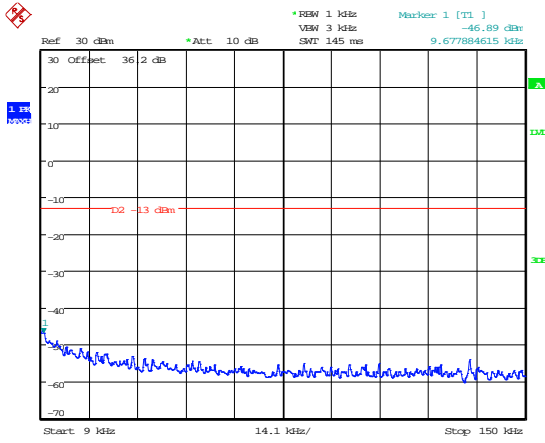

Date: 20.FEB.2014 10:00:38

9kHz - 150kHz

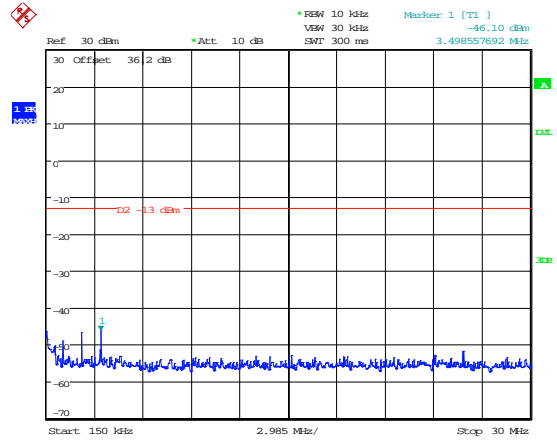

Date: 20.FEB.2014 10:02:05

150kHz - 30MHz

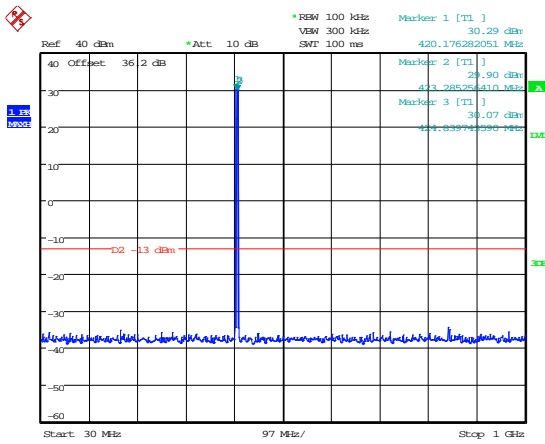

Date: 20.FEB.2014 09:58:33

30MHz - 1GHz

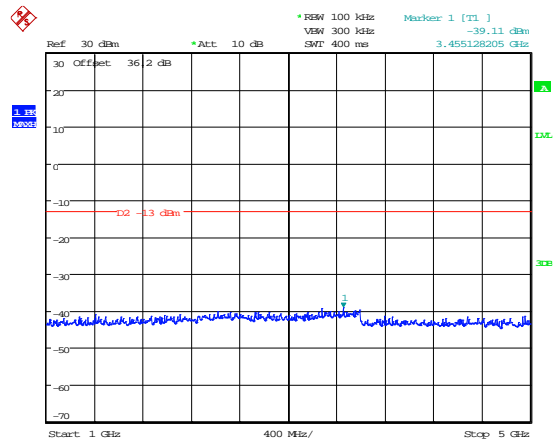

Date: 20.FEB.2014 09:58:58

1GHz - 5GHz

B3 Amplifier Modulated Channel Test

Test Details:	
Measurement standard	Part 2.1049, Part 219(a) Part 90.219(e)(4)(ii), 90.210(c), 90.210(d) and 90.210(e)
EUT sample number	S01
Modification state	0
SE in test environment	None
SE isolated from EUT	None
EUT set up	Refer to Appendix C

Modulation Type	Frequency Of Operation Channel		
	421.0 MHz	422.75 MHz	424.5 MHz
Analogue	10.128 kHz	10.128 kHz	10.128 kHz

As per D.3 Policies + Procedures (k) of KDB 935210 D02 Signal Boosters Certification v02 the EUT was tested at compression and 10dB into compression to show AGC operation, worst case results taken.

421.0 MHz - Analogue Signal Generator and EUT

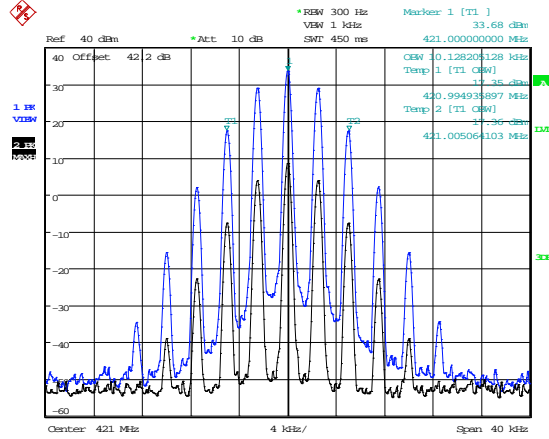

Date: 20.FEB.2014 16:07:31

422.75 MHz - Analogue Signal Generator and EUT

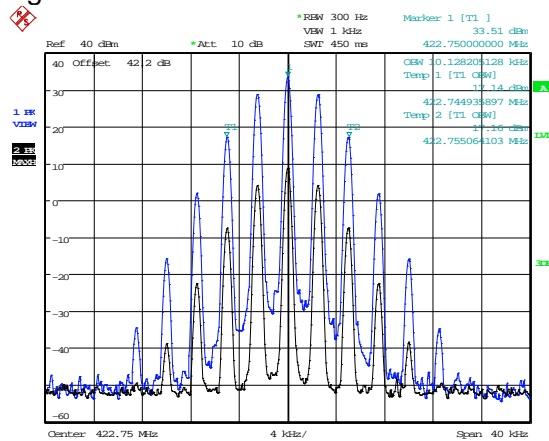

Date: 20.FEB.2014 16:06:03

424.5 MHz - Analogue Signal Generator and EUT

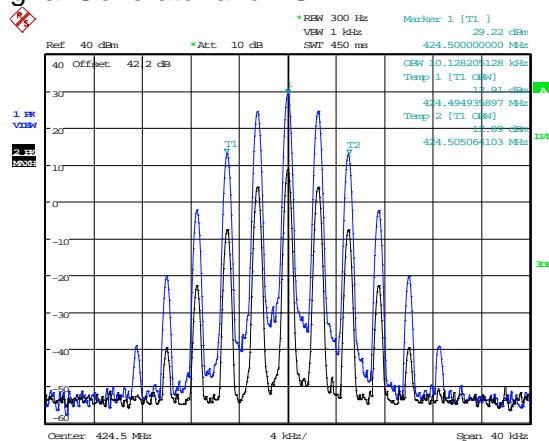

Date: 20.FEB.2014 16:09:07

The above plots depicting the output waveshape show no measurable distortion visible when compared to the input signal.

B4 Spurious Emissions at Antenna Terminals Less than 1MHz

Test Details:	
Measurement standard	Part 2.1053, 90.219(e)(3), 90.210(c), 90.210(d) and 90.210(e)
EUT sample number	S01
Modification state	0
SE in test environment	None
SE isolated from EUT	None
EUT set up	Refer to Appendix C

Modulation Type	Bandedge	Carrier Frequency (MHz)	Max Level @ bandedge (dBm)
Analogue	Lower	421.0125	-46.59
	Upper	424.4875	-49.45

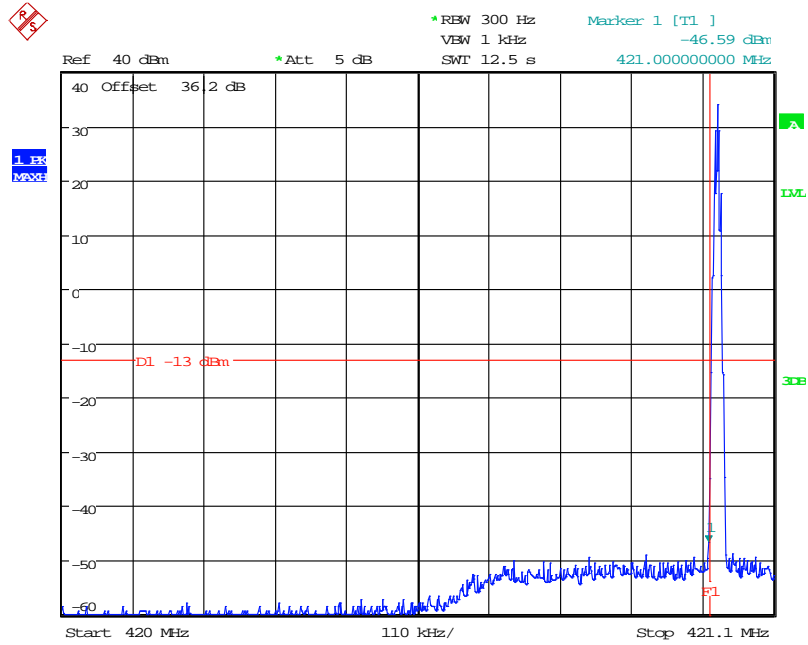

Date: 5.MAR.2014 11:27:27

Analogue Signal – Lower Bandedge

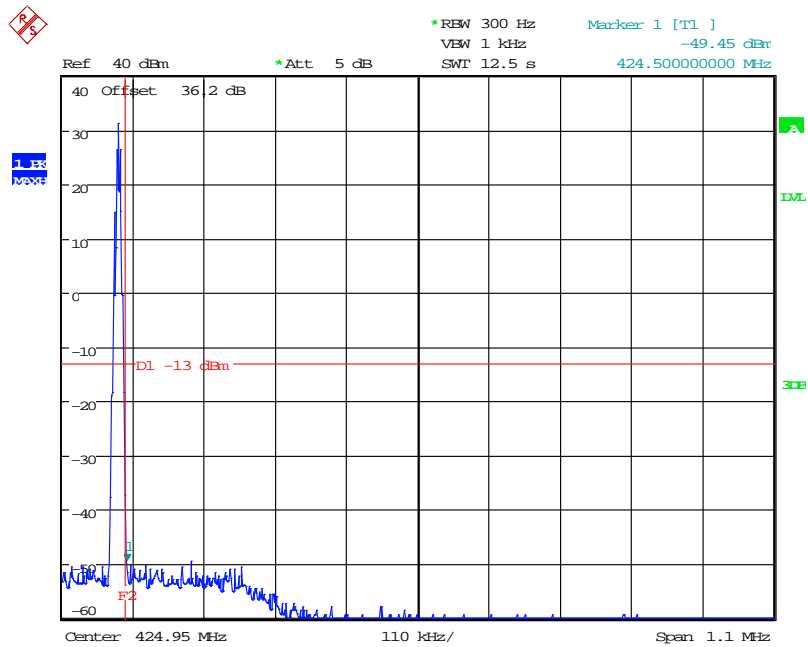

Date: 5.MAR.2014 11:33:32

Analogue Signal – Upper Bandedge

B5 Spurious Emissions at Antenna Terminals Greater than 1MHz

Test Details:	
Measurement standard	Part 2.1053, 90.219(e)(3)
EUT sample number	S01
Modification state	0
SE in test environment	None
SE isolated from EUT	None
EUT set up	Refer to Appendix C

Bottom Channel

Frequency Range (MHz)	Freq. of Emission (MHz)	Measured Level (dBm)	Attenuator & Cable Losses (dB)	Spurious Emission Level (dBm)	Limit dBm
9 kHz - 5 GHz	No Significant Emissions Within 20 dB of the Limit				-13

Middle Channel

Frequency Range (MHz)	Freq. of Emission (MHz)	Measured Level (dBm)	Attenuator & Cable Losses (dB)	Spurious Emission Level (dBm)	Limit dBm
9 kHz - 5 GHz	No Significant Emissions Within 20 dB of the Limit				-13

Top channel

Frequency Range (MHz)	Freq. of Emission (MHz)	Measured Level (dBm)	Attenuator & Cable Losses (dB)	Spurious Emission Level (dBm)	Limit dBm
9 kHz - 5 GHz	No Significant Emissions Within 20 dB of the Limit				-13

Limit is determined by the outermost step of the emissions mask and is calculated as follows:

At least $43 + 10 \log P$ dB

$$(10\log P_{\text{watts}}) - (43 + 10\log (P_{\text{watts}} * 1000)) = \text{LIMIT} = -13 \text{ dBm}$$

Result

The EUT was found to comply with the limits

Spurious Emissions at Antenna Terminals Greater than 1MHz

421.0 MHz

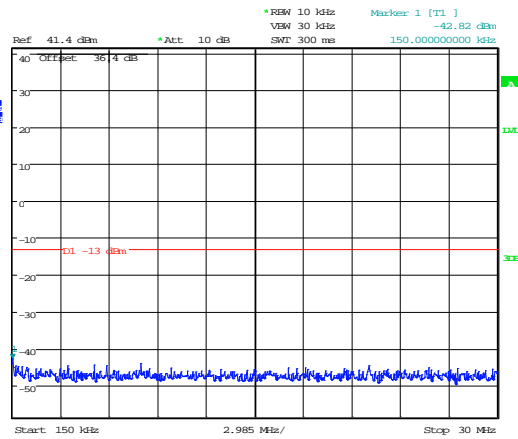
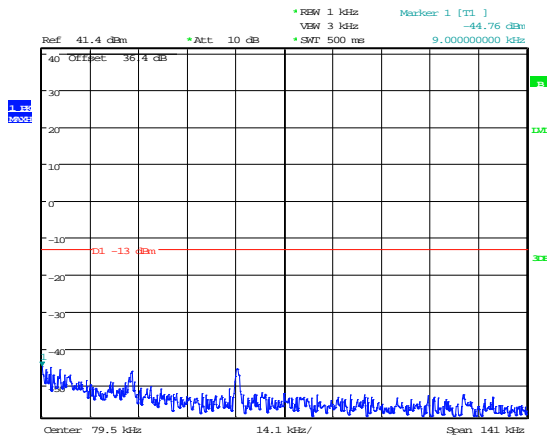

Date: 19.FEB.2014 15:58:41

Date: 19.FEB.2014 12:04:11

9kHz -150kHz

150kHz – 30MHz

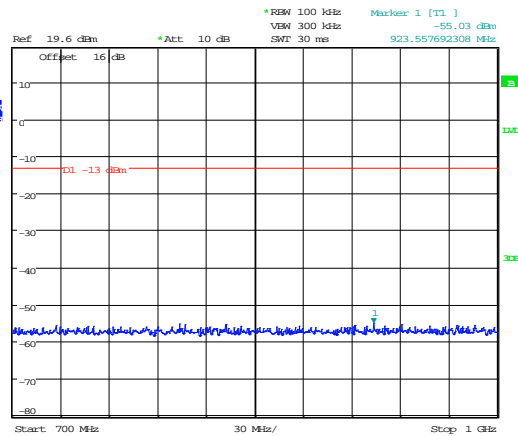
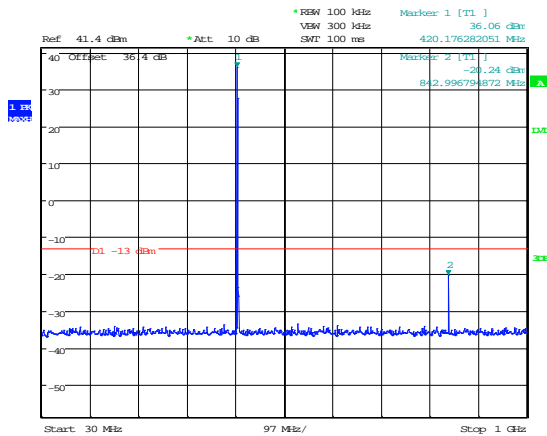

Date: 19.FEB.2014 11:54:30

Date: 19.FEB.2014 16:42:01

30MHz – 1GHz

700MHz – 1 GHz with High pas filter

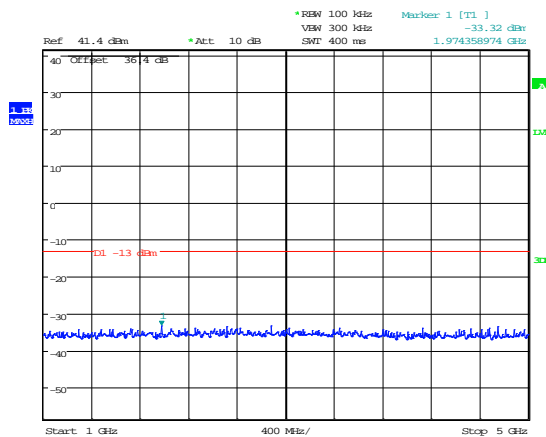

Date: 19.FEB.2014 11:56:23

1GHz – 5GHz

Spurious Emissions at Antenna Terminals Greater than 1MHz

422.75 MHz

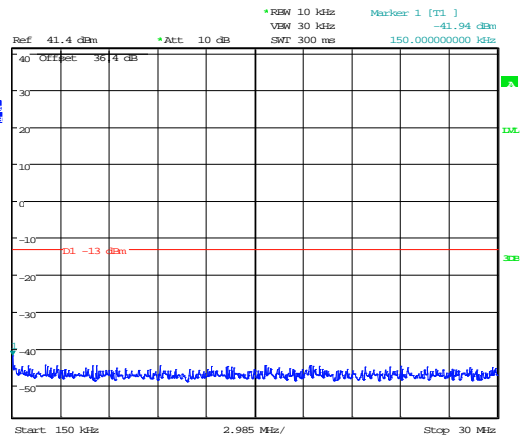
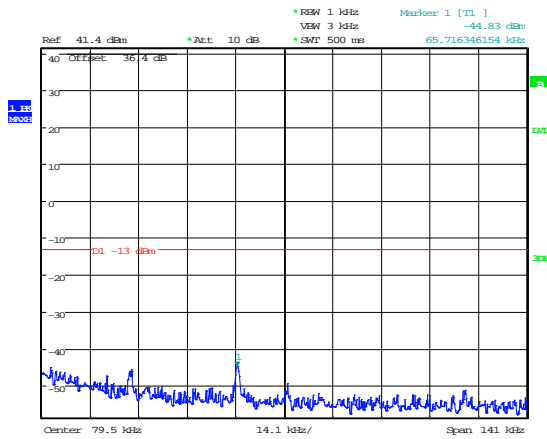

Date: 19.FEB.2014 16:00:13

Date: 19.FEB.2014 12:09:53

9kHz -150kHz

150kHz – 30MHz

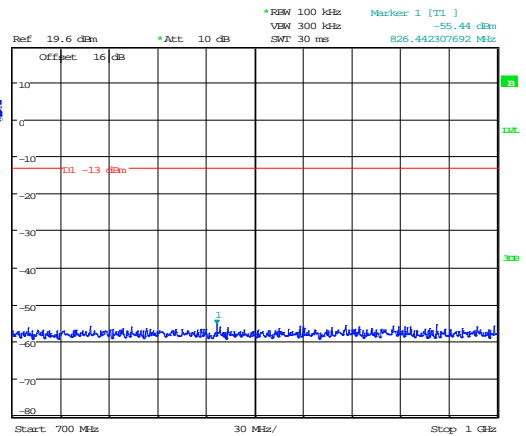
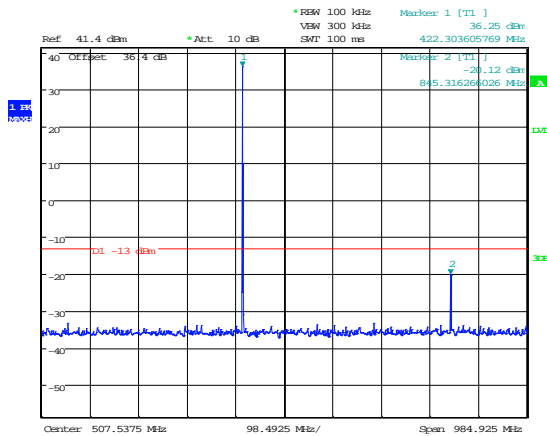

Date: 19.FEB.2014 12:10:36

Date: 19.FEB.2014 16:43:57

30MHz – 1GHz

700MHz – 1 GHz with High pas filter

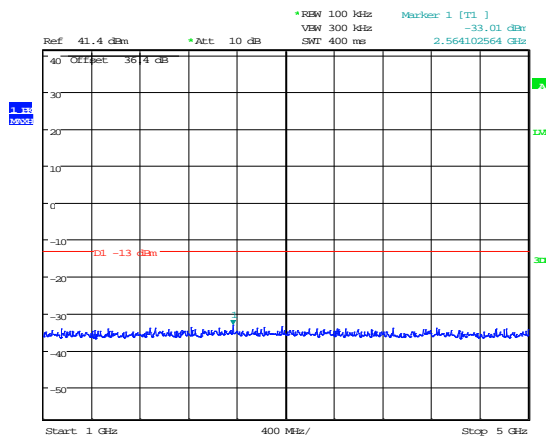

Date: 19.FEB.2014 12:11:13

1GHz – 5GHz

Spurious Emissions at Antenna Terminals Greater than 1MHz

424.5 MHz

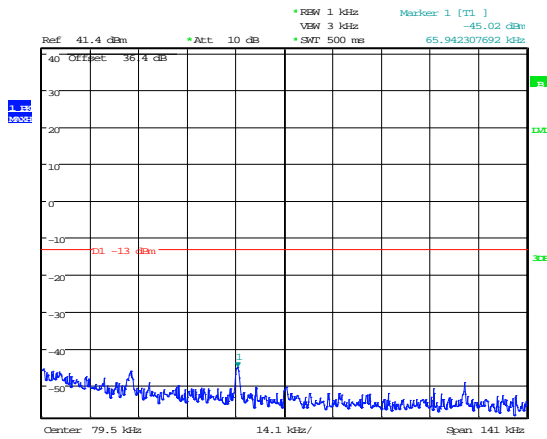

Date: 19.FEB.2014 16:00:46

9kHz -150kHz

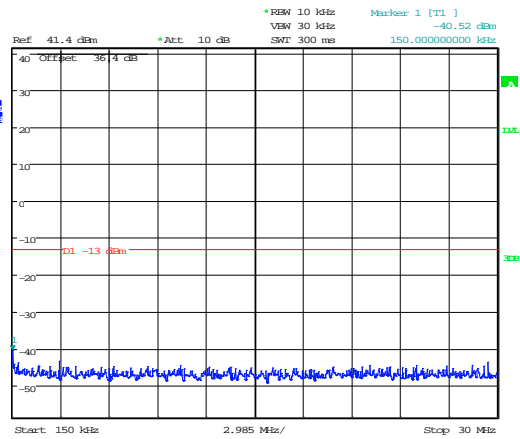

Date: 19.FEB.2014 12:18:17

150kHz – 30MHz

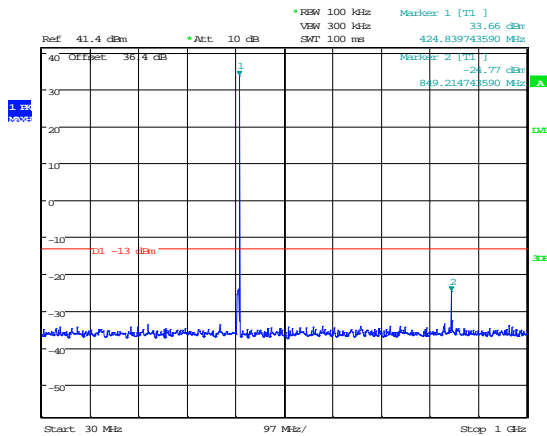

Date: 19.FEB.2014 12:24:01

30MHz – 1GHz

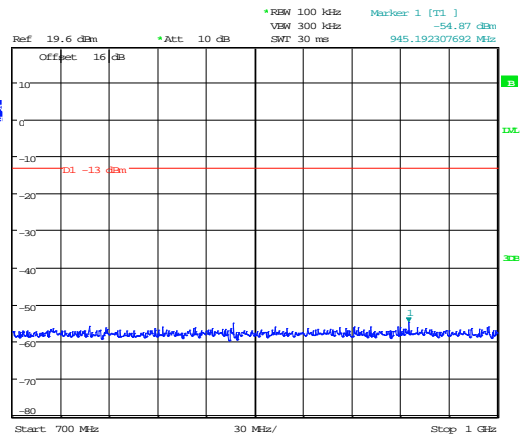

Date: 19.FEB.2014 16:47:48

700MHz – 1 GHz with High pas filter

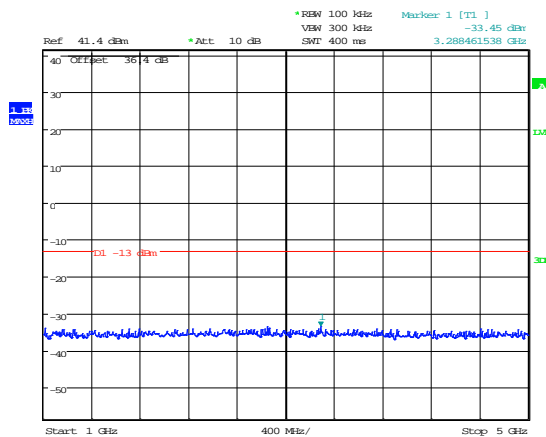

Date: 19.FEB.2014 12:22:54

1GHz – 5GHz

B6 Noise at Antenna Terminals

Test Details:	
Measurement standard	90.219(e)(2), 90.219(e)(3)
EUT sample number	S01
Modification state	0
SE in test environment	None
SE isolated from EUT	None
EUT set up	Refer to Appendix C

Compliance with these levels will be deemed satisfaction of the good engineering practice requirement. In a 10 kHz measurement bandwidth:

- (1) the ERP of noise within the signal booster passband should not exceed -43dBm;
- and
- (2) the ERP of noise on spectrum more than 1 MHz outside of the signal booster passband should not exceed -70 dBm.
- (3) The noise figure of a signal booster must not exceed 9 dB in either direction

See appendix E for declaration of good engineering practice

IN BAND AMPLIFIER NOISE

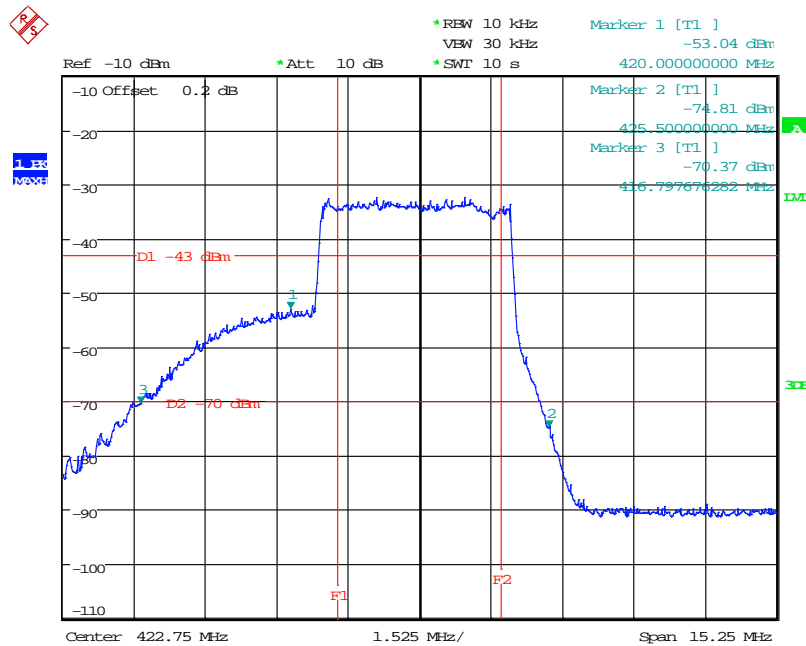

Date: 20.FEB.2014 15:32:42

Signal booster noise figure

Test equipment set up:-

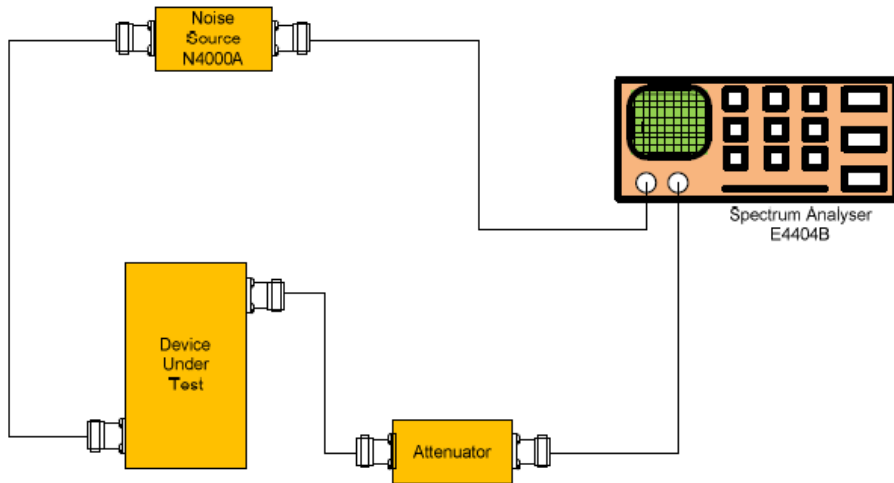

Result

Plots for noise figure, taken with the 18MHz filter applied at maximum gain with 70dB external attenuators in the test set up

Frequency (MHz)	Noise Figure dB
422.75	4.1018 dB

General notes about measurement setup:

- 1) The spectrum analyser has the noise figure measurement personality enabled.

Noise Figure – 428.5 MHz

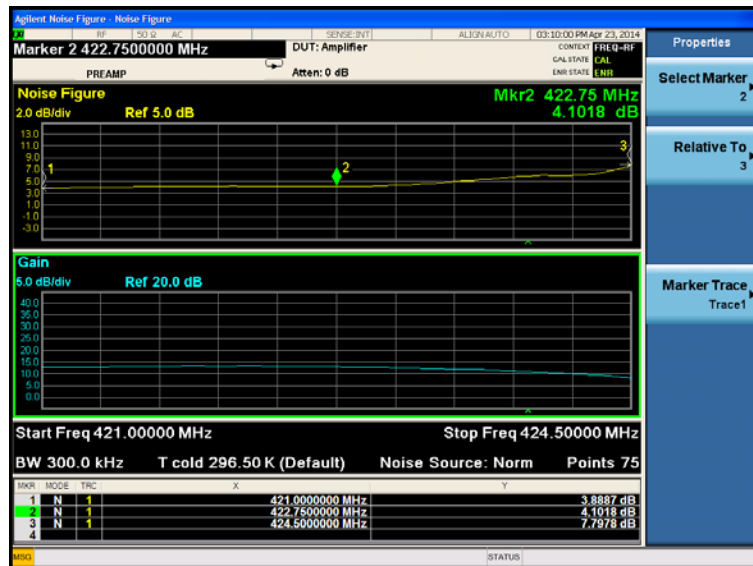

B7 Radiated Electric Field Emissions

Preliminary scans were performed using a peak detector with the RBW = 100kHz. The radiated electric field emission test applies to all spurious and harmonic emissions. The EUT was set to transmit as required.

The following test site was used for final measurements as specified by the standard tested to:

3m open area test site : 3m alternative test site :

The effect of the EUT set-up on the measurements is summarised in note (c) below.

Test Details:	
Measurement standard	Title 47 of the CFR: Part 2.1053, RSS-131 Section 4.3.2
Frequency range	30MHz - 5GHz
EUT sample number	S01
Modification state	0
SE in test environment	None
SE isolated from EUT	None
EUT set up	Refer to Appendix C
Photographs (Appendix F)	1 & 2

Bottom Frequency

FREQUENCY RANGE	FREQ. (MHz)	ERP/EIRP (dBm)	LIMIT (dBm)
30MHz - 5GHz	No Significant Emissions Within 20 dB of Limit		-13

Middle Frequency

FREQUENCY RANGE	FREQ. (MHz)	ERP/EIRP (dBm)	LIMIT (dBm)
30MHz - 5GHz	No Significant Emissions Within 20 dB of Limit		-13

Top Frequency

FREQUENCY RANGE	FREQ. (MHz)	ERP/EIRP (dBm)	LIMIT (dBm)
30MHz - 5GHz	No Significant Emissions Within 20 dB of Limit		-13

Result

The EUT was found to comply with the limits

Notes:

1. Emissions Checked up to 10 times Fc.
2. The unit was mounted on a turntable and rotated through 360° and in 3 orthogonal planes to find the worst case emission.
3. For Frequencies below 1 GHz, RBW = 120 kHz, testing was performed with CISPR16 compliant test receiver with QP detector. Above 1 GHz tests were performed using a spectrum analyser using the following settings:

Peak Detector RBW = 1MHz; VBW = ≥RBW

4. Limit is determined as the outermost step of the emissions mask and is calculated as follows.

At least 43 + 10 log P dB

$$(10\log P_{\text{watts}}) - (43 + 10\log (P_{\text{watts}} * 1000)) = \text{LIMIT} = -13 \text{ dBm}$$

The upper and lower frequency of the measurement range was decided according to 47 CFR Part 2.1057.

- (a) Where results have been measured at one distance, and a signal level displayed at another, the results have been extrapolated using the following formula:

$$\text{Extrapolation (dB)} = 20 \log_{10} \left(\frac{\text{measurement distance}}{\text{specification distance}} \right)$$

- (b) The levels may have been rounded for display purposes.
- (c) The following table summarises the effect of the EUT operating mode, internal configuration and arrangement of cables / samples on the measured emission levels :

	See (i)	See (ii)	See (iii)	See (iv)
Effect of EUT operating mode on emission levels	✓			
Effect of EUT internal configuration on emission levels	✓			
Effect of Position of EUT cables & samples on emission levels	✓			
(i) Parameter defined by standard and / or single possible, refer to Appendix D (ii) Parameter defined by client and / or single possible, refer to Appendix D (iii) Parameter had a negligible effect on emission levels, refer to Appendix D (iv) Worst case determined by initial measurement, refer to Appendix D				

Radiated Electric Field Emissions

421.0 MHz

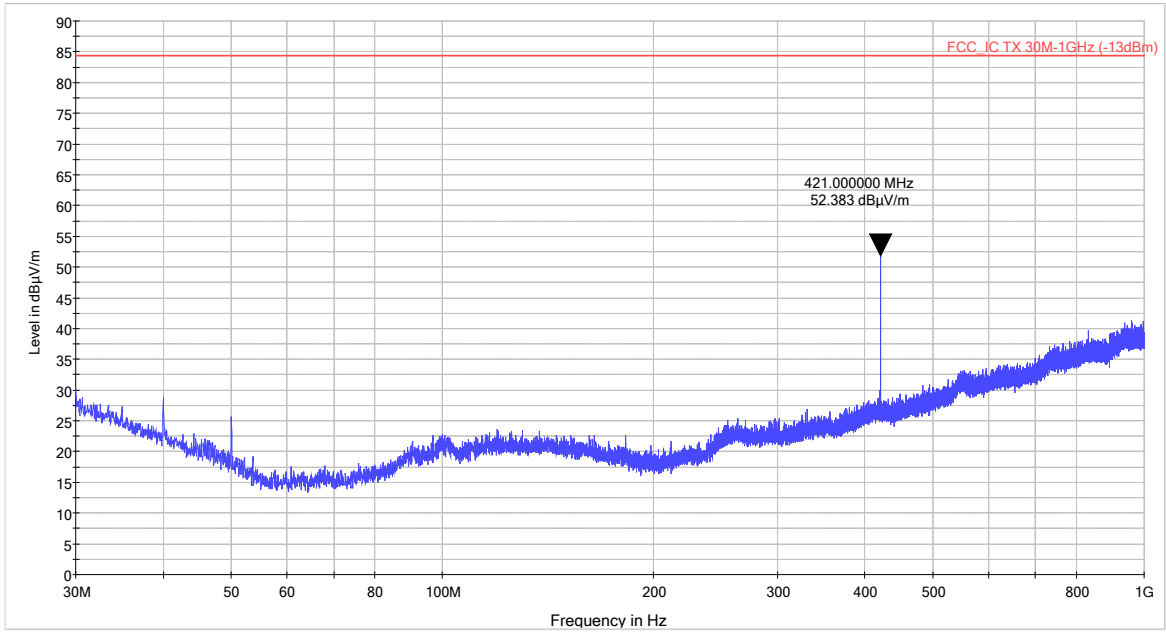

30MHz – 1GHz

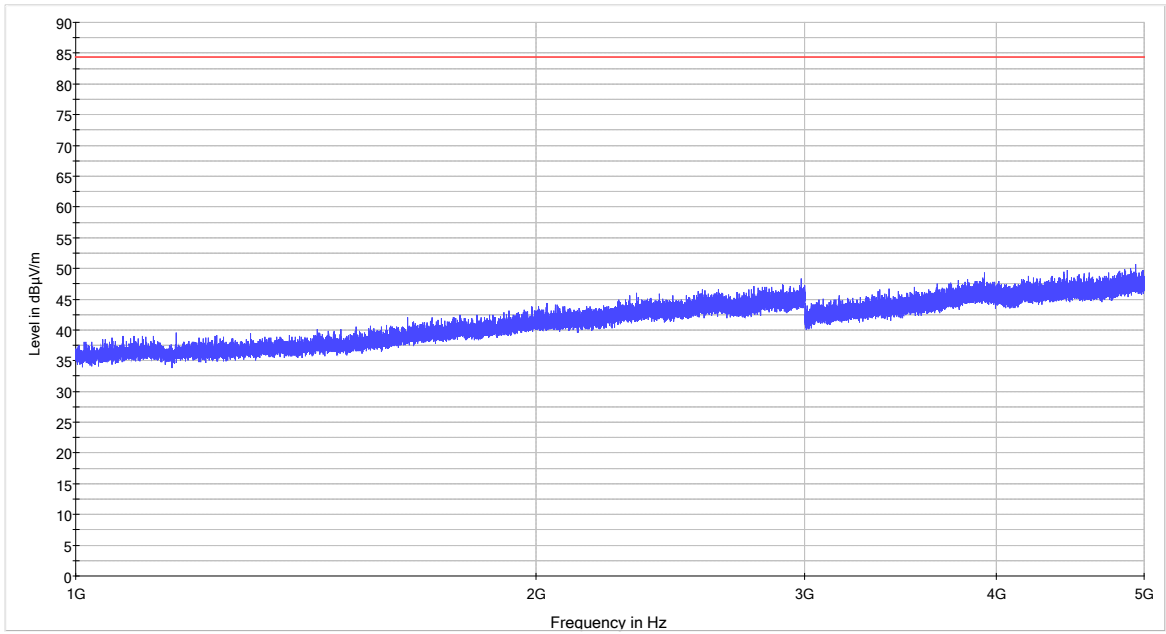

1GHz – 5GHz

Radiated Electric Field Emissions

422.75 MHz

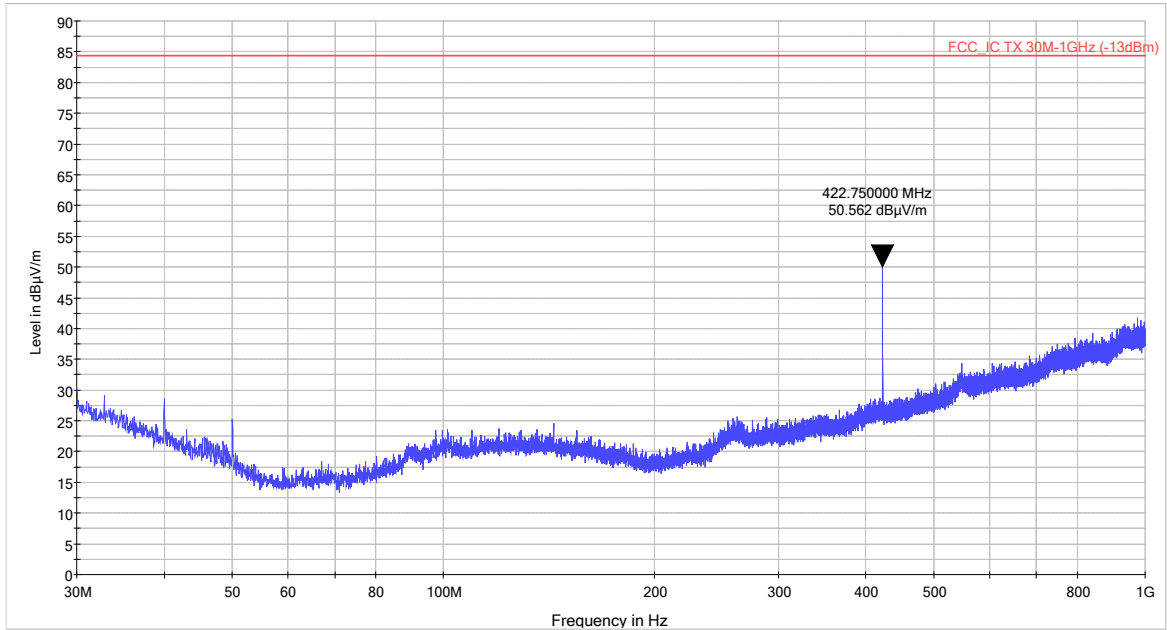

30MHz – 1GHz

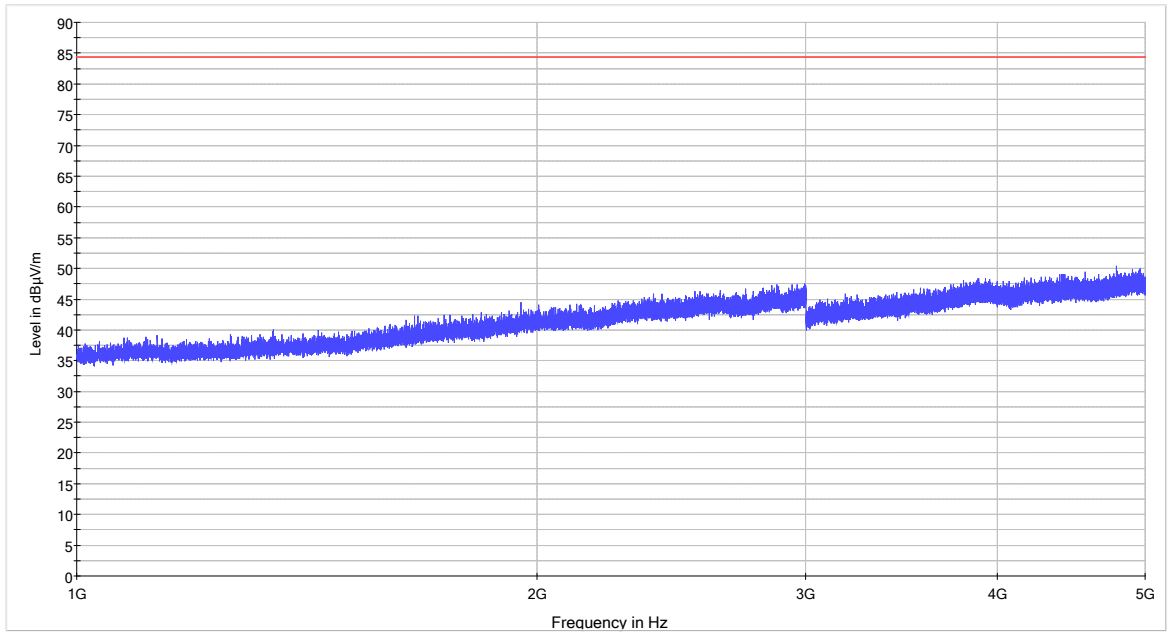

1GHz – 5GHz

Radiated Electric Field Emissions

424.5 MHz

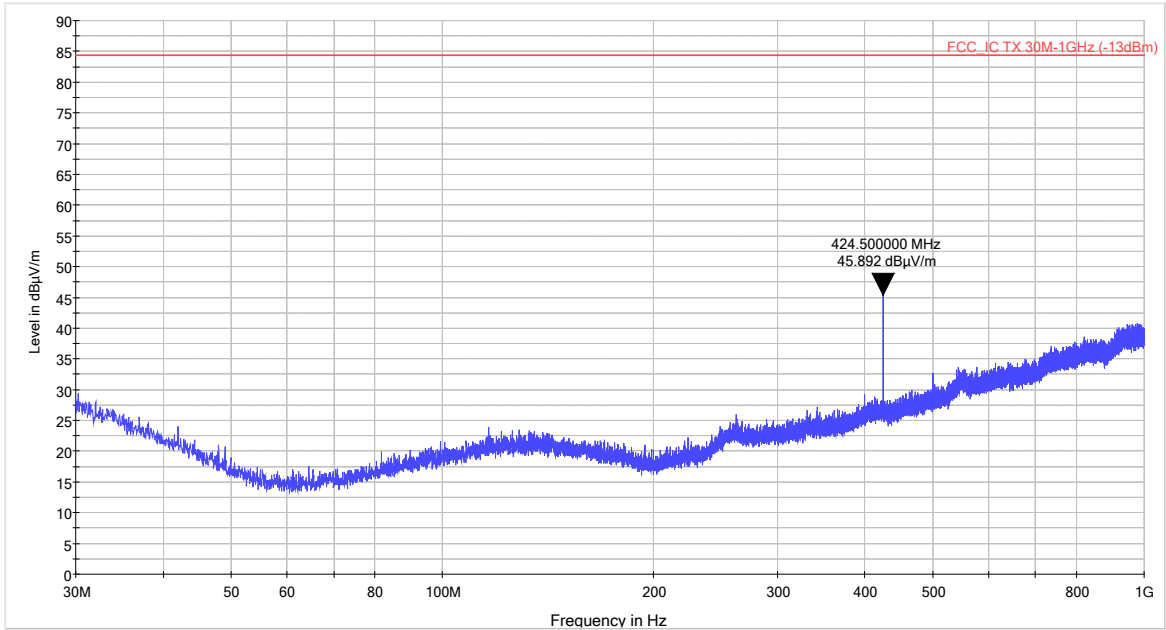

30MHz – 1GHz

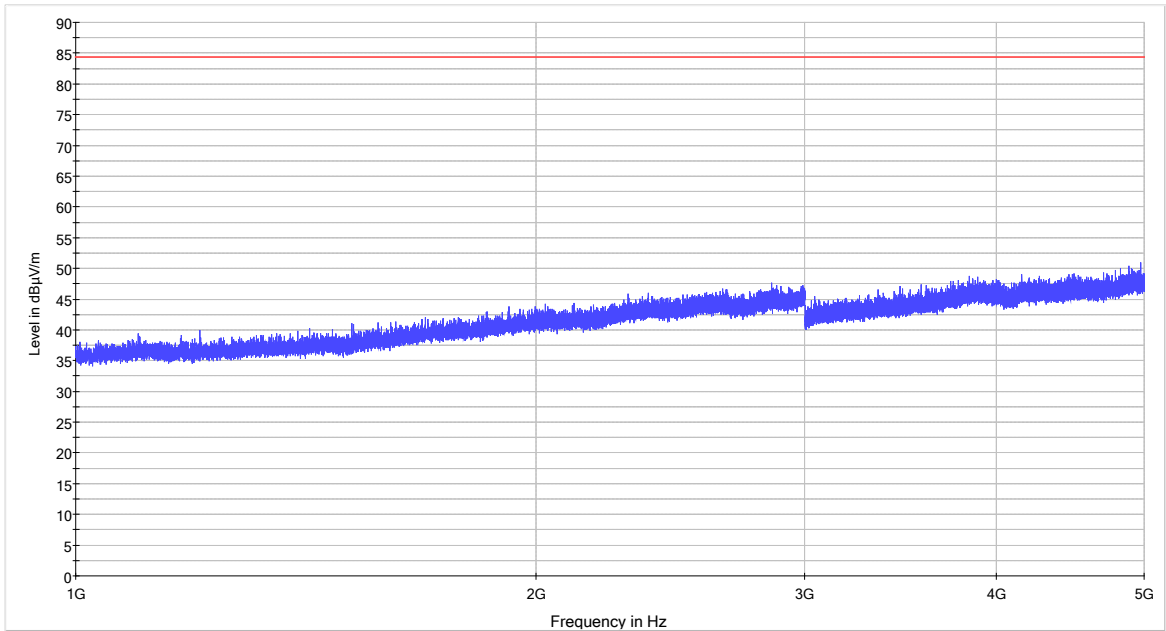

1GHz – 5GHz

B8 Passband Gain & Bandwidth

Test Details:	
Measurement standard	RSS-131 Section 4.2 D.3 Policies + Procedures (k) of KDB 935210 D02 Signal Boosters Certification v02
EUT sample number	S01
Modification state	0
SE in test environment	None
SE isolated from EUT	None
EUT set up	Refer to Appendix C

Frequency MHz	fl	fh	20 dB Bandwidth
421.0 – 424.5 MHz	420.4154230 MHz	424.769230 MHz	4.254 MHz

2. See below for plots showing passband gain & bandwidth

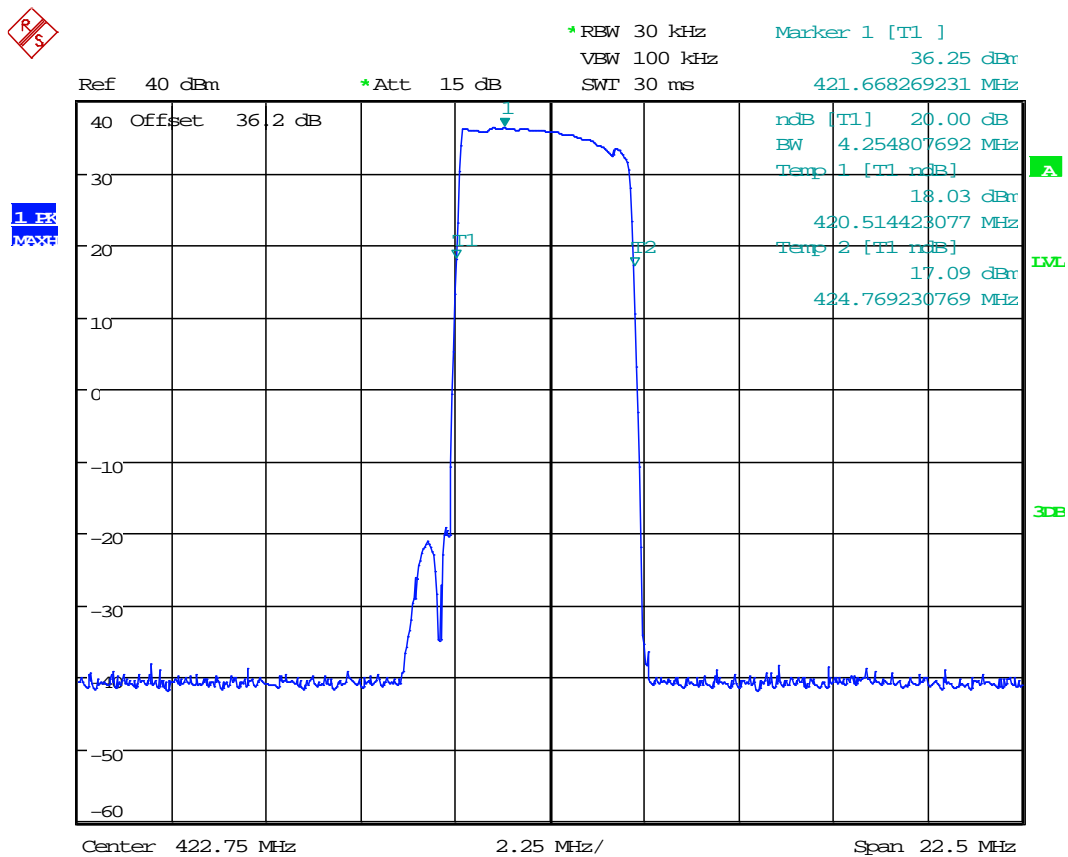

With the aid of a CW Swept signal generator and spectrum analyser, the bandwidth and frequency response of the passband (i.e. at the point where the gain has fallen by 20 dB) is measured. This measurement shows the gain-versus-frequency response of the passband from the midband frequency f_0 of the channel up to at least $f_0 + 250\%$ of the 20 dB bandwidth.

Appendix C:**Additional Test and Sample Details**

This appendix contains details of:

1. The samples submitted for testing.
2. Details of EUT operating mode(s)
3. Details of EUT configuration(s) (see below).
4. EUT arrangement (see below).

Throughout testing, the following numbering system is used to identify the sample and it's modification state:

Sample No: Sxx Mod w

where:

xx	= sample number	eg. S01
w	= modification number	eg. Mod 2

The following terminology is used throughout the test report:

Support Equipment (SE) is any additional equipment required to exercise the EUT in the applicable operating mode. Where relevant SE is divided into two categories:

SE in test environment: The SE is positioned in the test environment and is not isolated from the EUT (e.g. on the table top during REFE testing).

SE isolated from the EUT: The SE is isolated via filtering from the EUT. (e.g. equipment placed externally to the ALSR during REFE testing).

EUT configuration refers to the internal set-up of the EUT. It may include for example:

- Positioning of cards in a chassis.
- Setting of any internal switches.
- Circuit board jumper settings.
- Alternative internal power supplies.

Where no change in EUT configuration is **possible**, the configuration is described as "single possible configuration".

EUT arrangement refers to the termination of EUT ports / connection of support equipment, and where relevant, the relative positioning of samples (EUT and SE) in the test environment.

For further details of the test procedures and general test set ups used during testing please refer to the related document "EMC Test Methods - An Overview", which can be supplied by TRaC Global upon request.

C1) Test samples

The following samples of the apparatus were submitted by the client for testing :

Sample No.	Description	Identification
S01	D-CSR-3604-4	Not Available

The following samples of apparatus were submitted by the client as host, support or drive equipment (auxiliary equipment):

Sample No.	Description	Identification

The following samples of apparatus were supplied by TRaC Global as support or drive equipment (auxiliary equipment):

Identification	Description

C2) EUT Operating Mode During Testing.

During testing, the EUT was exercised as described in the following tables :

Test	Description of Operating Mode
All tests detailed in this report	Receiving a signal to ensure EUT is operating a maximum gain and maximum output power.

C3) EUT Configuration Information.

The EUT was submitted for testing in one single possible configuration.

C4) List of EUT Ports

The tables below describe the termination of EUT ports:

Sample : S01
Tests : Conducted

Port	Description of Cable Attached	Cable length	Equipment Connected
Mobile	Coaxial	>1m	Sig Gen or 50Ω Load
Base	Coaxial	>1m	Sig Gen or 50Ω Load
Power	Mains Cable	1m	110Vac

Sample : S01
Tests : Radiated Emissions

Port	Description of Cable Attached	Cable length	Equipment Connected
Mobile	Coaxial	>1m	Sig Gen or 50Ω Load
Base	Coaxial	>1m	Sig Gen or 50Ω Load
Power	Mains Cable	1m	110Vac

* Only connected during setup.

C5 Details of Equipment Used

TRaC No	Equipment Type	Equipment Description	Manufacturer	Last Cal Calibration
UH028	UHALP 9108	Log Periodic Ant	Schwarbeck	08/07/2013
UH029	VHBA 9123	Bicone Antenna	Schwarbeck	19/08/2013
UH093	CBL6112B	Bilog	Chase	08/07/2013
UH191	CBL611/A	Bilog	Chase	13/12/2012
UH281	FSU46	Spectrum Analyser	R&S	06/03/2013
UH387	ATS	Chamber 1	Rainford EMC	04/07/2013
UH388	ATS	Chamber 2	Rainford EMC	04/07/2013
UH396	ENV216	Lisn	R&S	30/04/2013
UH403	ESCI 7	Recevier	R&S	12/08/2013
UH405	FSU26	Spectrum Analyser	R&S	20/03/2013
UH420	CBL6112	Bilog	Chase	06/07/2012
L007	hfh2	Loop Antenna	R&S	17/10/2013
L138	3115	1-18GHz Horn	EMCO	17/10/2013
L139	3115	1-18GHz Horn	EMCO	20/09/2013
L176	2042	Signal Generator	Marconi	20/11/2012
L254	2042	Signal Generator	Marconi	19/12/2012
L193	VHA 9103 balu	Bicone Antenna	Chase	19/06/2012
L203	UPA6108	Log Periodic Ant	Chase	19/06/2012
L263/A	20240-20	Horn 18-26GHz	Flann	17/11/2011
L290	CBL611/A	Bilog	Chase	13/12/2012
L572	8449B	Pre Amp	Agilent	12/12/2012
REF916	SMBV100A	Signal Generator	R&S	23/07/2012
REF940	ATS	Radio Chamber - PP	Rainford EMC	09/07/2013

Appendix D:

Additional Information

No additional information is included within this test report.

Appendix E:**Good Engineering Information from Manual****Compliance with FCC deployment rule regarding the radiation of noise**

Good engineering practice must be used in regard to the signal booster's noise radiation. Thus, the gain of the signal booster should be set so that the ERP of the output noise from the signal booster should not exceed the level of -43 dBm in 10 kHz measurement bandwidth.

In the event that the noise level measured exceeds the aforementioned value, the signal booster gain should be decreased accordingly.

In general, the ERP of noise on a spectrum more than 1 MHz outside of the pass band should not exceed -70 dBm in a 10 kHz measurement bandwidth.

The 3604 A284 Series Repeater has a noise level of -53 dBm in 10 kHz measurement at 1 MHz spectrum outside the passband of the signal booster and an *in-band* noise level at around -34 dBm in a 10 kHz bandwidth. Therefore, the noise at the antenna input port should be calculated based on equation (3).

Equation (3) - Input Noise to service antenna

Input Noise to service antenna:

$$-53 \text{ dBm} + \text{Service Antenna gain} - \text{Antenna splitter losses in dB} - \text{cable loss in dB}$$

Example:

Signal booster connected to 10 service antennas with a 100m long ½ inch cable.

Losses of such a cable with the connectors = ~ 11dB

Gain = ~ 2 dBi

Assuming 10 service antennas: antenna splitter losses = 11 dB

Based on equation (3) Input antenna noise (to the antenna) = $-53+2-11-11=-73$ dBm

The inband input noise to the antenna should be $-34+2-11-11=-54$ dbm

NOTE: In this example there is no need to add an external band pass filter to attenuate the out of band noise.

Conclusion:

Good engineering practice requires that in general when the out of band noise measured at the service antenna input is more than -70 dBm per 10 kHz measurement bandwidth, an external band pass filter should be added to attenuate the out of band noise level.

Appendix G:

Photographs and Figures

The following photographs were taken of the test samples:

1. Radiated electric field emissions arrangement: D-CSR-3604-4 front view.
2. Radiated electric field emissions arrangement: D-CSR-3604-4 close up.



Photograph 1



Photograph 2

