



TRL Compliance
part of TRAC global

**REPORT ON THE CERTIFICATION TESTING OF A
AERIAL FACILITIES LIMITED
80-301403 VHF CELL ENHANCER
WITH RESPECT TO
THE FCC RULES CFR 47, PART 90 Subpart I
PRIVATE LAND MOBILE REPEATER.**



TEST REPORT NO: RU1394/8318
COPY NO: 1
ISSUE NO: 1
FCC ID: NEO80-3014SERIES

**REPORT ON THE CERTIFICATION TESTING OF A
AERIAL FACILITIES LIMITED
80-301403 VHF CELL ENHANCER
WITH RESPECT TO
THE FCC RULES CFR 47, PART 90 Subpart I
PRIVATE LAND MOBILE REPEATER.**

TEST DATE: 5th – 30th November 2007

TESTED BY: _____ S HODGKINSON

APPROVED BY: _____ J CHARTERS
RADIO SECTION
LEADER

DATE: 18th February 2008

Distribution:

- Copy Nos:
1. Aerial Facilities Limited
 2. TCB: TRL Compliance Limited
 3. TRL Compliance Ltd

THIS DOCUMENT MAY BE REPRODUCED ONLY IN ITS ENTIRETY AND WITHOUT CHANGE

CONTENTS

	PAGE	
CERTIFICATE OF CONFORMITY & COMPLIANCE	3	
APPLICANT'S SUMMARY	4	
EQUIPMENT TEST CONDITIONS	5	
TESTS REQUIRED	5	
TEST RESULTS	7-50	
		ANNEX
PHOTOGRAPHS	A	
PHOTOGRAPH No. 1: Test setup		
PHOTOGRAPH No. 2: Test setup		
APPLICANT'S SUBMISSION OF DOCUMENTATION LIST	B	
EQUIPMENT CALIBRATION	C	
MEASUREMENT UNCERTAINTY	D	
 Notes:		
1. Component failure during test	YES	<input type="checkbox"/>
	NO	<input checked="" type="checkbox"/>
2. If Yes, details of failure:		
3. The facilities used for the testing of the product contain in this report are FCC Listed.		



TRL Compliance

part of TRAC global

CERTIFICATE OF CONFORMITY & COMPLIANCE

FCC IDENTITY:	NEO80-3014SERIES
PURPOSE OF TEST:	Certification
TEST SPECIFICATION:	FCC RULES CFR 47, Part 90 Subpart I
TEST RESULT:	Compliant to Specification
EQUIPMENT UNDER TEST:	80-301403 VHF cell enhancer
EQUIPMENT TYPE:	Private Land Mobile Repeater
MAXIMUM GAIN:	Uplink 31.13dB Downlink 28.01dB
MAXIMUM INPUT:	Uplink -3.7dBm Downlink -7.16dBm
MAXIMUM OUTPUT CONDUCTED:	Uplink 27.28dBm Downlink 20.14dBm
ANTENNA TYPE:	Uplink Downlink
CHANNEL SPACING:	Not Applicable, Wideband
FREQUENCY GENERATION:	N/A
MODULATION TYPE:	F3E
POWER SOURCE(s):	+24Vdc
TEST DATE(s):	5 th – 30 th November 2007
ORDER No(s):	47231
APPLICANT:	Aerial Facilities Limited
ADDRESS:	Aerial House Asheridge Road Chesham Buckinghamshire HP5 1TU
TESTED BY:	----- S HODGKINSON
APPROVED BY:	----- J CHARTERS RADIO SECTION LEADER

APPLICANT'S SUMMARY

EQUIPMENT UNDER TEST (EUT): 80-301403 VHF cell enhancer

EQUIPMENT TYPE: Private Land Mobile Repeater

PURPOSE OF TEST: Certification

TEST SPECIFICATION(s): FCC RULES CFR 47, Part 90 Subpart I

TEST RESULT: COMPLIANT Yes
No

APPLICANT'S CATEGORY: MANUFACTURER
IMPORTER
DISTRIBUTOR
TEST HOUSE
AGENT

APPLICANT'S ORDER No(s): 47231

APPLICANT'S CONTACT PERSON(s): Mr Peter Bradfield

E-mail address: Peterb@aerial.co.uk

APPLICANT: Aerial Facilities Limited

ADDRESS: Aerial House
Asheridge Road
Chesham
Buckinghamshire
HP5 1TU
United Kingdom

TEL: +44 (0)1494 777000

FAX: +44 (0)1494 778456

MANUFACTURER: Aerial Facilities Limited

EUT(s) COUNTRY OF ORIGIN: United Kingdom

TEST LABORATORY: TRL Compliance Ltd

UKAS ACCREDITATION No: 0728

TEST DATE(s): 5th – 30th November 2007

TEST REPORT No: RU1394/8318

COMPLIANCE TESTS

AMPLIFIER GAIN – CONDUCTED – PART 2.1046 – UPLINK

Ambient temperature = 20°C
 Relative humidity = 62%
 Supply voltage = +24Vdc
 Channel number = See test results

Radio Laboratory

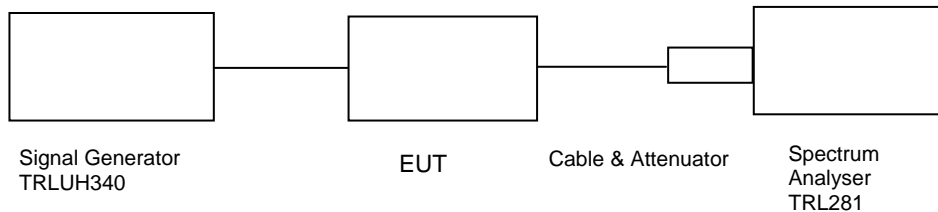

Frequency MHz	Signal Generator input level dBm	Input Cable Loss dB	Output Cable & Attenuator loss dB	Level at Spectrum Analyser dBm	Gain dB	Conducted Output Power dBm	Gain after 10dB input level increase dB
155.50	-3.7	0.15	40.39	-13.11	31.13	27.28	21.43
158.25	-3.7	0.15	40.39	-13.11	31.13	27.28	21.39
161.00	-3.8	0.15	40.39	-14.09	29.95	26.00	20.54

Notes: 1. The signal generator input was increased by 10dBs and the level of the output signal remeasured.
 2.

TYPE OF EQUIPMENT	MAKER/SUPPLIER	MODEL No	SERIAL No	TRL No	ACTUAL EQUIPMENT USED
SPECTRUM ANALYSER	RHODE & SCHWARZ	FSU	200034	281	X
ATTENUATOR	BIRD	8308-200-N	N/A	103	X
ATTENUATOR	SPINNER	745357	D57224	225	X
SIGNAL GENERATOR	RHODE & SCHWARZ	SML 03	102268	UH297	X

AMPLIFIER INTERMODULATION SPURIOUS EMISSIONS – CONDUCTED – PART 2.1053– UPLINK

Ambient temperature = 20°C
 Relative humidity = 65%
 Supply voltage = +24Vdc

Radio Laboratory

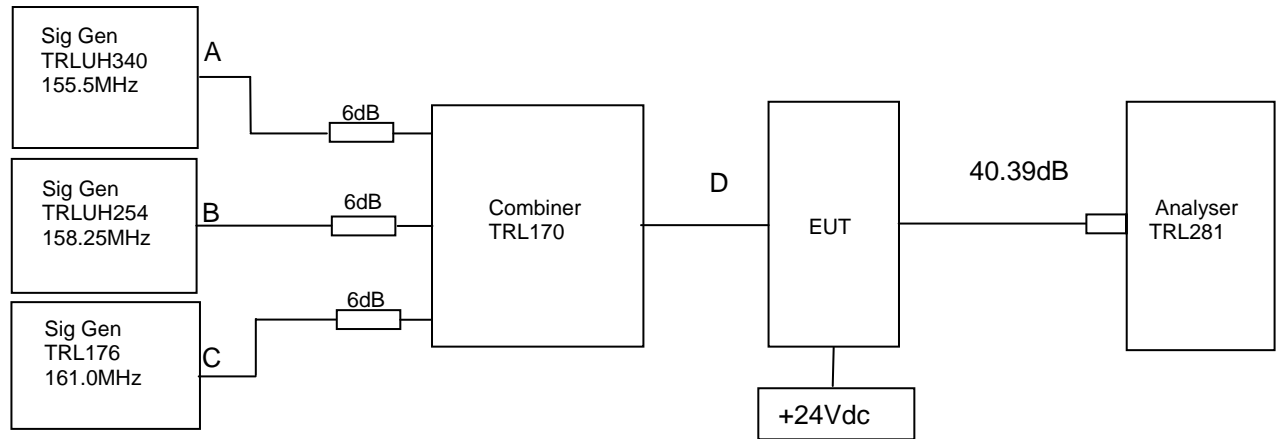

The intermodulation and spurious products were measured with the amplifier operating at maximum gain. A three tone test was conducted using the equipment as above. The input power level was adjusted so the level at point D was 10dB above the maximum input of -3.7dBm. The cable and attenuator loss between the EUT and the spectrum analyser was 40.39dB.

RF Input Frequency (MHz)			Highest Intermodulation Product Level (dBm)	Limit (dBm)
155.5	158.25	161.0	-26.86 @ 159.1675MHz	-13

Sweep data is shown on the next page:

Test equipment used for intermodulation test

TYPE OF EQUIPMENT	MAKER/SUPPLIER	MODEL No	SERIAL No	TRL No	ACTUAL EQUIPMENT USED
SPECTRUM ANALYSER	ANRITSU	MS2665C	MT26089	479	
SPECTRUM ANALYSER	R&S	FSU46	200034	UH281	X
SIGNAL GENERATOR	MARCONI	2042	119388/080	176	x
SIGNAL GENERATOR	HP	83630B	3722A00588	UH340	X
SIGNAL GENERATOR	MARCONI	2042	119562/021	254	X
SIGNAL GENERATOR	MARCONI	2023	112224/040	UH105	
CMTA	ROHDE & SCHWARZ	CMTA52	894715/033	05	
COMBINER	ELCOM	RC-4-50	N/A	170	X

Intermodulation Inband

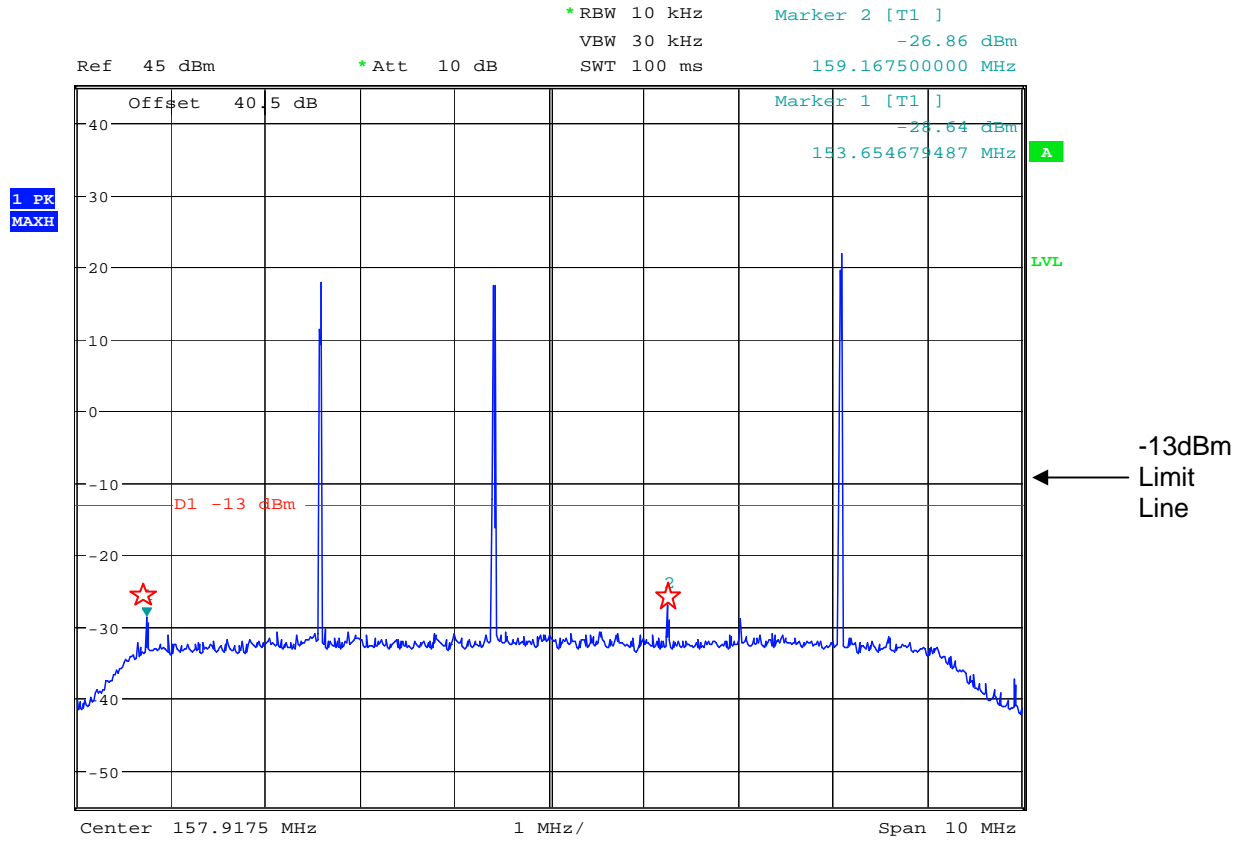

Date: 23.NOV.2007 11:42:01

The above plot shows that all products (designated by ☆) are below the spurious limit.

Intermodulation Wideband

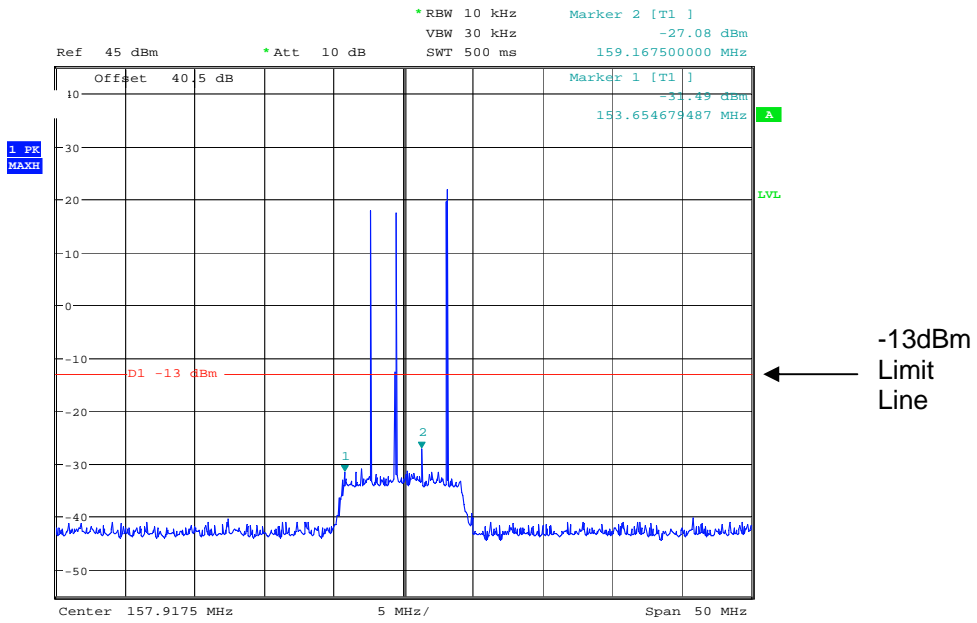

Date: 23.NOV.2007 11:43:14

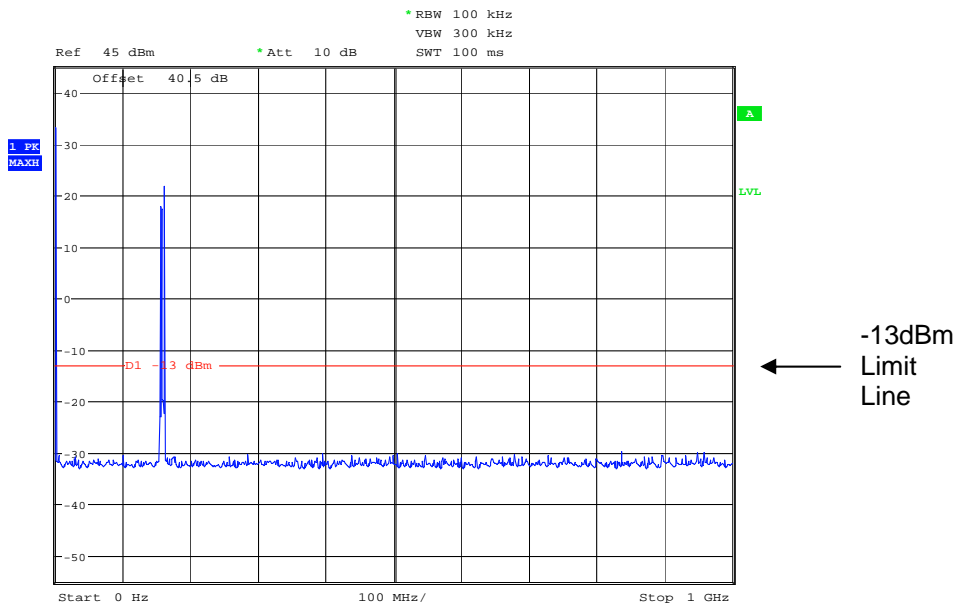

Date: 23.NOV.2007 11:58:10

Intermodulation Wideband

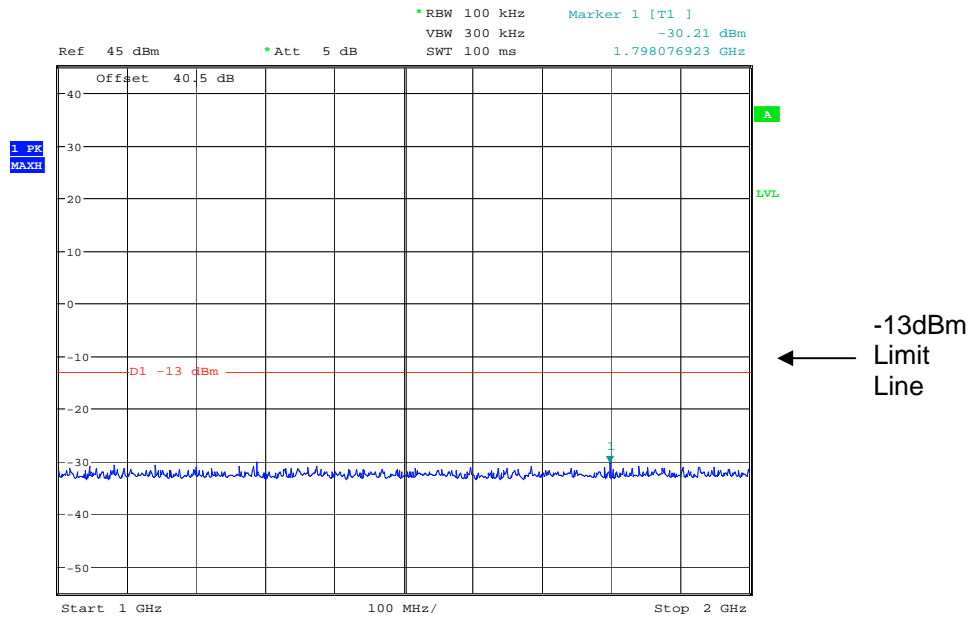

Date: 23.NOV.2007 11:59:51

The above plots show that there are no products outside the bands.

TRANSMITTER TESTS

AMPLIFIER MODULATED CHANNEL TEST – CONDUCTED – Part 2.1049– UPLINK

Ambient temperature = 20°C Radio Laboratory
 Relative humidity = 55%
 Supply voltage = +24Vdc
 Channel number = See test results

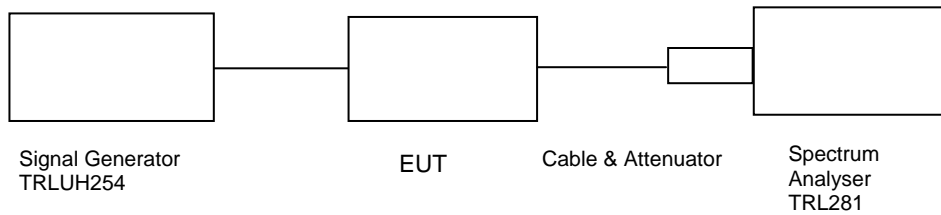

This test was performed to show that the amplifier does not alter the input signal in any way. The input signal was set to the maximum input level (6.3dBm) and modulated with a 2500Hz tone. The plots show the signal measured at the signal generator and the signal measured at the output of the EUT.

Note: The cables and attenuators had the following losses.

1. Cable and attenuator between EUT and spectrum analyser 40.39dB
2. Cable between signal generator and EUT 0.15dB

TYPE OF EQUIPMENT	MAKER/SUPPLIER	MODEL No	SERIAL No	TRL No	ACTUAL EQUIPMENT USED
SPECTRUM ANALYSER	R&S	FSU46	200034	UH281	X
ATTENUATOR	SPINNER	745357	D57224	225	X
ATTENUATOR	BIRD	8308-200-N	N/A	103	X
SIGNAL GENERATOR	MARCONI	2042	119562/021	254	X

VHF Amplifier uplink

Bottom channel 155.5MHz Signal Generator and EUT, deviation set to 2.5kHz

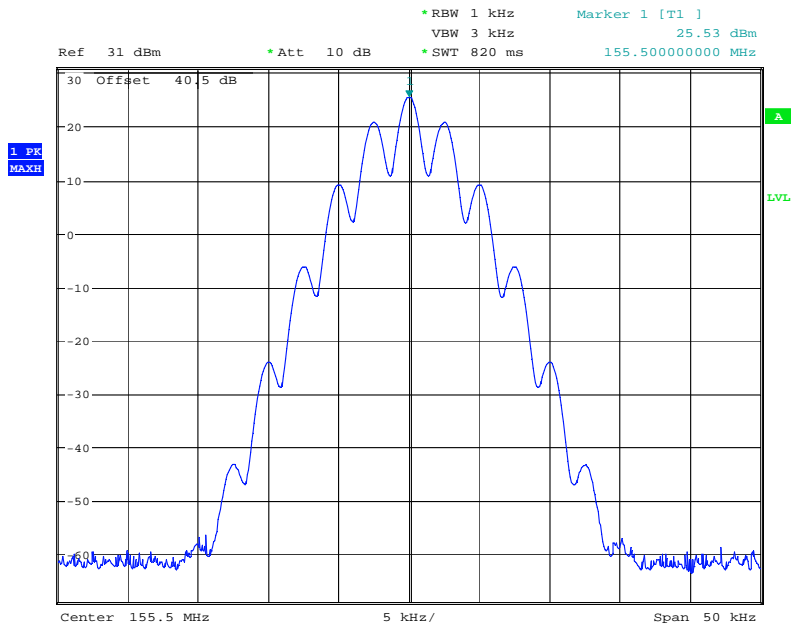

Date: 23.NOV.2007 10:40:37

Bottom channel 155.5MHz Signal Generator and EUT, deviation set to 5kHz

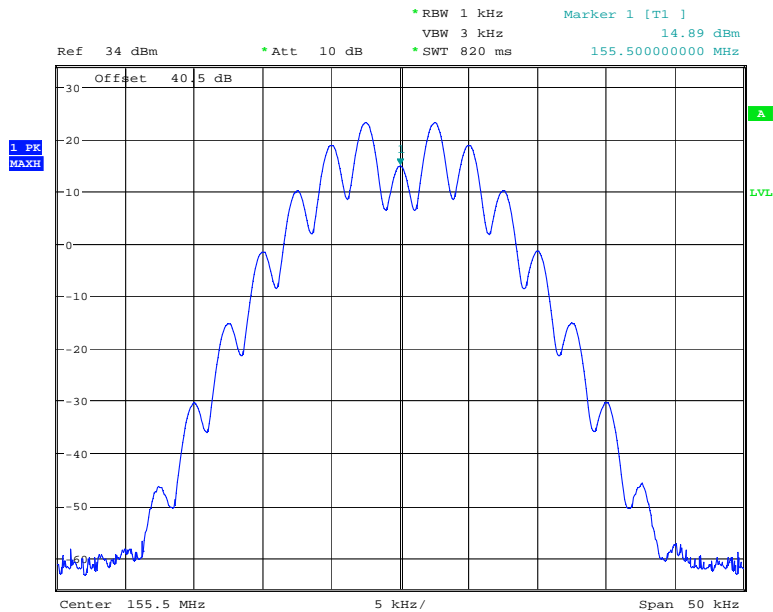

Date: 23.NOV.2007 10:42:11

The above plots depicting the output wavelshape show no measurable distortion visible when compared to the input signal.

Bottom channel 155.5MHz Signal Generator only, deviation set to 2.5kHz

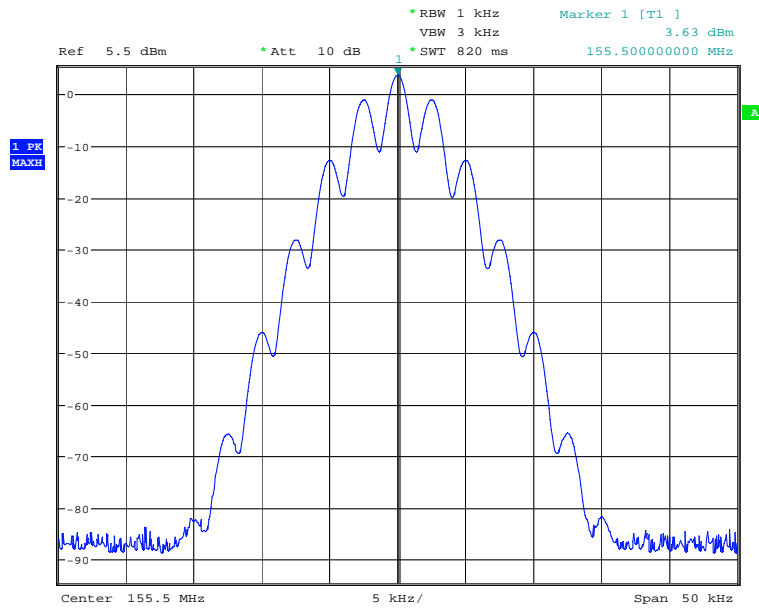

Date: 23.NOV.2007 10:47:58

Bottom channel 155.5MHz Signal Generator only, deviation set to 5.0kHz

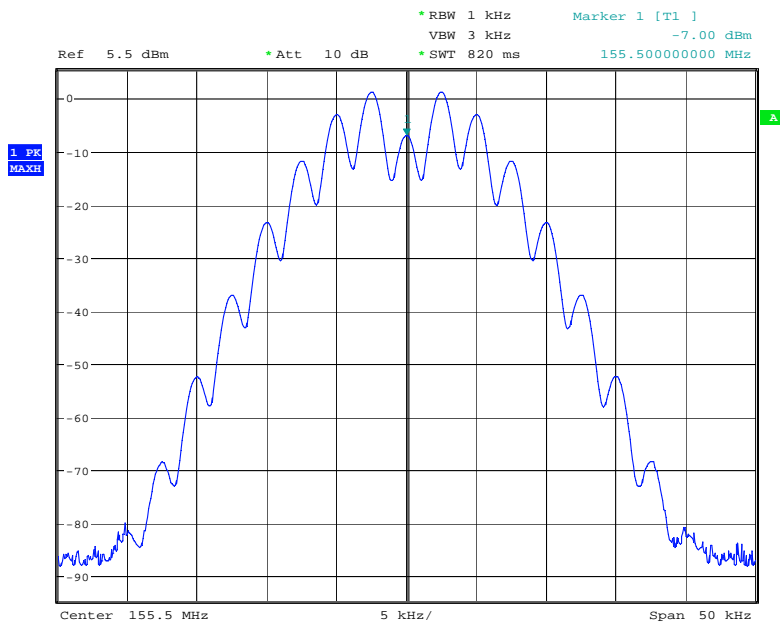

Date: 23.NOV.2007 10:48:35

The above plots depicting the output waveshape show no measurable distortion visible when compared to the input signal.

Middle channel 158.25MHz Signal Generator and EUT, deviation set to 2.5kHz

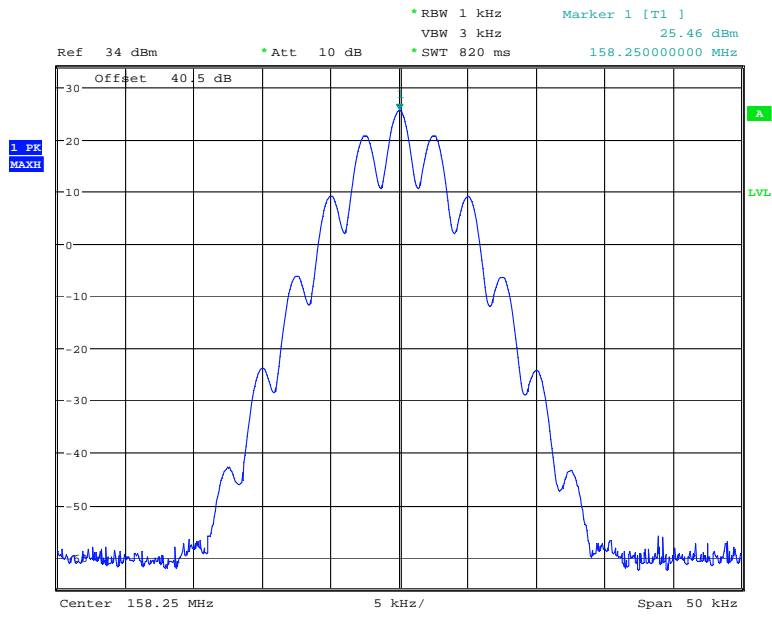

Date: 23.NOV.2007 10:43:13

Middle channel 158.25MHz Signal Generator and EUT, deviation set to 5kHz

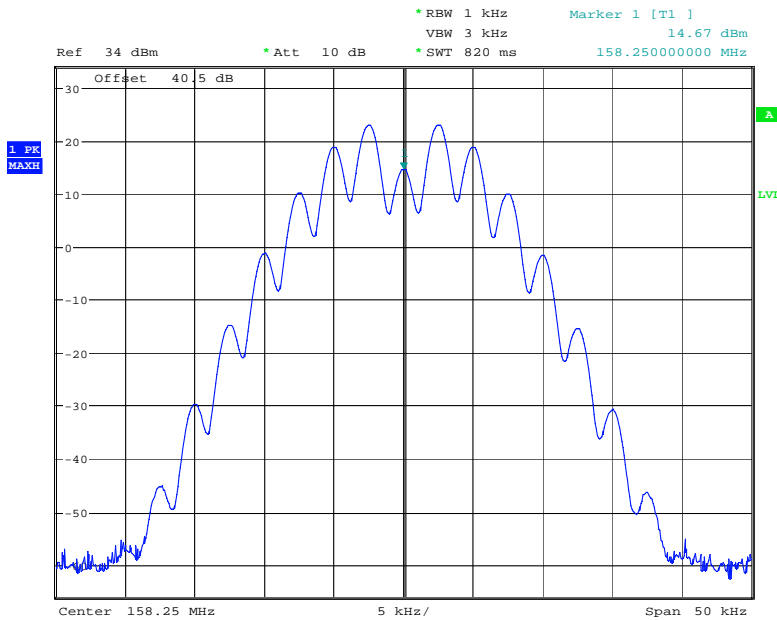

Date: 23.NOV.2007 10:44:02

The above plots depicting the output wavelshape show no measurable distortion visible when compared to the input signal.

Middle channel 158.25MHz Signal Generator, deviation set to 2.5kHz

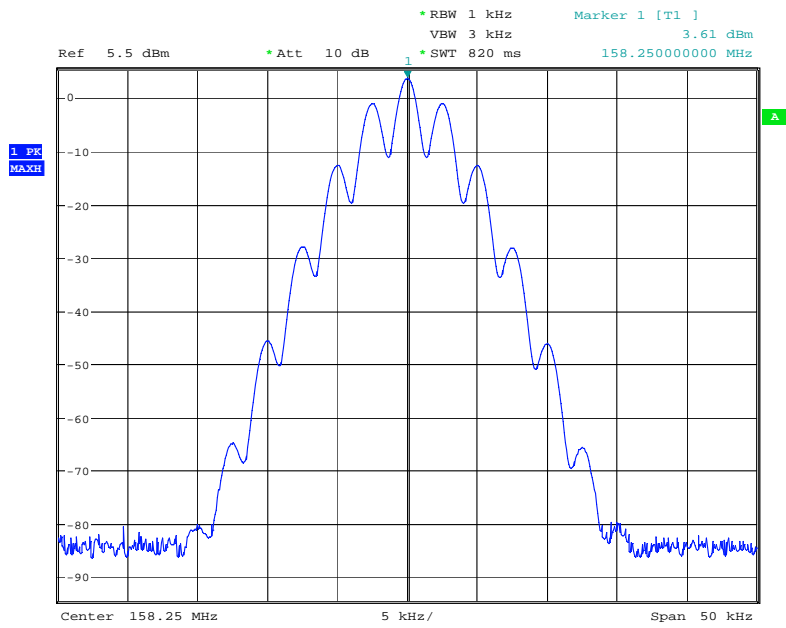

Date: 23.NOV.2007 10:49:23

Middle channel 158.25MHz Signal Generator, deviation set to 5kHz

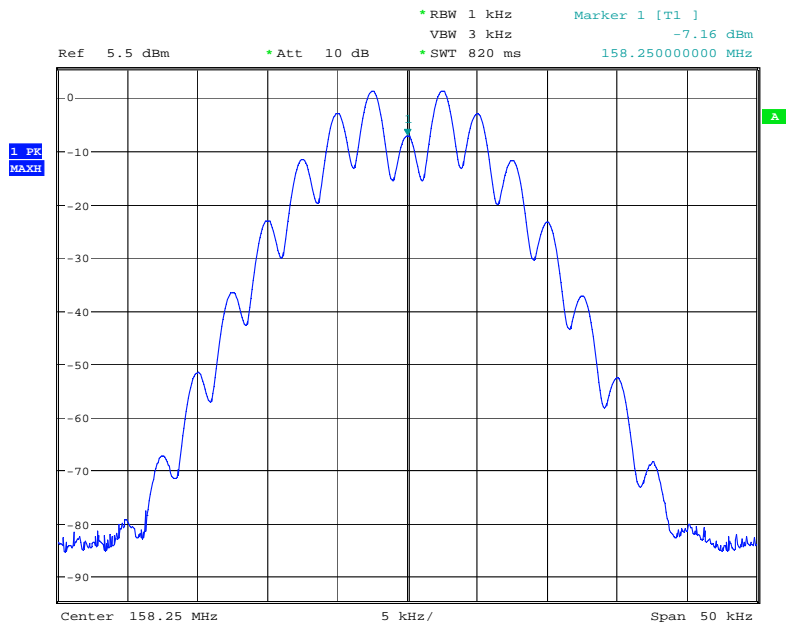

Date: 23.NOV.2007 10:50:06

Top channel 161.0MHz Signal Generator and EUT, deviation set to 2.5kHz

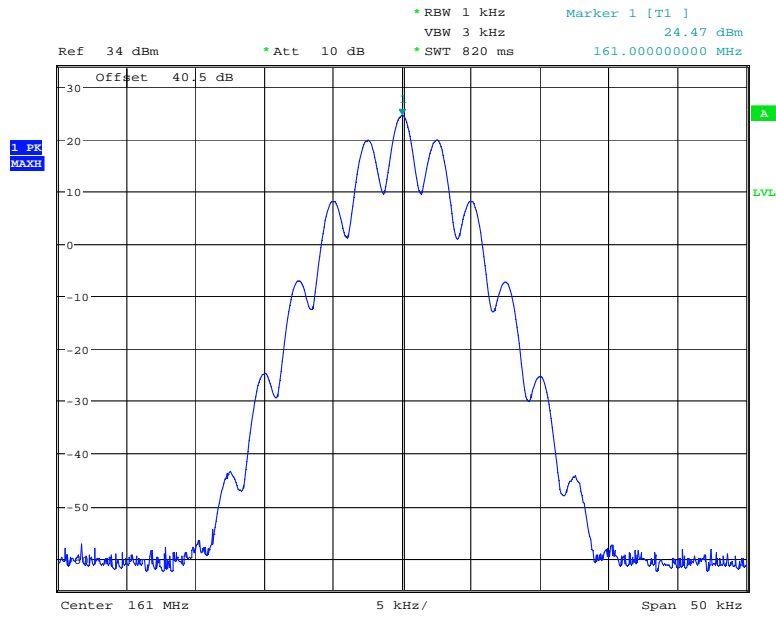

Date: 23.NOV.2007 10:44:58

Top channel 161.0MHz Signal Generator and EUT, deviation set to 5kHz

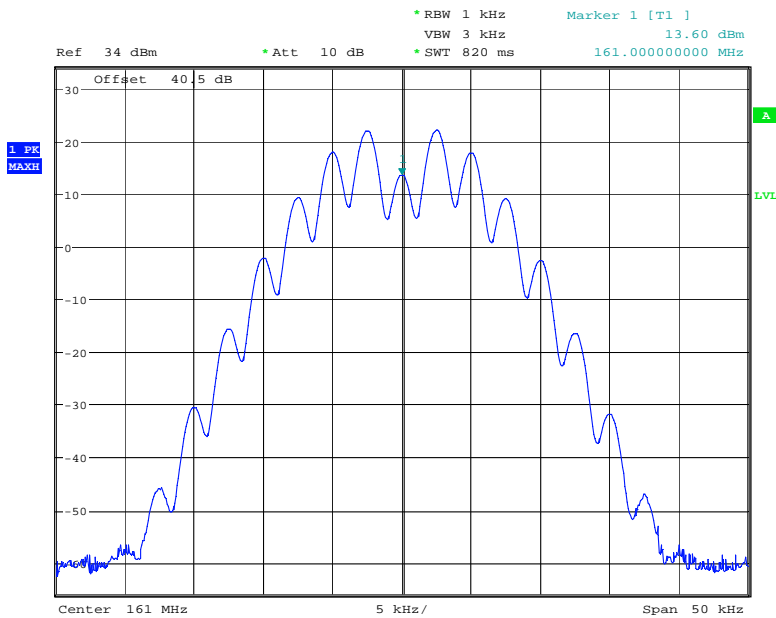

Date: 23.NOV.2007 10:45:46

Top channel 161.0MHz Signal Generator, deviation set to 2.5kHz

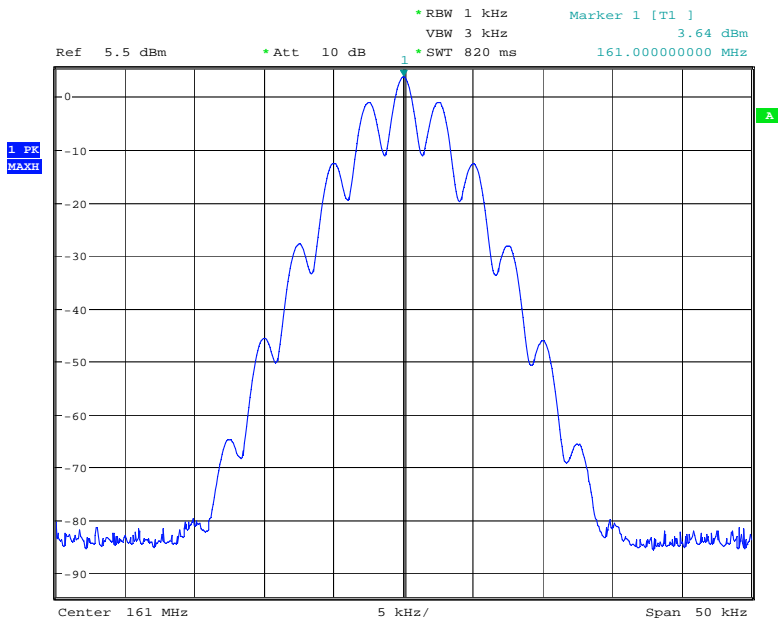

Date: 23.NOV.2007 10:51:25

Top channel 161.0MHz Signal Generator, deviation set to 5kHz

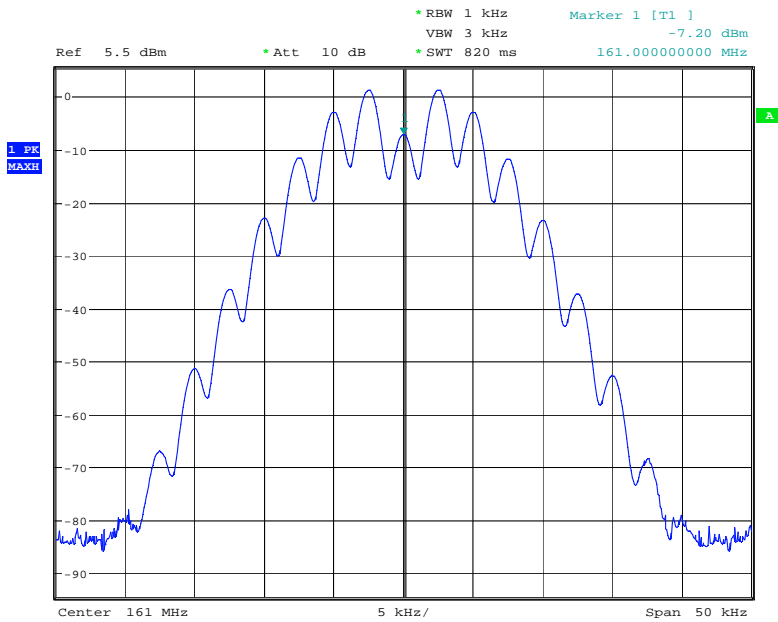

Date: 23.NOV.2007 10:52:18

TRANSMITTER TESTS

AMPLIFIER SPURIOUS EMISSIONS – CONDUCTED – Part 2.1053 – UPLINK

Ambient temperature = 20°C
 Relative humidity = 55%
 Supply voltage = +24Vdc

Radio Laboratory Test Signal = F3E

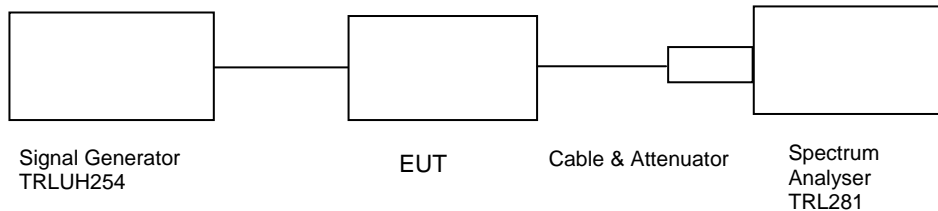

The test was set up as per the diagram. The level at the input was adjusted to compensate for the loss of the interconnecting cable. The unit was tested operating at maximum power and on three test frequencies.

The Spurious limit was calculated as follows:

On any frequency removed from the assigned frequency by more than 250% of the authorised bandwidth

At least $43 + 10 \log P_{dB}$

$(10 \log P_{watts}) - (43 + 10 \log (P_{watts} * 1000)) = \text{LIMIT} = -13 \text{ dBm}$

RESULTS

FREQUENCY RANGE	FREQ. (MHz)	MEASURED LEVEL (dBm)	ATTENUATOR & CABLE LOSSES (dB)	EMISSION LEVEL (dBm)	LIMIT (dBm)
0Hz – 2GHz	No Significant Emissions Within 20 dB of the Limit				-13

The test equipment used for the Transmitter Conducted Emissions:

TYPE OF EQUIPMENT	MAKER/SUPPLIER	MODEL No	SERIAL No	TRL No	ACTUAL EQUIPMENT USED
SPECTRUM ANALYSER	R&S	FSU46	200034	UH281	X
ATTENUATOR	SPINNER	745357	D57224	225	X
ATTENUATOR	BIRD	8308-200-N	N/A	103	X
SIGNAL GENERATOR	MARCONI	2042	119562/021	254	X

VHF Amplifier uplink

Conducted emissions bottom channel 155.5MHz 30MHz – 1GHz

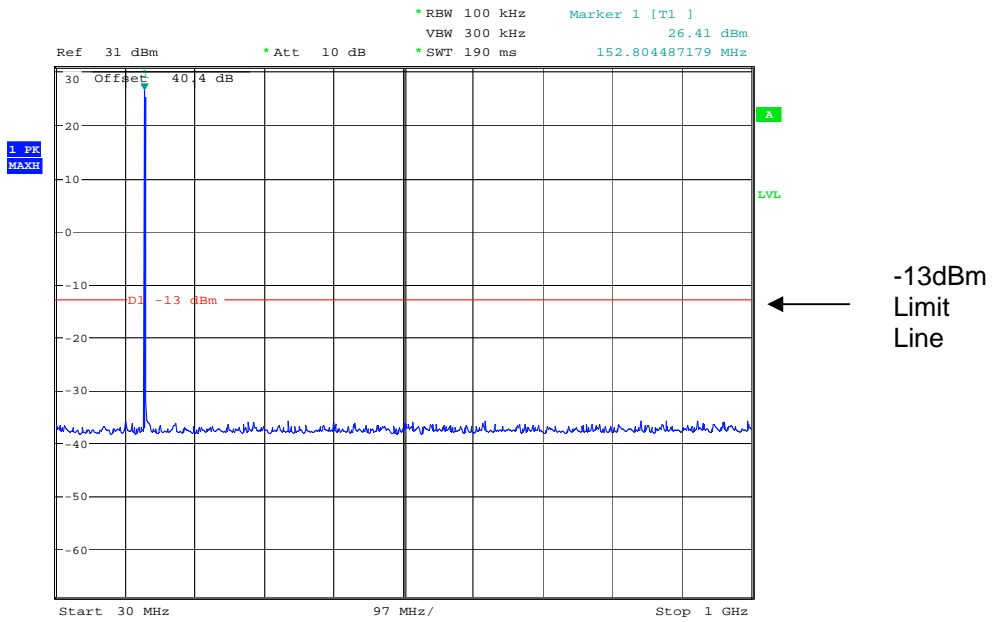

Date: 6.NOV.2007 15:50:15

Conducted emissions bottom channel 155.5MHz 1 – 1.8GHz

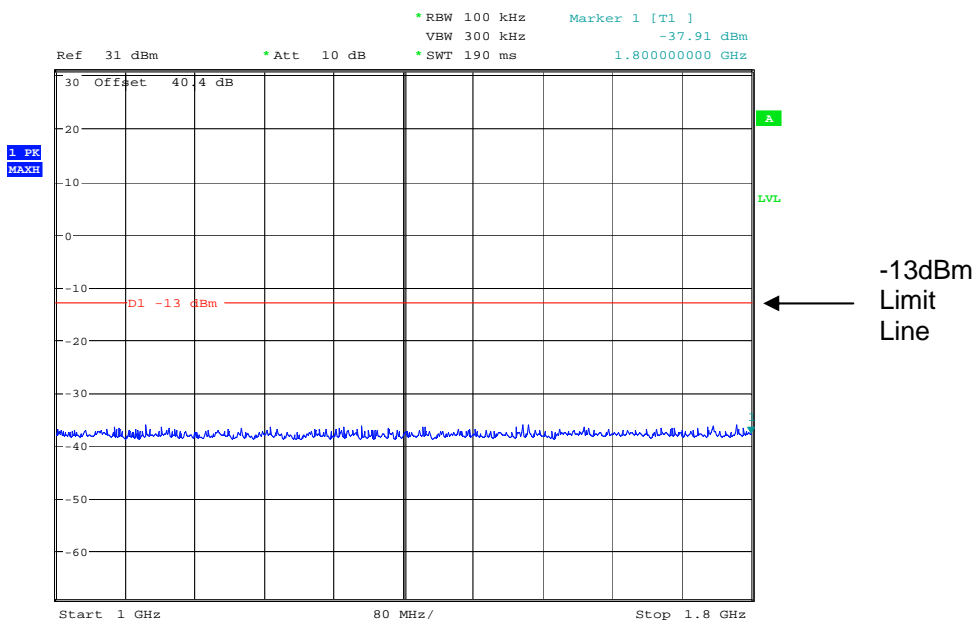

Date: 6.NOV.2007 15:52:00

Conducted emissions Middle channel 158.25MHz 30MHz – 1GHz

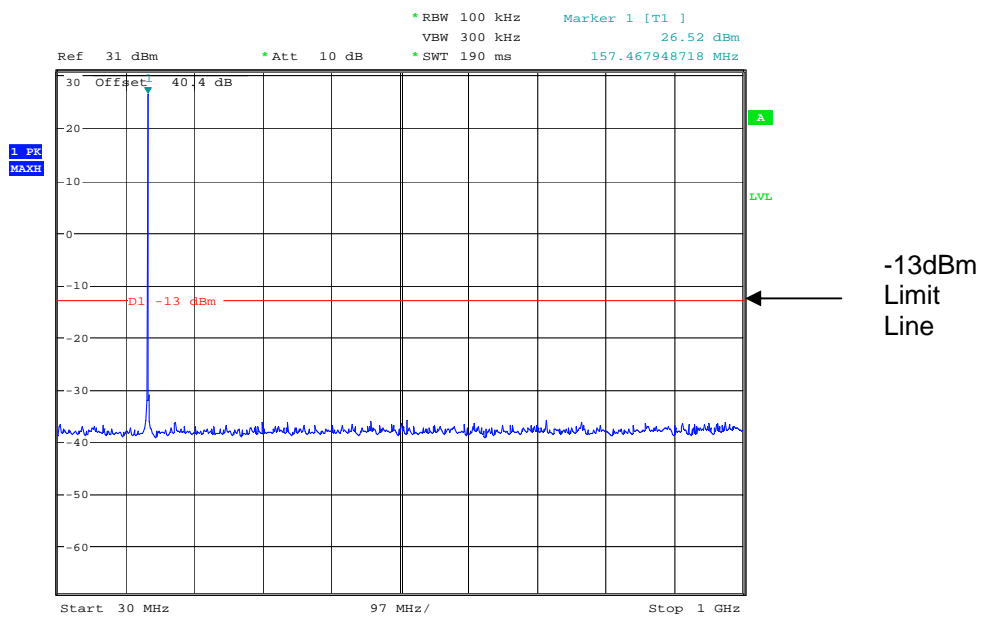

Date: 6.NOV.2007 15:56:26

Conducted emissions Middle channel 158.25MHz 1 – 1.8GHz

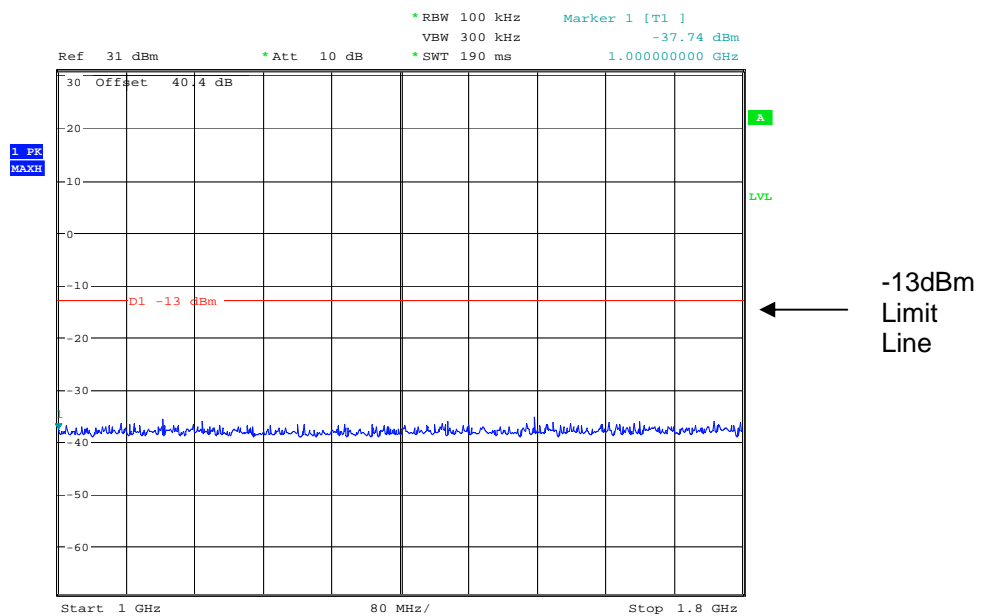

Date: 6.NOV.2007 15:57:01

Conducted emissions Top channel 161.0MHz 30MHz - 1GHz

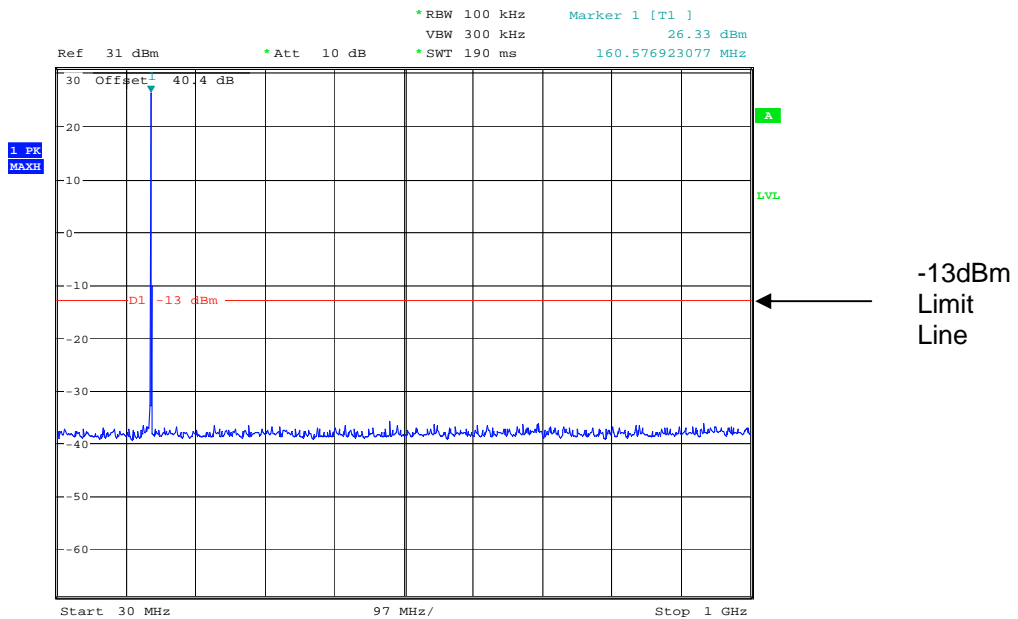

Date: 6.NOV.2007 15:59:03

Conducted emissions Top channel 161.0MHz 1 – 1.8GHz

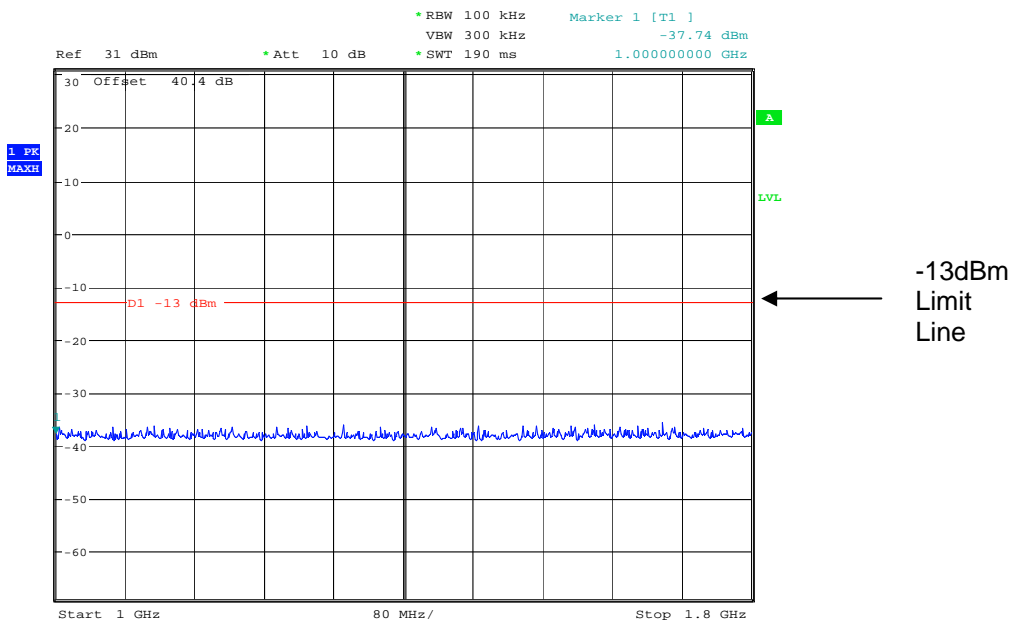

Date: 6.NOV.2007 15:59:43

The above test results show that there were no emissions within 20dBs of the -13dBm limit.

TRANSMITTER TESTS

AMPLIFIER SPURIOUS EMISSIONS – RADIATED – Part 2.1053– UPLINK

Ambient temperature = 12°C
 Relative humidity = 44%
 Conditions = OATS
 Supply voltage = +24Vdc
 Supply Frequency = N/A

Test Signal = F3E

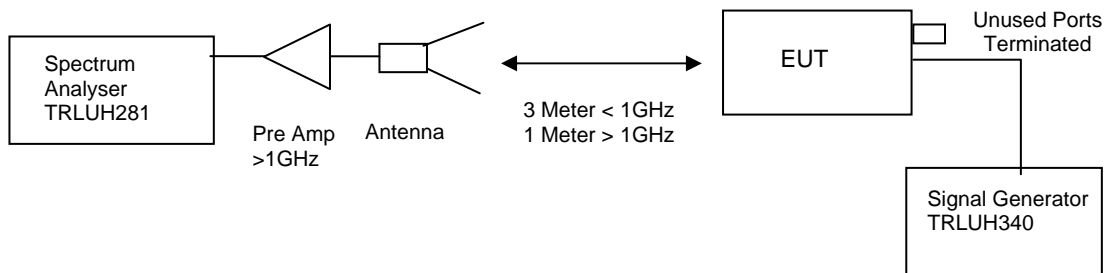

The test was set up as per the diagram. The level at the input was adjusted to compensate for the loss of the interconnecting cable. The unit was tested operating maximum power on three test frequencies with a 50 ohm load on the output. The unit was also tested with the signal generator replaced by another 50ohm load.

The Spurious limit was calculated as follows:

On any frequency removed from the assigned frequency by more that 250% of the authorised bandwidth

At least $43 + 10 \log P_{dB}$

$(10 \log P_{watts}) - (43 + 10 \log (P_{watts} * 1000)) = \text{LIMIT} = -13 \text{ dBm}$

RESULTS

FREQUENCY RANGE	FREQ. (MHz)	MEAS. Rx. (dBμV)	CABLE LOSS (dB)	ANT FACTOR	FIELD STRENGTH (dBμV/m)	CALCULATED EIRP (dBm)	LIMIT (dBm)
30MHz – 2GHz	No Significant Emissions Within 20 dB of the Limit						-13dBm

The test equipment used for the Transmitter Spurious Emissions:

TYPE OF EQUIPMENT	MAKER/SUPPLIER	MODEL No	SERIAL No	TRL No	ACTUAL EQUIPMENT USED
SPECTRUM ANALYSER	ANRITSU	MS2665C	MT26089	479	
HORN	EMCO	3115	9010-3580	138	X
SPECTRUM ANALYSER	R&S	FSU46	200034	UH281	X
PRE AMPLIFIER	HP	8449B	3008A016	572	X
SIGNAL GENERATOR	HP	83630B	3722A00588	UH340	X
ANTENNA	YORK	CBL611/A	1618	UH191	X

Radiated E-Field Emissions

EUT: LA-MTA-BDA Combiner
 Manuf: Aerial Facilities
 Op Cond: 3m Indoor Prescan MAC Chamber
 Operator: S Hodgkinson
 Test Spec: part90
 Comment: VHFUPLINK,BOTTOM CHANNEL
 Rx antenna Vertical.
 Result File: 16.dat : New Measurement

Scan Settings (1 Range)

Frequencies				Receiver Settings				
Start	Stop	Step	IF BW	Detector	M-Time	Atten	Preamp	OpRge
30MHz	1000MHz	50kHz	120kHz	PK	1msec	Auto	OFF	60dB

Transducer	No.	Start	Stop	Name
1	21	30MHz	1000MHz	UH213
	22	30MHz	1000MHz	UH191

Final Measurement: Detector: X QP
 Meas Time: 2sec
 Subranges: 50
 Acc Margin: 20 dB

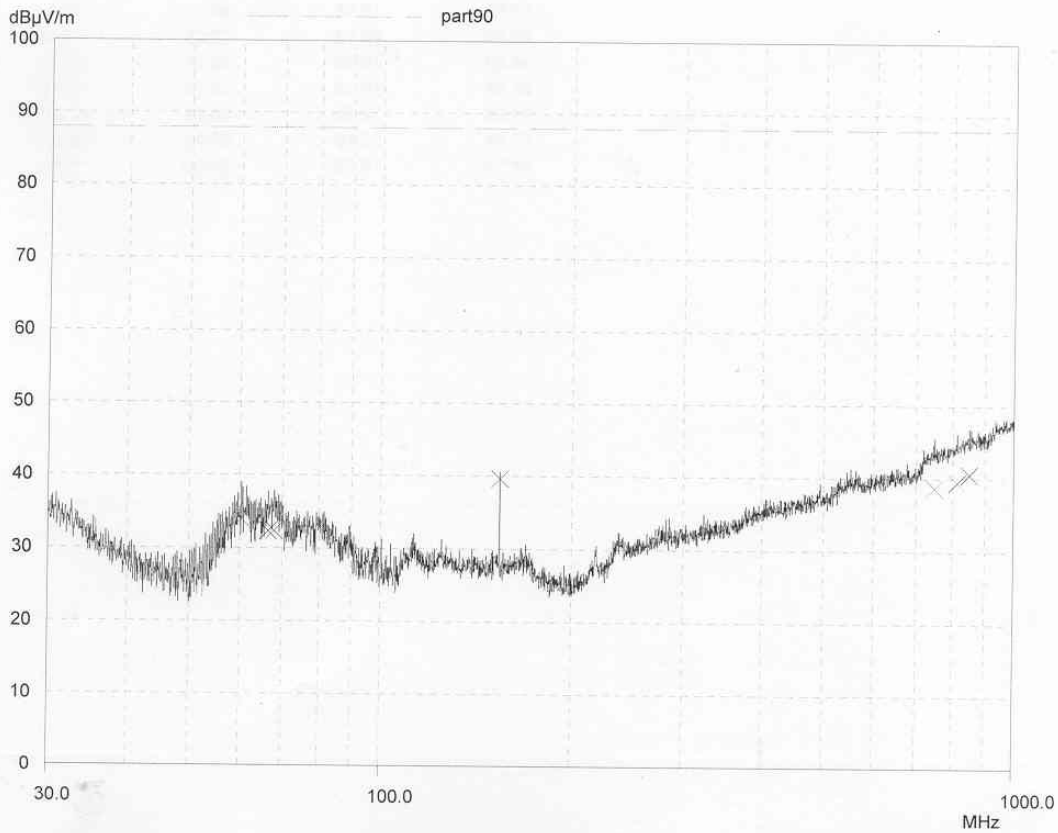

Radiated E-Field Emissions

EUT: LA-MTA-BDA Combiner
 Manuf: Aerial Facilities
 Op Cond: 3m Indoor Prescan MAC Chamber
 Operator: S Hodgkinson
 Test Spec: part90
 Comment: VHFUPLINK,MIDDLE CHANNEL
 Rx antenna Vertical..
 Result File: 17.dat : New Measurement

Scan Settings				Receiver Settings					
(1 Range)									
Frequencies		Step	IF BW	Detector	M-Time	Atten	Preamp	OpRge	
Start	Stop								
30MHz	1000MHz	50kHz	120kHz	PK	1msec	Auto	OFF	60dB	

Transducer	No.	Start	Stop	Name
1	21	30MHz	1000MHz	UH213
	22	30MHz	1000MHz	UH191

Final Measurement: Detector: X QP
 Meas Time: 2sec
 Subranges: 50
 Acc Margin: 20 dB

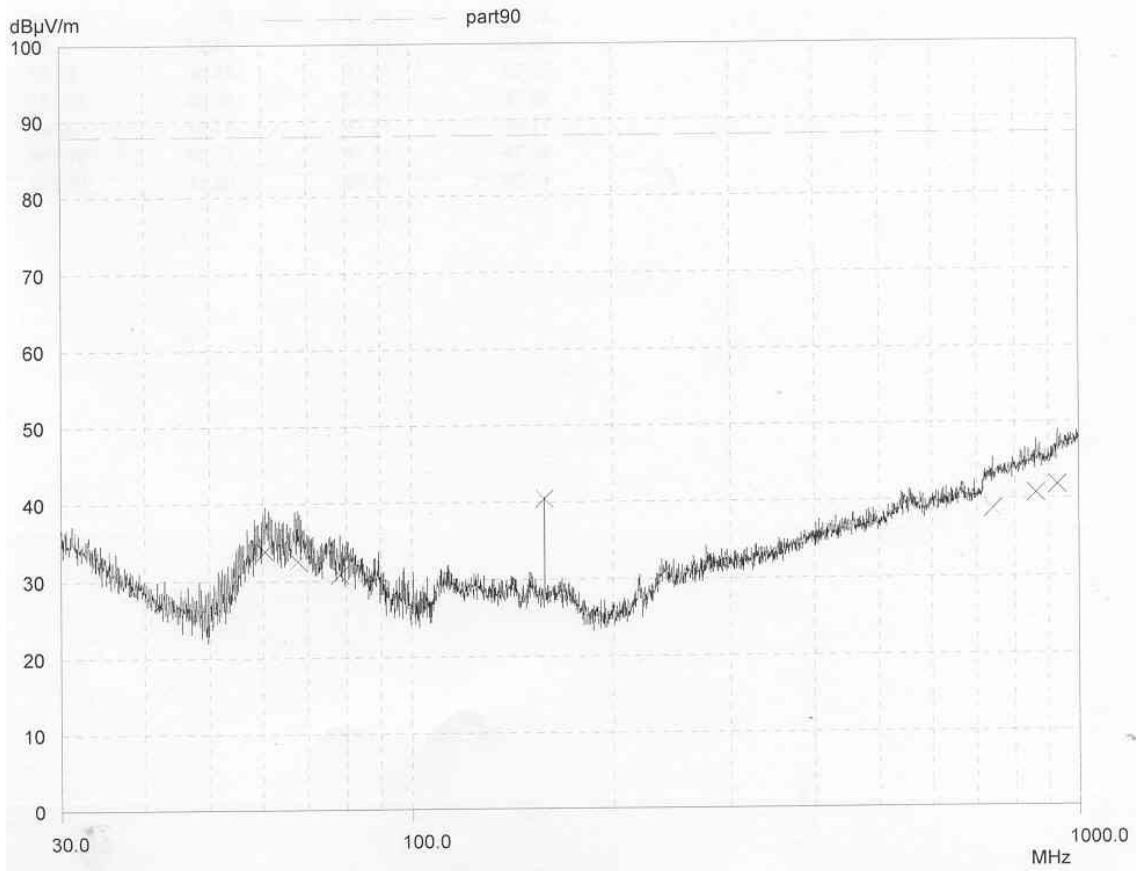

Radiated E-Field Emissions

EUT: LA-MTA-BDA Combiner
 Manuf: Aerial Facilities
 Op Cond: 3m Indoor Prescan MAC Chamber
 Operator: S Hodgkinson
 Test Spec: part90
 Comment: VHFUPLINK, TOP CHANNEL
 Rx antenna Vertical.
 Result File: 19.dat : New Measurement

Scan Settings (1 Range)

Frequencies			Receiver Settings					
Start	Stop	Step	IF BW	Detector	M-Time	Atten	Preamp	OpRge
30MHz	1000MHz	50kHz	120kHz	PK	1msec	Auto	OFF	60dB

Transducer	No.	Start	Stop	Name
1	21	30MHz	1000MHz	UH213
	22	30MHz	1000MHz	UH191

Final Measurement: Detector: X QP
 Meas Time: 2sec
 Subranges: 50
 Acc Margin: 20 dB

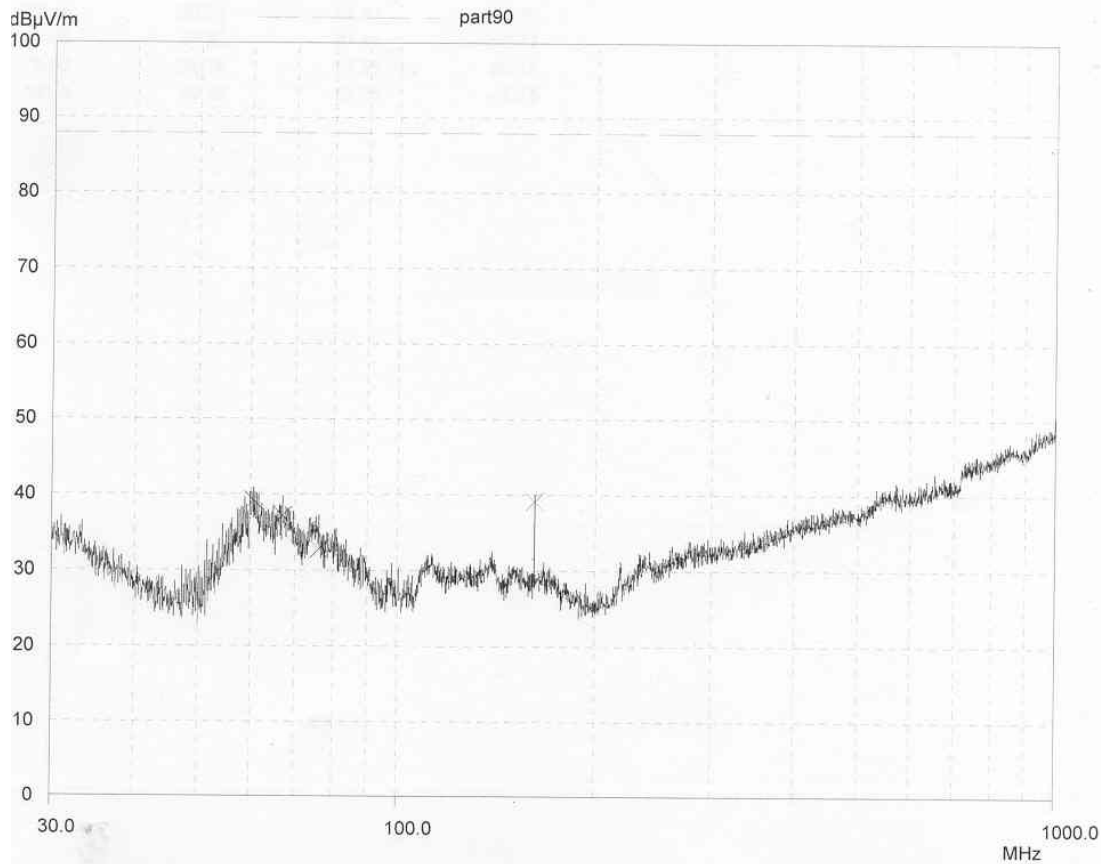

Radiated emissions bottom channel 155.5MHz 1 – 2GHz

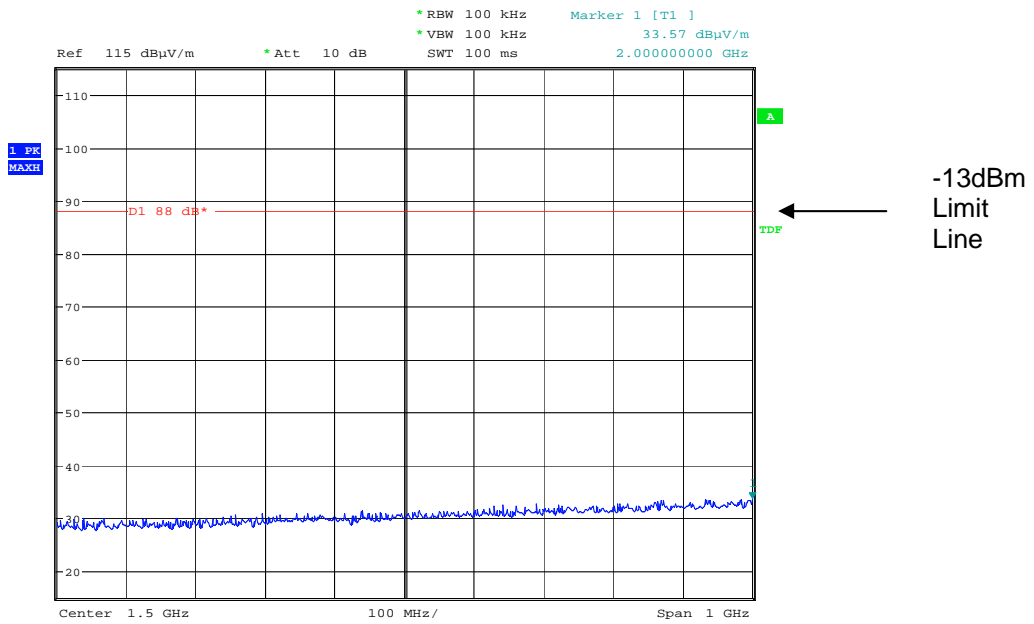

Date: 20.NOV.2007 12:01:21

Radiated emissions middle channel 158.25MHz 1 – 2GHz

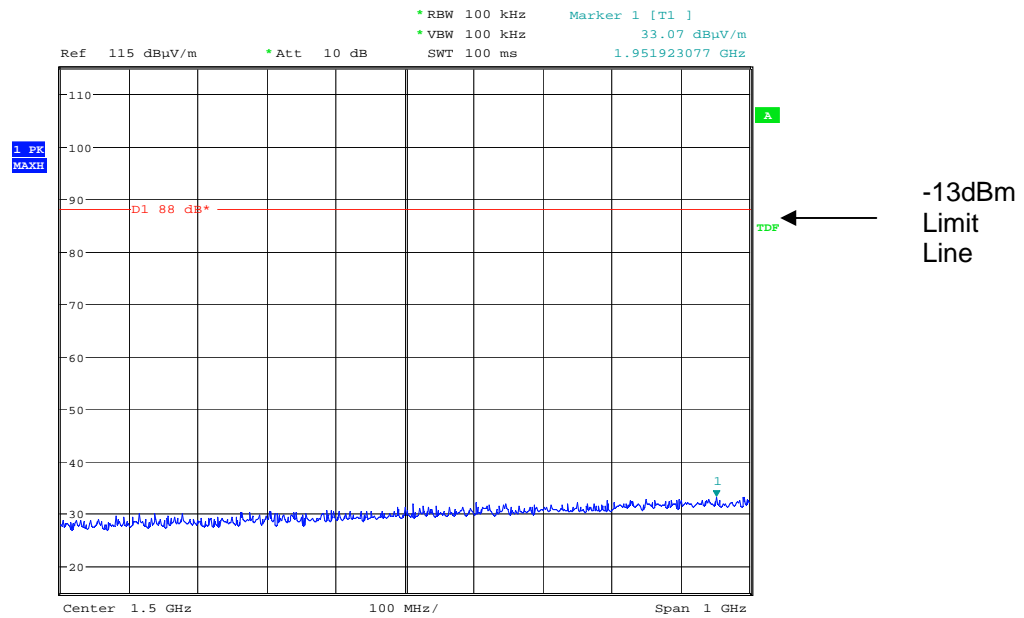

Date: 20.NOV.2007 12:01:55

Radiated emissions top channel 161.0MHz 1 – 2GHz

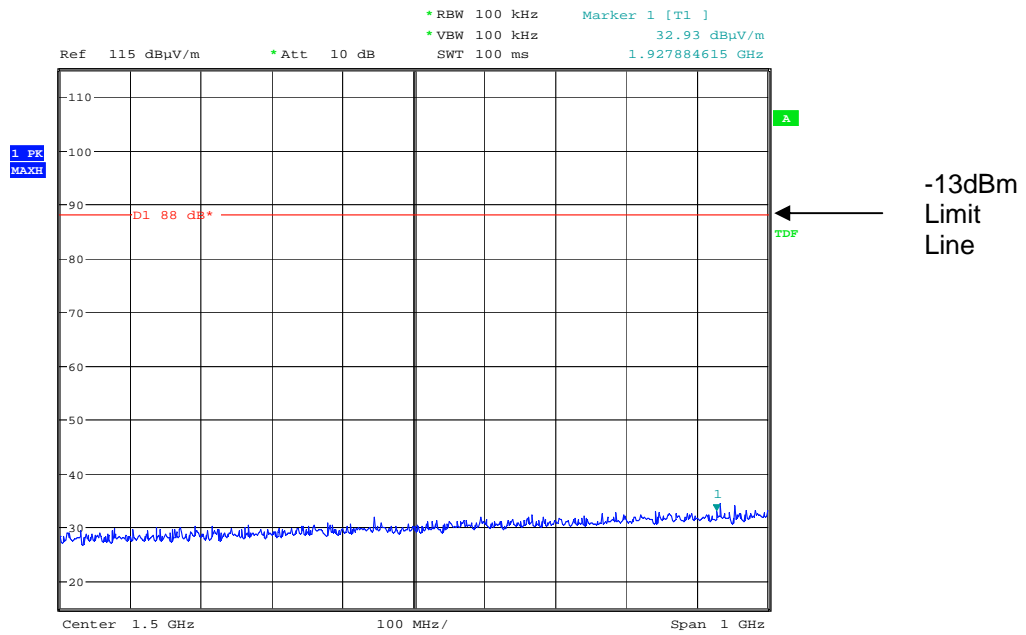

Date: 20.NOV.2007 12:02:43

The above test results show that there were no emissions within 20dBs of the -13dBm limit.

AMPLIFIER GAIN – CONDUCTED – PART 2.1046 – DOWNLINK

Ambient temperature = 25°C
 Relative humidity = 30%
 Supply voltage = +24Vac
 Channel number = See test results

Radio Laboratory

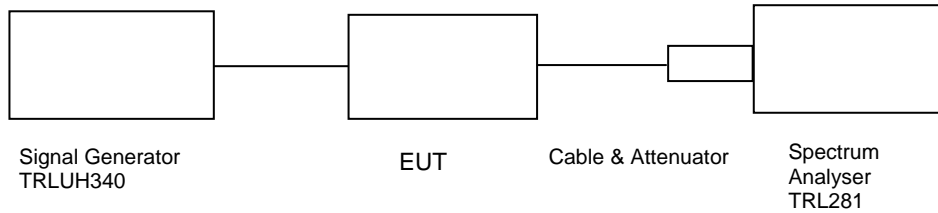

Frequency MHz	Signal Generator input level dBm	Input Cable Loss dB	Output Cable & Attenuator loss dB	Level at Spectrum Analyser dBm	Gain dB	Conducted Output Power dBm	Gain after 10dB input level increase dB
154.00	-7.80	0.23	40.5	-21.23	27.30	19.27	18.01
157.75	-9.60	0.23	40.5	-22.32	28.01	18.18	18.56
161.50	-7.16	0.23	40.5	-20.36	27.53	20.14	18.06

Notes: 1. The signal generator input was increased by 10dBs and the level of the output signal remeasured.

TYPE OF EQUIPMENT	MAKER/SUPPLIER	MODEL No	SERIAL No	TRL No	ACTUAL EQUIPMENT USED
SPECTRUM ANALYSER	RHODE & SCHWARZ	FSU	200034	281	X
ATTENUATOR	BIRD	8308-200-N	N/A	103	X
ATTENUATOR	SPINNER	745357	D57224	225	X
SIGNAL GENERATOR	RHODE & SCHWARZ	SML 03	102268	UH297	X

AMPLIFIER INTERMODULATION SPURIOUS EMISSIONS – CONDUCTED – PART 2.1053– DOWNLINK

Ambient temperature = 20°C
 Relative humidity = 30%
 Supply voltage = +24Vdc

Radio Laboratory

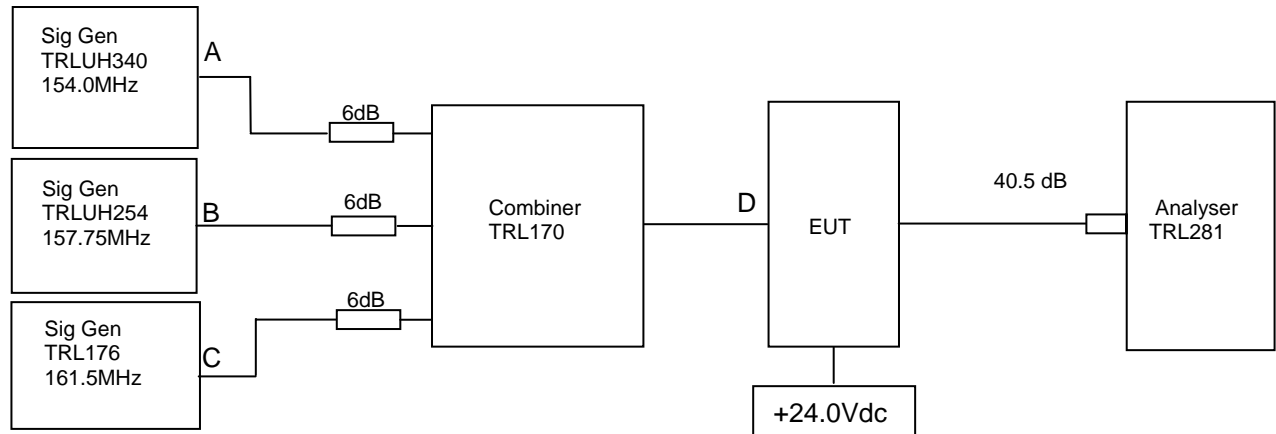

The intermodulation and spurious products were measured with the amplifier operating at maximum gain. A three tone test was conducted using the equipment as above. The input power level was adjusted so the level at point D was 10dB above the maximum input of -7.16dBm . The cable and attenuator loss between the EUT and the spectrum analyser was 40.5dB.

RF Input Frequency (MHz)			Highest Intermodulation Product Level (dBm)	Limit (dBm)
154.0	157.75	161.5	No significant emissions within 20dB of the limit	-13

Sweep data is shown on the next page:

Test equipment used for intermodulation test

TYPE OF EQUIPMENT	MAKER/SUPPLIER	MODEL No	SERIAL No	TRL No	ACTUAL EQUIPMENT USED
SPECTRUM ANALYSER	ANRITSU	MS2665C	MT26089	479	
SPECTRUM ANALYSER	R&S	FSU46	200034	UH281	X
SIGNAL GENERATOR	MARCONI	2042	119388/080	176	x
SIGNAL GENERATOR	HP	83630B	3722A00588	UH340	X
SIGNAL GENERATOR	MARCONI	2042	119562/021	254	X
SIGNAL GENERATOR	MARCONI	2023	112224/040	UH105	
CMTA	ROHDE & SCHWARZ	CMTA52	894715/033	05	
COMBINER	ELCOM	RC-4-50	N/A	170	X

Intermodulation Inband

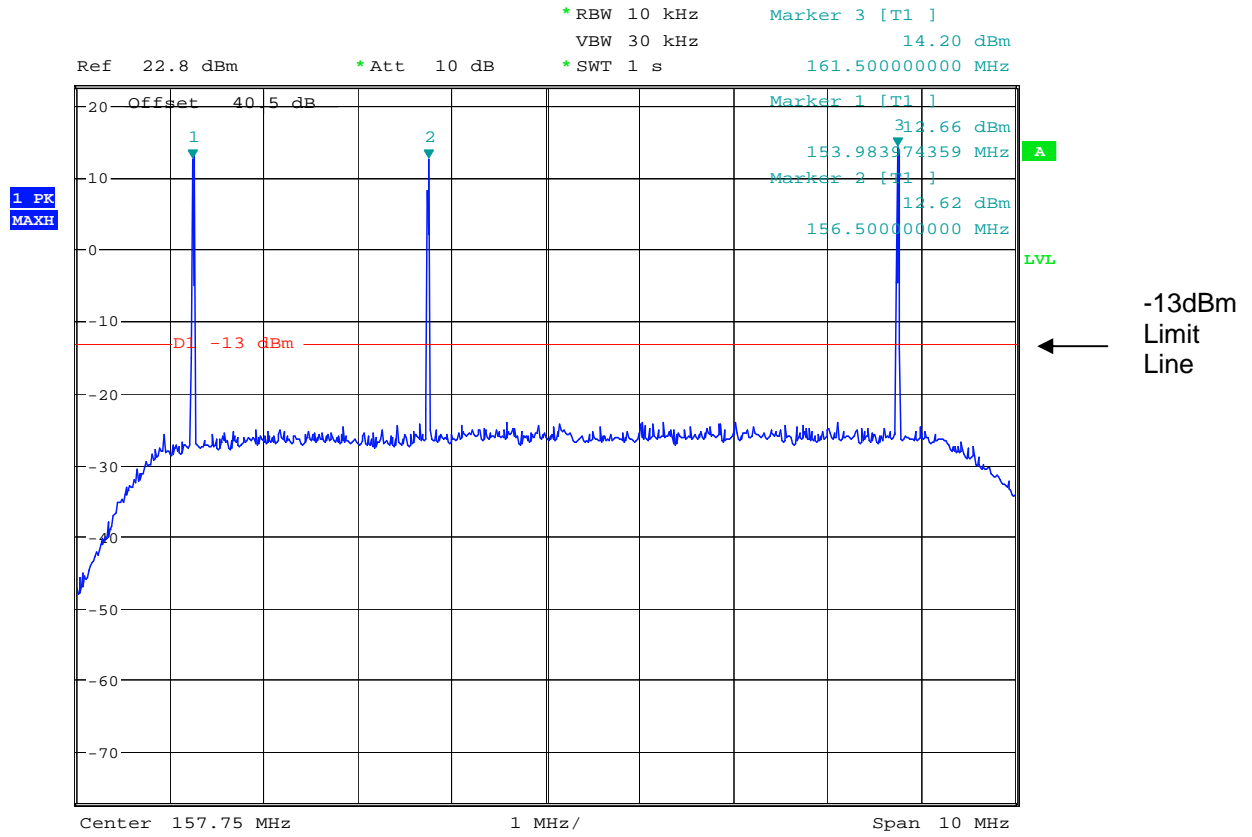

Date: 10.DEC.2007 12:39:17

The above plot shows that all products (designated by ☆) are below the spurious limit

Intermodulation Wideband

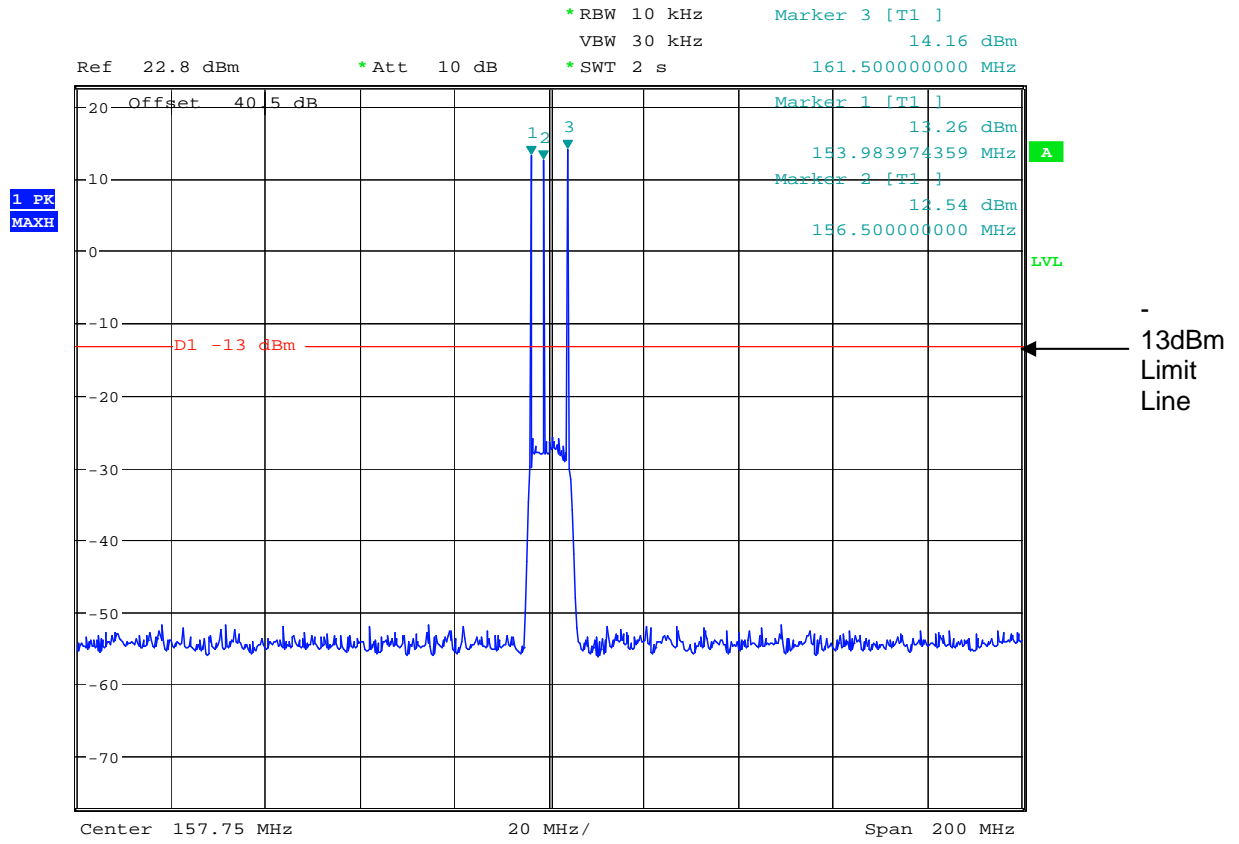

Date: 10.DEC.2007 12:40:16

The above plot shows that there are no products outside the bands.

Intermodulation Wideband

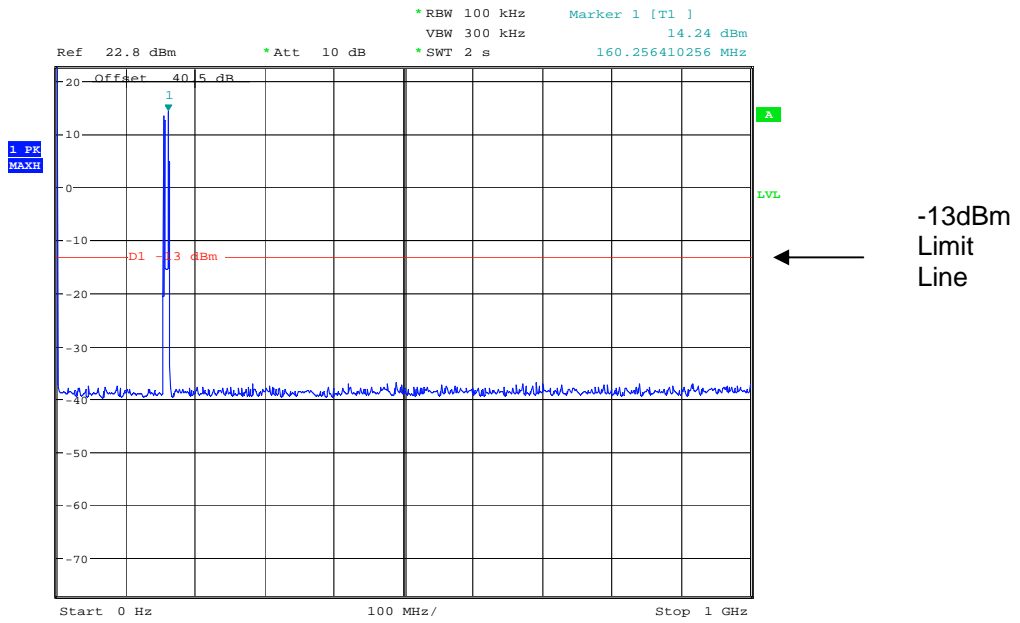

Date: 10.DEC.2007 12:41:13

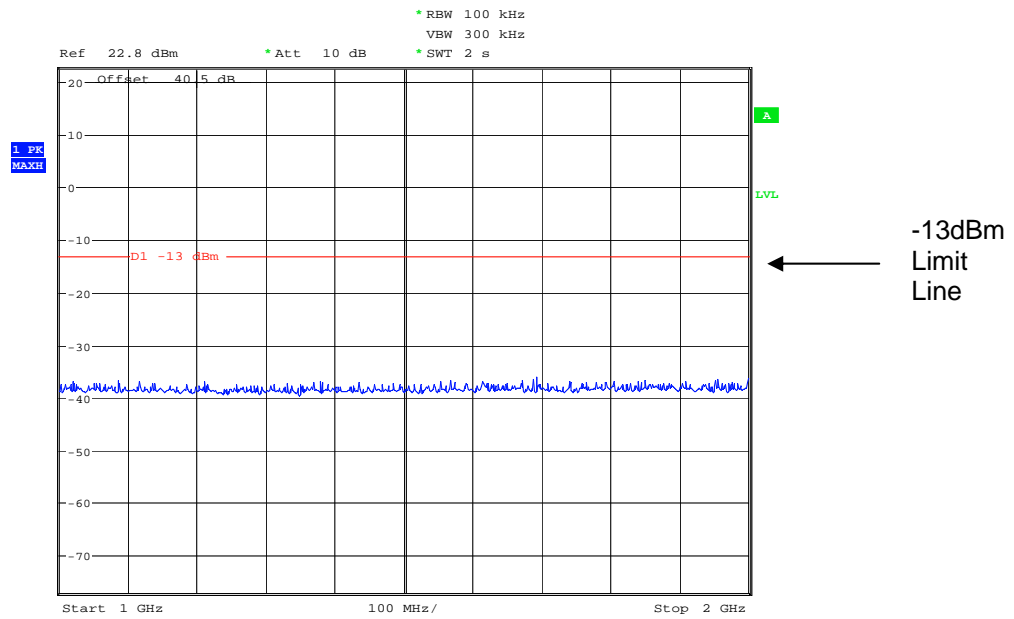

Date: 10.DEC.2007 12:41:50

The above plot shows that there are no products outside the bands.

TRANSMITTER TESTS

AMPLIFIER MODULATED CHANNEL TEST – CONDUCTED – Part 2.1049– DOWNLINK

Ambient temperature = 20°C Radio Laboratory
 Relative humidity = 30%
 Supply voltage = +24Vdc
 Channel number = See test results

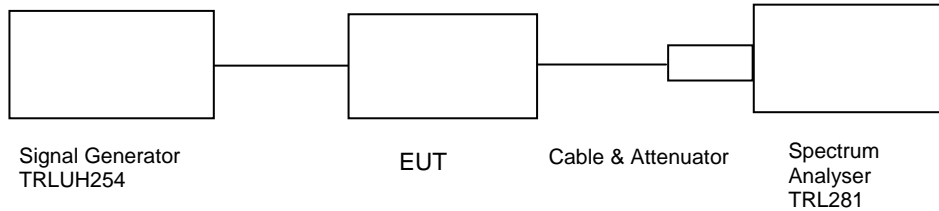

This test was performed to show that the amplifier does not alter the input signal in any way. The input signal was set to the maximum input level (2.84dBm) and modulated with a 2500Hz tone. The plots show the signal measured at the signal generator and the signal measured at the output of the EUT.

Note: The cables and attenuators had the following losses.

1. Cable and attenuator between EUT and spectrum analyser 40.5dB
2. Cable between signal generator and EUT 0.23dB

TYPE OF EQUIPMENT	MAKER/SUPPLIER	MODEL No	SERIAL No	TRL No	ACTUAL EQUIPMENT USED
SPECTRUM ANALYSER	R&S	FSU46	200034	UH281	X
ATTENUATOR	SPINNER	745357	D57224	225	X
ATTENUATOR	BIRD	8308-200-N	N/A	103	X
SIGNAL GENERATOR	MARCONI	2042	119562/021	254	X

VHF Amplifier downlink

Bottom channel 154.0MHz Signal Generator and EUT, deviation set to 2.5kHz

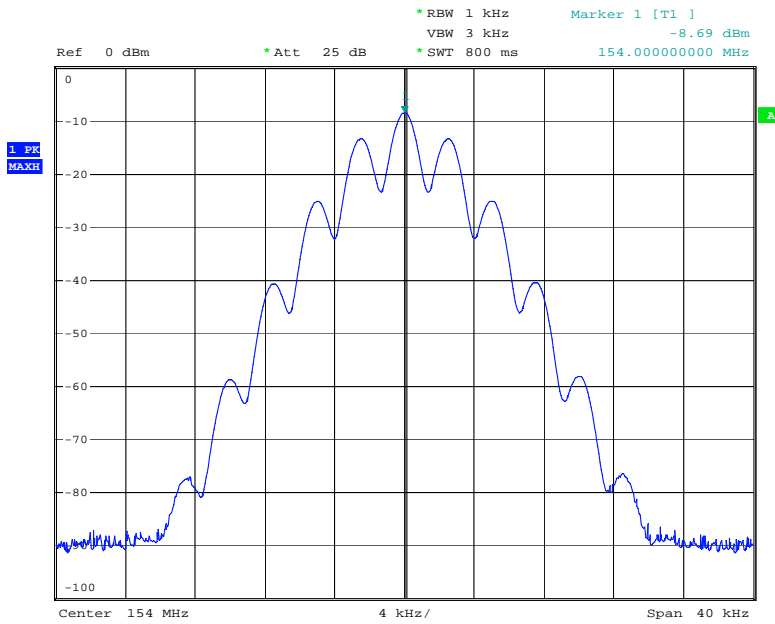

Date: 7.NOV.2007 09:52:27

Bottom channel 154.0MHz Signal Generator and EUT, deviation set to 5kHz

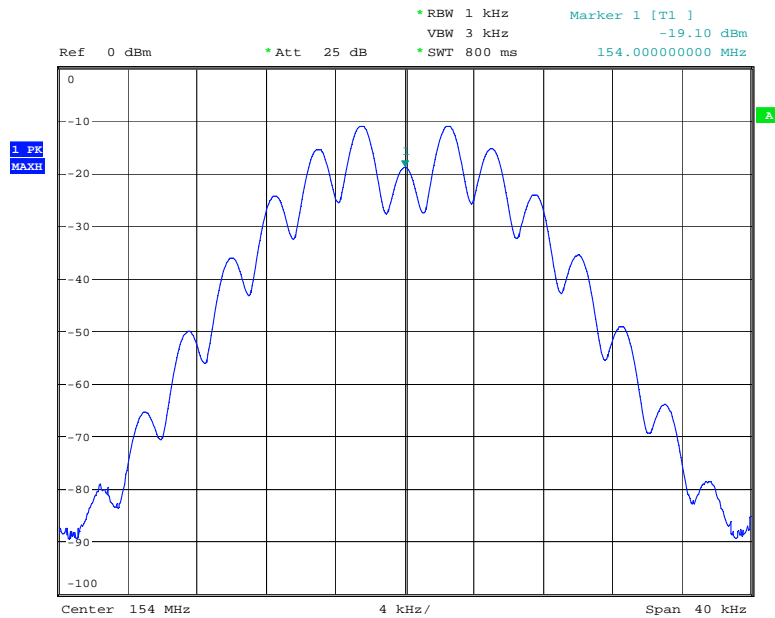

Date: 7.NOV.2007 09:50:59

The above plots depicting the output wavelshape show no measurable distortion visible when compared to the input signal.

Top channel 161.5MHz Signal Generator and EUT, deviation set to 2.5kHz

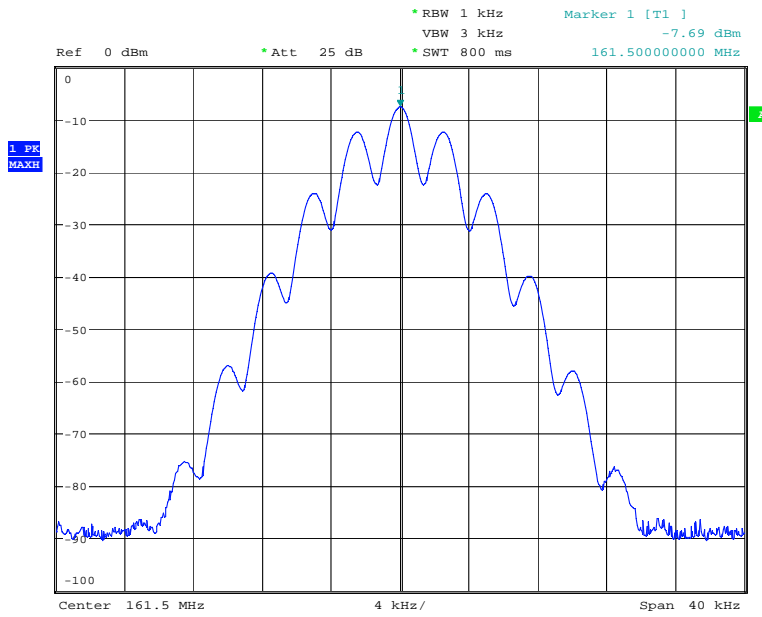

Date: 7.NOV.2007 09:56:55

Top channel 161.5MHz Signal Generator and EUT, deviation set to 5kHz

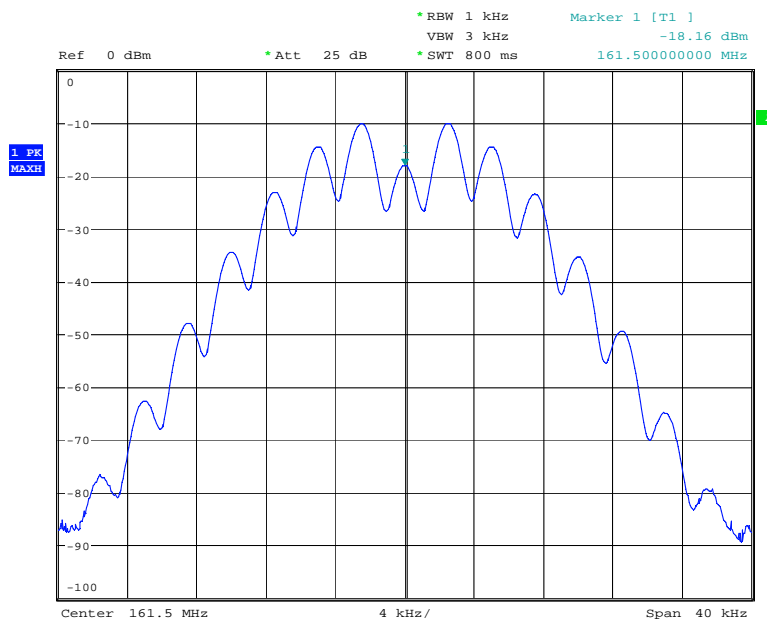

Date: 7.NOV.2007 10:02:00

The above plots depicting the output wavseshape show no measurable distortion visible when compared to the input signal.

Bottom channel 154.0MHz Signal Generator, deviation set to 2.5kHz

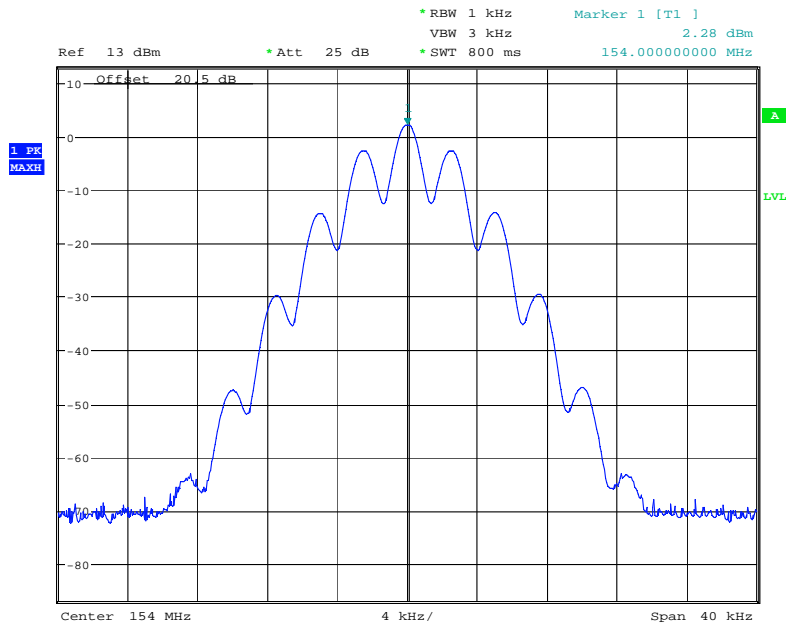

Date: 7.NOV.2007 10:09:19

Bottom channel 154.0MHz Signal Generator, deviation set to 5kHz

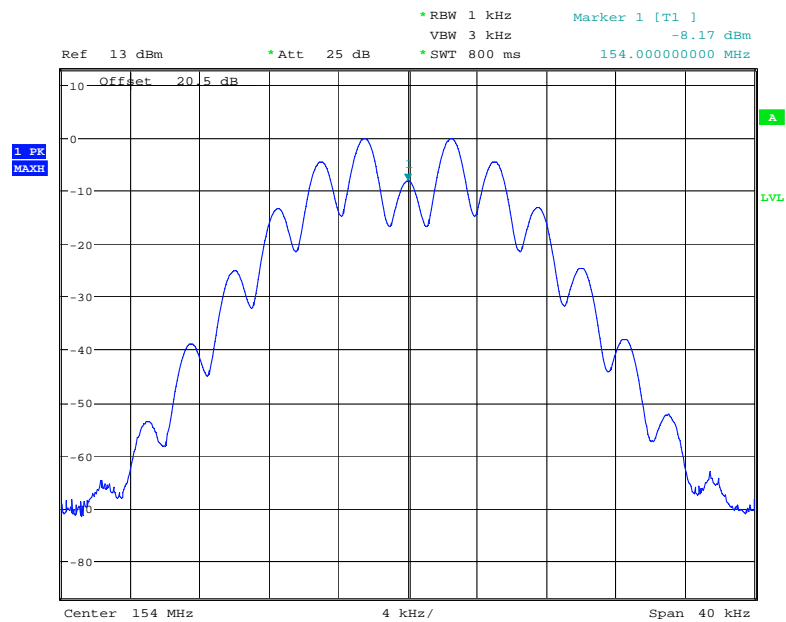

Date: 7.NOV.2007 10:11:26

The above plots depicting the output wavelshape show no measurable distortion visible when compared to the input signal.

Middle channel 157.75MHz Signal Generator, deviation set to 2.5kHz

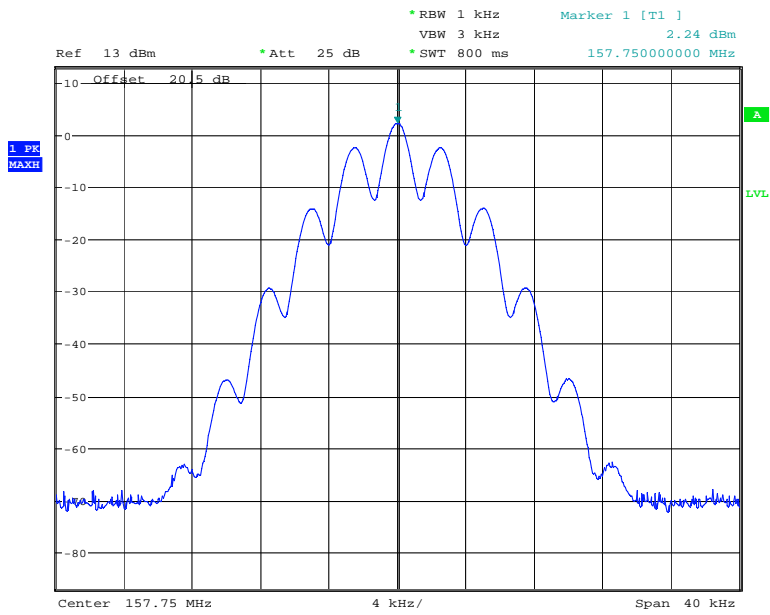

Date: 7.NOV.2007 10:13:24

Middle channel 157.75MHz Signal Generator, deviation set to 5kHz

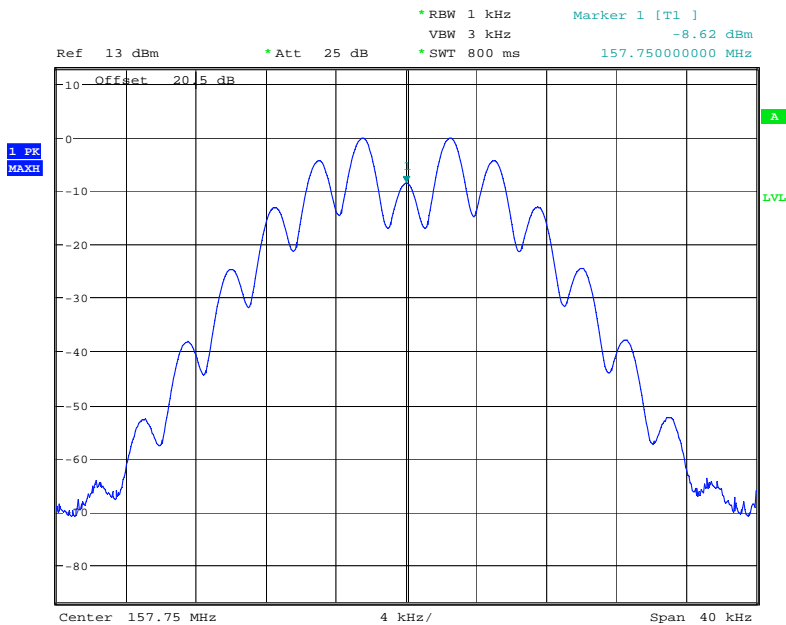

Date: 7.NOV.2007 10:16:43

The above plots depicting the output wavelshape show no measurable distortion visible when compared to the input signal.

Top channel 161.5MHz Signal Generator, deviation set to 2.5kHz

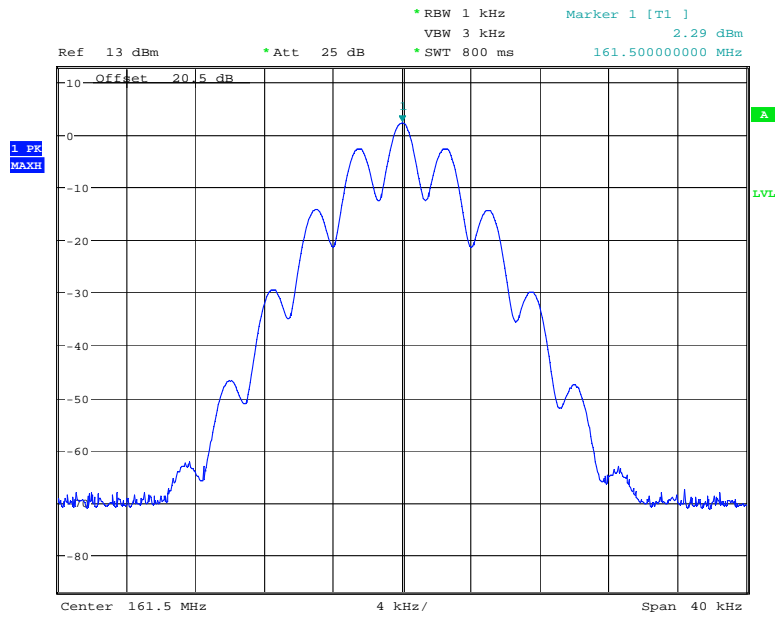

Date: 7.NOV.2007 10:19:53

Top channel 161.5MHz Signal Generator, deviation set to 5kHz

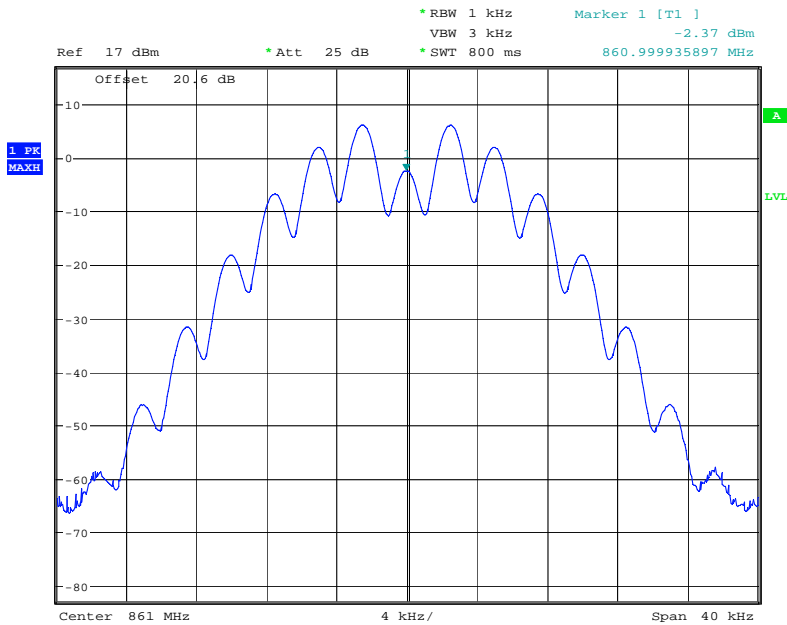

Date: 7.NOV.2007 14:06:11

The above plots depicting the output waveshape show no measurable distortion visible when compared to the input signal.

TRANSMITTER TESTS

AMPLIFIER SPURIOUS EMISSIONS – CONDUCTED – Part 2.1053 – DOWNLINK

Ambient temperature = 20°C
 Relative humidity = 55%
 Supply voltage = +24Vdc

Radio Laboratory
 Test Signal = F3E

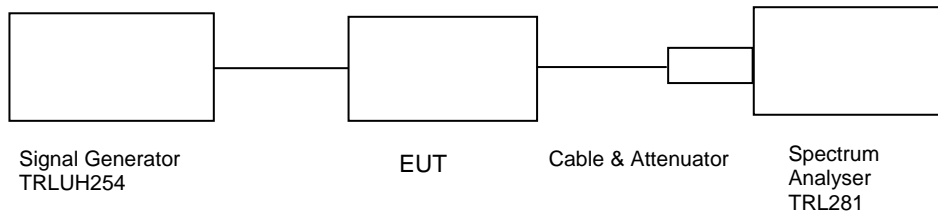

The test was set up as per the diagram. The level at the input was adjusted to compensate for the loss of the interconnecting cable. The unit was tested operating at maximum power and on three test frequencies.

The Spurious limit was calculated as follows:

On any frequency removed from the assigned frequency by more than 250% of the authorised bandwidth

At least 43 + 10 log PdB

$$(10\log P_{\text{watts}}) - (43 + 10\log (P_{\text{watts}} * 1000)) = \text{LIMIT} = -13 \text{ dBm}$$

RESULTS

FREQUENCY RANGE	FREQ. (MHz)	MEASURED LEVEL (dBm)	ATTENUATOR & CABLE LOSSES (dB)	EMISSION LEVEL (dBm)	LIMIT (dBm)
0Hz – 2GHz	No Significant Emissions Within 20 dB of the limit				-13

The test equipment used for the Transmitter Conducted Emissions:

TYPE OF EQUIPMENT	MAKER/SUPPLIER	MODEL No	SERIAL No	TRL No	ACTUAL EQUIPMENT USED
SPECTRUM ANALYSER	R&S	FSU46	200034	UH281	X
ATTENUATOR	SPINNER	745357	D57224	225	X
ATTENUATOR	BIRD	8308-200-N	N/A	103	X
SIGNAL GENERATOR	MARCONI	2042	119562/021	254	X

VHF Amplifier Downlink

Conducted emissions bottom channel 154.0MHz 30MHz – 1GHz

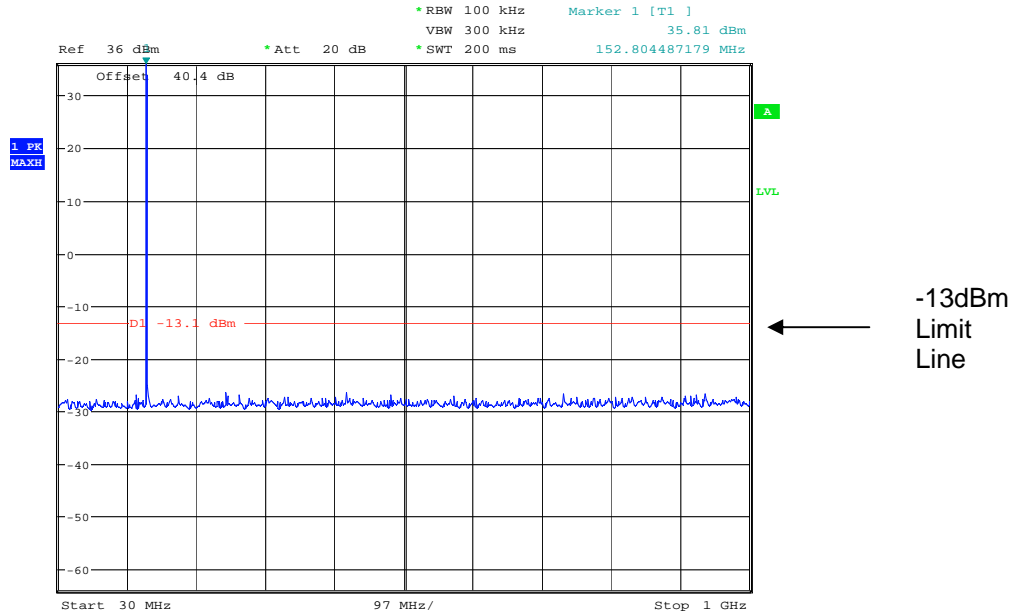

Date: 8.NOV.2007 15:49:10

Conducted emissions bottom channel 154.0MHz 1GHz – 2GHz

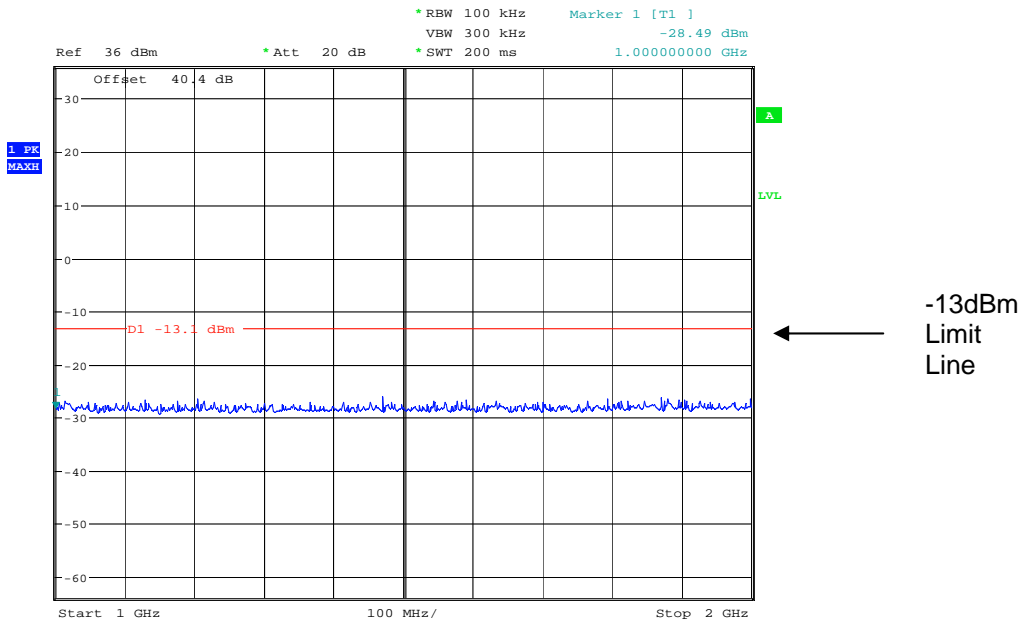

Date: 8.NOV.2007 15:49:52

Conducted emissions Middle channel 157.75MHz 30MHz – 1GHz

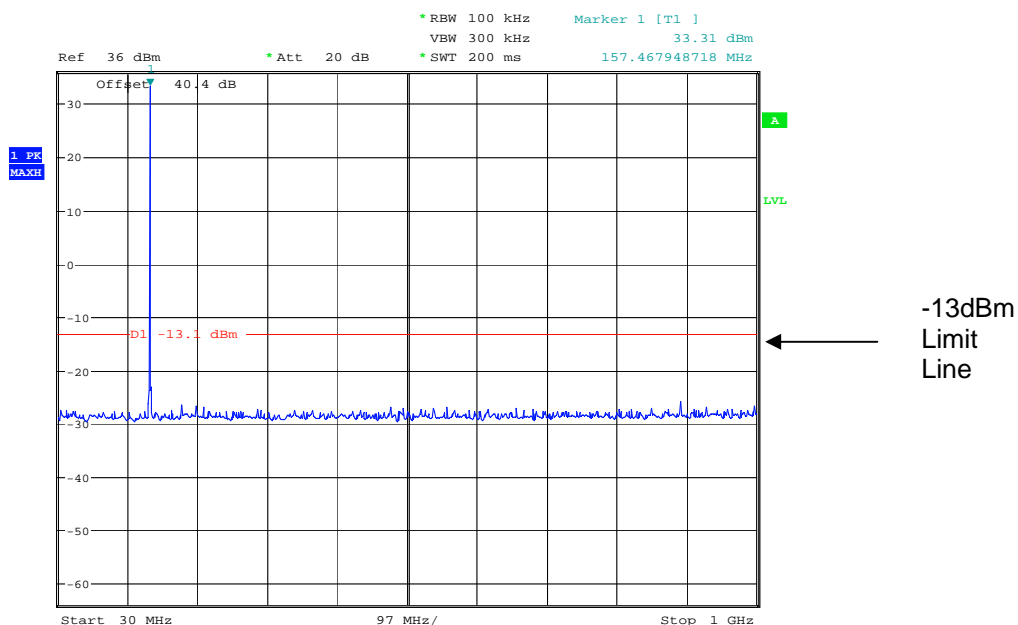

Date: 8.NOV.2007 15:50:44

Conducted emissions Middle channel 157.75MHz 1GHz – 2GHz

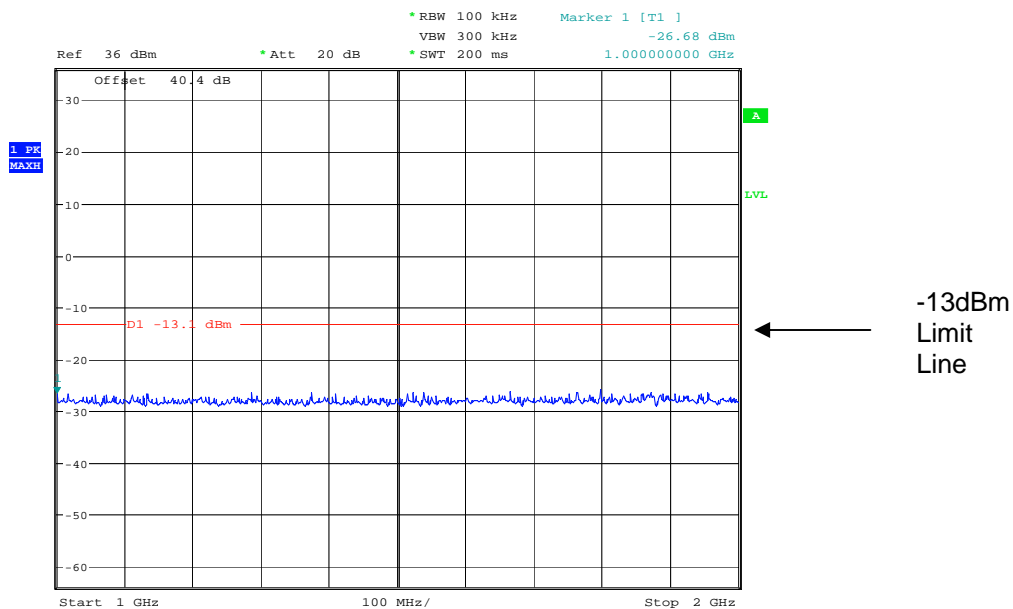

Date: 8.NOV.2007 15:51:28

TRANSMITTER TESTS

AMPLIFIER SPURIOUS EMISSIONS – RADIATED – Part 2.1053– DOWNLINK

Ambient temperature = 17°C
 Relative humidity = 44%
 Conditions = OATS
 Supply voltage = +24Vdc
 Supply Frequency = N/A

Test Signal = F3E

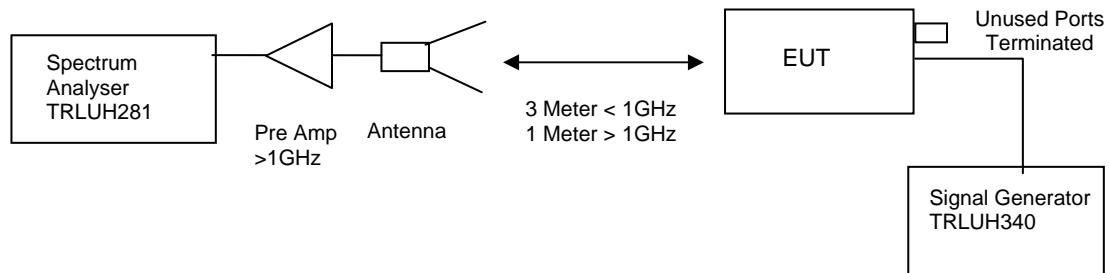

The test was set up as per the diagram. The level at the input was adjusted to compensate for the loss of the interconnecting cable. The unit was tested operating maximum power on three test frequencies with a 50 ohm load on the output. The unit was also tested with the signal generator replaced by another 50ohm load.

The Spurious limit was calculated as follows:

On any frequency removed from the assigned frequency by more that 250% of the authorised bandwidth

At least $43 + 10 \log P_{dB}$

$(10 \log P_{watts}) - (43 + 10 \log (P_{watts} * 1000)) = \text{LIMIT} = -13 \text{ dBm}$

RESULTS

FREQUENCY RANGE	FREQ. (MHz)	MEAS. Rx. (dBµV)	CABLE LOSS (dB)	ANT FACTOR	FIELD STRENGTH (dBµV/m)	CALCULATED EIRP (dBm)	LIMIT (dBm)
30MHz – 2GHz	No Significant Emissions Within 20dBs of the Limit						-13dBm

The test equipment used for the Transmitter Spurious Emissions:

TYPE OF EQUIPMENT	MAKER/SUPPLIER	MODEL No	SERIAL No	TRL No	ACTUAL EQUIPMENT USED
SPECTRUM ANALYSER	ANRITSU	MS2665C	MT26089	479	
HORN	EMCO	3115	9010-3580	138	X
SPECTRUM ANALYSER	R&S	FSU46	200034	UH281	X
PRE AMPLIFIER	HP	8449B	3008A016	572	X
SIGNAL GENERATOR	HP	83630B	3722A00588	UH340	X
ANTENNA	YORK	CBL611/A	1618	UH191	X

Radiated E-Field Emissions

EUT: LA-MTA BDA COMBINER
 Manuf: Aerial Facilities
 Op Cond: 3m Indoor Prescan MAC Chamber
 Operator: S Hodgkinson
 Test Spec: PART90
 Comment: VHF DOWNLINK,BOTTOM CHANNEL
 Rx antenna Vertical.
 Result File: 28.dat : New Measurement

Scan Settings (1 Range)				Receiver Settings				
Frequencies		Step	IF BW	Detector	M-Time	Atten	Preamp	OpRge
Start	Stop							
30MHz	1000MHz	50kHz	120kHz	PK	1msec	Auto	OFF	60dB

Transducer	No.	Start	Stop	Name
1	21	30MHz	1000MHz	UH213
	22	30MHz	1000MHz	UH191

Final Measurement: Detector: X QP
 Meas Time: 2sec
 Subranges: 50
 Acc Margin: 20 dB

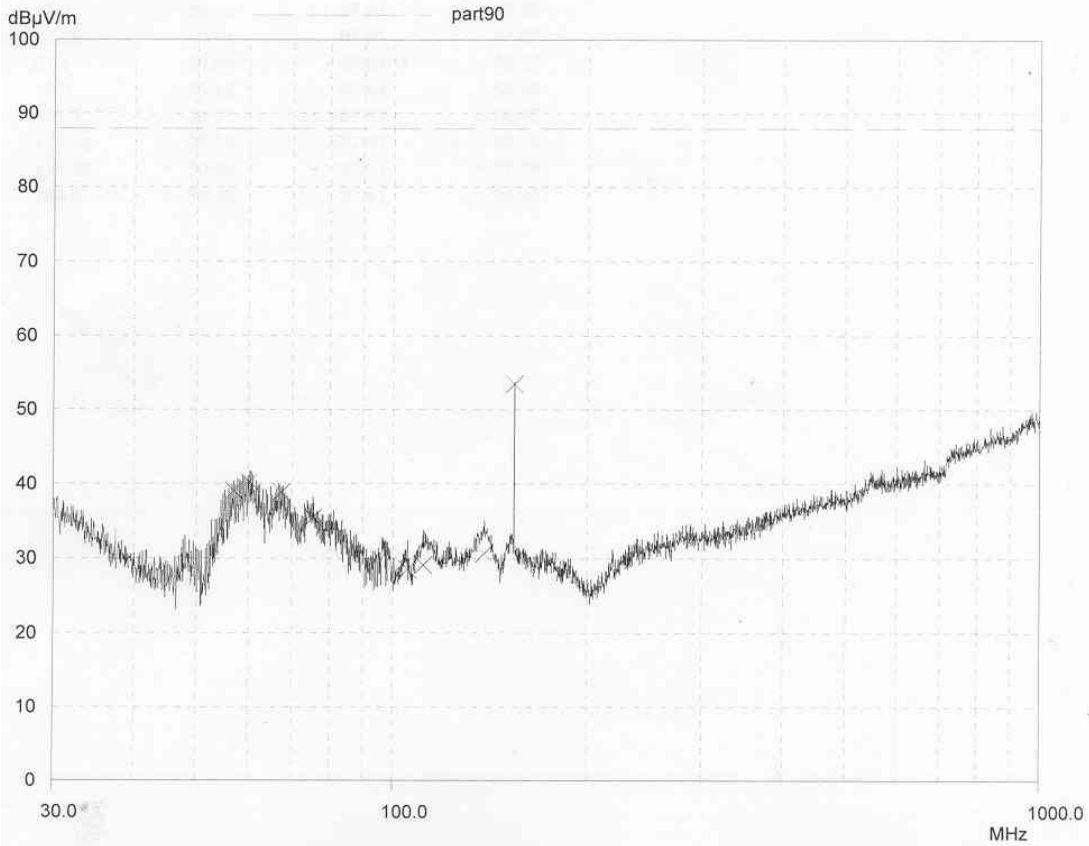

Radiated E-Field Emissions

EUT: LA-MTA BDA COMBINER
 Manuf: Aerial Facilities
 Op Cond: 3m Indoor Prescan MAC Chamber
 Operator: S Hodgkinson
 Test Spec: PART90
 Comment: VHF DOWNLINK,MIDDLE CHANNEL
 Rx antenna Vertical.
 Result File: 29.dat : New Measurement

Scan Settings (1 Range)				Receiver Settings				
Frequencies		Step	IF BW	Detector	M-Time	Atten	Preamp	OpRge
Start	Stop							
30MHz	1000MHz	50kHz	120kHz	PK	1msec	Auto	OFF	60dB
Transducer	No.	Start	Stop	Name				
1	21	30MHz	1000MHz	UH213				
	22	30MHz	1000MHz	UH191				
Final Measurement:		Detector:	X QP					
		Meas Time:	2sec					
		Subranges:	50					
		Acc Margin:	20 dB					

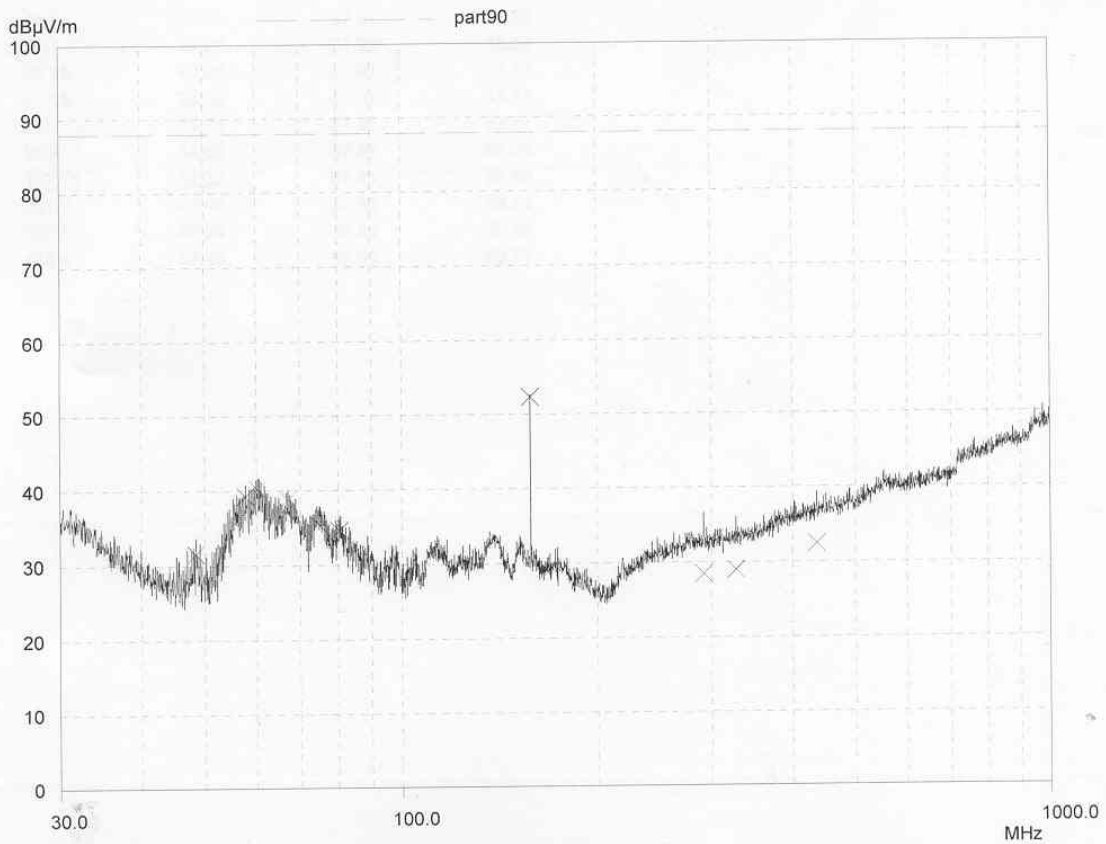

Radiated E-Field Emissions

EUT: LA-MTA BDA COMBINER
 Manuf: Aerial Facilities
 Op Cond: 3m Indoor Prescan MAC Chamber
 Operator: S Hodgkinson
 Test Spec: PART90
 Comment: VHF DOWNLINK, TOP CHANNEL
 Rx antenna Vertical.
 Result File: 31.dat : New Measurement

Scan Settings		(1 Range)			Receiver Settings				
		Frequencies							
Start	Stop	Step	IF BW	Detector	M-Time	Atten	Preamp	OpRge	
30MHz	1000MHz	50kHz	120kHz	PK	1msec	Auto	OFF	60dB	

Transducer	No.	Start	Stop	Name
1	21	30MHz	1000MHz	UH213
	22	30MHz	1000MHz	UH191

Final Measurement: Detector: X QP
 Meas Time: 2sec
 Subranges: 50
 Acc Margin: 20 dB

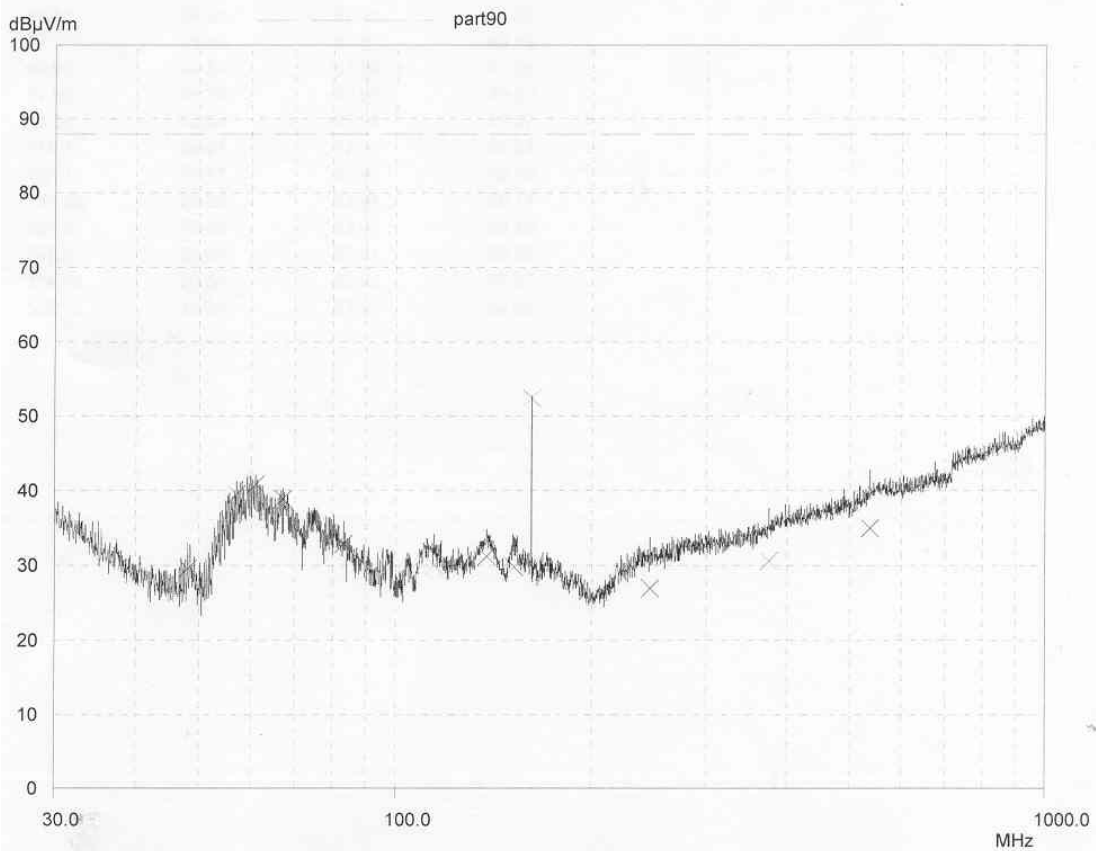

Radiated emissions bottom channel 154.0MHz 1 – 2GHz

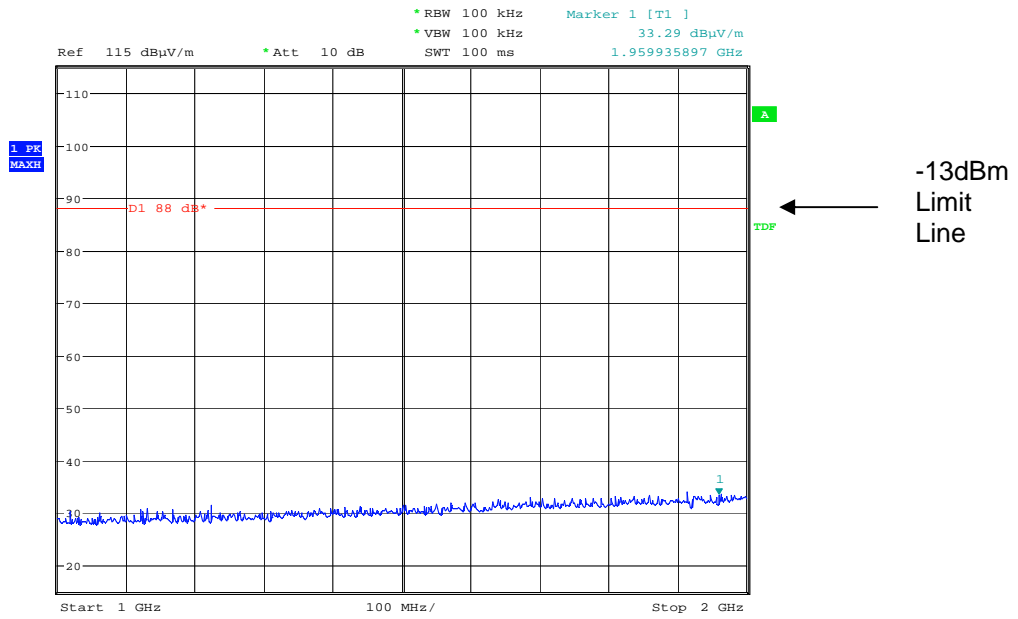

Date: 20.NOV.2007 11:11:02

Radiated emissions Middle channel 157.75MHz 1 – 2GHz

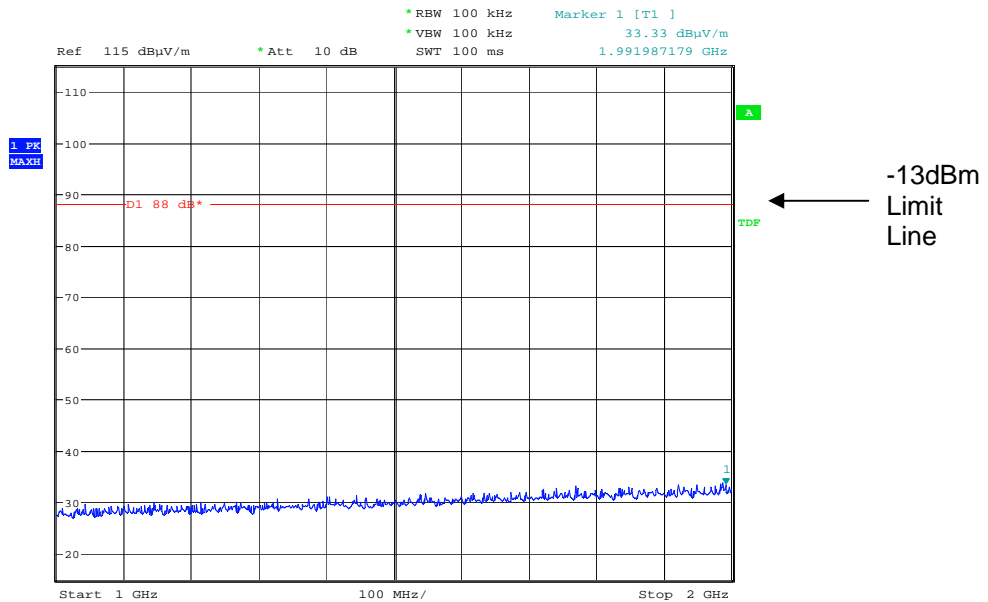

Date: 20.NOV.2007 11:11:48

Radiated emissions Top channel 161.5MHz 1 – 2GHz

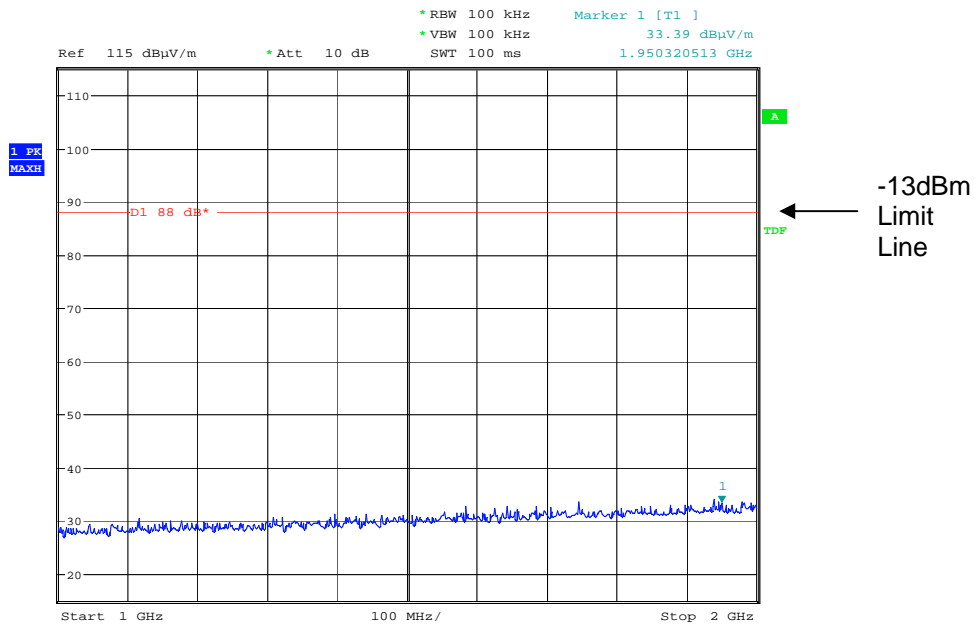

Date: 20.NOV.2007 11:12:28

The above test results show that there were no emissions within 20dBs of the -13dBm limit.

ANNEX A
PHOTOGRAPHS



ANNEX B
APPLICANT'S SUBMISSION OF DOCUMENTATION LIST

APPLICANT'S SUBMISSION OF DOCUMENTATION LIST

a.	TCB	-	APPLICATION	[X]
		-	FEE	[X]
b.	AGENT'S LETTER OF AUTHORISATION	-		[X]
c.	MODEL(s) vs IDENTITY	-		[X]
d.	ALTERNATIVE TRADE NAME DECLARATION(s)	-		[]
e.	LABELLING	-	PHOTOGRAPHS	[X]
		-	DECLARATION	[X]
		-	DRAWINGS	[X]
f.	TECHNICAL DESCRIPTION	-		[X]
g.	BLOCK DIAGRAMS	-	Tx	[X]
		-	Rx	[]
		-	PSU	[]
		-	AUX	[]
h.	CIRCUIT DIAGRAMS	-	Tx	[X]
		-	Rx	[]
		-	PSU	[]
		-	AUX	[]
i.	COMPONENT LOCATION	-	Tx	[X]
		-	Rx	[]
		-	PSU	[]
		-	AUX	[]
j.	PCB TRACK LAYOUT	-	Tx	[X]
		-	Rx	[]
		-	PSU	[]
		-	AUX	[]
k.	BILL OF MATERIALS	-	Tx	[X]
		-	Rx	[]
		-	PSU	[]
		-	AUX	[]
l.	USER INSTALLATION / OPERATING INSTRUCTIONS	-		[X]

ANNEX C
EQUIPMENT CALIBRATION

TRL Number	Equipment Type	Manufacturer	Last Cal Calibration	Calibration Period	Due For Calibration
UH06/07	IC OATS Submission	TRL	01/06/2007	24	01/06/2009
UH006	3m Range ERP CAL	TRL	08/12/2006	12	08/12/2007
UH028	Log Periodic Ant	Schwarbeck	30/05/2007	24	30/05/2009
UH029	Bicone Antenna	Schwarbeck	22/05/2007	24	22/05/2009
UH041	Multimeter	AVOmeter	04/01/2007	12	04/01/2008
UH089	Signal Generator	Marconi	09/01/2007	12	09/01/2008
UH093	Bilog Antenna	Chase	21/05/2007	24	21/05/2009
UH105	Signal Generator	Marconi	31/05/2007	12	31/05/2008
UH132	Power meter	Marconi	10/01/2007	12	10/01/2008
UH162	ERP Cable Cal	TRL	02/01/2007	12	02/01/2008
UH228	Power Sensor	Marconi	15/01/2007	12	15/01/2008
UH253	1m Cable N type	TRL	07/12/2006	12	07/12/2007
UH254	1m Cable N type	TRL	07/12/2006	12	07/12/2007
UH265	Notch filer	Telonic	11/01/2006	24	11/01/2008
UH269	1m Cable N type	TRL	07/12/2006	12	07/12/2007
UH270	1m Cable N type	TRL	07/12/2006	12	07/12/2007
UH271	1.5m Cable N type	TRL	07/12/2006	12	07/12/2007
UH272	1.5m Cable N type	TRL	07/12/2006	12	07/12/2007
UH273	2m Cable N type	TRL	07/12/2006	12	07/12/2007
UH274	2m Cable N type	TRL	07/12/2006	12	07/12/2007
UH281	Spectrum Analyser	R&S	24/07/2006	12	24/07/2007
UH297	Signal Generator	R&S	30/05/2007	12	30/05/2008
UH340	Signal Generator	HP	29/06/2006	12	29/06/2007
L005	CMTA	R&S	10/01/2007	12	10/01/2008
L007	Loop Antenna	R&S	22/05/2007	24	22/05/2009
L103	Attenuator	Bird		Calibrate in Use	
L112	Attenuator	Bird		Calibrate in Use	
L138	1-18GHz Horn	EMCO	23/05/2007	24	23/05/2009
L139	1-18GHz Horn	EMCO	23/05/2007	24	23/05/2009
L170	Combiner	Elcom		Calibrate in Use	
L176	Signal Generator	Marconi	01/03/2007	12	01/03/2008
L220	Attenuator	Bird		Calibrate in Use	
L426	Temperature Indicator	Fluke	09/01/2007	12	09/01/2008
L479	Analyser	Anritsu	09/01/2007	12	09/01/2008
L572	Pre Amplifier	HP		Calibrate in Use	

ANNEX D
MEASUREMENT UNCERTAINTY

Radio Testing – General Uncertainty Schedule

All statements of uncertainty are expanded standard uncertainty using a coverage factor of 1.96 to give a 95% confidence where no required test level exists.

[1] Adjacent Channel Power

Uncertainty in test result = **1.86dB**

[2] Carrier Power

Uncertainty in test result (Equipment - TRLUH120) = **2.18dB**

Uncertainty in test result (Equipment – TRL05) = **1.08dB**

Uncertainty in test result (Equipment – TRL479) = **2.48dB**

[3] Effective Radiated Power

Uncertainty in test result = **4.71dB**

[4] Spurious Emissions

Uncertainty in test result = **4.75dB**

[5] Maximum frequency error

Uncertainty in test result (Equipment - TRLUH120) = **119ppm**

Uncertainty in test result (Equipment – TRL05) = **0.113ppm**

Uncertainty in test result (Equipment – TRL479) = **0.265ppm**

[6] Radiated Emissions, field strength OATS 14kHz-18GHz Electric Field

Uncertainty in test result (14kHz – 30MHz) = **4.8dB**, Uncertainty in test result (30MHz – 1GHz) = **4.6dB**,

Uncertainty in test result (1GHz-18GHz) = **4.7dB**

[7] Frequency deviation

Uncertainty in test result = **3.2%**

[8] Magnetic Field Emissions

Uncertainty in test result = **2.3dB**

[9] Conducted Spurious

Uncertainty in test result (Equipment TRL479) Up to 8.1GHz = **3.31dB**

Uncertainty in test result (Equipment TRL479) 8.1GHz – 15.3GHz = **4.43dB**

Uncertainty in test result (Equipment TRL479) 15.3GHz – 21GHz = **5.34dB**

Uncertainty in test result (Equipment TRLUH120) Up to 26GHz = **3.14dB**

[10] Channel Bandwidth

Uncertainty in test result = **15.5%**

[11] Amplitude and Time Measurement – Oscilloscope

Uncertainty in overall test level = **2.1dB**, Uncertainty in time measurement = **0.59%**, Uncertainty in Amplitude measurement = **0.82%**

[11] Power Line Conduction

Uncertainty in test result = **3.4dB**

[12] Spectrum Mask Measurements

Uncertainty in test result = **2.59% (frequency)**
Uncertainty in test result = **1.32dB (amplitude)**

[13] Adjacent Sub Band Selectivity

Uncertainty in test result = **1.24dB**

[14] Receiver Blocking – Listen Mode, Radiated

Uncertainty in test result = **3.42dB**

[15] Receiver Blocking – Talk Mode, Radiated

Uncertainty in test result = **3.36dB**

[16] Receiver Blocking – Talk Mode, Conducted

Uncertainty in test result = **1.24dB**

[17] Receiver Threshold

Uncertainty in test result = **3.23dB**

[18] Transmission Time Measurement

Uncertainty in test result = **7.98%**