

Report on the Radio Testing

For

Axell Wireless Limited

on

BSF0060

Report no. TRA-029027-47-02A

17 October 2018

RF926

Report Number: TRA-029027-47-02A
Issue: A

REPORT ON THE RADIO TESTING OF A
Axell Wireless Limited
BSF0060
WITH RESPECT TO SPECIFICATION
FCC 47CFR 90

TEST DATE: 10th May-17th July 2018

Written by:

S Hodgkinson
Radio Engineer

Approved by:

J Charters
Department Manager - Radio

Date: 17 October 2018

Disclaimers:

- [1] THIS DOCUMENT MAY BE REPRODUCED ONLY IN ITS ENTIRETY AND WITHOUT CHANGE
[2] THE RESULTS CONTAINED IN THIS DOCUMENT RELATE ONLY TO THE ITEM(S) TESTED

RF926

1 Revision Record

<i>Issue Number</i>	<i>Issue Date</i>	<i>Revision History</i>
A	17 October 2018	Original

2 Summary

TEST REPORT NUMBER: TRA-029027-47-02A

WORKS ORDER NUMBER: TRA-029027

PURPOSE OF TEST: USA: Testing of radio frequency equipment per the relevant authorization procedure of chapter 47 of CFR (code of federal regulations) Part 2, subpart J.

TEST SPECIFICATION: FCC 47CFR 90

EQUIPMENT UNDER TEST (EUT): BSF0060

FCCID: NEO61-104SERIES

EUT SERIAL NUMBER: Not Stated

MANUFACTURER/AGENT: Axell Wireless Limited

ADDRESS: Aerial House
Asheridge Road
Chesham
Bucks
HP5 2QD
United Kingdom

CLIENT CONTACT: Brian Barton
☎ 01494 777 014
✉ Brian.Barton@cobham.com

TEST DATE: 10th May-17th July 2018

TESTED BY: S Hodgkinson
Element

2.1 Test Summary

Test Method and Description	Requirement Clause			Applicable to this equipment	Result / Note
	47CFR Part 90	47CFR Part 2	KDB935210 v01r02		
Out of Band Rejection	-	-	4.3	<input checked="" type="checkbox"/>	Pass
Input versus-output signal comparison	-	-	4.4	<input checked="" type="checkbox"/>	Pass
Input/output power and amplifier gain	90.219(e)(1)	2.1046	4.5	<input checked="" type="checkbox"/>	Pass
Noise figure	90.219(e)(2)	-	4.6	<input checked="" type="checkbox"/>	See note 2
Spurious emissions at antenna terminals	90.219(e)(3)	2.1051	4.7.3	<input checked="" type="checkbox"/>	Pass
Intermodulation products	90.219(e)(i)	-	4.7.2	<input checked="" type="checkbox"/>	Pass
Frequency stability	90.213	2.1055	4.8	<input checked="" type="checkbox"/>	See note1
Field strength of spurious radiation	90.219(e)(3)	2.1053	4.9	<input checked="" type="checkbox"/>	Pass
99% occupied Bandwidth	-	2.1049	-	<input checked="" type="checkbox"/>	Pass

Notes:

- 1) See Client declaration, regarding frequency stability, section of this test report.
- 2) See Client declaration, regarding good engineering practice section of this test report.
- 3) The repeater is a DAS repeater and therefore only the Downlink direction was tested
As per KDB935210 D05 section 3.2

The results contained in this report relate only to the items tested, in the condition at time of test, and were obtained in the period between the date of initial receipt of samples and the date of issue of the report.

The apparatus was set-up and exercised using the configurations, modes of operation and arrangements defined in this report only. Any modifications made are identified in Section 8 of this report.

Particular operating modes, apparatus monitoring methods and performance criteria required by the standards tested to have been performed except where identified in Section 5.2 of this test report (Deviations from Test Standards).

3 Contents

1	Revision Record	3
2	Summary	4
2.1	Test Summary	5
3	Contents	6
4	Introduction.....	8
5	Test Specifications	9
5.1	Normative References	9
5.2	Deviations from Test Standards	9
6	Glossary of Terms	10
7	Equipment Under Test.....	11
7.1	EUT Identification	11
7.2	System Equipment.....	11
7.3	EUT Mode of Operation.....	11
7.3.1	Transmissions Downlink	11
7.4	EUT Radio Frequency Parameters.....	11
7.4.1	General.....	11
7.5	EUT Description.....	12
8	Modifications.....	13
9	EUT Test Setup	14
9.1	Block Diagram	14
9.2	General Set-up Photograph.....	15
10	General Technical Parameters	16
10.1	Normal Conditions	16
10.2	AGC threshold	16
11	RF power output (mean output power)	17
11.1	Definition.....	17
11.2	Test Parameters	17
11.3	Test Limits	17
11.4	Test Method.....	18
11.5	Test Equipment.....	18
11.6	Test Results.....	19
12	Retransmitted masks	20
12.1	Definition.....	20
12.2	Test Parameters	20
12.3	Test Limits	21
12.4	Test Method.....	22
12.5	Test Equipment.....	22
12.6	Test Results.....	23
13	Noise figure	29
13.1	Definition.....	29
13.2	Test Parameters	29
13.3	Test Limits	29
13.4	Test Method.....	29
13.5	Test Equipment.....	31
13.6	Test Results.....	31
14	Out-of-band rejection.....	33
14.1	Definition.....	33
14.2	Test Parameters	33
14.3	Test Method.....	34
14.4	Test Equipment.....	34
14.5	Test Results.....	35
15	Spurious emissions at antenna terminals	36
15.1	Definition.....	36
15.2	Test Parameters	36
15.3	Test Limits	36
15.4	Test Method.....	36
15.5	Test Equipment.....	37
15.6	Test Results.....	38
16	Intermodulation products	44
16.1	Definition.....	44
16.2	Test Parameters	44
16.3	Test Limits	44
16.4	Test Method.....	44
16.5	Test Equipment.....	45
16.6	Test Results.....	46

17	Field strength of spurious radiation.....	48
17.1	Definitions.....	48
17.2	Test Parameters.....	48
17.3	Test Limits.....	48
17.4	Test Method.....	48
17.5	Test Results.....	50
18	Frequency stability.....	53
18.1	Definition.....	53
19	99% Occupied Bandwidth.....	54
19.1	Definition.....	54
19.2	Test Parameters.....	54
19.3	Test Equipment.....	54
20	Measurement Uncertainty.....	59

4 Introduction

This report TRA-029027-47-02A presents the results of the Radio testing on an Axell Wireless Limited, BSF0060 to specification FCC 47CFR 90.

The testing was carried out for Axell Wireless Limited by Element, at the address detailed below.

<input type="checkbox"/>	Element Hull Unit E South Orbital Trading Park Hedon Road Hull HU9 1NJ UK	<input checked="" type="checkbox"/>	Element Skelmersdale Unit 1 Pendle Place Skelmersdale West Lancashire WN8 9PN UK
--------------------------	---	-------------------------------------	--

This report details the configuration of the equipment, the test methods used and any relevant modifications where appropriate.

FCC Site Listing:

The test laboratory is accredited for the above sites under the US-EU MRA, Designation number UK0009.

ISED Registration Number(s):

Element Skelmersdale	3930B
Element Hull	3483A

The test site requirements of ANSI C63.4-2014 are met up to 1GHz.

The test site SVSWR requirements of CISPR 16-1-4:2010 are met over the frequency range 1 GHz to 18 GHz.

5 Test Specifications

5.1 Normative References

- CFR 47 Part 90-Private Land Mobile Radio Services
- KDB935210 D05 Industrial Booster Basic Measurement v01r02 October 27, 2017.
- CFR 47 Part 2 Frequency Allocations And Radio Treaty Matters; General Rules And Regulations

5.2 Deviations from Test Standards

There were no deviations from the test standard.

6 Glossary of Terms

§	Denotes a section reference from the standard, not this document
AC	Alternating Current
AM	Amplitude Modulated
AWGN	Additive White Gaussian Noise
BW	Bandwidth
C	Celcius
CW	Continuous Wave
Class A	Class A signal booster is designed to retransmit signals on one or more specific channels where none of its passbands exceed 75kHz.
Class B	Class B signal booster is designed to retransmit any signals within a wide frequency band greater than 75kHz.
dB	Decibels
dBm	dB relative to 1 milliwatt
CDMA	Code Division Multiple Access – a modulation technique used in cellular networks
DC	Direct Current
EIRP	Equivalent Isotropically Radiated Power
emf	electromotive force
erp	Effective Radiated Power
EUT	Equipment Under Test
f	Frequency
FCC	Federal Communications Commission
GSM	Group Special Mobile – a cellular network standard
Hz	Hertz
IC	Industry Canada (now ISED)
IF	Intermediate Frequency
ISED	Innovation, Science and Economic Development Canada
ITU	International Telecommunication Union
KDB	Knowledge Data Base (of the FCC Office of Engineering and Technology).
LO	Local Oscillator
m	metre
max	Maximum
min	Minimum
N/A	Not Applicable
No.	Number
PCB	Printed Circuit Board
PDF	Portable Document Format
PLMR	Private Land Mobile Radio
RE	Radio Equipment
RF	Radio Frequency
RH	Relative Humidity
RMS	Root Mean Square
Rx	Receiver
s	Second
Tx	Transmitter
UKAS	United Kingdom Accreditation Service
V	Volt
W	Watt
Ω	Ohm

7 Equipment Under Test

7.1 EUT Identification

- Name: BSF0060
- Serial Number: Not Stated
- Model Number: BSF3604-406.1-411
- Software Revision: SW00360 REV 1
- Build Level / Revision Number: BSF0060 REV 4

7.2 System Equipment

Equipment listed below forms part of the overall test setup and is required for equipment functionality and/or monitoring during testing. The compliance levels achieved in this report relate only to the EUT and not items given in the following list.

Optical Master Unit (OMU)

7.3 EUT Mode of Operation

7.3.1 Transmissions Downlink

The mode of operation for repeater tests was as follows: The repeater was operated at maximum gain and output power.

The test signals used were, 16K0F3E 11k3F3E, 8k10F1E, 4k00F1E

7.4 EUT Radio Frequency Parameters

7.4.1 General

Frequency bands of operation:	Downlink 406.1 MHz - 411 MHz Uplink 415 MHz - 420 MHz
Passband gain:	32dB
Supported channel bandwidth(s) & class:	Class B > 75 kHz
Rated mean output power (P_{rated}):	36.0dBm
Frequency stability:	Not Applicable, see client declaration
Nominal Supply Voltage:	110Vac

7.5 EUT Description

The EUT is a Band Selective Class B Booster, it does not provide frequency translation capability, the BSF3604 utilises filter and amplifier techniques to amplify channels within the Downlink bands 406.1-411 MHz and Uplink 415-420 MHz.

8 Modifications

No modifications were performed during this assessment.

9 EUT Test Setup

9.1 Block Diagram

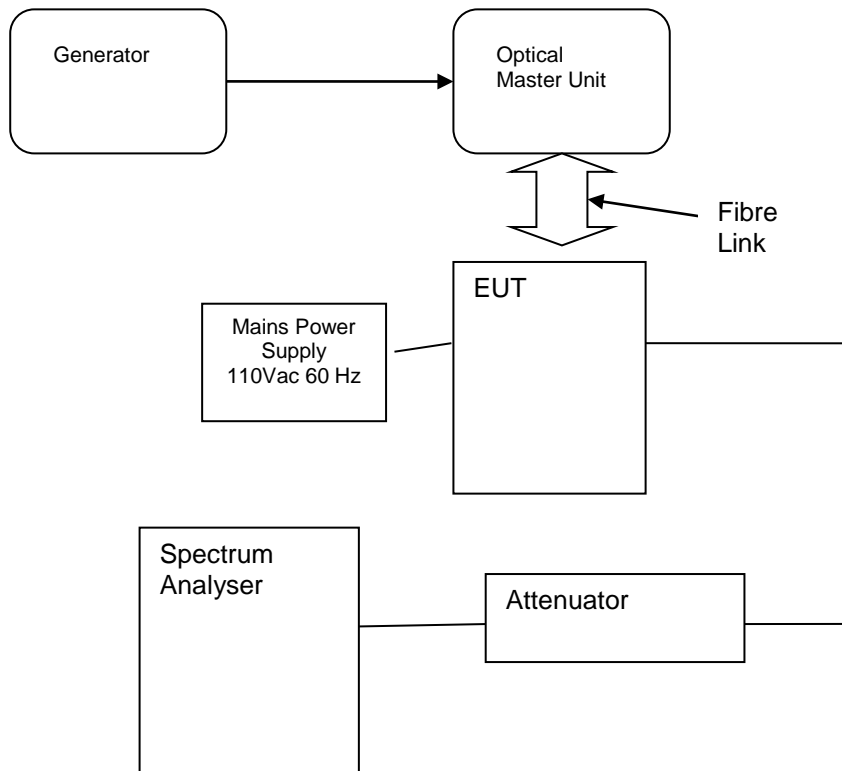

9.2 General Set-up Photograph

The following photograph shows basic EUT set-up:

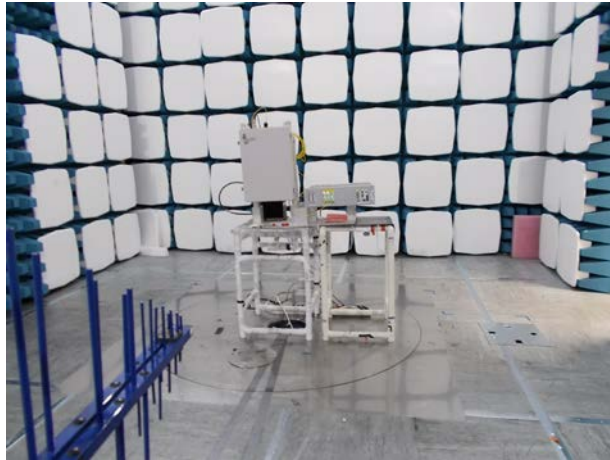

10 General Technical Parameters

10.1 Normal Conditions

The E U T was tested under the normal environmental conditions of the test laboratory, except where otherwise stated. The normal power source applied was 110 V ac from the mains.

Variation of supply voltage is required to ensure stability of the declared output power and frequency. During carrier power and frequency error testing the following variations were made:

	Category	Nominal	Variation
<input checked="" type="checkbox"/>	Mains	110V ac +/-2%	85% and 115%
<input type="checkbox"/>	Battery	New battery	N/A

10.2 AGC threshold

Testing at and above the AGC threshold was required. The AGC threshold was therefore determined per KDB 935210 D05 v01r02 4.2

11 RF power output (mean output power)

11.1 Definition

The average power supplied to the antenna transmission line by a transmitter during an interval of time sufficiently long compared with the lowest frequency encountered in the modulation taken under normal operating conditions.

11.2 Test Parameters

Test Location:	Element Skelmersdale
Test Chamber:	Radio Laboratory
Test Standard and Clause:	90.219(e)(1) KDB 935210 D05 v01r02 Clause 4.5
EUT Operating Frequency f ₀	409.501602 MHz
Source Modulations:	CW, 11K3F3E, 4K00F1E
Source Level:	4.9 dBm (maximum input rating)
Deviations From Standard:	None
Measurement BW:	RBW 100 kHz; VBW 3xRBW
Span:	1 MHz
Measurement Detector:	Peak; Max-Hold.

Environmental Conditions (Normal Environment)

Temperature: 23°C	+15 °C to +35 °C (as declared)
Humidity: 44%RH	20%RH to 75%RH (as declared)
Supply: 110 V ac	

11.3 Test Limits

The output power capability of a signal booster must be designed for deployments providing a radiated power not exceeding 5 Watts ERP for each retransmitted channel.

11.4 Test Method

Single Channel:

With the EUT setup as per section 9 of this report and connected as per Figure i, the power of the EUT was calculated by taking into account any cable and attenuator calibration factors. It was confirmed that at the maximum input level there was no compression.

Gain was calculated by removing the EUT from the setup and measuring the signal generator to EUT level.

Figure i Test Setup

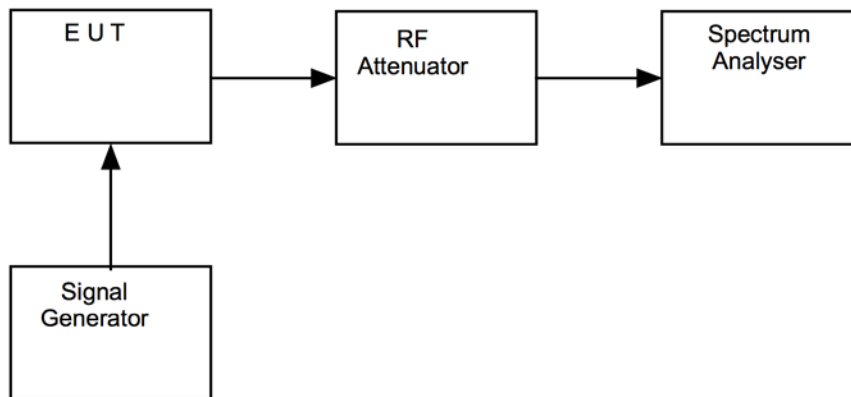

11.5 Test Equipment

<i>Equipment Description</i>	<i>Manufacturer</i>	<i>Equipment Type</i>	<i>Element No</i>	<i>Last Cal Calibration</i>	<i>Calibration Period</i>	<i>Due For Calibration</i>
Signal Generator	R&S	SMBV100A	REF916	2017-06-09	12	2018-06-09
Power Meter	Dare	RPR3006W	REF2083	2017-11-17	12	2018-11-17
Attenuator	Bird	8308-200	TRL112	Use L176 and REF910		
Attenuator	Radiall	R417030110	-	Use L176 and REF910		

11.6 Test Results

Single Channel @ AGC Threshold								
F0 Frequency (MHz)	Modulation	Signal Generator Input Level (dBm)	Input Cable Loss (dB)	Level at Spectrum Analyser (dBm)	Output Cable & Attenuator Loss (dB)	Gain (dB)	Conducted Output Power (dBm)	Result
409.501602	CW	4.90	0.6	-4.30	40.6	32.00	36.30	PASS
409.501602	P25	4.90	0.6	-4.20	40.6	32.10	36.40	PASS

Single Channel @ AGC Threshold+3								
Channel Centre Frequency (MHz)	Modulation	Signal Generator Input Level (dBm)	Input Cable Loss (dB)	Level at Spectrum Analyser (dBm)	Output Cable & Attenuator Loss (dB)	Gain (dB)	Conducted Output Power (dBm)	Result
409.501602	CW	7.90	0.6	-4.32	40.6	28.98	36.28	PASS
409.501602	P25	7.90	0.6	-4.20	40.6	29.10	36.40	PASS

12 Retransmitted masks

12.1 Definition

The emission mask is the required attenuation relative to the channel power up to 250% of the channel bandwidth. For frequencies greater than 250% of the authorized bandwidth, refer to spurious emission measurement.

12.2 Test Parameters

Test Location:	Element Skelmersdale
Test Chamber:	Radio Lab
Test Standard and Clause:	KDB 935210 D05 v01r02 Clause 4.4
EUT Operating Frequency Tested:	408.5 MHz
Source Modulations:	16K0F3E, 11K3F3E, 8k10F1E, 4k00F1E
Source Levels:	4.9 dBm 7.9dBm(AGC threshold and 3dB above)
Deviations From Standard:	None
Measurement BW:	100 Hz; VBW = 3xRBW
Span:	(2-5 times OBW)
Measurement Detector:	Peak; Max-Hold.

Environmental Conditions (Normal Environment)

Temperature: 23°C	+15 °C to +35 °C (as declared)
Humidity: 28%RH	20%RH to 75%RH (as declared)
Supply: 110 V ac	

12.3 Test Limits

5.8.2 Emission Mask C for Transmitters not Equipped With an Audio Low-Pass Filter

The power of any emission shall be attenuated below the transmitter output power P (dBW) as specified in Table 6.

Table 6 – Emission Mask C

Displacement Frequency, f_d (kHz)	Minimum Attenuation (dB)	Resolution Bandwidth (Hz)
$5 < f_d \leq 10$	$83 \log_{10}(f_d/5)$	300
$10 < f_d \leq 50$	Whichever is the lesser: 50 or $29 \log_{10}(f_d^2/11)$	300
$f_d > 50$	$43 + 10 \log_{10}(p)$	Specified in Section 4.2.1

12.4 Test Method

With the EUT setup as per section 9 of this report and connected as per Figure iv, the RF spectrum mask was measured on a spectrum analyser and compared to the signal generator output as shown on the plots.

The measurements were performed with EUT set at its nominal / maximum gain.

Figure iv Test Setup

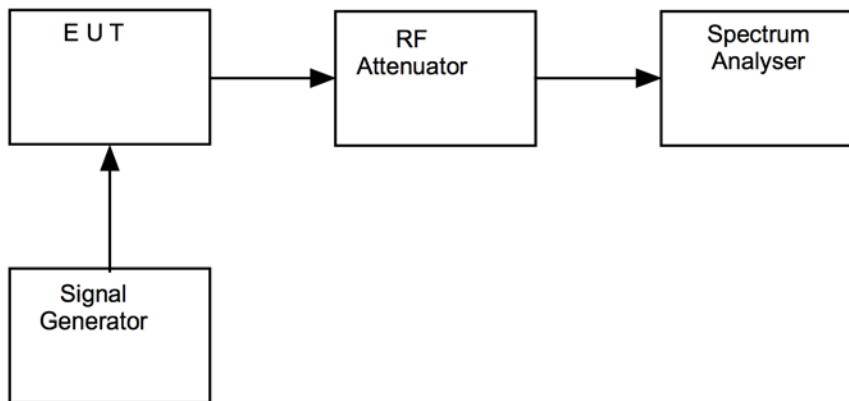

12.5 Test Equipment

<i>Equipment Description</i>	<i>Manufacturer</i>	<i>Equipment Type</i>	<i>Element No</i>	<i>Last Cal Calibration</i>	<i>Calibration Period</i>	<i>Due For Calibration</i>
Spectrum Analyser	R&S	FSU46	REF910	2017-07-13	12	2018-07-13
Signal Generator	R&S	SMBV100A	REF916	2017-06-09	12	2018-06-09
Attenuator	Bird	8308-200	TRL112	Use REF916 and REF910		
Attenuator	Radiall	R417030110	-	Use REF916 and REF910		

12.6 Test Results

Emission Mask C @ AGC Threshold					
Channel Centre Frequency (MHz)	Modulation Type				Result
	16k0F3E	11K3F3E	8k10F1E	4K00F1E	
408.5000	Compliant	Compliant	Compliant	Compliant	PASS

The above plots depicting the output spectra show no obvious distortion visible when compared to the input signal.

Emission Mask C @ AGC+3dB Threshold					
Channel Centre Frequency (MHz)	Modulation Type				Result
	16k0F3E	11K3F3E	8k10F1E	4K00F1E	
408.5000	Compliant	Compliant	Compliant	Compliant	PASS

Mask C 16k0F3E @ AGC

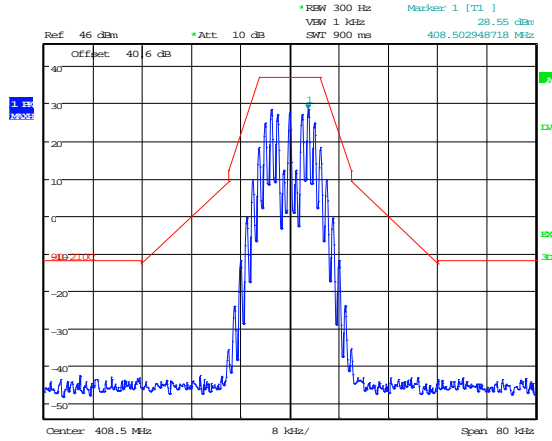

Date: 17.MAY.2018 10:17:19

Mask C 16k0F3E @ AGC+3

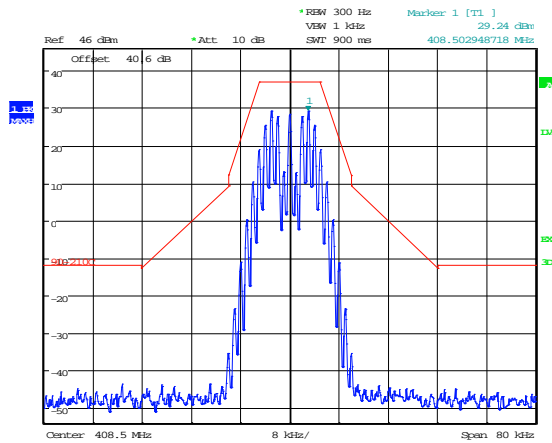

Date: 17.MAY.2018 10:17:57

16k3F3E Signal Generator

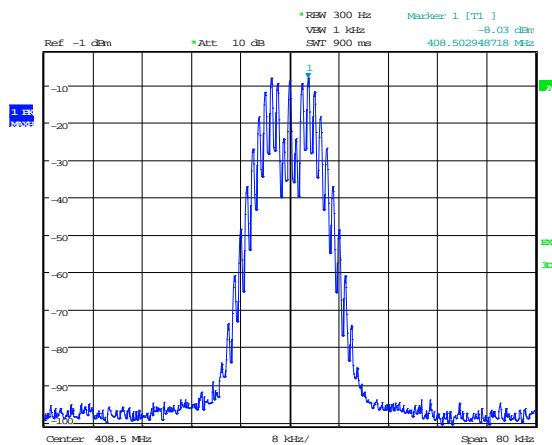

Date: 17.MAY.2018 10:19:26

The above plots depicting the output spectra show no obvious distortion visible when compared to the input signal below

Mask C 11k3F3E @ AGC

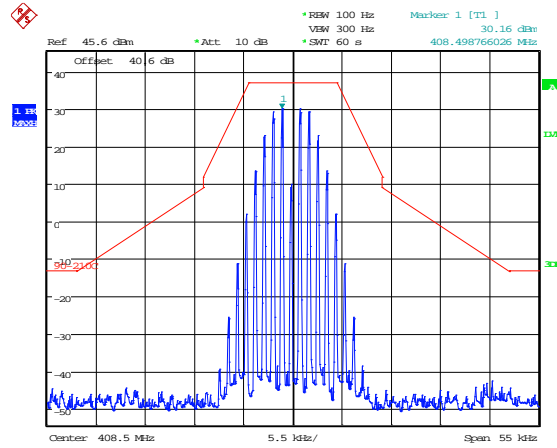

Date: 9.SEP.2018 23:16:41

Mask C 11k3F3E @ AGC+3

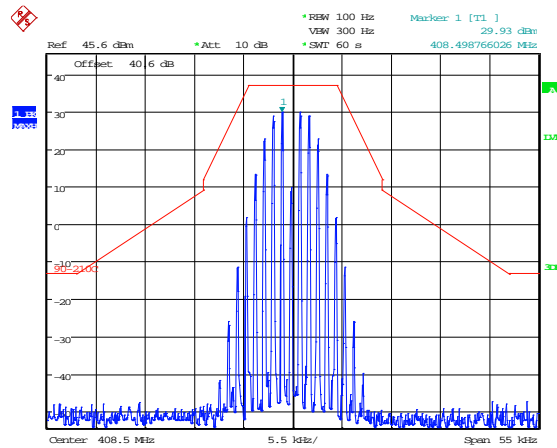

Date: 9.SEP.2018 23:18:12

The above plots depicting the output spectra show no obvious distortion visible when compared to the input signal below

11k3F3E Signal Generator

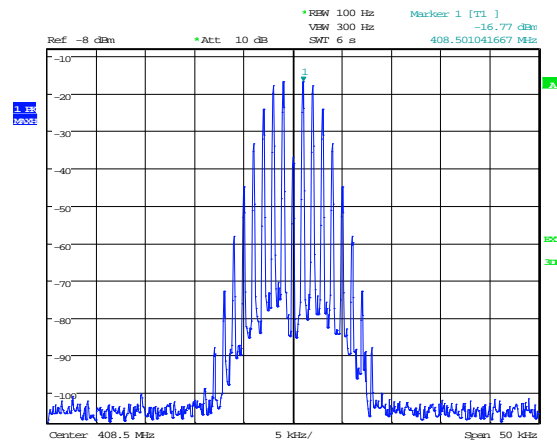

Date: 17.MAY.2018 10:24:08

Mask C 8k10F1E @ AGC

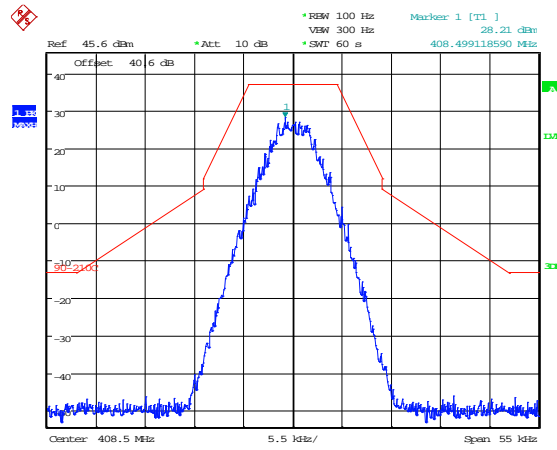

Date: 9.SEP.2018 23:25:14

Mask C 8k10F1E @ AGC+3

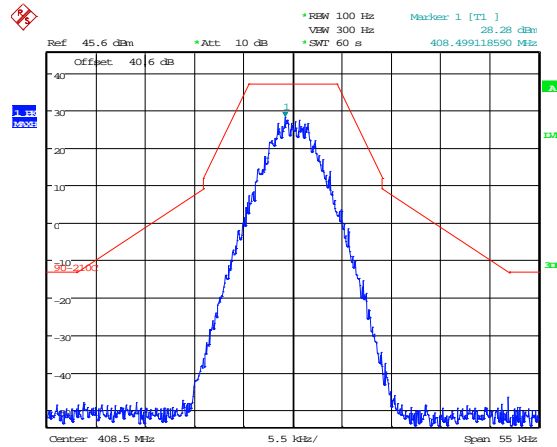

Date: 9.SEP.2018 23:26:49

The above plots depicting the output spectra show no obvious distortion visible when compared to the input signal

8k10F1E Signal Generator

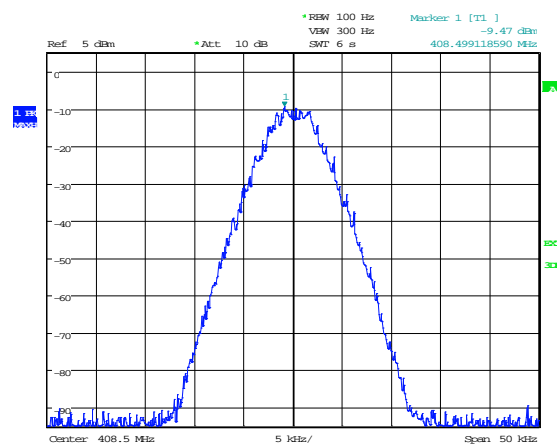

Date: 17.MAY.2018 10:39:20

Mask C 4k00F1E @ AGC

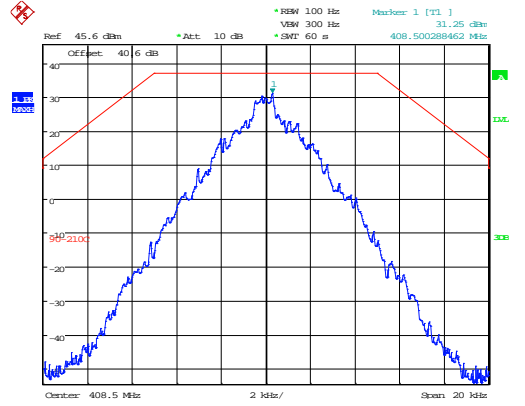

Date: 9.SEP.2018 23:29:44

Mask E 4k00F1E @ AGC+3

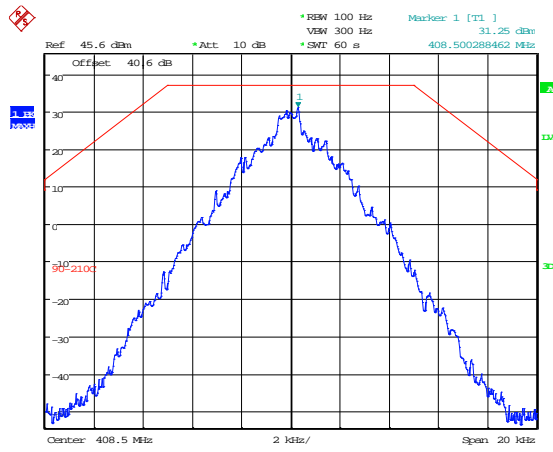

Date: 9.SEP.2018 23:30:07

Mask E 4k00F1E @ AGC+3 Wide View

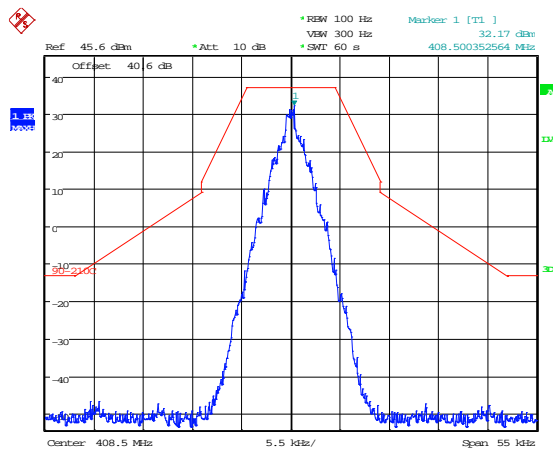

Date: 10.SEP.2018 16:23:12

The above plots depicting the output spectra show no obvious distortion visible when compared to the input signal

4k00F1E Signal Generator

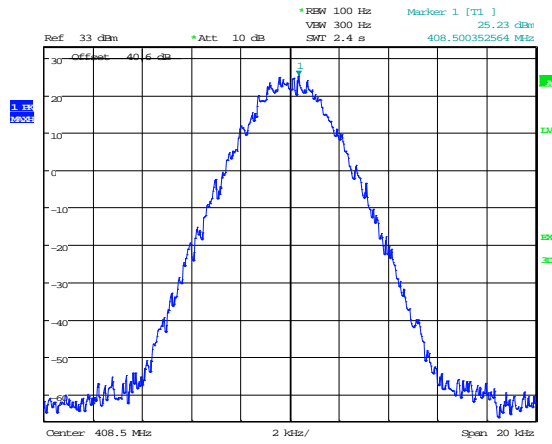

Date: 16.MAY.2018 16:57:29

13 Noise figure

13.1 Definition

A measure of the noise generated within (or degradation in signal/noise ratio as a signal passes through) the device expressed as the ratio of signal/noise power ratio at the input to signal/noise ratio at the output.

13.2 Test Parameters

Test Location:	Element Skelmersdale
Test Chamber:	Radio Laboratory
Test Standard and Clause:	Y-Factor Method (Keysight Technologies Application Note 57-2) 90.219(e)(2) KDB 935210 D05 v01, clause 4.6
EUT Frequency Tested:	408.5 MHz
Deviations From Standard:	None
Measurement BW:	RBW 10 kHz; VBW 100 kHz

Environmental Conditions (Normal Environment)

Temperature: 26°C	+15 °C to +35 °C (as declared)
Humidity: 37%RH	20%RH to 75%RH (as declared)
Supply: 110V ac	

13.3 Test Limits

The noise figure of a signal booster must not exceed 9 dB in either direction.

Or Part 90.219 Use of signal boosters.

90.219(d)(6)(ii) In general the ERP of noise within the passband should not exceed -43 dBm in a 10kHz measurement bandwidth.

90.219(d)(6)(iii) In general the ERP of noise on the spectrum more than 1MHz outside of the passband must not exceed -70dBm in a 10kHz measurement bandwidth

13.4 Test Method

The equipment was setup as shown in Figure iii. A spectrum analyser with a noise figure measurement capability was used. The spectrum analyser provided the on/off control of the noise source as well as measuring the result at its RF input. Prior to measuring the EUT, a calibration of the measurement network was performed with the EUT removed.

Figure iii Test Setup

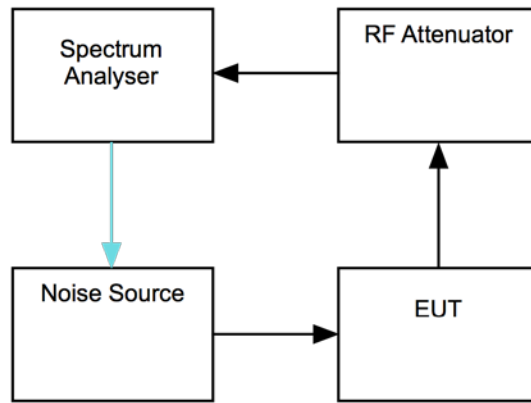

Or

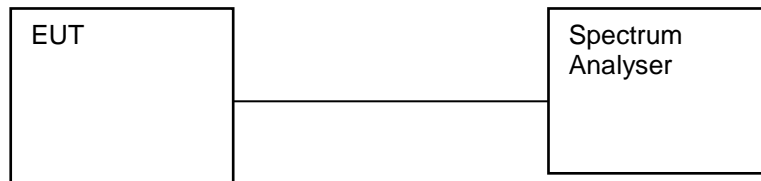

13.5 Test Equipment

Equipment Description	Manufacturer	Equipment Type	Element No	Last Cal Calibration	Calibration Period	Due For Calibration
Spectrum Analyser	R&S	FSU46	REF910	2017-07-13	12	2018-07-13

13.6 Test Results

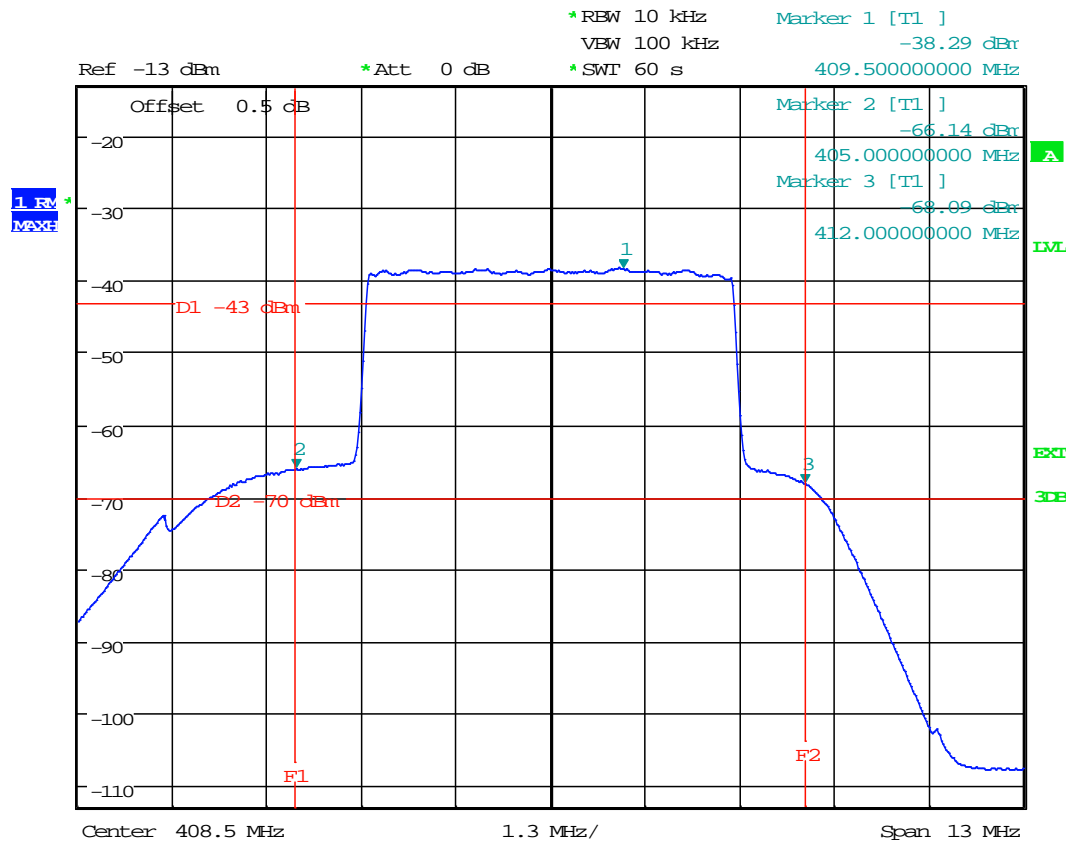

Date: 10.MAY.2018 16:17:24

As the equipment is connected to a Fibre Optic Unit, the equipment would not meet the required noise figure of 9dB in either direction.

As the equipment would be installed by a professional installation team, the installation would need to take into account any of the cable losses/splitters etc to ensure that the installation will meet the requirement.

See client statement

Note:* using the good engineering practice statement supplied by the client,

Example: In band Noise

Signal booster connected to 10 service antennas with a 100m long ½ inch cable.
Losses of such a cable with the connectors = ~ 12dB

Assuming 10 service antennas: antenna splitter losses = 11 dB
Based on equation (3) Input antenna noise (to the antenna) = $-38 - 12 - 11 = -61$ dBm ERP
The in-band input noise to the antenna should be $-38 - 12 - 11 = -61$ dBm ERP

Example: Out of band noise

Signal booster connected to 10 service antennas with a 100m long ½ inch cable.
Losses of such a cable with the connectors = ~ 12dB

Assuming 10 service antennas: antenna splitter losses = 11 dB
Based on equation (3) Input antenna noise (to the antenna) = $-66 - 12 - 11 = -89$ dBm ERP
The Out of-band input noise to the antenna should be $-66 - 12 - 11 = -89$ dBm ERP

NOTE: In this example there is no need to add an external band pass filter to attenuate the out of band noise. If fewer antennas are deployed then additional filtering may be required

Conclusion:

Good engineering practice requires that in general when the out of band noise measured at the service antenna input is more than -70 dBm per 10 kHz measurement bandwidth, an external band pass filter should be added to attenuate the out of band noise level.

All Axell Wireless repeaters include high selectivity duplexers and filters to attenuate the out of band noise. Should additional filtering be required, we have a comprehensive range of interference filters which can be supplied upon request.

14 Out-of-band rejection

14.1 Definition

The passband is the range of frequencies over which the booster is intended to apply gain. Each booster may include one or more passbands. The bandwidth of each passband is defined by two points either side of the band where the gain has fallen by 20dB from maximum.

14.2 Test Parameters

Test Location:	Element Skelmersdale
Test Chamber:	Radio Laboratory
Test Standard and Clause:	KDB 935210 D05 v01r02 Clause 4.3
Frequency Band Measured:	406.1 MHz - 411 MHz (+/-250% declared pass band)
Source Modulation:	CW
Source Level:	1.9 dBm (3dB below the AGC threshold)
Sweep Set-Up:	50kHz steps; 10ms dwell.
Deviations From Standard:	None
Measurement BW:	RBW 50 kHz (1-5% pass band); VBW 200 kHz (3xRBW).
Measurement Detector:	Peak; Max-Hold.

Environmental Conditions (Normal Environment)

Temperature: 24°C	+15 °C to +35 °C (as declared)
Humidity: 40%RH	20%RH to 75%RH (as declared)
Supply: 110 V ac	

14.3 Test Method

With the EUT setup as per section 9 of this report and connected as per Figure v, the 20dB bandwidth of the EUT was measured on a spectrum analyser. The measurements were performed with EUT set at its nominal / maximum gain.

Figure v Test Setup

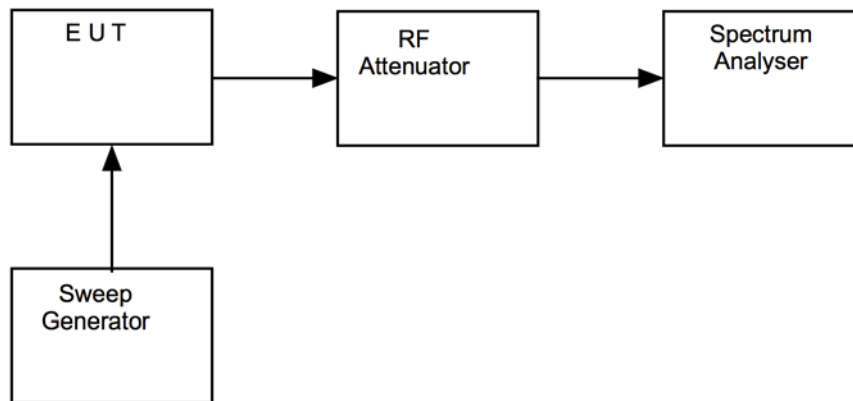

14.4 Test Equipment

<i>Equipment Description</i>	<i>Manufacturer</i>	<i>Equipment Type</i>	<i>Element No</i>	<i>Last Cal Calibration</i>	<i>Calibration Period</i>	<i>Due For Calibration</i>
Signal Generator	Marconi	2042	L176	2018-01-08	12	2019-01-08
Spectrum Analyser	R&S	FSU46	REF910	2017-07-13	12	2018-07-13
Attenuator	Bird	8308-200	TRL112	Use L176 and REF910		
Attenuator	Radiall	R417030110	-	Use L176 and REF910		

14.5 Test Results

Pass Band Nominal Centre (MHz)	Lower Mkr Frequency (MHz)	Upper Mkr Frequency (MHz)	20dB Bandwidth (MHz)	Result
408.5000	405.855769	411.144230	5.288	PASS

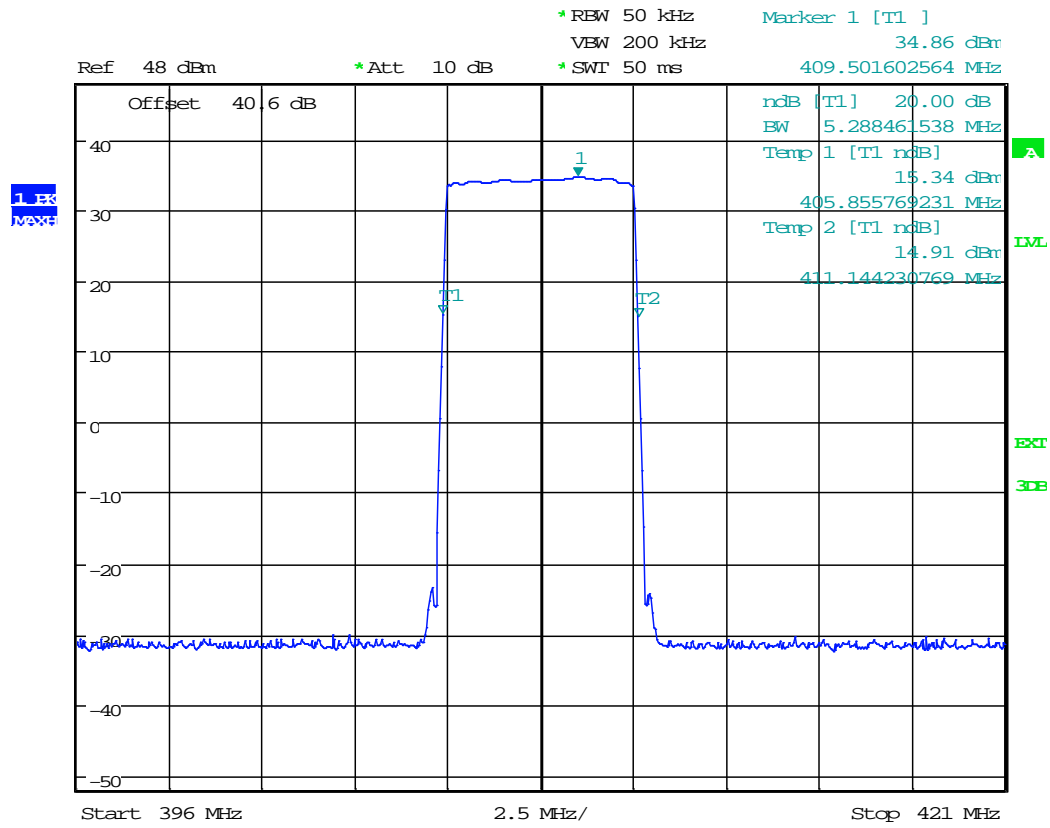

Date: 10.MAY.2018 12:03:57

F₀ = 409.501602 MHz

15 Spurious emissions at antenna terminals

15.1 Definition

Emission on a frequency or frequencies which are outside the necessary bandwidth and the level of which may be reduced without affecting the corresponding transmission of information. Spurious emissions include harmonic emissions, parasitic emissions, intermodulation products and frequency conversion products, but exclude out-of-band emissions.

15.2 Test Parameters

Test Location:	Element Skelmersdale
Test Chamber:	Radio Laboratory
Test Standard and Clause:	KDB 935210 D05 v01r02 Clause 4.7.3
EUT Operating Frequencies Tested:	406.1 MHz / 408.5 MHz / 410.99375 MHz
Source Modulations:	CW
Source Level:	4.9 dBm (maximum input rating / AGC threshold)
Deviations From Standard:	None
Measurement BW:	RBW 100 kHz; VBW = 3xRBW
Frequency Range Examined:	30 MHz – 5 GHz (10 x highest passband)
Measurement Detector:	Peak

Environmental Conditions (Normal Environment)

Temperature: 25°C	+15 °C to +35 °C (as declared)
Humidity: 38%RH	20%RH to 75%RH (as declared)
Supply: 110 V ac	

15.3 Test Limits

Spurious emissions from a signal booster must not exceed -13 dBm within any 100 kHz measurement bandwidth

15.4 Test Method

Single Channel:

With the EUT setup as per section 9 of this report and connected as per Figure vi, the emissions of the EUT were calculated by taking into account any cable and attenuator calibration factors. The power level was set so that the signal was just below the AGC threshold.

Figure vi Test Setup

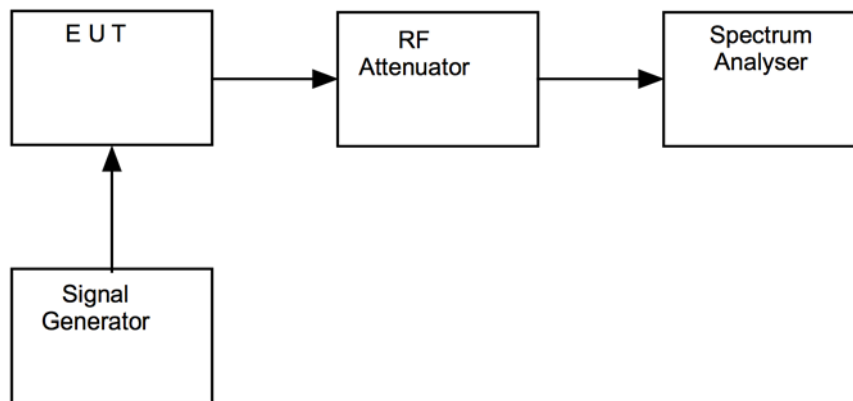

15.5 Test Equipment

<i>Equipment Description</i>	<i>Manufacturer</i>	<i>Equipment Type</i>	<i>Element No</i>	<i>Last Cal Calibration</i>	<i>Calibration Period</i>	<i>Due For Calibration</i>
Signal Generator	Marconi	2042	L176	2018-01-08	12	2019-01-08
Spectrum Analyser	R&S	FSU46	REF910	2017-07-13	12	2018-07-13
Attenuator	Bird	8308-200	TRL112	Use L176 and REF910		
Attenuator	Radiall	R417030110	-	Use L176 and REF910		

15.6 Test Results

Downlink							
Operating Frequency (MHz)	Frequency Range (MHz)	Freq. of Emission (MHz)	Measured Level (dBm)	Attenuator & Cable Losses (dB)	Spurious Emission Level (dBm)	Limit (dBm)	Result
406.10000	0.009-50000	No Significant emissions within 20dB of the limit				-13.0	PASS
408.50000	0.009-50000	No Significant emissions within 20dB of the limit				-13.0	PASS
410.99375	0.009-50000	No Significant emissions within 20dB of the limit				-13.0	PASS

Bottom 9 kHz – 150 kHz

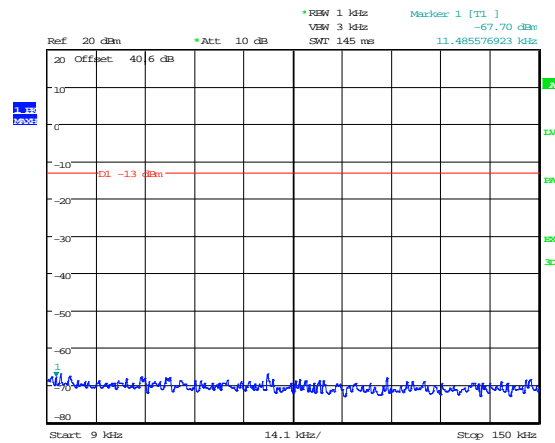

Date: 16.MAY.2018 09:43:11

Bottom 150 kHz – 30 MHz

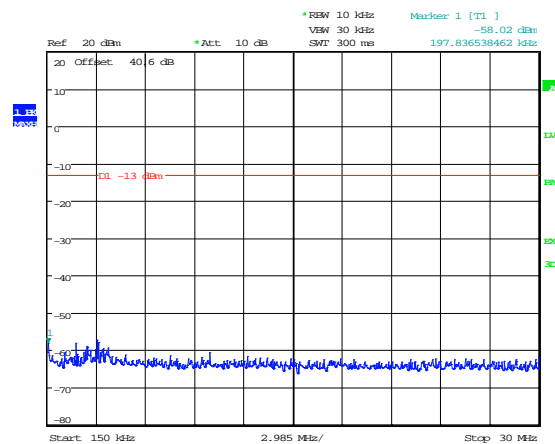

Date: 16.MAY.2018 09:43:53

Bottom 30 MHz – 1 GHz

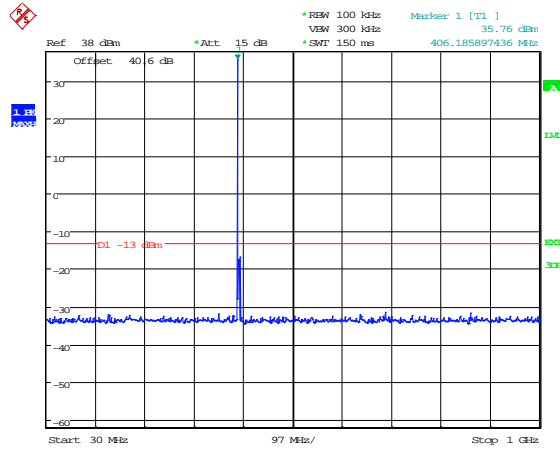

Date: 17.JUL.2018 12:30:29

Bottom 1 GHz – 5 GHz

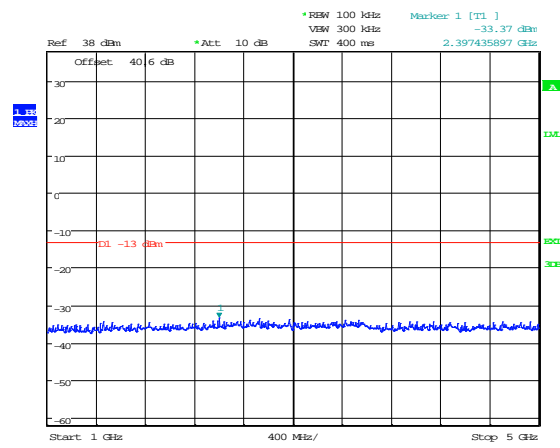

Date: 16.MAY.2018 09:42:27

Middle 9 kHz – 150 kHz

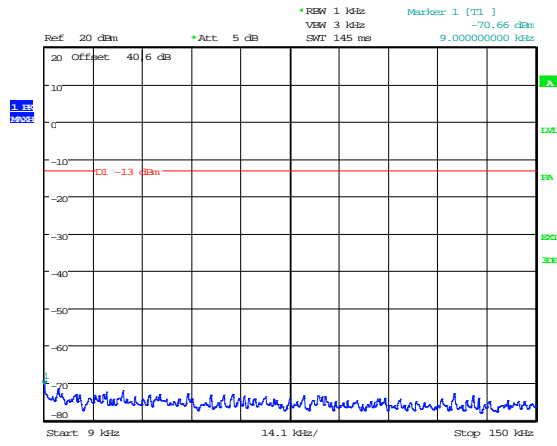

Date: 10.MAY.2018 12:44:17

Middle 150 kHz – 30 MHz

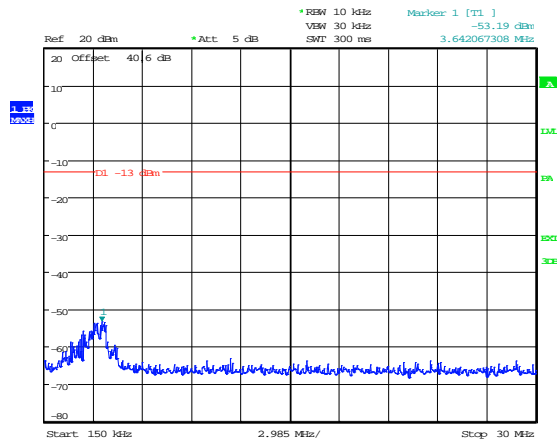

Date: 10.MAY.2018 12:43:44

Middle 30 MHz – 1 GHz

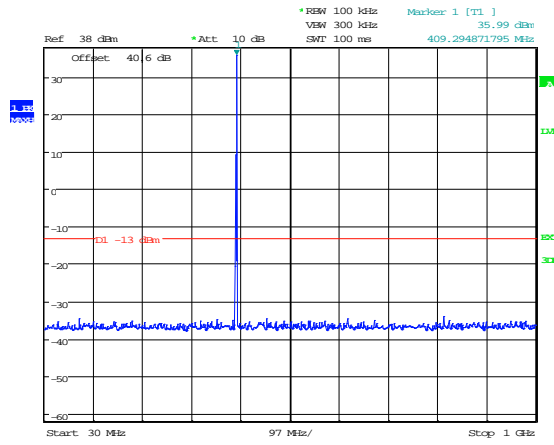

Date: 10.MAY.2018 12:49:05

Middle 1 GHz – 5 GHz

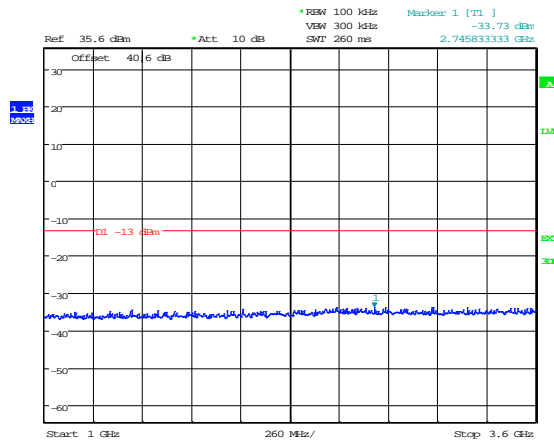

Date: 10.MAY.2018 12:57:34

Top 9 kHz – 150 kHz

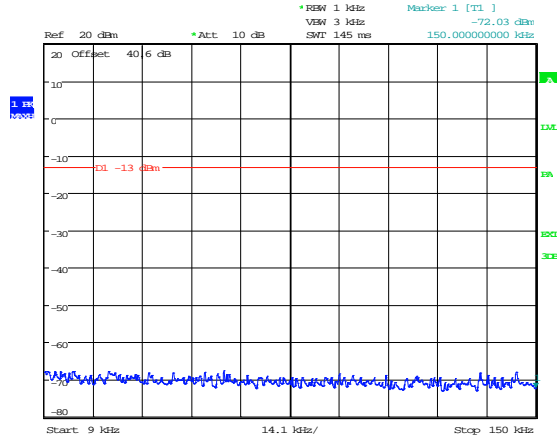

Date: 16.MAY.2018 09:44:42

Top 150 kHz – 30 MHz

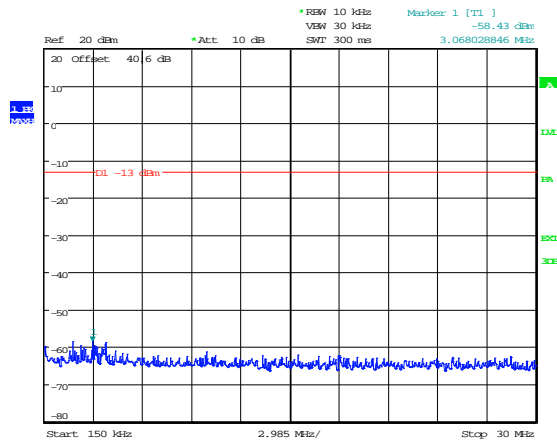

Date: 16.MAY.2018 09:45:15

Top 30 MHz – 1 GHz

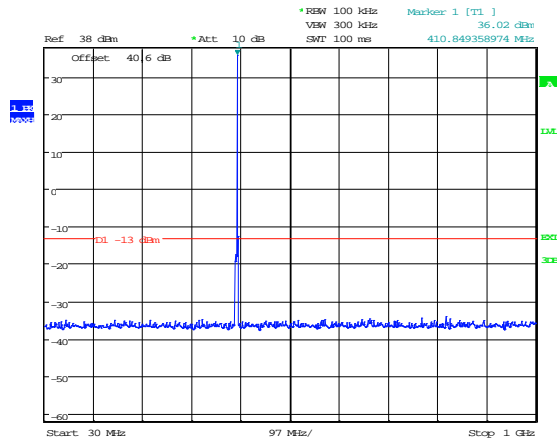

Date: 16.MAY.2018 09:46:12

Top 1 GHz – 5 GHz

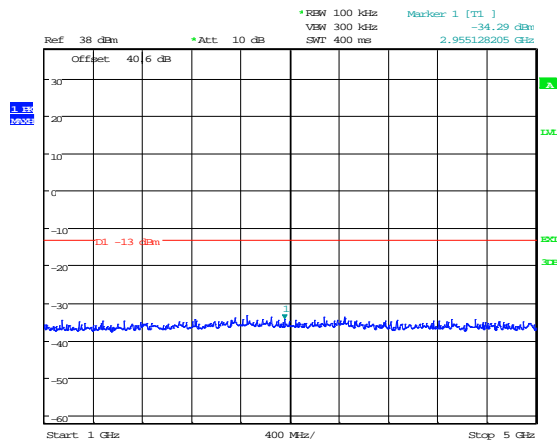

Date: 16.MAY.2018 09:46:34

16 Intermodulation products

16.1 Definition

Spurious intermodulation products result from intermodulation between: – the oscillations at the carrier, characteristic, or harmonic frequencies of an emission, or the oscillations resulting from the generation of the carrier or characteristic frequency; and – oscillations of the same nature, of one or several other emissions, originating from the same transmitting system or from other transmitters or transmitting systems.

16.2 Test Parameters

Test Location:	Element Skelmersdale
Test Chamber:	Radio Laboratory
Test Standard and Clause:	KDB 935210 D05 v01r02 clause 4.7.2 90.219(e)(i)
EUT Operating Frequency Tested:	409.501602 MHz
Source Tones:	$f_0 \pm 12.5$ kHz /6.25 kHz
Source Level:	4.9 dBm (AGC threshold); 7.9 dBm (3dB above)
Deviations From Standard:	None
Measurement BW:	RBW 300 Hz; VBW = 3xRBW
Span:	100 kHz
Measurement Detector:	Average

Environmental Conditions (Normal Environment)

Temperature: 23°C	+15 °C to +35 °C (as declared)
Humidity: 43%RH	20%RH to 75%RH (as declared)
Supply: 110 V ac	

16.3 Test Limits

The effective radiated power (ERP) of intermodulation products should not exceed -30dBm in a 10 kHz measurement bandwidth.

16.4 Test Method

With the EUT setup as per section 9 of this report and connected as per Figure viii, two tones were input to the EUT. The combined level at the EUT input was set by the attenuator to just below the EUT AGC threshold level and the intermodulation products were measured on the spectrum analyser. The measurement was repeated with the input attenuator decreased by 3dB.

Figure viii Test Setup

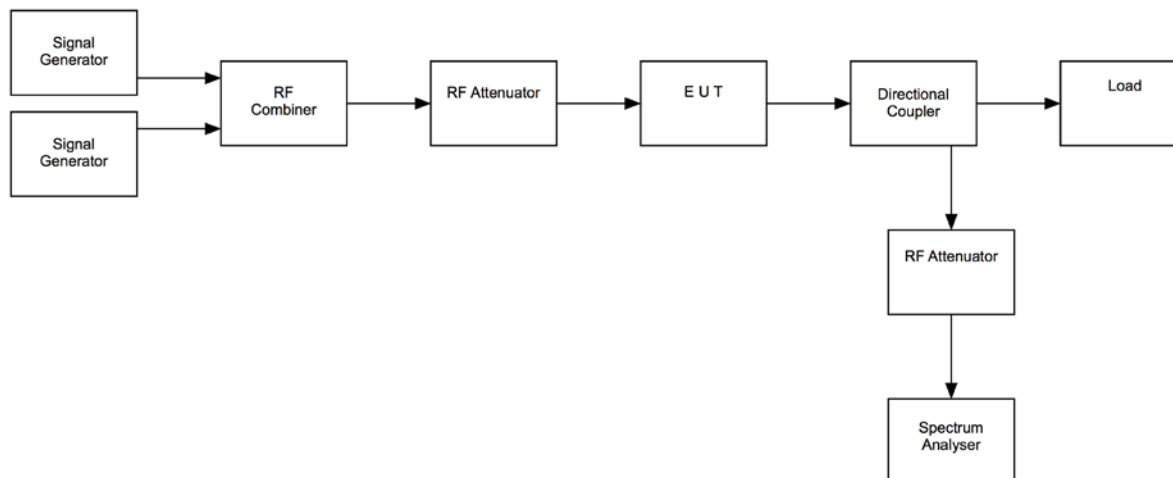

16.5 Test Equipment

<i>Equipment Description</i>	<i>Manufacturer</i>	<i>Equipment Type</i>	<i>Element No</i>	<i>Last Cal Calibration</i>	<i>Calibration Period</i>	<i>Due For Calibration</i>
Spectrum Analyser	R & S	FSU	REF910	2017-07-13	12	2018-07-13
Signal Generator	Marconi	2042	L176	2018-01-08	12	2019-01-08
Signal Generator	HP	E4433B	REF2195	2018-04-24	12	2019-04-24
Signal Combiner	Axell Wireless	REF 05-003401	-	Calibrate using REF910 & L176		
Amplifier	ENI	603L	TRL31	Calibrate using REF910 & L176		
Attenuator	Bird	8308-200-20	TRL112	Calibrate using REF910 & L176		
Attenuator	Radiall	R417030110	-	Calibrate using REF910 & L176		

16.6 Test Results

Intermodulation 12.5 kHz Channel Spacing @ AGC threshold						
Centre Frequency (MHz)	Tone 1 (MHz)	Tone 2 (MHz)	Frequency of Intermodulation Product (MHz)	Highest Intermodulation Product Level (dBm)	Limit (dBm)	Result
409.501602	409.495352	409.507852	409.520352	-43.07	-30	PASS

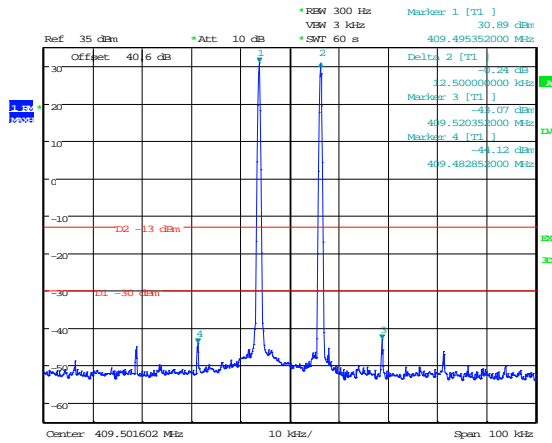

Date: 18.MAY.2018 15:55:20

Intermodulation 12.5 kHz Channel Spacing @ 3dB above AGC threshold						
Centre Frequency (MHz)	Tone 1 (MHz)	Tone 2 (MHz)	Frequency of Intermodulation Product (MHz)	Highest Intermodulation Product Level (dBm)	Limit (dBm)	Result
409.501602	409.495352	409.507852	409.520352	-45.80	-30	PASS

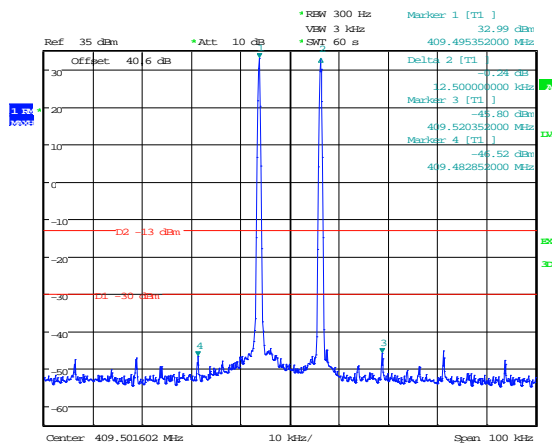

Date: 18.MAY.2018 15:56:44

Intermodulation 6.25 kHz Channel Spacing @ AGC threshold						
Centre Frequency (MHz)	Tone 1 (MHz)	Tone 2 (MHz)	Frequency of Intermodulation Product (MHz)	Highest Intermodulation Product Level (dBm)	Limit (dBm)	Result
409.501602	409.498477	409.504727	409.510896	-43.24	-30	PASS

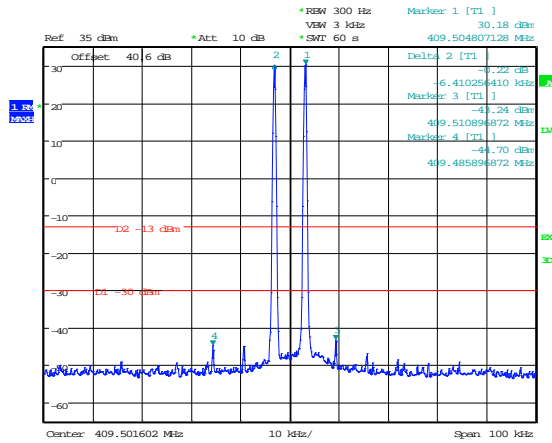

Date: 18.MAY.2018 16:00:01

Intermodulation.25 kHz Channel Spacing @ 3dB above AGC threshold						
Centre Frequency (MHz)	Tone 1 (MHz)	Tone 2 (MHz)	Frequency of Intermodulation Product (MHz)	Highest Intermodulation Product Level (dBm)	Limit (dBm)	Result
409.501602	409.498477	409.504727	409.492307	-45.09	-30	PASS

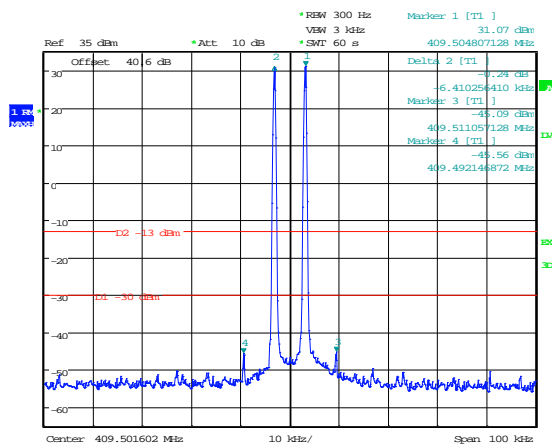

Date: 18.MAY.2018 16:02:37

17 Field strength of spurious radiation

17.1 Definitions

Spurious emissions that may be radiated directly from the cabinet, control circuits, power leads, or intermediate circuit elements under normal conditions of installation and operation.

17.2 Test Parameters

Test Location:	Element Skelmersdale
Test Chamber:	Radio Chamber 3
Test Standard and Clause:	KDB 935210 D05 v01r02 90.219(e)(3) Clause 4.9
EUT Operating Frequencies Tested:	406.1 MHz / / 408.5 MHz / 410.99375 MHz
Source Modulations:	CW
Source Level:	4.9 dBm (maximum input rating / AGC threshold)
Deviations From Standard:	None
Frequency Range Examined:	30 MHz – 5 GHz (10 x highest passband)
Measurement BW:	30 MHz to 1 GHz: 120 kHz Above 1 GHz: 1 MHz
Measurement Detector:	Up to 1 GHz: quasi-peak Above 1 GHz: Peak

Environmental Conditions (Normal Environment)

Temperature: 20 °C	+15 °C to +35 °C (as declared)
Humidity: 40 %RH	20%RH to 75%RH (as declared)
Supply: 110 Vac	

17.3 Test Limits

Spurious emissions from a signal booster must not exceed -13 dBm within any 100 kHz measurement bandwidth.

17.4 Test Method

With the EUT setup as per section 9 of this report and connected as per Figure ix and with the EUT's antenna replaced by a non-radiating load, the emissions from the EUT were measured on a spectrum analyzer / EMI receiver. The EUT was rotated in three orthogonal planes and the measurement antenna height scanned (below 1GHz, from 1 to 4 m; above 1GHz as necessary) in order to maximise emissions.

The measurements were performed with EUT set at its maximum gain. All modulation schemes, data rates and power settings were used to observe the worst-case configuration at each frequency.

The EUT was substituted with a known generator and antenna and for the same level achieved at the analyser, the effective radiated power was recorded.

Pre-scan plots are shown with a peak detector and 100kHz RBW.

Figure ix Test Setup

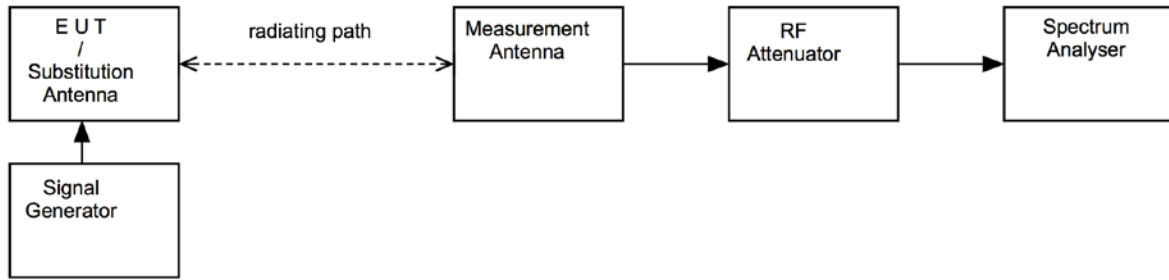

Test Setup Photograph

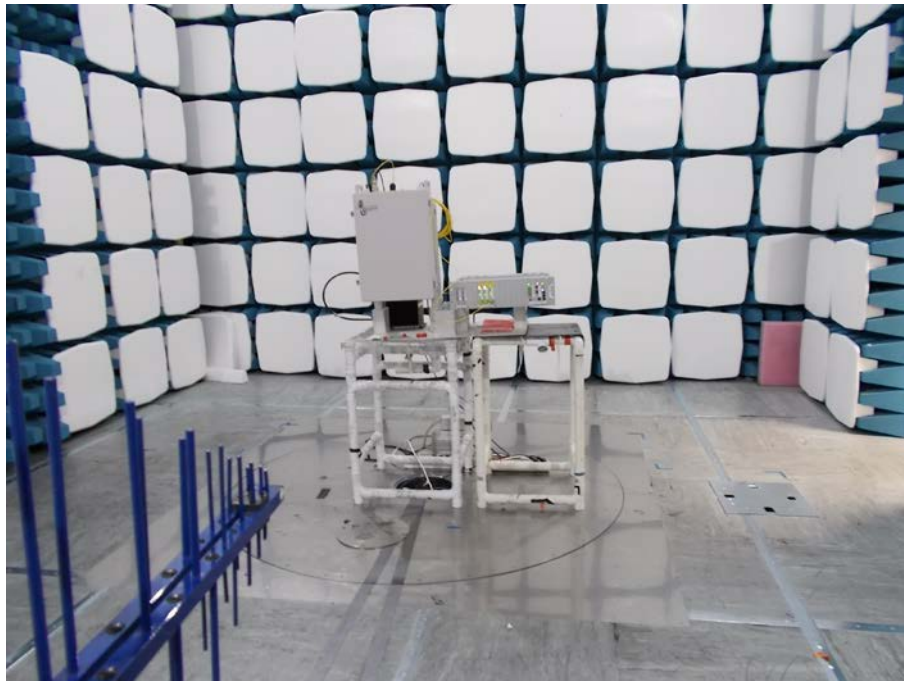

<i>Equipment Description</i>	<i>Manufacturer</i>	<i>Equipment Type</i>	<i>Element No</i>	<i>Last Cal Calibration</i>	<i>Calibration Period</i>	<i>Due For Calibration</i>
Bilog	Chase	CBL611/A	U191	2017-02-23	24	2019-02-23
1-18GHz Horn	EMCO	3115	L139	2017-09-25	24	2019-09-25
Spectrum Analyser	R&S	FSU46	U281	2017-06-19	12	2018-06-19
Pre Amp	Agilent	8449B	L572	2017-09-28	12	2018-09-28
Receiver	R&S	ESVS10	L352	2017-07-28	12	2018-07-28
Radio Chamber - PP	Rainford EMC	ATS	REF940	2017-09-08	24	2019-09-08
Signal Generator	R&S	SMBV100A	REF916	2017-06-09	12	2018-06-09

17.5 Test Results

Bottom channel Downlink 30 MHz-1 GHz

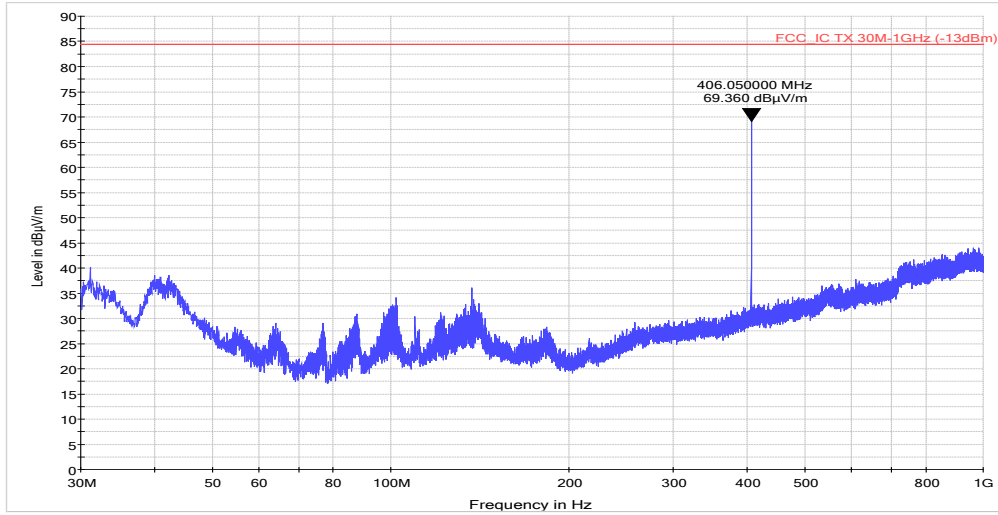

Bottom channel Downlink 1 GHz-5 GHz

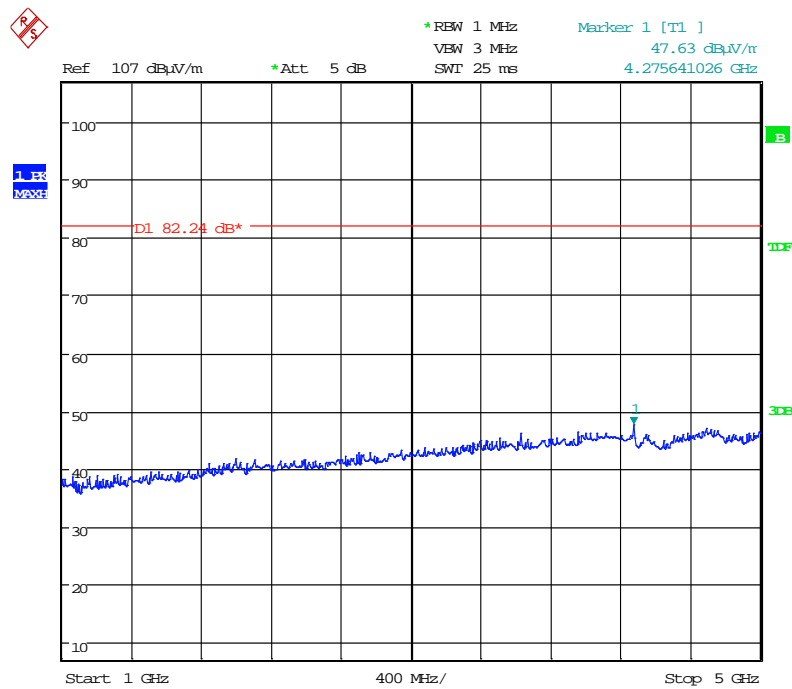

Downlink Low Frequency; 406.00625 MHz					
Emission	Frequency (MHz)	Emission level (dBm)	Limit (dBm)	Margin (dB)	Result
1	No Significant emissions				PASS

Middle channel Downlink 30 MHz-1 GHz

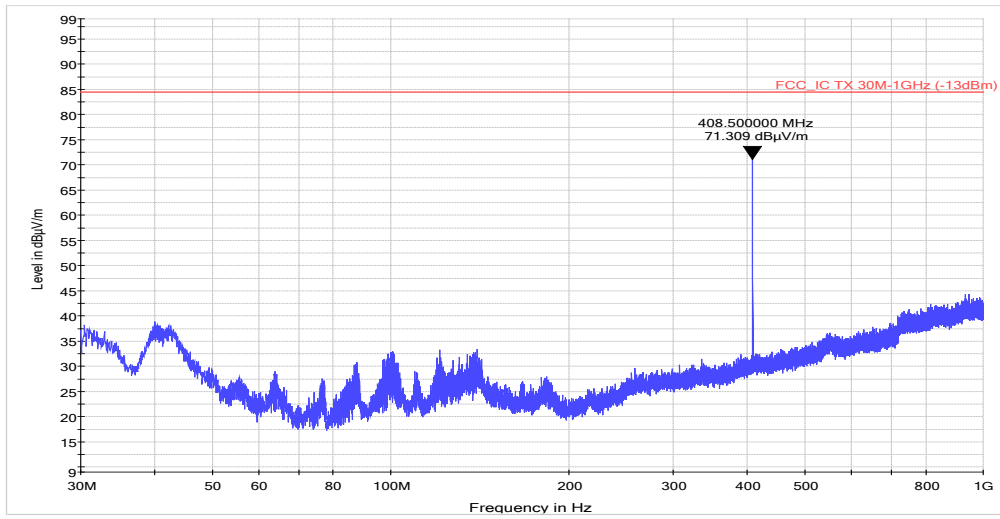

Middle channel Downlink 1 GHz-5 GHz

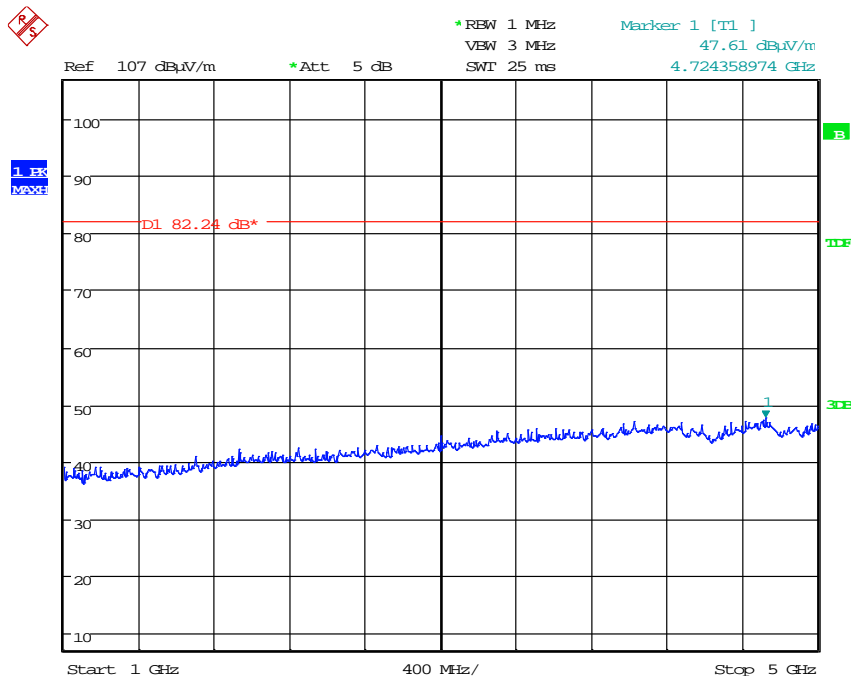

Downlink Middle Frequency; 408.5 MHz					
Emission	Frequency (MHz)	Emission level (dBm)	Limit (dBm)	Margin (dB)	Result
1	No Significant emissions				PASS

Top channel Downlink 30 MHz-1 GHz

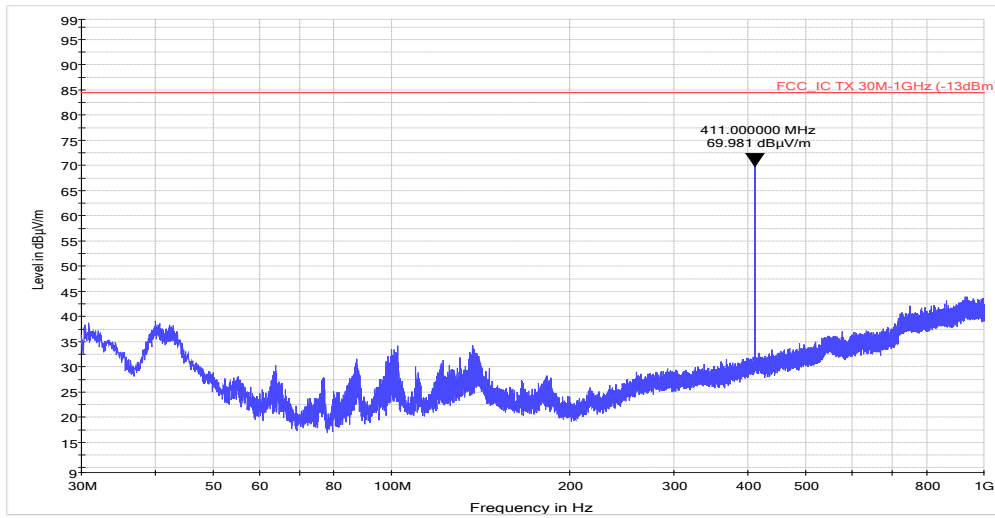

Top channel Downlink 1 GHz-5 GHz

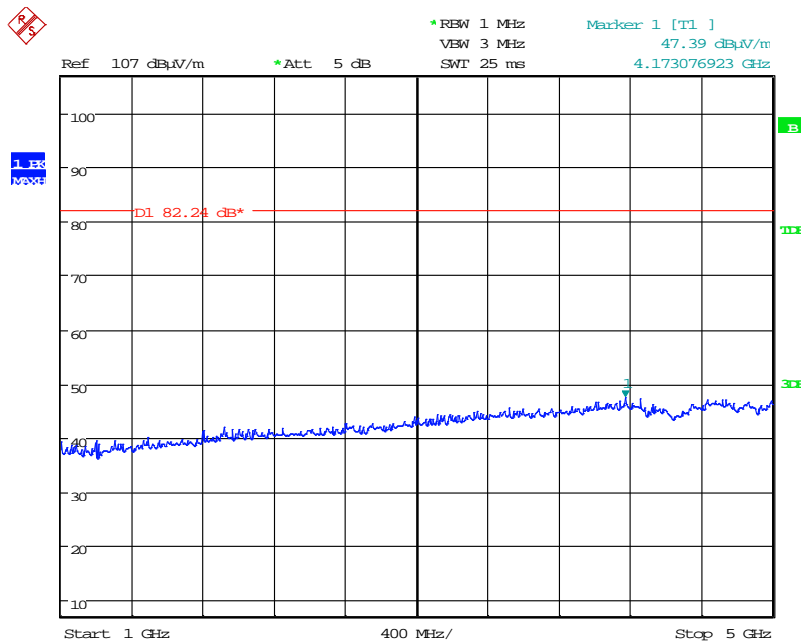

Downlink High Frequency; 410.99375 MHz					
Emission	Frequency (MHz)	Emission level (dBm)	Limit (dBm)	Margin (dB)	Result
1	No Significant emissions				PASS

18 Frequency stability

18.1 Definition

Frequency stability is a measure of the frequency drift due to temperature and supply voltage variations, with reference to the frequency measured at +20C and rated supply voltage.



Frequency Stability of Digital Repeaters

Axell Wireless legacy channel selective repeaters take the wanted signal, mixed with a local oscillator down to an IF frequency where the filtering is carried out and then is mixed back to the original frequency with the same local oscillator. If you do the calculations on this process any drift of the local oscillator cancels out and the output always equals the input frequency. Local oscillator drift has the effect of moving the filter centre frequency with respect to the signal so in an extreme case it could result in sideband cutting or even tuning to the next channel but still the output = input.

In a digital repeater exactly the same thing happens with the up/down converter because the conversion process to IF is the same. In the case of a digital repeater the filtering is not based on fixed crystal resonator elements but sampling and calculation based on the same reference oscillator that drives the synthesisers. The effect is the same, the exact filter frequency moves but again the drift cancels and we always have output = input.

There is one more thing to consider, a digital repeater is capable of being programmed for frequency translation but usually it isn't. This would only be done in very rare cases where the licensing administration allows it. Usually it involves a fixed offset (but it need not be), e.g. Output = Input +4MHz. A frequency translating repeater is easy to recognise as in the GUI there will be separate frequency selection boxes for input and output frequency of each channel. In this case the cancellation of reference oscillator error is slightly imperfect and a small residual offset is introduced. The offset is in error by the PPM error of the reference, e.g. the 10MHz reference has an error of +1ppm. A non-frequency shifting repeater with a channel centre frequency of 400MHz moves by 1ppm now becoming centred at 400Hz high, in a frequency shifting repeater (say for argument up by 4MHz) the input channel centred at 400MHz still moves high by 400Hz but now the intended 4MHz shift increases by 4Hz.

19 99% Occupied Bandwidth

19.1 Definition

The emission bandwidth (x dB) is defined as the frequency range between two points, one above and one below the carrier frequency, at which the spectral density of the emission is attenuated x Db Below the maximum in band spectral density of the modulated signal. Spectral density (power per unit bandwidth) is to be measured with a detector of resolution bandwidth in the range of 1% to 5% of the Anticipated emission bandwidth, and a video bandwidth at least 3 x the resolution bandwidth.

19.2 Test Parameters

Test Location:	Element Skelmersdale
Test Chamber:	Radio Lab
Test Standard and Clause:	2.1049
EUT Operating Frequency Tested:	408.5 MHz
Source Modulations:	16K0F3E, 11K3F3E, 8k10FIE, 4k00FIE
Deviations From Standard:	None
Measurement BW:	RBW 300Hz / 100Hz ; VBW =3xRBW
Span:	35/25 kHz (2-5 times OBW)
Measurement Detector:	Peak; Max-Hold.

Environmental Conditions (Normal Environment)

Temperature: 25°C	+15 °C to +35 °C (as declared)
Humidity: 38%RH	20%RH to 75%RH (as declared)

19.3 Test Equipment

<i>Equipment Description</i>	<i>Manufacturer</i>	<i>Equipment Type</i>	<i>Element No</i>	<i>Last Cal Calibration</i>	<i>Calibration Period</i>	<i>Due For Calibration</i>
Signal Generator	Marconi	2042	L176	2018-01-08	12	2019-01-08
Spectrum Analyser	R&S	FSU46	REF910	2017-07-13	12	2018-07-13
Signal Generator	R&S	SMBV100A	REF916	2017-06-09	12	2018-06-09
Attenuator	Bird	8308-200	TRL112	Use L176 and REF910		
Attenuator	Radiall	R417030110	-	Use L176 and REF910		

Modulation Type 16K0F3E 99% OCBW Downlink @ AGC			
Channel Centre Frequency (MHz)	F _I (MHz)	F _H (MHz)	99% bandwidth (kHz)
408.5000	408.492651	408.507347	14.69

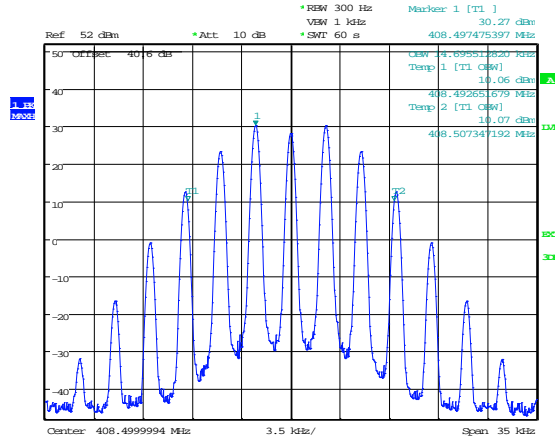

Date: 10 MAY 2018 13:20:32

Modulation Type 16K0F3E 99% OCBW Downlink @ AGC + 3			
Channel Centre Frequency (MHz)	F _I (MHz)	F _H (MHz)	99% bandwidth (kHz)
408.5000	408.492651	408.507347	14.69

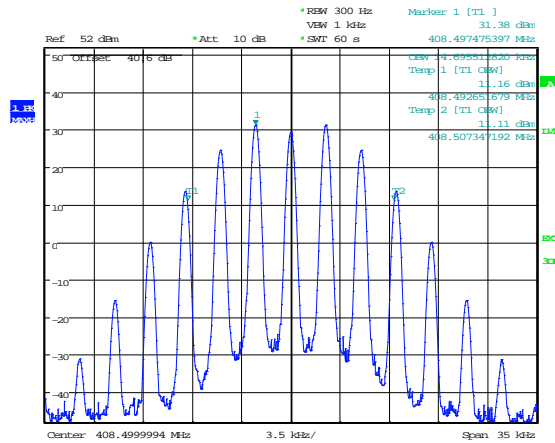

Date: 10 MAY 2018 13:22:00

Modulation Type 11K0F3E 99% OCBW Downlink @ AGC			
Channel Centre Frequency (MHz)	F _I (MHz)	F _h (MHz)	99% bandwidth (kHz)
408.5000	408.494951	408.505047	10.096

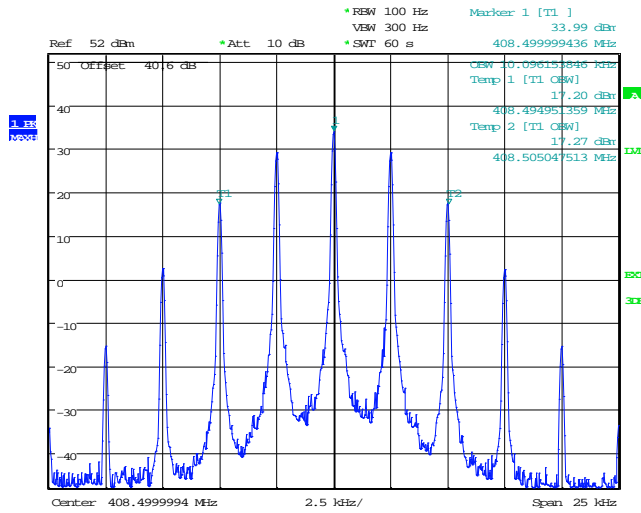

Date: 10.MAY.2018 14:27:39

Modulation Type 11K0F3E 99% OCBW Downlink @ AGC + 3			
Channel Centre Frequency (MHz)	F _I (MHz)	F _h (MHz)	99% bandwidth (kHz)
408.5000	408.494951	408.505047	10.096

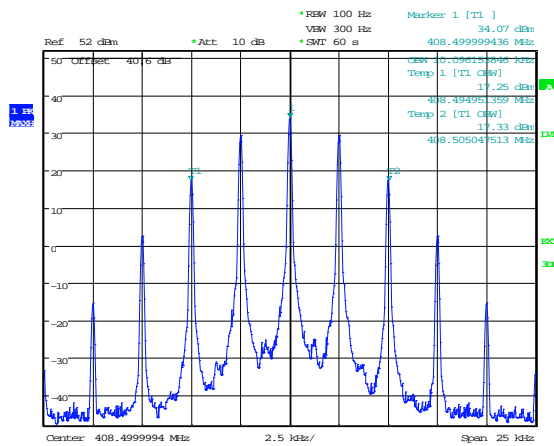

Date: 10.MAY.2018 14:34:08

Modulation Type 4K00F1E 99% OCBW Downlink @ AGC			
Channel Centre Frequency (MHz)	F _I (MHz)	F _h (MHz)	99% bandwidth (kHz)
408.5000	408.497553	408.502451	4.8976

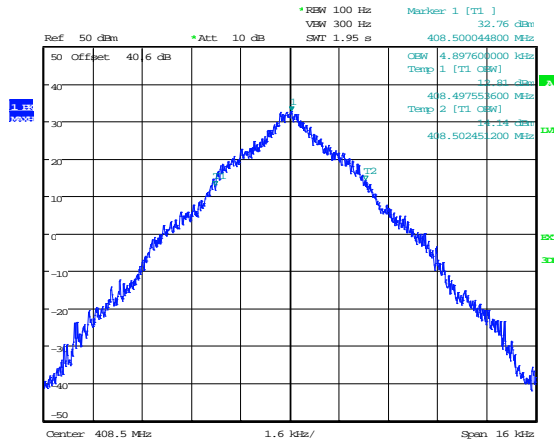

Date: 14.MAY.2018 17:12:52

Modulation Type 4K00F1E 99% OCBW Downlink @ AGC+3			
Channel Centre Frequency (MHz)	F _I (MHz)	F _h (MHz)	99% bandwidth (kHz)
408.5000	408.487552	408.502412	4.8608

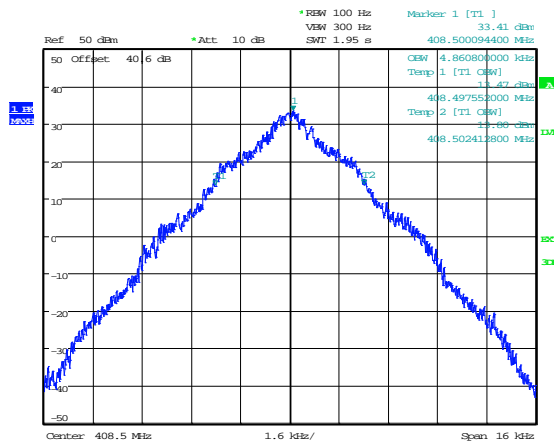

Date: 14.MAY.2018 17:17:24

Modulation Type 8k10F1E 99% OCBW Downlink @ AGC			
Channel Centre Frequency (MHz)	Fl (MHz)	Fh (MHz)	99% bandwidth (kHz)
408.5000	408.495793	408.504126	8.333

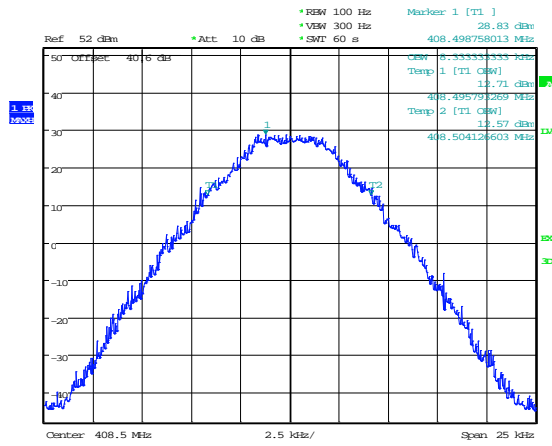

Date: 14.MAY.2018 12:35:18

Modulation Type 8k10F1E 99% OCBW Downlink @ AGC+3			
Channel Centre Frequency (MHz)	Fl (MHz)	Fh (MHz)	99% bandwidth (kHz)
408.5000	408.495873	408.504126	8.253

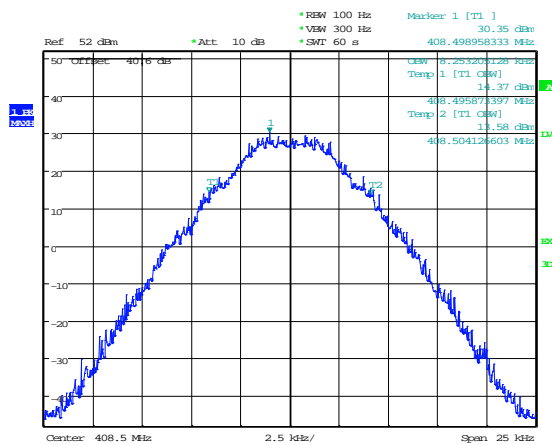

Date: 14.MAY.2018 12:43:26

20 Measurement Uncertainty

For the test data recorded the following measurement uncertainty was calculated:

Radio Testing – General Uncertainty Schedule

All statements of uncertainty are expanded standard uncertainty using a coverage factor of 1.96 to give a 95% confidence where no required test level exists.

[1] Adjacent Channel Power

Uncertainty in test result = **1.86dB**

[2] Carrier Power

Uncertainty in test result (Power Meter) = **1.08dB**

Uncertainty in test result (Spectrum Analyser) = **2.48dB**

[3] Effective Radiated Power

Uncertainty in test result = **4.71dB**

[4] Spurious Emissions

Uncertainty in test result = **4.75dB**

[5] Maximum frequency error

Uncertainty in test result (Frequency Counter) = **0.113ppm**

Uncertainty in test result (Spectrum Analyser) = **0.265ppm**

[6] Radiated Emissions, field strength OATS 14kHz-18GHz Electric Field

Uncertainty in test result (14kHz – 30MHz) = **4.8dB**,

Uncertainty in test result (30MHz – 1GHz) = **4.6dB**,

Uncertainty in test result (1GHz – 18GHz) = **4.7dB**

[7] Frequency deviation

Uncertainty in test result = **3.2%**

[8] Magnetic Field Emissions

Uncertainty in test result = **2.3dB**

[9] Conducted Spurious

Uncertainty in test result – Up to 8.1GHz = **3.31dB**

Uncertainty in test result – 8.1GHz – 15.3GHz = **4.43dB**

Uncertainty in test result – 15.3GHz – 21GHz = **5.34dB**

Uncertainty in test result – Up to 26GHz = **3.14dB**

[10] Channel Bandwidth

Uncertainty in test result = **15.5%**

[11] Amplitude and Time Measurement – Oscilloscope

Uncertainty in overall test level = **2.1dB**,
Uncertainty in time measurement = **0.59%**,
Uncertainty in Amplitude measurement = **0.82%**

[12] Power Line Conduction

Uncertainty in test result = **3.4dB**

[13] Spectrum Mask Measurements

Uncertainty in test result = **2.59% (frequency)**
Uncertainty in test result = **1.32dB (amplitude)**

[14] Adjacent Sub Band Selectivity

Uncertainty in test result = **1.24dB**

[15] Receiver Blocking – Listen Mode, Radiated

Uncertainty in test result = **3.42dB**

[16] Receiver Blocking – Talk Mode, Radiated

Uncertainty in test result = **3.36dB**

[17] Receiver Blocking – Talk Mode, Conducted

Uncertainty in test result = **1.24dB**

[18] Receiver Threshold

Uncertainty in test result = **3.23dB**

[19] Transmission Time Measurement

Uncertainty in test result = **7.98%**