



TEST REPORT NO: RU1161/6076
COPY NO: 2
ISSUE NO: 2
FCC ID: NEO 55-1515Series

**REPORT ON THE CERTIFICATION TESTING OF A
AERIAL FACILITIES LIMITED
55-151-501 CELL ENHANCER
WITH RESPECT TO
THE FCC RULES CFR 47, PART 22 Subpart H
PRIVATE LAND MOBILE REPEATER.**

TEST DATE: 1st February 2005 – 2nd February 2005

TESTED BY: _____ D WINSTANLEY

APPROVED BY: _____ P GREEN
PRODUCT MANAGER
EMC

DATE: 13 July 2005

Distribution:

- Copy Nos:
1. Aerial Facilities Limited
 2. TCB: TRL Compliance Services Limited
 3. TRL EMC

THIS DOCUMENT MAY BE REPRODUCED ONLY IN ITS ENTIRETY AND WITHOUT CHANGE



CONTENTS

	PAGE	
CERTIFICATE OF CONFORMITY & COMPLIANCE	3	
APPLICANT'S SUMMARY	4	
EQUIPMENT TEST CONDITIONS	5	
TESTS REQUIRED	5	
TEST RESULTS	6-65	
		ANNEX
PHOTOGRAPHS		A
PHOTOGRAPH No. 1: Test setup		
PHOTOGRAPH No. 2: Test setup		
APPLICANT'S SUBMISSION OF DOCUMENTATION LIST		B
 Notes:		
1. Component failure during test	YES	<input type="checkbox"/>
	NO	<input checked="" type="checkbox"/>
2. If Yes, details of failure:		
3. The facilities used for the testing of the product contain in this report are FCC Listed.		



CERTIFICATE OF CONFORMITY & COMPLIANCE

FCC IDENTITY:	NEO 55-1515Series
PURPOSE OF TEST:	Certification
TEST SPECIFICATION:	FCC RULES CFR 47, PART 22 Subpart H
TEST RESULT:	Compliant to Specification
EQUIPMENT UNDER TEST:	55-151-501 Cell Enhancer
EQUIPMENT TYPE:	Private Land Mobile Repeater
MAXIMUM GAIN	82.63dB Uplink 83.07dB Downlink
MAXIMUM INPUT	-55dBm Uplink -54dBm Downlink
MAXIMUM OUTPUT	+25.94dBm Uplink +27.79dBm Downlink
ANTENNA TYPE:	Not applicable
CHANNEL SPACING:	Not applicable, Wideband
NUMBER OF CHANNELS:	Not applicable., Wideband
FREQUENCY GENERATION:	N/A
MODULATION TYPE:	F3E
POWER SOURCE(s):	+12 Vdc or 110Vac
TEST DATE(s):	1 st February 2005 – 2 nd February 2005
ORDER No(s):	29156
APPLICANT:	Aerial Facilities Limited
ADDRESS:	Aerial House Asheridge Road Chesham Buckinghamshire HP5 2QD United Kingdom
TESTED BY:	----- D WINSTANLEY
APPROVED BY:	----- P GREEN PRODUCT MANAGER EMC

APPLICANT'S SUMMARY

EQUIPMENT UNDER TEST (EUT): 55-151-501 Cell Enhancer

EQUIPMENT TYPE: 558-151-501

PURPOSE OF TEST: CERTIFICATION

TEST SPECIFICATION(S): FCC RULES CFR 47, PART 22 Subpart H

TEST RESULT: COMPLIANT Yes
 No

APPLICANT'S CATEGORY: MANUFACTURER
 IMPORTER
 DISTRIBUTOR
 TEST HOUSE
 AGENT

APPLICANT'S ORDER No(s): 29156

APPLICANT'S CONTACT PERSON(s): Mr Peter Bradfield

 E-mail address: Peterb@aerial.co.uk

APPLICANT: Aerial Facilities Limited

ADDRESS: Aerial House
 Asheridge Road
 Chesham
 Buckinghamshire
 HP5 2QD
 United Kingdom

 TEL: +44 (0)1494 777 000

 FAX: +44 (0)1494 778 456

MANUFACTURER: Aerial Facilities Limited

EUT(s) COUNTRY OF ORIGIN: United Kingdom

TEST LABORATORY: TRL EMC

UKAS ACCREDITATION No: 0728

TEST DATE(s) 1st February 2005 – 2nd February 2005

TEST REPORT No: RU1161/6076

EQUIPMENT TEST / EXAMINATIONS REQUIRED

1.	TEST/EXAMINATION	RULE PART	APPLICABILITY	RESULT
	RF Power Output	90.205	Yes	Complies
	Audio Frequency Response	TIA EIA-603.3.2.6	N/A	N/A
	Audio Low-Pass Filter Response	TIA EIA-603.3.2.6	N/A	N/A
	Modulation Limiting	TIA EIA-603.3.2.6	N/A	N/A
	Occupied Bandwidth	90.210	Yes	Complies
	Spurious Emissions at Antenna Terminals	90.210	Yes	Complies
	Field Strength of Spurious Emissions	90.210	Yes	Complies
	Frequency Stability	90.213	N/A(note 1)	N/A
	Transient behaviour	90.214	N/A(note 2)	N/A

Notes:

1 The EUT does not contain modulation circuitry, therefore the test was not performed.

2 The EUT is not a keyed carrier system, therefore the test was not performed.

- | | | | |
|----|--|----------------------------------|-------------------------------------|
| 2. | Product Use: | Private Land Mobile Repeater | |
| 3. | Emission Designator: | F3E | |
| 4. | Temperatures: | Ambient (Tnom) | 25°C |
| 5. | Supply Voltages: | Vnom | +12Vdc or
110Vac |
| | Note: Vnom voltages are as stated above unless otherwise shown on the test report page | | |
| 6. | Equipment Category: | Single channel | <input type="checkbox"/> |
| | | Two channel | <input type="checkbox"/> |
| | | Multi-channel | <input checked="" type="checkbox"/> |
| 7. | Channel spacing: | Narrowband | <input type="checkbox"/> |
| | | Wideband | <input checked="" type="checkbox"/> |
| 8. | Test Location | TRL Compliance Services | |
| | | Up Holland | <input checked="" type="checkbox"/> |
| | | Long Green | <input type="checkbox"/> |
| 9. | Modifications made during test program | No modifications were performed. | |

COMPLIANCE TESTS

AMPLIFIER GAIN – CONDUCTED – PART 2.1046 – UPLINK

Ambient temperature = 25°C
 Relative humidity = 39%
 Supply voltage = +12Vdc & 110Vac
 Channel Frequency = See test results

Radio Laboratory

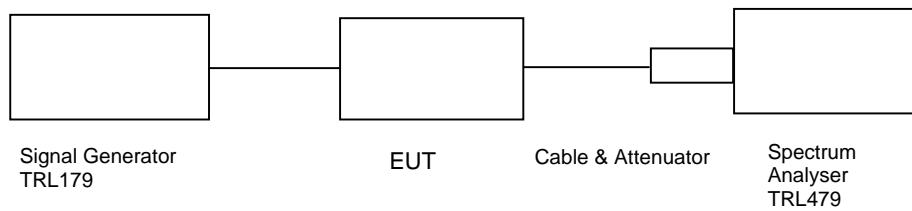

Frequency MHz	Operating Voltage	Signal Generator input level dBm	Cable & Attenuator Loss dB	Level at Spectrum Analyser dBm	Gain dB	Gain after 10dB input level increase dBm
819.0	+12Vdc	-55.0	35.67	-9.52	81.15	71.19
834.0	+12Vdc	-56.0	35.69	-9.28	82.41	72.41
844.0	+12Vdc	-57.0	35.71	-10.43	82.28	72.23
819.0	+110Vac	-55.0	35.67	-9.34	81.33	71.47
834.0	+110Vac	-56.0	35.69	-9.06	82.63	72.69
844.0	+110Vac	-57.0	35.71	-10.32	82.39	72.53

Notes:

- The signal generator input was increased by 10dB and the level of the output signal remeasured

TYPE OF EQUIPMENT	MAKER/SUPPLIER	MODEL No	SERIAL No	TRL No	ACTUAL EQUIPMENT USED
SPECTRUM ANALYSER	ANRITSU	MS2665C	MT26089	479	X
ATTENUATOR	BIRD	8304-300-N	N/A	220	X
ATTENUATOR	BIRD	8304-100-N	N/A	222	X
CABLE	ROSENBERGER	MICRO COAX	N/A	280	X
SIGNAL GENERATOR	MARCONI	2042	119388/080	179	X

AMPLIFIER INTERMODULATION SPURIOUS EMISSIONS – CONDUCTED – PART 2.1053– UPLINK

Ambient temperature = 28°C
 Relative humidity = 39%
 Supply voltage = 110Vac

Radio Laboratory

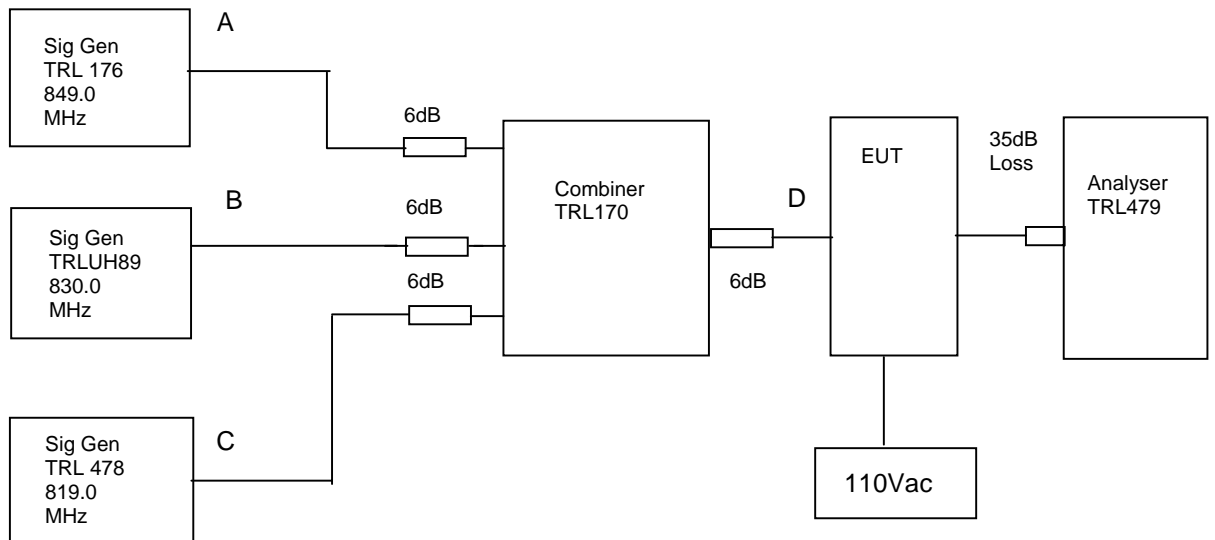

The Intermodulation and spurious products were measured with the amplifier operating at maximum gain. A three tone test was conducted using the equipment as above. The input power level was adjusted so the level at point D was the maximum input of -55dBm . The cable and attenuator loss between the EUT and the spectrum analyser was 35dB.

Sweep data is shown on the next page:

TYPE OF EQUIPMENT	MAKER/SUPPLIER	MODEL No	SERIAL No	TRL No	ACTUAL EQUIPMENT USED
SPECTRUM ANALYSER	ANRITSU	MS2665C	MT26089	479	X
SIGNAL GENERATOR	RHODE & SCHWARZ	SMR 20	834671/003	478	X
SIGNAL GENERATOR	MARCONI	2022D	119224/035	UH89	X
SIGNAL GENERATOR	MARCONI	2042	119388/080	176	X
COMBINER	ELCOM	RC-4-50	N/A	170	X

Intermodulation Inband

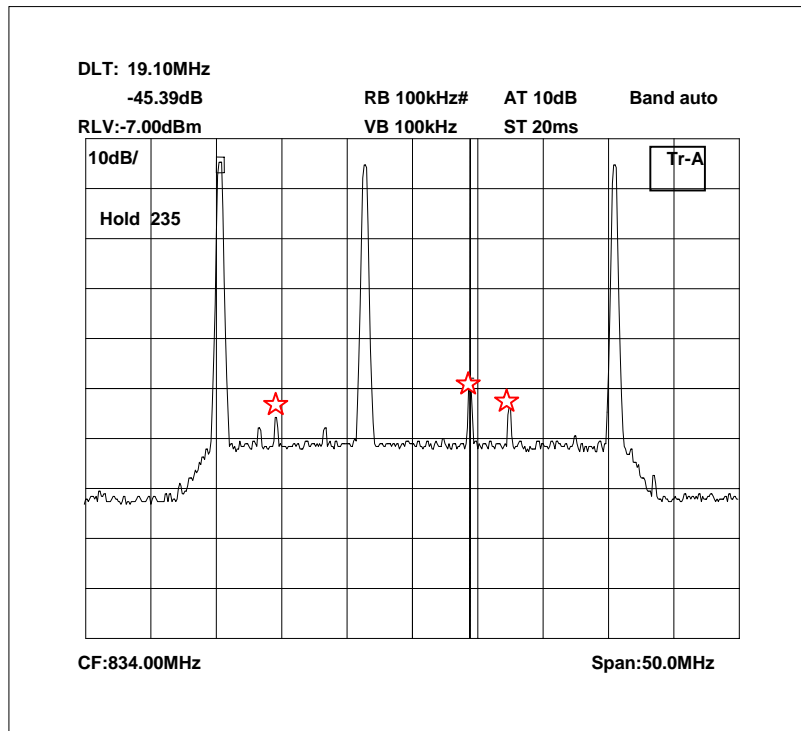

The above plot shows that all products (designated by ☆) are at least 40dB below the fundamentals.

Intermodulation Wideband

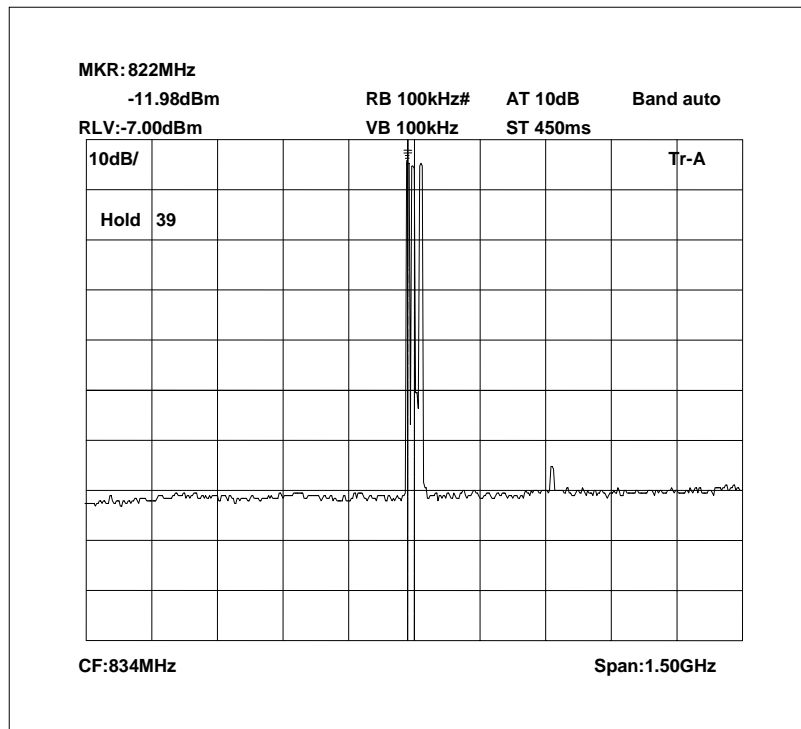

The above plot shows that there are no products outside the bands.

TRANSMITTER TESTS

AMPLIFIER MODULATED CHANNEL TEST – CONDUCTED – Part 2.1049– UPLINK

Ambient temperature = 25°C
 Relative humidity = 39%
 Supply voltage = 100Vac
 Channel Frequency = See test results

Radio Laboratory

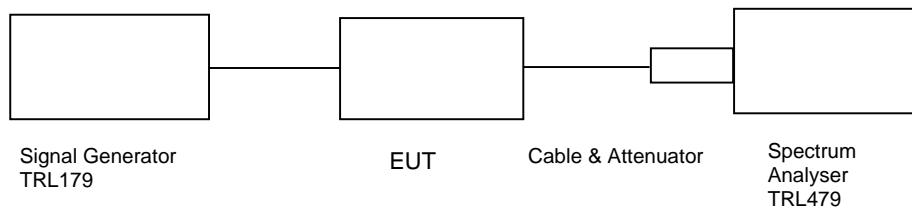

This test was performed to show that the amplifier does not alter the input signal in any way. The input signal was set to the maximum input level (-55dBm) and modulated with a 2500Hz tone and a 5000Hz tone. The plots show the signal measured at the signal generator and the signal measured at the output of the EUT.

Note: The cables and attenuators had the following losses.

1. Cable and attenuator losses 35dB
2. Cable between signal generator and EUT 0.7dB

The test equipment used for the Transmitter Modulated Channel test:

TYPE OF EQUIPMENT	MAKER/SUPPLIER	MODEL No	SERIAL No	TRL No	ACTUAL EQUIPMENT USED
SPECTRUM ANALYSER	ANRITSU	MS2665C	MT26089	479	X
ATTENUATOR	BIRD	8304-300-N	N/A	220	X
ATTENUATOR	BIRD	8304-100-N	N/A	222	X
CABLE	ROSENBERGER	MICRO COAX	N/A	280	X
SIGNAL GENERATOR	MARCONI	2042	119388/080	179	X

819.0MHz Signal Generator. FM deviation set to 5 kHz

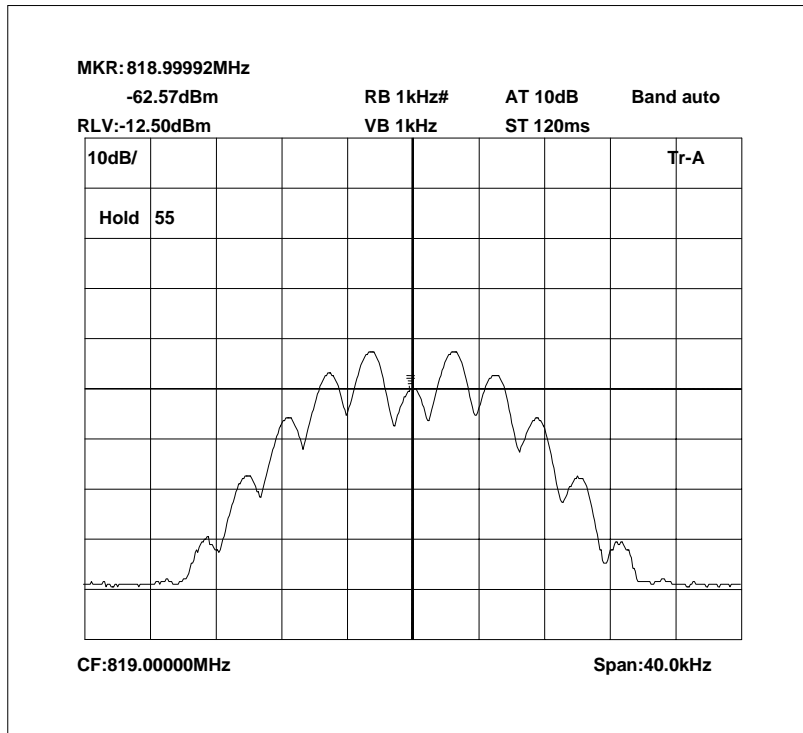

819.0MHz Signal Generator and EUT. FM deviation set to 5kHz

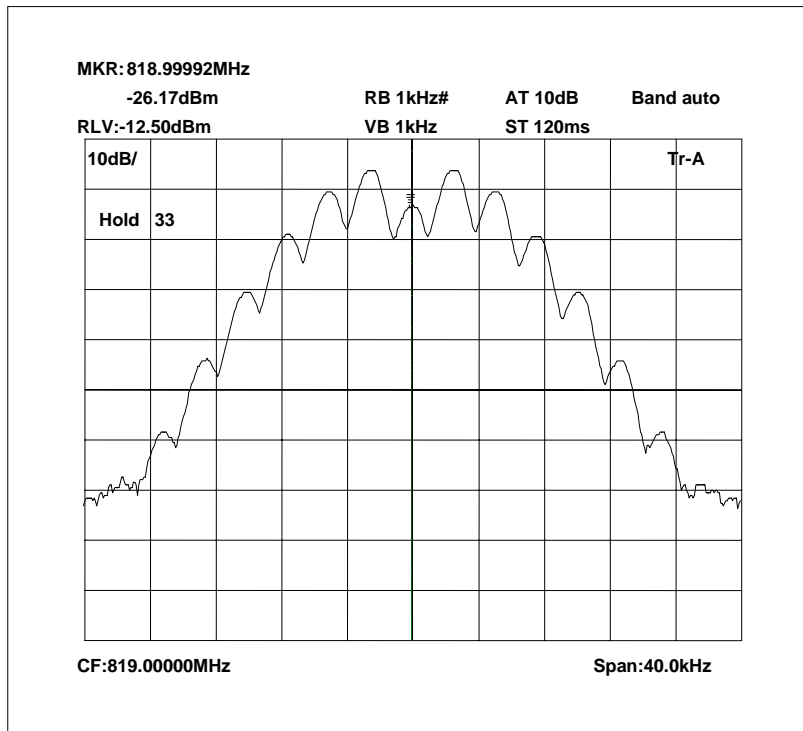

The above plots depicting the output waveshape show no measurable distortion visible. When compared to the input signal.

834.0 MHz Signal Generator. FM deviation set to 5kHz

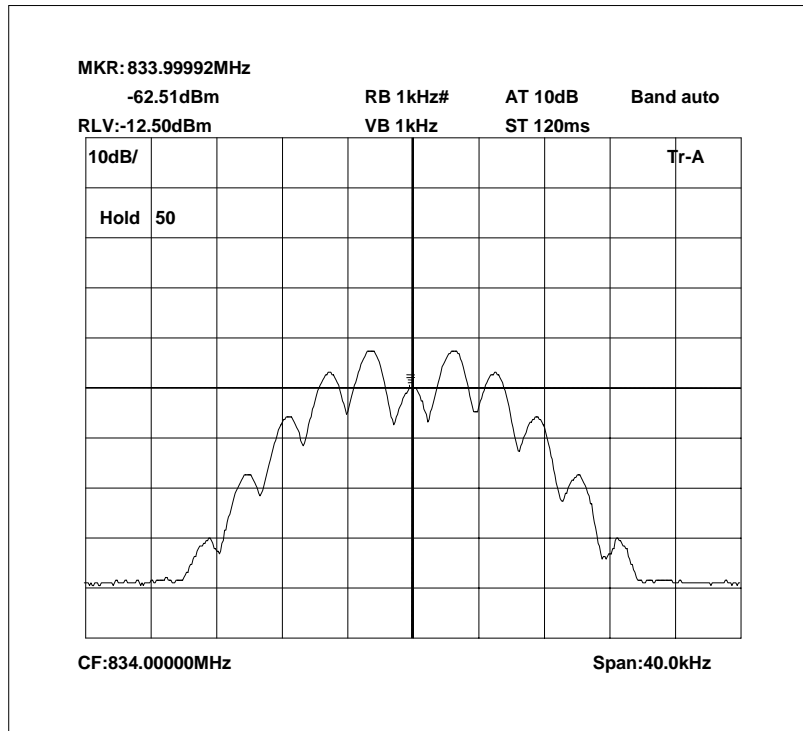

834.0MHz Signal Generator and EUT. FM deviation set to 5kHz

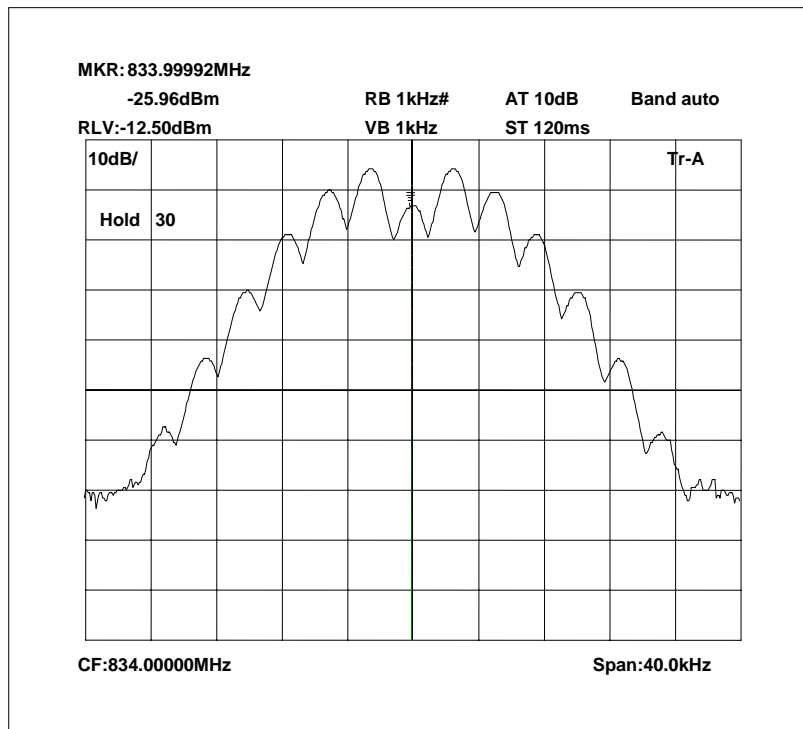

The above plots depicting the output waveshape show no measurable distortion visible. When compared to the input signal.

844.0MHz Signal Generator. FM deviation set to 5kHz

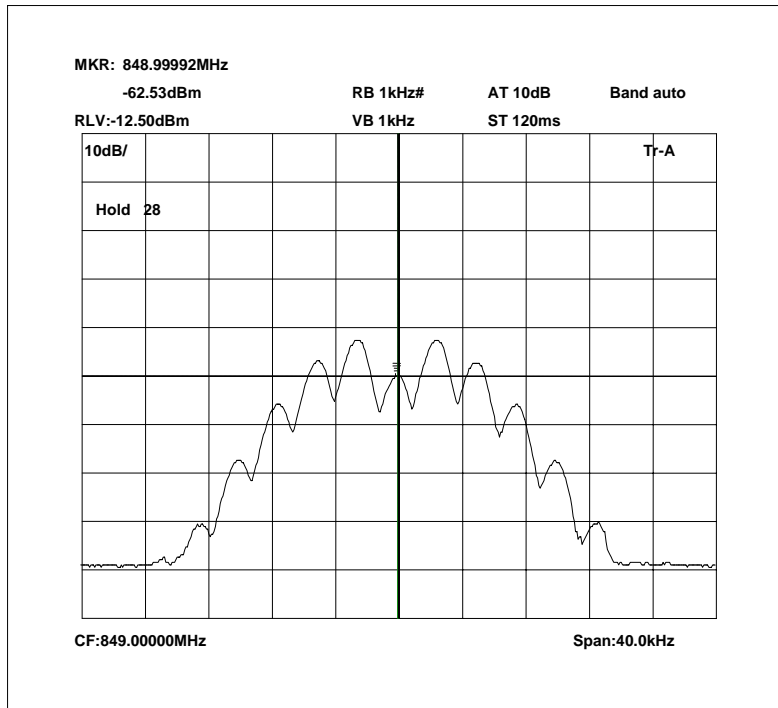

844.0MHz Signal Generator. FM deviation set to 5kHz

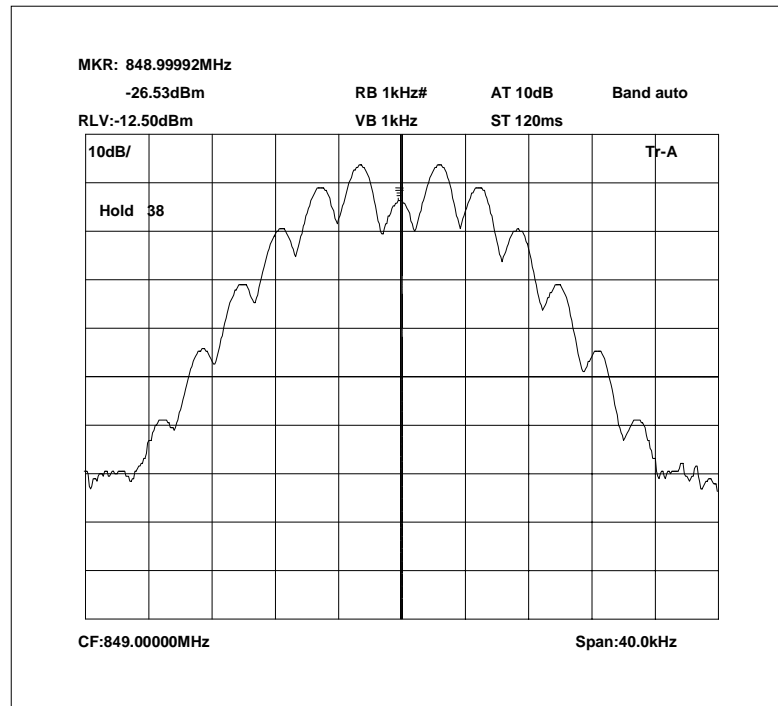

The above plots depicting the output waveshape show no measurable distortion visible. When compared to the input signal.

TRANSMITTER TESTS

AMPLIFIER SPURIOUS EMISSIONS – CONDUCTED – Part 2.1053 – UPLINK

Ambient temperature = 20°C
 Relative humidity = 45%
 Supply voltage = +12Vdc & 110Vac

Radio Laboratory Test Signal = F3E

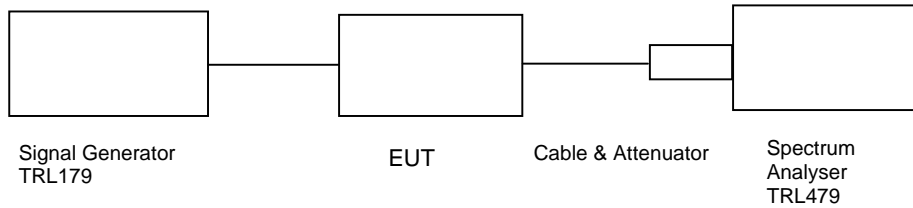

The test was set up as per the diagram. The level at the input was adjusted to compensate for the loss of the interconnecting cable. The unit was tested operating at maximum power and on three test frequencies.

The Spurious limit was calculated as follows:

On any frequency removed from the assigned frequency by more that 250% of the authorised bandwidth

At least 43 + 10 log PdB

$$(10\log P_{\text{watts}}) - (43+10\log (P_{\text{watts}} * 1000)) = \text{LIMIT} = -13 \text{ dBm}$$

TYPE OF EQUIPMENT	MAKER/SUPPLIER	MODEL No	SERIAL No	TRL No	ACTUAL EQUIPMENT USED
SPECTRUM ANALYSER	ANRITSU	MS2665C	MT26089	479	X
ATTENUATOR	BIRD	8304-300-N	N/A	220	X
ATTENUATOR	BIRD	8304-100-N	N/A	222	X
CABLE	ROSENBERGER	MICRO COAX	N/A	279	X
SIGNAL GENERATOR	MARCON	2042	119388/080	179	X

Conducted emissions 819.0MHz 0 - 3GHz

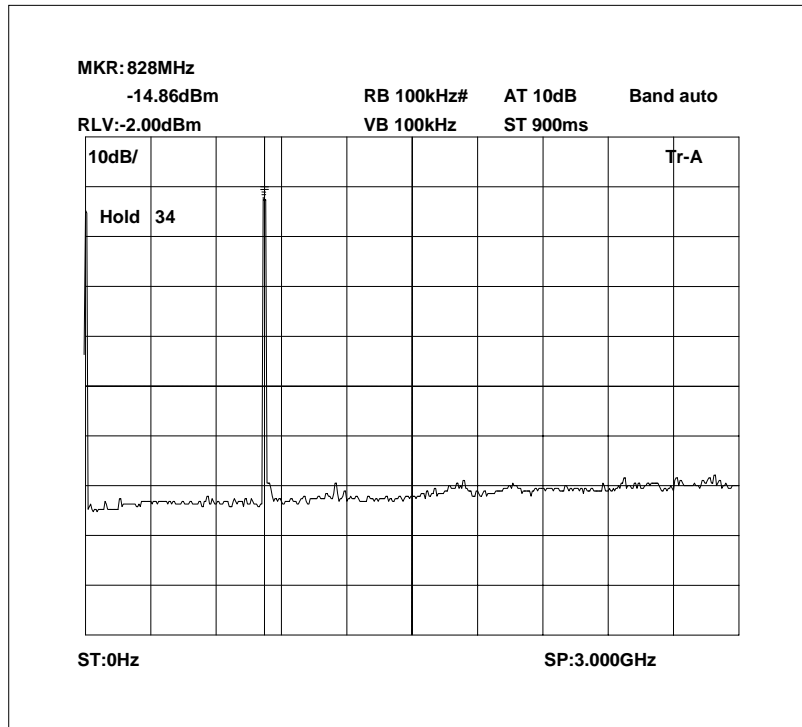

Conducted emissions 819.0MHz 3 - 5GHz

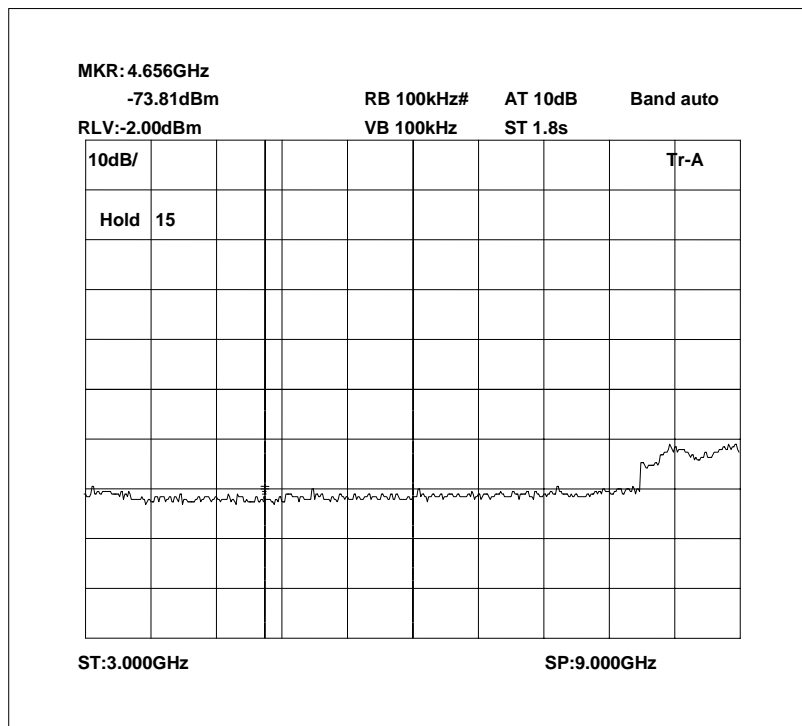

Conducted emissions 834.0MHz 0 - 3GHz

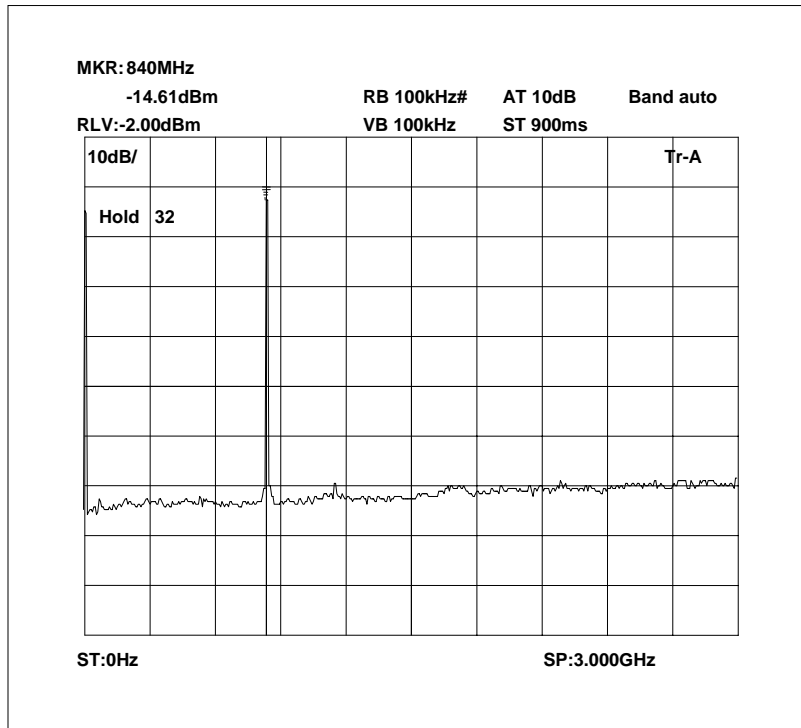

Conducted emissions 834.0MHz 3 - 9GHz

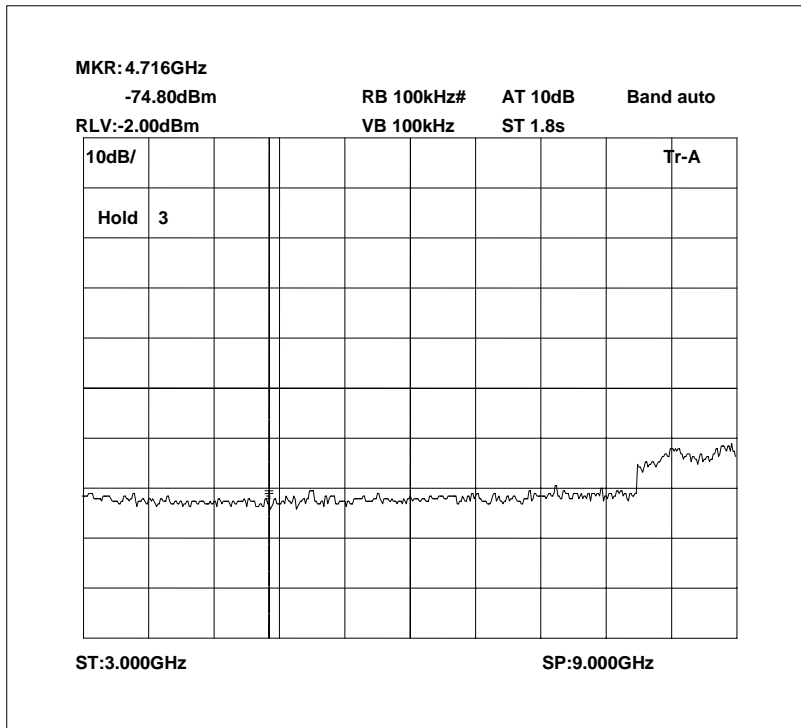

Conducted emissions 844.0MHz 0 - 3GHz

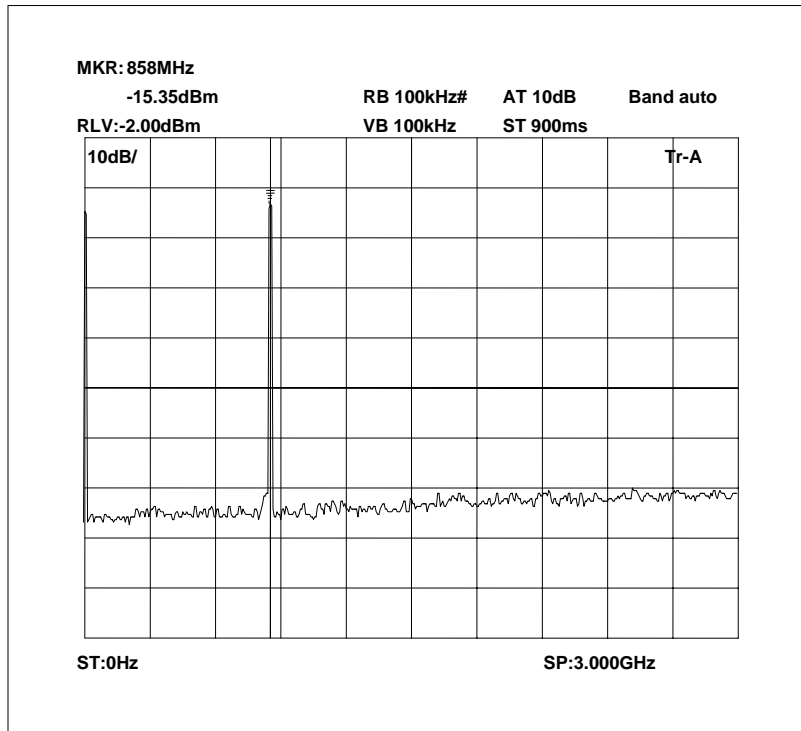

Conducted emissions 844.0MHz 3 - 9GHz

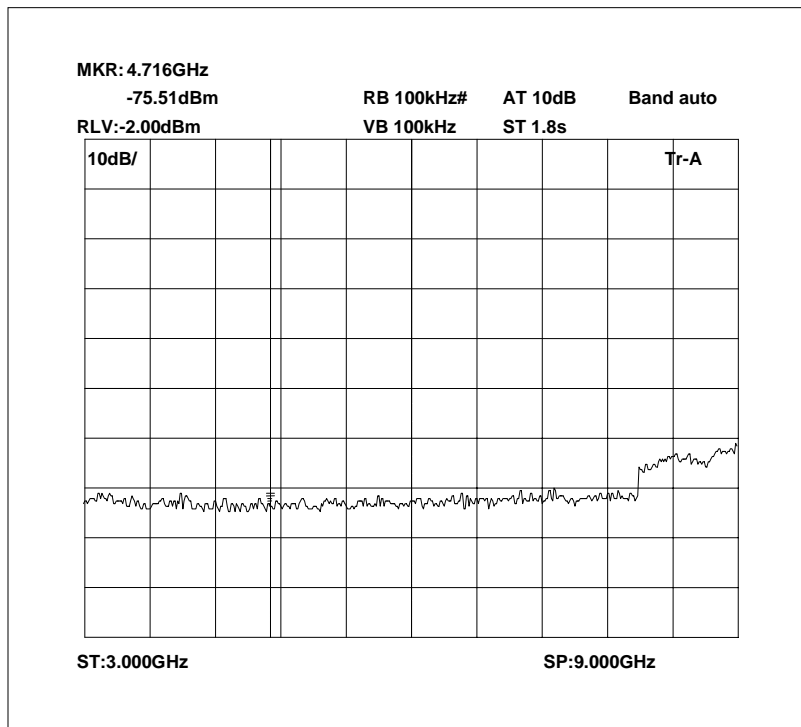

TRANSMITTER TESTS

AMPLIFIER SPURIOUS EMISSIONS – RADIATED – Part 2.1053– UPLINK

Ambient temperature = 6°C
 Relative humidity = 39%
 Conditions = OATS
 Supply voltage = 110Vac
 Supply Frequency = 60Hz

Test Signal = F3E

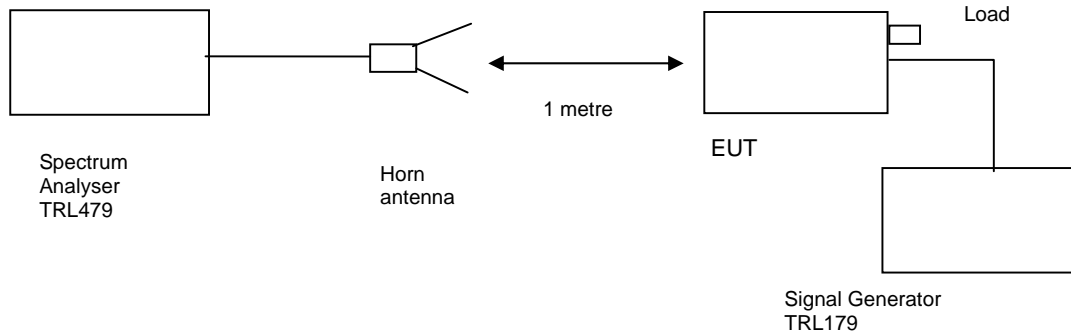

The test was set up as per the diagram. The level at the input was adjusted to compensate for the loss of the interconnecting cable. The unit was tested operating maximum power on three test frequencies with a 50 ohm load on the output. The unit was also tested with the signal generator replaced by another 50ohm load.

The Spurious limit was calculated as follows:

On any frequency removed from the assigned frequency by more that 250% of the authorised bandwidth

At least 43 + 10 log PdB

$$(10\log P_{\text{watts}}) - (43+10\log (P_{\text{watts}} * 1000)) = \text{LIMIT} = -13 \text{ dBm}$$

TYPE OF EQUIPMENT	MAKER/ SUPPLIER	MODEL No	SERIAL No	TRL No	ACTUAL EQUIPMENT USED
SPECTRUM ANALYSER	ANRITSU	MS2665C	MT26089	479	X
HORN	EMCO	3115	9010-3581	139	X
50 OHM LOAD	PHILCO	160B-300	1643	UH139	X
50 OHM LOAD	RHODE & SCHWARZ	200.0019.55	300804/32	UH227	X
CABLE	ROSENBERGER	MICRO COAX	N/A	280	X
SIGNAL GENERATOR	MARCONI	2042	119388/080	179	X

Radiated emissions 819.3MHz 0 – 1000MHz

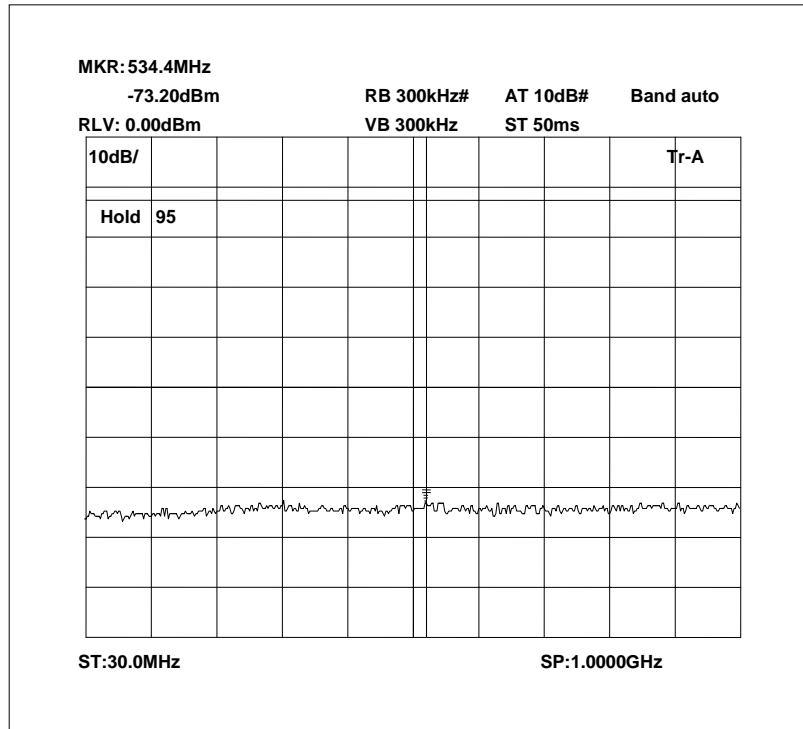

Radiated emissions 819.3MHz 1000MHz – 4000MHz

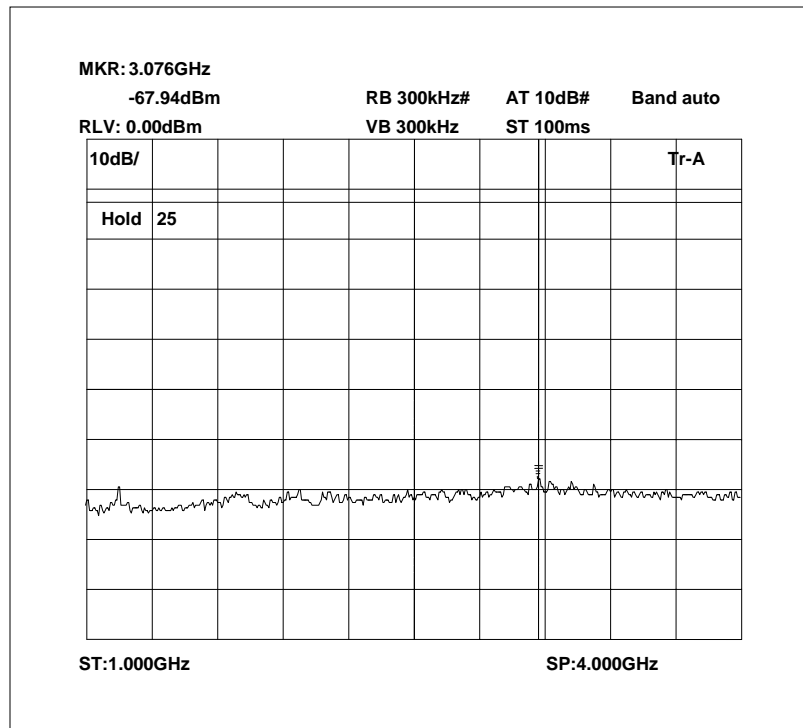

The above test results show that there were no emissions within 20dBs of the -13dBm limit.

Radiated emissions 819.0 MHz 4000MHz – 7000MHz

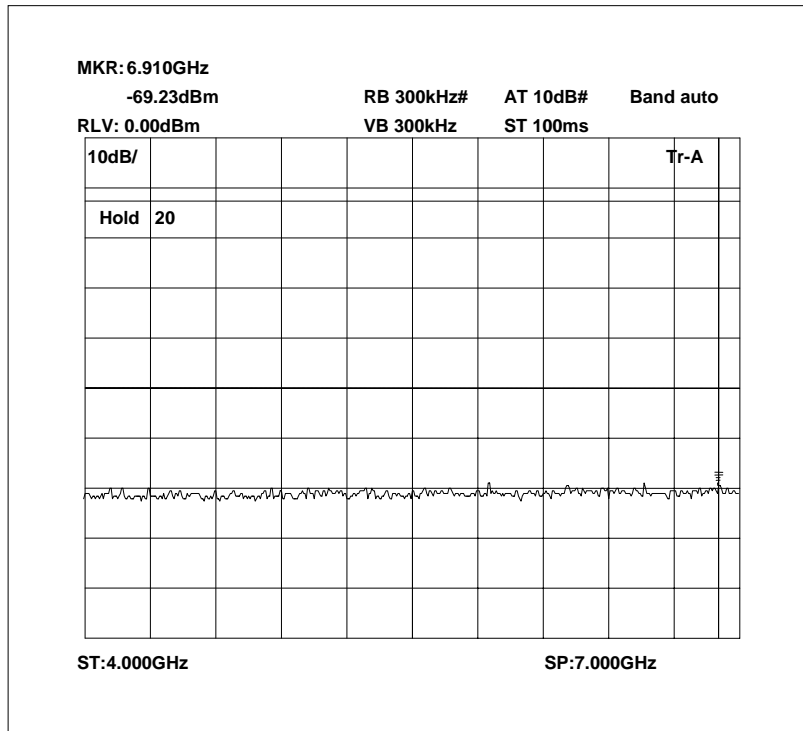

Radiated emissions 819.0 MHz 7000MHz – 10000MHz

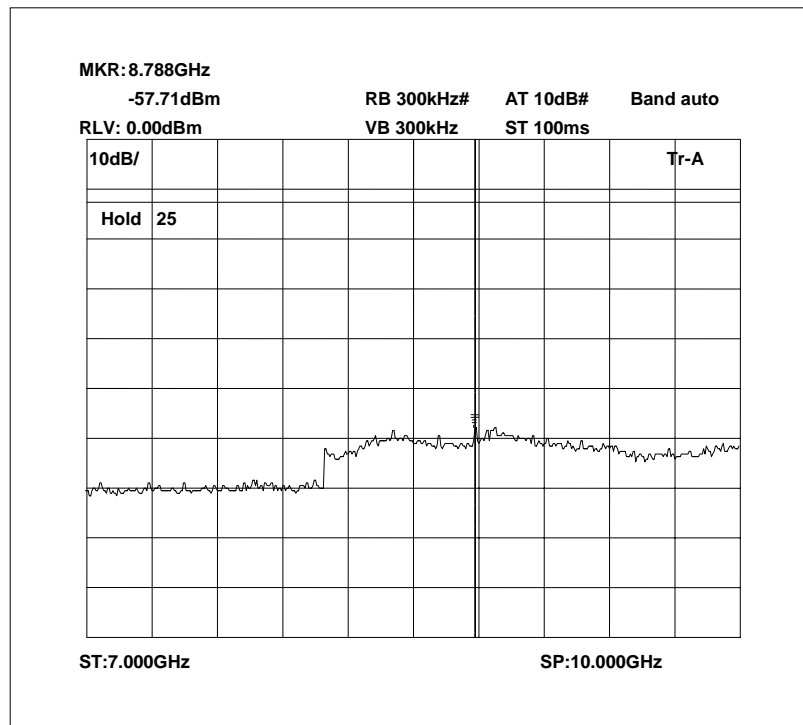

The above test results show that there were no emissions within 20dBs of the -13dBm limit.

Radiated emissions 834.0 MHz 30MHz - 1000MHz

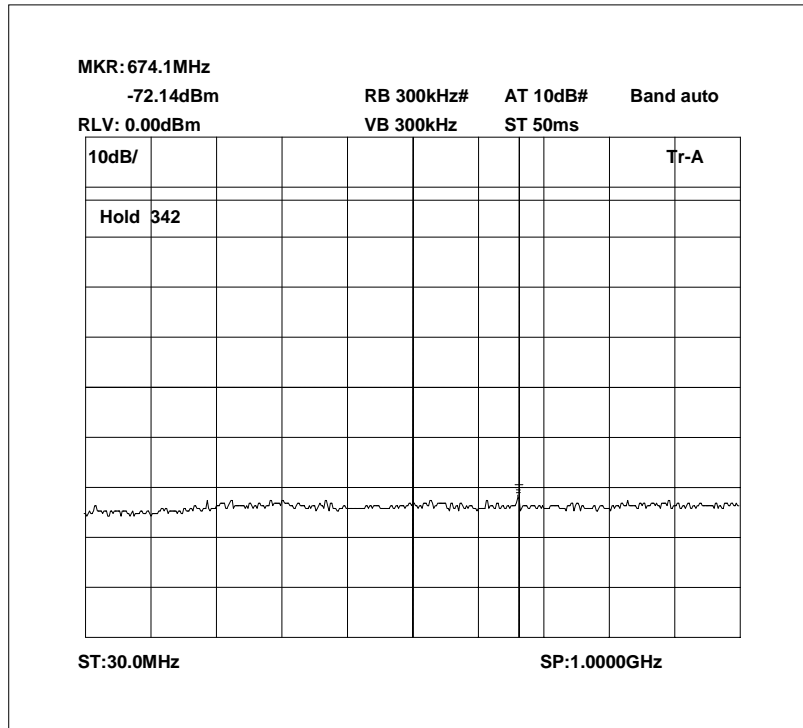

Radiated emissions 834.0 MHz 1000MHz - 4000MHz

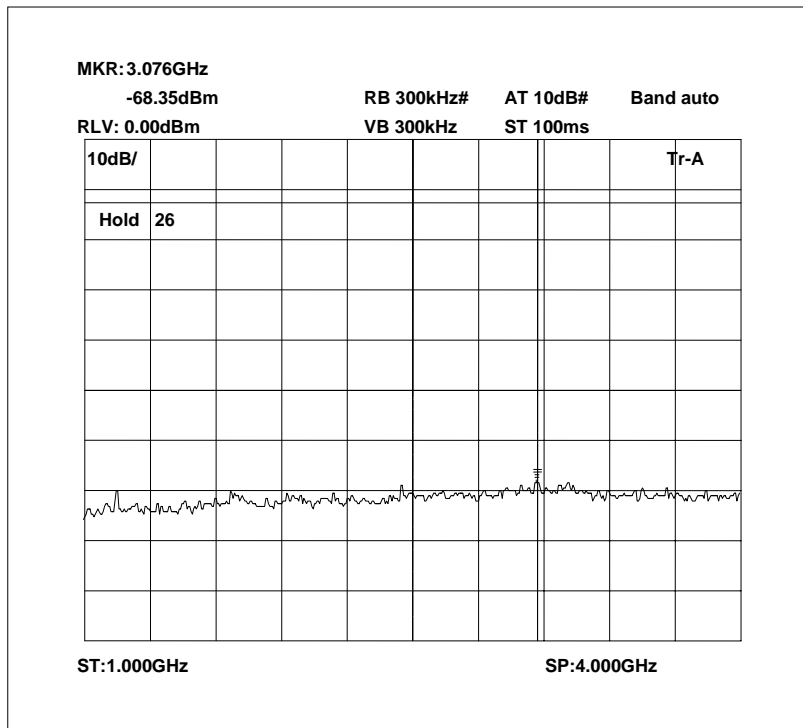

The above test results show that there were no emissions within 20dBs of the -13dBm limit.

Radiated emissions 834.0 MHz 4000MHz – 7000MHz

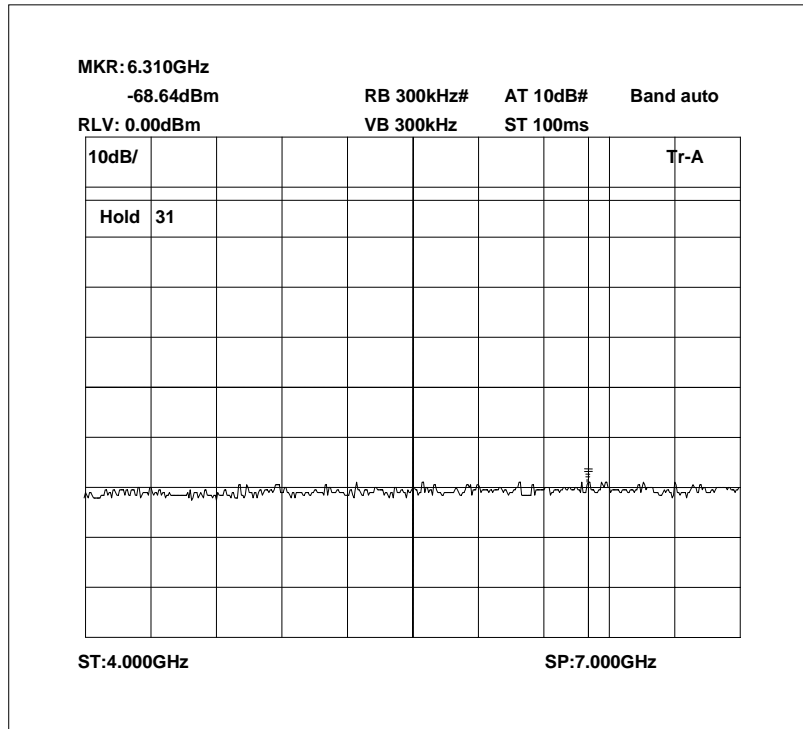

Radiated emissions 834.0 MHz 7000MHz – 10000MHz

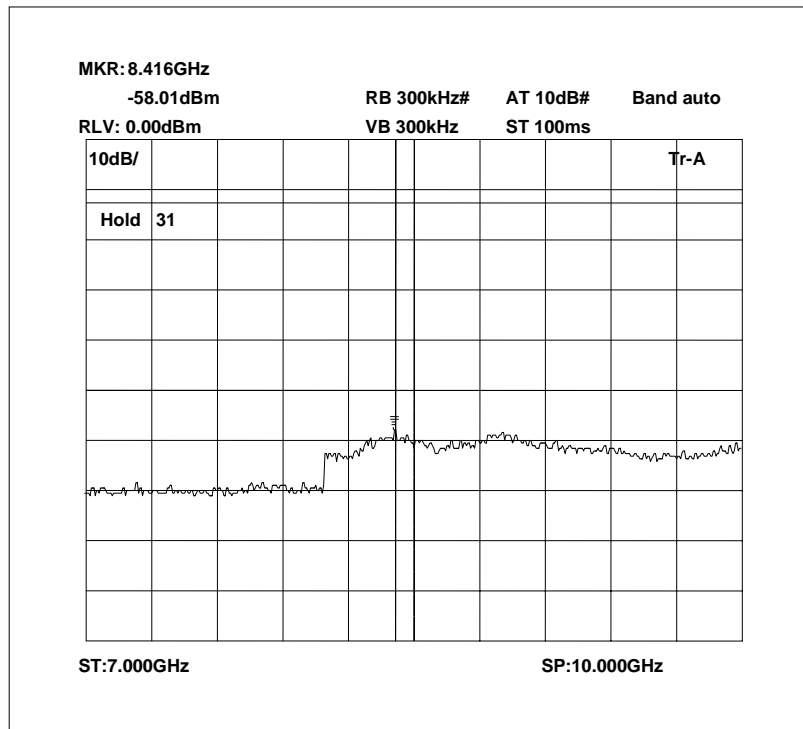

The above test results show that there were no emissions within 20dBs of the -13dBm limit.

Radiated emissions 844.0MHz 30MHz – 1000MHz

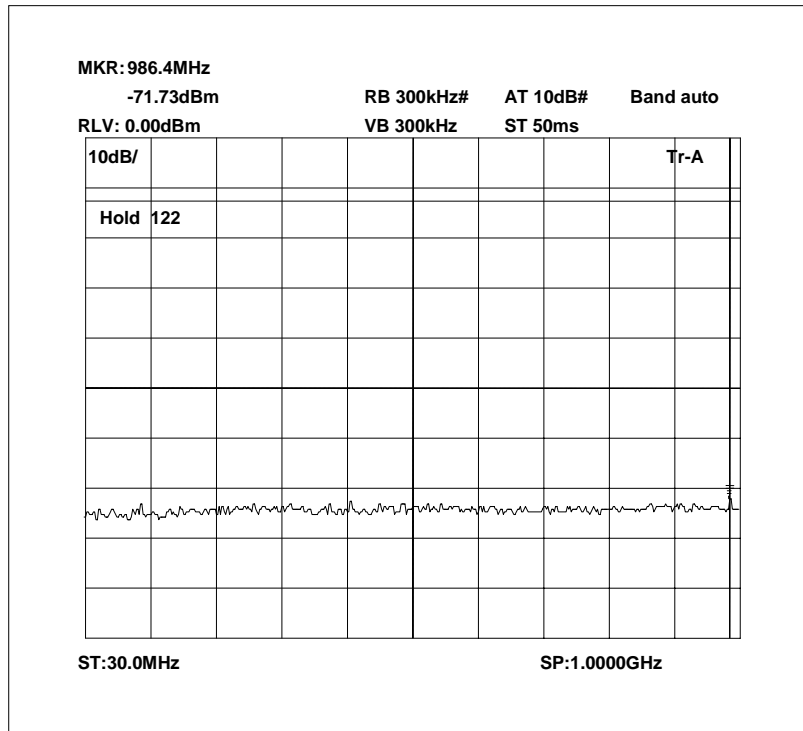

Radiated emissions 844.0MHz 1000MHz - 4000MHz

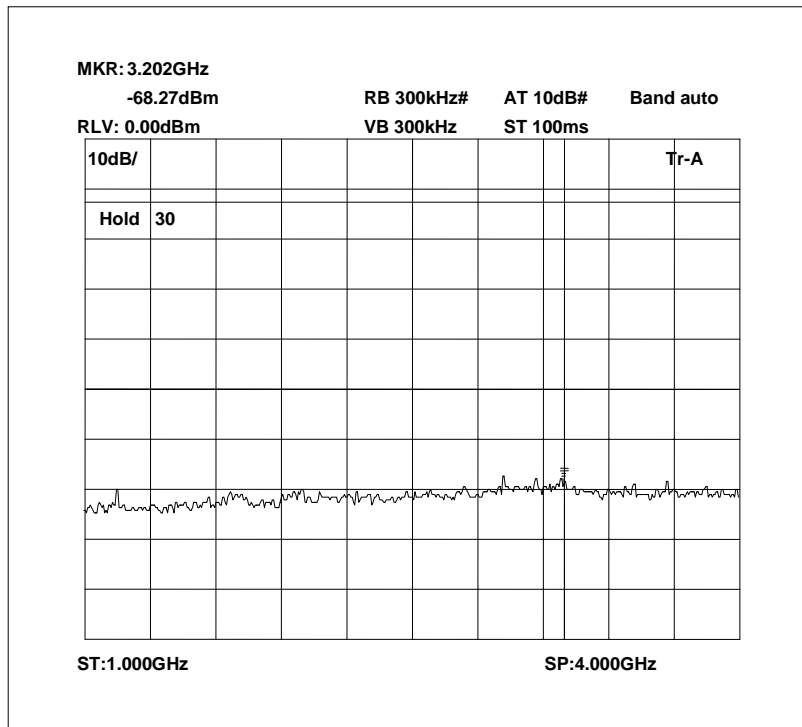

The above test results show that there were no emissions within 20dBs of the -13dBm limit.

Radiated emissions 844.0 MHz 400MHz – 7000Hz

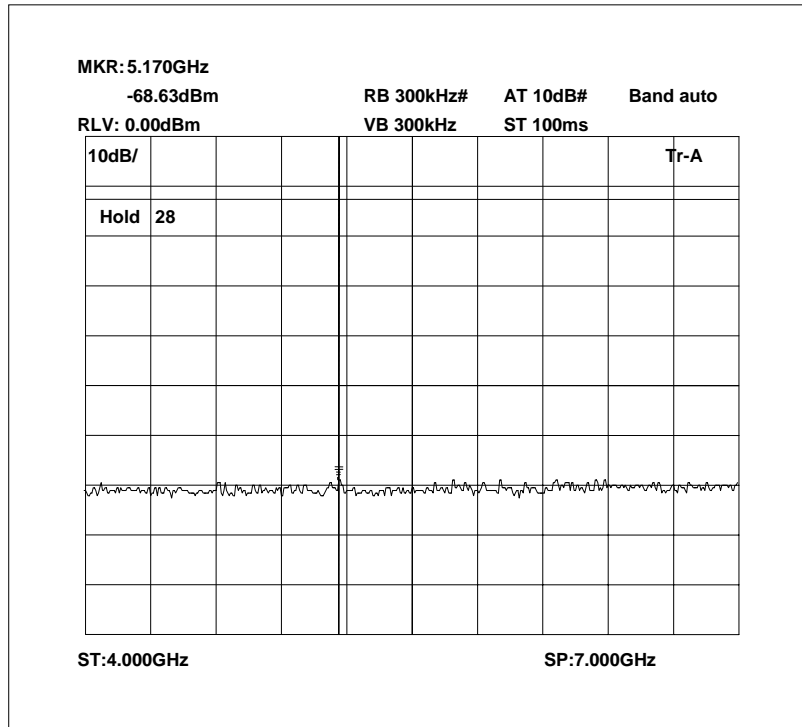

Radiated emissions 844.0MHz 7000MHz – 10000MHz

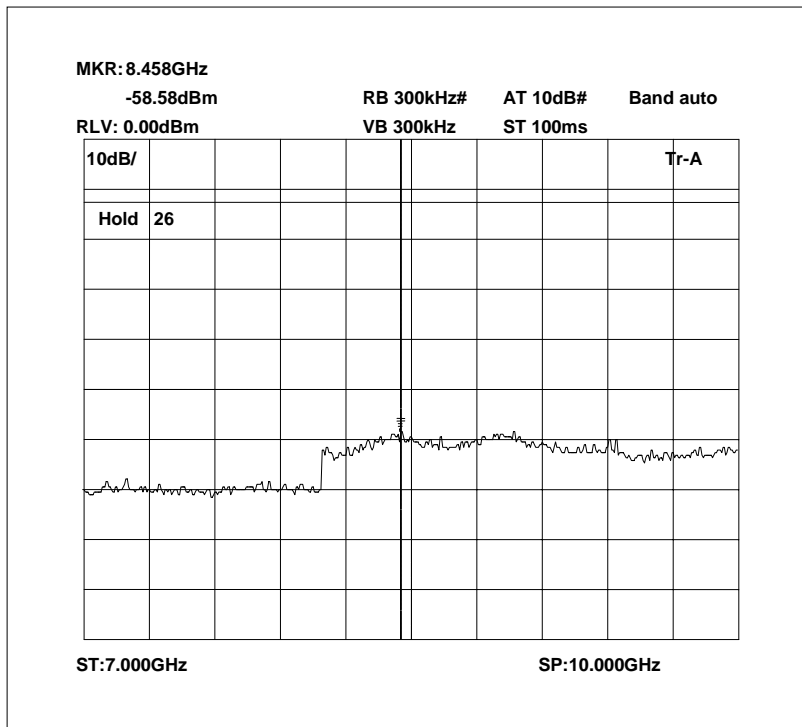

The above test results show that there were no emissions within 20dBs of the -13dBm limit.

Radiated emissions no input signal 30MHz - 1000MHz

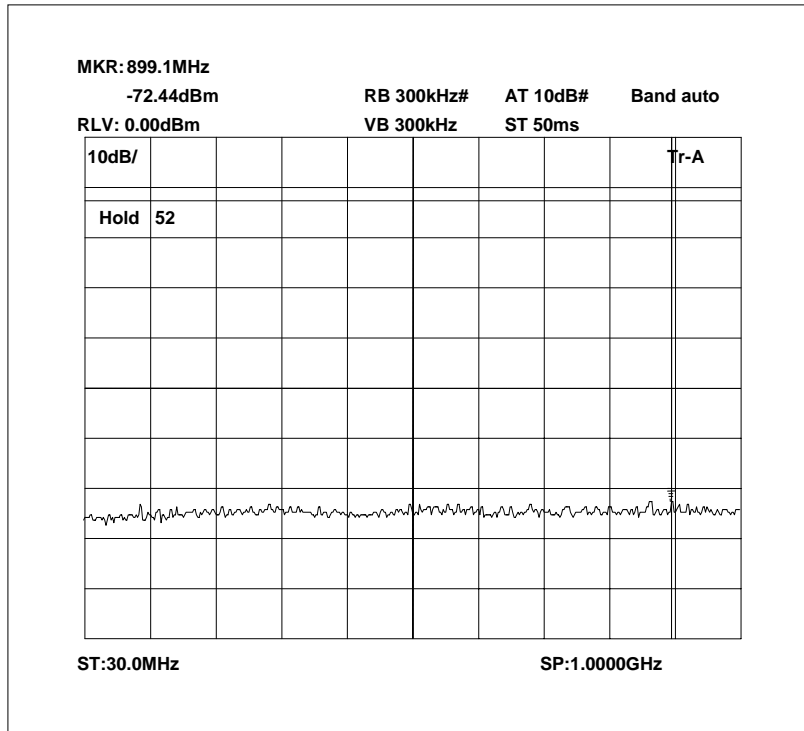

Radiated emissions no input signal 1000MHz - 4000MHz

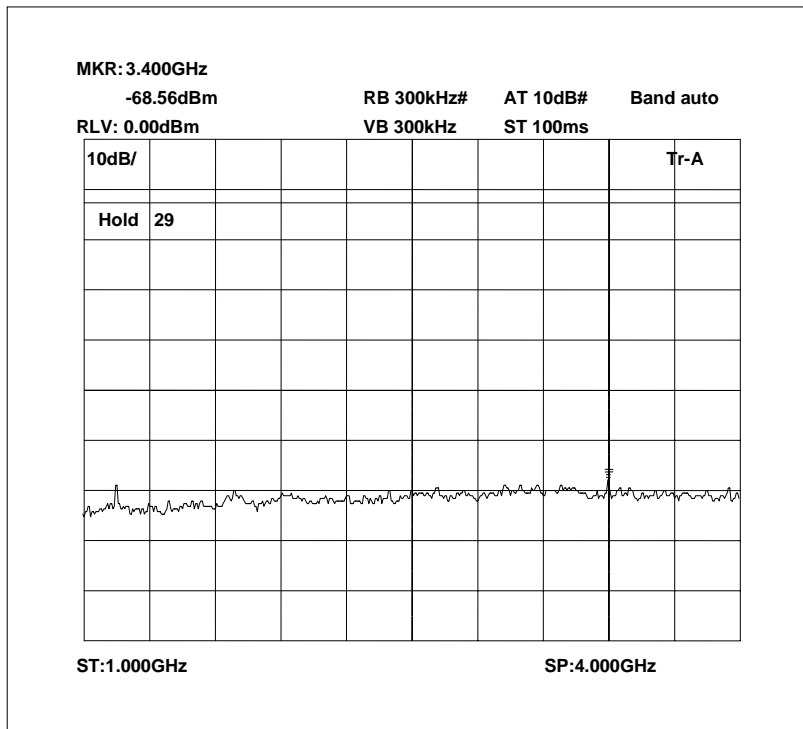

The above test results show that there were no emissions within 20dBs of the -13dBm limit.

Radiated emissions no input signal 4000MHz – 7000MHz

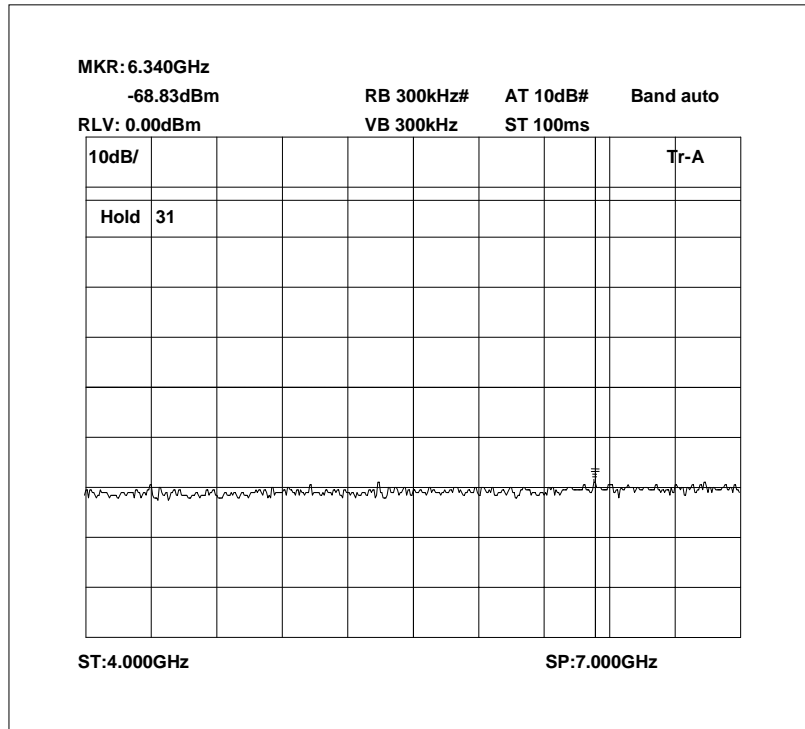

Radiated emissions no input signal 7000MHz – 10000MHz

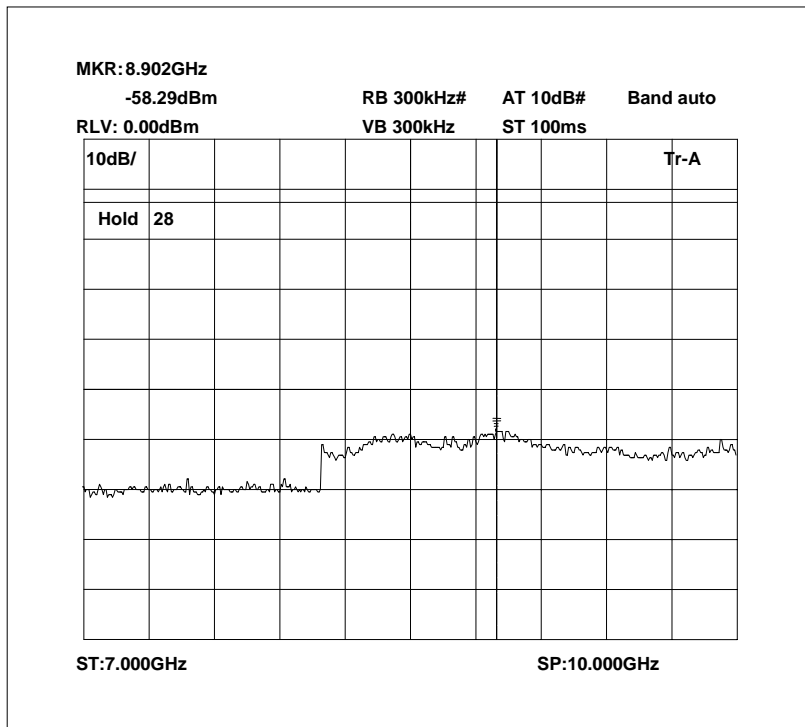

The above test results show that there were no emissions within 20dBs of the -13dBm limit.

AMPLIFIER GAIN – CONDUCTED – PART 2.1046 – DOWNLINK

Ambient temperature = 24°C
 Relative humidity = 50%
 Supply voltage = +12Vdc & 110Vac
 Channel Frequency = See test results

Radio Laboratory

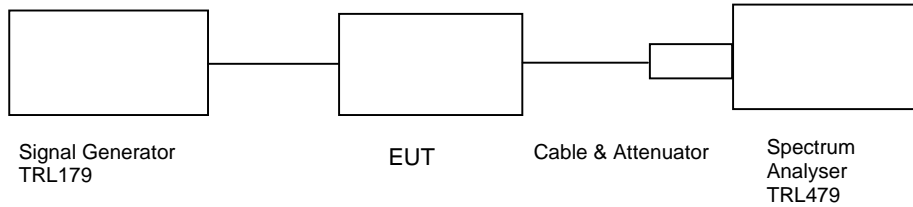

Frequency MHz	Operating Voltage	Signal Generator input level dBm	Cable & Attenuator Loss dB	Level at Spectrum Analyser dBm	Gain dB	Gain after 20dB input level increase dBm
866.0	+12Vdc	-54	35.76	-7.42	82.34	72.55
881.0	+12Vdc	-55	35.79	-7.72	83.07	72.77
896.0	+12Vdc	-56	35.81	-9.58	82.23	72.50
866.0	+110Vac	-54	35.76	-7.42	82.34	72.82
881.0	+110Vac	-55	35.79	-7.72	83.07	73.08
896.0	+110Vac	-56	35.81	-9.50	82.31	72.78

Notes:

1. The level of the signal generator takes into consideration the loss from the cable.
2. The signal generator input was increased by 20dB and the level of the output signal remeasured

TYPE OF EQUIPMENT	MAKER/SUPPLIER	MODEL No	SERIAL No	TRL No	ACTUAL EQUIPMENT USED
SPECTRUM ANALYSER	ANRITSU	MS2665C	MT26089	479	X
ATTENUATOR	BIRD	8304-200	N/A	103	X
ATTENUATOR	BIRD	8304-300-N	N/A	220	X
CABLE	ROSENBERGER	MICRO COAX	N/A	279	X
SIGNAL GENERATOR	MARCONI	2042	119388/080	179	X

AMPLIFIER INTERMODULATION SPURIOUS EMISSIONS – CONDUCTED – PART 2.1053– DOWNLINK

Ambient temperature = 25°C
 Relative humidity = 39%
 Supply voltage = 110Vac

Radio Laboratory

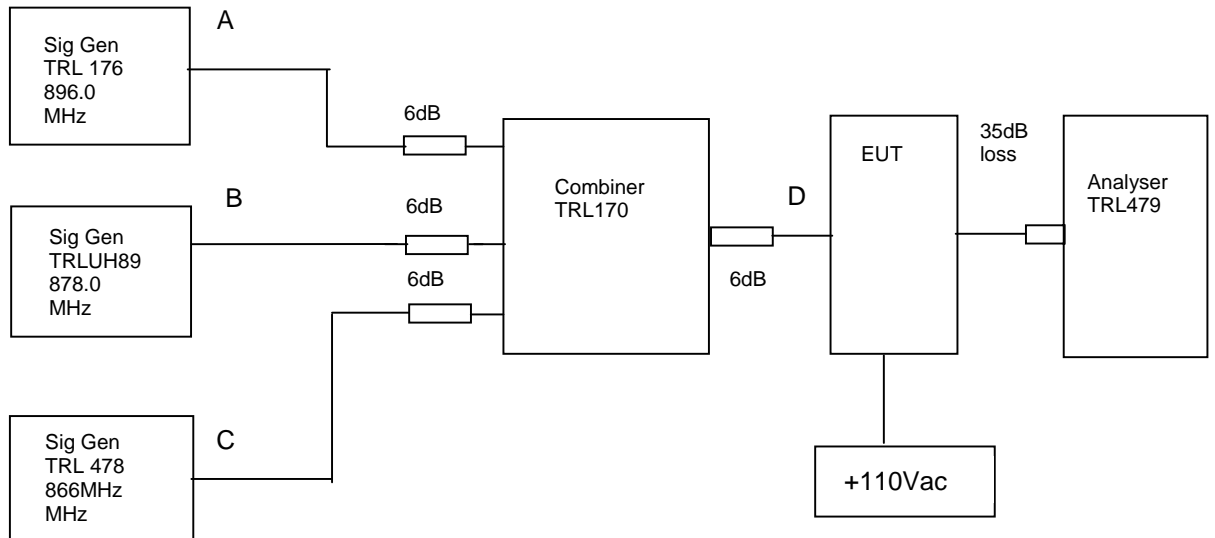

The Intermodulation and spurious products were measured with the amplifier operating at maximum gain. A three tone test was conducted using the equipment as above. The input power level was adjusted so the level at point D was the maximum input of -54dBm. The cable and attenuators loss between the EUT and the spectrum analyser was 35 dB.

Sweep data is shown on the next page:

Test equipment used for intermodulation test

TYPE OF EQUIPMENT	MAKER/SUPPLIER	MODEL No	SERIAL No	TRL No	ACTUAL EQUIPMENT USED
SPECTRUM ANALYSER	ANRITSU	MS2665C	MT26089	479	X
SIGNAL GENERATOR	RHODE & SCHWARZ	SMR 20	834671/003	478	X
SIGNAL GENERATOR	MARCONI	2022D	119224/035	UH89	X
SIGNAL GENERATOR	MARCONI	2042	119388/080	176	X
COMBINER	ELCOM	RC-4-50	N/A	170	X

Intermodulation Inband

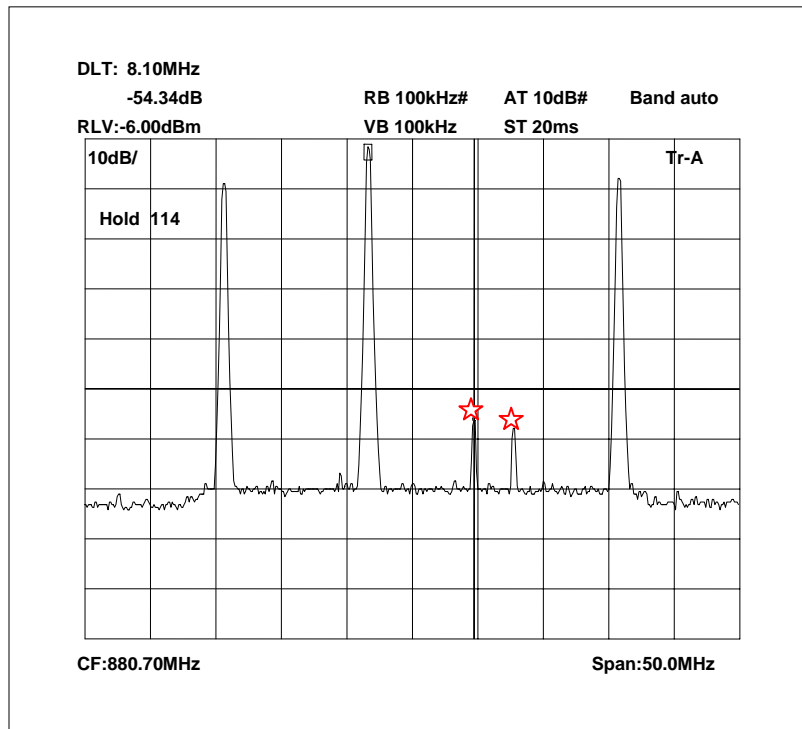

The above plot shows that all products (designated by ) are at least 50dB below the fundamentals.

Intermodulation Wideband

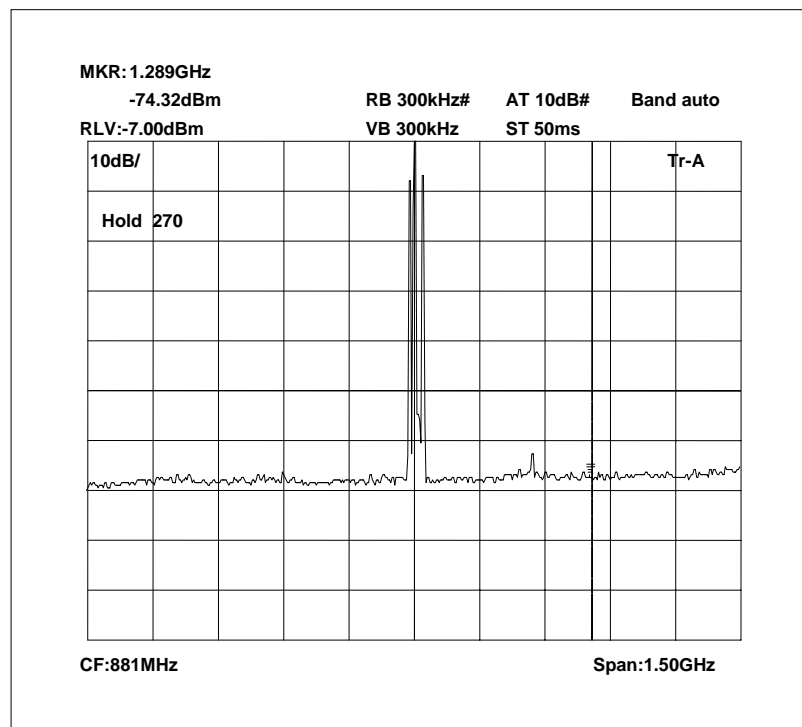

The above plot shows that there are no products outside the bands.

TRANSMITTER TESTS

AMPLIFIER MODULATED CHANNEL TEST – CONDUCTED – Part 2.1049– DOWNLINK

Ambient temperature = 20°C Radio Laboratory
 Relative humidity = 45%
 Supply voltage = 110Vac
 Channel Frequency = See test results

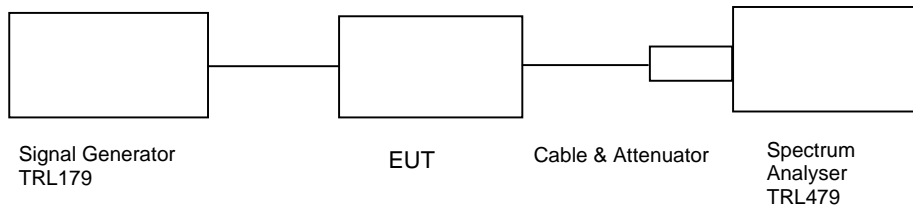

This test was performed to show that the amplifier does not alter the input signal in any way. The input signal was set to the maximum input level (-54dBm) and modulated with a 2500Hz tone and a 5000Hz tone. The plots show the signal measured at the signal generator and the signal measured at the output of the EUT.

Note: The cables and attenuators had the following losses.

1. Cable and attenuator = 35dB
2. Cable between signal generator and EUT = 0.79dB

The test equipment used for the Transmitter modulated channel test:

TYPE OF EQUIPMENT	MAKER/SUPPLIER	MODEL No	SERIAL No	TRL No	ACTUAL EQUIPMENT USED
SPECTRUM ANALYSER	ANRITSU	MS2665C	MT26089	479	X
ATTENUATOR	BIRD	8304-300-N	N/A	220	X
ATTENUATOR	BIRD	8304-100-N	N/A	222	X
CABLE	ROSENBERGER	MICRO COAX	N/A	279	X
SIGNAL GENERATOR	MARCONI	2042	119388/080	179	X

866.0MHz Signal Generator. FM deviation set to 5kHz

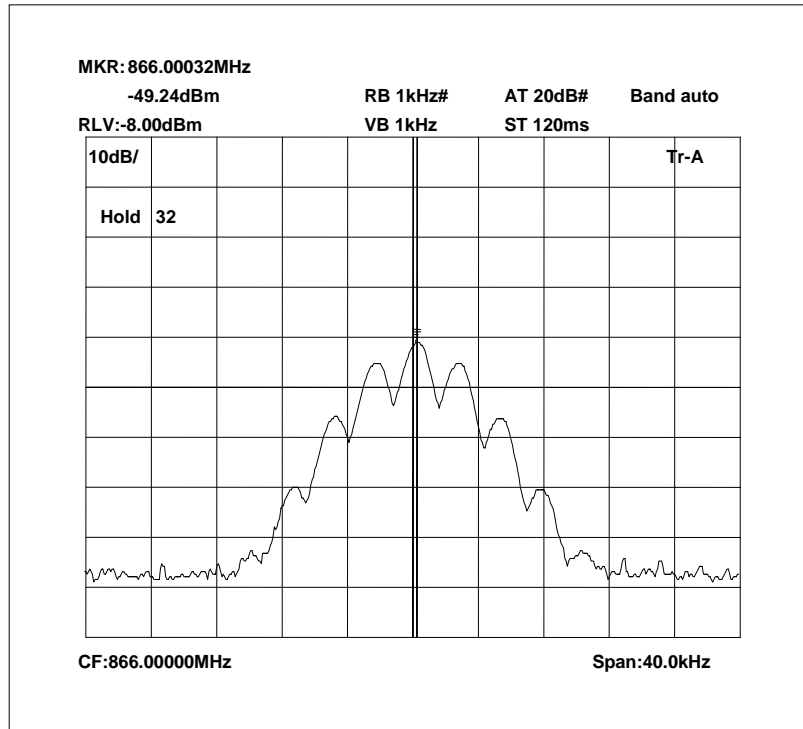

866.0MHz Signal Generator and EUT. FM deviation set to 5kHz

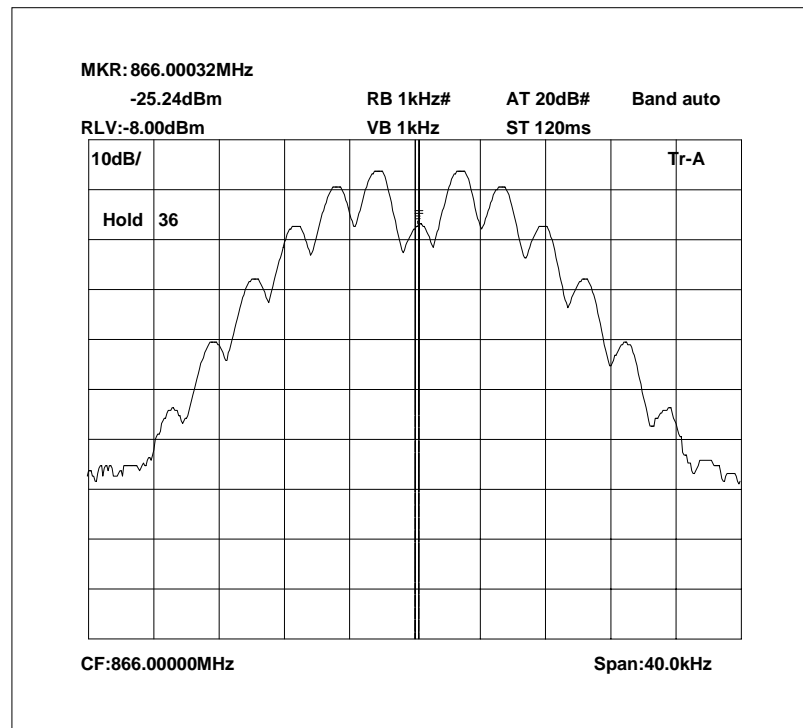

The above plots depicting the output wavelshape show no measurable distortion visible. When compared to the input signal.

881.0MHz Signal Generator. FM deviation set to 5kHz

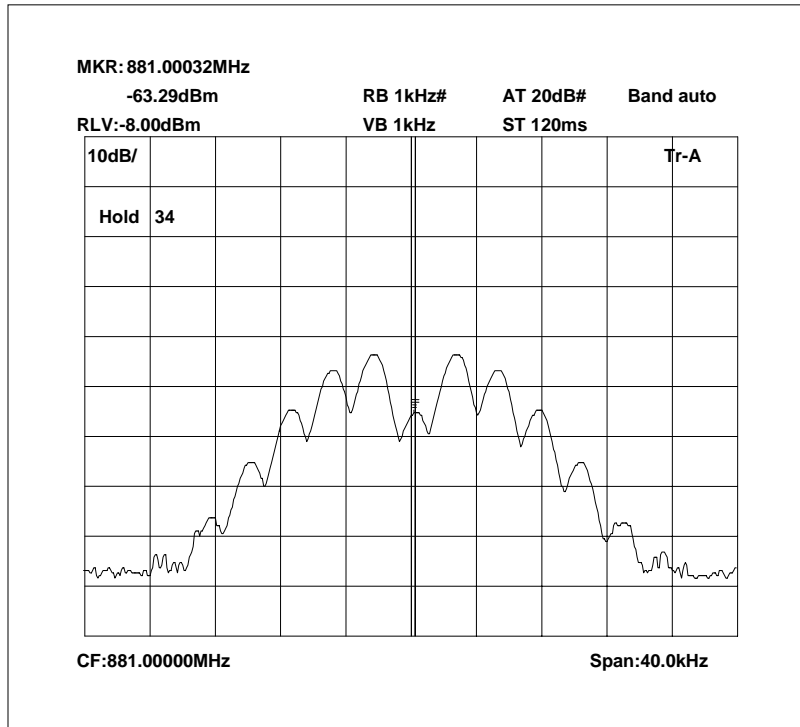

881.0MHz Signal Generator and EUT. FM deviation set to 5kHz

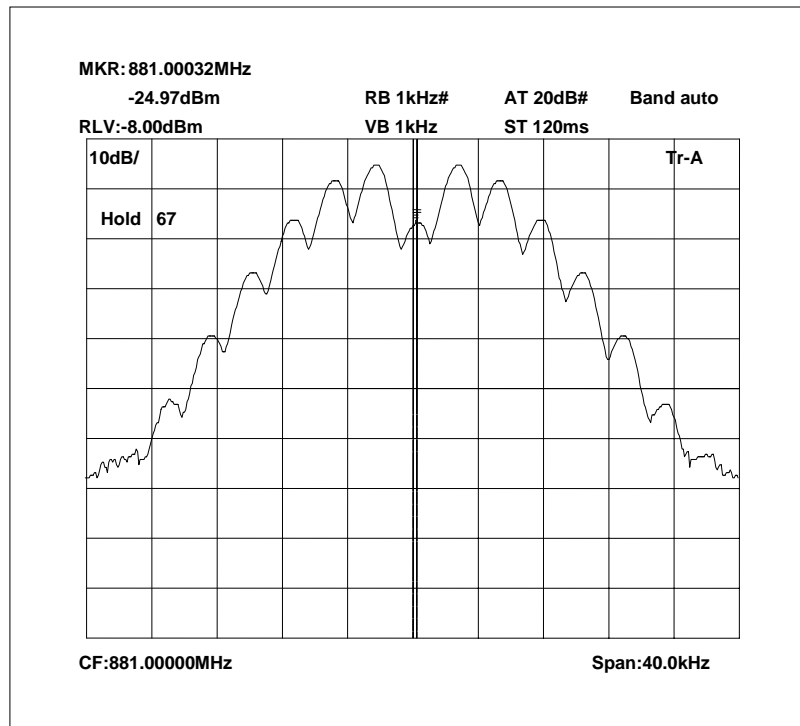

The above plots depicting the output waveshape show no measurable distortion visible. When compared to the input signal.

896.0MHz Signal Generator. FM deviation set to 5kHz

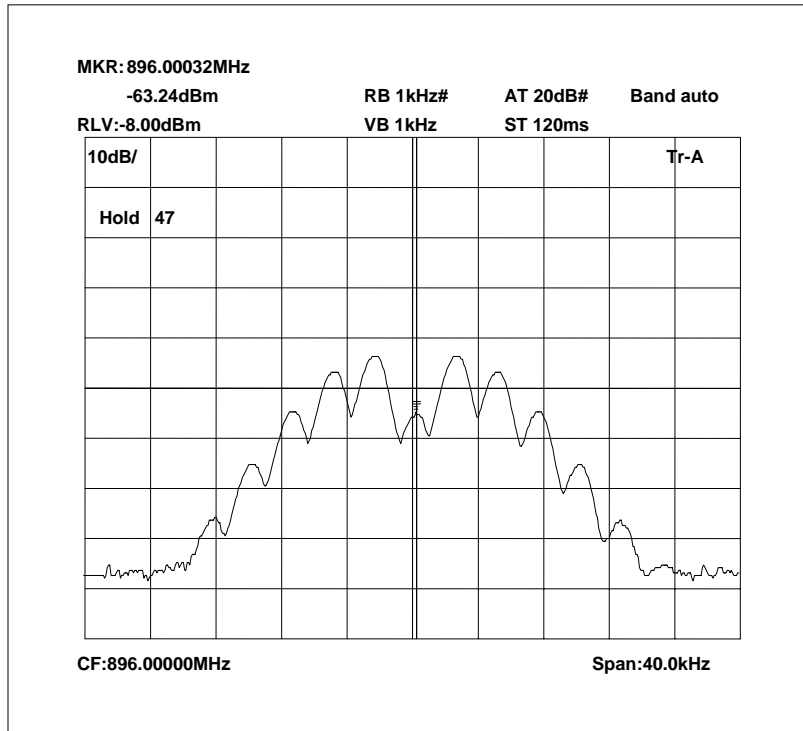

896.0 MHz Signal Generator and EUT. FM deviation set to 5kHz

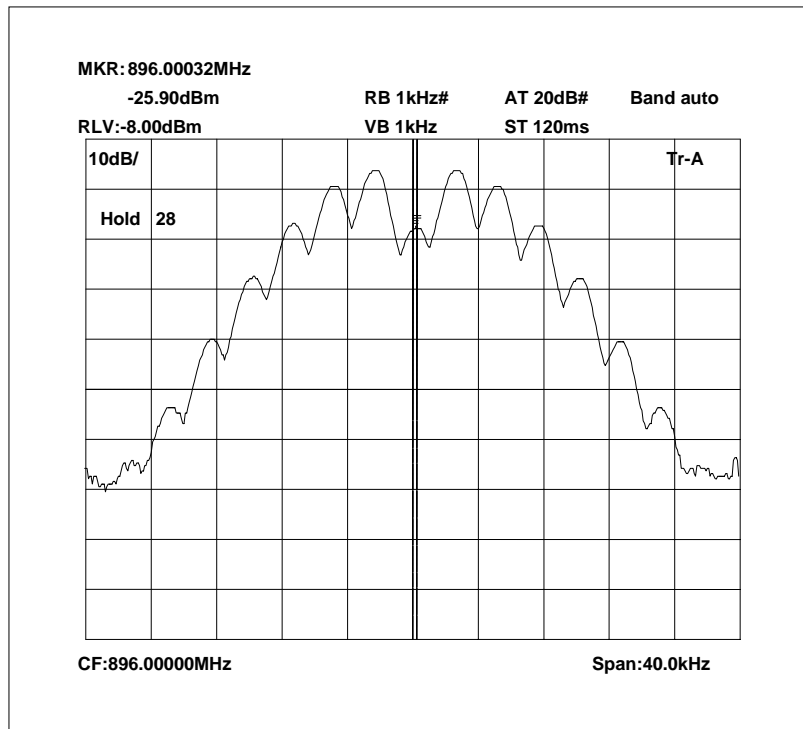

The above plots depicting the output waveshape show no measurable distortion visible. When compared to the input signal.

TRANSMITTER TESTS

AMPLIFIER SPURIOUS EMISSIONS – CONDUCTED – Part 2.1053 – DOWNLINK

Ambient temperature = 25°C
 Relative humidity = 39%
 Supply voltage = 110Vac

Radio Laboratory Test Signal = F3E

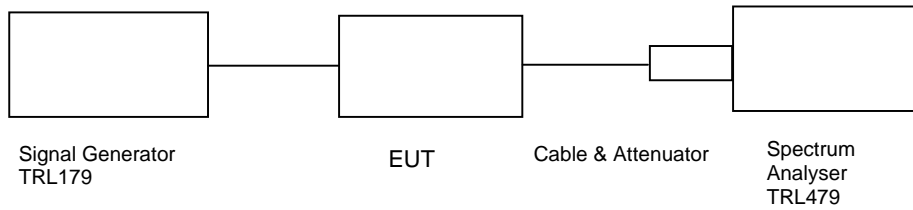

The test was set up as per the diagram. The level at the input was adjusted to compensate for the loss of the interconnecting cable. The unit was tested operating at maximum power and on three test frequencies.

The Spurious limit was calculated as follows:

On any frequency removed from the assigned frequency by more that 250% of the authorised bandwidth

At least 43 + 10 log PdB

$$(10\log P_{\text{watts}}) - (43+10\log (P_{\text{watts}} * 1000)) = \text{LIMIT} = -13 \text{ dBm}$$

The test equipment used for the Transmitter Conducted Emissions:

TYPE OF EQUIPMENT	MAKER/SUPPLIER	MODEL No	SERIAL No	TRL No	ACTUAL EQUIPMENT USED
SPECTRUM ANALYSER	ANRITSU	MS2665C	MT26089	479	X
ATTENUATOR	BIRD	8304-300-N	N/A	220	X
ATTENUATOR	BIRD	8304-100-N	N/A	222	X
CABLE	ROSENBERGER	MICRO COAX	N/A	279	X
SIGNAL GENERATOR	MARCONI	2042	119388/080	179	X

Conducted emissions 866.0 MHz 0MHz – 3000MHz

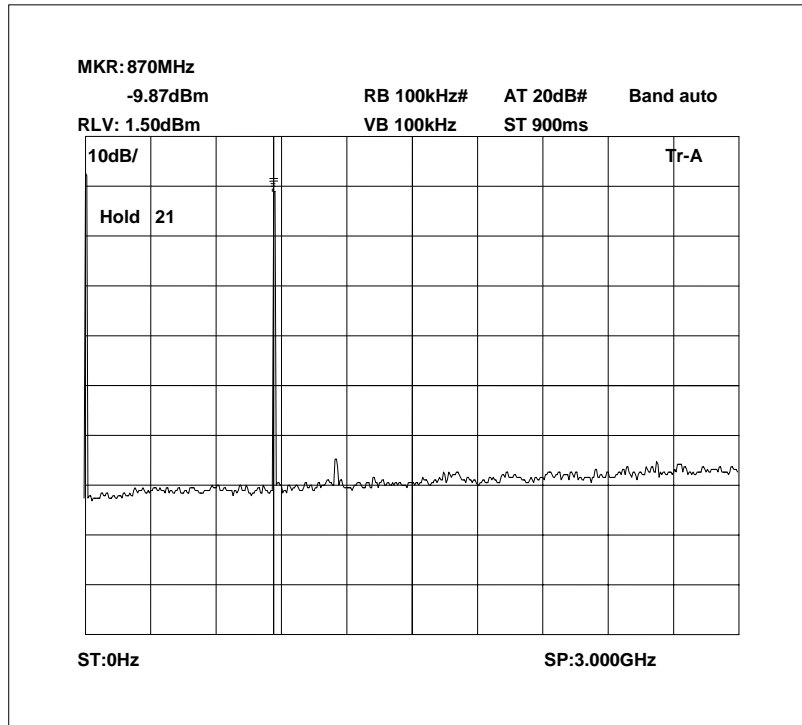

Conducted emissions 866.0 MHz 3000MHz – 9000MHz

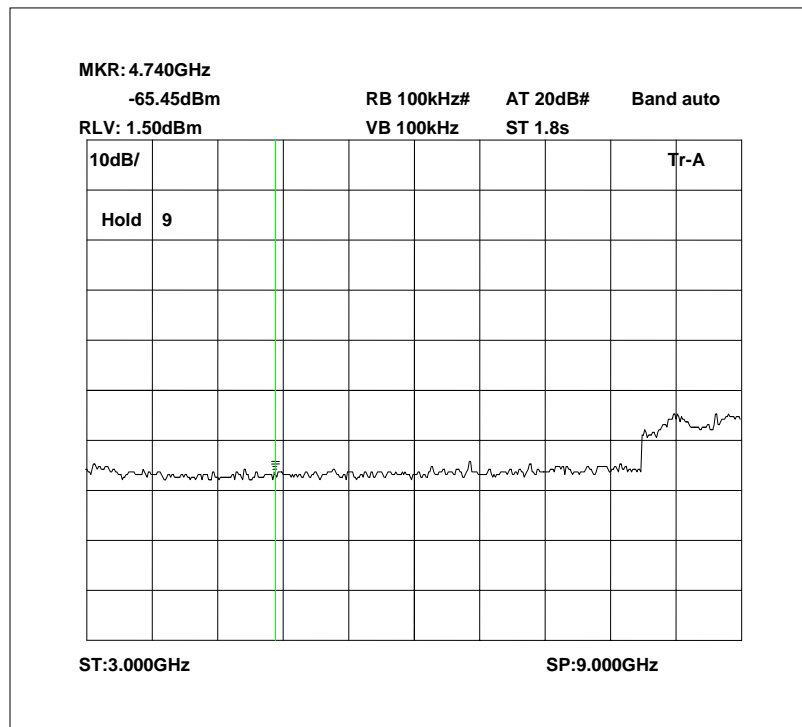

Conducted emissions 881.0 MHz 0MHz – 3000MHz

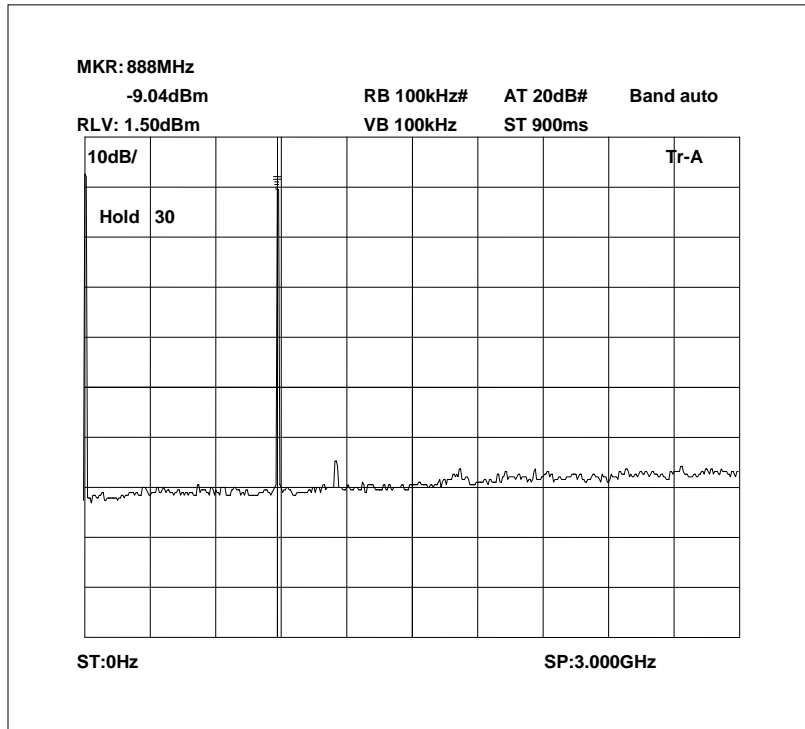

Conducted emissions 881.0 MHz 3000MHz – 9000MHz

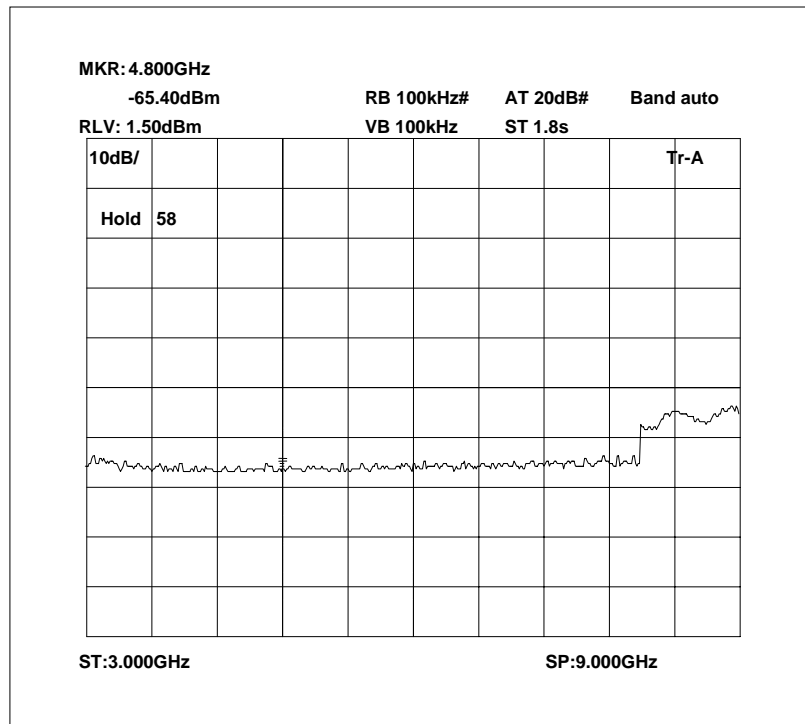

Conducted emissions 896.0 MHz 0MHz – 3000MHz

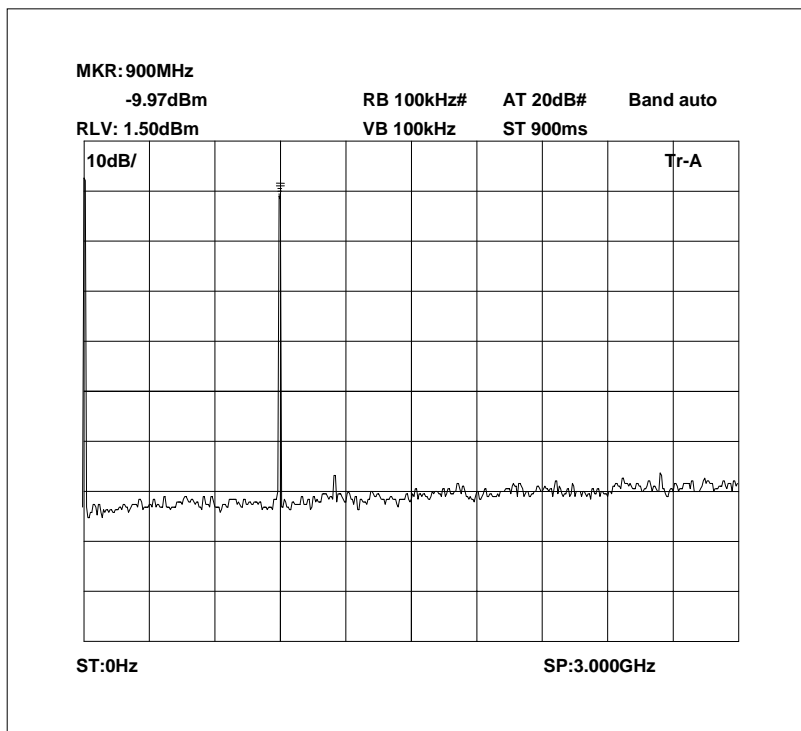

Conducted emissions 896.0 MHz 3000MHz – 9000MHz

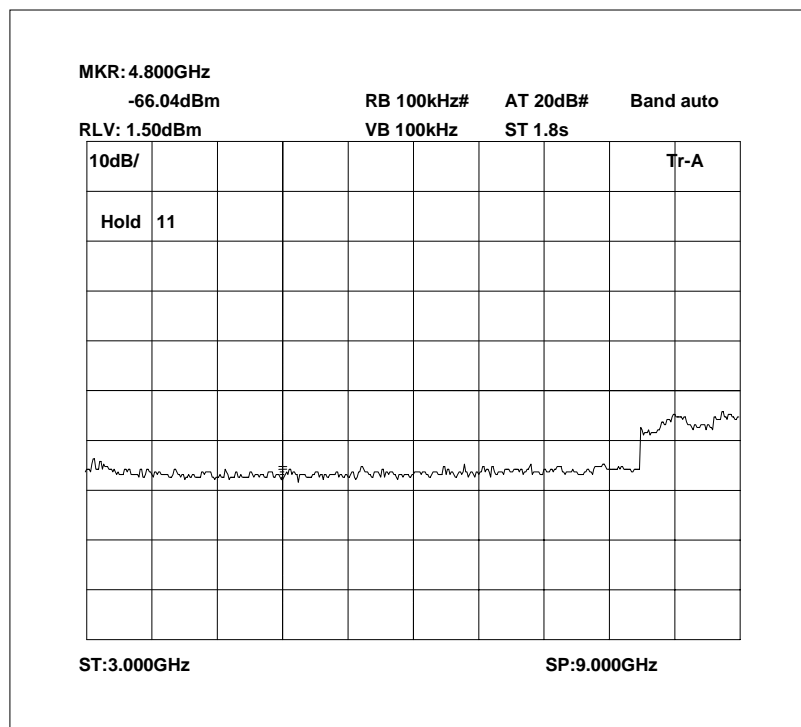

TRANSMITTER TESTS

AMPLIFIER SPURIOUS EMISSIONS – RADIATED – Part 2.1053– DOWNLINK

Ambient temperature = 6°C
 Relative humidity = 39%
 Conditions = OATS
 Supply voltage = 110Vac
 Supply Frequency = 60Hz

Test Signal = F3E

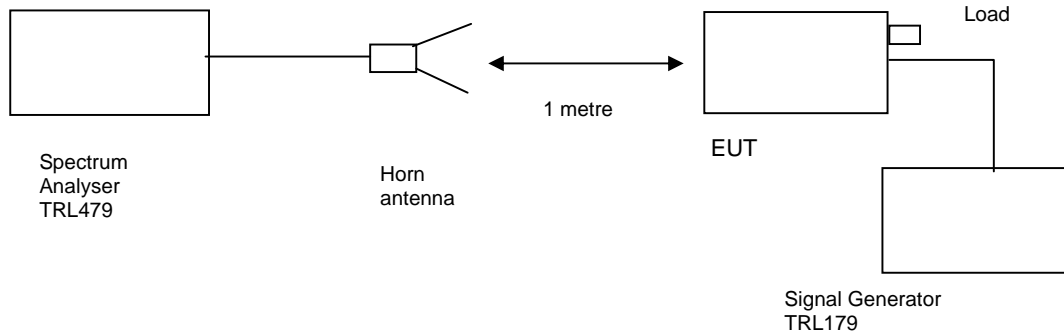

The test was set up as per the diagram. The level at the input was adjusted to compensate for the loss of the interconnecting cable. The unit was tested operating maximum power on three test frequencies with a 50 ohm load on the output. The unit was also tested with the signal generator replaced by another 50ohm load.

The Spurious limit was calculated as follows:

On any frequency removed from the assigned frequency by more that 250% of the authorised bandwidth

At least $43 + 10 \log \text{PdB}$

$$(10 \log P_{\text{watts}}) - (43 + 10 \log (P_{\text{watts}} * 1000)) = \text{LIMIT} = -13 \text{ dBm}$$

TYPE OF EQUIPMENT	MAKER/SUPPLIER	MODEL No	SERIAL No	TRL No	ACTUAL EQUIPMENT USED
SPECTRUM ANALYSER	ANRITSU	MS2665C	MT26089	479	X
HORN	EMCO	3115	9010-3581	139	X
50 OHM LOAD	PHILCO	160B-300	1643	UH139	X
50 OHM LOAD	RHODE & SCHWARZ	200.0019.55	300804/32	UH227	X
CABLE	ROSENBERGER	MICRO COAX	N/A	280	X
SIGNAL GENERATOR	MARCONI	2042	119388/080	179	X

Radiated emissions 866.0 MHz 30MHz – 1000MHz

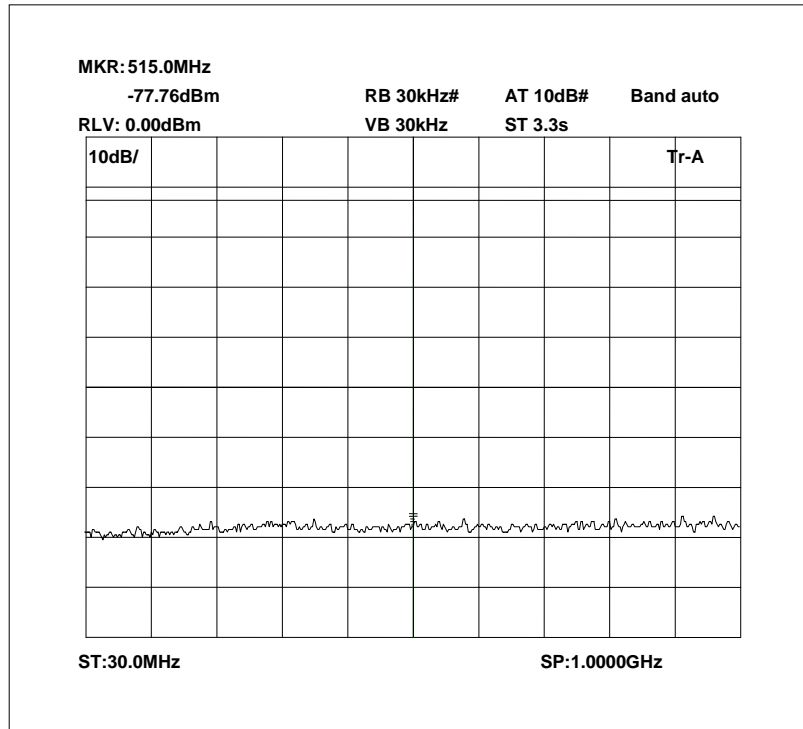

Radiated emissions 866.0 MHz 1000MHz – 4000MHz

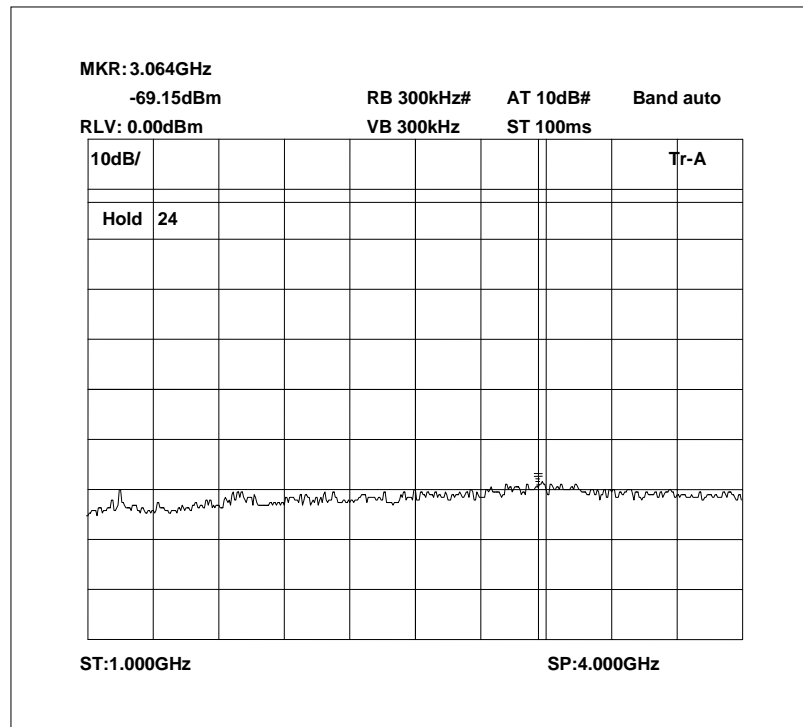

Radiated emissions 866.0 MHz 4000MHz – 7000MHz

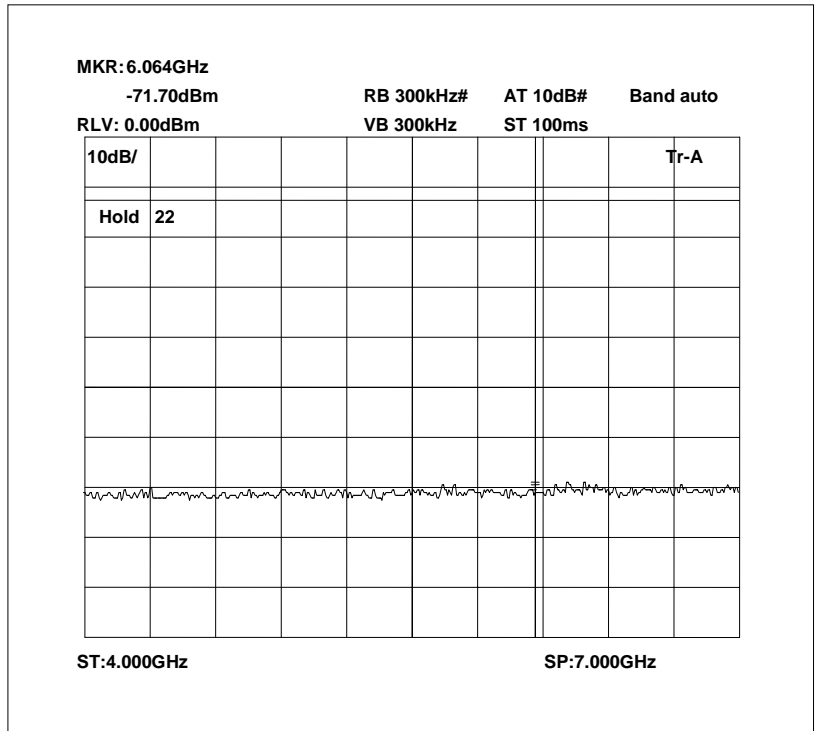

Radiated emissions 866.0 MHz 7000MHz – 10000MHz

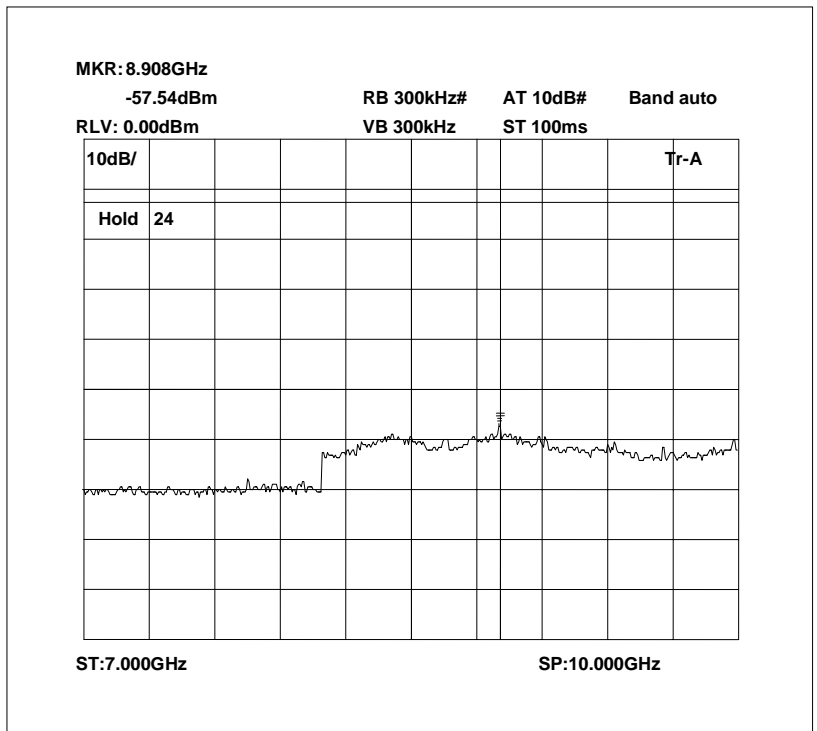

Radiated emissions 881.0 MHz 400MHz – 7000MHz

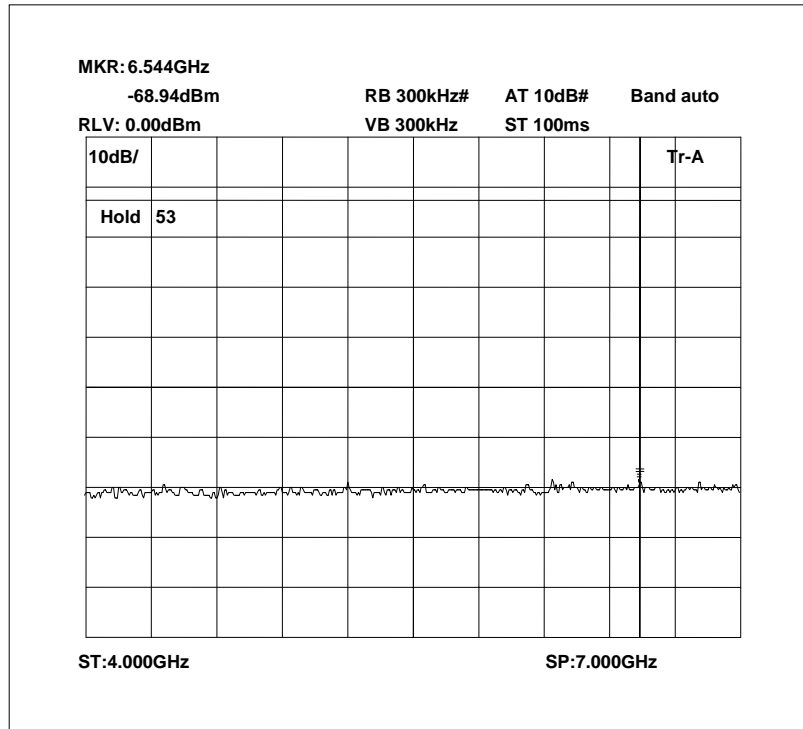

Radiated emissions 881.0 MHz 7000MHz – 10000MHz

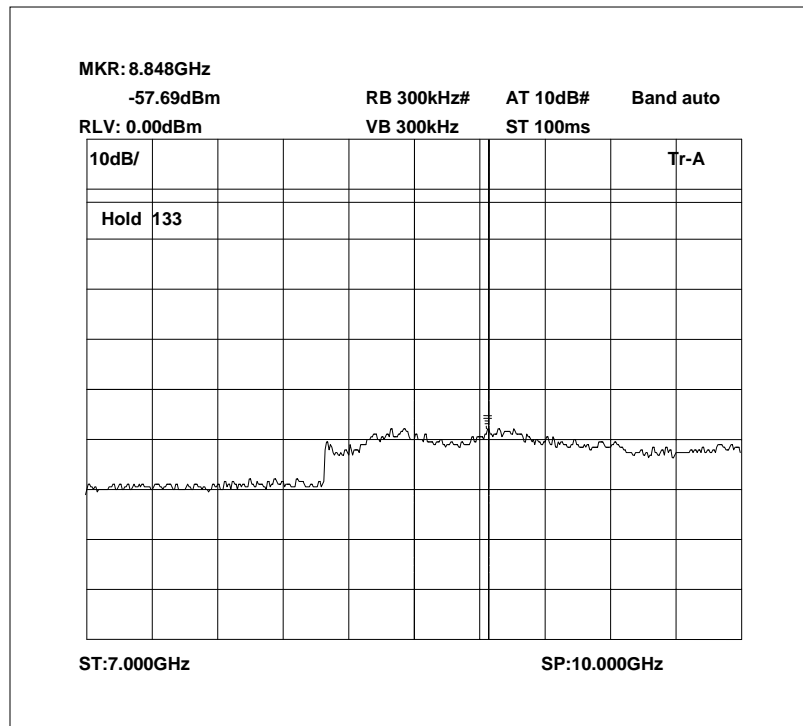

Radiated emissions 896.0 MHz 30MHz – 1000MHz

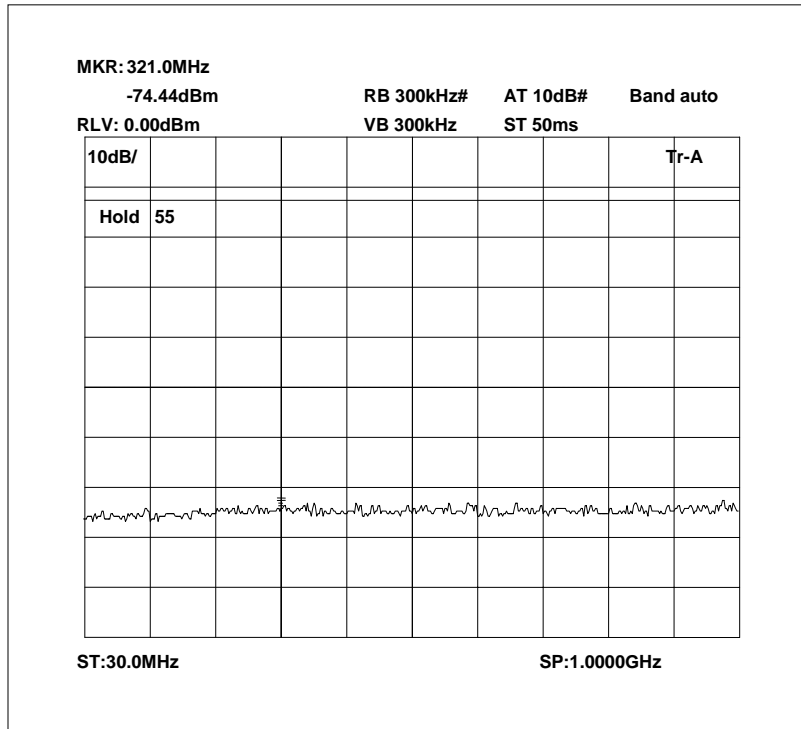

Radiated emissions 896.0 MHz 1000MHz – 4000MHz

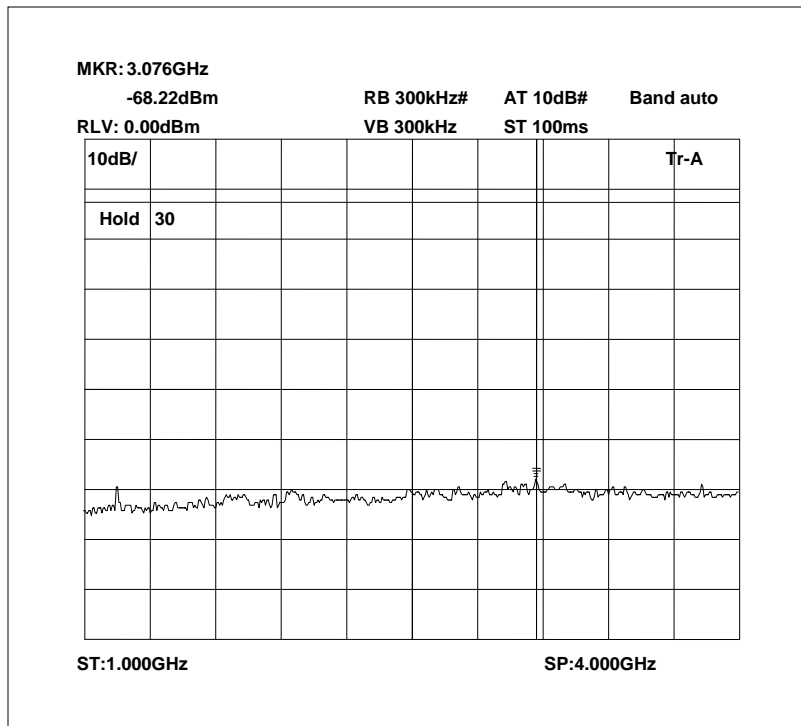

Radiated emissions 896.0 MHz 4000MHz – 7000MHz

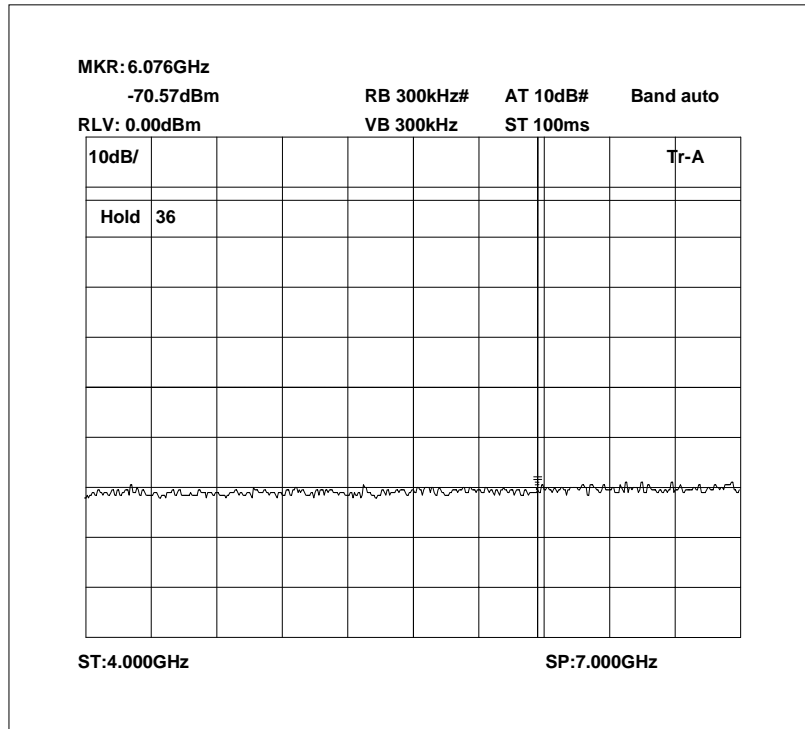

Radiated emissions 896.0 MHz 7000MHz – 10000MHz

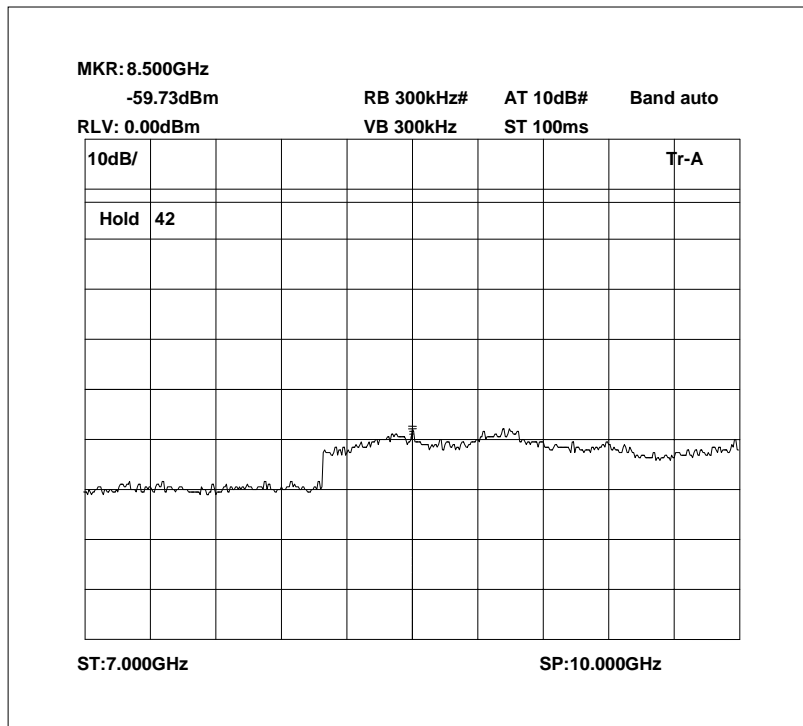

Radiated emissions no input signal 30MHz - 1000MHz

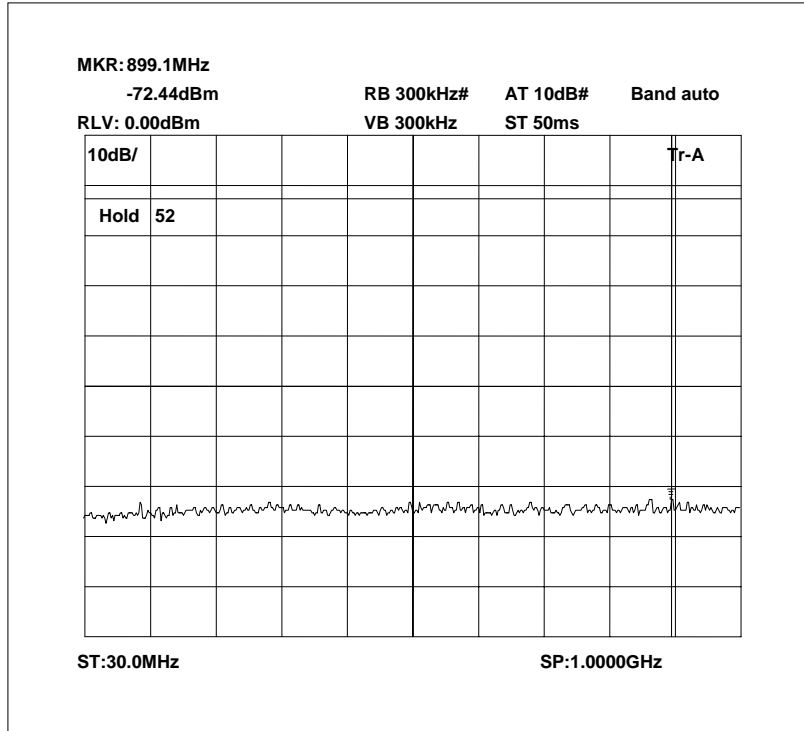

Radiated emissions no input signal 1000MHz - 4000MHz

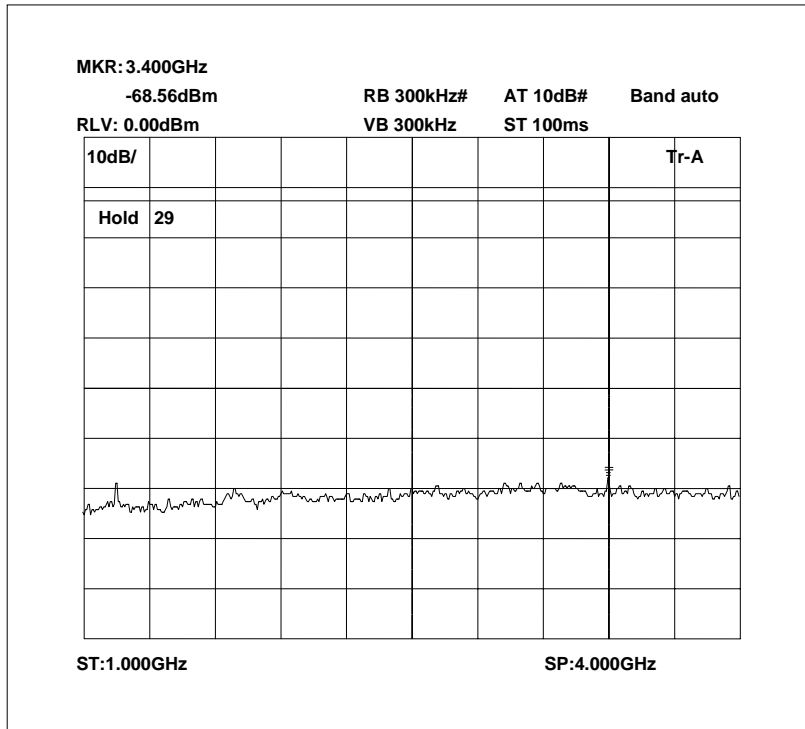

The above test results show that there were no emissions within 20dBs of the -13dBm limit.

Radiated emissions no input signal 4000MHz – 7000MHz

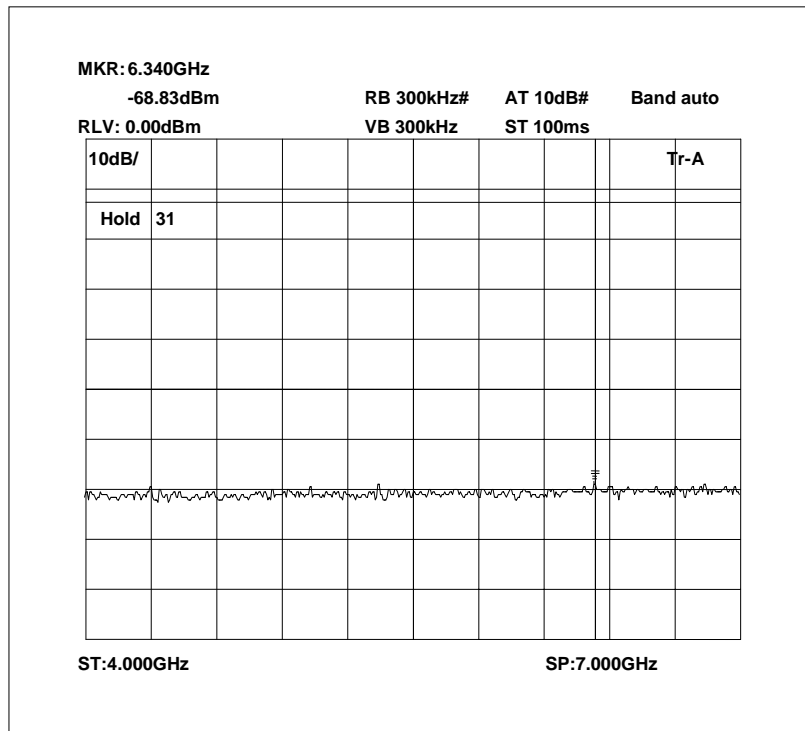

Radiated emissions no input signal 7000MHz – 10000MHz

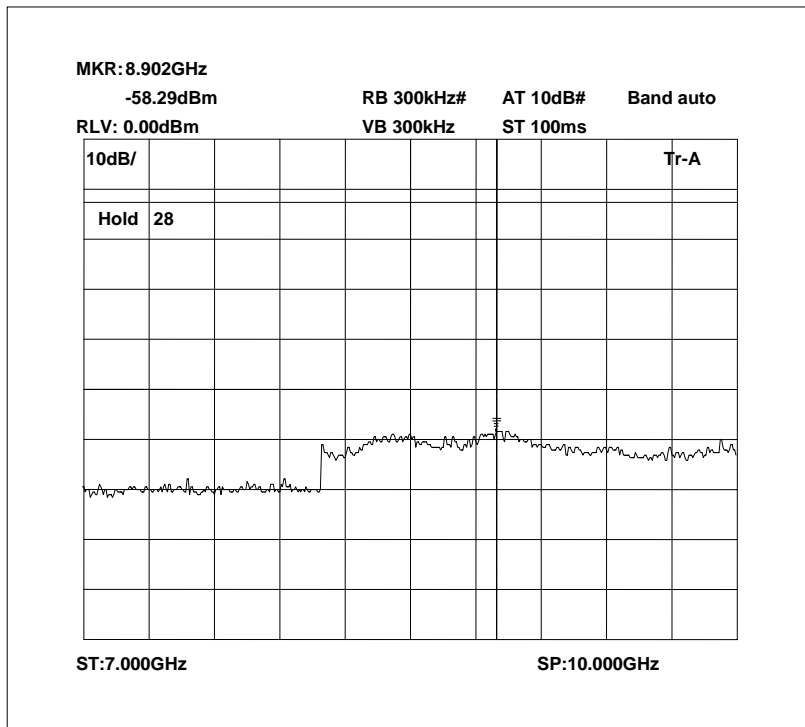

The above test results show that there were no emissions within 20dBs of the -13dBm limit.

ANNEX A
PHOTOGRAPHS

PHOTOGRAPH No. 1

CONDUCTED TEST SETUP



PHOTOGRAPH No. 2

RADIATED TEST SETUP



ANNEX B
APPLICANT'S SUBMISSION OF DOCUMENTATION LIST

APPLICANT'S SUBMISSION OF DOCUMENTATION LIST

a.	TCB	-	APPLICATION	[X]
		-	FEE	[X]
b.	AGENT'S LETTER OF AUTHORISATION	-		[X]
c.	MODEL(s) vs IDENTITY	-		[]
d.	ALTERNATIVE TRADE NAME DECLARATION(s)	-		[]
e.	LABELLING	-	PHOTOGRAPHS	[]
		-	DECLARATION	[]
		-	DRAWINGS	[]
f.	TECHNICAL DESCRIPTION	-		[X]
g.	BLOCK DIAGRAMS	-	Tx	[X]
		-	Rx	[]
		-	PSU	[]
		-	AUX	[]
h.	CIRCUIT DIAGRAMS	-	Tx	[]
		-	Rx	[]
		-	PSU	[]
		-	AUX	[]
i.	COMPONENT LOCATION	-	Tx	[]
		-	Rx	[]
		-	PSU	[]
		-	AUX	[]
j.	PCB TRACK LAYOUT	-	Tx	[]
		-	Rx	[]
		-	PSU	[]
		-	AUX	[]
k.	BILL OF MATERIALS	-	Tx	[]
		-	Rx	[]
		-	PSU	[]
		-	AUX	[]
l.	USER INSTALLATION / OPERATING INSTRUCTIONS	-		[X]