

Report on the Radio Testing

For

Axell Wireless Limited

on

51-105001

Report no. TRA-028456-47-00C

28th October 2016

RFXXX

Report Number: TRA-028456-47-00C
Issue: A

REPORT ON THE RADIO TESTING OF A
Axell Wireless Limited
51-105001
WITH RESPECT TO SPECIFICATION
FCC 47CFR 90 & IC RSS-131

TEST DATE: 9th November 2015 - 12th November 2015

Written by: S Hodgkinson

S Hodgkinson, D Winstanley
Radio Test engineer

Approved by:

J Charters
Department Manager - Radio

Date: 28th October 2016

Disclaimers:

- [1] THIS DOCUMENT MAY BE REPRODUCED ONLY IN ITS ENTIRETY AND WITHOUT CHANGE
[2] THE RESULTS CONTAINED IN THIS DOCUMENT RELATE ONLY TO THE ITEM(S) TESTED

1 Revision Record

<i>Issue Number</i>	<i>Issue Date</i>	<i>Revision History</i>
A	28th October 2016	Original

2 Summary

TEST REPORT NUMBER: TRA-028456-47-00C

WORKS ORDER NUMBER: TRA-028456-00

PURPOSE OF TEST: USA: Testing of radio frequency equipment per the relevant authorization procedure of chapter 47 of CFR (code of federal regulations) Part 2, subpart J.
Canada: Testing of radio apparatus for TAC (technical acceptance certificate) per subsections 4(2) of the Radiocommunication Act and 21(1) of the Radiocommunication Regulations

TEST SPECIFICATION: 47CFR90 & RSS-131

EQUIPMENT UNDER TEST (EUT): 51-105001

FCC IDENTIFIER: NEO51-105SERIES
INDUSTRY CANADA: 8749A-51105SERIES

EUT SERIAL NUMBER: 26849 G

MANUFACTURER/AGENT: Axell Wireless Limited

ADDRESS: Aerial House
Asheridge Road
Chesham
Bucks
HP5 2QD
United Kingdom

CLIENT CONTACT: Brian Barton
☎ 01494 777 014
✉ Brian.Barton@axellwireless.com

ORDER NUMBER: Not Applicable

TEST DATE: 9th November 2015 - 12th November 2015

TESTED BY: S Hodgkinson, D Winstanley
Element

2.1 Test Summary

Test Method and Description	Requirement Clause		Applicable to this equipment	Result / Note
	RSS-131	47CFR90		
RF power output (mean output power)	6.2	90.219(e)(1)	<input checked="" type="checkbox"/>	
Modulation characteristics				
Noise figure	-	90.219(e)(2)	<input checked="" type="checkbox"/>	
Retransmitted masks	6.3.2	90.219(e)(4)(ii); 90.219(e)(4)(iii)	<input checked="" type="checkbox"/>	
Occupied bandwidth				
Passband gain and bandwidth	6.1	-	<input checked="" type="checkbox"/>	
Spurious emissions at antenna terminals	6.4	90.219(e)(3)	<input checked="" type="checkbox"/>	
Intermodulation products	6.3.1	-	<input checked="" type="checkbox"/>	
Field strength of spurious radiation	-	90.219(e)(3)	<input checked="" type="checkbox"/>	
Frequency stability	6.5	90.213	<input type="checkbox"/>	Note 1

Note 1 :Not Applicable the EUT is not a frequency translator.

Notes:

The results contained in this report relate only to the items tested, in the condition at time of test, and were obtained in the period between the date of initial receipt of samples and the date of issue of the report.

The apparatus was set-up and exercised using the configurations, modes of operation and arrangements defined in this report only. Any modifications made are identified in Section 8 of this report.

Particular operating modes, apparatus monitoring methods and performance criteria required by the standards tested to have been performed except where identified in Section 5.2 of this test report (Deviations from Test Standards).

The spectrum Analyser, time and date stamp, might not show the correct information. The correct date of the testing is declared on the front page of the document, and on any subsequent page that references the time and date of the testing.

3 Contents

1	Revision Record	3
2	Summary	4
2.1	Test Summary	5
3	Contents	6
4	Introduction	8
5	Test Specifications	9
5.1	Normative References	9
5.2	Deviations from Test Standards	9
6	Glossary of Terms	10
7	Equipment Under Test	11
7.1	EUT Identification	11
7.2	System Equipment	11
7.3	EUT Mode of Operation	11
7.3.1	Transmissions uplink / downlink	11
7.4	EUT Radio Frequency Parameters	11
7.4.1	General	11
7.5	EUT Description	12
8	Modifications	13
9	EUT Test Setup	14
9.1	Block Diagram	14
9.2	General Set-up Photograph	15
10	General Technical Parameters	16
10.1	Normal Conditions	16
10.2	Varying Test Conditions	16
11	RF power output (mean output power)	17
11.1	Definition	17
11.2	Test Parameters	17
11.3	Test Limits	17
11.3.1	RSS-131	17
11.3.2	47CFR90	18
11.4	Test Method	18
11.5	Test Equipment	19
11.6	Test Results	20
12	Noise figure	27
12.1	Definition	27
12.2	Test Parameters	27
12.3	Test Limits – Noise Figure	27
12.4	Test Method	27
12.5	Test Equipment	28
12.6	Test Results	28
12.7	Test Limits – Noise at Antenna Terminals	32
13	Retransmitted masks	35
13.1	Definition	35
13.2	Test Parameters	35
13.3	Test Limits	35
13.3.1	FCC 47CFR90	35
13.3.2	36	
13.3.3	IC RSS-131	36
13.4	Test Method	36
13.5	Test Equipment	36
13.6	Test Results	37
14	Passband gain and bandwidth	54
14.1	Definition	54
14.2	Test Parameters	54
14.3	Test Limits	54
14.3.1	FCC 47CFR90	54
14.3.2	RSS-131	54
14.4	Test Method	54
14.5	Test Equipment	55
14.6	Test Results	56
15	Spurious emissions at antenna terminals	62
15.1	Definition	62
15.2	Test Parameters	62
15.3	Test Limits	62
15.3.1	IC RSS-131	62
15.3.2	47CFR90	62

15.4	Test Method.....	63
15.5	Test Equipment.....	63
15.6	Test Results.....	64
15.6.1	Out-of-band - Downlink.....	64
	Out-of-band - Uplink.....	75
16	Intermodulation products.....	88
16.1	Definition.....	88
16.2	Test Parameters.....	88
16.3	Test Limits.....	88
16.4	Test Method.....	88
16.5	Test Equipment.....	89
16.6	Test Results.....	90
17	Field strength of spurious radiation.....	98
17.1	Definitions.....	98
17.2	Test Parameters.....	98
17.3	Test Limits.....	98
17.4	Test Method.....	98
17.5	Test Equipment.....	99
17.6	Test Results.....	101
18	Measurement Uncertainty.....	107
19	Client Declaration.....	109

4 Introduction

This report TRA-028456-47-00C presents the results of the Radio testing on a Axell Wireless Limited, 51-105001 to specification 47CFR90.219 Use of signal boosters and RSS-131 Zone Enhancers for the Land Mobile Service.

The testing was carried out for Axell Wireless Limited by Element, at the address(es) detailed below.

- | | | | |
|--------------------------|---|-------------------------------------|--|
| <input type="checkbox"/> | Element Hull
Unit E
South Orbital Trading Park
Hedon Road
Hull
HU9 1NJ
UK | <input checked="" type="checkbox"/> | Element Skelmersdale
Unit 1
Pendle Place
Skelmersdale
West Lancashire
WN8 9PN
UK |
|--------------------------|---|-------------------------------------|--|

This report details the configuration of the equipment, the test methods used and any relevant modifications where appropriate.

FCC Site Listing:

The test laboratory is accredited for the above sites under the US-EU MRA, Designation number UK0009.

IC Registration Number(s):

Element Skelmersdale	3930B-4
Element Hull	3483A

The test site requirements of ANSI C63.4-2014 are met up to 1GHz.

The test site SVSWR requirements of CISPR 16-1-4:2010 are met over the frequency range 1 GHz to 18 GHz.

5 Test Specifications

5.1 Normative References

- FCC 47 CFR Ch. I – Part 90 – Private Land Mobile Radio Services
- FCC KDB Publication 935210 D05 v01 June 5, 2015 – Measurements guidance for industrial and non-consumer signal booster, repeater and amplifier devices.
- TIA-603-D-2010 – Land Mobile FM or PM - Communications Equipment - Measurement and Performance Standards
- ANSI C63.4-2014 – American National Standard for Methods of Measurement of Radio-Noise Emissions from Low-Voltage Electrical and Electronic Equipment in the Range of 9 kHz to 40 GHz.
- Industry Canada RSS-131, Issue 2, July 2003 – Zone Enhancers for the Land Mobile Service

5.2 Deviations from Test Standards

There were no deviations from the test standard.

6 Glossary of Terms

§	Denotes a section reference from the standard, not this document
AC	Alternating Current
AM	Amplitude Modulated
AWGN	Additive White Gaussian Noise
BW	Bandwidth
C	Celcius
CW	Continuous Wave
Class A	Class A signal booster is designed to retransmit signals on one or more specific channels where none of its passbands exceed 75kHz.
Class B	Class B signal booster is designed to retransmit any signals within a wide frequency band greater than 75kHz.
dB	Decibels
dBm	dB relative to 1 milliwatt
CDMA	Code Division Multiple Access – a modulation technique used in cellular networks
DC	Direct Current
EIRP	Equivalent Isotropically Radiated Power
emf	electromotive force
erp	Effective Radiated Power
EUT	Equipment Under Test
f	Frequency
FCC	Federal Communications Commission
GSM	Group Special Mobile – a cellular network standard
Hz	Hertz
IF	Intermediate Frequency
ITU	International Telecommunication Union
KDB	Knowledge Data Base (of the FCC Office of Engineering and Technology).
LO	Local Oscillator
m	metre
max	Maximum
min	Minimum
N/A	Not Applicable
No.	Number
PCB	Printed Circuit Board
PDF	Portable Document Format
PLMR	Private Land Mobile Radio
RE	Radio Equipment
RF	Radio Frequency
RH	Relative Humidity
RMS	Root Mean Square
Rx	Receiver
s	Second
Tx	Transmitter
UKAS	United Kingdom Accreditation Service
V	Volt
W	Watt
Ω	Ohm

7 Equipment Under Test

7.1 EUT Identification

- Name: 51-105001
- Serial Number: 26849 G
- Model Number: D-CSR-3604 410/430 110VAC
- Software Revision: SW00352 Rev 1
- Build Level / Revision Number: Rev 4

7.2 System Equipment

Equipment listed below forms part of the overall test setup and is required for equipment functionality and/or monitoring during testing. The compliance levels achieved in this report relate only to the EUT and not items given in the following list.

OMU : Optical Master Unit

7.3 EUT Mode of Operation

7.3.1 Transmissions uplink / downlink

The mode of operation for Tx tests was a continuous test signal as required, see below

16K0F3E
11K3F3E
CW

7.4 EUT Radio Frequency Parameters

7.4.1 General

Frequency of operation:	410 MHz – 430MHz *
Passband gain:	Downlink: 86.81 dB Uplink : 86.75 dB
Supported channel bandwidth(s) & class:	Class A > 75 kHz
Rated mean output power (P_{rated}):	Downlink: 39.46 dBm Uplink : 39.21 dBm
Frequency stability:	Not Applicable
Nominal Supply Voltage:	110Vac
Method of prevention of use on non-US / non-Canadian frequencies:	Not Applicable

* EUT is software settable to operate on upto 8 channels over a 5 MHz portion of the 20 MHz operating range.

7.5 EUT Description

The EUT is a PLMRS booster operating over the frequency range 410 MHz - 430 MHz

For the purposes of testing the device was setup to operating the following bands.

Lower 5MHz Band 410.0 MHz – 415.0MHz

Middle 5MHz Band 427.5 MHz – 432.5 MHz

Upper 5MHz Band 425.0 MHz – 430.0 MHz

EUT is software settable to operate on up to 8 channels over a 5 MHz portion of the 20 MHz operating range. During testing the number of channels required by a specific test was active

8 Modifications

No modifications were performed during this assessment.

9 EUT Test Setup

9.1 Block Diagram

The following diagram shows basic EUT interconnections with cable type and cable lengths identified:

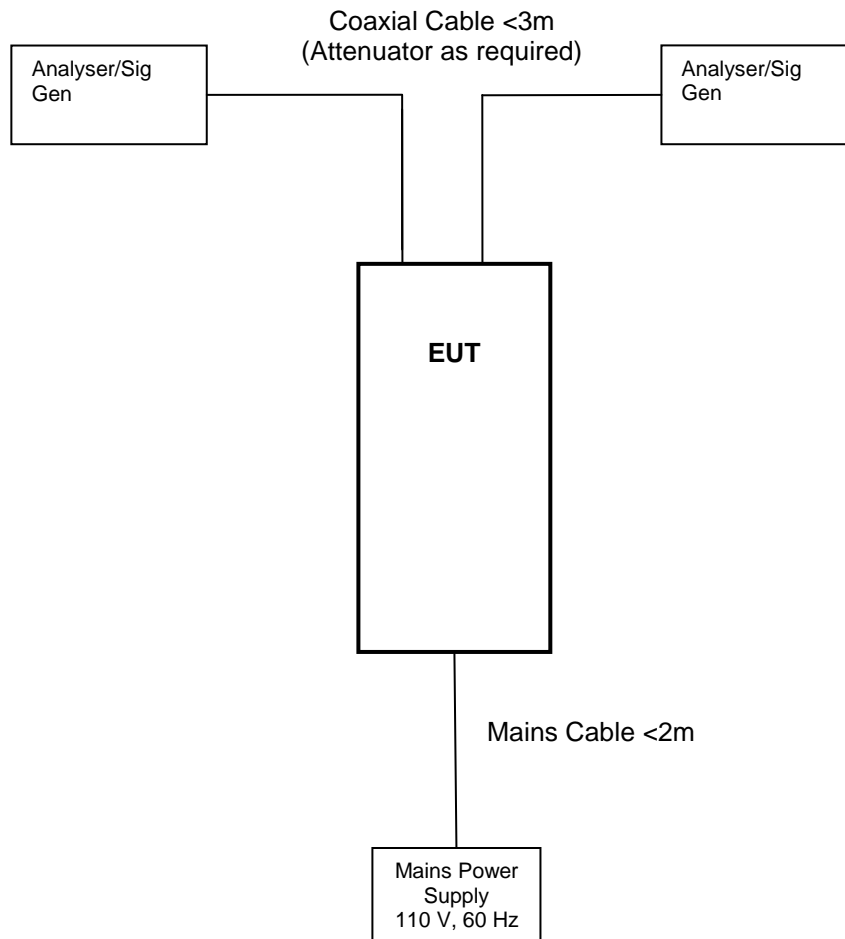

9.2 General Set-up Photograph

The following photograph shows basic EUT set-up:

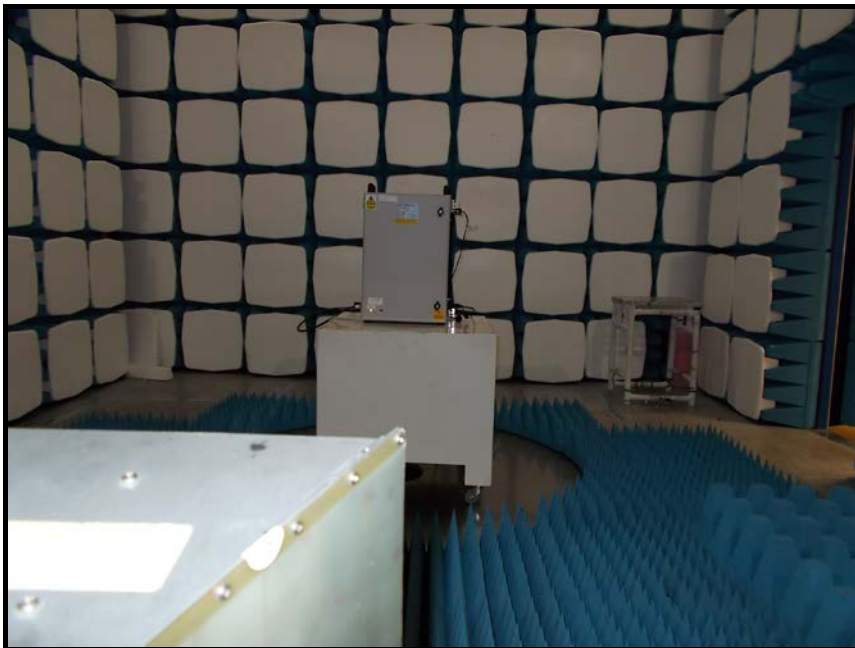

10 General Technical Parameters

10.1 Normal Conditions

The E U T was tested under the normal environmental conditions of the test laboratory, except where otherwise stated. The normal power source applied was 110 V ac from the mains.

10.2 Varying Test Conditions

Variation of temperature is required to ensure stability of the declared fundamental frequency. During frequency error testing the following variations were made:

	Category	Variation
<input type="checkbox"/>	Standard	-20 to +50 C in 10 degree steps
<input type="checkbox"/>	Extended	
<input checked="" type="checkbox"/>	Not Applicable	

Variation of supply voltage is required to ensure stability of the declared output power and frequency. During carrier power and frequency error testing the following variations were made:

	Category	Nominal	Variation
<input checked="" type="checkbox"/>	Mains	110V ac +/-2%	85% and 115%
<input type="checkbox"/>	Battery	New battery	N/A

11 RF power output (mean output power)

11.1 Definition

The average power supplied to the antenna transmission line by a transmitter during an interval of time sufficiently long compared with the lowest frequency encountered in the modulation taken under normal operating conditions.

11.2 Test Parameters

Test Location:	Element Skelmersdale
Test Chamber:	Radio Lab
Test Standard and Clause:	IC RSS-131, clause 4.3 KDB 935210 D05 v01, clause 4.5
EUT Operating Frequencies Tested:	412.5 MHz 420MHz, 427.5MHz
Source Modulations:	CW
Source Level:	-46.2 dBm (maximum input rating)
Deviations From Standard:	None
Bandwidth:	RBW 100 kHz; VBW 3xRBW
Span:	1 MHz
Measurement Detector	Peak; Max-Hold.

Environmental Conditions (Normal Environment)

Temperature: 22°C	+15 °C to +35 °C (as declared)
Humidity: 38%RH	20%RH to 75%RH (as declared)
Supply: 110 V ac	110Vac +/-10% (as declared)

11.3 Test Limits

11.3.1 RSS-131

The manufacturer's output power rating P_{rated} MUST NOT be greater than P_{mean} for all types of enhancers.

Additional Power Back-off Condition for Multiple Carrier Operations:

An example of a single carrier operation is a band translator that incorporates an (IF) filter of a passband equal to one channel bandwidth. Another example of a single carrier operation is the use of an enhancer, before the connection to the antenna, to boost a low power transmitter (single carrier) to a higher power.

An example of a multiple carrier operation is the use of an enhancer to amplify off-air signals that contain the wanted carrier and two (or more) adjacent band carriers. If the enhancer passband is wide enough to pass more than the wanted channel bandwidth, the enhancer output stage will be loaded by the multiple carriers.

Examination: with 3 carrier signals (of assumed equal level), the peak voltage will be 3 times the single carrier voltage. The corresponding Peak Envelope Power (PEP) will be 3^2 times greater than a single carrier or $9/4 = 2.25$ times greater than 2 tones PEP. Therefore the permissible wanted signal operating point has to be backed off by 3.5 dB (i.e. $P_{\text{permissible}} = P_{\text{rated}} - 3.5 \text{ dB}$).

Note 1: All enhancers will be classified in the Radio Equipment List (REL) for a single carrier operation.

Note 2: For a multiple carrier operation, the rating must be reduced by 3.5 dB or more.

Note 3: If there are more than 3 carriers present at the amplifier input point, greater power back-off may be required. This can be examined on a case-by-case basis.

11.3.2 47CFR90

The output power capability of a signal booster must be designed for deployments providing a radiated power not exceeding 5 Watts ERP for each retransmitted channel.

11.4 Test Method

Single Channel:

With the EUT setup as per section 9 of this report and connected as per Figure i, the power of the EUT was calculated by taking into account any cable and attenuator calibration factors. It was confirmed that at the maximum input level there was no compression.

Gain was calculated by removing the EUT from the setup and measuring the signal generator to EUT level.

Figure i Test Setup

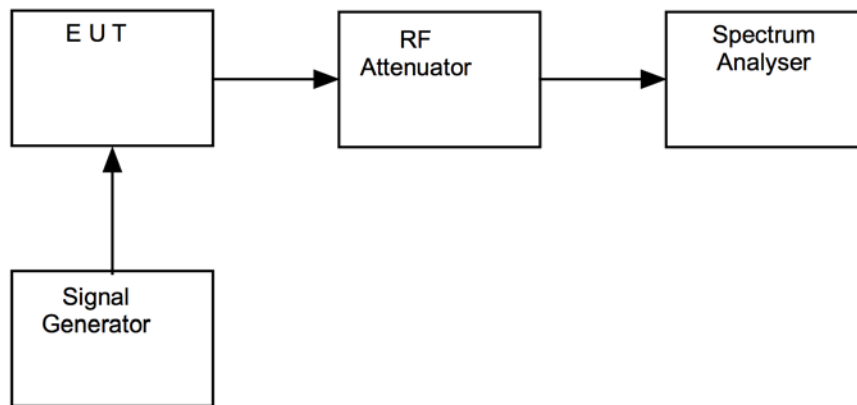

Multi-Channel (RSS-131):

With the EUT setup as per section 9 of this report and connected as per Figure ii, two similar sinusoidal signal inputs were used, such that the 3rd order intermodulation products were also within the passband of the EUT. The input level(s) were increased until the products met the required level. The output power of the EUT was calculated by the measurement of P_{01} , an additional 3dB representing the second equal input and taking into account any cable and attenuator calibration factors.

The gain was calculated by removing the EUT from the setup and measuring the signal generator to EUT level.

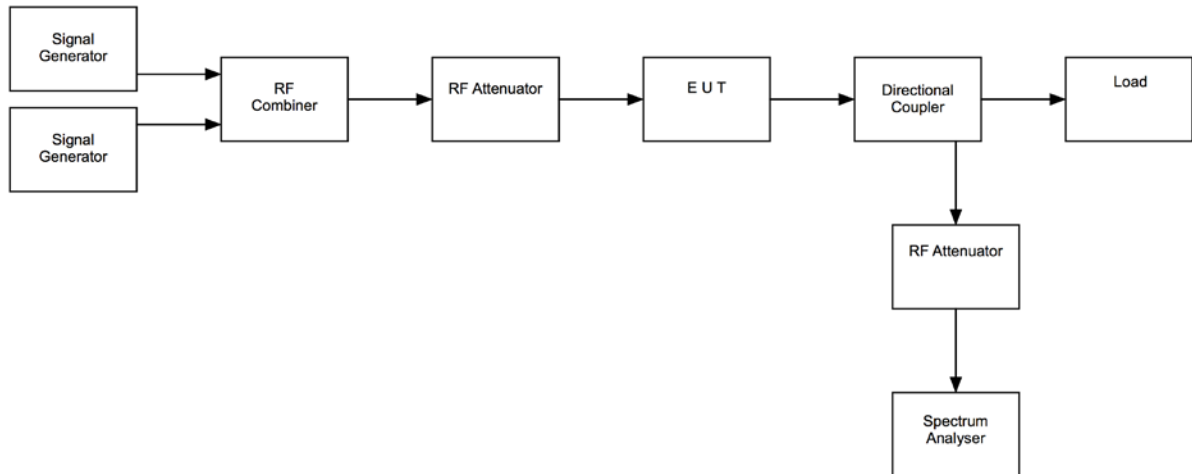
Figure ii Test Setup**11.5 Test Equipment**

Equipment Description	Manufacturer	Equipment Type	Element No	Last Cal Calibration	Calibration Period	Due For Calibration
Spectrum Analyser	R&S	FSU46	U281	24/04/2015	12	24/04/2016
Signal Generator	R&S	SMBV100A	REF916	17/02/2015	12	17/02/2016
Signal Generator	Agilent	ESG-D3000A	RFG441	08/10/2014	24	08/10/2016

11.6 Test Results

Downlink Single Channel @ AGC Threshold								
Channel Centre Frequency (MHz)	Modulation	Signal Generator Input Level (dBm)	Input Cable Loss (dB)	Level at Spectrum Analyser (dBm)	Output Cable & Attenuator Loss (dB)	Gain (dB)	Conducted Output Power (dBm)	Result
412.500	CW	-46.20	0.30	-1.25	40.3	85.55	39.05	PASS
420.000	CW	-47.10	0.30	-0.89	40.3	86.81	39.41	PASS
427.500	CW	-46.80	0.30	-1.00	40.3	86.40	39.30	PASS

Downlink Single Channel @ 3dB above AGC Threshold								
Channel Centre Frequency (MHz)	Modulation	Signal Generator Input Level (dBm)	Input Cable Loss (dB)	Level at Spectrum Analyser (dBm)	Output Cable & Attenuator Loss (dB)	Gain (dB)	Conducted Output Power (dBm)	Result
412.500	CW	-43.20	0.30	-2.46	40.30	74.34	37.84	PASS
420.000	CW	-44.10	0.30	-0.87	40.30	76.83	39.43	PASS
427.500	CW	-43.80	0.30	-1.10	40.30	76.30	39.20	PASS

Uplink Single Channel @ AGC Threshold								
Channel Centre Frequency (MHz)	Modulation	Signal Generator Input Level (dBm)	Input Cable Loss (dB)	Level at Spectrum Analyser (dBm)	Output Cable & Attenuator Loss (dB)	Gain (dB)	Conducted Output Power (dBm)	Result
412.500	CW	-46.80	0.30	-1.10	40.3	86.30	39.20	PASS
420.000	CW	-47.10	0.30	-0.95	40.3	86.75	39.35	PASS
427.500	CW	-46.90	0.20	-4.00	40.3	83.40	36.30	PASS

Uplink Single Channel @ 3dB above AGC Threshold								
Channel Centre Frequency (MHz)	Modulation	Signal Generator Input Level (dBm)	Input Cable Loss (dB)	Level at Spectrum Analyser (dBm)	Output Cable & Attenuator Loss (dB)	Gain (dB)	Conducted Output Power (dBm)	Result
412.500	CW	-43.80	0.30	-1.87	40.30	75.53	38.43	PASS
420.000	CW	-44.10	0.30	-0.93	40.30	76.77	39.37	PASS
427.500	CW	-43.90	0.30	-1.10	40.30	76.30	39.20	PASS

Above Tables for FCC only.

RSS 131 Downlink Lowest 5 MHz operating band Multi-channel @ AGC Threshold					
Signal	Frequency (MHz)	Level at Spectrum Analyser (dBm)	Network Loss (dB)	Output Power (dBm)	Result
P ₀₁	413.25	-5.17	40.3	35.13	Pass
P ₀₂	411.75	-5.68	40.3	34.62	
P ₀₃	410.25	-61.55	40.3	-21.25	
P ₀₄	414.75	-62.79	40.3	-22.49	
$P_{mean} = P_{01} + 3dB$		38.13			PASS

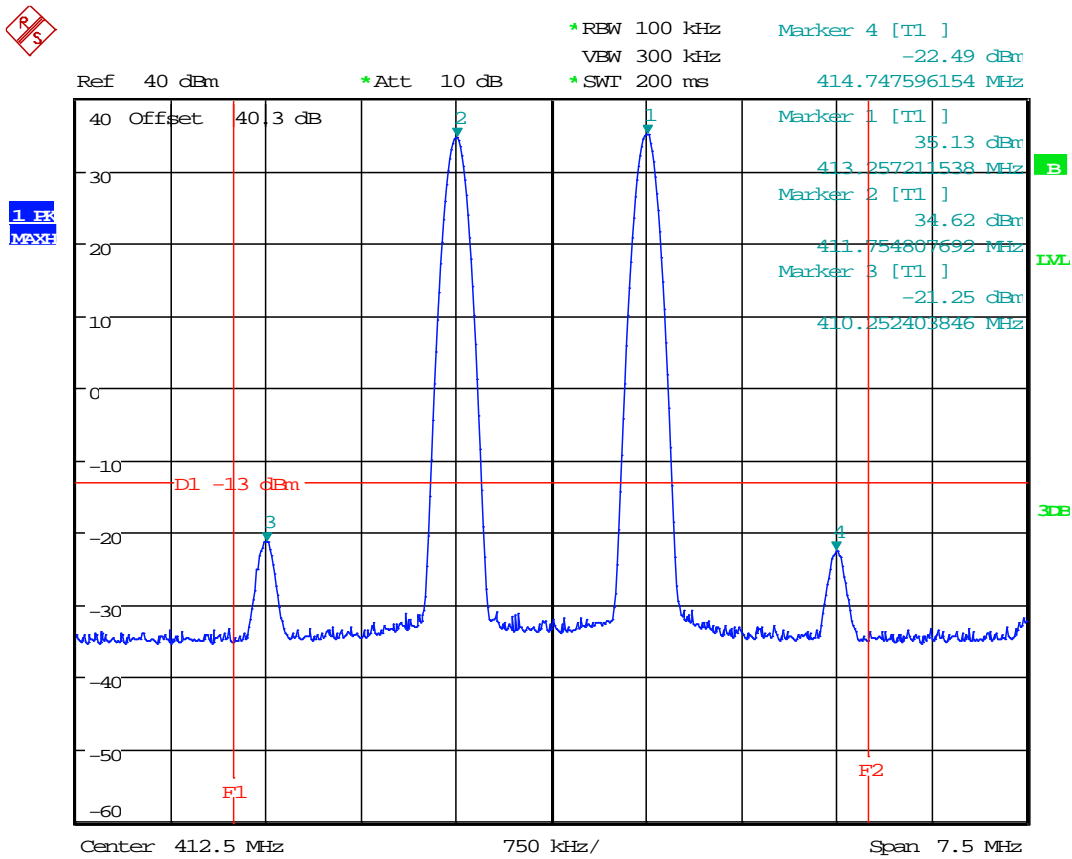

Date: 14.JAN.2004 09:39:24

RSS 131 Downlink Middle 5 MHz operating band Multi-channel @ AGC Threshold					
Signal	Frequency (MHz)	Level at Spectrum Analyser (dBm)	Network Loss (dB)	Output Power (dBm)	Result
P ₀₁	419.25	-3.84	40.3	36.46	Pass
P ₀₂	420.75	-3.91	40.3	36.39	Pass
P ₀₃	417.75	-71.3	40.3	-31.00	Pass
P ₀₄	422.25	-71.56	40.3	-31.26	Pass
$P_{mean} = P_{01} + 3dB$		39.46			PASS

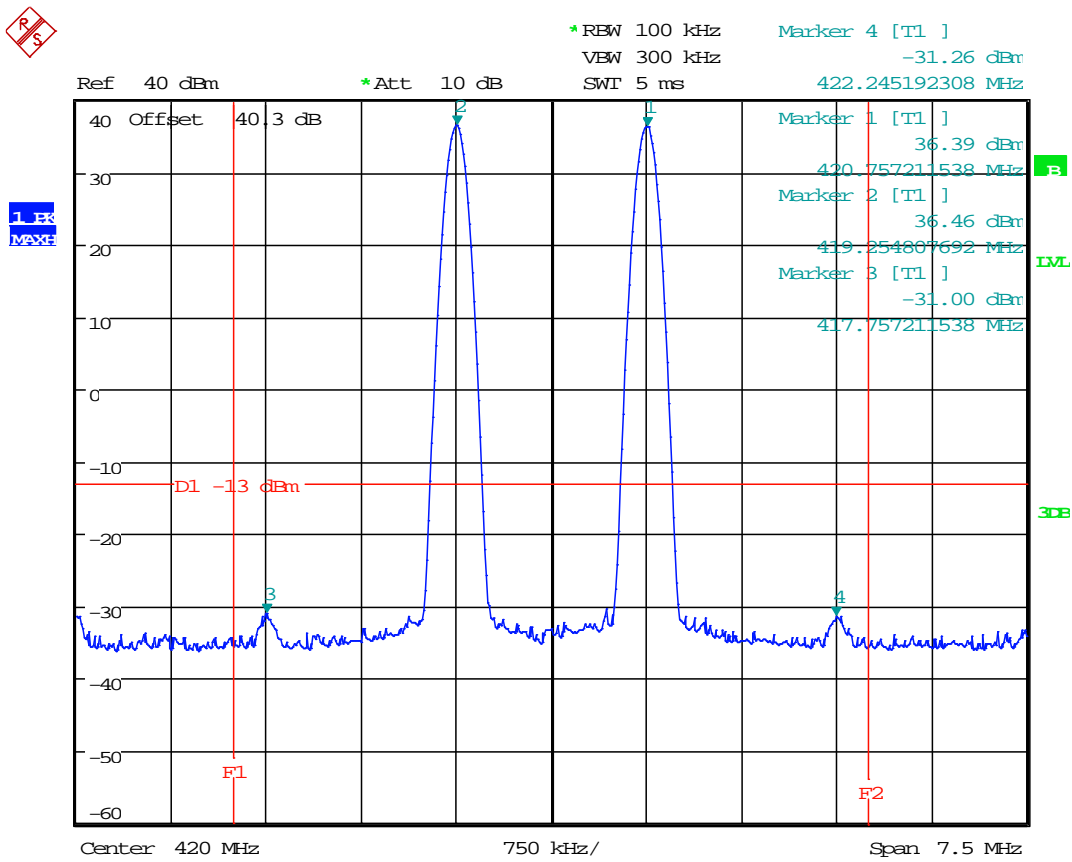

Date: 16.JAN.2004 09:43:31

RSS 131					
Downlink Highest 5 MHz operating band Multi-channel @ AGC Threshold					
Signal	Frequency (MHz)	Level at Spectrum Analyser (dBm)	Network Loss (dB)	Output Power (dBm)	Result
P ₀₁	426.75	-4.11	40.3	36.19	Pass
P ₀₂	420.25	-4.11	40.3	36.19	Pass
P ₀₃	429.75	-65.38	40.3	-25.08	Pass
P ₀₄	425.25	-65.23	40.3	-24.93	Pass
$P_{mean} = P_{01} + 3dB$		39.19			PASS

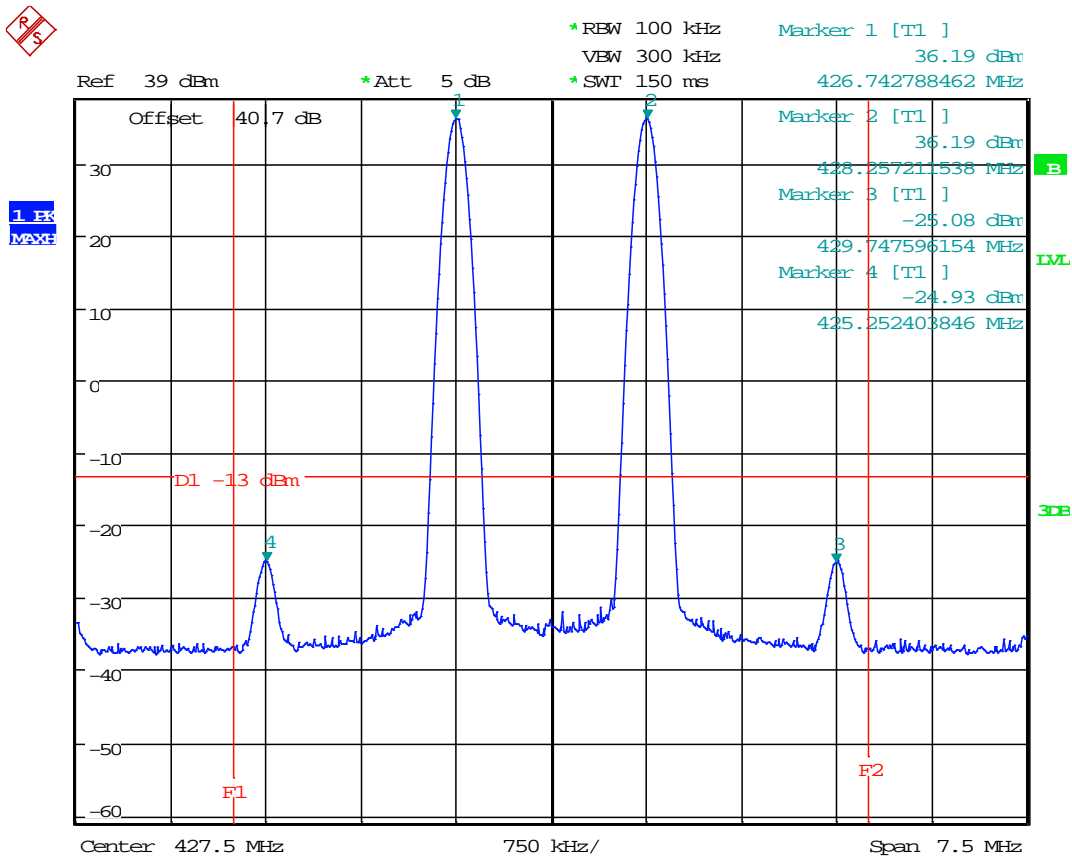

Date: 10.NOV.2015 12:58:21

RSS 131					
Uplink Lowest 5 MHz operating band Multi-channel @ AGC Threshold					
Signal	Frequency (MHz)	Level at Spectrum Analyser (dBm)	Network Loss (dB)	Output Power (dBm)	Result
P ₀₁	411.75	-6.14	40.3	34.16	Pass
P ₀₂	413.25	-6.15	40.3	34.15	Pass
P ₀₃	414.75	-62.56	40.3	-22.26	Pass
P ₀₄	410.25	-61.19	40.3	-20.89	Pass
$P_{mean} = P_{01} + 3dB$		37.16			PASS

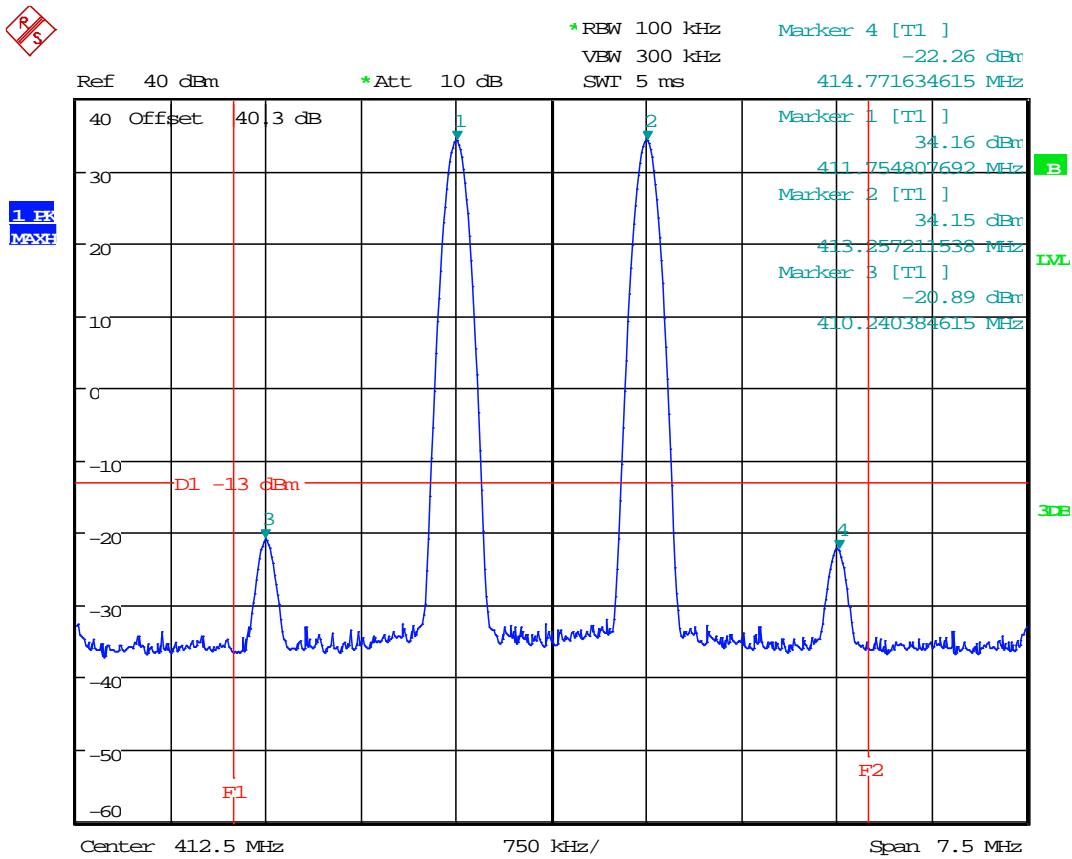

Date: 14.JAN.2004 14:43:32

RSS 131					
Uplink Middle 5 MHz operating band Multi-channel @ AGC Threshold					
Signal	Frequency (MHz)	Level at Spectrum Analyser (dBm)	Network Loss (dB)	Output Power (dBm)	Result
P ₀₁	420.75	-4.09	40.3	36.21	Pass
P ₀₂	419.25	-4.10	40.3	36.20	Pass
P ₀₃	417.75	-69.74	40.3	-29.44	Pass
P ₀₄	422.25	-73.59	40.3	-33.29	Pass
$P_{mean} = P_{01} + 3dB$		39.21			PASS

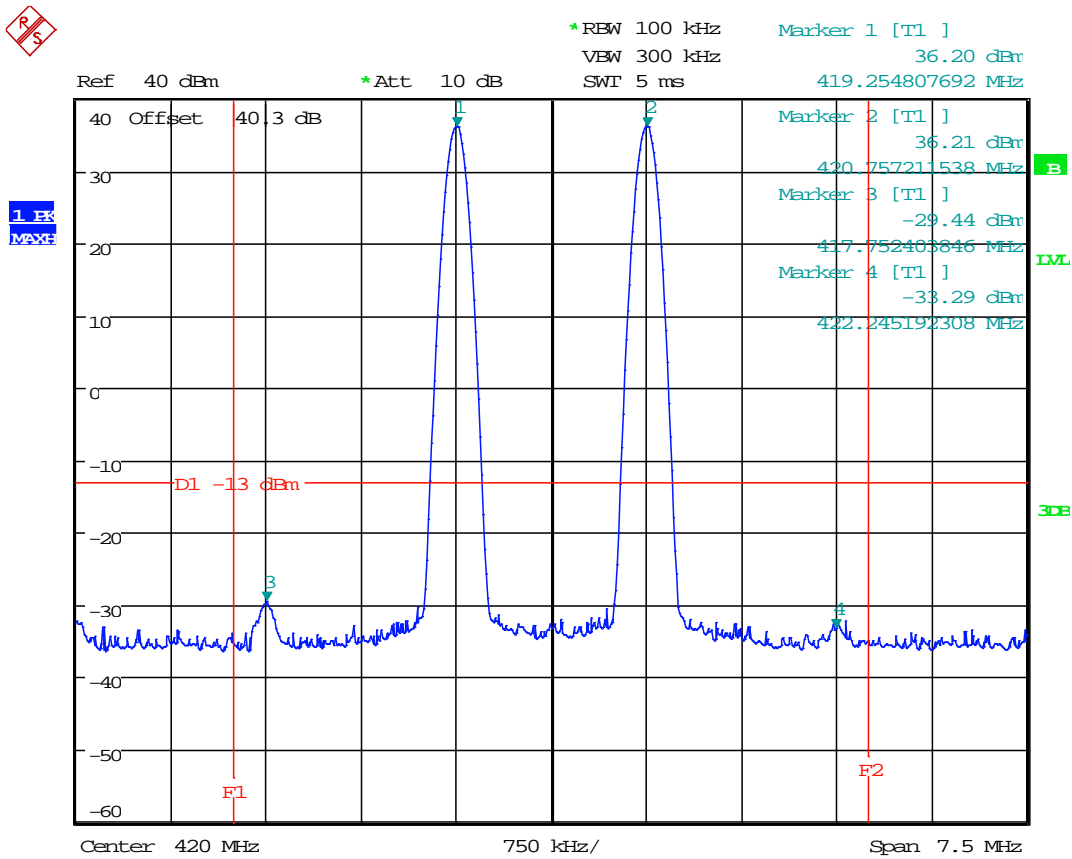

Date: 16.JAN.2004 09:48:44

RSS 131 Uplink Highest 5 MHz operating band Multi-channel @ AGC Threshold					
Signal	Frequency (MHz)	Level at Spectrum Analyser (dBm)	Network Loss (dB)	Output Power (dBm)	Result
P ₀₁	428.25	-4.09	40.3	36.21	Pass
P ₀₂	426.75	-4.20	40.3	36.10	Pass
P ₀₃	425.25	-75.7	40.3	-35.40	Pass
P ₀₄	429.75	-77.27	40.3	-36.97	Pass

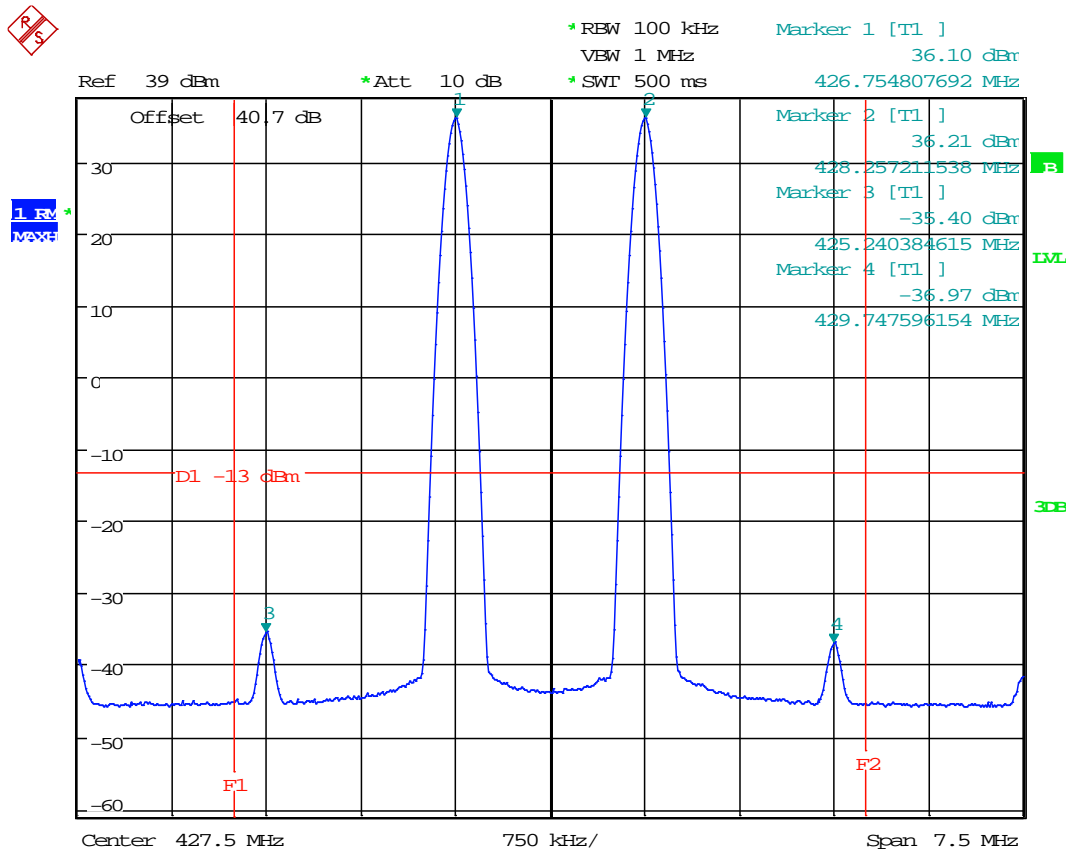

Date: 11.NOV.2015 14:50:27

12 Noise figure

12.1 Definition

A measure of the noise generated within (or degradation in signal/noise ratio as a signal passes through) the device expressed as the ratio of signal/noise power ratio at the input to signal/noise ratio at the output.

12.2 Test Parameters

Test Location:	Element Skelmersdale
Test Chamber:	Radio Lab
Test Standard and Clause:	Y-Factor Method (Keysight Technologies Application Note 57-2) KDB 935210 D05 v01, clause 4.6
Deviations From Standard:	None
Bandwidth:	RBW 300 kHz

Environmental Conditions (Normal Environment)

Temperature: 22°C	+15 °C to +35 °C (as declared)
Humidity: 44%RH	20%RH to 75%RH (as declared)
Supply: 110 V ac	110Vac +/-10% (as declared)

12.3 Test Limits – Noise Figure

The noise figure of a signal booster must not exceed 9 dB in either direction.

12.4 Test Method

The equipment was setup as shown in Figure iii. A spectrum analyser with a noise figure measurement capability was used. The spectrum analyser provided the on/off control of the noise source as well as measuring the result at its RF input. Prior to measuring the EUT, a calibration of the measurement network was performed with the EUT removed.

Figure iii Test Setup

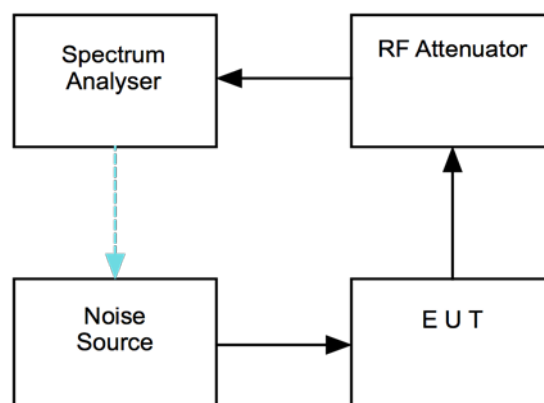

12.5 Test Equipment

Equipment Description	Manufacturer	Equipment Type	Element No	Last Cal Calibration	Calibration Period	Due For Calibration
Spectrum Analyser	R&S	FSU46	U281	24/04/2015	12	24/04/2016
Signal Generator	R&S	SMBV100A	REF916	17/02/2015	12	17/02/2016
Signal Generator	Agilent	ESG-D3000A	RFG441	08/10/2014	24	08/10/2016
Noise Source serial # MY53231895	Agilent	346A	N/A	07/10/15	12	07/10/16
Spectrum / Noise Analyser serial #MY49432183	Agilent	PXA	N/A	07/10/15	12	07/10/16

12.6 Test Results

Uplink Noise Figure		
Channel Centre Frequency (MHz)	Noise Figure (dB)	Result
410.0125	6.8813	PASS
429.9875	7.0312	PASS

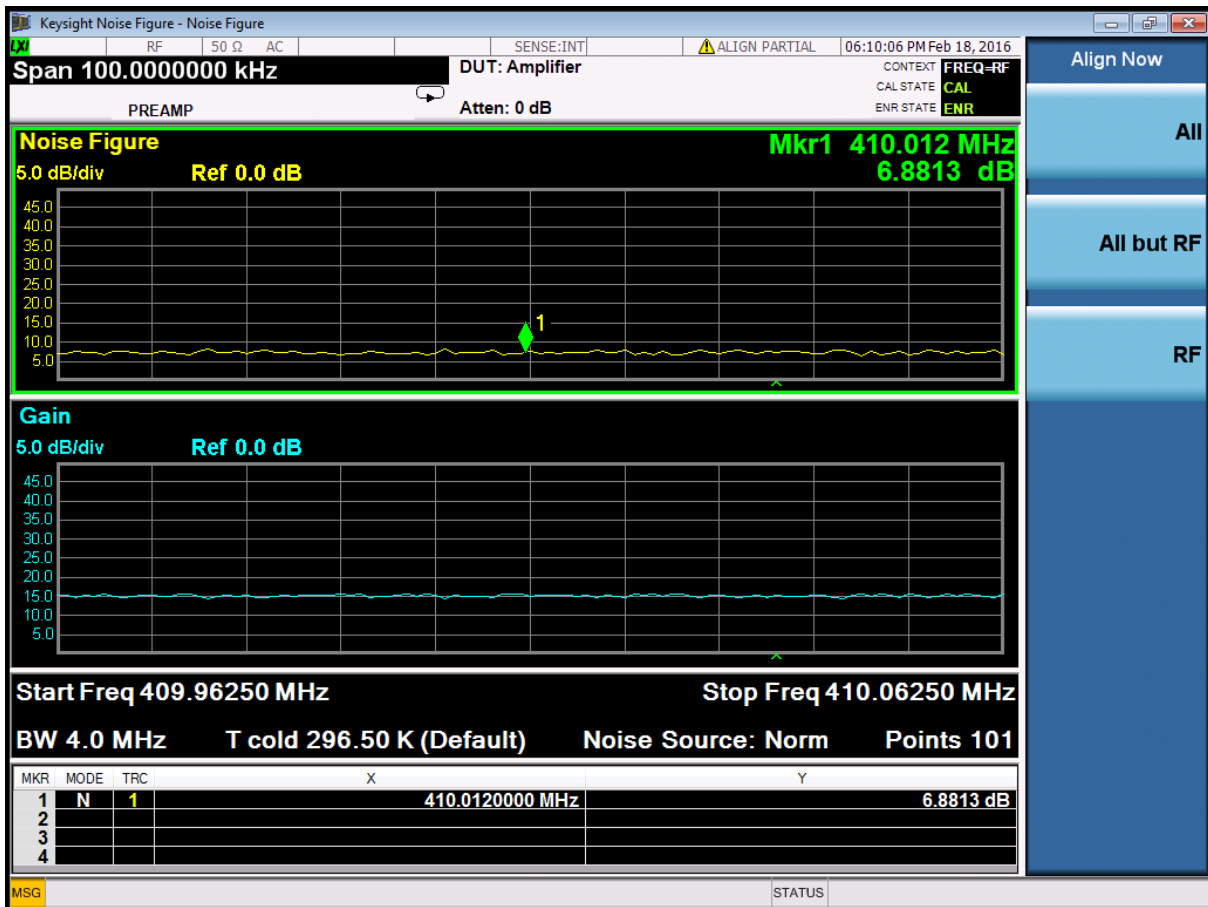

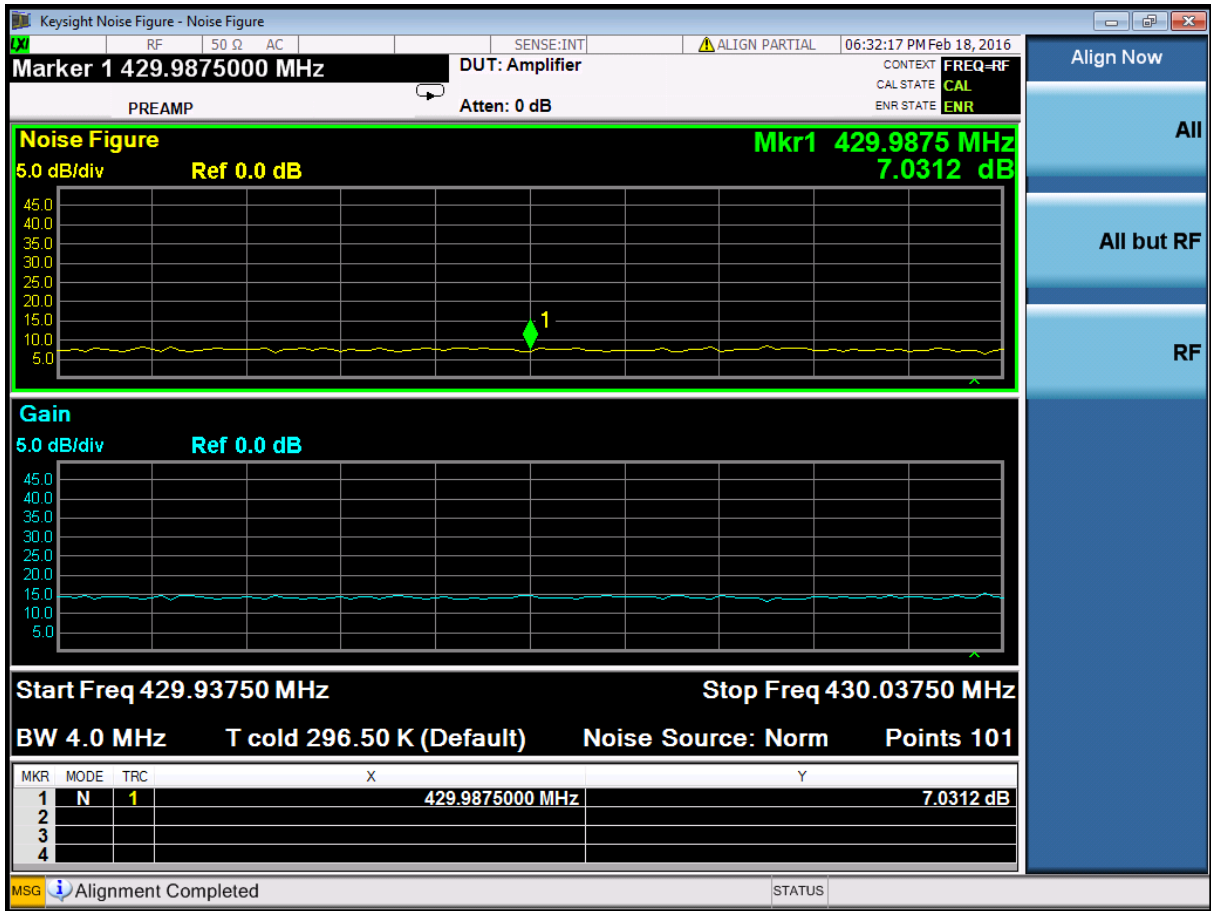

Downlink Noise Figure		
Channel Centre Frequency (MHz)	Noise Figure (dB)	Result
410.0125	4.6359	PASS
429.9875	5.4121	PASS

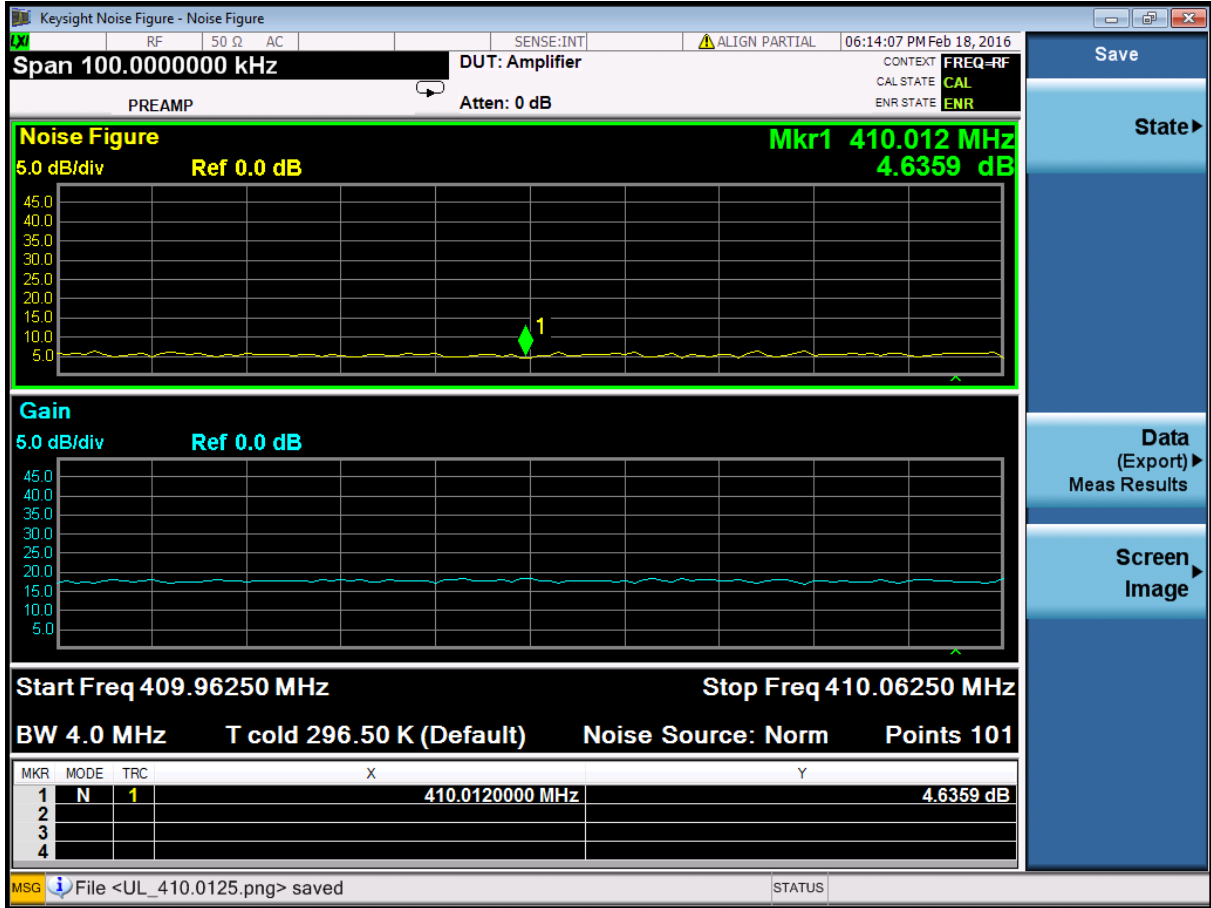

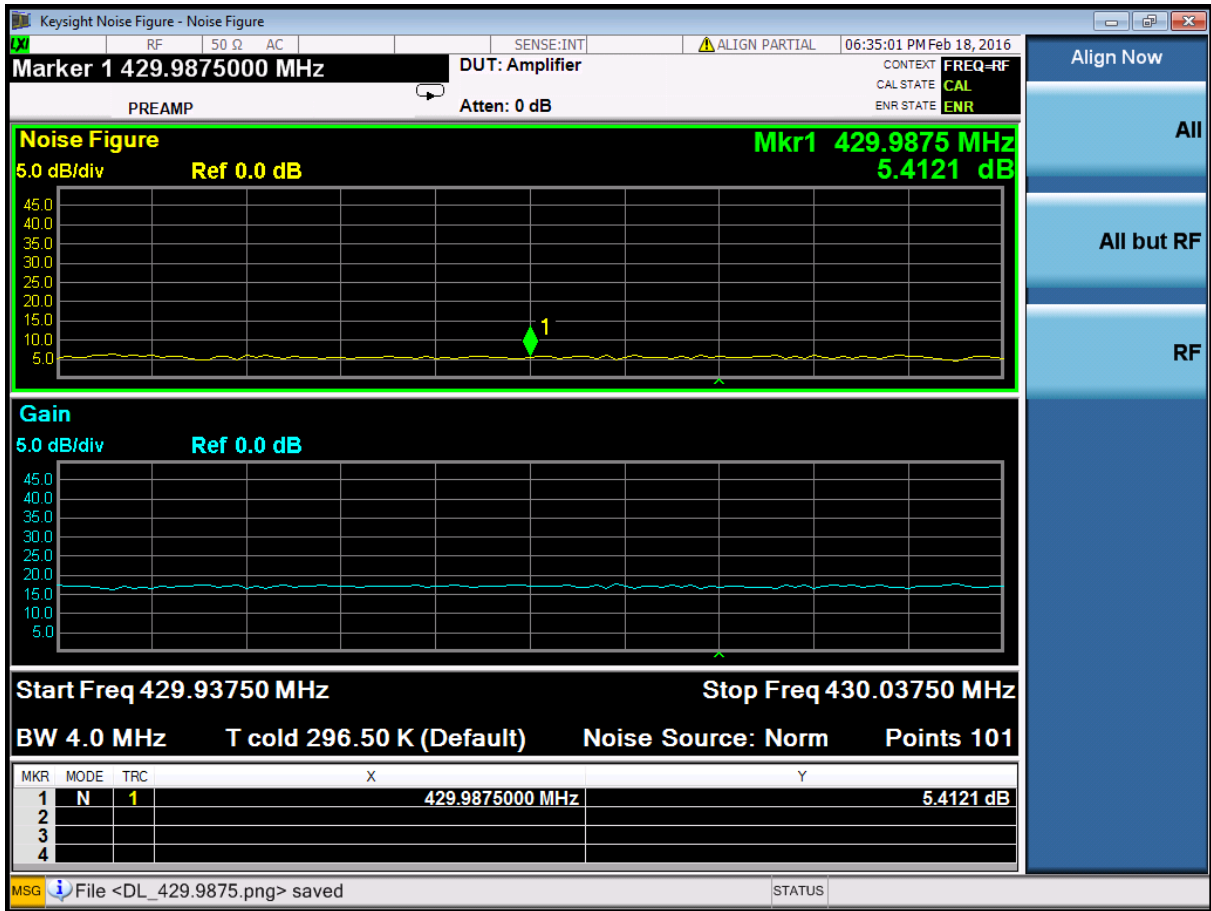

12.7 Test Limits – Noise at Antenna Terminals

Compliance with these levels will be deemed satisfaction of the good engineering practice requirement. In a 10 kHz measurement bandwidth:

- (1) the ERP of noise within the signal booster passband should not exceed -43dBm ;
- and
- (2) the ERP of noise on spectrum more than 1 MHz outside of the signal booster passband should not exceed -70 dBm .

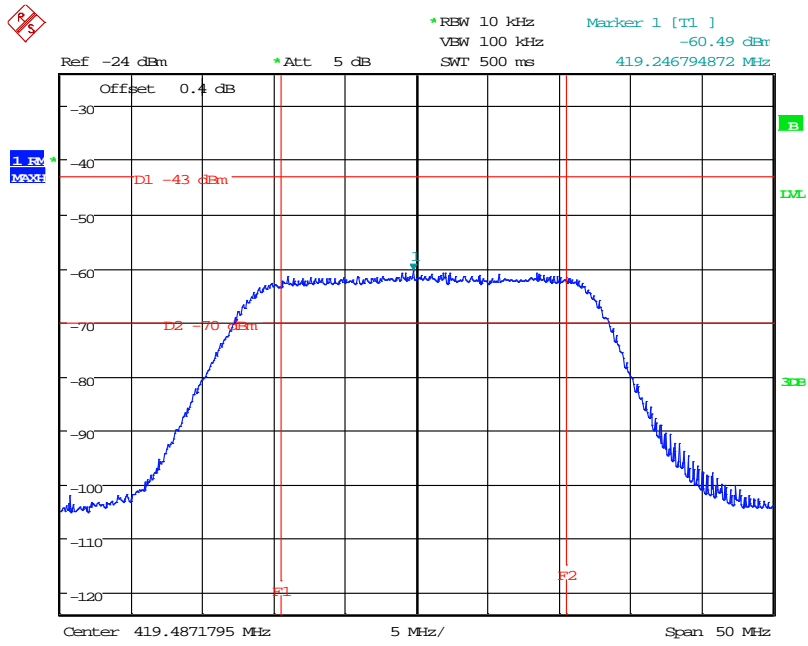

Date: 9.NOV.2015 14:36:21

DOWNLINK - IN BAND AMPLIFIER NOISE

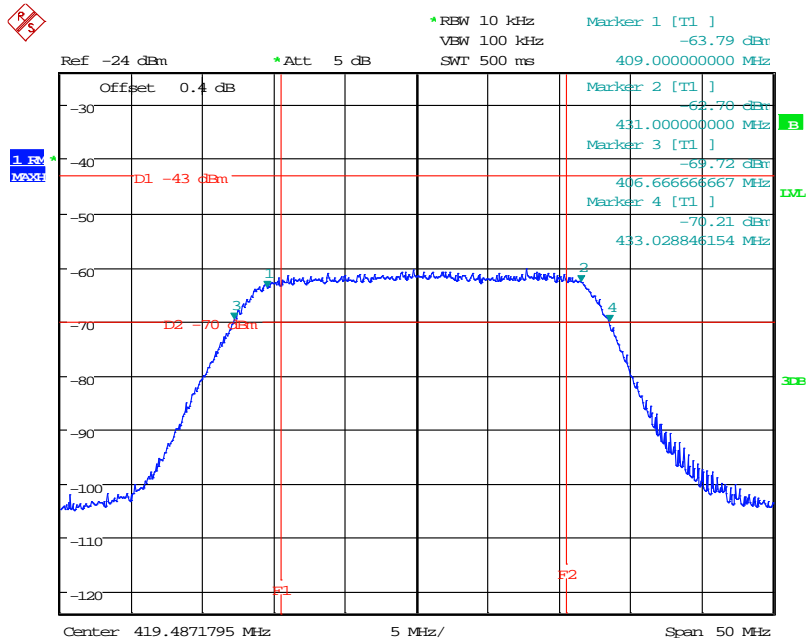

Date: 9.NOV.2015 14:38:29

DOWNLINK - NOISE 1MHz FROM PASSBAND

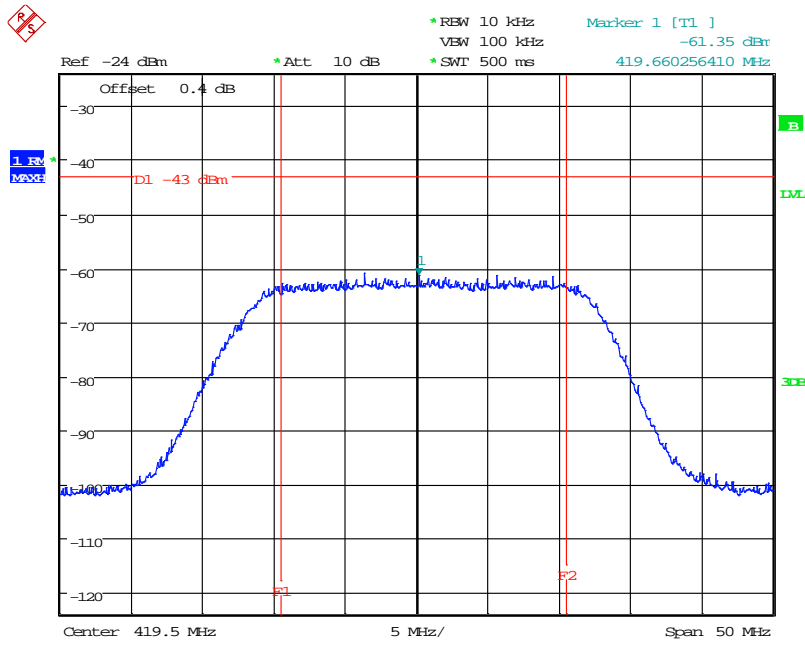

Date: 11.NOV.2015 14:33:52

UPLINK - IN BAND AMPLIFIER NOISE

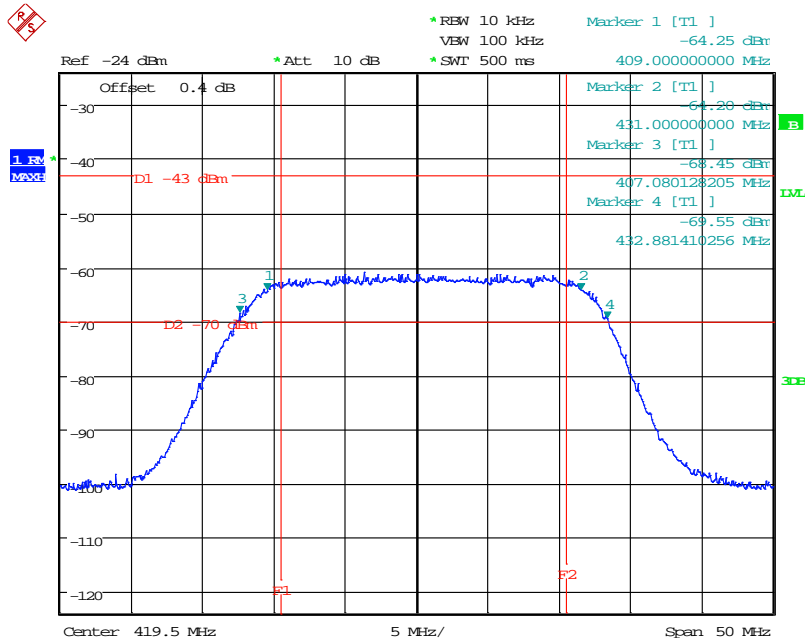

Date: 11.NOV.2015 14:36:29

UPLINK - NOISE 1MHz FROM PASSBAND

13 Retransmitted masks

13.1 Definition

The emission mask is the required attenuation relative to the channel power up to 250% of the channel bandwidth. For frequencies greater than 250% of the authorized bandwidth, refer to spurious emission measurement.

13.2 Test Parameters

Test Location:	Element Skelmersdale
Test Chamber:	Radio Lab
Test Standard and Clause:	IC RSS-131, clause 4.3.2 KDB 935210 D05 v01, clause 4.4
EUT Operating Frequencies Tested:	412.5 MHz 420MHz, 427.5MHz
Source Modulations:	16K0F3E, 11K3F3E, 4K00F1E
Source Levels:	-46.2, -46.8 dBm (AGC threshold and 3dB above)
Deviations From Standard:	None
Bandwidth, RBW:	Various, see plots. VBW =3xRBW
Span:	80 kHz (2-5 times OBW)
Measurement Detector	Peak; Max-Hold.

Environmental Conditions (Normal Environment)

Temperature: 22°C	+15 °C to +35 °C (as declared)
Humidity: 43%RH	20%RH to 75%RH (as declared)
Supply: 110 V ac	110Vac +/-10% (as declared)

13.3 Test Limits

13.3.1 FCC 47CFR90

- (i) There is no change in the occupied bandwidth of the retransmitted signals.
- (ii) The retransmitted signals continue to meet the unwanted emissions limits of §90.210 applicable to the corresponding received signals (assuming that these received signals meet the applicable unwanted emissions limits by a reasonable margin).

Table 5: Emission Mask C

<i>Displacement Frequency, f (kHz)</i>	<i>Minimum Attenuation (dB)</i>
10 < f ≤ 10	83 log (fd÷5)
10 < f ≤ 250% Authorised BW	29 log (fd ² ÷11) or 50*
f > 250% Authorised BW	43 + log ₁₀ (P)

*Whichever is the lesser

Table 5: Emission Mask D

<i>Displacement Frequency, f (kHz)</i>	<i>Minimum Attenuation (dB)</i>
F ₀ to 5.625 removed from F ₀	0
>5.625≤12.5	7.27(fd-2.88)
>12.5	At least 50+10log (P) or 70dB*

Mask for equipment without audio low pass filter

Where P is the transmitter output power in dBW.

13.3.2

13.3.3 IC RSS-131

For a single channel amplifier, the 99% emission bandwidth shall be measured under the conditions described in section 4.3.2 and the spectrum analyser plots submitted in the test report. Set the resolution bandwidth of the spectrum analyser from 1% to 3% of the 99% emission bandwidth and set the video bandwidth to 3 times the resolution bandwidth. Record both the amplifier input and output signals.

All emissions in the amplifier's output signal that falls outside a licensed frequency block or allocated bandwidth for the technology under test must be attenuated, relative to P, by at least:

$$43 + 10 \text{ Log}_{10}P, \text{ or } 70 \text{ dB, whichever is less stringent}$$

where P is the manufacturer's rated output power in watts.

13.4 Test Method

With the EUT setup as per section 9 of this report and connected as per Figure iv, the RF spectrum mask was measured on a spectrum analyser and compared to the signal generator output as shown on the plots.

The measurements were performed with EUT set at its nominal / maximum gain.

Figure iv Test Setup

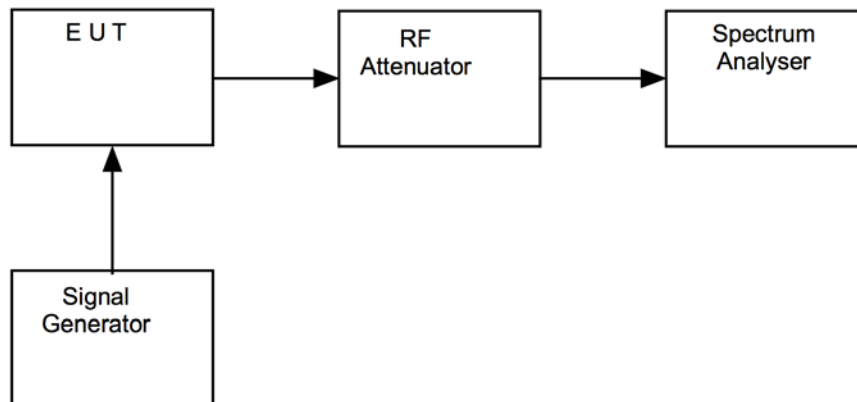

13.5 Test Equipment

<i>Equipment Description</i>	<i>Manufacturer</i>	<i>Equipment Type</i>	<i>Element No</i>	<i>Last Cal Calibration</i>	<i>Calibration Period</i>	<i>Due For Calibration</i>
Spectrum Analyser	R&S	FSU46	U281	24/04/2015	12	24/04/2016
Signal Generator	R&S	SMBV100A	REF916	17/02/2015	12	17/02/2016
Signal Generator	Agilent	ESG-D3000A	RFG441	08/10/2014	24	08/10/2016

13.6 Test Results

Downlink Emission Masks @ AGC Threshold				
Channel Centre Frequency (MHz)	Modulation Type			Result
	16K0F3E	11K3F3E	4K00F1E	
412.500	Compliant	Compliant	-	PASS
420.000	Compliant	Compliant	-	PASS
427.500	Compliant	Compliant	-	

16K0F3E

412.5 MHz

11K3F3E

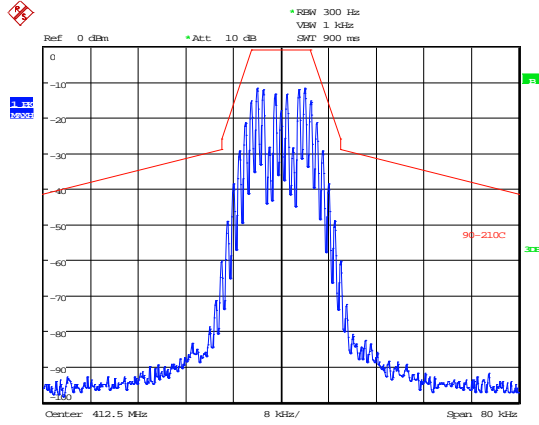

Date: 14.JAN.2004 07:39:43

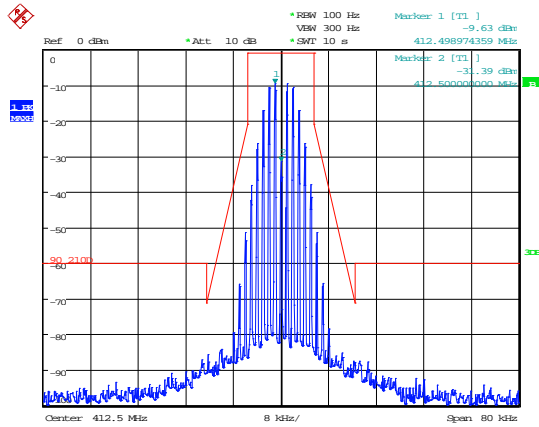

Date: 14.JAN.2004 08:00:46

Input Signal

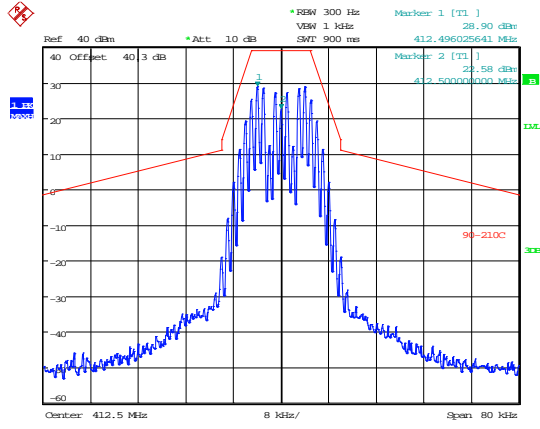

Date: 14.JAN.2004 07:47:52

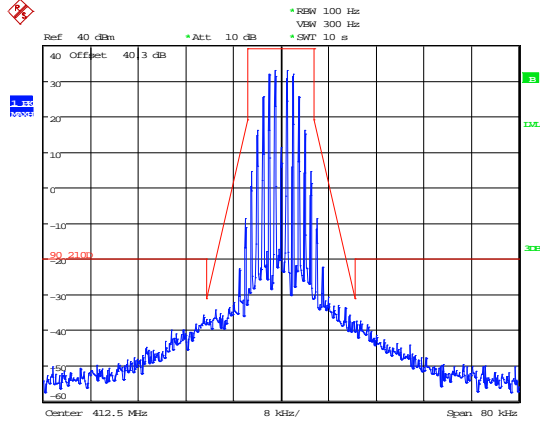

Date: 14.JAN.2004 07:03:23

AGC

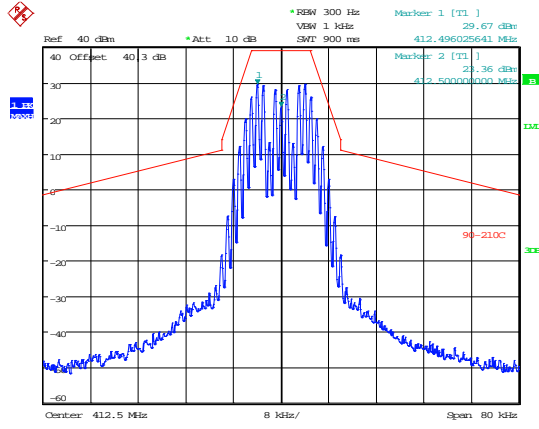

Date: 14.JAN.2004 07:48:47

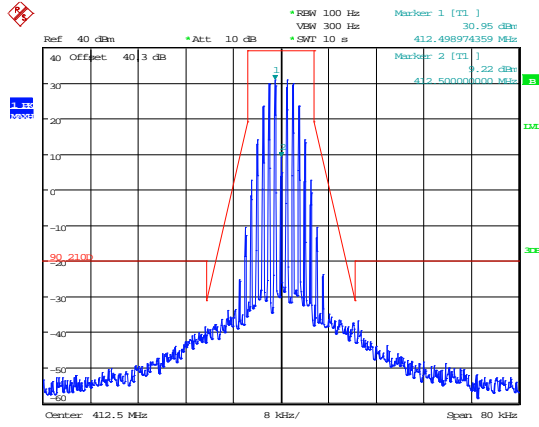

Date: 14.JAN.2004 07:53:57

AGC +3dB

16K0F3E

420 MHz

11K3F3E

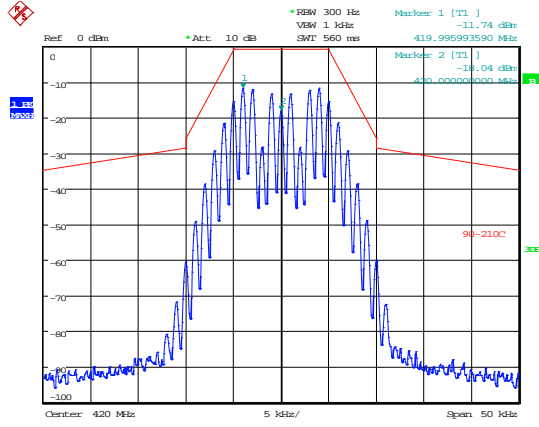

Date: 16.JAN.2004 09:02:06

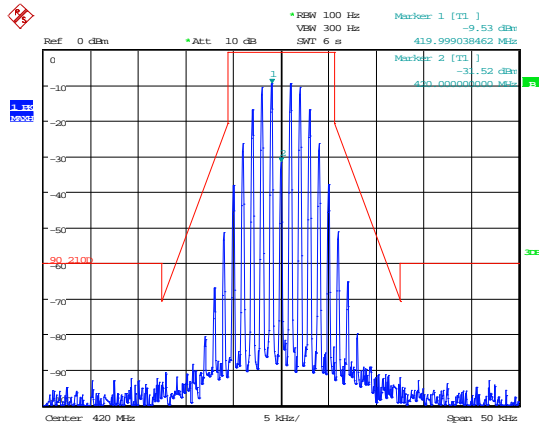

Date: 16.JAN.2004 09:03:26

Input Signal

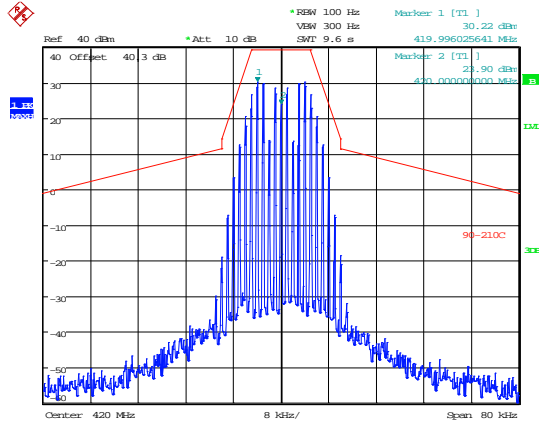

Date: 16.JAN.2004 08:43:57

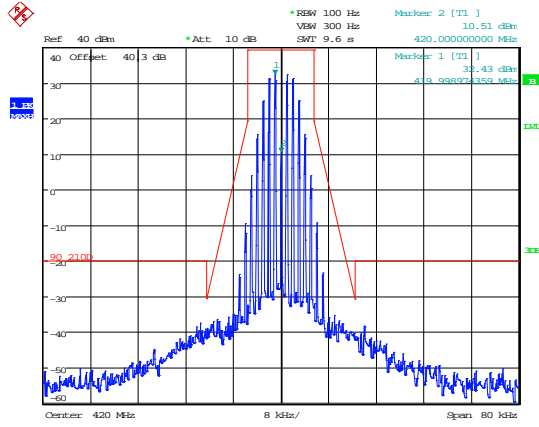

Date: 16.JAN.2004 08:42:15

AGC

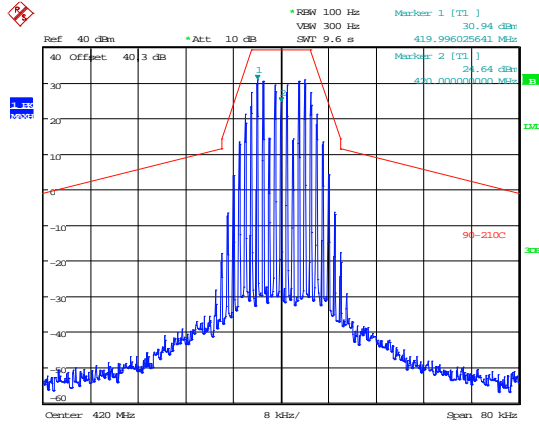

Date: 16.JAN.2004 08:45:04

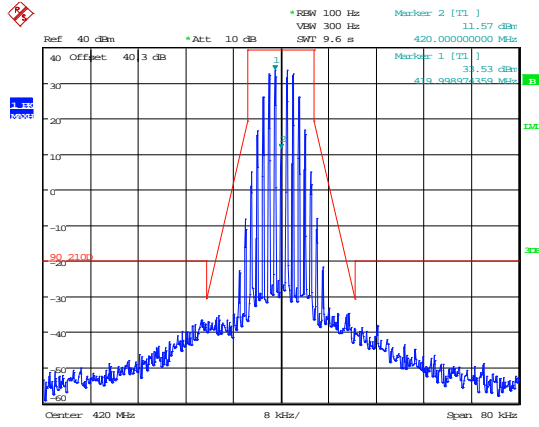

Date: 16.JAN.2004 08:41:21

AGC +3dB

16K0F3E

427.5 MHz

11K3F3E

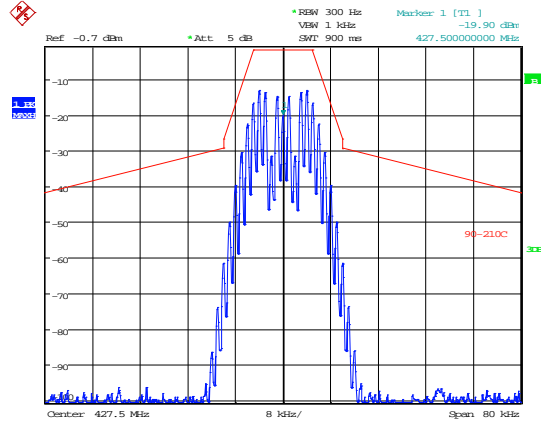

Date: 9.NOV.2015 11:07:26

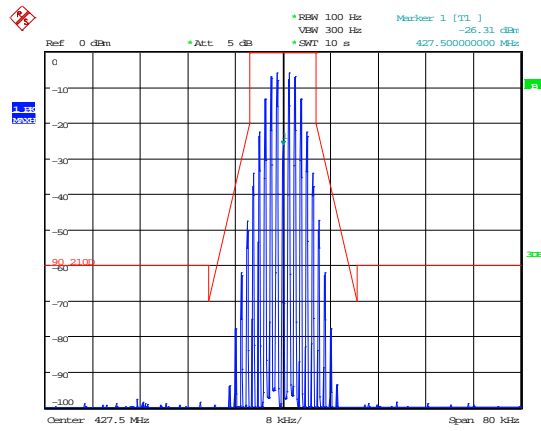

Date: 9.NOV.2015 11:29:01

Input Signal

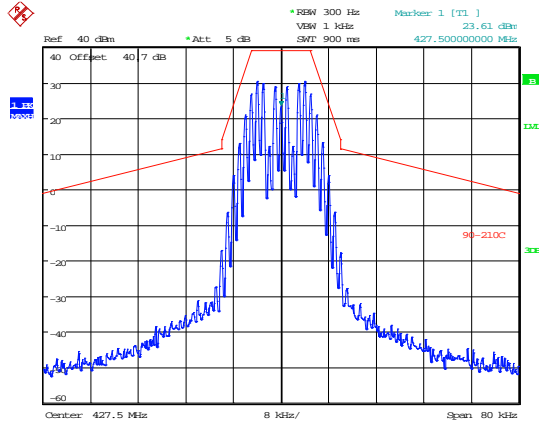

Date: 9.NOV.2015 11:03:45

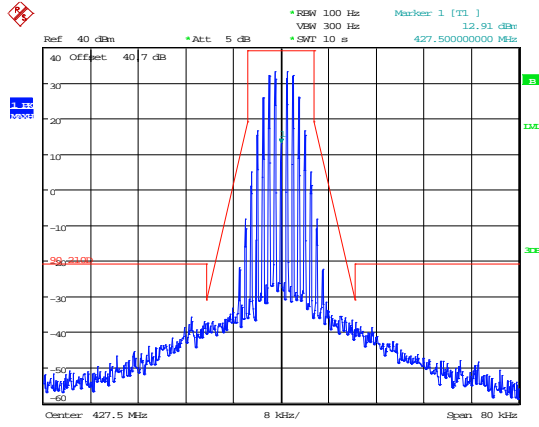

Date: 9.NOV.2015 11:14:12

AGC

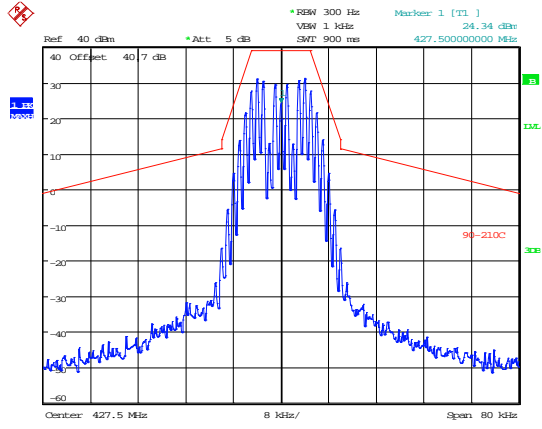

Date: 9.NOV.2015 11:04:13

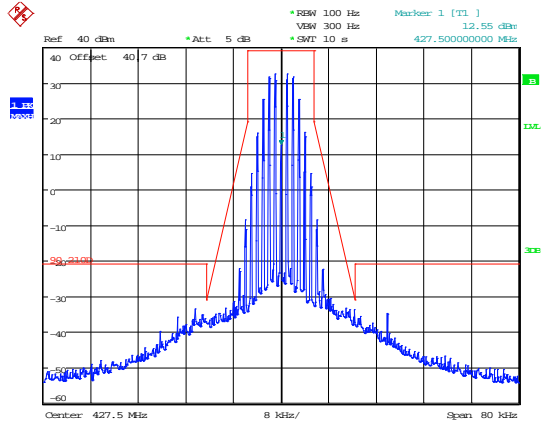

Date: 9.NOV.2015 11:25:21

AGC +3dB

The above plots depicting the output spectra show no obvious distortion visible when compared to the input signal.

<i>Uplink Emission Masks @ AGC Threshold</i>				
<i>Channel Centre Frequency (MHz)</i>	<i>Modulation Type</i>			<i>Result</i>
	<i>16K0F3E</i>	<i>11K3F3E</i>	<i>4K00F1E</i>	
412.500	Compliant	Compliant	-	PASS
420.000	Compliant	Compliant	-	PASS
427.500	Compliant	Compliant	-	

16K0F3E

412.5 MHz

11K3F3E

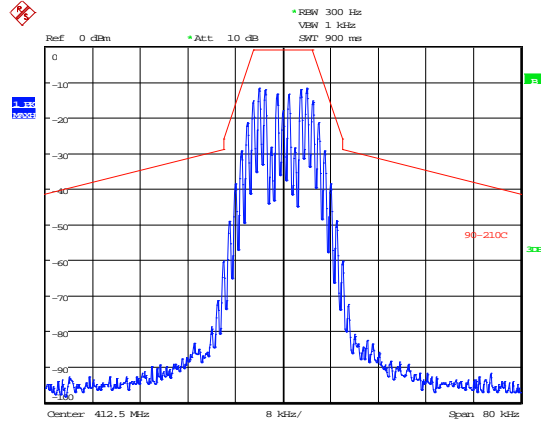

Date: 14.JAN.2004 07:39:43

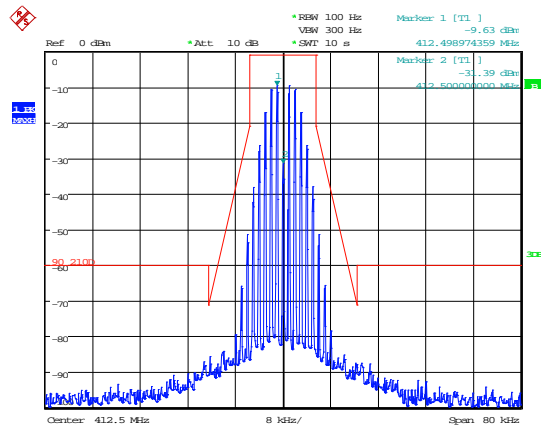

Date: 14.JAN.2004 08:00:46

Input Signal

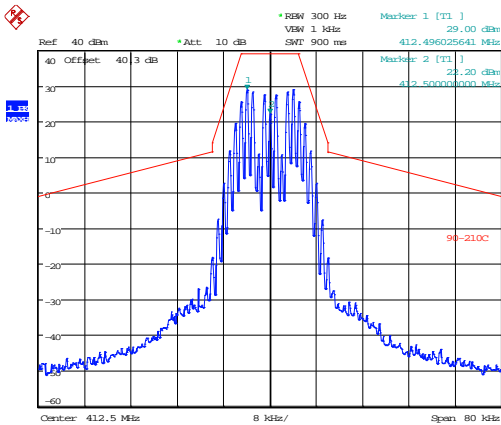

Date: 14.JAN.2004 13:56:08

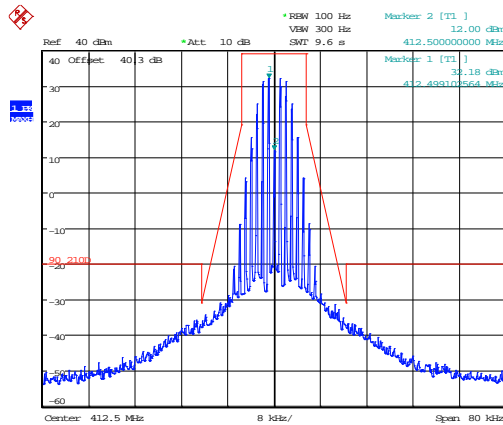

Date: 14.JAN.2004 13:47:52

AGC

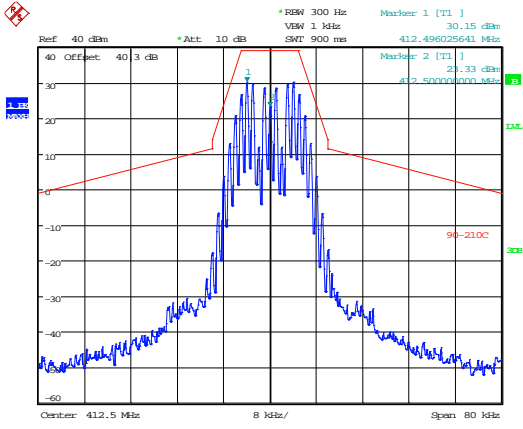

Date: 14.JAN.2004 13:54:22

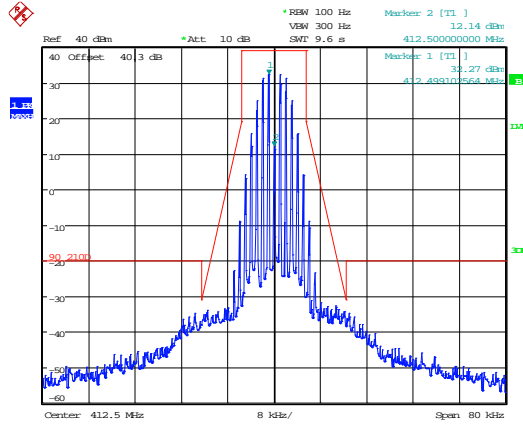

Date: 14.JAN.2004 13:52:21

AGC +3dB

16K0F3E

420 MHz

11K3F3E

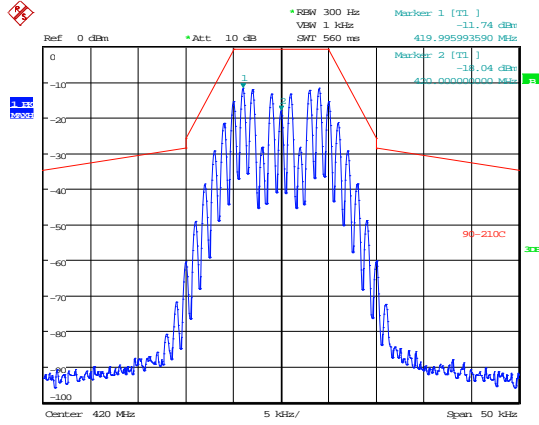

Date: 16.JAN.2004 09:02:06

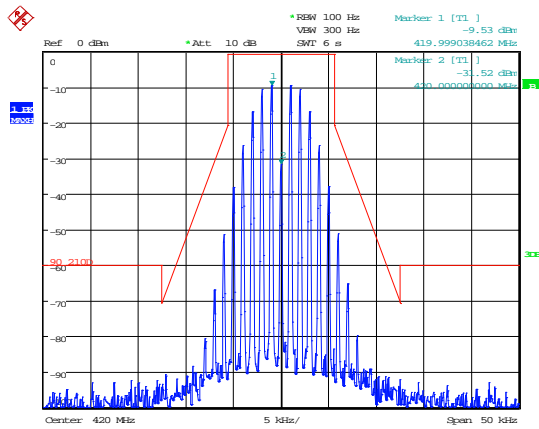

Date: 16.JAN.2004 09:03:26

Input Signal

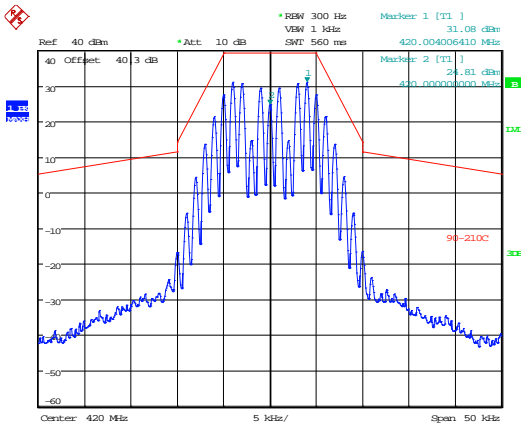

Date: 16.JAN.2004 08:53:46

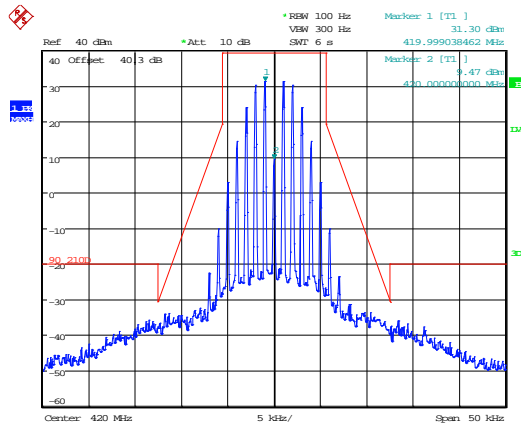

Date: 16.JAN.2004 08:59:11

AGC

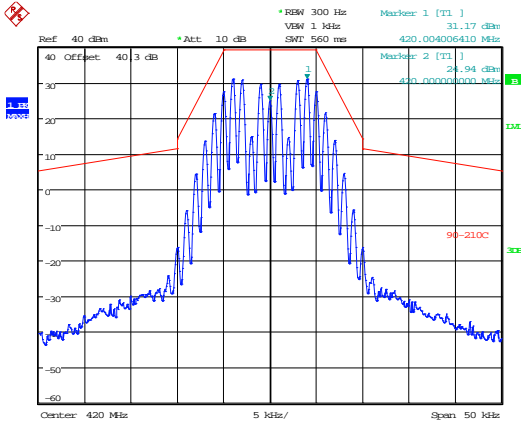

Date: 16.JAN.2004 08:54:47

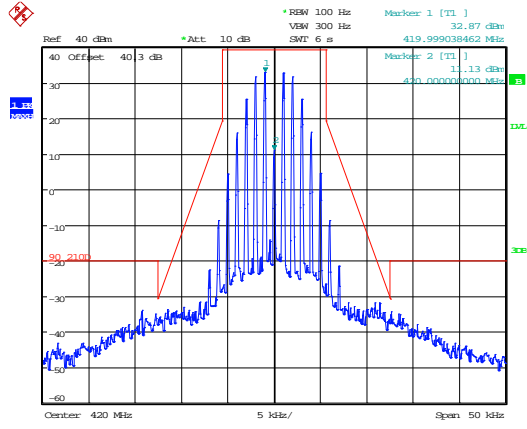

Date: 16.JAN.2004 08:56:00

AGC +3dB

16K0F3E

427.5 MHz

11K3F3E

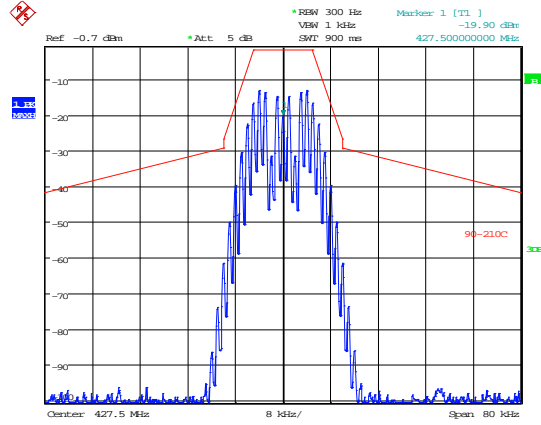

Date: 9.NOV.2015 11:07:26

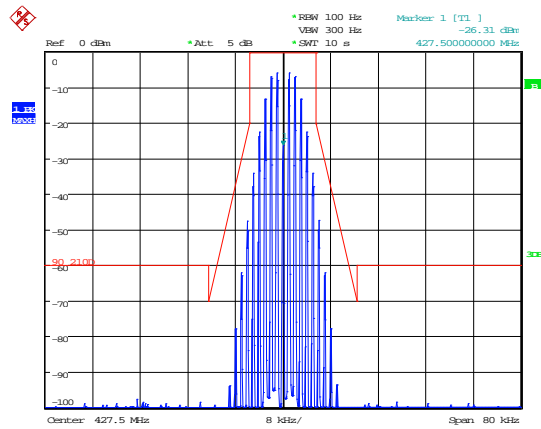

Date: 9.NOV.2015 11:29:01

Input Signal

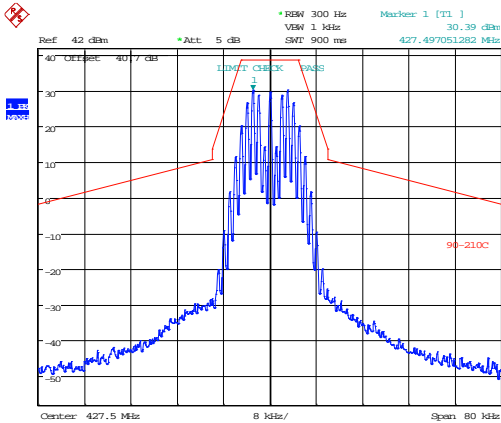

Date: 10.NOV.2015 17:00:06

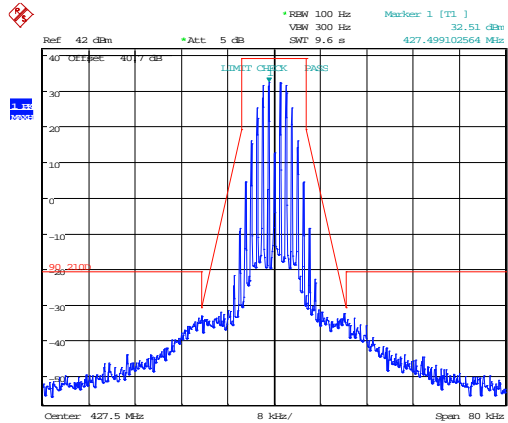

Date: 10.NOV.2015 17:16:42

AGC

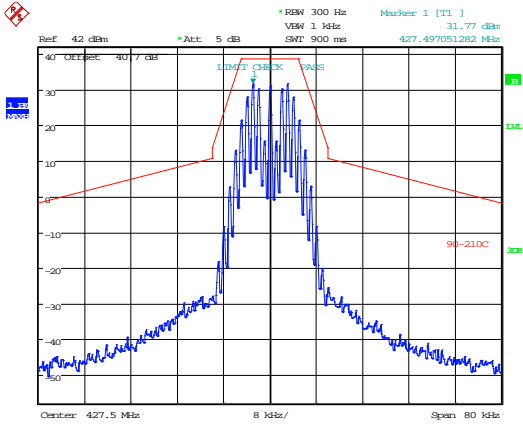

Date: 10.NOV.2015 17:00:44

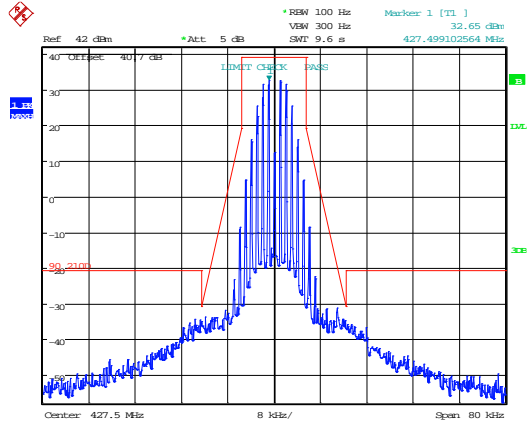

Date: 10.NOV.2015 17:18:08

AGC +3dB

14 Passband gain and bandwidth

14.1 Definition

The passband is the range of frequencies over which the booster is intended to apply gain. Each booster may include one or more passbands. The bandwidth of each passband is defined by two points either side of the band where the gain has fallen by 20dB from maximum.

14.2 Test Parameters

Test Location:	Element Skelmersdale
Test Chamber:	Radio Lab
Test Standard and Clause:	IC RSS-131, Clause 4.2 KDB 935210 D05 v01 , Clause 4.3
Channels / Frequencies Measured:	+/-250% declared pass band
Source Modulation:	CW
Source Level:	3dB below the AGC threshold
Sweep Set-Up:	500 Hz steps; 2s dwell / 50kHz steps; 90ms dwell
Deviations From Standard:	None
Bandwidth:	RBW 1kHz / 50 kHz (1-5% pass band); (VBW \geq 3xRBW).
Measurement Detector	Peak; Max-Hold.

Environmental Conditions (Normal Environment)

Temperature: 22°C	+15 °C to +35 °C (as declared)
Humidity: 38%RH	20%RH to 75%RH (as declared)
Supply: 110 V ac	110Vac +/-10% (as declared)

14.3 Test Limits

14.3.1 FCC 47CFR90.

Not specified.

14.3.2 RSS-131.

The passband gain shall not exceed the nominal gain by more than 1.0 dB. The 20 dB bandwidth shall not exceed the nominal bandwidth that is stated by the manufacturer. Outside of the 20 dB bandwidth, the gain shall not exceed the gain at the 20 dB point.

14.4 Test Method

With the EUT setup as per section 9 of this report and connected as per Figure v, the 20dB bandwidth of the EUT was measured on a spectrum analyser.

The measurements were performed with EUT set at its nominal / maximum gain.

Figure v Test Setup

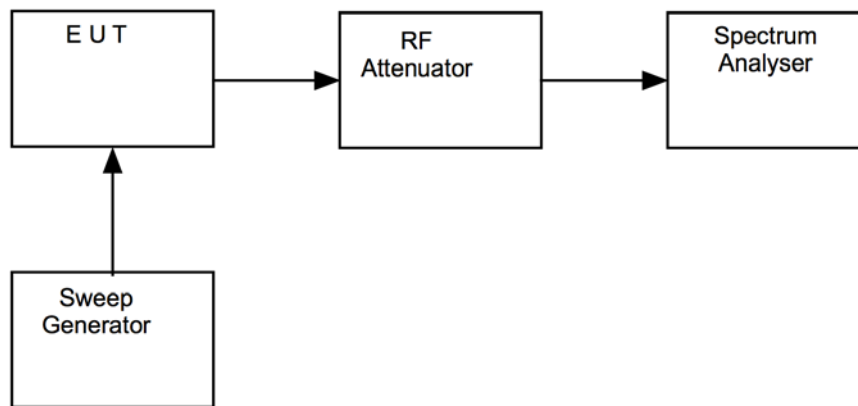

14.5 Test Equipment

<i>Equipment Description</i>	<i>Manufacturer</i>	<i>Equipment Type</i>	<i>Element No</i>	<i>Last Cal Calibration</i>	<i>Calibration Period</i>	<i>Due For Calibration</i>
Spectrum Analyser	R&S	FSU46	U281	24/04/2015	12	24/04/2016
Signal Generator	R&S	SMBV100A	REF916	17/02/2015	12	17/02/2016

14.6 Test Results

Downlink - Lower 5 MHz operating band – Centre Frequency 412.5 MHz				
Active Channel(s) (MHz)	Lower Mkr Frequency (MHz)	Upper Mkr Frequency (MHz)	20dB Bandwidth (kHz)	Result
412.5 MHz	412.46955	412.52724	57.69	PASS
410.0125 MHz/ 414.9875 MHz	409.93250	415.06750	5135.00	PASS

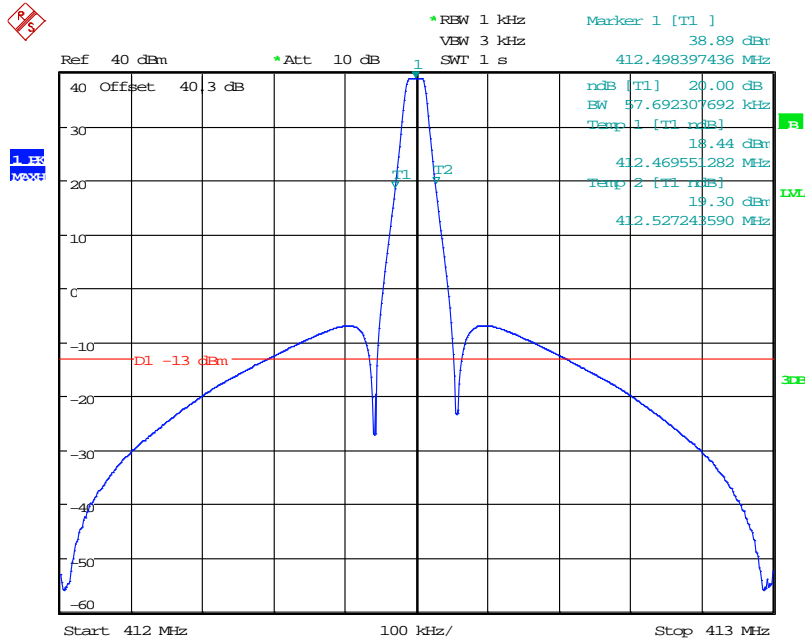

Date: 14.JAN.2004 11:56:59

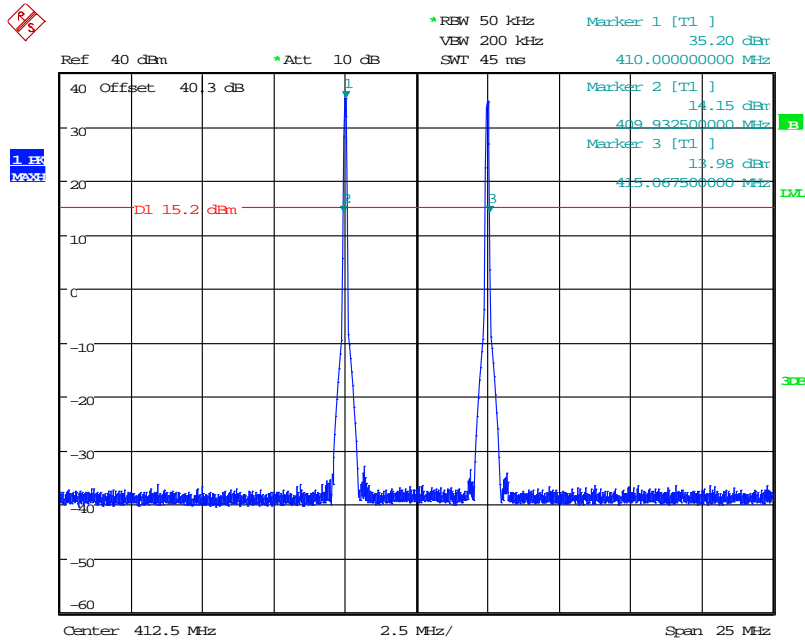

Date: 14.JAN.2004 12:16:25

Downlink - Middle 5 MHz operating band – Centre Frequency 420.0 MHz				
Active Channel(s) (MHz)	Lower Mkr Frequency (MHz)	Upper Mkr Frequency (MHz)	20dB Bandwidth (kHz)	Result
420.0	419.96795	420.03045	62.5	PASS
417.5125 MHz / 424.49875	417.43250	422.56500	5132.50	PASS

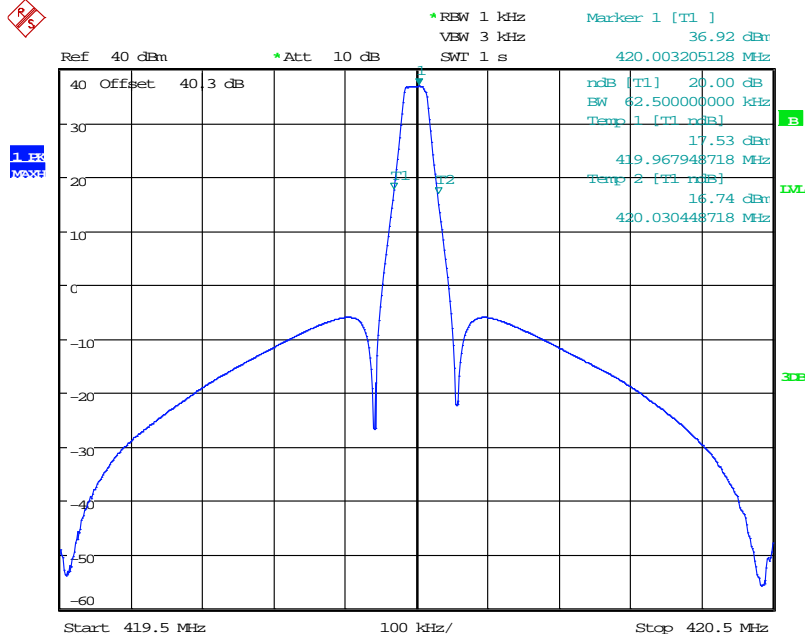

Date: 16.JAN.2004 12:46:04

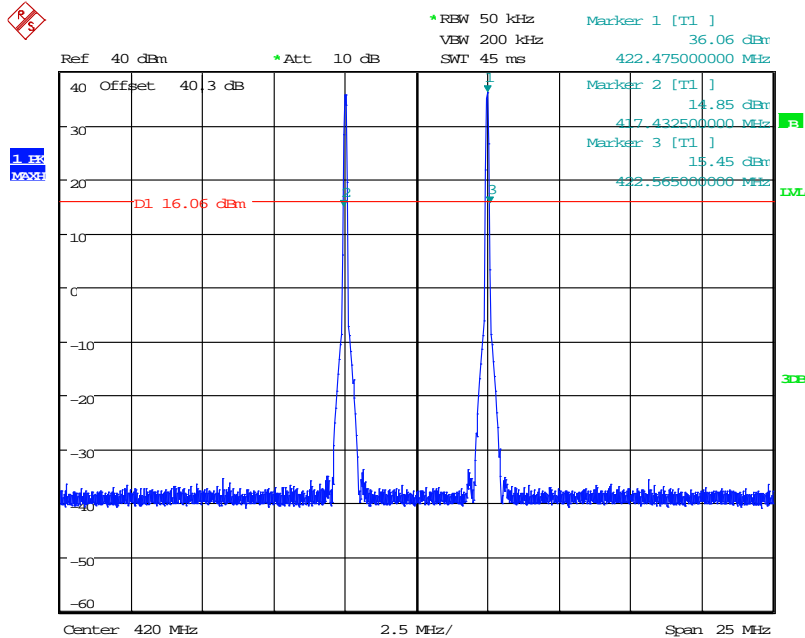

Date: 16.JAN.2004 11:20:49

Downlink - Upper 5 MHz operating band – Centre Frequency 427.5 MHz				
Active Channel(s) (MHz)	Lower Mkr Frequency (MHz)	Upper Mkr Frequency (MHz)	20dB Bandwidth (kHz)	Result
427.5 MHz	427.46955	427.52724	57.69	PASS
425.0125 MHz / 429.9875 MHz	424.09503	429.30336	5208.33	PASS

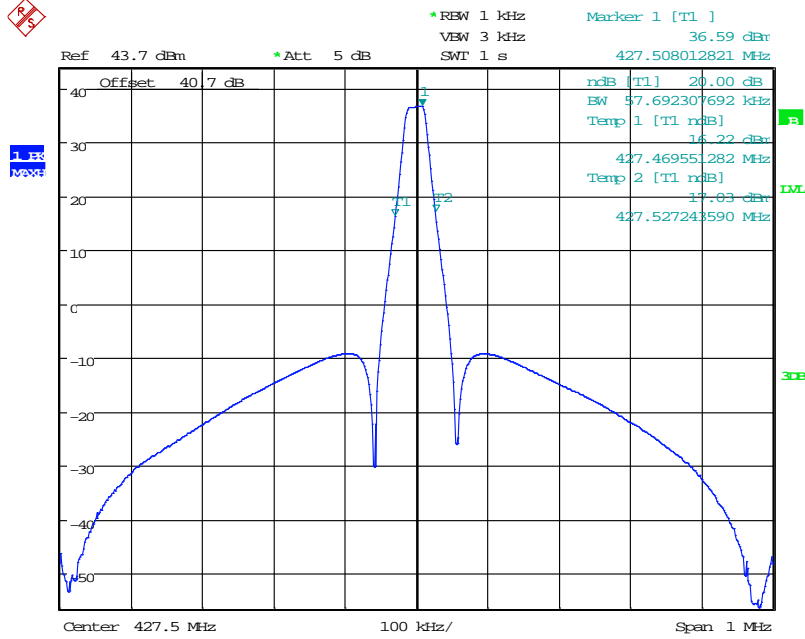

Date: 9.NOV.2015 14:16:59

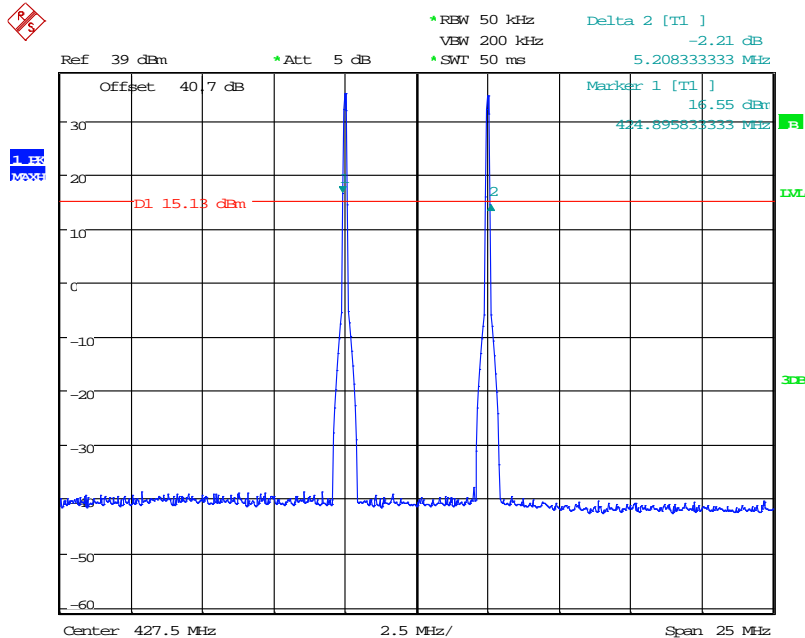

Date: 10.NOV.2015 15:19:09

Uplink - Lower 5 MHz operating band – Centre Frequency 412.5 MHz				
Active Channel(s) (MHz)	Lower Mkr Frequency (MHz)	Upper Mkr Frequency (MHz)	20dB Bandwidth (kHz)	Result
412.5 MHz	412.46955	412.52724	57.69	PASS
410.0125 MHz/ 414.9875 MHz	409.93250	415.05750	5125.00	PASS

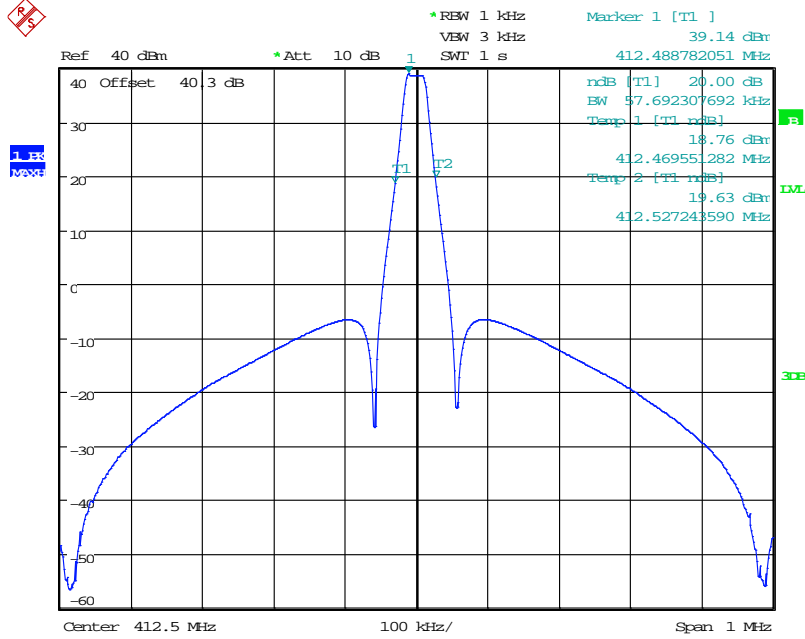

Date: 14.JAN.2004 13:35:09

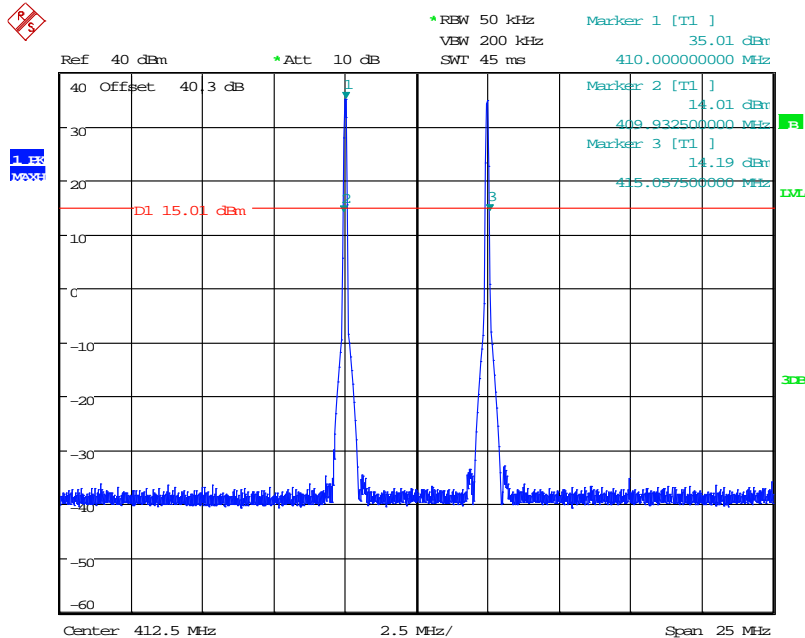

Date: 14.JAN.2004 12:56:11

Uplink - Middle 5 MHz operating band – Centre Frequency 420.0 MHz				
Active Channel(s) (MHz)	Lower Mkr Frequency (MHz)	Upper Mkr Frequency (MHz)	20dB Bandwidth (kHz)	Result
420.0	419.96955	420.02885	59.30	PASS
417.5125 MHz / 424.49875	417.43250	422.56500	5132.50	PASS

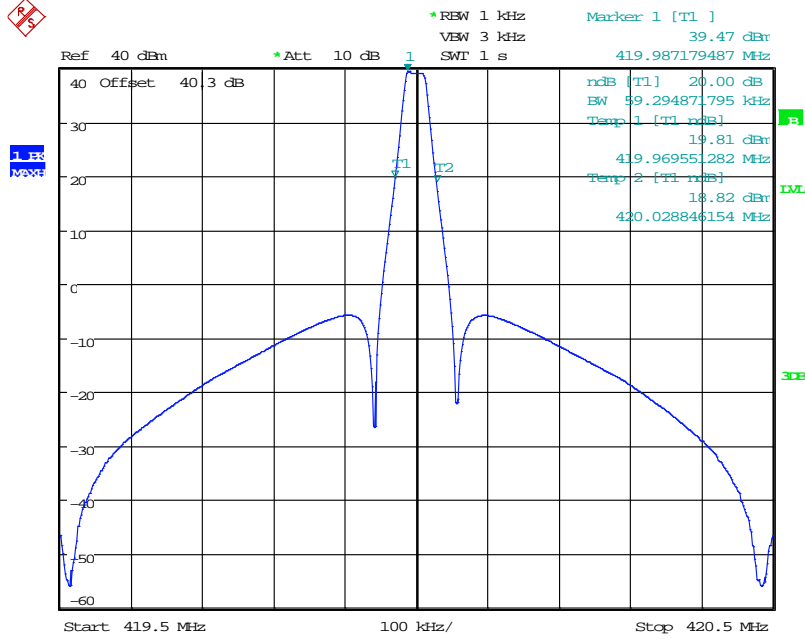

Date: 16.JAN.2004 13:29:24

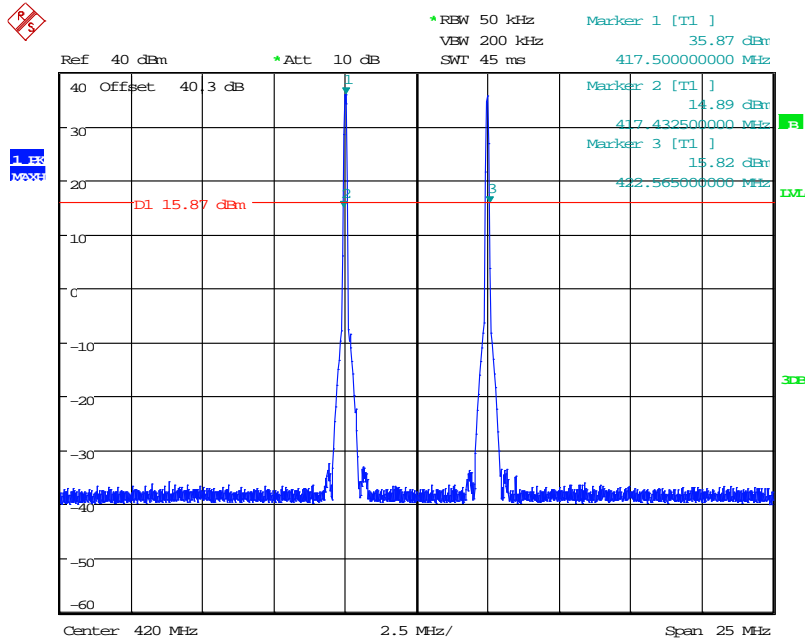

Date: 16.JAN.2004 10:21:24

Uplink - Upper 5 MHz operating band – Centre Frequency 427.5 MHz				
Active Channel(s) (MHz)	Lower Mkr Frequency (MHz)	Upper Mkr Frequency (MHz)	20dB Bandwidth (kHz)	Result
427.5 MHz	427.46955	427.52724	57.69	PASS
425.0125 MHz / 429.9875 MHz	424.89583	430.10416	5208.33	PASS

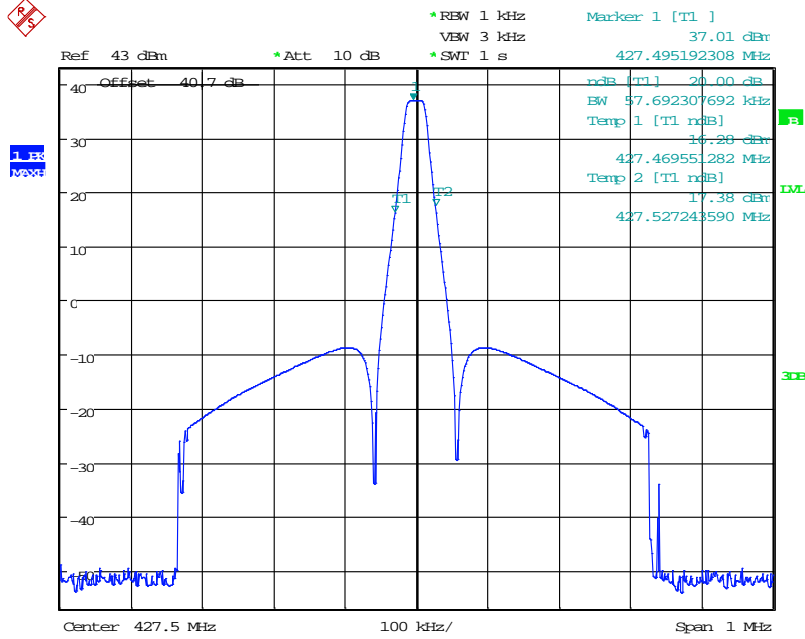

Date: 11.NOV.2015 12:00:22

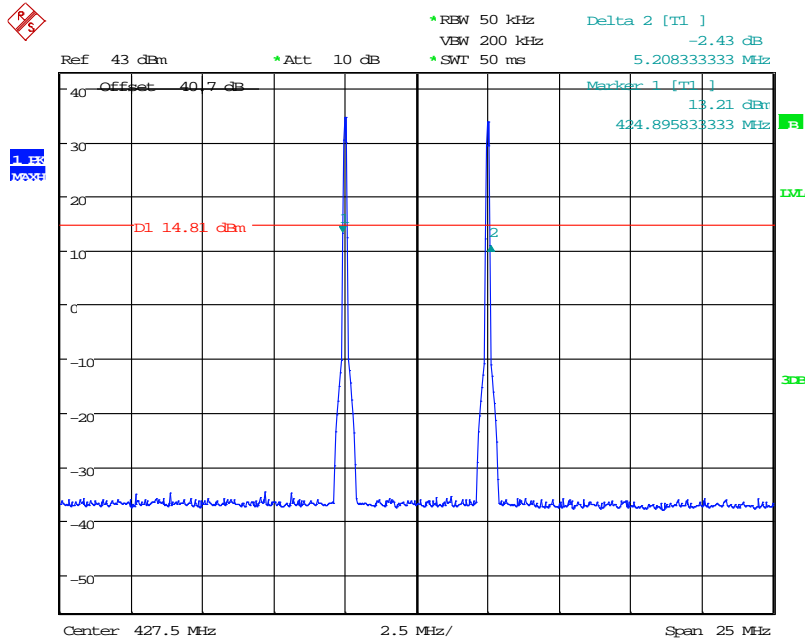

Date: 11.NOV.2015 12:41:46

15 Spurious emissions at antenna terminals

15.1 Definition

Emission on a frequency or frequencies which are outside the necessary bandwidth and the level of which may be reduced without affecting the corresponding transmission of information. Spurious emissions include harmonic emissions, parasitic emissions, intermodulation products and frequency conversion products, but exclude out-of-band emissions.

15.2 Test Parameters

Test Location:	Element Skelmersdale
Test Chamber:	Radio Lab
Test Standard and Clause:	IC RSS-131, clause 4.4 KDB 935210 D05 v01, clause 4.7.3
EUT Operating Frequencies Tested, f_0 :	412.5 MHz, 420MHz, 427.5MHz
Source Modulations:	CW, 16K0F3E, 11K3F3E, 4K00F1E
Source Level:	-46.2 dBm (maximum input rating)
Deviations From Standard:	None
Bandwidth:	RBW 100 kHz; VBW 3xRBW
Frequency Range Examined:	30 MHz – 5GHz (10 x highest passband)
Measurement Detector	Peak

Environmental Conditions (Normal Environment)

Temperature: 23°C	+15 °C to +35 °C (as declared)
Humidity: 42%RH	20%RH to 75%RH (as declared)
Supply: 110 V ac	110Vac +/-10% (as declared)

15.3 Test Limits

15.3.1 IC RSS-131

Spurious emissions of zone enhancers and translators shall be suppressed as much as possible.

Spurious emissions shall be attenuated below the rated power of the enhancer by at least:

$$43 + 10 \text{ Log}_{10}(P_{\text{rated}} \text{ in watts}), \text{ or } 70 \text{ dB, whichever is less stringent.}$$

Note: If the minimum standard is not met, check to see if the input signal generators have a high harmonic content.

15.3.2 47CFR90

Spurious emissions from a signal booster must not exceed -13 dBm within any 100 kHz measurement bandwidth.

15.4 Test Method

Single Channel:

With the EUT setup as per section 9 of this report and connected as per Figure vi, the emissions of the EUT were calculated by taking into account any cable and attenuator calibration factors. It was confirmed that at the maximum input level there was no compression.

Figure vi Test Setup

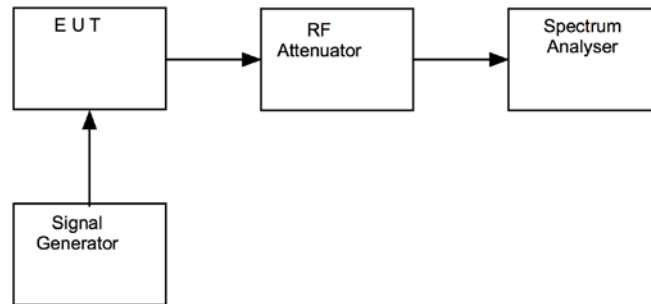

Multi-Channel (RSS-131):

With the EUT setup as per section 9 of this report and connected as per Figure vii, two similar sinusoidal signal inputs were used, such that the 3rd order intermodulation products were also within the passband of the EUT. The input level(s) were increased until the products met the required level. The emissions of the EUT were calculated by taking into account any cable and attenuator calibration factors.

Figure vii Test Setup

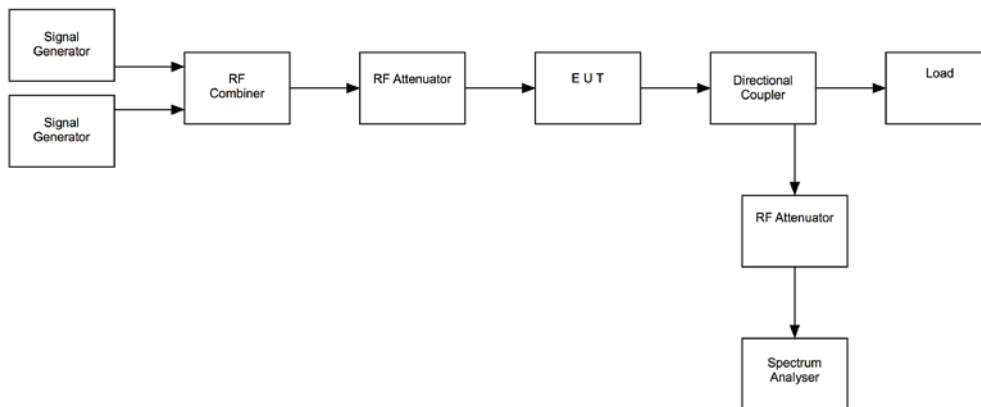

15.5 Test Equipment

<i>Equipment Description</i>	<i>Manufacturer</i>	<i>Equipment Type</i>	<i>Element No</i>	<i>Last Cal Calibration</i>	<i>Calibration Period</i>	<i>Due For Calibration</i>
Spectrum Analyser	R&S	FSU46	U281	24/04/2015	12	24/04/2016
Signal Generator	R&S	SMBV100A	REF916	17/02/2015	12	17/02/2016
Signal Generator	Agilent	ESG-D3000A	RFG441	08/10/2014	24	08/10/2016

15.6 Test Results

15.6.1 Out-of-band - Downlink

Downlink								
Operating Frequency (MHz)	Frequency Range (MHz)	Freq. of Emission (MHz)	Measured Level (dBm)	Attenuator & Cable Losses (dB)	Spurious Emission Level (dBm)	Limit (dBm)	Result	
412.5	30 – 5,000	No Significant Emissions Within 20 dB of the limit						PASS
420.0	30 – 5,000						PASS	
427.5	30 – 5,000						PASS	

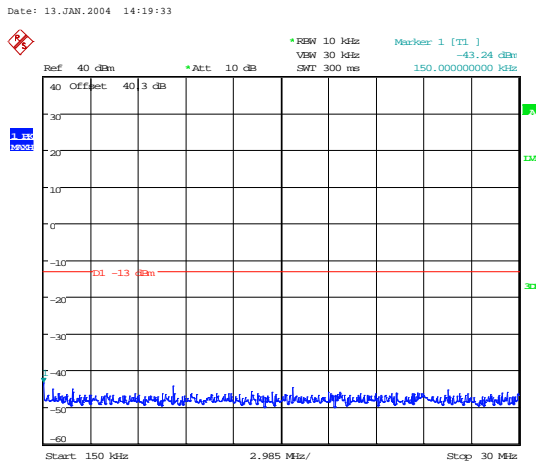
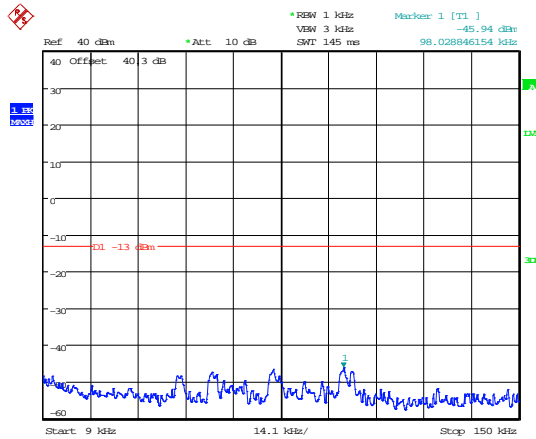

Date: 13.JAN.2004 14:20:08

9 kHz – 150 kHz

Downlink 412.5 MHz

150 kHz – 30 MHz

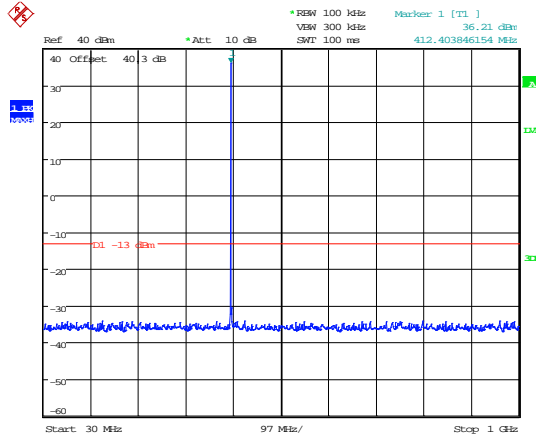

Date: 13.JAN.2004 14:20:25

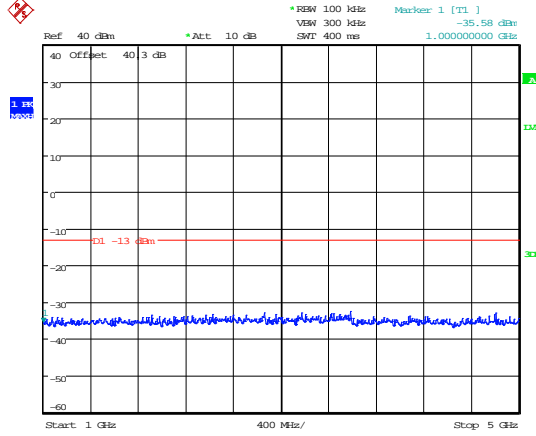

Date: 13.JAN.2004 14:19:08

30 MHz – 1 GHz

Downlink 412.5 MHz

1 GHz – 5 GHz

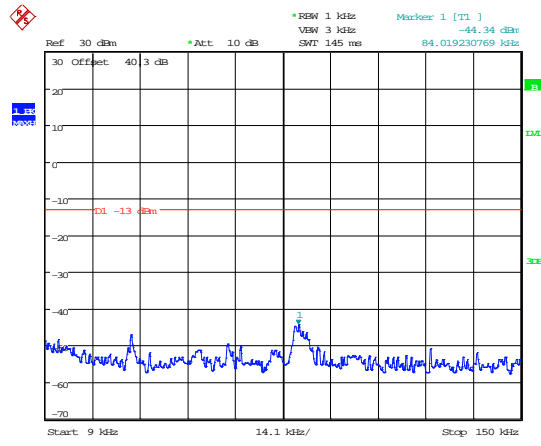

Date: 16.JAN.2004 08:46:13

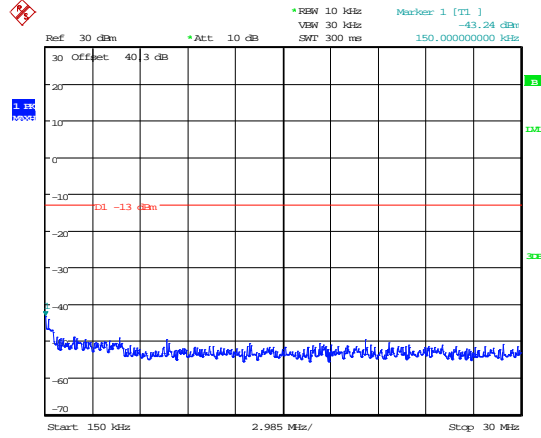

Date: 16.JAN.2004 08:46:27

9 kHz – 150 kHz

Downlink 420.0 MHz

150 kHz – 30 MHz

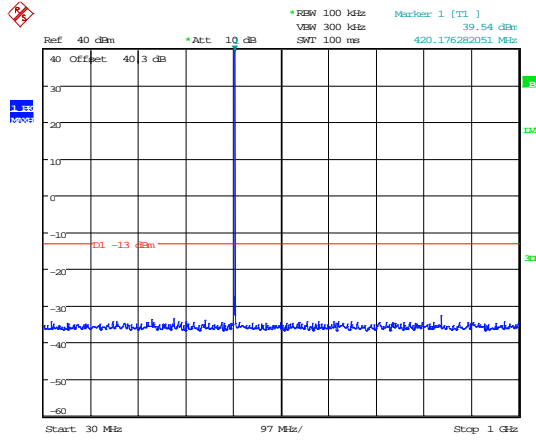

Date: 16.JAN.2004 08:46:49

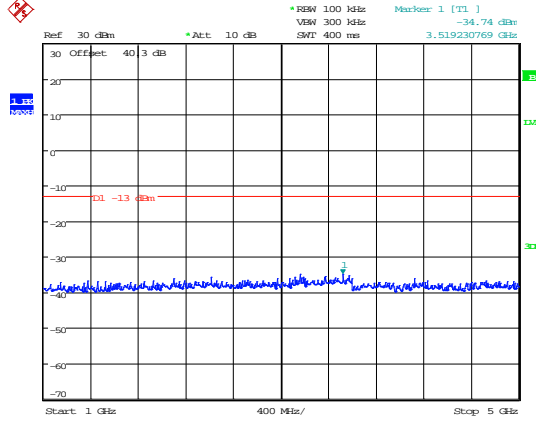

Date: 16.JAN.2004 08:45:51

30 MHz – 1 GHz

Downlink 420.0 MHz

1 GHz – 5 GHz

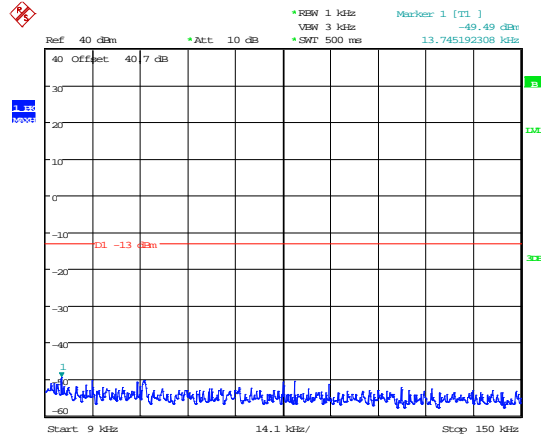

Date: 11.NOV.2015 10:19:43

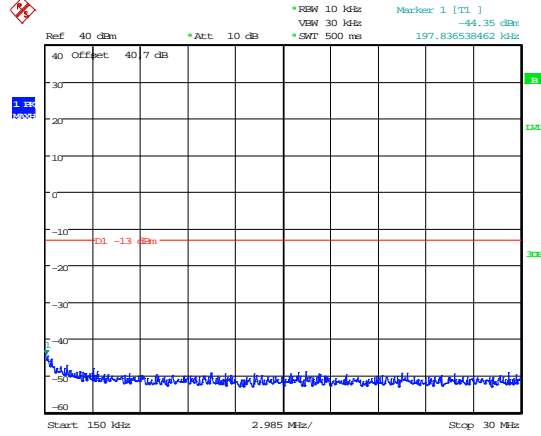

Date: 11.NOV.2015 10:20:05

9 kHz – 150 kHz

Downlink 427.5 MHz

150 kHz – 30 MHz

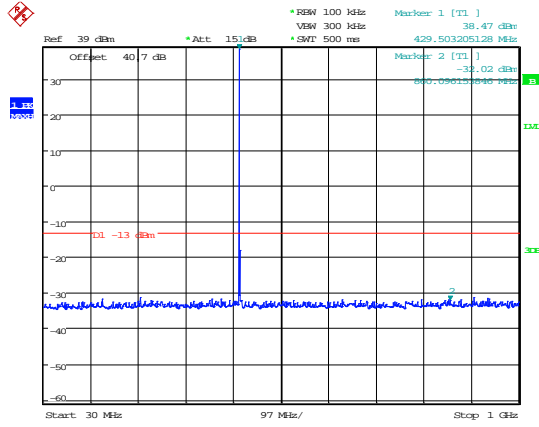

Date: 11.NOV.2015 10:21:30

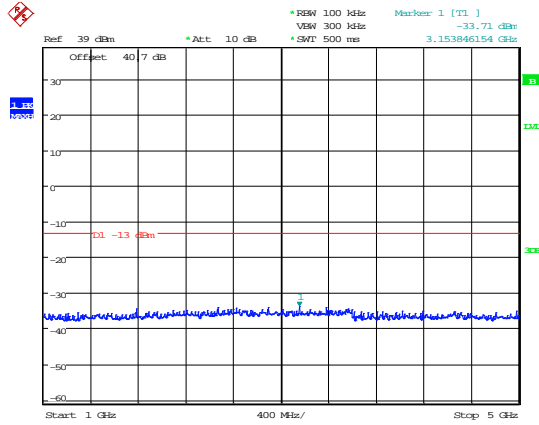

Date: 11.NOV.2015 10:22:38

30 MHz – 1 GHz

Downlink 427.5 MHz

1 GHz – 5 GHz

IC Plots

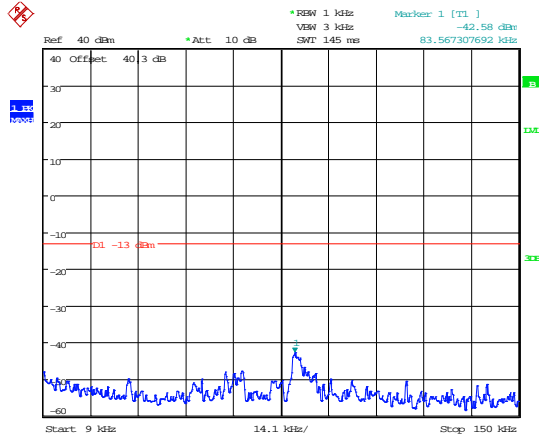

Date: 14.JAN.2004 09:40:56

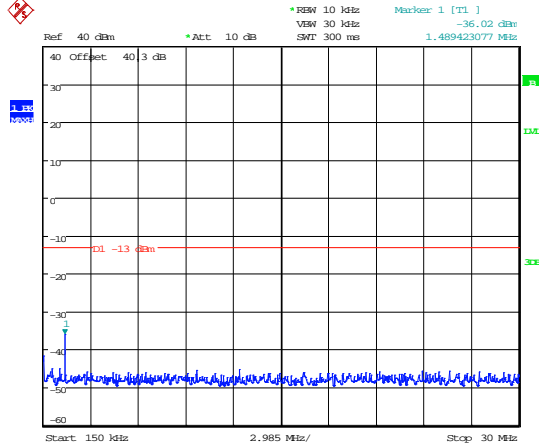

Date: 14.JAN.2004 09:41:19

9 kHz – 150 kHz

Downlink 412.5 MHz

150 kHz – 30 MHz

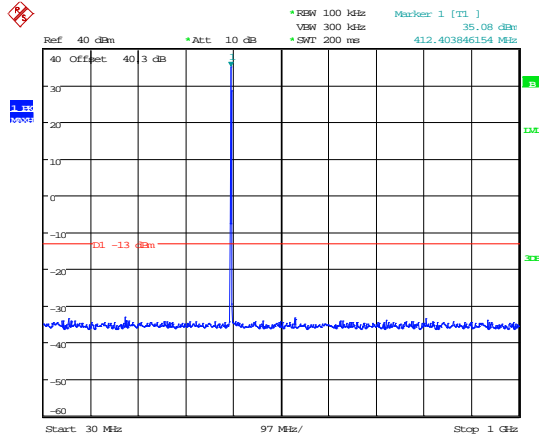

Date: 14.JAN.2004 09:40:16

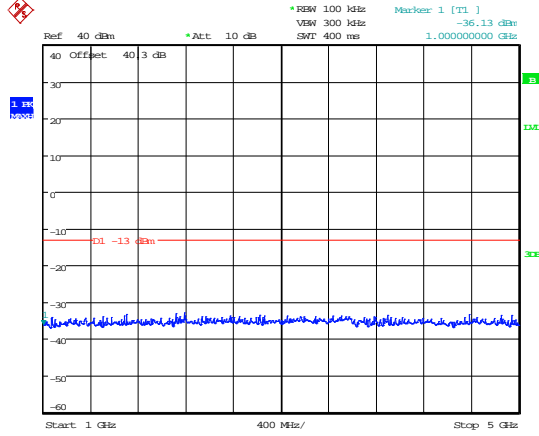

Date: 14.JAN.2004 09:40:40

30 MHz – 1 GHz

Downlink 412.5 MHz

1 GHz – 5 GHz

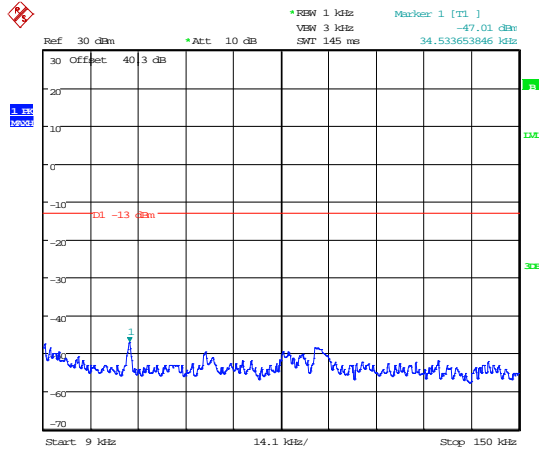

Date: 16.JAN.2004 09:44:32

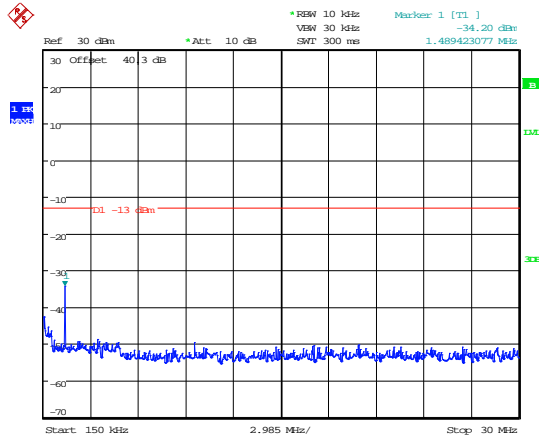

Date: 16.JAN.2004 09:44:46

9 kHz – 150 kHz

Downlink 420.0 MHz

150 kHz – 30 MHz

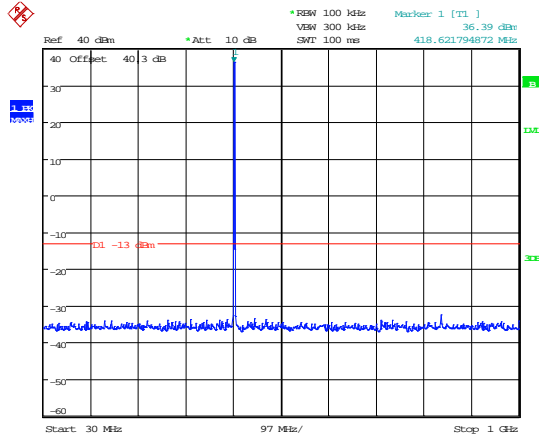

Date: 16.JAN.2004 09:43:49

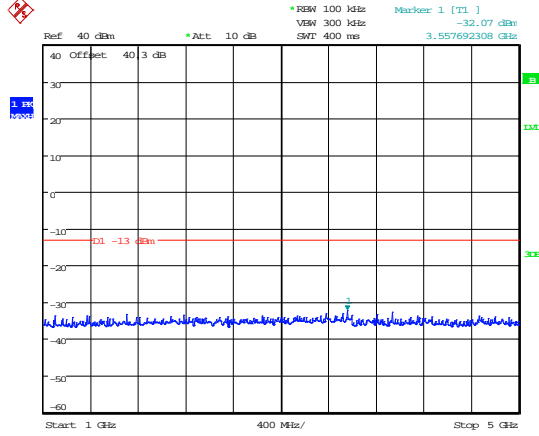

Date: 16.JAN.2004 09:44:09

30 MHz – 1 GHz

Downlink 420.0 MHz

1 GHz – 5 GHz

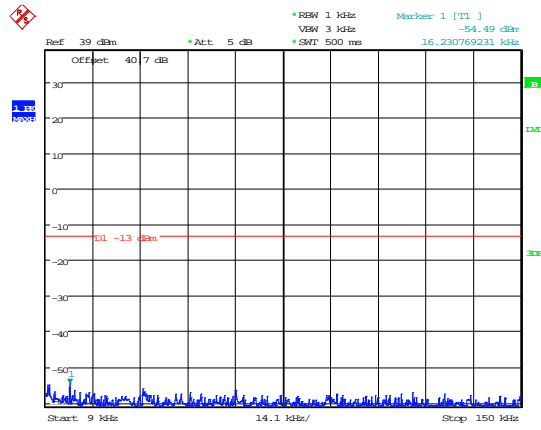

Date: 10.NOV.2015 13:00:07

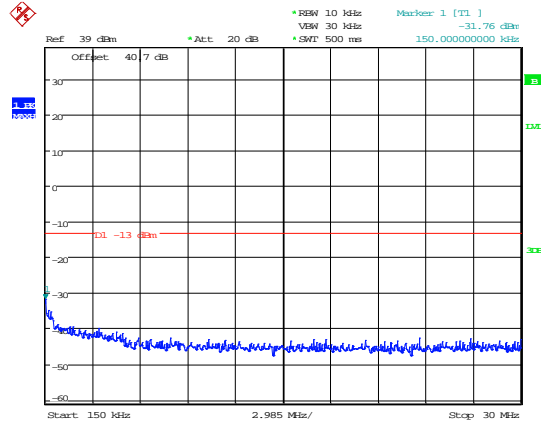

Date: 10.NOV.2015 13:01:06

9 kHz – 150 kHz

Downlink 427.5 MHz

150 kHz – 30 MHz

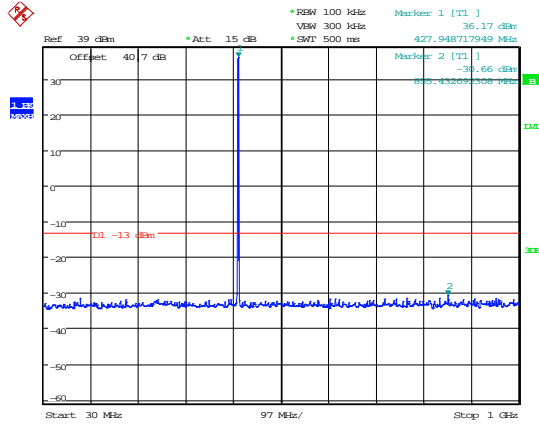

Date: 10.NOV.2015 13:02:09

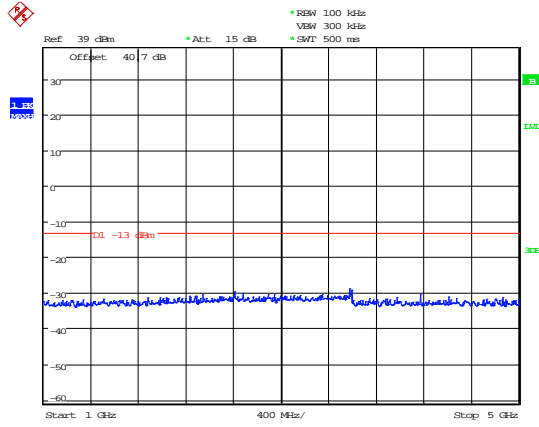

Date: 10.NOV.2015 13:02:32

30 MHz – 1 GHz

Downlink 427.5 MHz

1 GHz – 5 GHz

Out-of-band - Uplink

Uplink

Operating Frequency (MHz)	Frequency Range (MHz)	Freq. of Emission (MHz)	Measured Level (dBm)	Attenuator & Cable Losses (dB)	Spurious Emission Level (dBm)	Limit (dBm)	Result
412.5	30 – 10,000	No Significant Emissions Within 20 dB of the limit					PASS
420.0	30 – 10,000						PASS
427.5	30 – 10,000						PASS

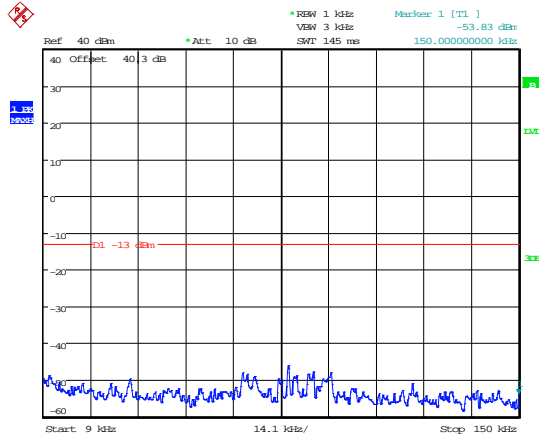

Date: 14.JAN.2004 13:37:34

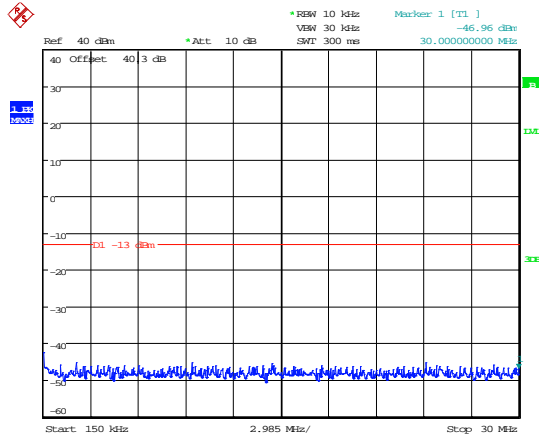

Date: 14.JAN.2004 13:37:15

9 kHz – 150 kHz

Uplink 412.5 MHz

150 kHz – 30 MHz

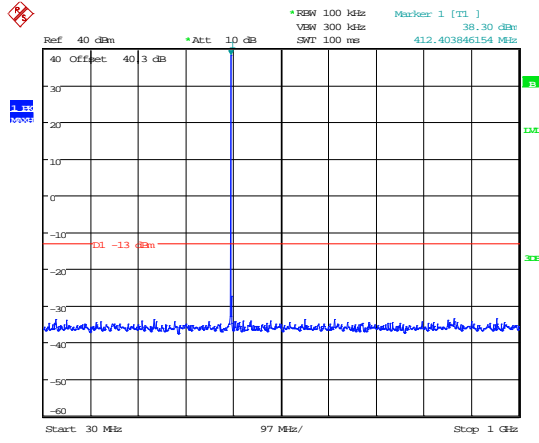

Date: 14.JAN.2004 13:37:02

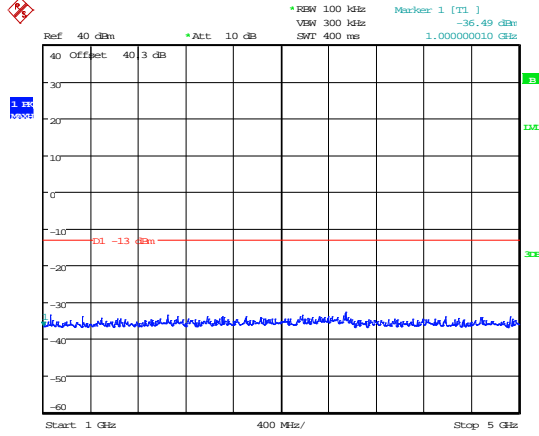

Date: 14.JAN.2004 13:37:51

30 MHz – 1 GHz

Uplink 412.5 MHz

1 GHz – 5 GHz

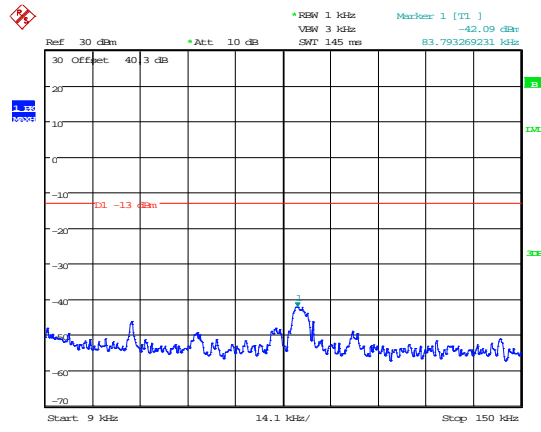

Date: 16.JAN.2004 08:52:11

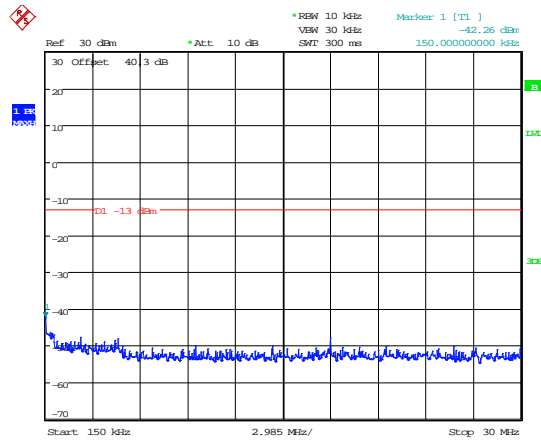

Date: 16.JAN.2004 08:52:37

9 kHz – 150 kHz

Uplink 420.0 MHz

150 kHz – 30 MHz

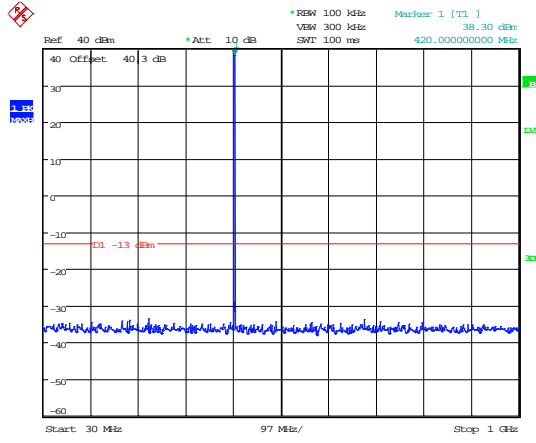

Date: 16.JAN.2004 08:51:22

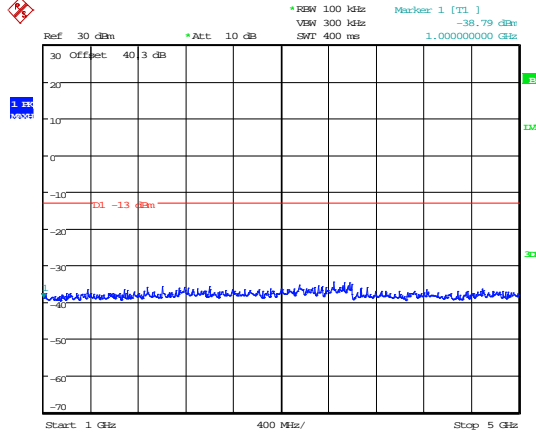

Date: 16.JAN.2004 08:51:42

30 MHz – 1 GHz

Uplink 420.0 MHz

1 GHz – 5 GHz

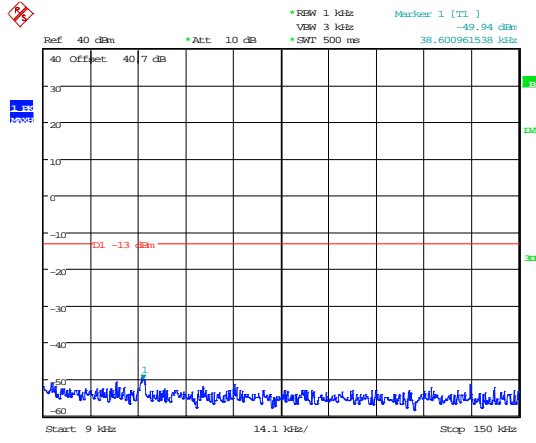

Date: 11.NOV.2015 10:12:40

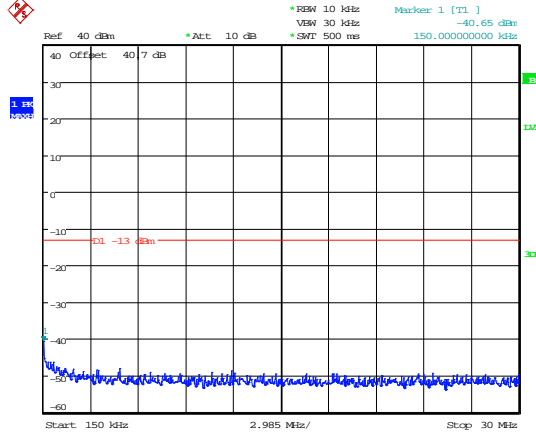

Date: 11.NOV.2015 10:13:04

9 kHz – 150 kHz

Uplink 427.5 MHz

150 kHz – 30 MHz

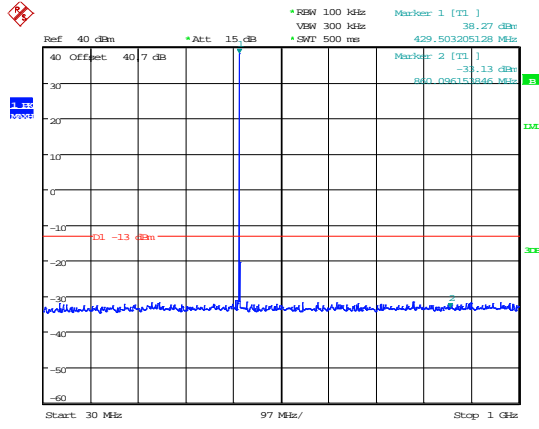

Date: 11.NOV.2015 10:14:44

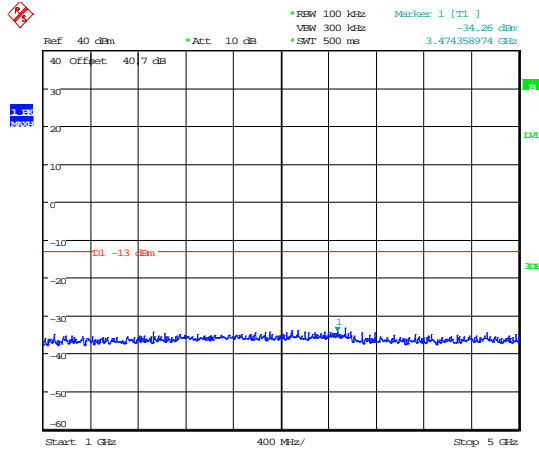

Date: 11.NOV.2015 10:16:01

30 MHz – 1 GHz

Uplink 427.5 MHz

1 GHz – 5 GHz

IC Plots

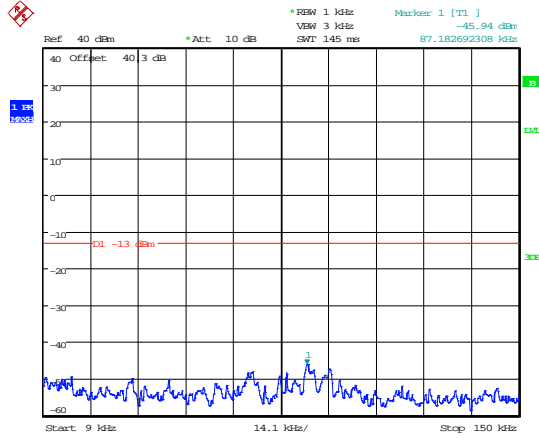

Date: 14.JAN.2004 14:46:33

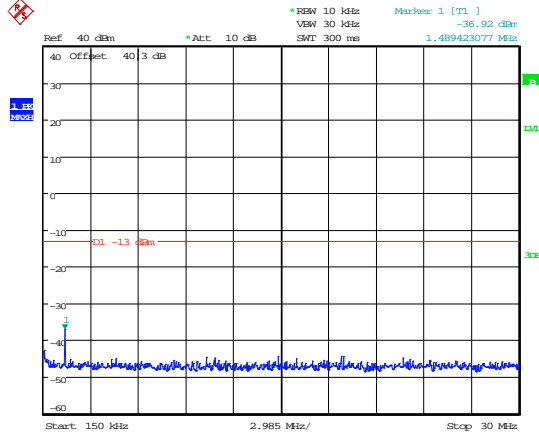

Date: 14.JAN.2004 14:47:26

9 kHz – 150 kHz

Uplink 412.5 MHz

150 kHz – 30 MHz

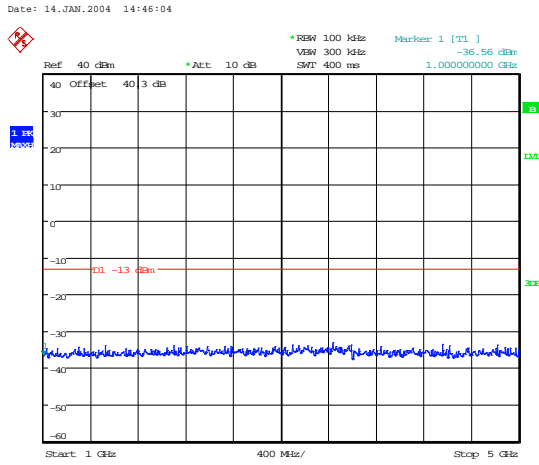
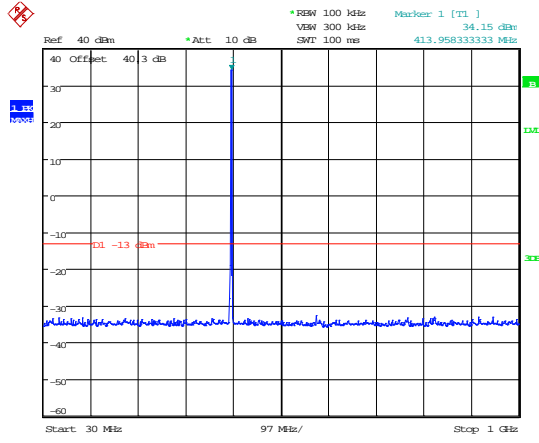

Date: 14.JAN.2004 14:46:15

30 MHz – 1 GHz

Uplink 412.5 MHz

1 GHz – 5 GHz

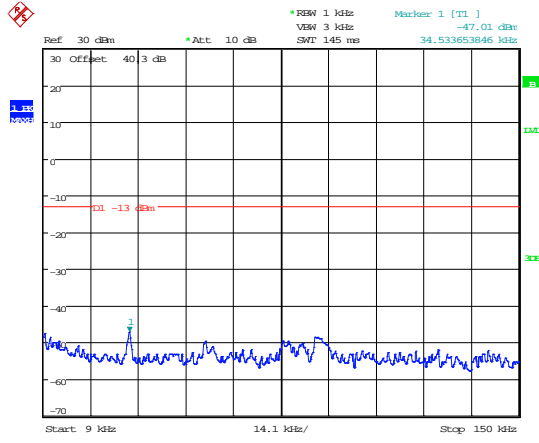

Date: 16.JAN.2004 09:44:32

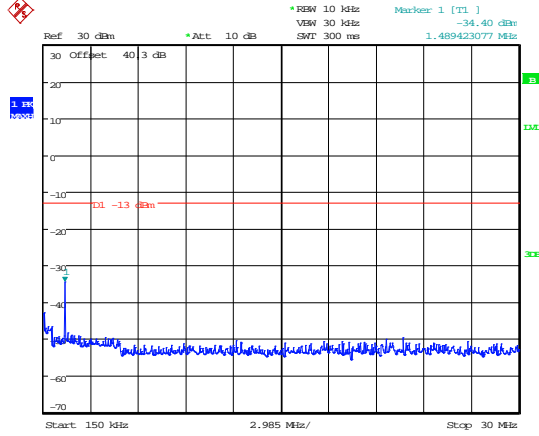

Date: 16.JAN.2004 09:49:52

9 kHz – 150 kHz

Uplink 420.0 MHz

150 kHz – 30 MHz

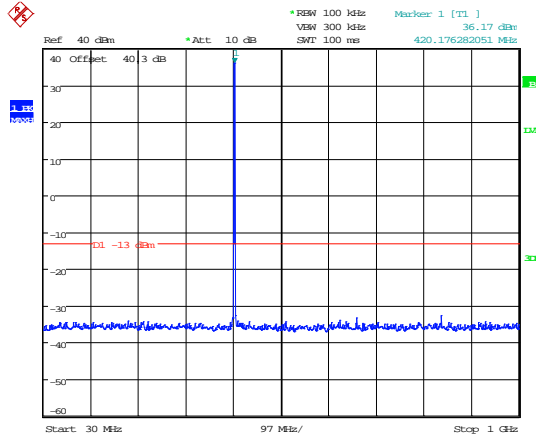

Date: 16.JAN.2004 09:49:02

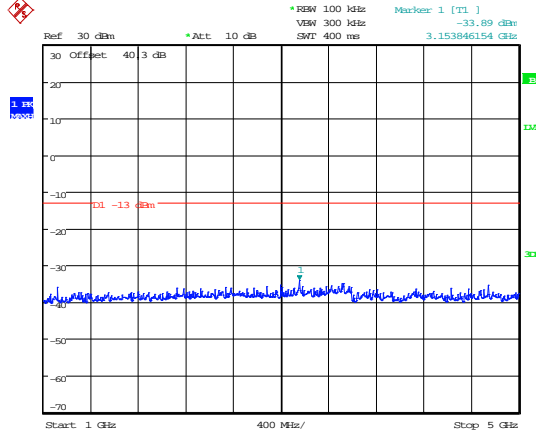

Date: 16.JAN.2004 09:49:17

30 MHz – 1 GHz

Uplink 420.0 MHz

1 GHz – 5 GHz

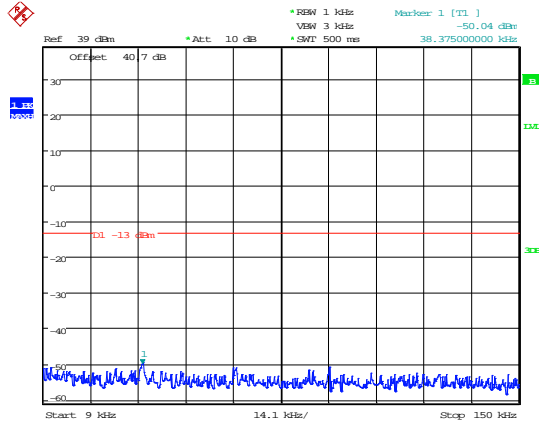

Date: 11.NOV.2015 14:52:44

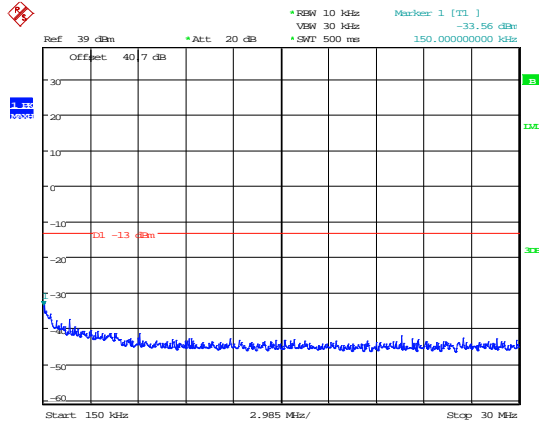

Date: 11.NOV.2015 14:53:36

9 kHz – 150 kHz

Uplink 427.5 MHz

150 kHz – 30 MHz

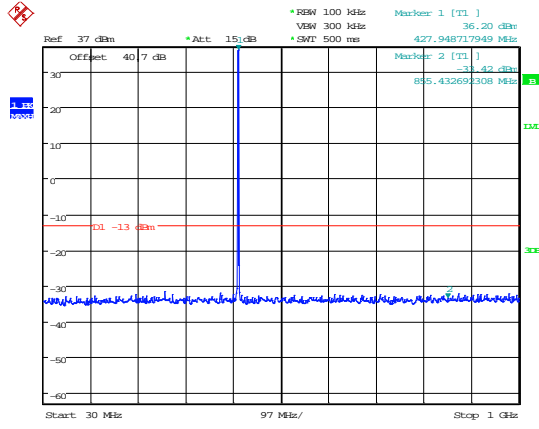

Date: 11.NOV.2015 14:54:35

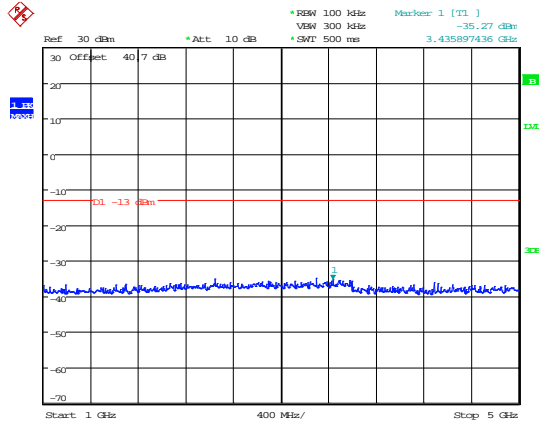

Date: 11.NOV.2015 14:55:20

30 MHz – 1 GHz

Uplink 427.5 MHz

1 GHz – 5 GHz

16 Intermodulation products

16.1 Definition

Spurious intermodulation products result from intermodulation between: – the oscillations at the carrier, characteristic, or harmonic frequencies of an emission, or the oscillations resulting from the generation of the carrier or characteristic frequency; and – oscillations of the same nature, of one or several other emissions, originating from the same transmitting system or from other transmitters or transmitting systems.

16.2 Test Parameters

Test Location:	Element Skelmersdale
Test Chamber:	Radio Lab
Test Standard and Clause:	IC RSS-131, clause 4.3 KDB 935210 D05 v01, clause 4.5
EUT Operating Frequencies Tested, f_0 :	412.5 MHz 420MHz, 427.5MHz
Source Tones:	f_0 +/- 12.5 kHz
Source Level:	-46.2, -46.8 dBm (AGC threshold and 3dB above)
Deviations From Standard:	None
Bandwidth:	RBW 300 Hz; VBW 3xRBW
Span:	100 kHz
Measurement Detector	Average, rms.

Environmental Conditions (Normal Environment)

Temperature: 22°C	+15 °C to +35 °C (as declared)
Humidity: 44%RH	20%RH to 75%RH (as declared)
Supply: 110 V ac	110Vac +/-10% (as declared)

16.3 Test Limits

The retransmitted signals continue to meet the unwanted emissions limits of §90.210 applicable to the corresponding received signals (assuming that these received signals meet the applicable unwanted emissions limits by a reasonable margin).

16.4 Test Method

With the EUT setup as per section 9 of this report and connected as per Figure viii, two tones were input to the EUT. The combined level at the EUT input was set by the attenuator to just below the EUT AGC threshold level and the intermodulation products were measured on the spectrum analyser. The measurement was repeated with the input attenuator decreased by 3dB.

Figure viii Test Setup

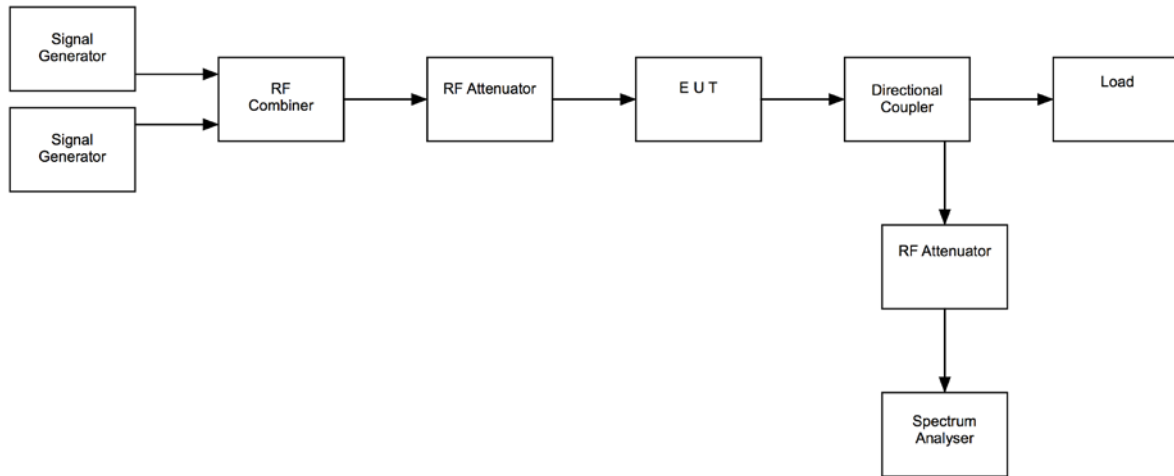

16.5 Test Equipment

<i>Equipment Description</i>	<i>Manufacturer</i>	<i>Equipment Type</i>	<i>Element No</i>	<i>Last Cal Calibration</i>	<i>Calibration Period</i>	<i>Due For Calibration</i>
Spectrum Analyser	R&S	FSU46	U281	24/04/2015	12	24/04/2016
Signal Generator	R&S	SMBV100A	REF916	17/02/2015	12	17/02/2016
Signal Generator	Agilent	ESG-D3000A	RFG441	08/10/2014	24	08/10/2016

16.6 Test Results

Downlink Intermodulation @ AGC threshold						
Centre Frequency (MHz)	Tone 2 (MHz)	Tone 2 (MHz)	Frequency of Intermodulation Product (MHz)	Highest Intermodulation Product Level (dBm)	Limit (dBm)	Result
412.5	412.4875	412.5125	412.4625	-28.54	-13	PASS
420.0	419.9875	420.0125	419.9625	-34.34	-13	PASS
427.5	427.4875	427.5125	427.4625	-47.70	-13	PASS

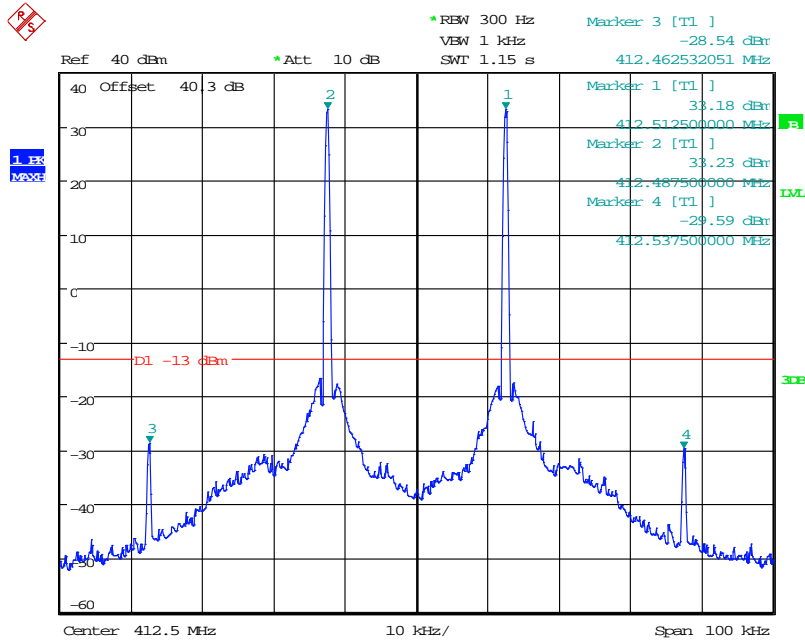

Date: 14.JAN.2004 09:26:36

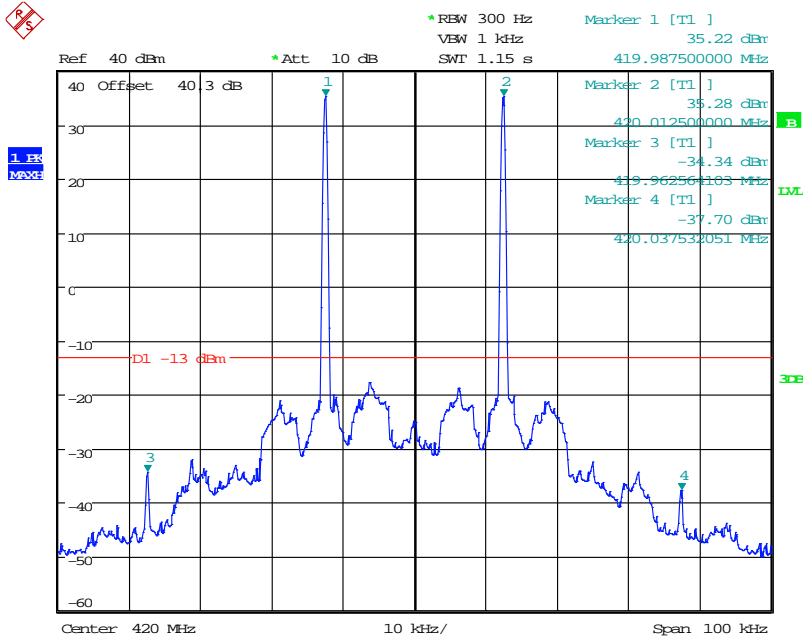

Date: 16.JAN.2004 09:35:43

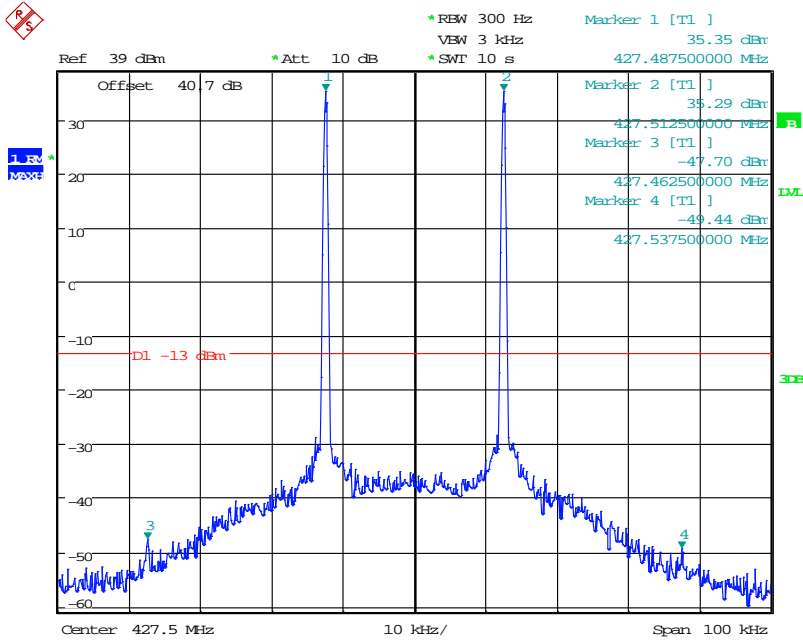

Date: 11.NOV.2015 10:49:05

Downlink Intermodulation @ 3dB above AGC threshold						
Centre Frequency (MHz)	Tone 2 (MHz)	Tone 1 (MHz)	Frequency of Intermodulation Product (MHz)	Highest Intermodulation Product Level (dBm)	Limit (dBm)	Result
412.5	412.4875	512.5125	412.4625	-29.81	-13	PASS
420.0	419.9875	420.0125	419.9625	-33.90	-13	PASS
427.5	427.4875	427.5125	427.4625	-44.42	-13	PASS

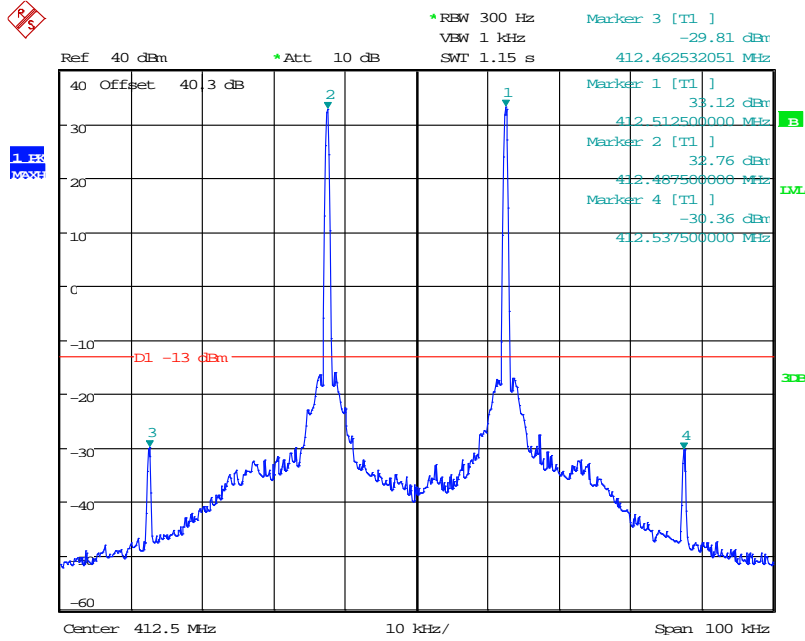

Date: 14.JAN.2004 09:31:13

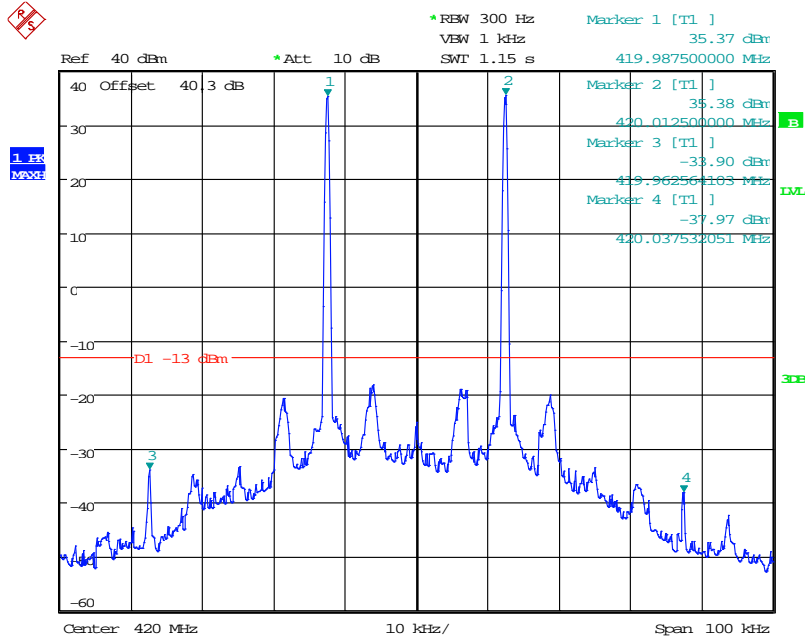

Date: 16.JAN.2004 09:36:46

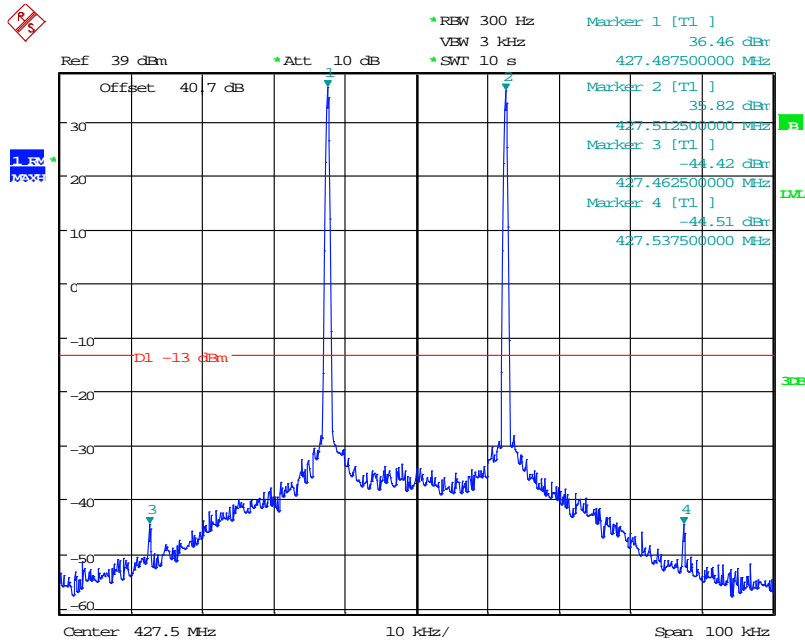

Date: 11.NOV.2015 10:49:55

Uplink Intermodulation @ AGC threshold						
Centre Frequency (MHz)	Tone 2 (MHz)	Tone 2 (MHz)	Frequency of Intermodulation Product (MHz)	Highest Intermodulation Product Level (dBm)	Limit (dBm)	Result
412.5	412.4875	412.5125	412.4625	-25.98	-13	PASS
420.0	419.9875	420.0125	419.9625	-32.93	-13	PASS
427.5	427.4875	427.5125	427.4625	-45.58	-13	PASS

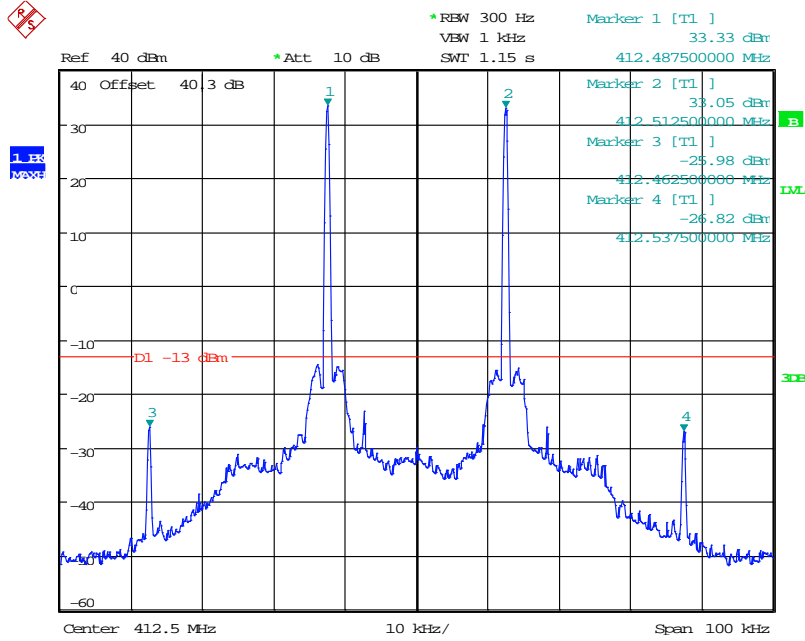

Date: 14.JAN.2004 14:32:29

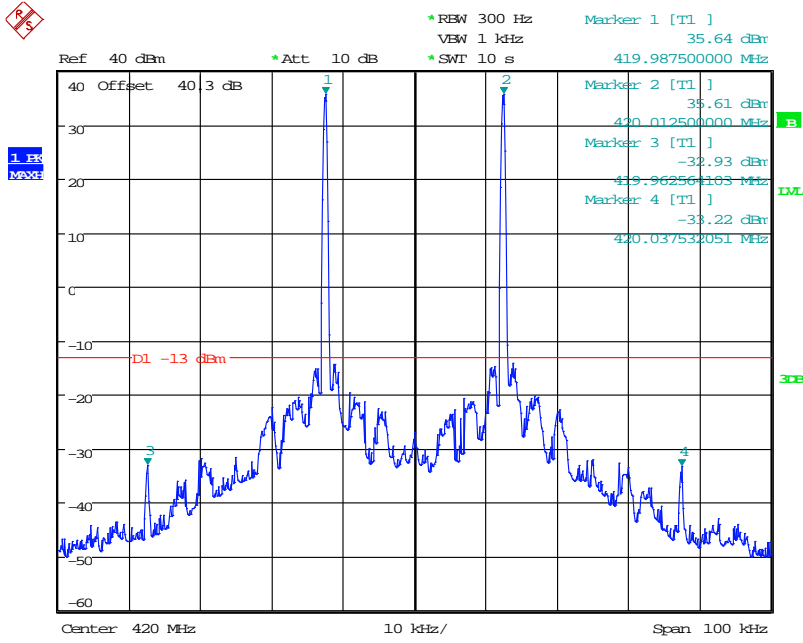

Date: 16.JAN.2004 09:23:47

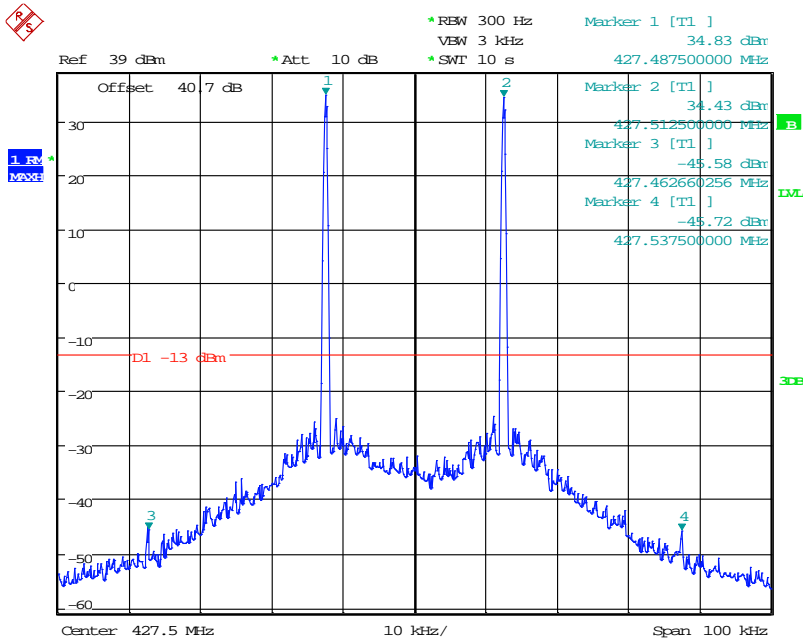

Date: 11.NOV.2015 10:40:29

Uplink Intermodulation @ 3dB above AGC threshold						
Centre Frequency (MHz)	Tone 2 (MHz)	Tone 2 (MHz)	Frequency of Intermodulation Product (MHz)	Highest Intermodulation Product Level (dBm)	Limit (dBm)	Result
412.5	412.4875	512.5125	412.4625	-27.42	-13	PASS
420.0	419.9875	420.0125	419.9625	-32.44	-13	PASS
427.5	427.4875	427.5125	427.5375	-39.59	-13	PASS

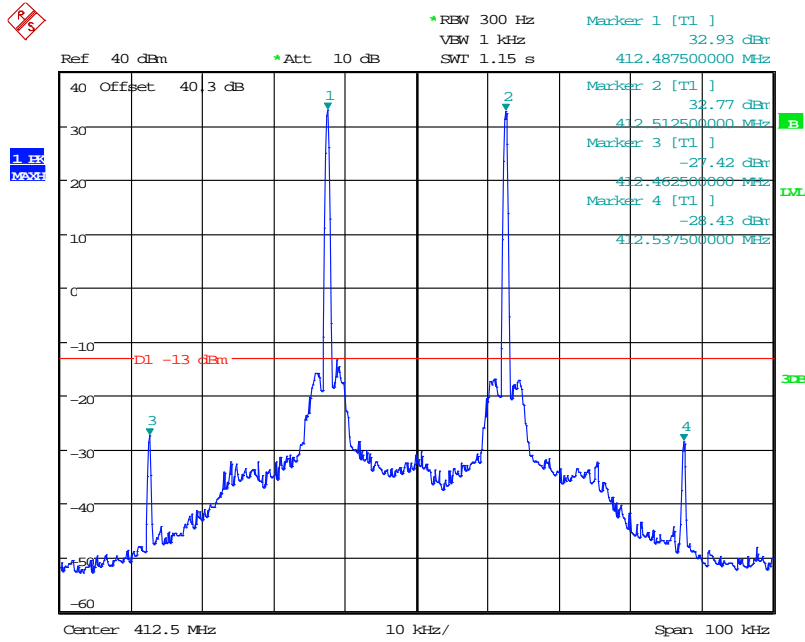

Date: 14.JAN.2004 14:34:30

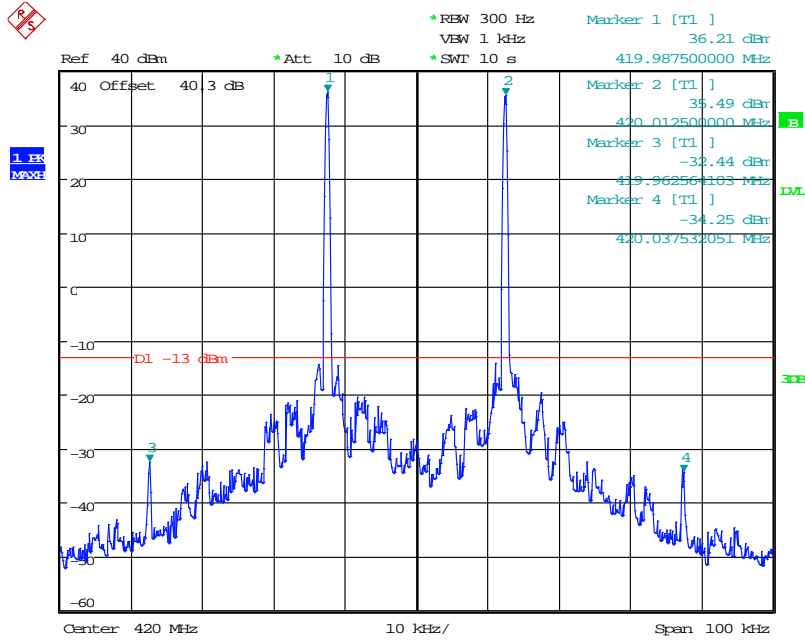

Date: 16.JAN.2004 09:24:28

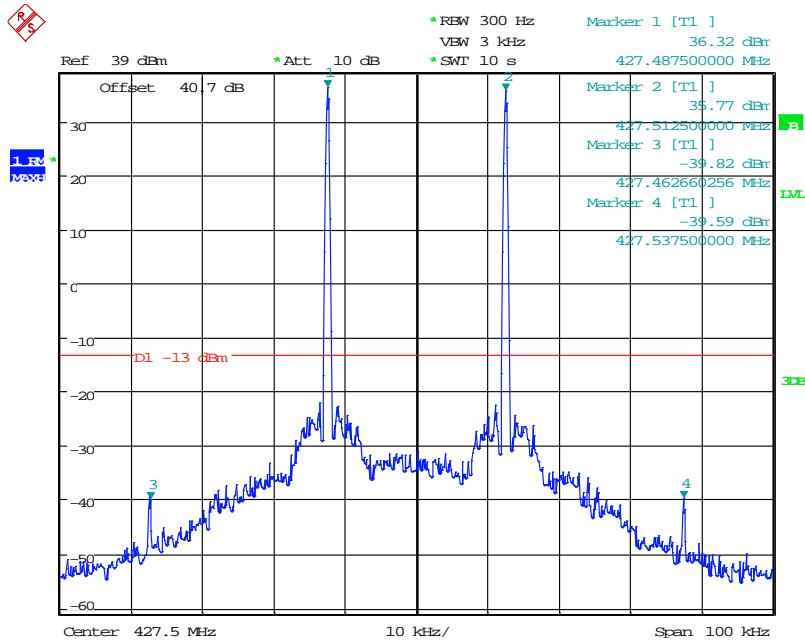

Date: 11.NOV.2015 10:42:30

17 Field strength of spurious radiation

17.1 Definitions

Spurious emissions that may be radiated directly from the cabinet, control circuits, power leads, or intermediate circuit elements under normal conditions of installation and operation.

17.2 Test Parameters

Test Location:	Element Skelmersdale
Test Chamber:	Radio Chamber (REF940)
Test Standard and Clause:	TIA 603-D, clause 2.2.12
EUT Operating Frequencies Tested:	412.5 MHz 420MHz, 427.5MHz
Source Modulations:	CW, 16K0F3E, 11K3F3E, 4K00F1E
Source Level:	-46.2 dBm (maximum input rating)
Deviations From Standard:	None
Frequency Range Examined:	30 MHz – 5GHz (10 x highest passband)
Measurement BW:	30 MHz to 1 GHz: 120 kHz Above 1 GHz: 1 MHz
Measurement Detector:	Up to 1 GHz: quasi-peak Above 1 GHz: Peak

Environmental Conditions (Normal Environment)

Temperature: 23 °C	+15 °C to +35 °C (as declared)
Humidity: 42 %RH	20%RH to 75%RH (as declared)
Supply: 110 Vac	110Vac +/-10% (as declared)

17.3 Test Limits

Spurious emissions from a signal booster must not exceed -13 dBm within any 100 kHz measurement bandwidth.

17.4 Test Method

With the EUT setup as per section 9 of this report and connected as per Figure ix and with the EUT's antenna replaced by a non-radiating load, the emissions from the EUT were measured on a spectrum analyzer / EMI receiver. The EUT was rotated in three orthogonal planes and the measurement antenna height scanned (below 1GHz, from 1 to 4 m; above 1GHz as necessary) in order to maximise emissions.

The measurements were performed with EUT set at its maximum gain. All modulation schemes, data rates and power settings were used to observe the worst-case configuration at each frequency.

The EUT was substituted with a known generator and antenna and for the same level achieved at the analyser, the effective radiated power was recorded.

Pre-scan plots are shown with a peak detector and 100kHz RBW.

Figure ix Test Setup

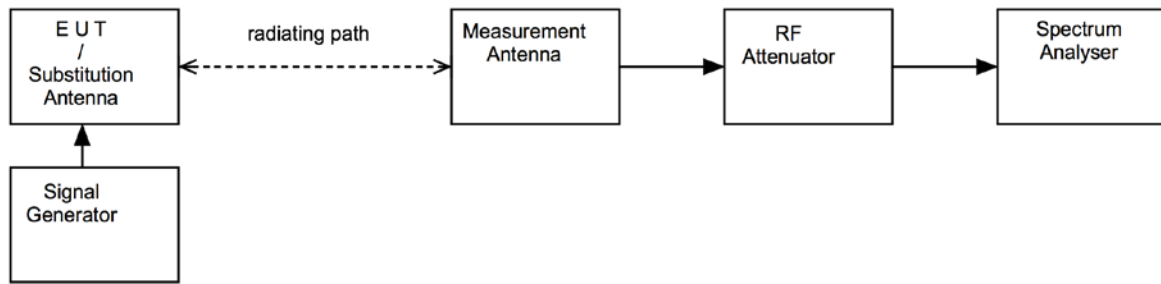

Test Setup Photograph(s)

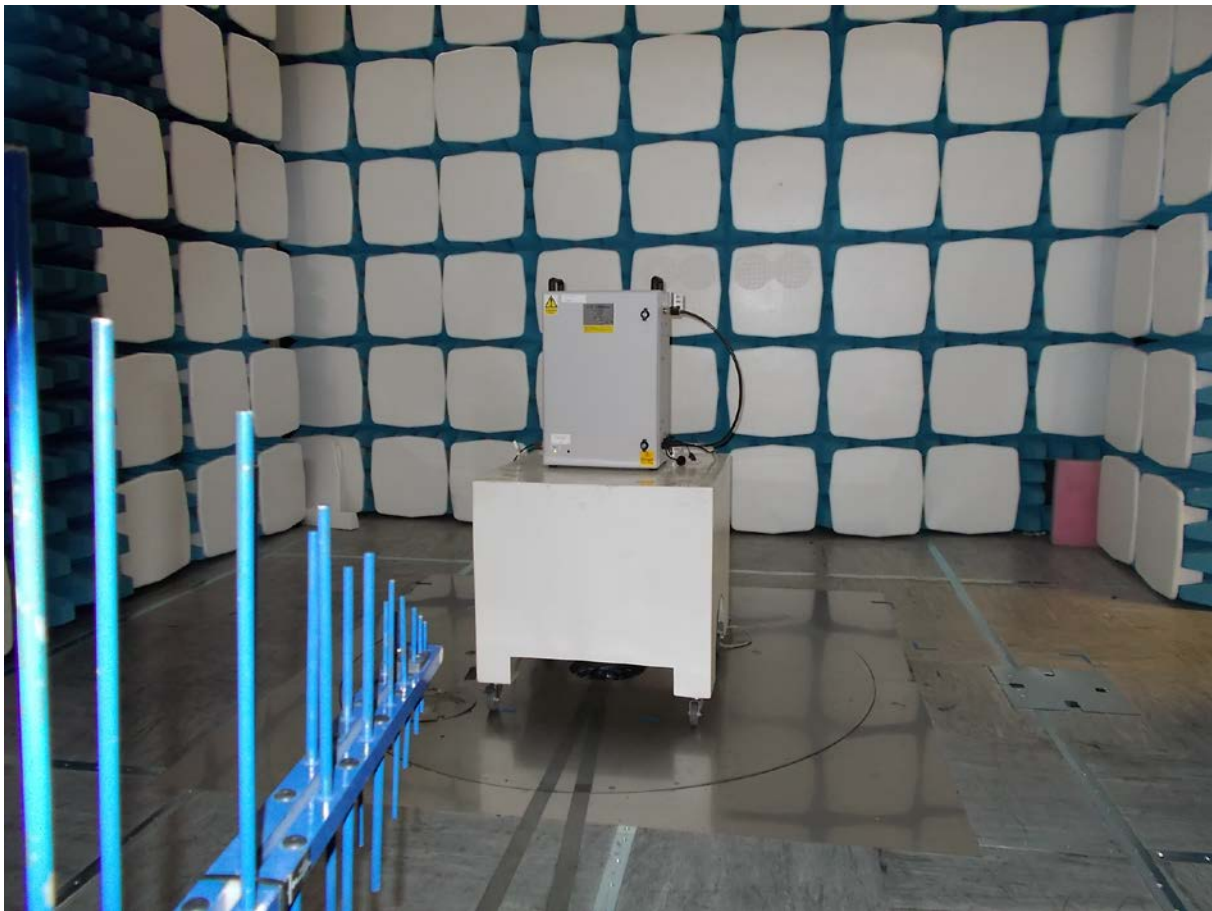

17.5 Test Equipment

<i>Equipment Description</i>	<i>Manufacturer</i>	<i>Equipment Type</i>	<i>Element No</i>	<i>Last Cal Calibration</i>	<i>Calibration Period</i>	<i>Due For Calibration</i>
Spectrum Analyser	R&S	FSU46	U281	24/04/2015	12	24/04/2016
Signal Generator	R&S	SMBV100A	REF916	17/02/2015	12	17/02/2016
Bilog Antenna	Chase	CBL6112/A	UH191	26/02/2015	24	26/02/2017
Horn Antenna	EMCO	3115	L139	25/09/2015	24	25/09/2017
Pre Amplifier	Agilent	8994A	L572	10/02/2015	12	10/02/2016
Receiver	R&S	ESVS10	L317	26/02/2015	12	26/02/2016

17.6 Test Results

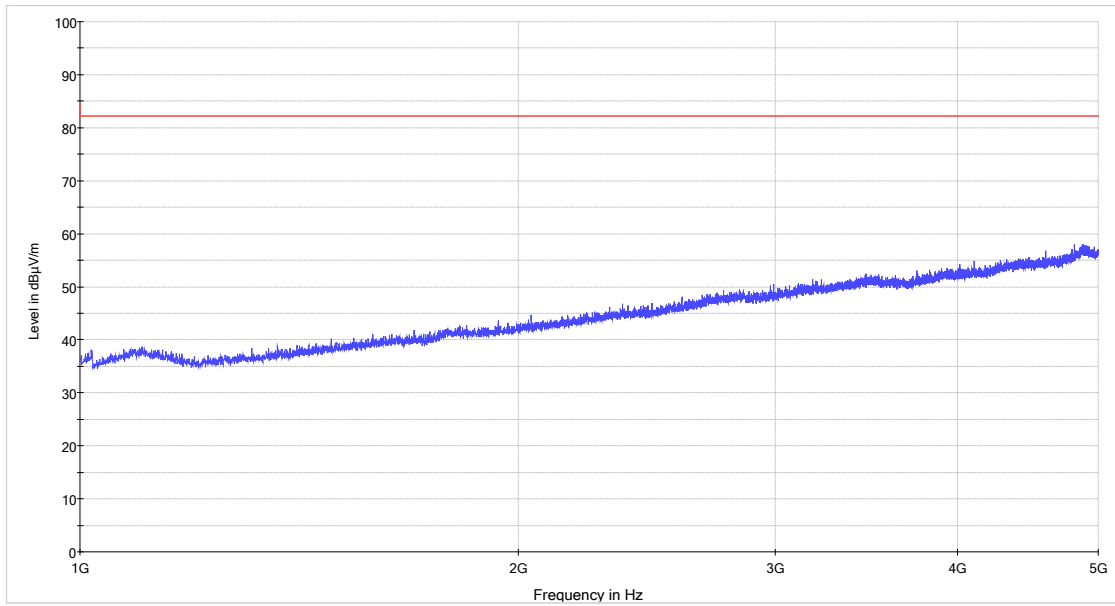
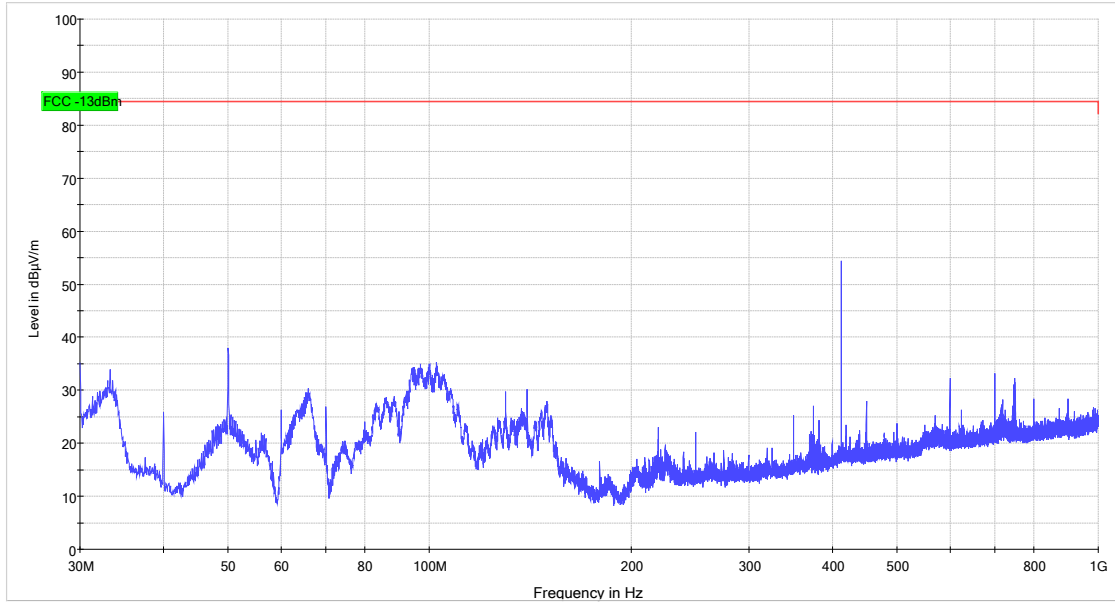

Downlink Low Frequency; 412.5 MHz					
Emission	Frequency (MHz)	Emission level (dBm)	Limit (dBm)	Margin (dB)	Result
No Significant Emissions Within 10 dB of Limit					

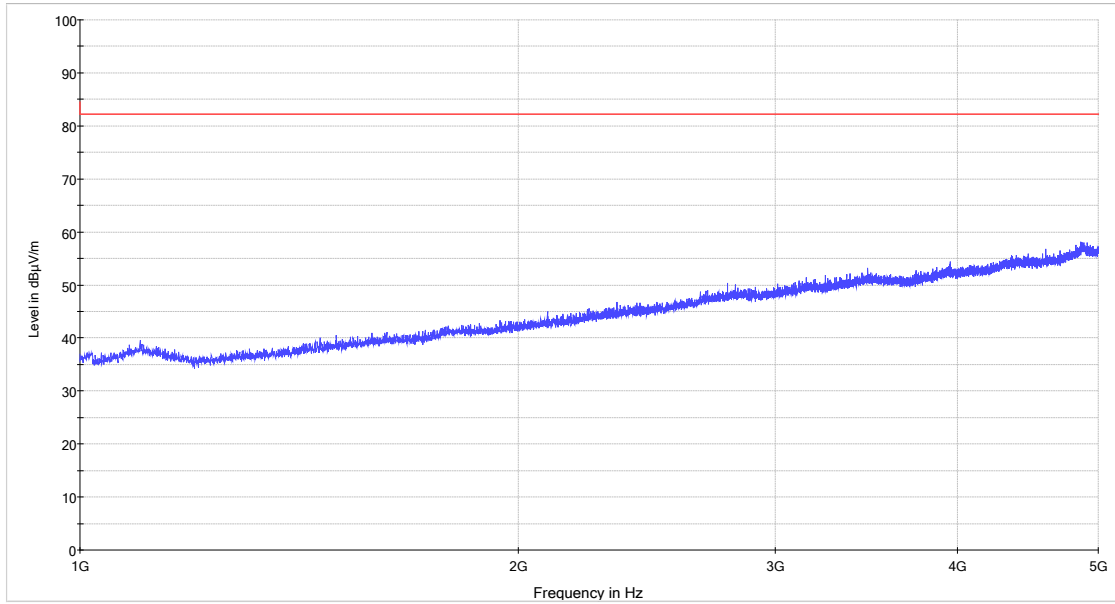
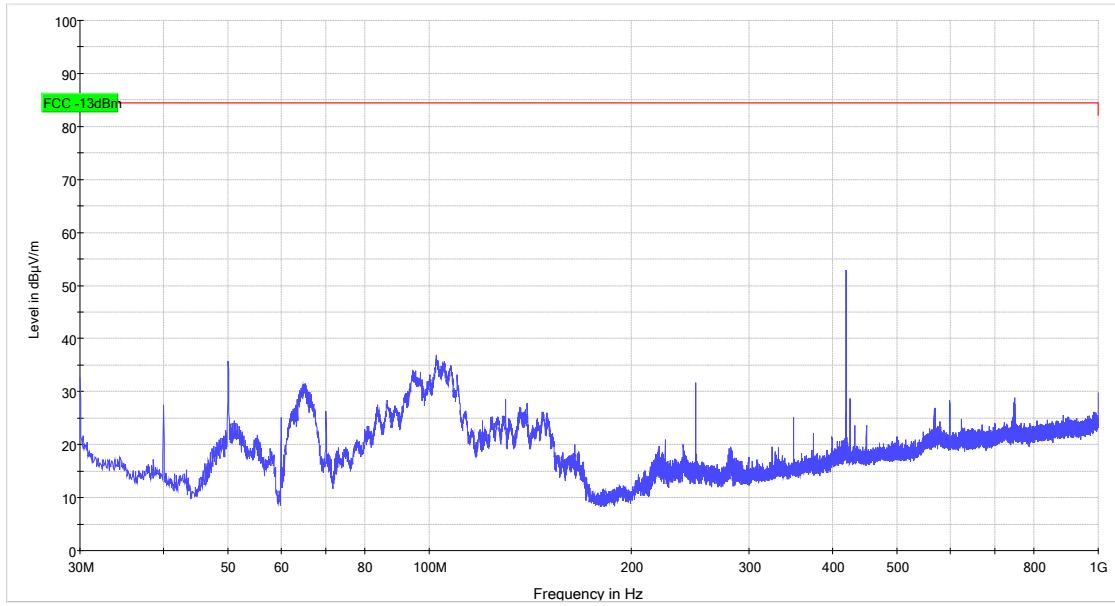

Downlink Middle Frequency; 420.0 MHz					
Emission	Frequency (MHz)	Emission level (dBm)	Limit (dBm)	Margin (dB)	Result
No Significant Emissions Within 10 dB of Limit					

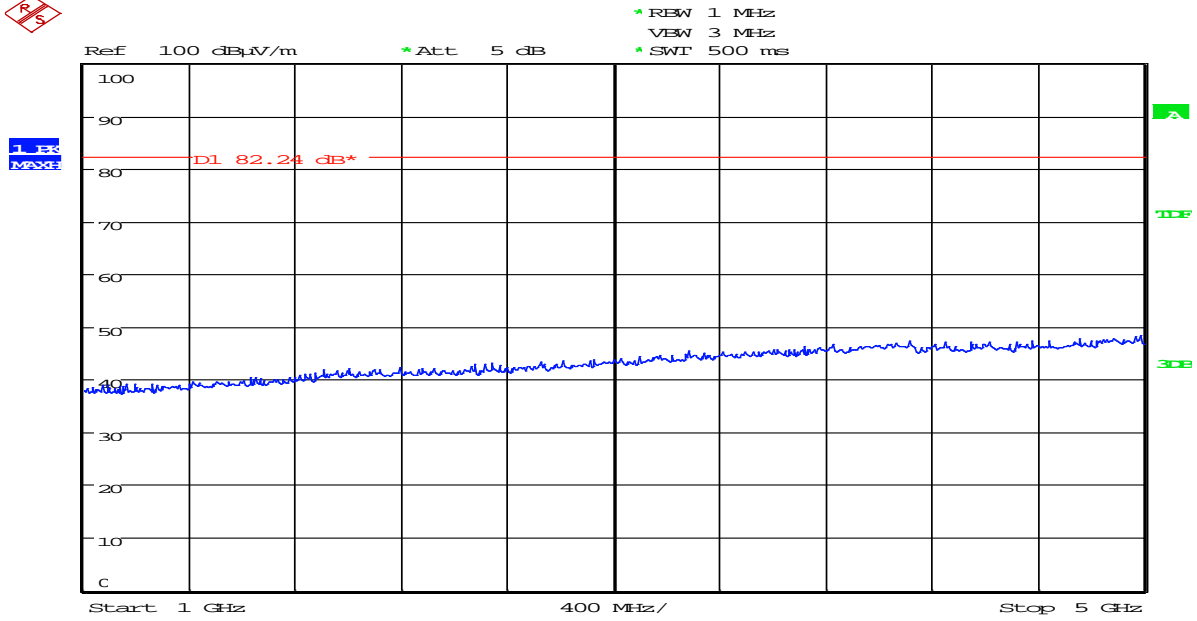
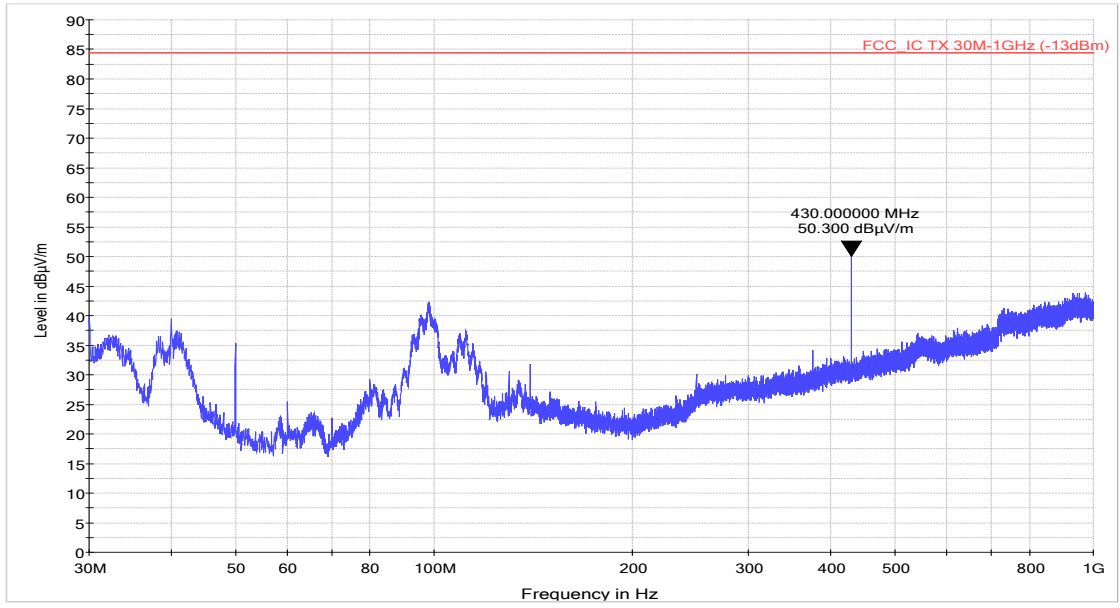

Downlink Top Frequency; 427.5 MHz					
Emission	Frequency (MHz)	Emission level (dBm)	Limit (dBm)	Margin (dB)	Result
No Significant Emissions Within 10 dB of Limit					

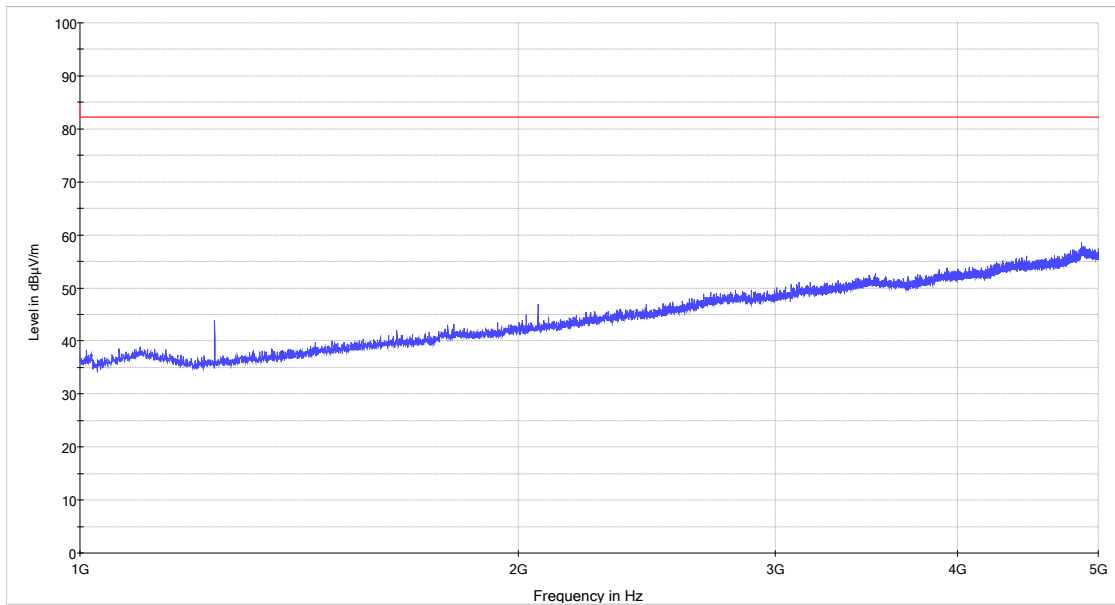
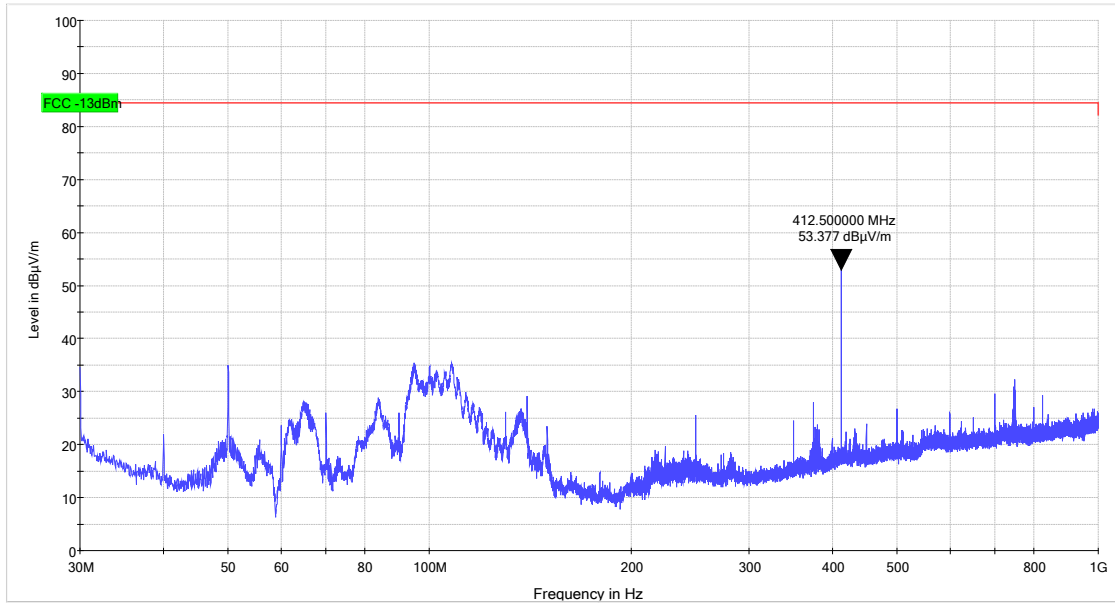

Uplink Low Frequency; 412.5 MHz					
Emission	Frequency (MHz)	Emission level (dBm)	Limit (dBm)	Margin (dB)	Result
No Significant Emissions Within 10 dB of Limit					

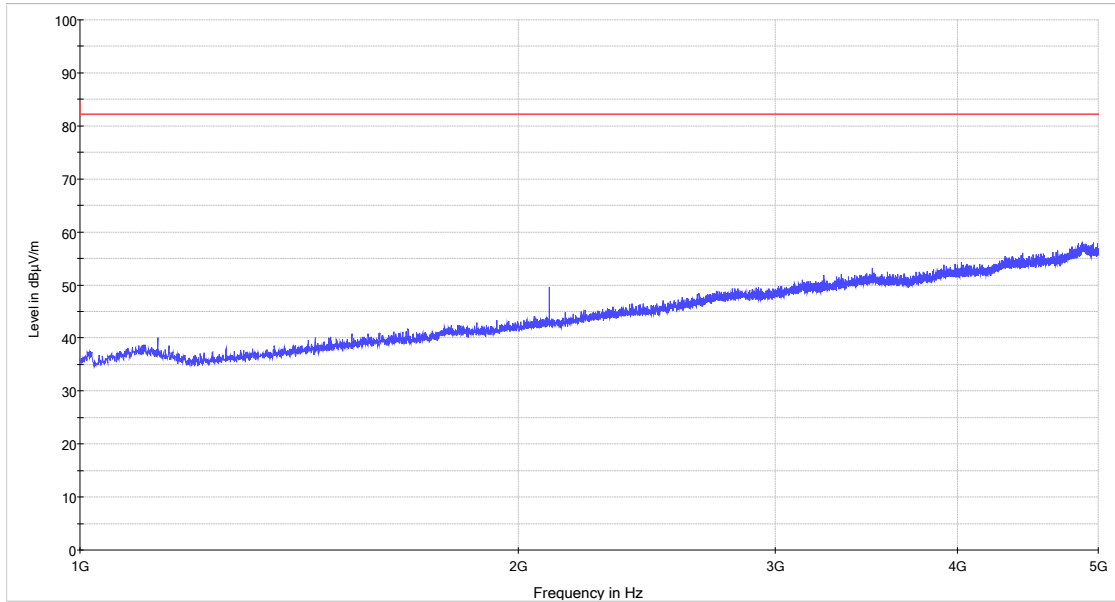
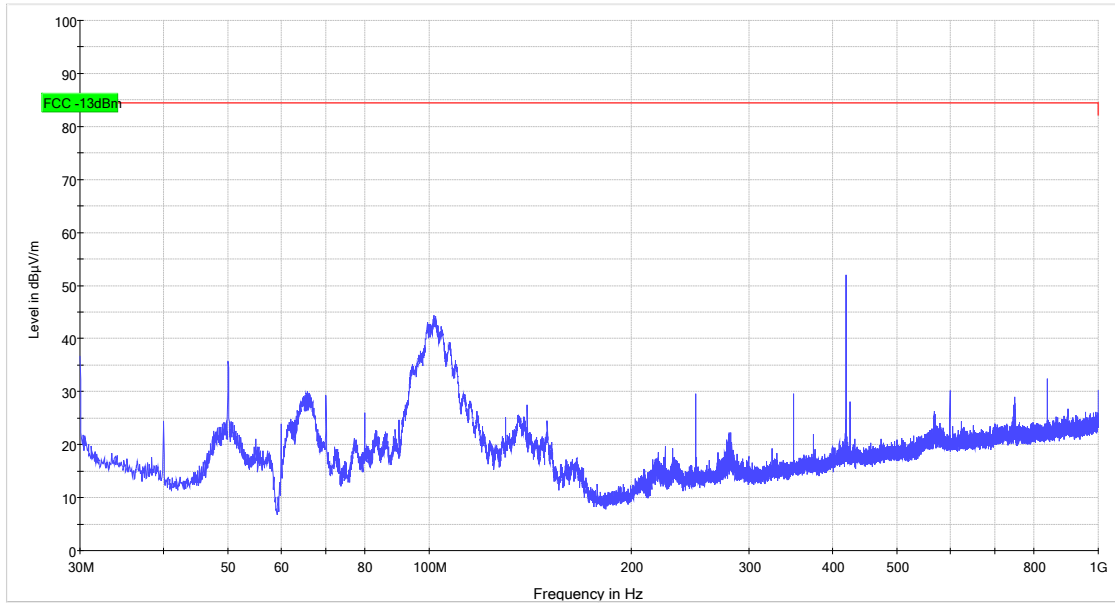

<i>Uplink Middle Frequency; 420.0 MHz</i>					
<i>Emission</i>	<i>Frequency (MHz)</i>	<i>Emission level (dBm)</i>	<i>Limit (dBm)</i>	<i>Margin (dB)</i>	<i>Result</i>
No Significant Emissions Within 10 dB of Limit					

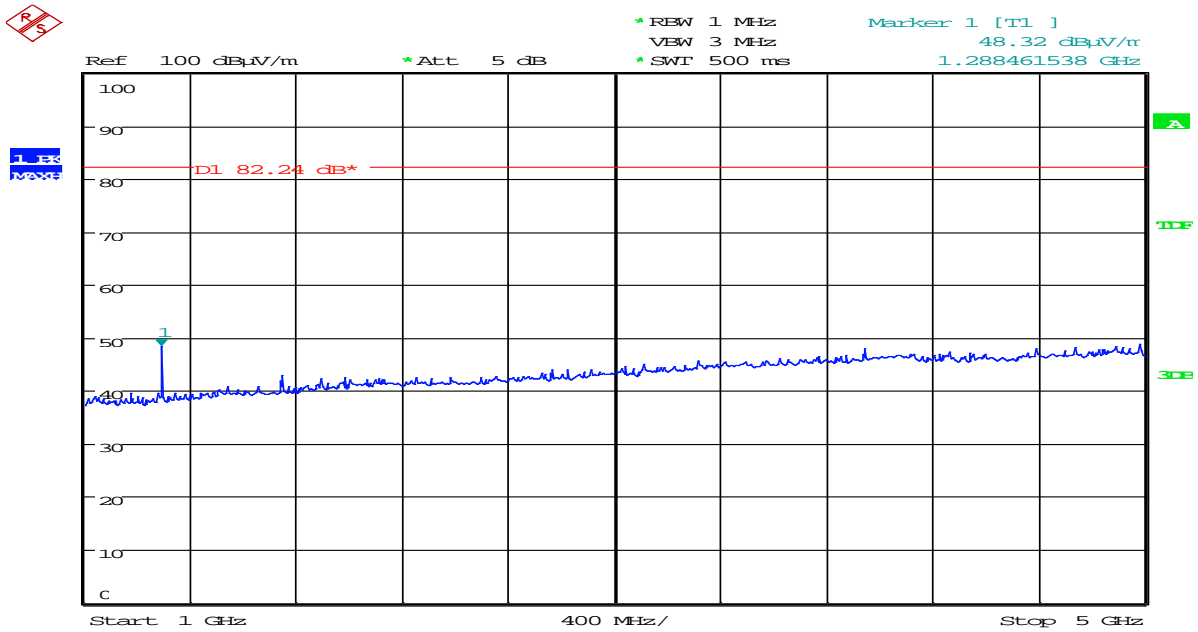
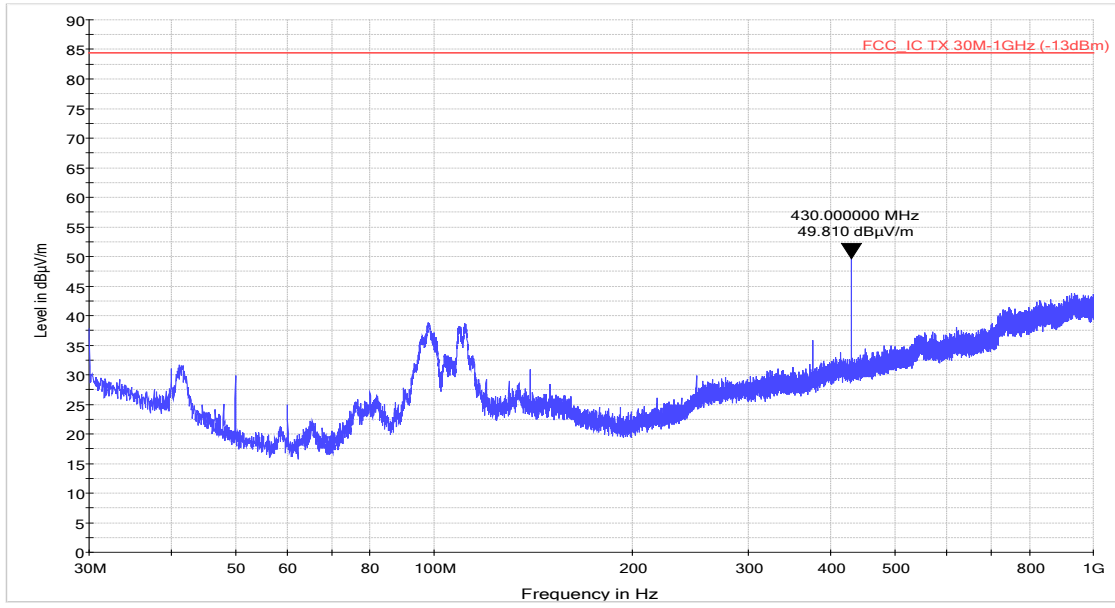

Uplink Top Frequency; 427.5 MHz					
Emission	Frequency (MHz)	Emission level (dBm)	Limit (dBm)	Margin (dB)	Result
No Significant Emissions Within 10 dB of Limit					

18 Measurement Uncertainty

For the test data recorded the following measurement uncertainty was calculated:

Radio Testing – General Uncertainty Schedule

All statements of uncertainty are expanded standard uncertainty using a coverage factor of 1.96 to give a 95% confidence where no required test level exists.

[1] Adjacent Channel Power

Uncertainty in test result = **1.86dB**

[2] Carrier Power

Uncertainty in test result (Power Meter) = **1.08dB**
 Uncertainty in test result (Spectrum Analyser) = **2.48dB**

[3] Effective Radiated Power

Uncertainty in test result = **4.71dB**

[4] Spurious Emissions

Uncertainty in test result = **4.75dB**

[5] Maximum frequency error

Uncertainty in test result (Frequency Counter) = **0.113ppm**
 Uncertainty in test result (Spectrum Analyser) = **0.265ppm**

[6] Radiated Emissions, field strength OATS 14kHz-18GHz Electric Field

Uncertainty in test result (14kHz – 30MHz) = **4.8dB**,
 Uncertainty in test result (30MHz – 1GHz) = **4.6dB**,
 Uncertainty in test result (1GHz – 18GHz) = **4.7dB**

[7] Frequency deviation

Uncertainty in test result = **3.2%**

[8] Magnetic Field Emissions

Uncertainty in test result = **2.3dB**

[9] Conducted Spurious

Uncertainty in test result – Up to 8.1GHz = **3.31dB**
 Uncertainty in test result – 8.1GHz – 15.3GHz = **4.43dB**
 Uncertainty in test result – 15.3GHz – 21GHz = **5.34dB**
 Uncertainty in test result – Up to 26GHz = **3.14dB**

[10] Channel Bandwidth

Uncertainty in test result = **15.5%**

[11] Amplitude and Time Measurement – Oscilloscope

Uncertainty in overall test level = **2.1dB**,
Uncertainty in time measurement = **0.59%**,
Uncertainty in Amplitude measurement = **0.82%**

[12] Power Line Conduction

Uncertainty in test result = **3.4dB**

[13] Spectrum Mask Measurements

Uncertainty in test result = **2.59% (frequency)**
Uncertainty in test result = **1.32dB (amplitude)**

[14] Adjacent Sub Band Selectivity

Uncertainty in test result = **1.24dB**

[15] Receiver Blocking – Listen Mode, Radiated

Uncertainty in test result = **3.42dB**

[16] Receiver Blocking – Talk Mode, Radiated

Uncertainty in test result = **3.36dB**

[17] Receiver Blocking – Talk Mode, Conducted

Uncertainty in test result = **1.24dB**

[18] Receiver Threshold

Uncertainty in test result = **3.23dB**

[19] Transmission Time Measurement

Uncertainty in test result = **7.98%**

19 Client Declaration

Technical explanation from client regarding frequency stability.

The wanted signal, mixed with a local oscillator down to an IF frequency where the filtering was done and then mixed back to original frequency with the same local oscillator. If you do the sums on that process any drift of the local oscillator cancels out, and the output always equals input frequency. LO drift has the effect of moving the filter centre frequency with respect to the signal so in an extreme case it could result in sideband cutting or even tuning to the next channel but still output = input.

In a digital repeater exactly the same thing happens with the up/down converter because the conversion process to IF is the same.
that drives the synthesisers.

The effect is the same. The exact filter frequency moves but again the drift cancels and always output = input.



DECLARATION

Element Materials Technology
100 Frobisher Business Park
Malvern
Worcestershire
WR14 1BX
UK

Declaration **2016-28**

Ref: NEO51-105SERIES

To whom it may concern

Axell Wireless Ltd states in the User Manual for the booster with FCC ID NEO51-105SERIES that only suitably qualified, professional people should undertake the installation of the product.

By only using suitably qualified, professional personnel to install the device, installation of the antenna can be maintained, ensuring compliance with FCC RF exposure requirements and FCC rule part §90.219(e)(1) – Ensuring that the Booster does not exceed the 5W EIRP requirement.

Date: 23/09/2016

A handwritten signature in black ink, appearing to read "bbarton", is written over a light grey circular stamp.

Brian Barton
Operations Support
Director

Axell Wireless