



TEST REPORT NO: RU1136/5795  
COPY NO: .2.....  
ISSUE NO: 1  
FCC ID: NE0-50-0780-800

**REPORT ON THE CERTIFICATION TESTING OF A  
Aerial Facilities Limited  
Cell Enhancer (NE0-50-0780-800)  
WITH RESPECT TO  
THE FCC RULES CFR 47, PART 90 Subpart S  
PRIVATE LAND MOBILE REPEATER**

TEST DATE: 10<sup>th</sup> September 2004 – 13<sup>th</sup> September 2004

TESTED BY: ..... J CHARTERS  
APPROVED BY: ..... P GREEN  
PRODUCT MANAGER  
EMC  
DATE: 11<sup>th</sup> October 2004.....

Distribution:

- Copy Nos:
1. Aerial Facilities Limited
  2. TCB: TRL Compliance Services Limited
  3. TRL EMC

THIS DOCUMENT MAY BE REPRODUCED ONLY IN ITS ENTIRETY AND WITHOUT CHANGE



## CONTENTS

	<b>PAGE</b>	
CERTIFICATE OF CONFORMITY & COMPLIANCE	3	
APPLICANT'S SUMMARY	4	
EQUIPMENT TEST CONDITIONS	5	
TESTS REQUIRED	5	
TEST RESULTS	6-53	
		<b>ANNEX</b>
PHOTOGRAPHS	A	
PHOTOGRAPH No. 1: Test setup		
PHOTOGRAPH No. 2: Test setup		
APPLICANT'S SUBMISSION OF DOCUMENTATION LIST	B	
 <b>Notes:</b>		
1. Component failure during test	YES	<input type="checkbox"/>
	NO	<input checked="" type="checkbox"/>
2. If Yes, details of failure:		
3. The facilities used for the testing of the product contain in this report are FCC Listed.		



**CERTIFICATE OF CONFORMITY & COMPLIANCE**

FCC IDENTITY: NE0-50-0780-800

PURPOSE OF TEST: CERTIFICATION

TEST SPECIFICATION: FCC RULES CFR 47, Part 90 Subpart S

TEST RESULT: Compliant to Specification

EQUIPMENT UNDER TEST: Cell Enhancer

EQUIPMENT TYPE: Private Land Mobile Repeater

MAXIMUM GAIN: +101.68 dB

MAXIMUM INPUT: Uplink -74 dBm, Downlink -63.4

MAXIMUM OUTPUT: Uplink +27.68 dBm, Downlink +18.98

ANTENNA TYPE: Not applicable

CHANNEL SPACING: 25 kHz

NUMBER OF CHANNELS: Channel No. Uplink 22 Downlink 22

FREQUENCY GENERATION: N/A

MODULATION TYPE: F3E

POWER SOURCE(s): +110 Vac

TEST DATE(s): 10<sup>th</sup> September 2004 – 13<sup>th</sup> September 2004

ORDER No(s): 26773

APPLICANT: Aerial Facilities Limited

ADDRESS: Aerial House  
Latimer Park, Latimer  
Chesham  
Buckinghamshire  
HP5 1TU  
United Kingdom

TESTED BY: ----- J CHARTERS

APPROVED BY: ----- P GREEN  
PRODUCT  
MANAGER EMC

**APPLICANT'S SUMMARY**

EQUIPMENT UNDER TEST (EUT): Cell Enhancer  
EQUIPMENT TYPE: Private Land Mobile Repeater  
PURPOSE OF TEST: CERTIFICATION  
TEST SPECIFICATION(s): FCC RULES CFR 47, Part 90 Subpart S  
TEST RESULT: COMPLIANT Yes   
No   
APPLICANT'S CATEGORY: MANUFACTURER   
IMPORTER   
DISTRIBUTOR   
TEST HOUSE   
AGENT   
APPLICANT'S ORDER No(s): 26773  
APPLICANT'S CONTACT PERSON(s): Mr Peter Bradfield  
E-mail address: Peterb@aerial.co.uk  
APPLICANT: Aerial Facilities Limited  
ADDRESS: Aerial House  
Latimer Park, Latimer  
Chesham  
Buckinghamshire  
HP5 1TU  
United Kingdom  
TEL: +44 (0)1494777020  
FAX: +44 (0)1494777002  
MANUFACTURER: Aerial Facilities Limited  
EUT(s) COUNTRY OF ORIGIN: United Kingdom  
TEST LABORATORY: TRL EMC  
UKAS ACCREDITATION No: 0728  
TEST DATE(s) 10<sup>th</sup> September 2004 – 13<sup>th</sup> September 2004  
TEST REPORT No: RU1136/5795

**EQUIPMENT TEST / EXAMINATIONS REQUIRED**

1.	TEST/EXAMINATION	RULE PART	APPLICABILITY	RESULT
	RF Power Output	90.205	Yes	Complies
	Audio Frequency Response	TIA EIA-603.3.2.6	N/A	N/A
	Audio Low-Pass Filter Response	TIA EIA-603.3.2.6	N/A	N/A
	Modulation Limiting	TIA EIA-603.3.2.6	N/A	N/A
	Occupied Bandwidth	90.210	Yes	Complies
	Spurious Emissions at Antenna Terminals	90.210	Yes	Complies
	Field Strength of Spurious Emissions	90.210	Yes	Complies
	Frequency Stability	90.213	N/A(note 1)	N/A
	Transient behaviour	90.214	N/A(note 2)	N/A

Notes:

1 The EUT does not contain signal generation circuitry, therefore the test was not performed.

2 The EUT is not a keyed carrier system, therefore the test was not performed.

2. Product Use: Private Land Mobile Repeater
3. Emission Designator: F3E
4. Temperatures: Ambient (Tnom) 21°C
5. Supply Voltages: Vnom +110 Vac  
 Note: Vnom voltages are as stated above unless otherwise shown on the test report page
6. Equipment Category: Single channel [ ]  
 Two channel [ ]  
 Multi-channel [X]
7. Channel spacing: Narrowband [X] 25 kHz  
 Wideband [ ]
8. Test Location TRL Compliance Services  
 Up Holland [X]  
 Long Green [ ]
9. Modifications made during test program No modifications were performed.

**COMPLIANCE TESTS**

**AMPLIFIER GAIN – CONDUCTED – PART 2.1046 – UPLINK**

Ambient temperature = 26°C Radio Laboratory  
 Relative humidity = 44%  
 Supply voltage = +110 Vac  
 Channel number = See test results

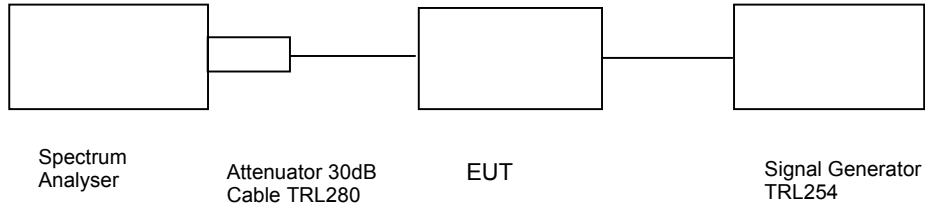

Frequency MHz	Signal Generator input level dBm	Cable & Attenuator loss dB	Level at Spectrum Analyser dBm	Gain dB	Gain after 20dB input level increase dBm
810.0 MHz	-74	32.08	-5.9	100.18	113.08
817.0 MHz	-74	32.08	-4.4	101.68	113.80
824.0 MHz	-74	32.08	-6.5	99.58	114.82

Notes:

1. The level of the signal generator takes into consideration the loss from the cable.
2. The signal generator input was increased by 20dBs and the level of the output signal remeasured

TYPE OF EQUIPMENT	MAKER/SUPPLIER	MODEL No	SERIAL No	TRL No	ACTUAL EQUIPMENT USED
SPECTRUM ANALYSER	RHODE & SCHWARZ	ESIB 7	100 182	630	<b>X</b>
ATTENUATOR	AFL	10-002530	8616	N/A	<b>X</b>
CABLE	ROSENBERGER	MICRO COAX	N/A	280	<b>X</b>
SIGNAL GENERATOR	MARCONI	2042	119562/021	254	<b>X</b>

**AMPLIFIER INTERMODULATION SPURIOUS EMISSIONS – CONDUCTED – PART 2.1053– UPLINK**

Ambient temperature = 26°C  
Relative humidity = 50%  
Supply voltage = +110 Vac

Radio Laboratory

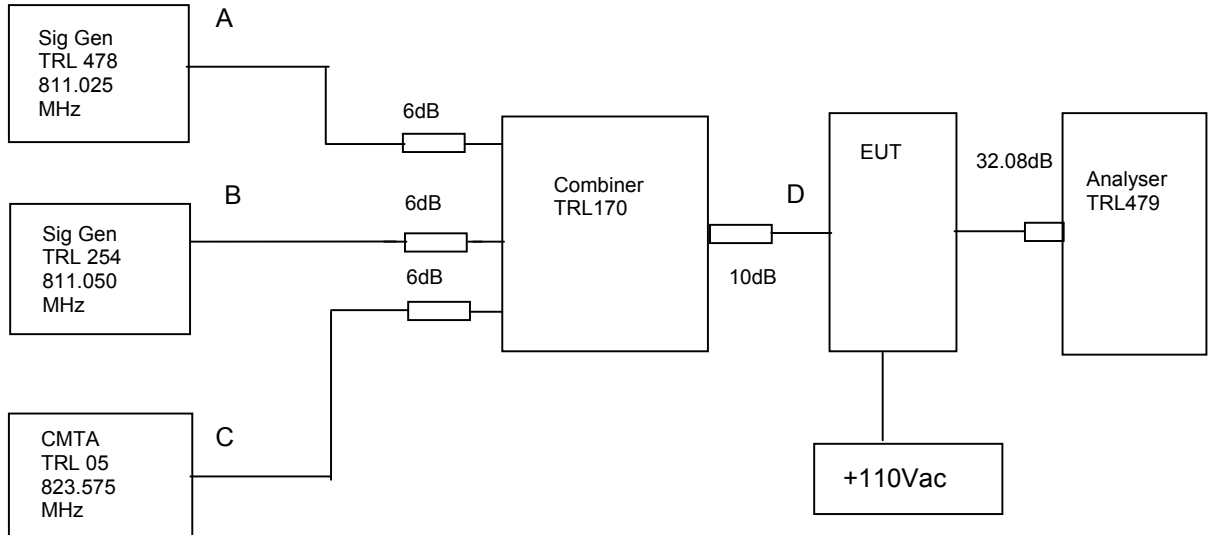

The intermodulation and spurious products were measured with the amplifier operating at maximum gain. A three tone test was conducted using the equipment as above. The input power level was adjusted so the level at point D was the maximum input of -74dBm. The cable and attenuator loss between the EUT and the spectrum analyser was 32.08dB. This loss was taken into account by adjusting the analysers level offset.

Sweep data is shown on the next page:

## Intermodulation Inband

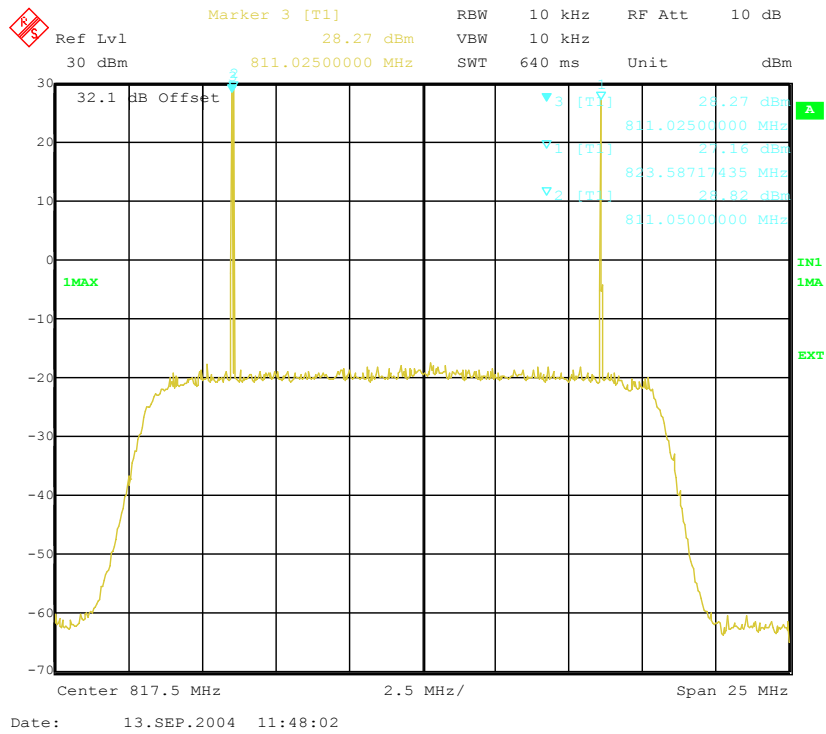

The above plot shows that all products (designated by ★) are at least 40dB below the fundamentals.



### Intermodulation Wideband

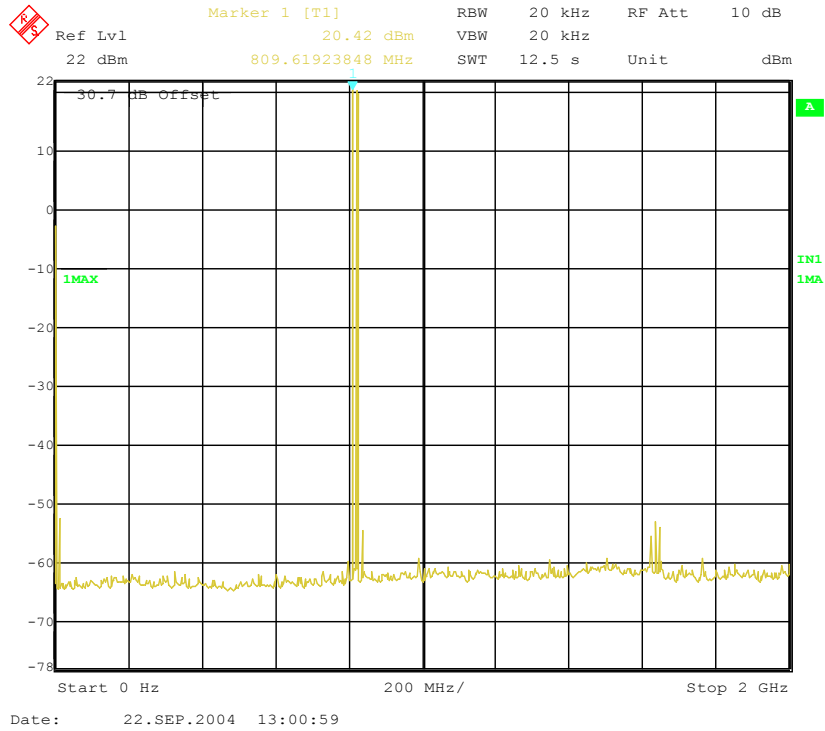

The above plot shows that there are no products outside the bands.

#### Test equipment used for intermodulation test

TYPE OF EQUIPMENT	MAKER/SUPPLIER	MODEL No	SERIAL No	TRL No	ACTUAL EQUIPMENT USED
SPECTRUM ANALYSER	RHODE & SCHWARZ	ESIB 7	100 182	630	<b>X</b>
SIGNAL GENERATOR	MARCONI	2042	119562/021	254	<b>X</b>
CMTA	ROHDE & SCHWARZ	CMTA52	894715/033	05	<b>X</b>
SIGNAL GENERATOR	ROHDE & SCHWARZ	SMR 20	834671/003	478	<b>X</b>
COMBINER	ELCOM	RC-4-50	N/A	170	<b>X</b>

**TRANSMITTER TESTS**

**AMPLIFIER MODULATED CHANNEL TEST – CONDUCTED – Part 2.1049– UPLINK**

Ambient temperature = 24°C Radio Laboratory  
 Relative humidity = 51%  
 Supply voltage = +110 Vac  
 Channel number = See test results

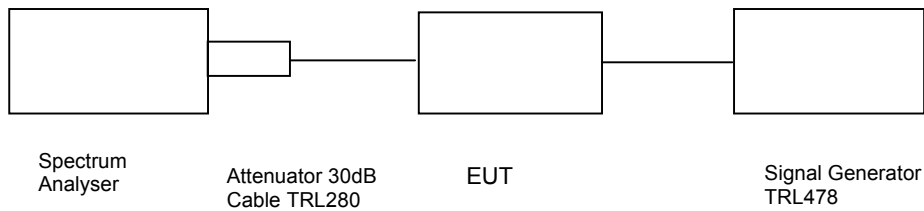

This test was performed to show that the amplifier does not alter the input signal in any way. The input signal was set to the maximum input level (-74dBm) and modulated with a 2500Hz tone. The plots show the signal measured at the signal generator and the signal measured at the output of the EUT.

Note: The cables and attenuators had the following losses.

1. Cable TRL280 and attenuator 32.08dB
2. Cable between signal generator and EUT 1.72dB

The test equipment used for the Transmitter Modulated Channel tests is shown below:

TYPE OF EQUIPMENT	MAKER/SUPPLIER	MODEL No	SERIAL No	TRL No	ACTUAL EQUIPMENT USED
SPECTRUM ANALYSER	RHODE & SCHWARZ	ESIB 7	100 182	630	<b>X</b>
ATTENUATOR	AFL	10-002530	8616	N/A	<b>X</b>
CABLE	ROSENBERGER	MICRO COAX	N/A	280	<b>X</b>
SIGNAL GENERATOR	MARCONI	2042	119562/021	254	<b>X</b>

810.0 MHz Signal generator deviation set to 2.5kHz

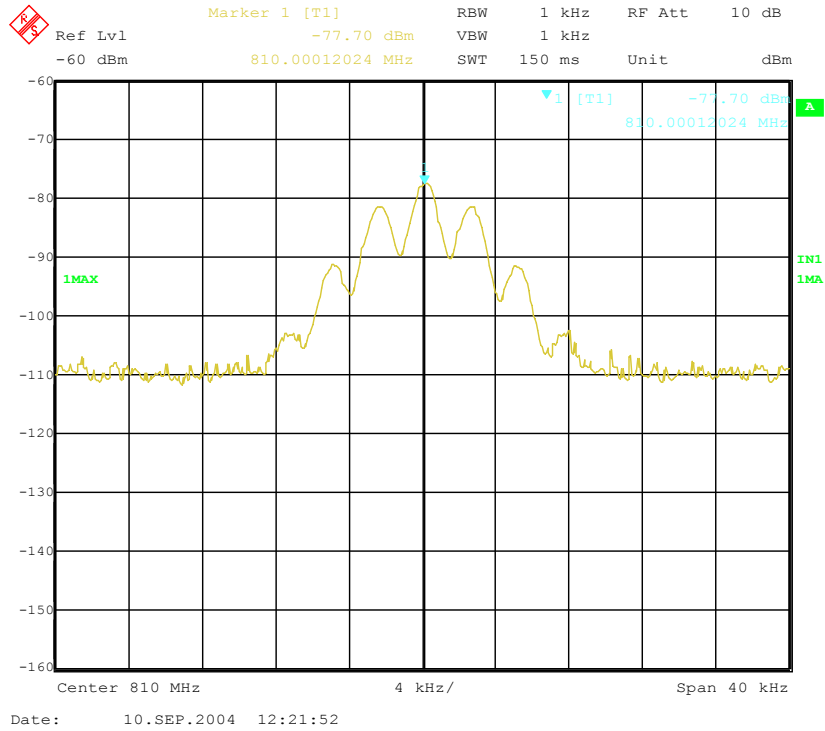

810.0 MHz Signal generator and EUT deviation set to 2.5kHz

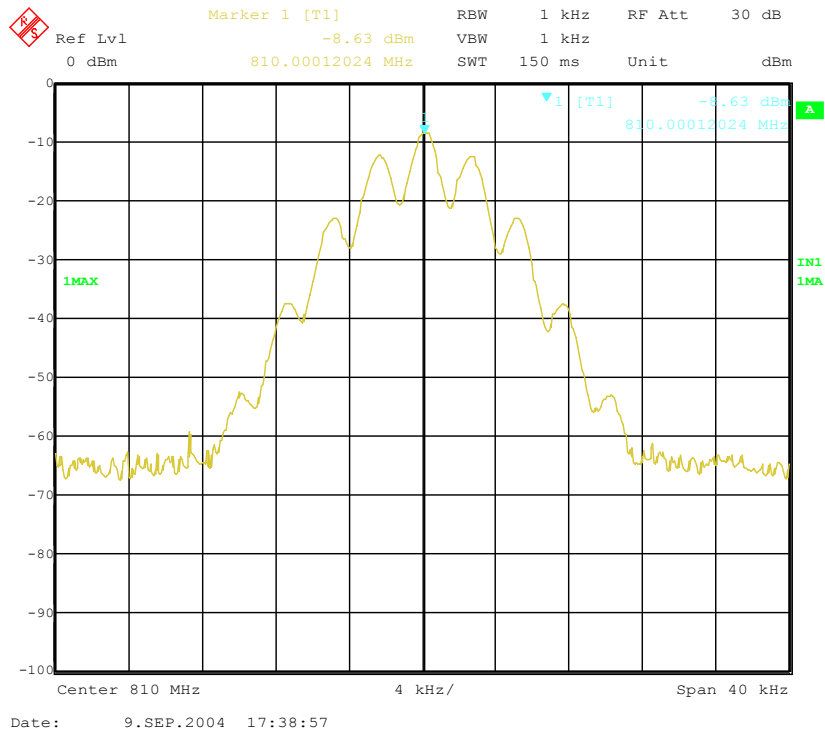

The above plots depicting the output wawshape show no measurable distortion visible. When compared to the input signal.

817.0 MHz Signal generator deviation set to 2.5kHz

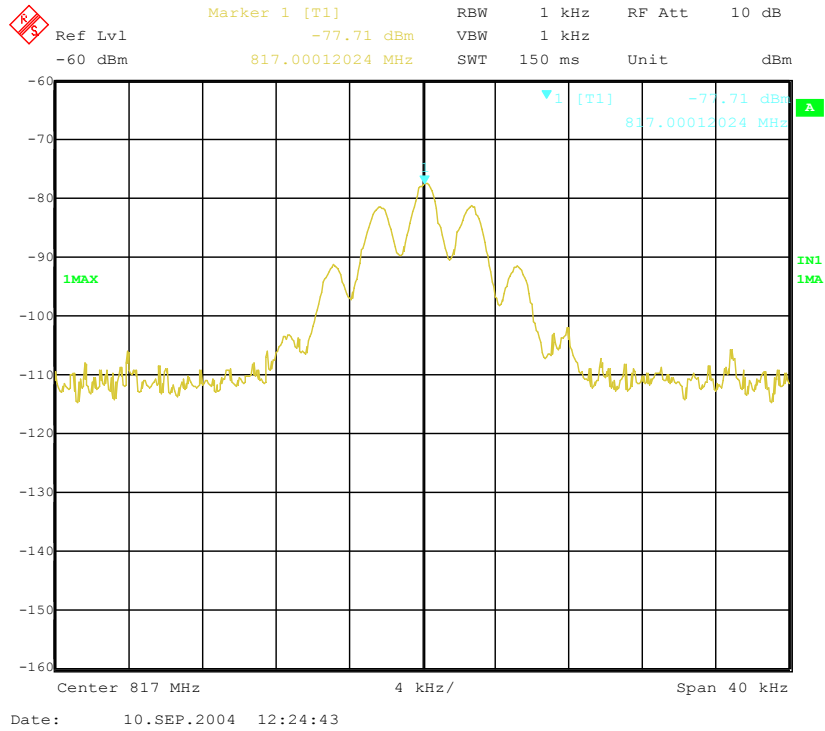

817.0 MHz Signal generator and amplifier deviation set to 2.5kHz

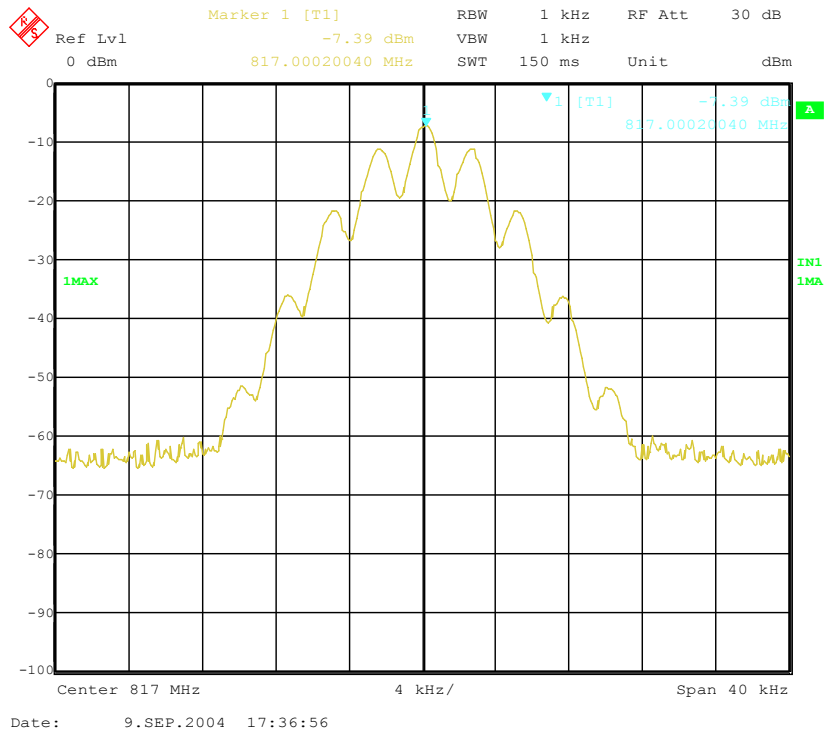

The above plots depicting the output waweshape show no measurable distortion visible. When compared to the input signal.

824.0 MHz Signal generator deviation set to 2.5kHz

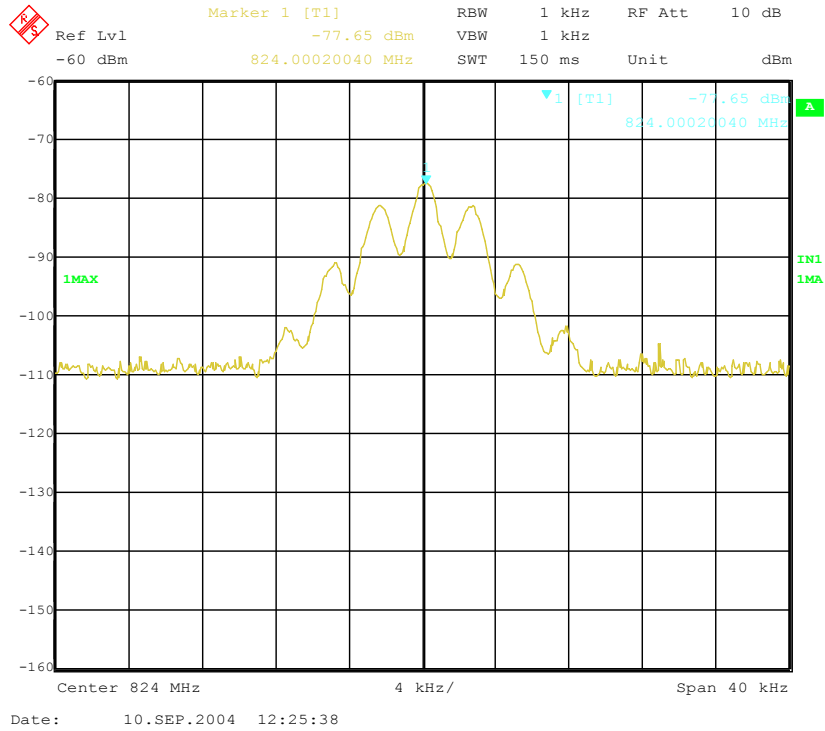

824.0 MHz Signal generator deviation set to 2.5kHz

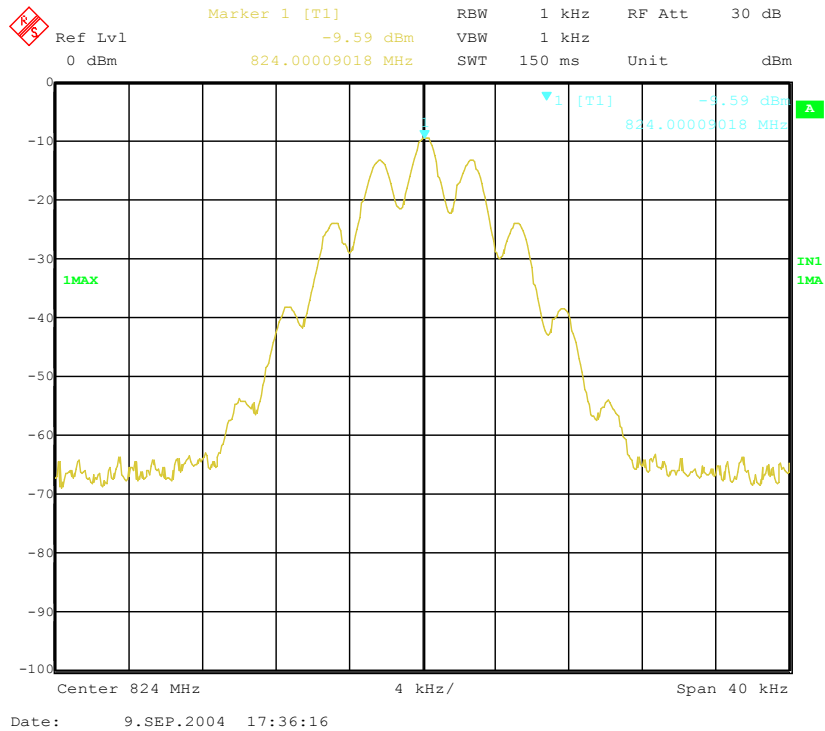

The above plots depicting the output wavsshape show no measurable distortion visible. When compared to the input signal.

**TRANSMITTER TESTS**

**AMPLIFIER SPURIOUS EMISSIONS – CONDUCTED – Part 2.1051– UPLINK**

Ambient temperature = 23°C  
 Relative humidity = 51%  
 Supply voltage = +110 Vac

Radio Laboratory  
 Test Signal = F3E

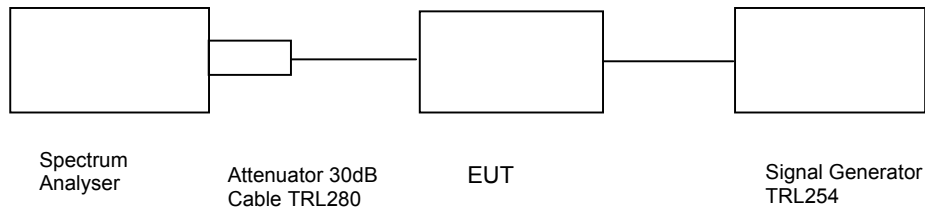

The test was set up as per the diagram. The level at the input was adjusted to compensate for the loss of the interconnecting cable. The unit was tested operating at maximum power and on three test frequencies.

The Spurious limit was calculated as follows:

On any frequency removed from the assigned frequency by more that 250% of the authorised bandwidth

At least 43 + 10 log PdB

$$(10\log P_{\text{watts}}) - (43 + 10\log (P_{\text{watts}} * 1000)) = \text{LIMIT} = -13 \text{ dBm}$$

The test equipment used for the Transmitter Conducted Emissions:

TYPE OF EQUIPMENT	MAKER/ SUPPLIER	MODEL No	SERIAL No	TRL No	ACTUAL EQUIPMENT USED
SPECTRUM ANALYSER	RHODE & SCHWARZ	ESIB 7	100 182	630	<b>X</b>
ATTENUATOR	AFL	10-002530	8616	N/A	<b>X</b>
CABLE	ROSENBERGER	MICRO COAX	N/A	280	<b>X</b>
SIGNAL GENERATOR	MARCONI	2042	119562/021	254	<b>X</b>
SPECTRUM ANALYSER	ANRITSU	MS2665C	MT26089	479	<b>X</b>

Conducted emissions 810.0 MHz

0 - 3GHz

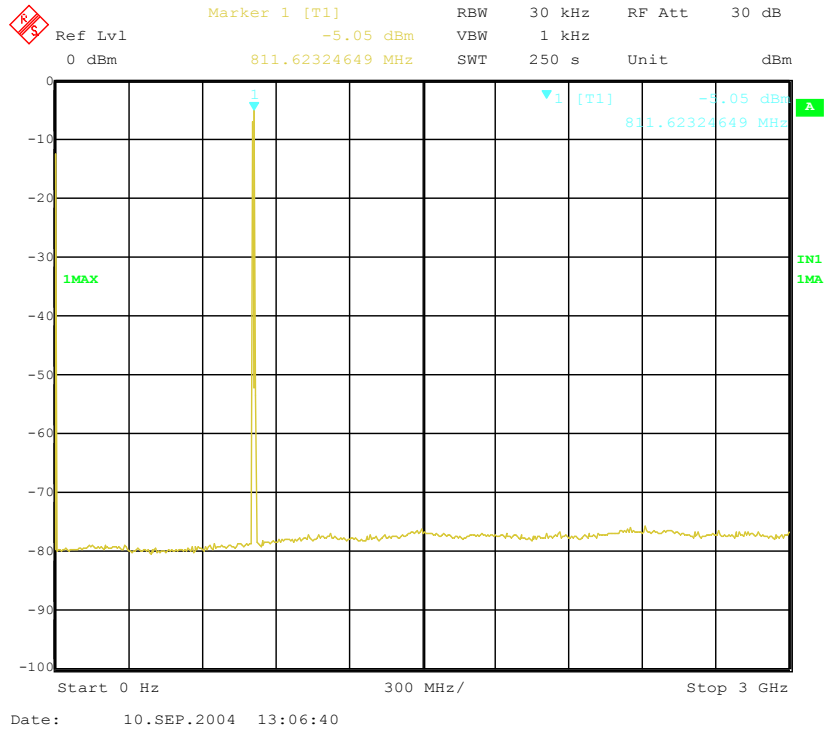

Conducted emissions 810.0 MHz

3 - 7GHz

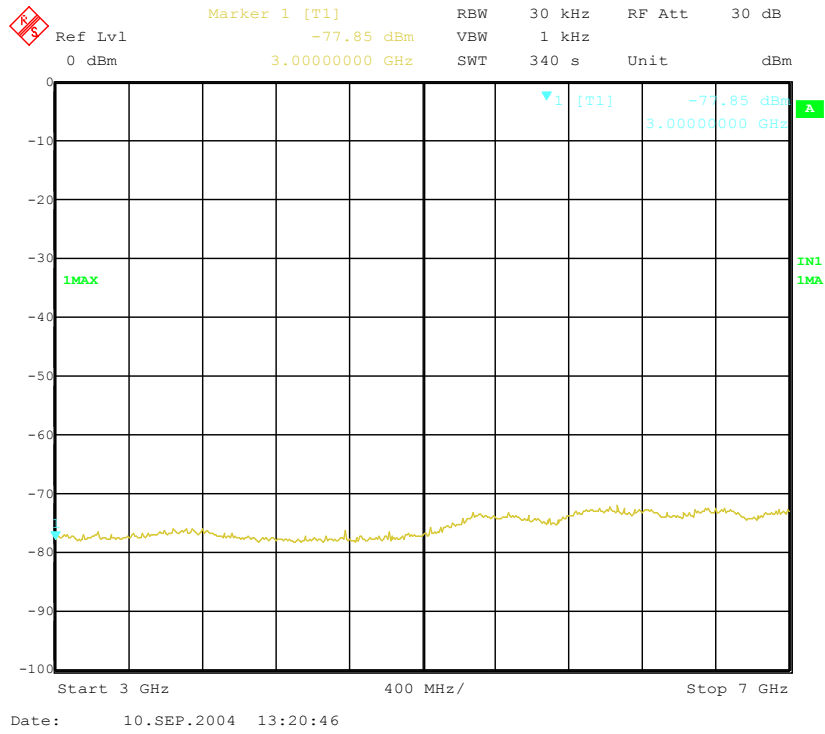

Conducted emissions 810.0 MHz

7 - 10GHz

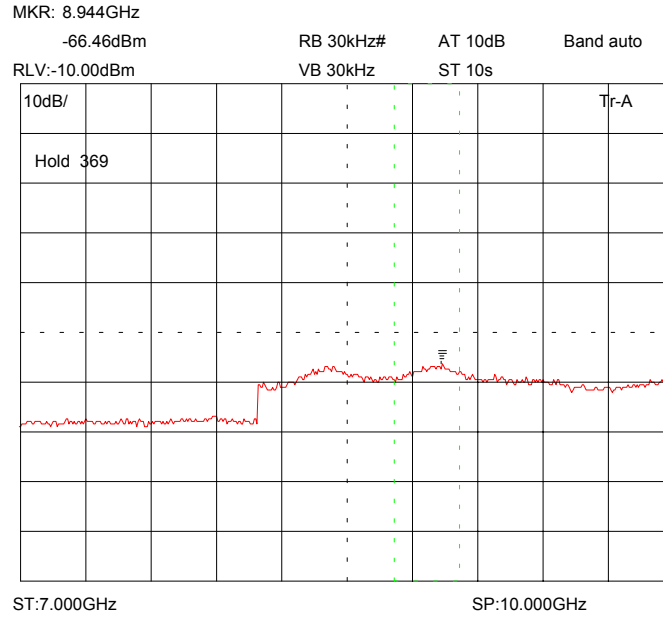



Conducted emissions 817.0 MHz

0 - 3GHz

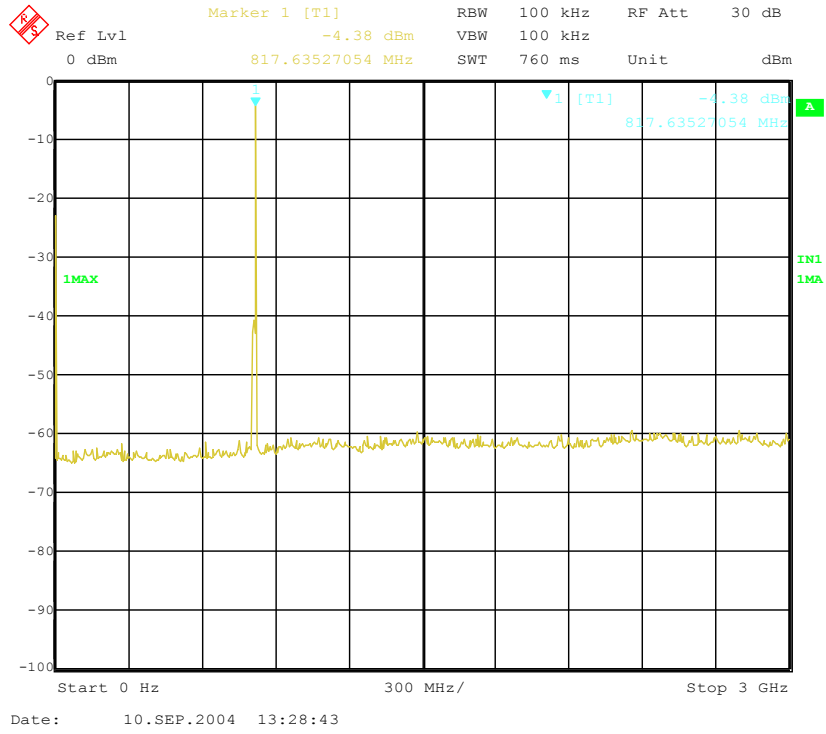

Conducted emissions 817.0 MHz

3 - 7GHz

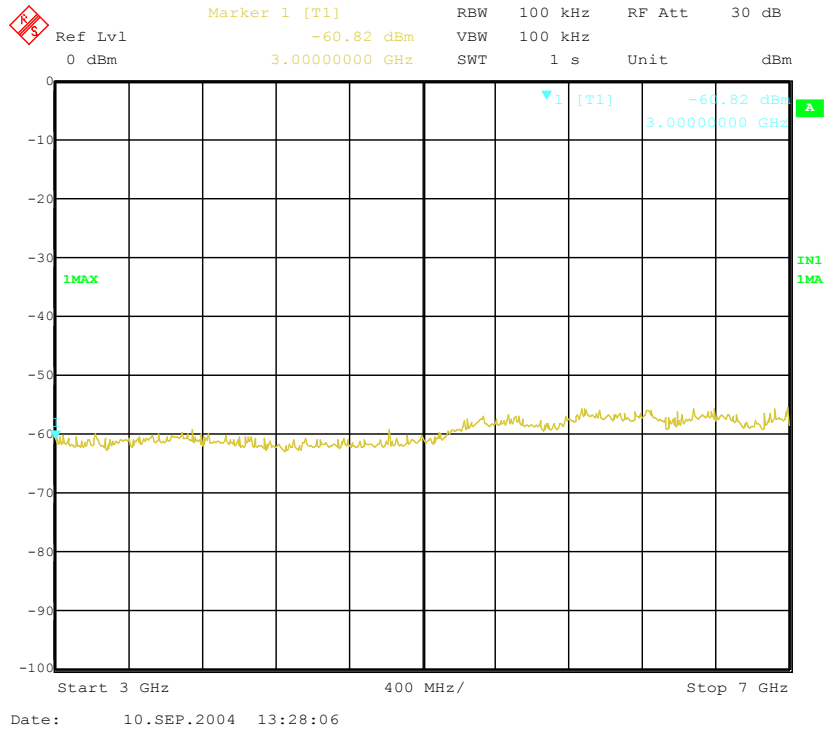

Conducted emissions 817.0 MHz

7 - 10GHz

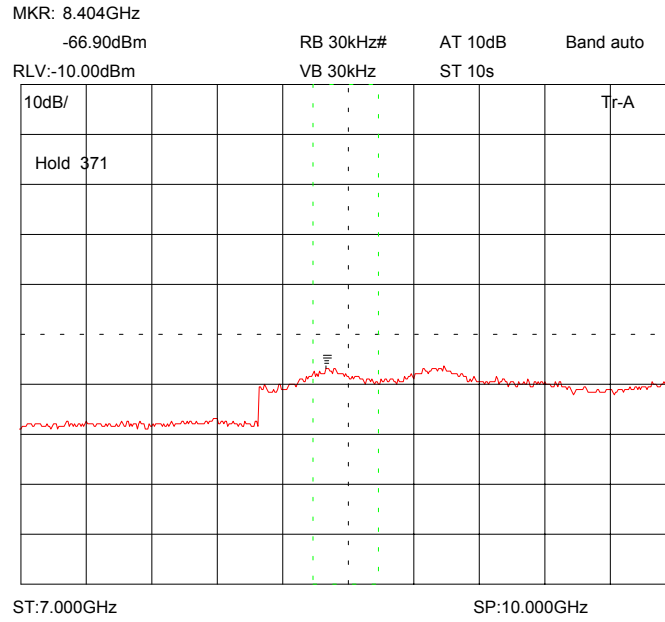

Conducted emissions 824.0 MHz

0 - 3GHz

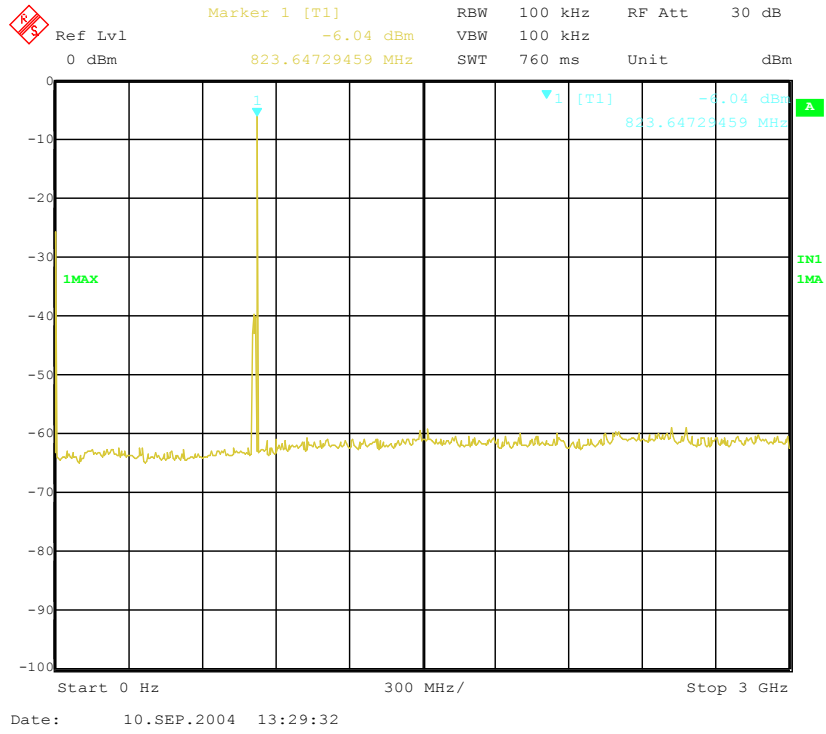

Conducted emissions 824.0 MHz

3 - 7GHz

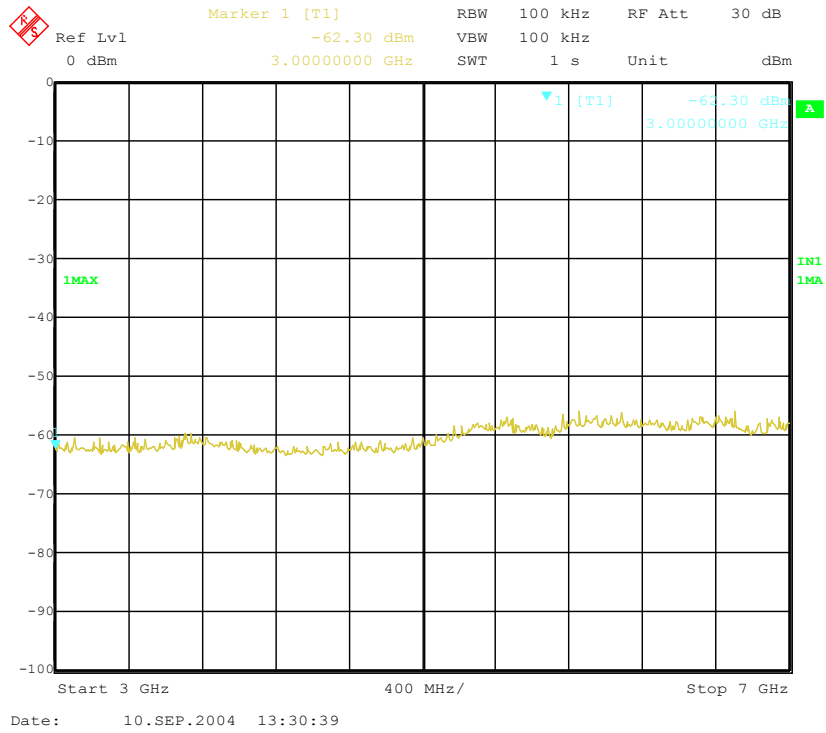

Conducted emissions 824.0 MHz

7 - 10GHz

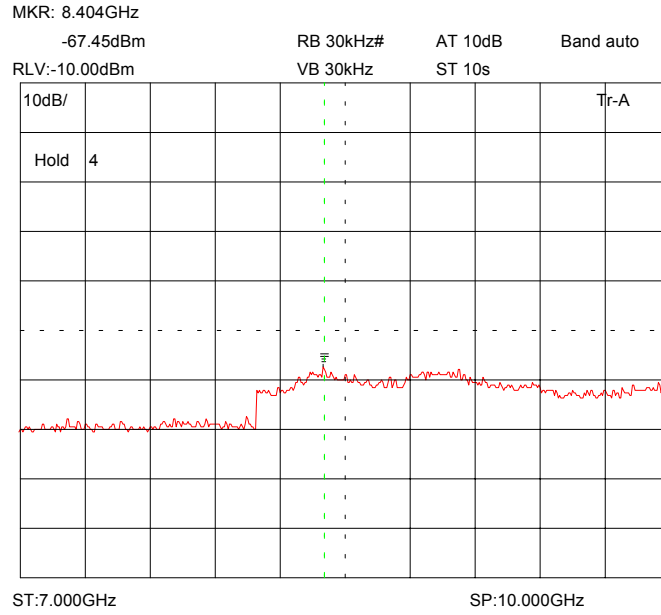

## TRANSMITTER TESTS

### AMPLIFIER SPURIOUS EMISSIONS – RADIATED – Part 2.1053– UPLINK

Ambient temperature = 26°C  
 Relative humidity = 44%  
 Conditions = OATS  
 Supply voltage = +110 Vac  
 Supply Frequency = N/A

Test Signal = F3E

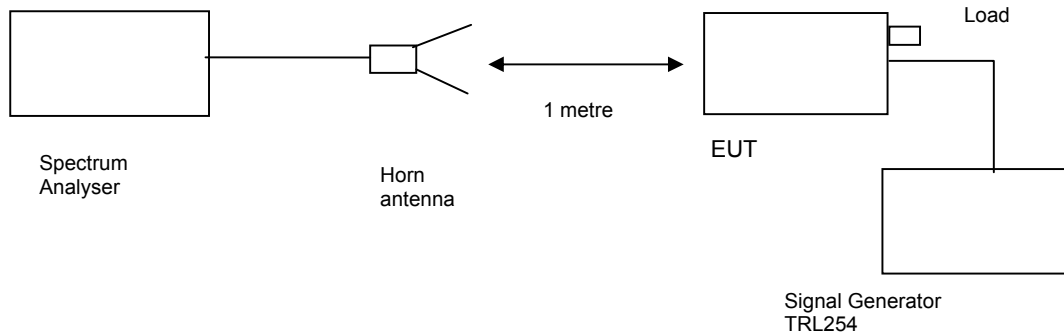

The test was set up as per the diagram. The level at the input was adjusted to compensate for the loss of the interconnecting cable. The unit was tested operating maximum power on three test frequencies with a 50 ohm load on the output. The unit was also tested with the signal generator replaced by another 50ohm load.

The Spurious limit was calculated as follows:

On any frequency removed from the assigned frequency by more that 250% of the authorised bandwidth

At least  $43 + 10 \log P_{dB}$

$$(10 \log P_{\text{watts}}) - (43 + 10 \log (P_{\text{watts}} * 1000)) = \text{LIMIT} = -13 \text{ dBm}$$

The test equipment used for the Transmitter Spurious Emissions:

TYPE OF EQUIPMENT	MAKER/SUPPLIER	MODEL No	SERIAL No	TRL No	ACTUAL EQUIPMENT USED
SPECTRUM ANALYSER	RHODE & SCHWARZ	ESIB 7	100 182	630	<b>X</b>
HORN	EMCO	3115	9010-3581	139	<b>X</b>
50Ω LOAD	RHODE & SCHWARZ	200.0019.55	300804/32	UH227	<b>X</b>
CABLE	ROSENBERGER	MICRO COAX	N/A	280	<b>X</b>
SIGNAL GENERATOR	MARCONI	2042	119388/021	254	<b>X</b>
SPECTRUM ANALYSER	ANRITSU	MS2665C	MT26089	479	<b>X</b>

Radiated emissions 810.0 MHz

30 MHz -1 GHz

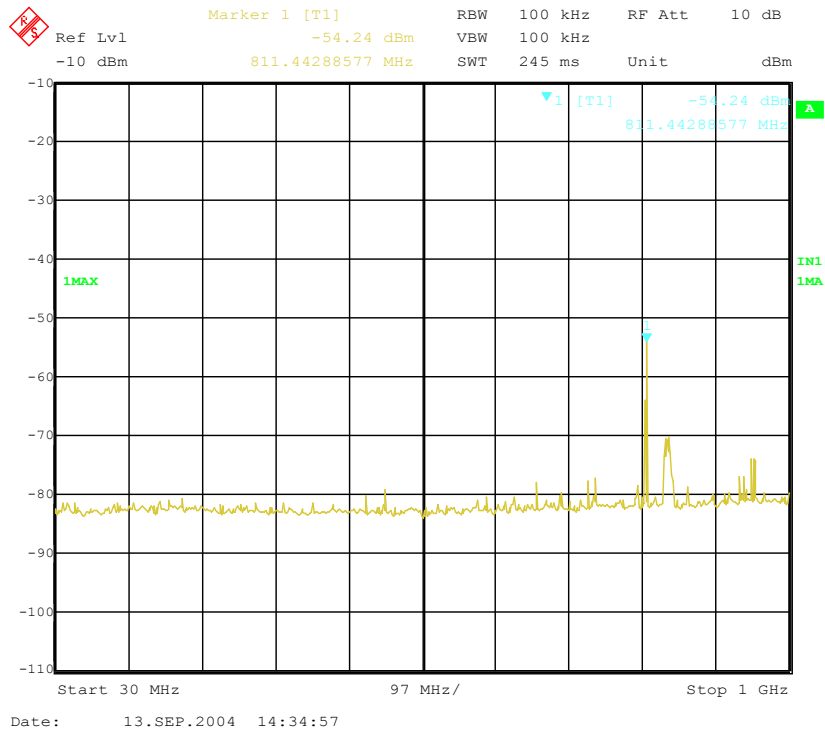

Radiated emissions 810.0 MHz

1-3GHz

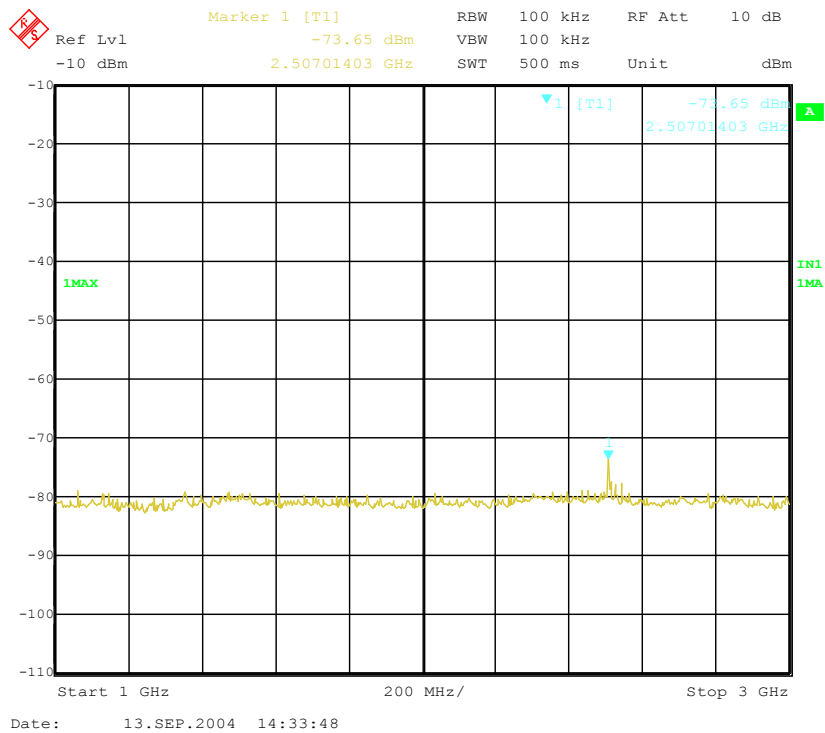

The above test results show that there were no emissions within 20dBs of the -13dBm limit.

Radiated emissions 810.0 MHz

3-7GHz

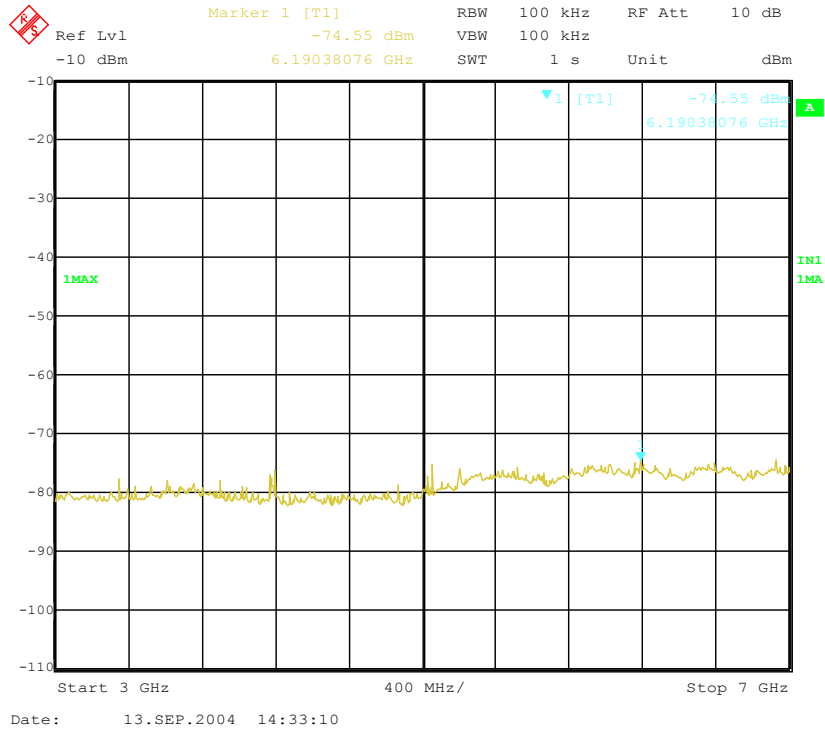

Radiated emissions 810.0 MHz

7-10GHz

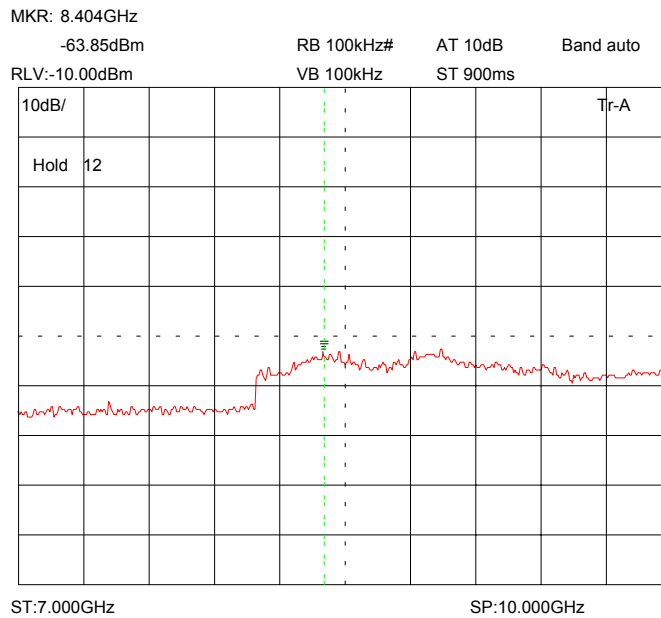

The above test results show that there were no emissions within 20dBs of the -13dBm limit.

Radiated emissions 817.0 MHz

30 MHz -1GHz

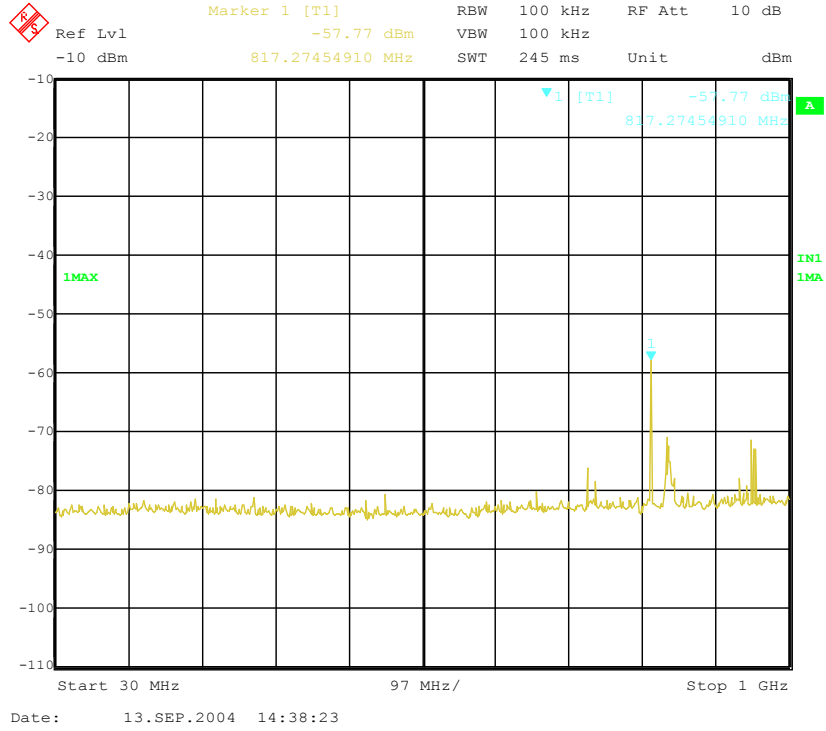

Radiated emissions 817.0 MHz

1-3GHz

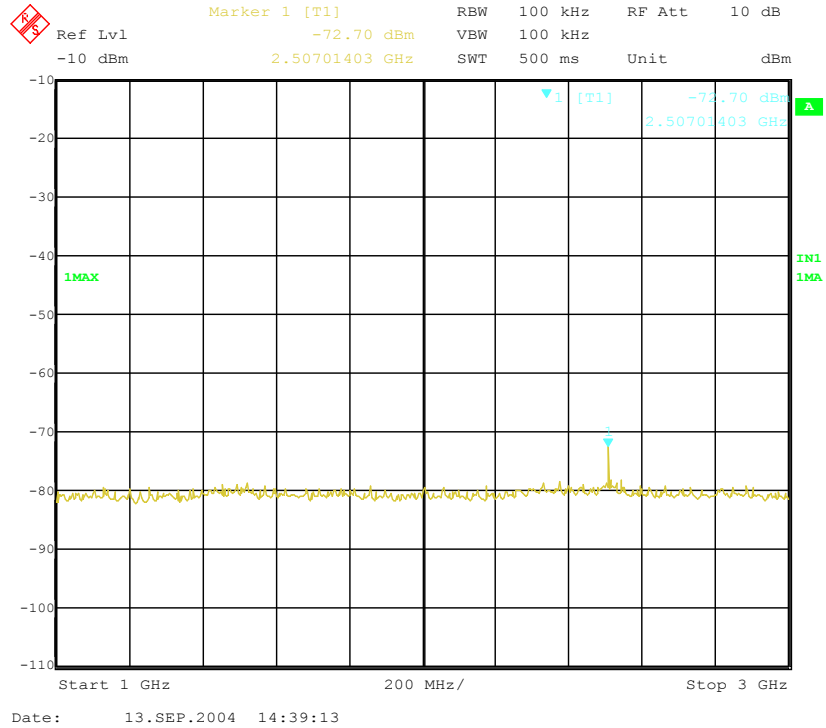

The above test results show that there were no emissions within 20dBs of the -13dBm limit.



Radiated emissions 817.0 MHz

3-7GHz

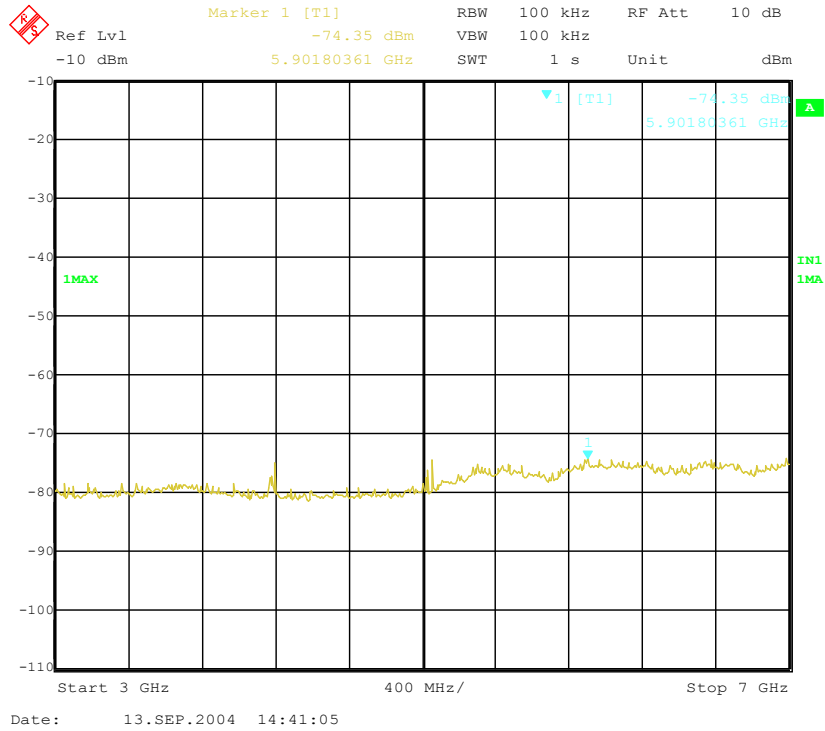

Radiated emissions 817.0 MHz

7-10GHz

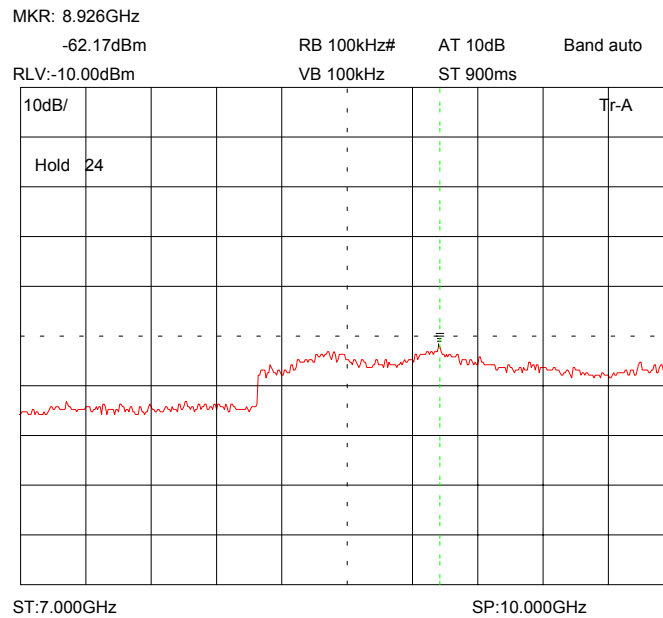

The above test results show that there were no emissions within 20dBs of the -13dBm limit.

Radiated emissions 824.0 MHz

30MHz -1GHz

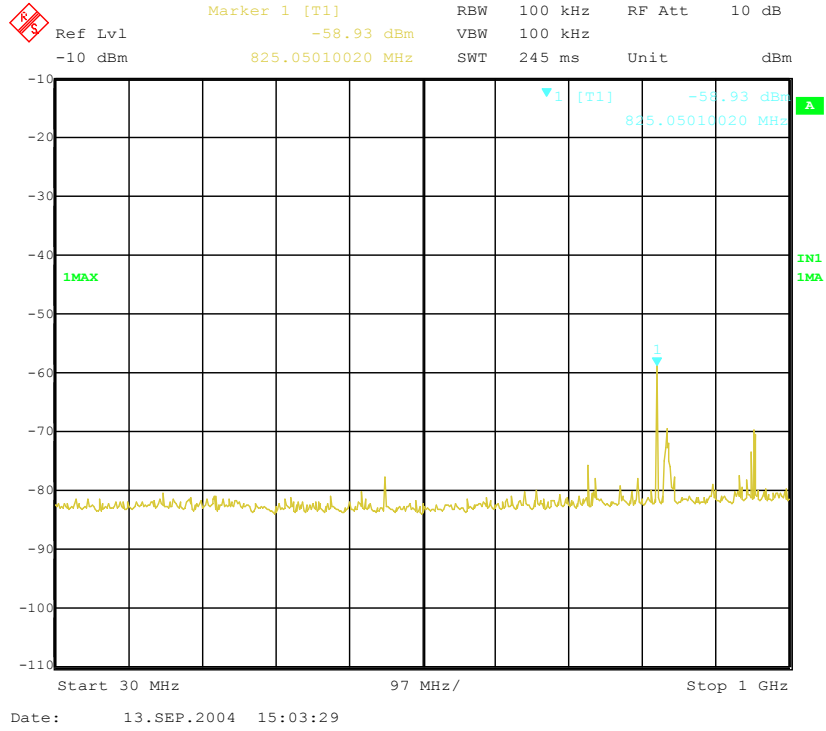

Radiated emissions 824.0 MHz

1-3GHz

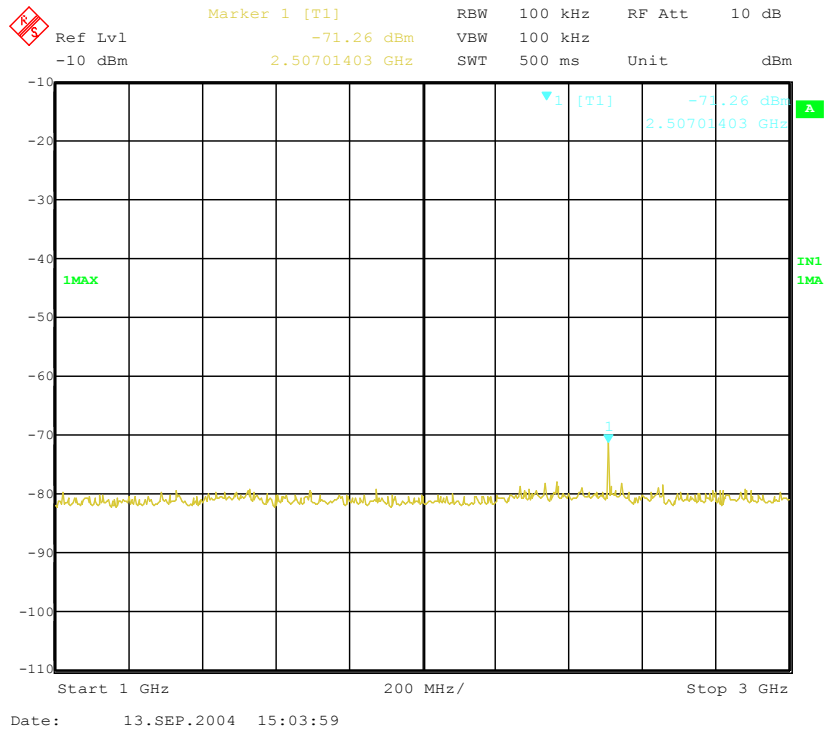

The above test results show that there were no emissions within 20dBs of the -13dBm limit.

Radiated emissions 824.0 MHz

3-7GHz

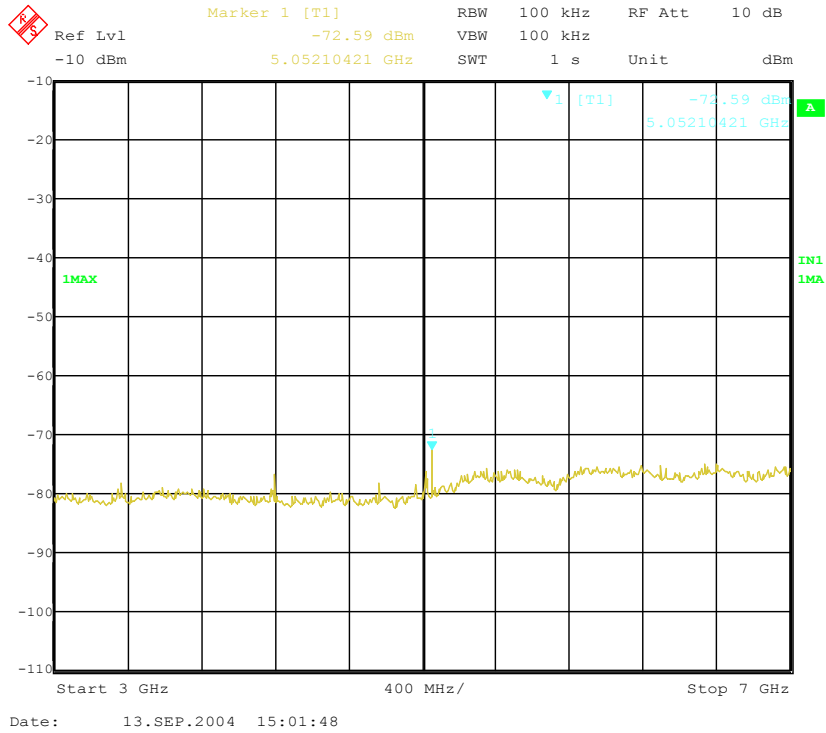

Radiated emissions 824.0 MHz

7-10GHz

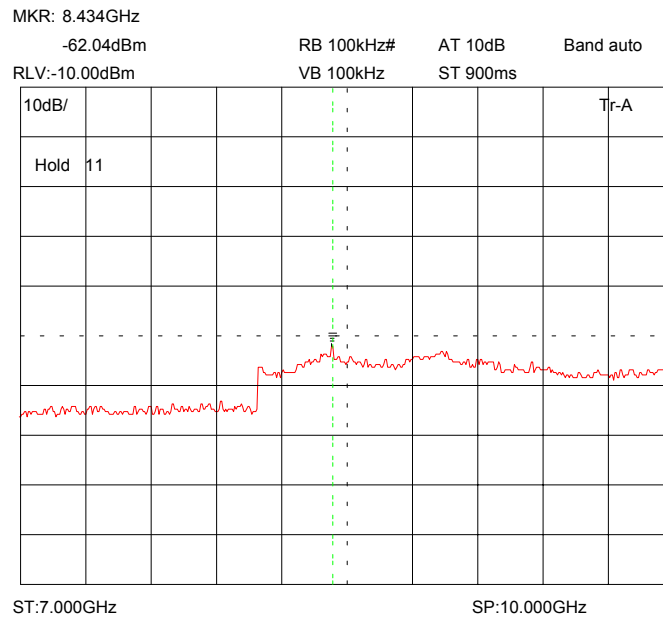

The above test results show that there were no emissions within 20dBs of the -13dBm limit.

Radiated emissions no input signal

30MHz-1GHz

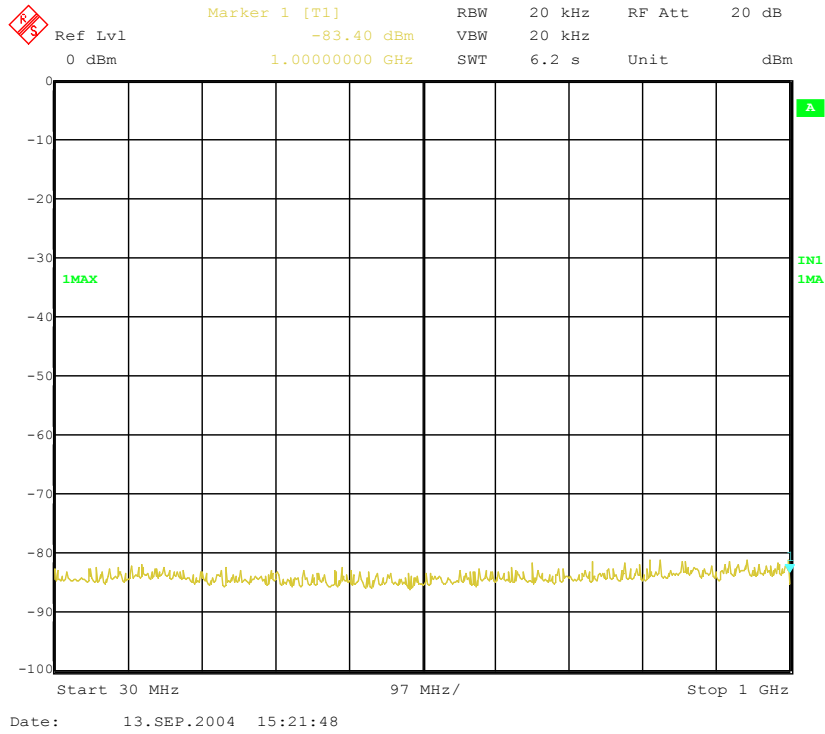

Radiated emissions no input signal

1-3GHz

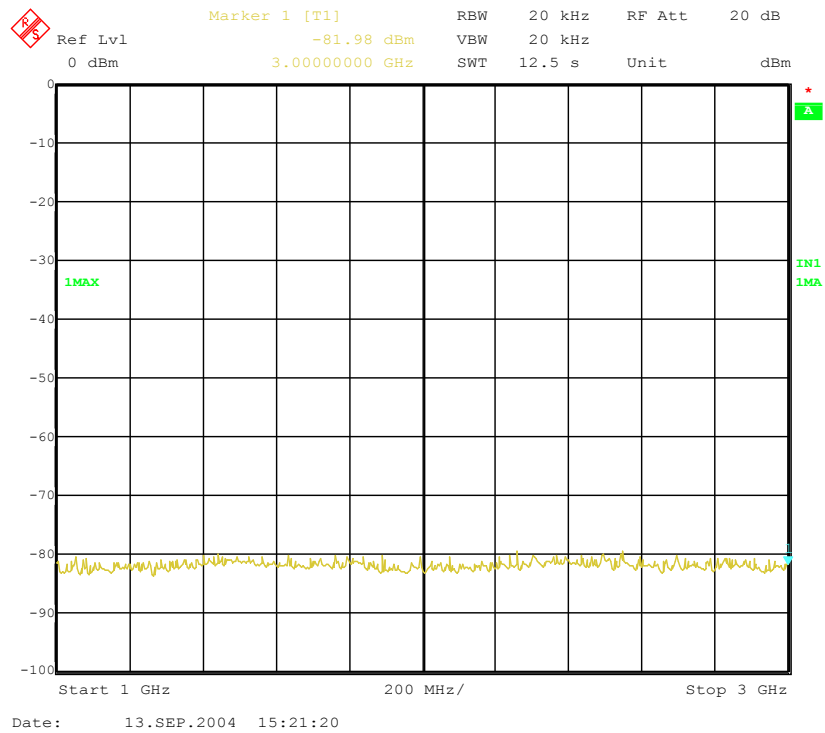

The above test results show that there were no emissions within 20dBs of the -13dBm limit.

Radiated emissions no input signal

3 - 7GHz

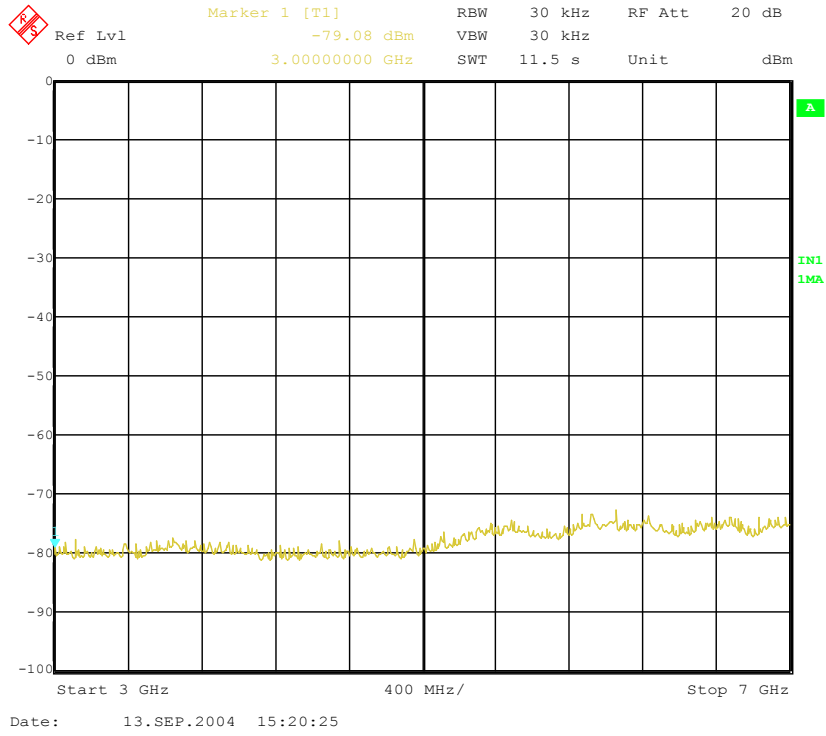

Radiated emissions no input signal

7- 10 GHz

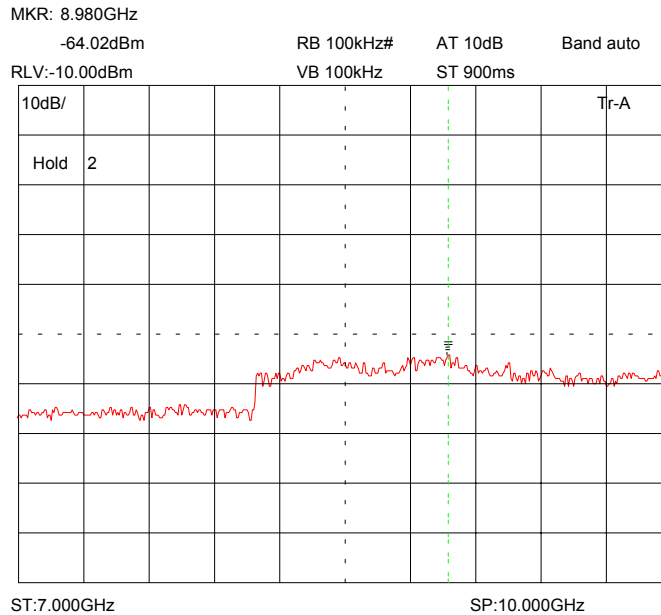

The above test results show that there were no emissions within 20dBs of the -13dBm limit.

**AMPLIFIER GAIN – CONDUCTED – PART 2.1046 – DOWNLINK**

Ambient temperature = 26°C  
 Relative humidity = 44%  
 Supply voltage = +110 Vac  
 Channel number = See test results

Radio Laboratory

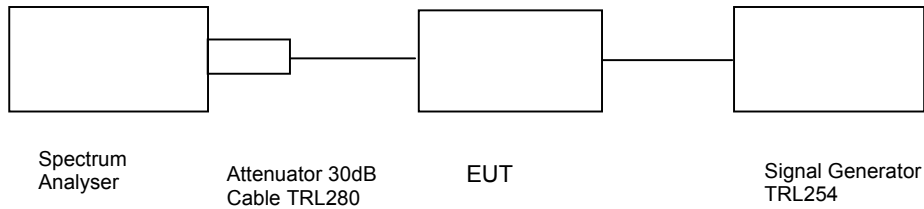

Frequency MHz	Signal Generator input level dBm	Cable & Attenuator loss dB	Level at Spectrum Analyser dBm	Gain dB	Gain after 20dB input level increase dBm
856.025 MHz	-63.4	32.08	-13.7	81.78	61.78
862.050 MHz	-63.4	32.08	-13.7	81.78	61.78
868.575 MHz	-63.4	32.08	-13.1	82.38	62.38

Notes:

1. The level of the signal generator takes into consideration the loss from the cable.
2. The signal generator input was increased by 20dBs and the level of the output signal remeasured
3. The EUT's downlink path had 10dB's of internal attenuation switched in.

TYPE OF EQUIPMENT	MAKER/SUPPLIER	MODEL No	SERIAL No	TRL No	ACTUAL EQUIPMENT USED
SPECTRUM ANALYSER	RHODE & SCHWARZ	ESIB 7	100 182	630	<b>X</b>
ATTENUATOR	AFL	10-002530	8616	N/A	<b>X</b>
CABLE	ROSENBERGER	MICRO COAX	N/A	280	<b>X</b>
SIGNAL GENERATOR	MARCONI	2042	119388/021	254	<b>X</b>

# AMPLIFIER INTERMODULATION SPURIOUS EMISSIONS – CONDUCTED – PART 2.1053– DOWNLINK

Ambient temperature = 21°C  
Relative humidity = 56%  
Supply voltage = +110 Vac

Radio Laboratory

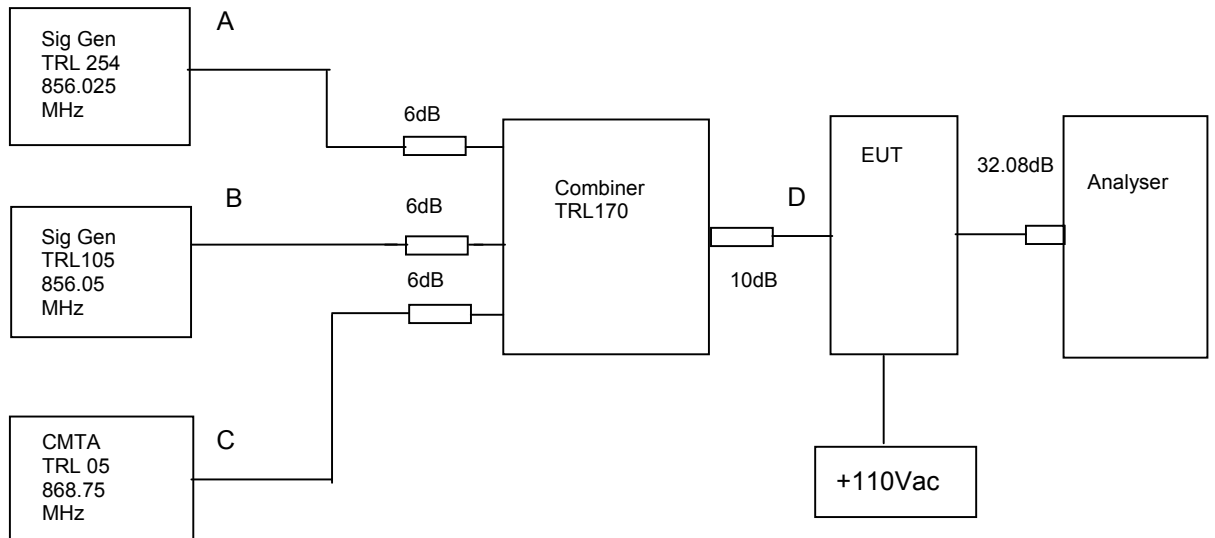

The intermodulation and spurious products were measured with the amplifier operating at maximum gain. A three tone test was conducted using the equipment as above. The input power level was adjusted so the level at point D was the maximum input of  $-63.4\text{dBm}$ . The cable and attenuators loss between the EUT and the spectrum analyser was  $29.84\text{ dB}$ .

Sweep data is shown on the next page:

### Intermodulation Inband

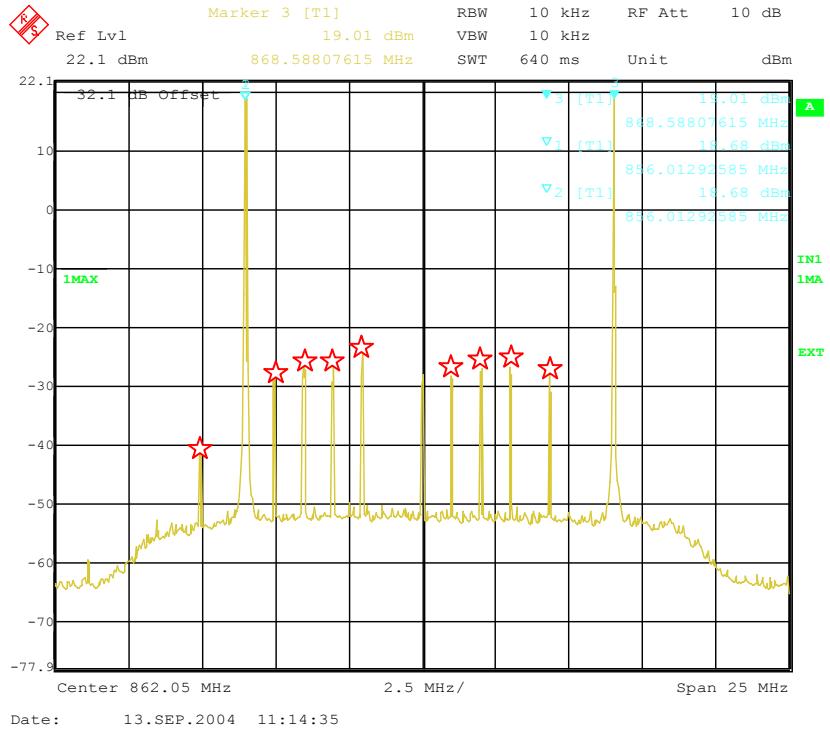

The above plot shows that all products (designated by ☆ ) are at least 40dB below the fundamentals.



### Intermodulation Wideband

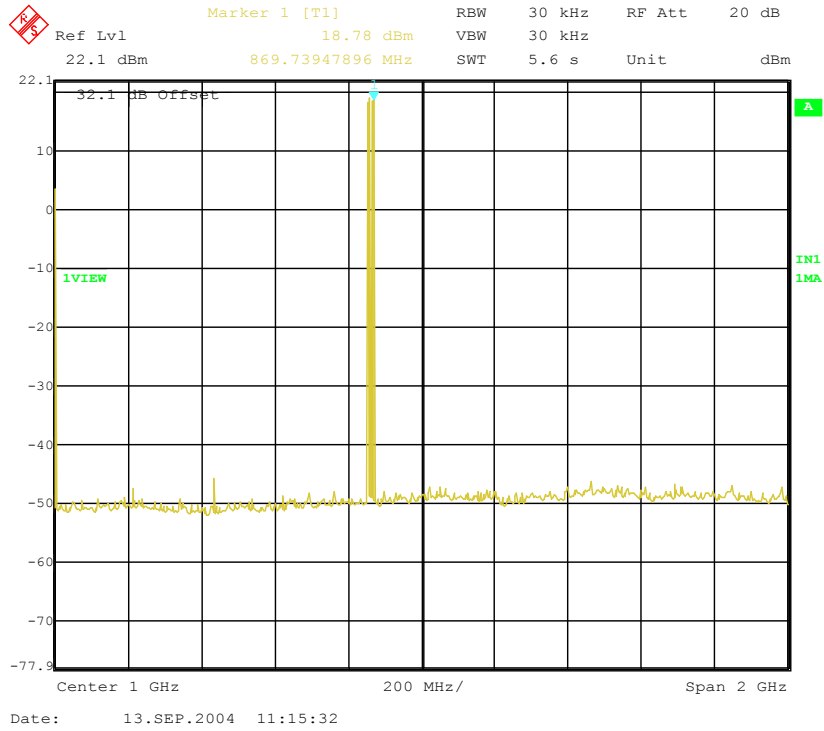

The above plot shows that there are no products outside the bands.

#### Test equipment used for intermodulation test

TYPE OF EQUIPMENT	MAKER/SUPPLIER	MODEL No	SERIAL No	TRL No	ACTUAL EQUIPMENT USED
SPECTRUM ANALYSER	RHODE & SCHWARZ	ESIB 7	100 182	630	<b>X</b>
SIGNAL GENERATOR	MARCON	2042	119562/021	254	<b>X</b>
SIGNAL GENERATOR	ROHDE & SCHWARZ	SMR 20	834671/003	478	<b>X</b>
SIGNAL GENERATOR	MARCONI	2023	112224/040	105	<b>X</b>
COMBINER	ELCOM	RC-4-50	N/A	170	<b>X</b>

**TRANSMITTER TESTS**

**AMPLIFIER MODULATED CHANNEL TEST – CONDUCTED – Part 2.1049– DOWNLINK**

Ambient temperature = 21°C Radio Laboratory  
 Relative humidity = 53%  
 Supply voltage = +110 Vac  
 Channel number = See test results

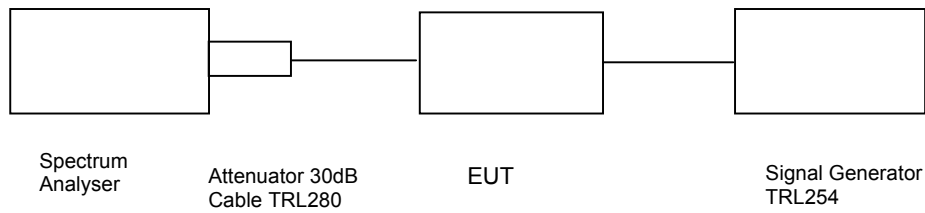

This test was performed to show that the amplifier does not alter the input signal in any way. The input signal was set to the maximum input level (-63.4) and modulated with a 2500Hz tone. The plots show the signal measured at the signal generator and the signal measured at the output of the EUT.

Note: The cables and attenuators had the following losses.

1. Cable TRL280 and 30dB attenuator = 32.08dB
2. Cable between signal generator and EUT = 1.72dB

The test equipment used for the Transmitter modulated channel tests is shown below:

TYPE OF EQUIPMENT	MAKER/SUPPLIER	MODEL No	SERIAL No	TRL No	ACTUAL EQUIPMENT USED
SPECTRUM ANALYSER	RHODE & SCHWARZ	ESIB 7	100 182	630	<b>X</b>
ATTENUATOR	AFL	10-002530	8616	N/A	<b>X</b>
CABLE	ROSENBERGER	MICRO COAX	N/A	280	<b>X</b>
SIGNAL GENERATOR	MARCONI	2042	119388/021	254	<b>X</b>

856.025 MHz Signal generator deviation set to 2.5kHz

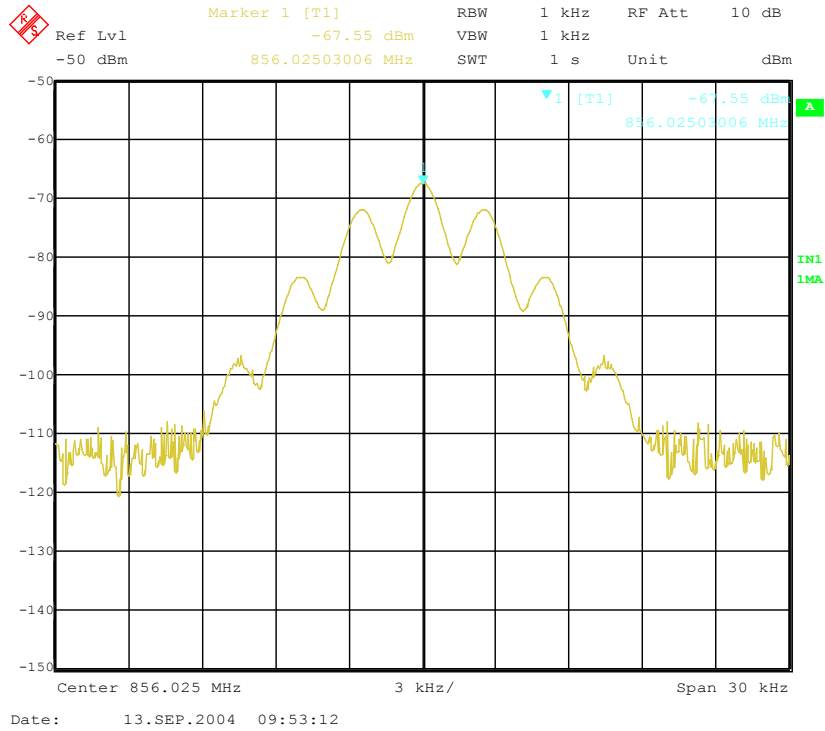

856.025 MHz Signal generator and EUT deviation set to 2.5kHz

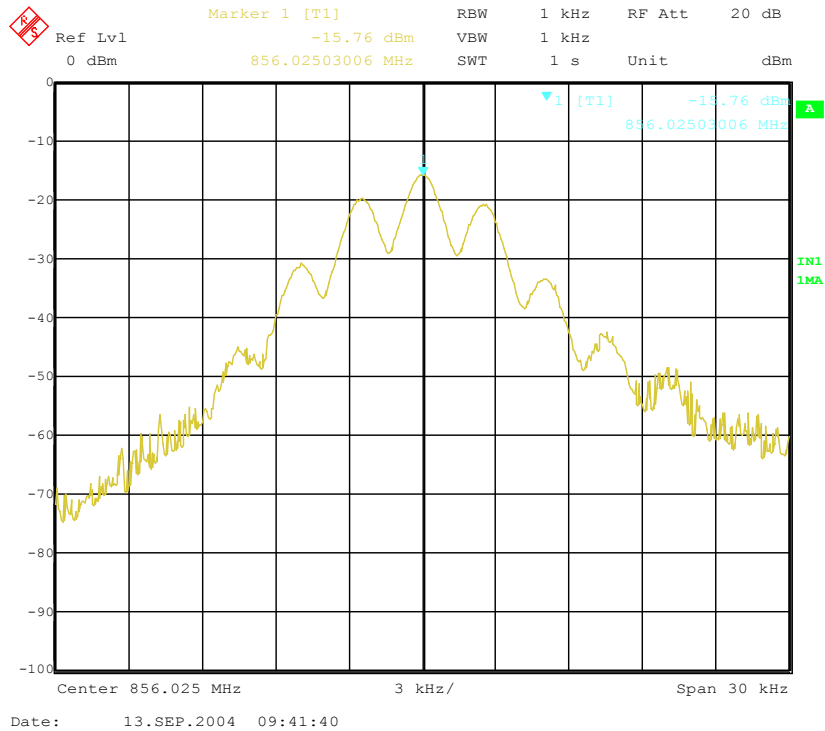

The above plots depicting the output wave shape show no measurable distortion visible. When compared to the input signal.

862.050 MHz Signal generator deviation set to 2.5kHz

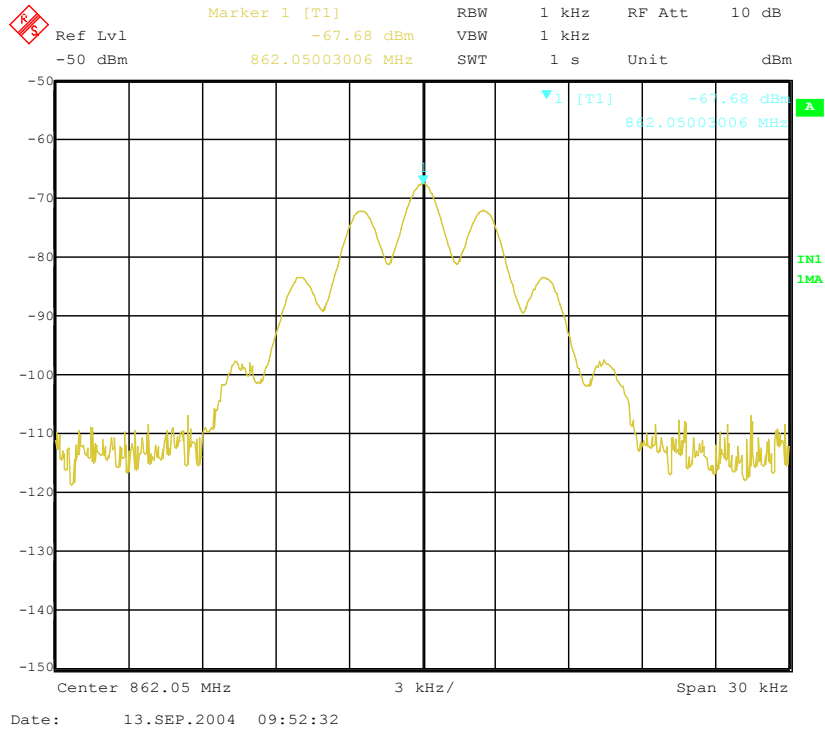

862.050 MHz Signal generator and amplifier deviation set to 2.5kHz

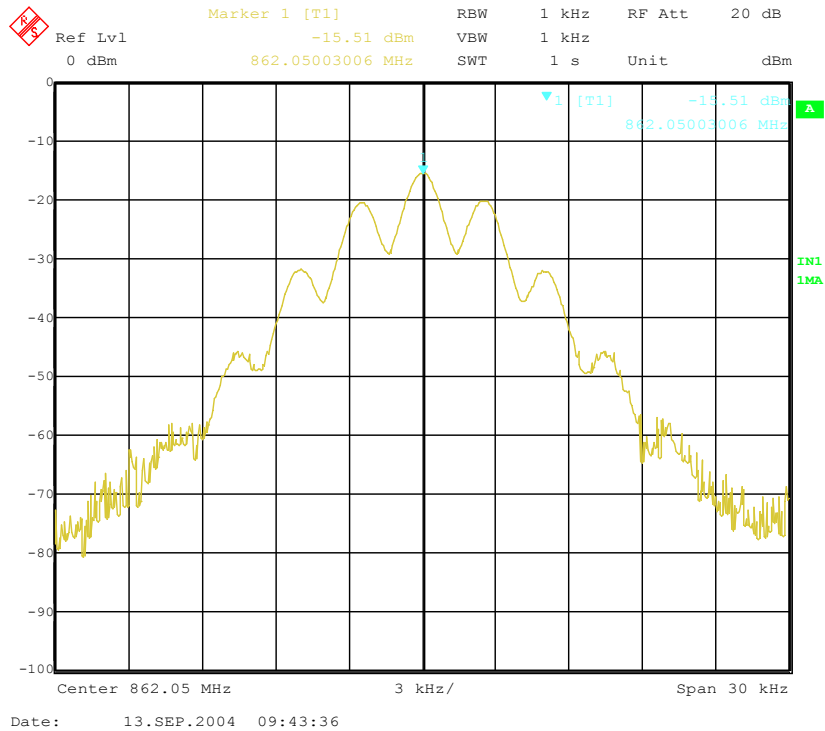

The above plots depicting the output wave shape show no measurable distortion visible. When compared to the input signal.

868.575 MHz Signal generator deviation set to 2.5kHz

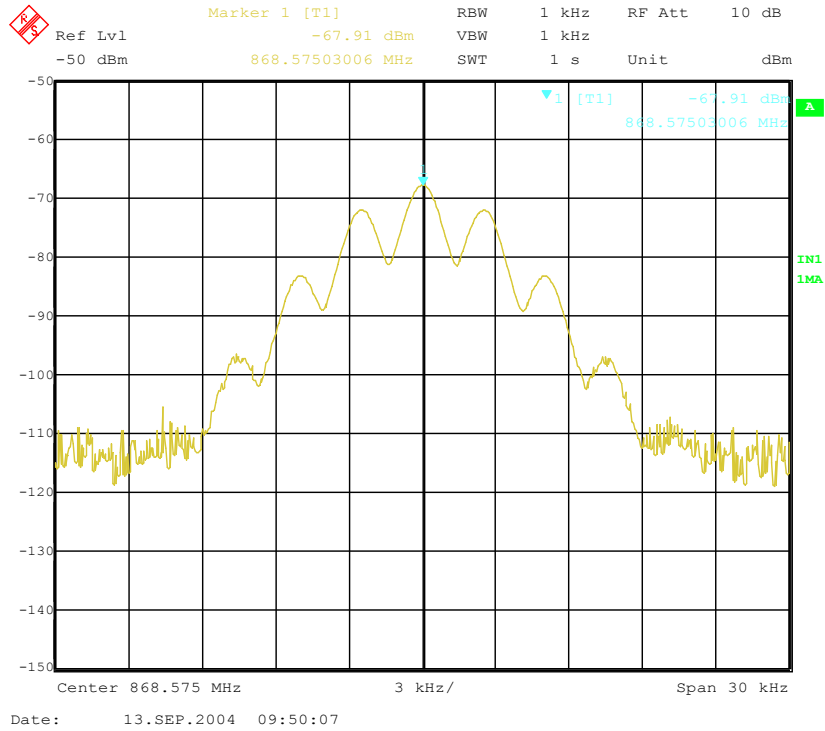

868.575 MHz Signal generator deviation set to 2.5kHz

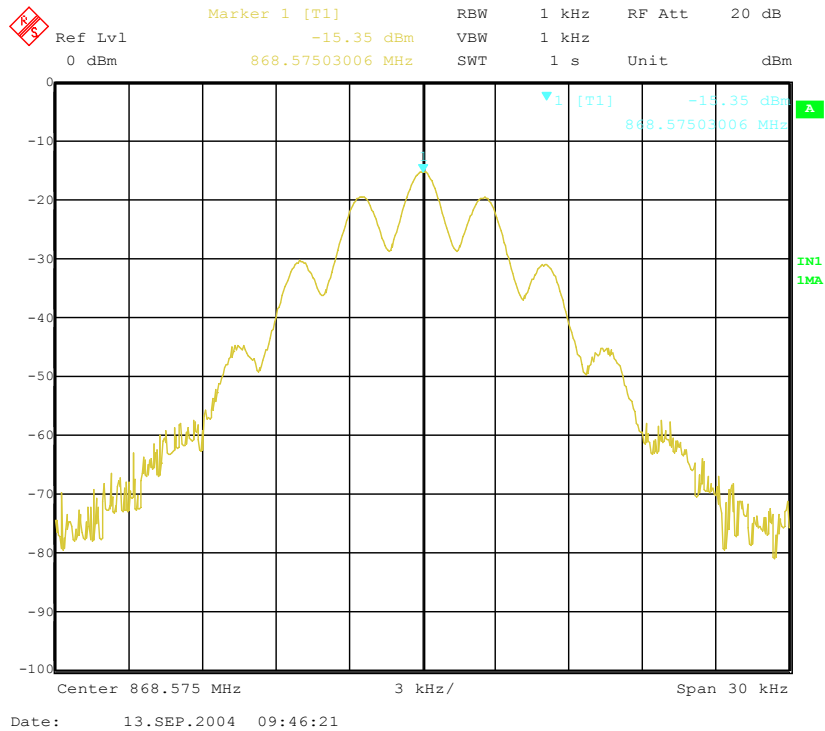

The above plots depicting the output wave shape show no measurable distortion visible. When compared to the input signal.

**TRANSMITTER TESTS**

**AMPLIFIER SPURIOUS EMISSIONS – CONDUCTED – Part 2.1051– DOWNLINK**

Ambient temperature = 26°C  
 Relative humidity = 48%  
 Supply voltage = +110 Vac

Radio Laboratory  
 Test Signal = F3E

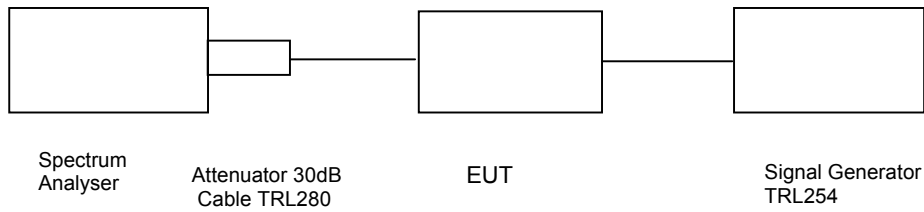

The test was set up as per the diagram. The level at the input was adjusted to compensate for the loss of the interconnecting cable. The unit was tested operating at maximum power and on three test frequencies. The EUT's downlink path had 10dB's of internal attenuation switched in.

The Spurious limit was calculated as follows:

On any frequency removed from the assigned frequency by more that 250% of the authorised bandwidth

At least 43 + 10 log PdB

$$(10\log P_{\text{watts}}) - (43 + 10\log (P_{\text{watts}} * 1000)) = \text{LIMIT} = -13 \text{ dBm}$$

The test equipment used for the Transmitter Conducted Emissions:

TYPE OF EQUIPMENT	MAKER/SUPPLIER	MODEL No	SERIAL No	TRL No	ACTUAL EQUIPMENT USED
SPECTRUM ANALYSER	RHODE & SCHWARZ	ESIB 7	100 182	630	<b>X</b>
ATTENUATOR	AFL	10-002530	8616	N/A	<b>X</b>
CABLE	ROSENBERGER	MICRO COAX	N/A	280	<b>X</b>
SIGNAL GENERATOR	MARCONI	2042	119388/021	254	<b>X</b>
SPECTRUM ANALYSER	ANRITSU	MS2665C	MT26089	479	<b>X</b>

Conducted emissions 856.025 MHz

0 - 3GHz

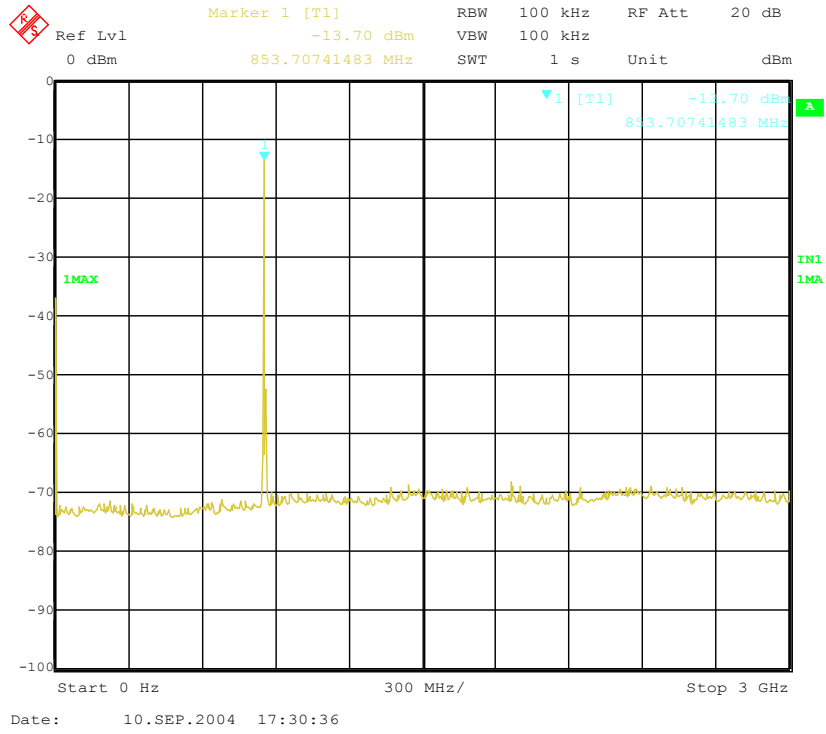

Conducted emissions 856.025 MHz

3 - 7GHz

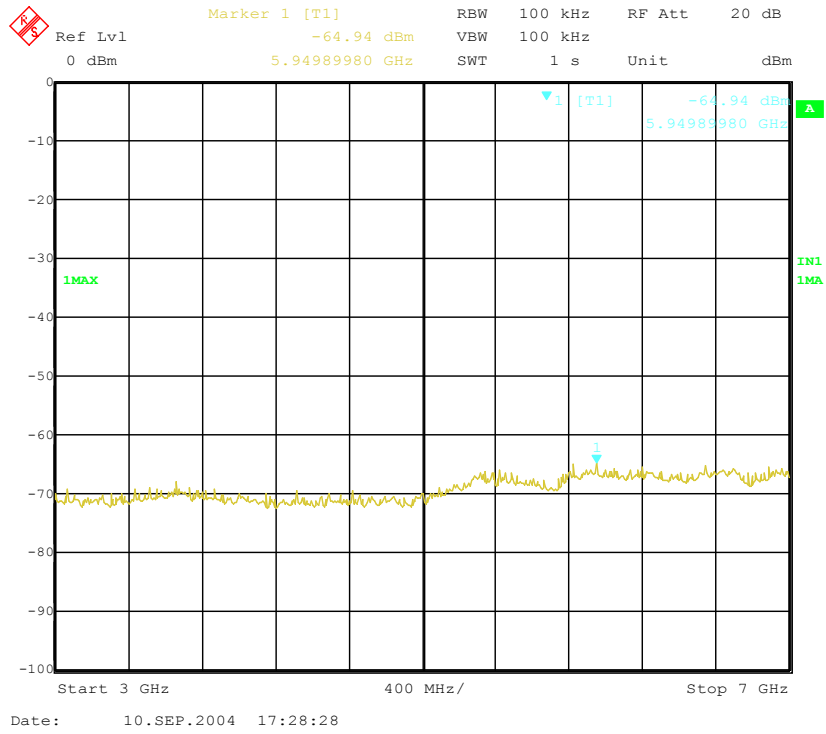

Conducted emissions 856.025 MHz

7 - 10GHz

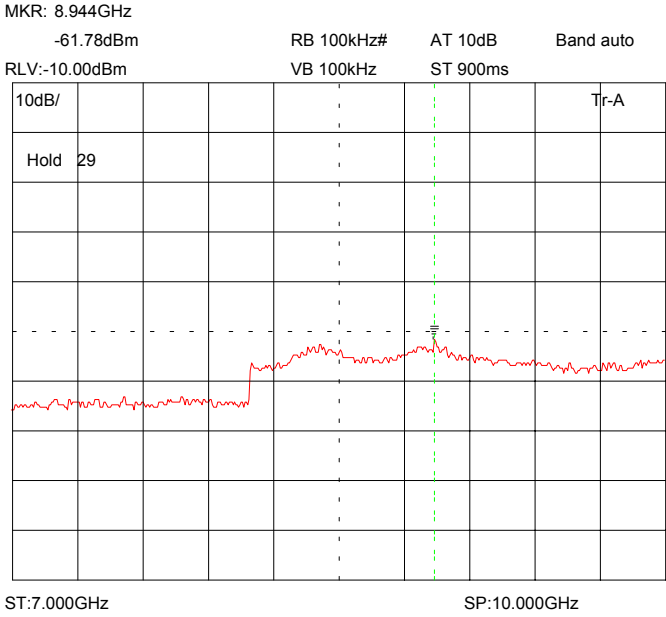



Conducted emissions 862.05 MHz

0 - 3GHz

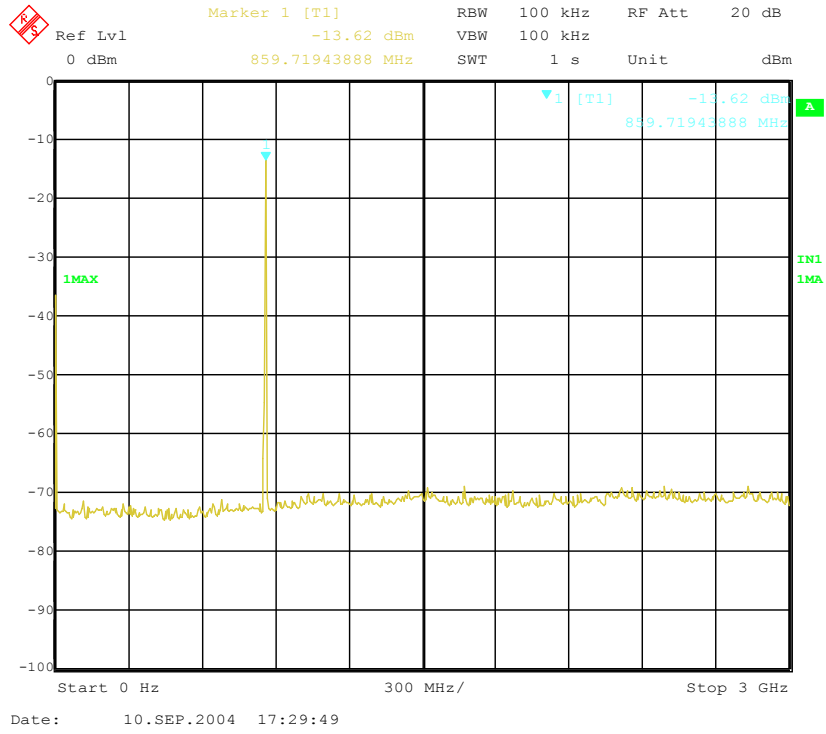

Conducted emissions 862.05 MHz

3 - 7GHz

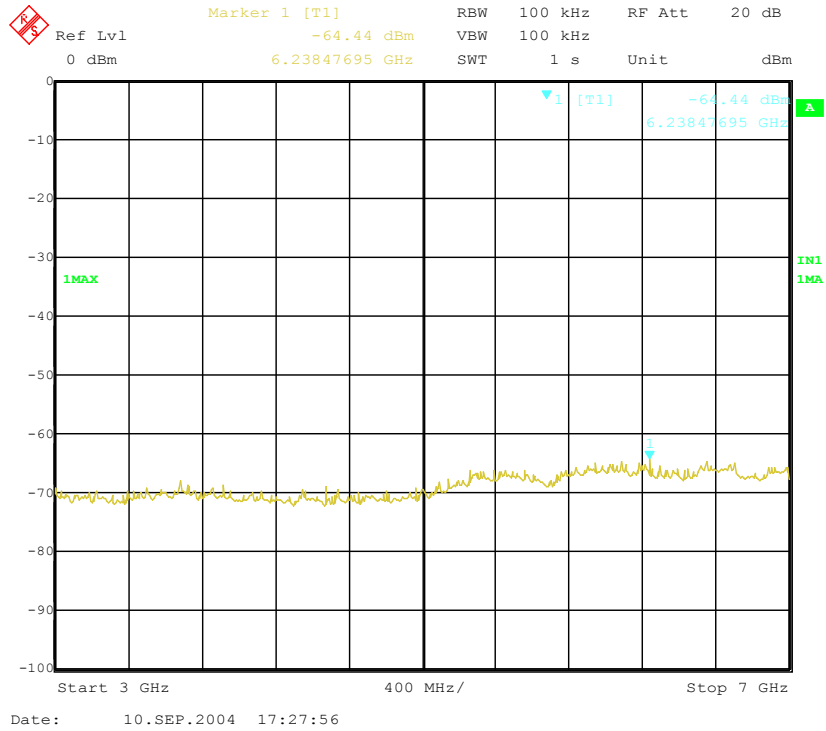

Conducted emissions 862.05 MHz

7 - 10GHz

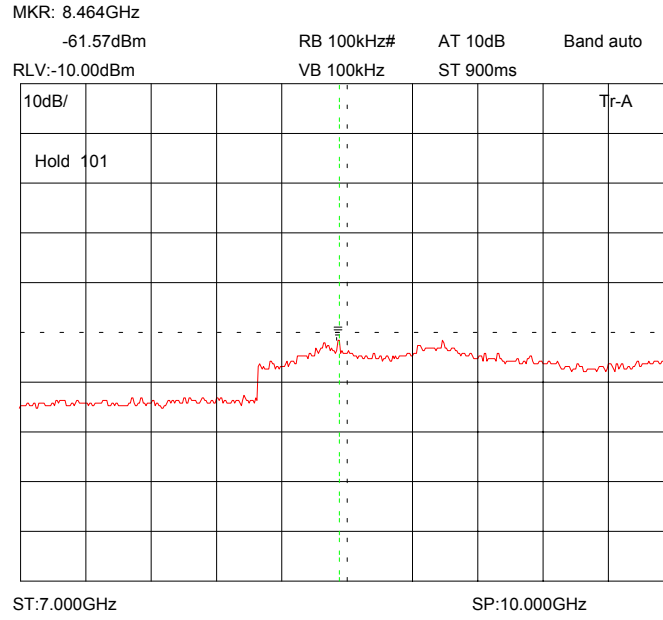

Conducted emissions 868.575 MHz

0 - 3GHz

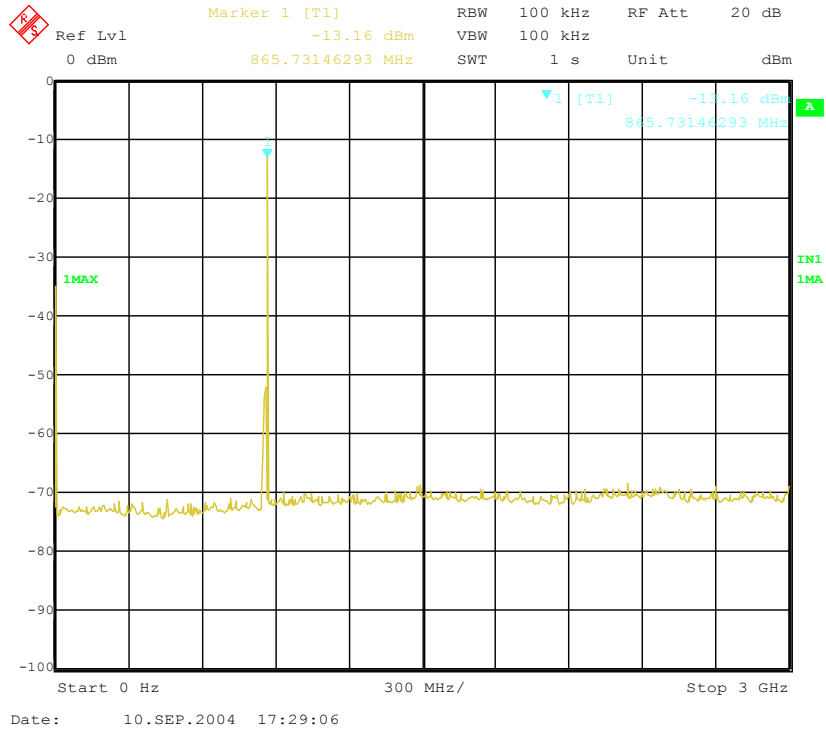

Conducted emissions 868.575 MHz

3 - 7GHz

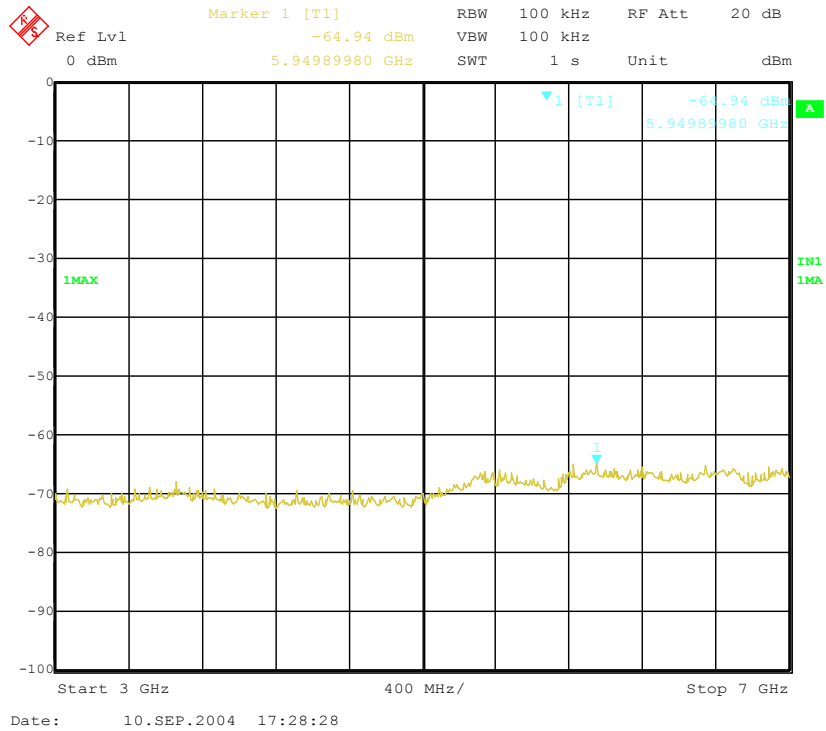

Conducted emissions 868.575 MHz

7 - 10GHz

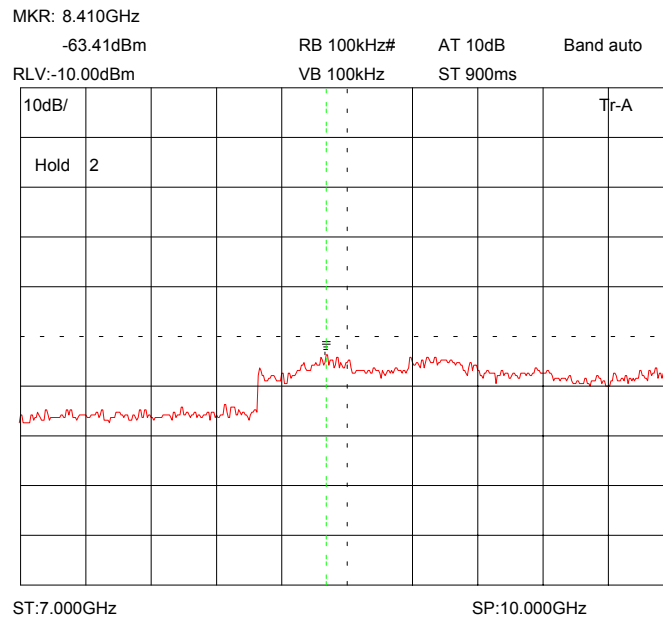

## TRANSMITTER TESTS

### AMPLIFIER SPURIOUS EMISSIONS – RADIATED – Part 2.1053– DOWNLINK

Ambient temperature = 26°C  
 Relative humidity = 44%  
 Conditions = OATS  
 Supply voltage = +110 Vac  
 Supply Frequency = N/A

Test Signal = F3E

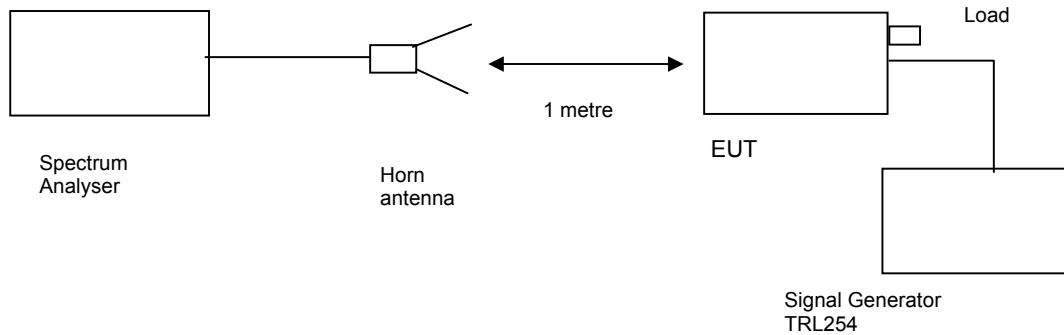

The test was set up as per the diagram. The level at the input was adjusted to compensate for the loss of the interconnecting cable. The unit was tested operating maximum power on three test frequencies with a 50 ohm load on the output. The unit was also tested with the signal generator replaced by another 50ohm load.

The Spurious limit was calculated as follows:

On any frequency removed from the assigned frequency by more that 250% of the authorised bandwidth

At least  $43 + 10 \log P_{dB}$

$$(10\log P_{watts}) - (43 + 10\log (P_{watts} * 1000)) = \text{LIMIT} = -13 \text{ dBm}$$

The test equipment used for the Transmitter Spurious Emissions:

TYPE OF EQUIPMENT	MAKER/ SUPPLIER	MODEL No	SERIAL No	TRL No	ACTUAL EQUIPMENT USED
SPECTRUM ANALYSER	RHODE & SCHWARZ	ESIB 7	100 182	630	<b>X</b>
HORN	EMCO	3115	9010-3581	139	<b>X</b>
50Ω LOAD	RHODE & SCHWARZ	200.0019.55	300804/32	UH227	<b>X</b>
CABLE	ROSENBERGER	MICRO COAX	N/A	280	<b>X</b>
SIGNAL GENERATOR	MARCONI	2042	119388/021	254	<b>X</b>
SPECTRUM ANALYSER	ANRITSU	MS2665C	MT26089	479	<b>X</b>

Radiated emissions 856.025 MHz

30 MHz - 1GHz

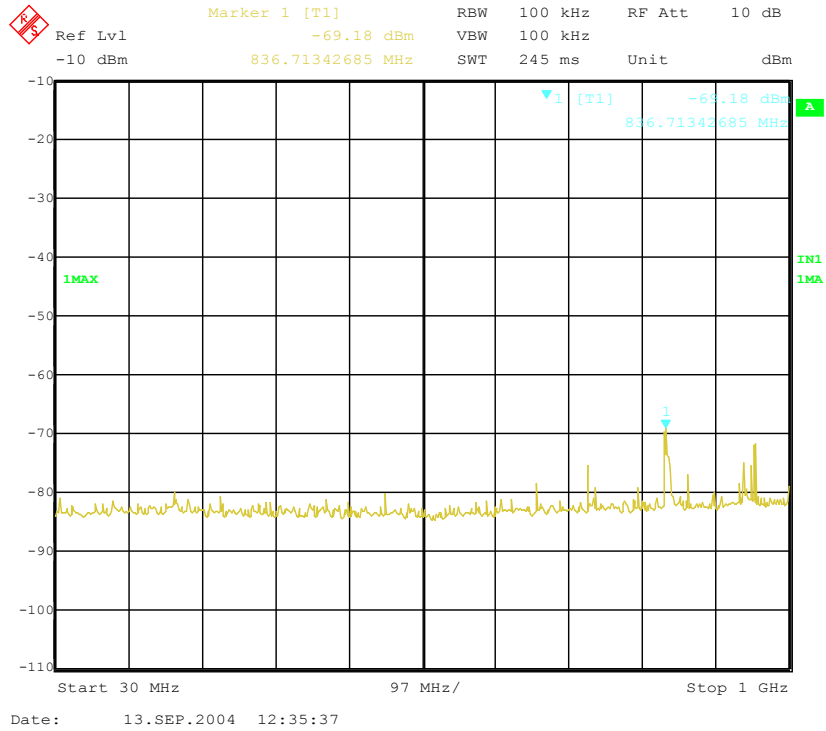

Radiated emissions 856.025 MHz

1-3GHz

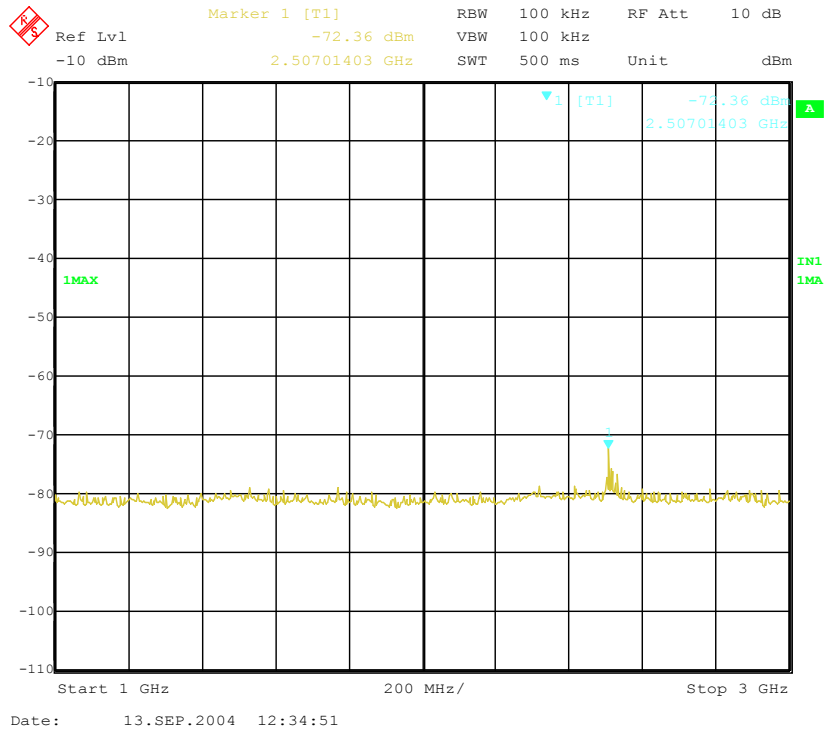

The above test results show that there were no emissions within 20dBs of the -13dBm limit.

Radiated emissions 856.025 MHz

3-7GHz

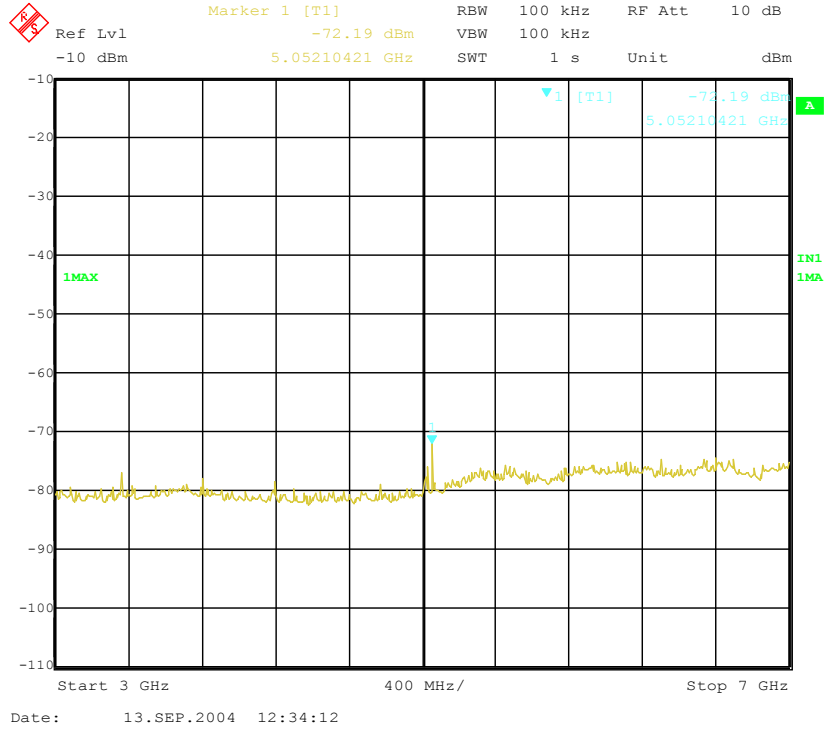

Radiated emissions 856.025 MHz

7-10GHz

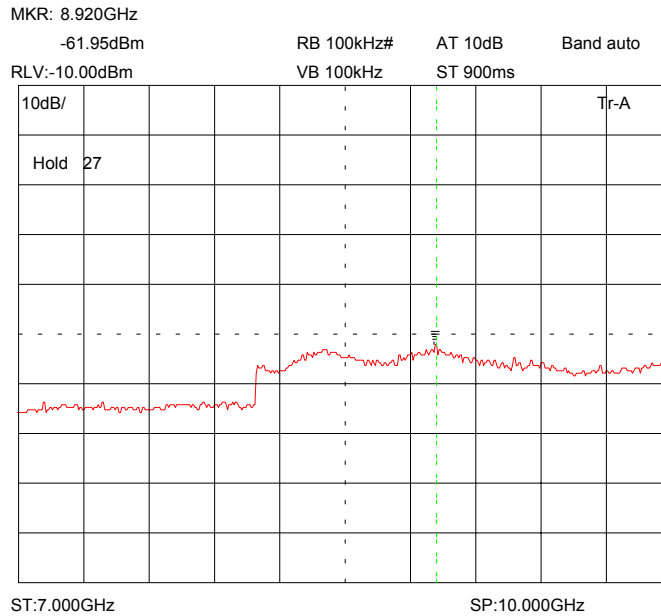

The above test results show that there were no emissions within 20dBs of the -13dBm limit.

Radiated emissions 862.050 MHz

30 MHz - 1GHz

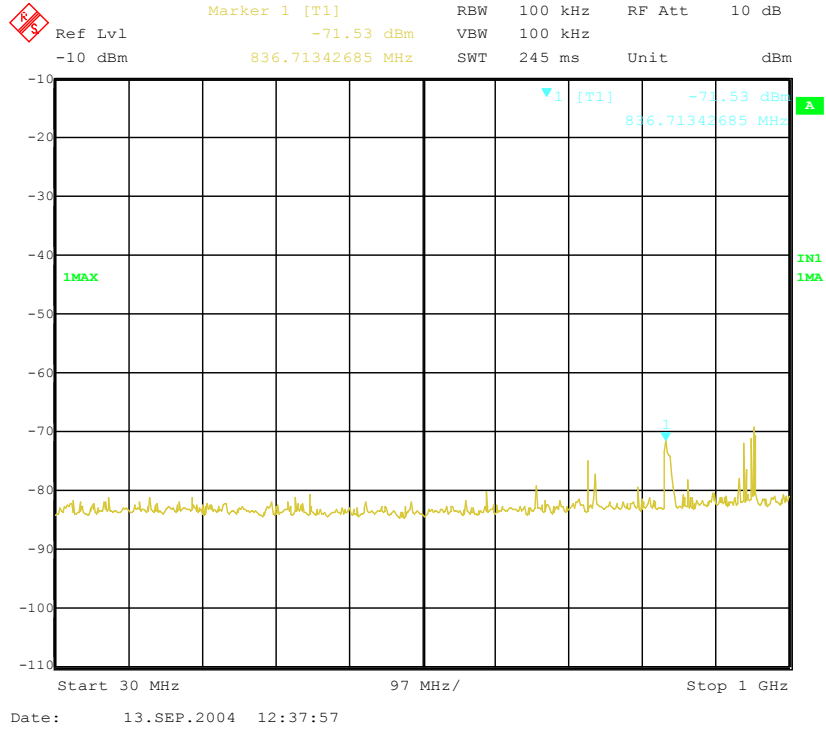

Radiated emissions 862.050 MHz

1-3GHz

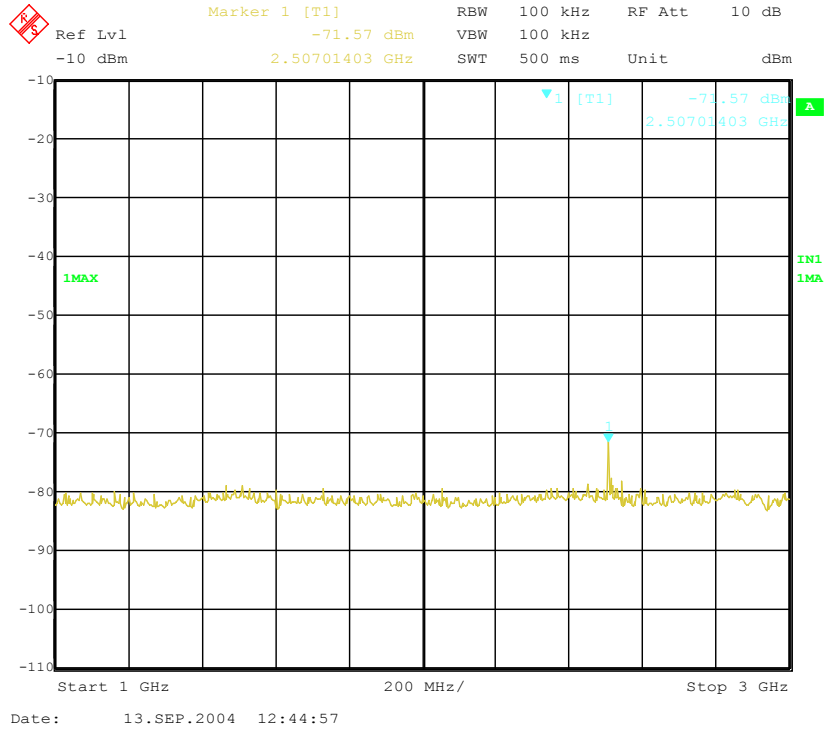

The above test results show that there were no emissions within 20dBs of the -13dBm limit.



Radiated emissions 862.05 MHz

3-7GHz

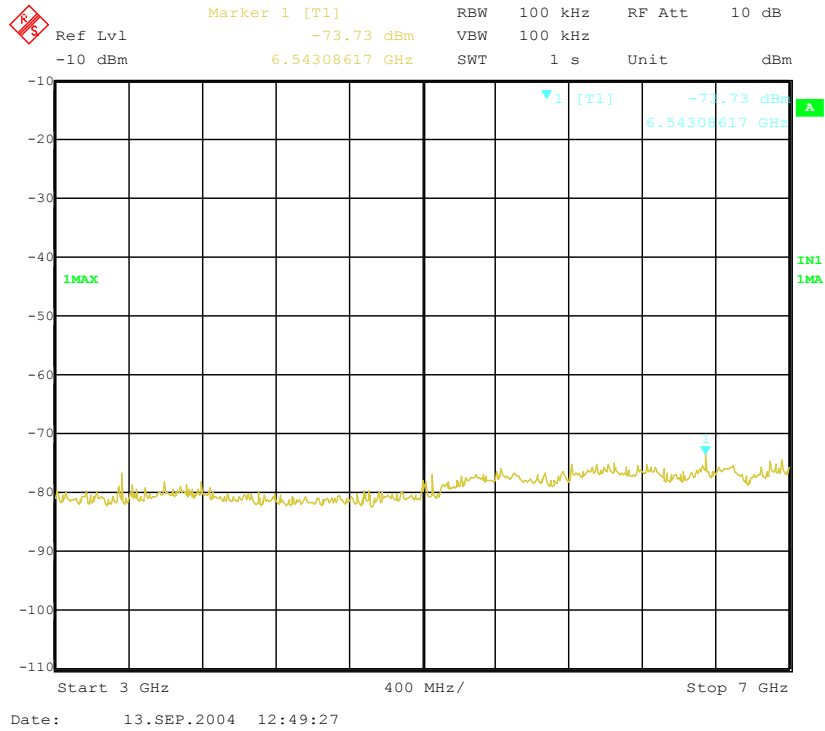

Radiated emissions 862.05 MHz

7-10GHz

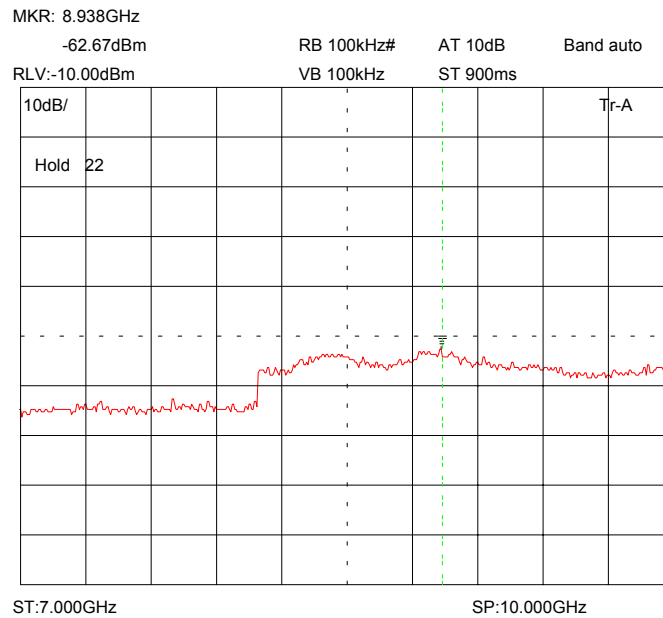

The above test results show that there were no emissions within 20dBs of the -13dBm limit.

Radiated emissions 868.575 MHz

30 MHz - 1GHz

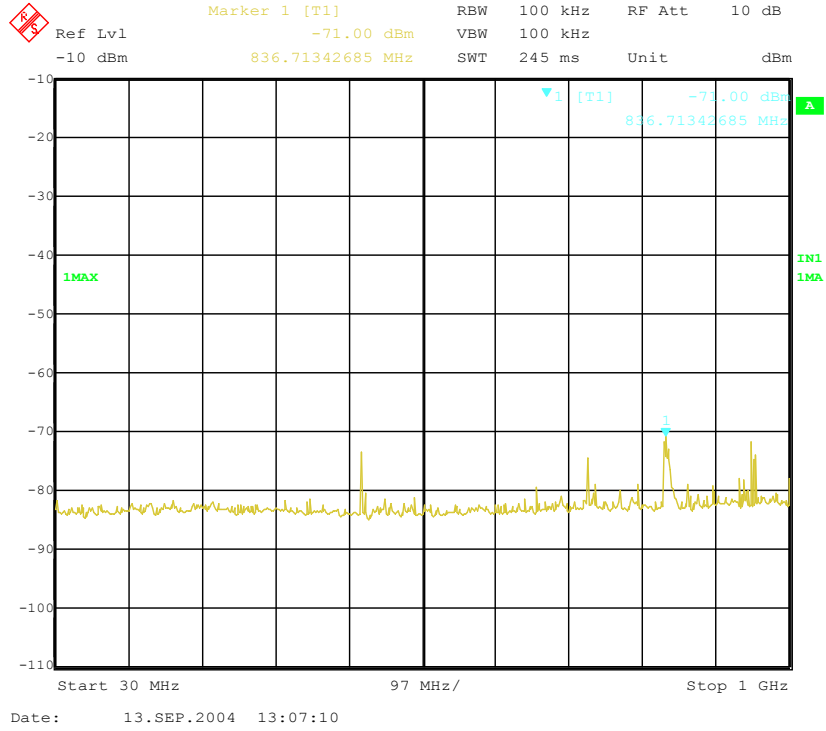

Radiated emissions 868.575 MHz

1-3GHz

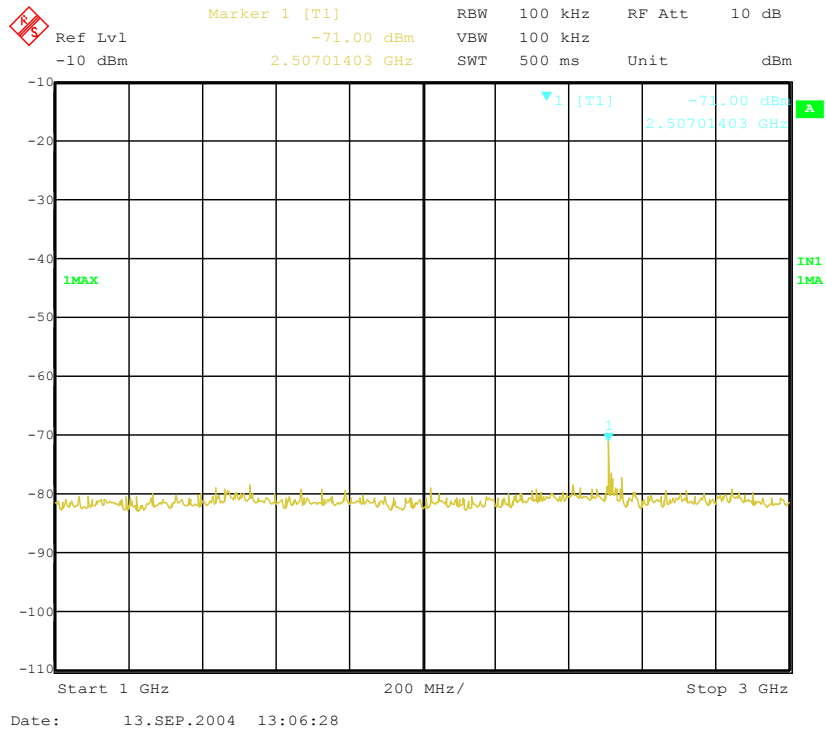

The above test results show that there were no emissions within 20dBs of the -13dBm limit.

Radiated emissions 868.575 MHz

3-7GHz

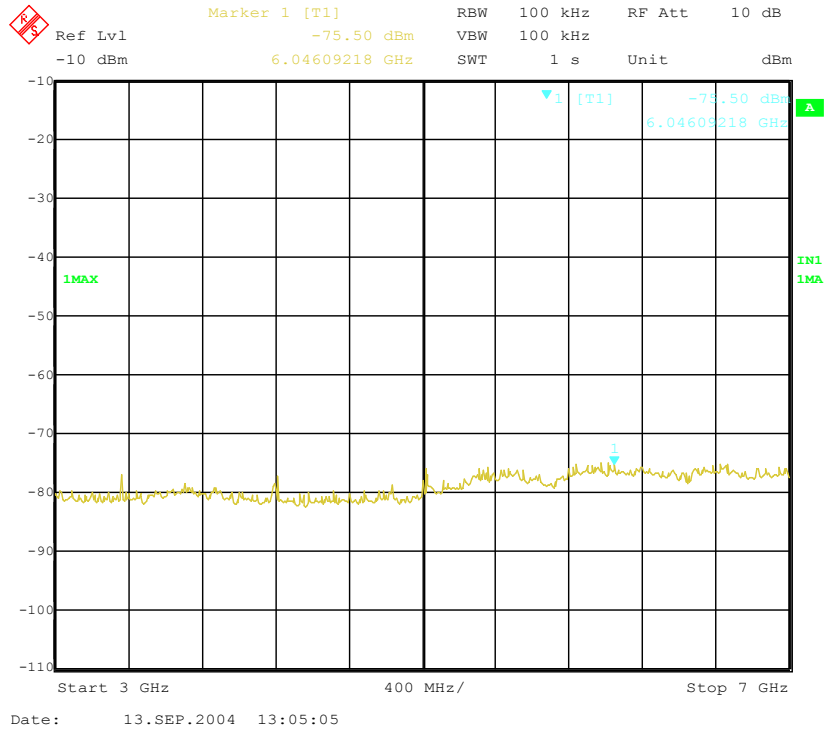

Radiated emissions 868.575 MHz

7-10GHz

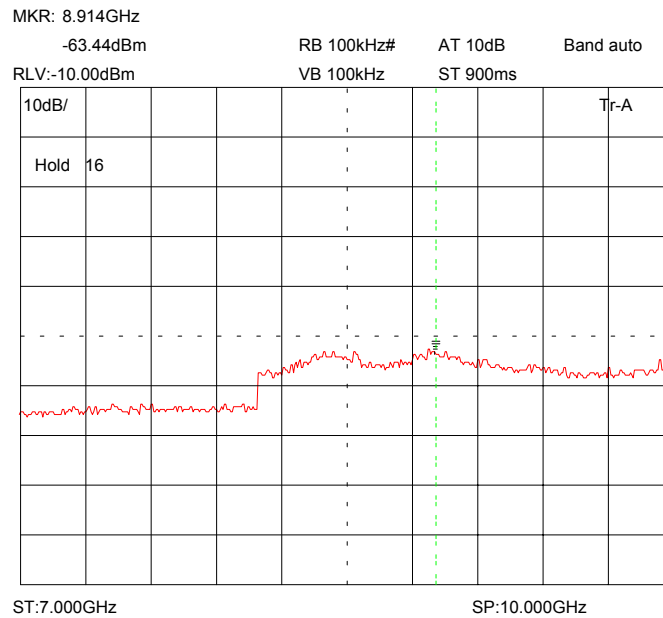

The above test results show that there were no emissions within 20dBs of the -13dBm limit.

Radiated emissions no input signal

30 MHz - 1GHz

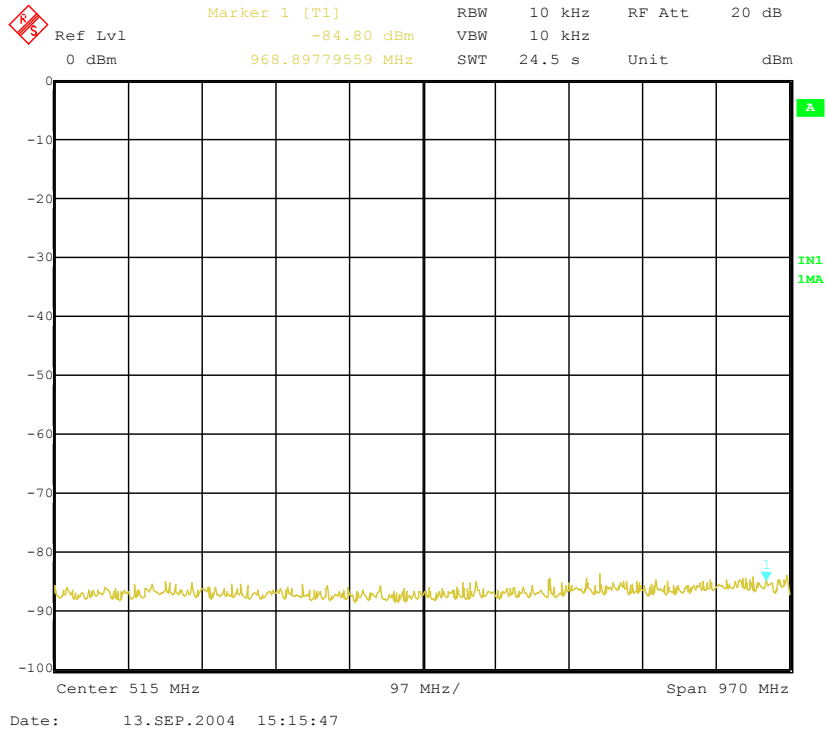

Radiated emissions no input signal

1-3GHz

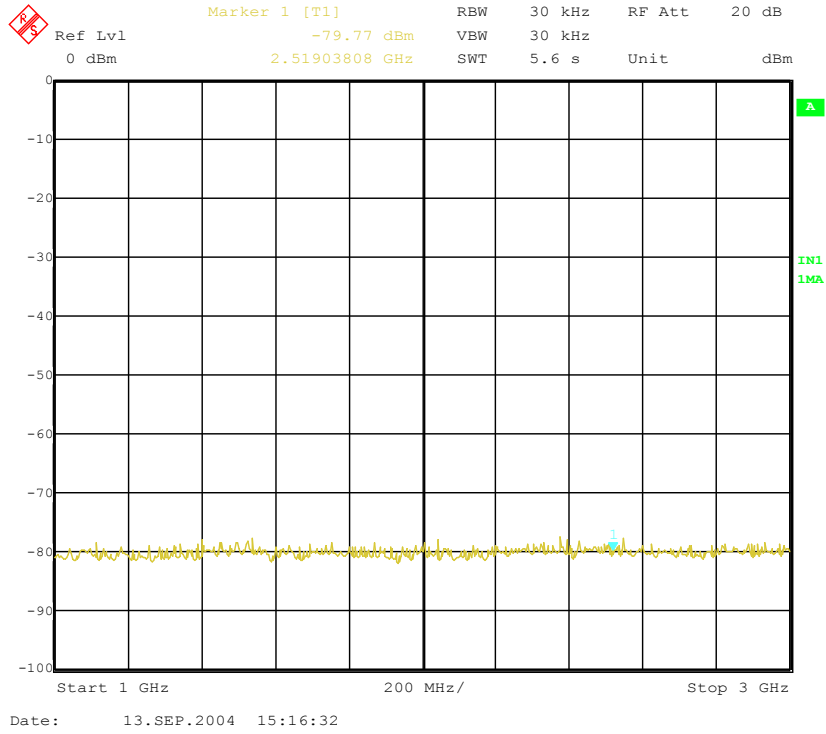

The above test results show that there were no emissions within 20dBs of the -13dBm limit.

Radiated emissions no input signal

3-7GHz

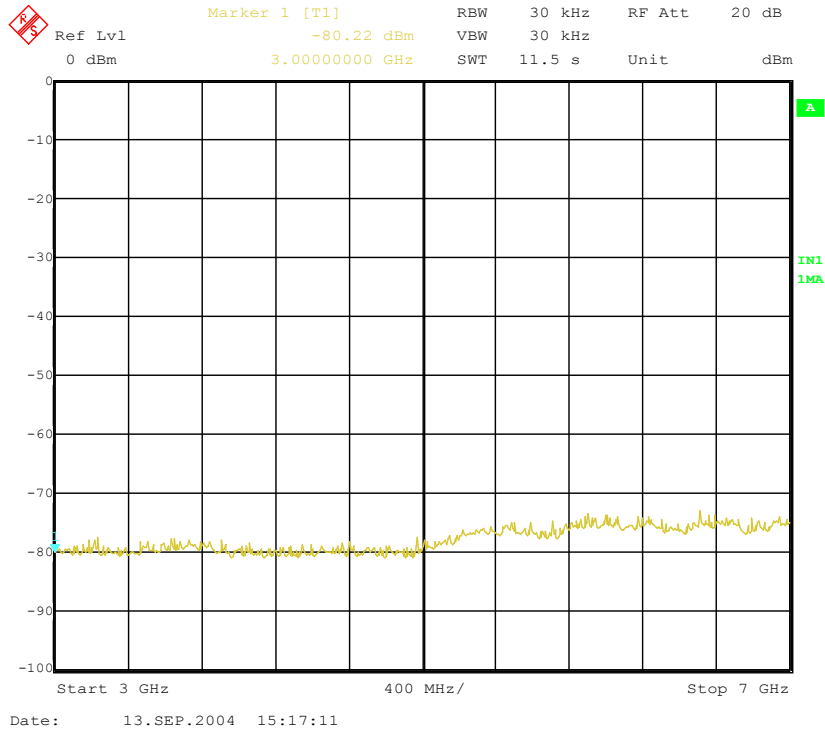

Radiated emissions no input signal

7-10GHz

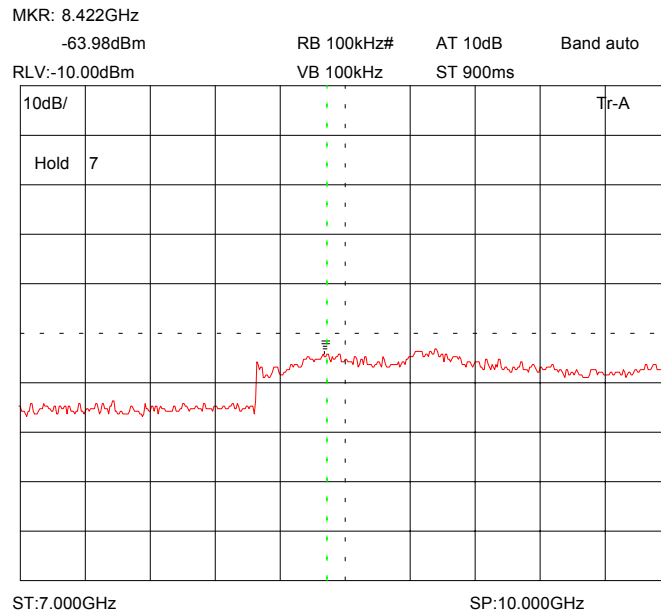

The above test results show that there were no emissions within 20dBs of the -13dBm limit.

**ANNEX A**  
**PHOTOGRAPHS**

PHOTOGRAPH No. 1

**TEST SETUP**



PHOTOGRAPH No. 2

**TEST SETUP**





**ANNEX B**  
**APPLICANT'S SUBMISSION OF DOCUMENTATION LIST**

### APPLICANT'S SUBMISSION OF DOCUMENTATION LIST

a.	TCB	-	APPLICATION	[X]
		-	FEE	[X]
b.	AGENT'S LETTER OF AUTHORISATION	-		[X]
c.	MODEL(s) vs IDENTITY	-		[ ]
d.	ALTERNATIVE TRADE NAME DECLARATION(s)	-		[ ]
e.	LABELLING	-	PHOTOGRAPHS	[ ]
		-	DECLARATION	[ ]
		-	DRAWINGS	[ ]
f.	TECHNICAL DESCRIPTION	-		[X]
g.	BLOCK DIAGRAMS	-	Tx	[X]
		-	Rx	[ ]
		-	PSU	[ ]
		-	AUX	[ ]
h.	CIRCUIT DIAGRAMS	-	Tx	[ ]
		-	Rx	[ ]
		-	PSU	[ ]
		-	AUX	[ ]
i.	COMPONENT LOCATION	-	Tx	[ ]
		-	Rx	[ ]
		-	PSU	[ ]
		-	AUX	[ ]
j.	PCB TRACK LAYOUT	-	Tx	[ ]
		-	Rx	[ ]
		-	PSU	[ ]
		-	AUX	[ ]
k.	BILL OF MATERIALS	-	Tx	[ ]
		-	Rx	[ ]
		-	PSU	[ ]
		-	AUX	[ ]
l.	USER INSTALLATION / OPERATING INSTRUCTIONS	-		[X]