



Electromagnetic Compatibility Test Report

Test Report No: AXW 160117 Rev.2
Issued on: January 16, 2017

Product Name
RRU High Power

Tested According to
FCC 47 CFR, Part 24
1930 MHz - 1995 MHz Band

Tests Performed for
Axell Wireless
Qiryat Matalon, Petah Tikva, 49002,
Tel: +972-3-918 0180

QualiTech EMC Laboratory

30 Hasivim Street, P.O. Box 7500
Petah-Tikva, 4951169, Israel
Tel: +972-3-926-6994
Fax: +972-3-928 7490



The information contained herein is the property of QualiTech, EMC Lab and is supplied without liability for errors or omissions.

*The copyright for this document vests in QualiTech, EMC Lab.
All rights reserved.*

This Test Report may not be reproduced, by any method, without the written permission of the QualiTech, EMC Lab.

If and when such permission is granted, the report must be reproduced only in the full format.

Test Personnel



Tests Performed By: -----

Idan Zehavi



Report Prepared By: -----

Bina Talkar



Report Approved By: -----

Rami Nataf
EMC Lab. Manager
QualiTech EMC Laboratory

Test Report details:

Test commencement date: 26.04.2016
Test completion date: 29.12.2016
Customer's representative: Boaz Reuven
Issued on: 24.05.2017

Revision details:

Version	Date	Details/Reasons
Rev. 1	16.01.2017	-
Rev. 2	24.05.2017	Updated according to TCB comments

Assessment information:

This report contains an assessment of the EUT against Electromagnetic Compatibility based upon tests carried out on the samples submitted. The results contained in this report relate only to the items tested. Manufactured products will not necessarily give identical results due to production and measurement tolerances. QualiTech, EMC Lab does not assume responsibility for any conclusion and generalization drawn from the test results with regards to other specimens or samples of type of the equipment represented by test item.

The EUT was set up and exercised using the configuration, modes of operation and arrangements defined in this report only.

Modifications:

Modifications made to the EUT

None.

Modifications made to the Test Standard

None.

Summary of Compliance Status

Test Spec. Clause	Test Case	Remarks
Specific Requirements		
-KDB 935210 D05 v01r01, sec. 3.3	Out-of-Band Rejection	Done
General Requirements		
-47 CFR §24.238(b) -47 CFR §2.1049(h) -KDB 935210 D05 v01r01, sec.3.4	Occupied Bandwidth - Input-versus-output signal comparison	Pass
-47 CFR §24.232(a)1), (a)2) -47 CFR §2.1046 -KDB 935210 D05 v01r01, sec. 3.5.4	Mean Output Power and Amplifier/Booster Gain	Pass
-47 CFR §24.238(a) -47 CFR §2.1051 -KDB 935210 D05v01r01, sec. 3.6.2, Conducted	Out-of-Band/Out-of-Block & Intermodulation Emissions Conducted Measurements	Pass
-47 CFR §24.238(a) -47 CFR §2.1051 -KDB 935210 D05v01r01, sec. 3.6.3, Conducted	Spurious Emission Conducted Measurement	Pass
-47 CFR §24.238 -47 CFR §2.1053 -KDB 935210 D05v01r01, sec. 3.8, Radiated	Spurious Emissions – Radiated Measurement	Pass
-47 CFR §24.235 -47 CFR §2.1055 -KDB 935210 D05v01r01, sec. 3.7, Conducted	Frequency Stability	Pass

Table of Contents

1. GENERAL.....	6
1.1. Referenced documents	6
1.2. Product Description	7
2. TEST FACILITY & UNCERTAINTY OF MEASUREMENT	9
2.1. Accreditation/ Registration reference	9
2.2. Test Facility description	9
3. EXAMINATION TEST RESULTS.....	11
3.1. Out-of-Band Rejection.....	11
3.2. Occupied Bandwidth - Input-versus-output signal comparison.....	12
3.3. Mean Output Power and Amplifier/Booster Gain	14
3.4. Out-of-Band/Out-of-Block & Intermodulation Emissions Conducted Measurements.....	15
3.5. Spurious Emission Conducted Measurement	20
3.6. Spurious Emission, Radiated Measurements.....	27
3.7. Frequency stability.....	35
4. APPENDIX.....	36

1. General

1.1. Referenced documents

KDB 935210 D05 v01r01: Measurements Guidance for Industrial and Non-consumer Signal Booster, Repeater and Amplifiers Devices

ANSI/TIA-603-D: Land Mobile FM or PM Communications Equipment and Performance Standards

1.2. Product Description

FCC ID: NEO43ID7D8C17C19A

IC: 8749A-43ID7817C19

Model Numbers: id-DAS-RRU-M-4307-4308-4317-4319-AC-F

Serial Number:1611D9001

Description of the EUT system/test Item:

idRU – The idRU is an IP 65 outdoor as well as indoor four-band remote unit, where two units can be cascaded through a CPRI link to support eight bands. Each band can provide maximum power of 43 dBm ± 0.75dB per band. The Remote Units serve as the backhaul port of any IP device or switch in the neighborhood; thus, it distributes combined cellular and data services according to user defined configuration profiles. The idRU is connected to the MSDH via 10 Gbit/s CPRI interfaces, where each interface contains an Embedded 1Gbit/s IP backhaul link.

Description of the EUT system/test Item:

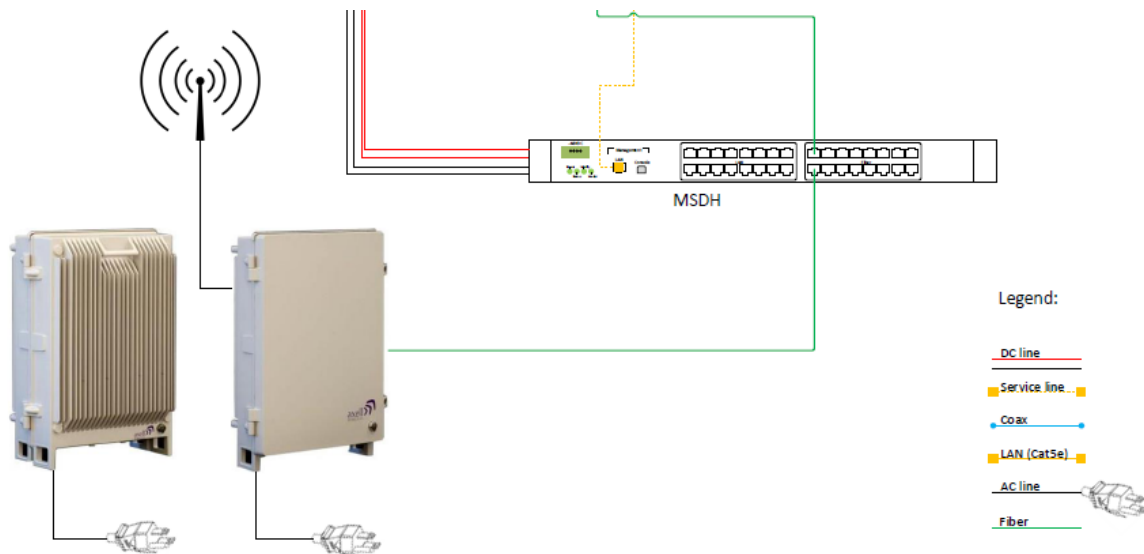

Bands and Modulations:

Technology	Direction	Modulation & Bandwidth	Frequency Band	Maximum Output Power(AV)
AC Model-Fc-1940.2MHz				
GSM	Downlink	QPSK,0.2 MHz	1930 - 1995 MHz	41.51dBm,14.2w
CDMA	Downlink	1.25MHz		43.50dBm,22.4w
WCDMA	Downlink	5MHz		42.59dBm,18.1w
LTE	Downlink	64 QAM 1.4MHz		43.35dBm,21.6w
		64 QAM 5MHz		43.37dBm,21.7w,
		64 QAM 20 MHz		43.20dBm,20.9w

Support /Ancillary Equipment:

For the purposes of this test report, ancillary equipment is defined as equipment which is used in conjunction with the EUT to provide operational features to the EUT.
The system was configured in a typical fashion, as it would be normally used. However, the ancillary equipment can influence the test results.

Test Setup and Module Description:

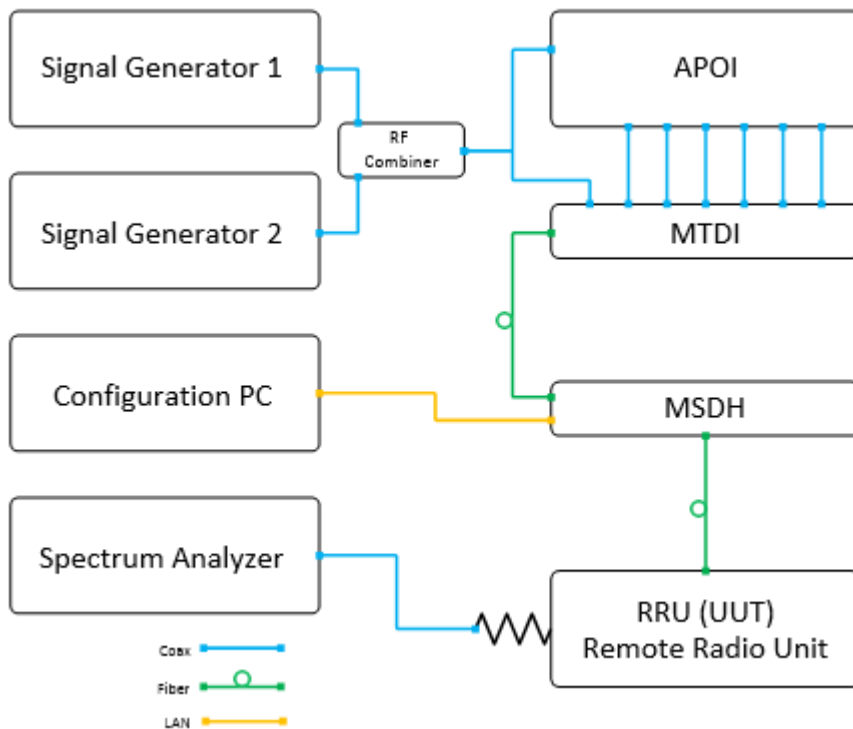

Signal Generator 1 and Signal Generator 2 generates a single tone or two-tones to the system. The tones can be selected to be CW or modulated . The signal can be routed either to the APOI or MTDI via Coax.

The APOI (Active Point of Interface), conditions and controls level of up to 16 low power BTS sectors of up to 30dBm. (Separate low PIM attenuators are used for higher power signals.)

The signals are conditioned by up to eight, band-specific modules, supporting two same-band sectors. The conditioned signals of each module are converged and fed to the corresponding (band-specific) MTDI module for digitization.

The MTDI (Multi Technology Digital Interface) unit digitizes and filters up to 16 conditioned cellular RF sectors from one more A-POI shelves. It then combines the signals over a single CPRI link that is routed towards the MSDH.

The MSDH (Multi Sector Digital Hub) serves as the idDAS central switching hub and control system. It routes digitized cellular resources received from MTDI units, along with data from the Ethernet network, over CPRI links towards the relevant remotes.

2. Test Facility & Uncertainty of Measurement

2.1. Accreditation/ Registration reference

- A2LA Certificate Number: 1633.01
- IC Canada: Site# 4808A-1

2.2. Test Facility description

The tests were performed at the EMC Laboratory, QualiTech Division, ECI Telecom Group

Address: 30, Hasivim St., Petah Tikva, Israel.
Tel: 972-3-926-6994

3m Anechoic Chamber:

The 3m-screened chamber is used in two configurations: the semi-anechoic configuration for Radiated Emission measurements and the full-anechoic configuration for Radiated Immunity tests.

3m Anechoic Chamber:

Measurement distance	3m
Chamber dimensions	9.5m x 6.5m x 5.2m
Antenna height	1 - 4m
Shielding Effectiveness	Magnetic field ≥ 80 dB at 15 kHz ≥ 90 dB at 100 kHz Electric field > 120 dB from 1MHz to 1GHz > 110 dB from 1GHz to 10GHz
Absorbing material	Ferrite tiles on the walls and ceiling Emerson and Cuming absorbing material in selected positions on the walls
Normalized Site Attenuation measured at 5 positions	± 3.9 dB, 30MHz to 200MHz ± 3 dB, 200MHz to 1000MHz
Transmission Loss measured at 5 positions, at 1.5m height	± 3 dB, 1GHz to 18GHz

Uncertainty of Measurement:

The data and results referenced in this document are true and accurate. The reader is cautioned that there may be errors within the calibration limits of the equipment and facilities. The measurement uncertainty was calculated for all measurements listed in this test report according to CISPR 16-4-2 “Specification for radio disturbance and immunity measuring apparatus and methods – Part 4-2: Uncertainties, statistics and limit modelling – Uncertainty in EMC measurements “. Furthermore, component and process variability of devices similar to that tested may result in additional deviation. The manufacturer has the sole responsibility of continued compliance of the device.

Test Name	Test Method & Range	Uncertainty	
		Combined std. Uc(y)	Expanded U
Radiated Emission	30MHz÷230MHz, Horiz. polar.	[dB] 1.8	[dB] 3.6
	30MHz÷230MHz, Ver. polar.	1.967	3.934
	230MHz÷1000MHz, Horiz. polar.	1.487	2.973
	230MHz÷1000MHz, Vert. polar.	1.499	2.998
Conducted Emission	9 kHz÷150 kHz	[dB] 1.378	[dB] 2.756
	150 kHz÷30MHz	1.095	2.190
Radio frequency	Up to 18 GHz	$\pm 1 \cdot 10^{-6}$	$< \pm 1 \cdot 10^{-5}$
Total Conducted RF Power	Up to 18 GHz	± 1.378 dB	$< \pm 1.5$ dB
Conducted Power density	Up to 18 GHz	± 1.378 dB	$< \pm 3$ dB
Temperature	23.6 °C	± 0.6 °C	$< \pm 2$ °C
Humidity	54.9%	± 3.1 %	$< \pm 5$ %
DC Voltage	0-60 VDC	± 0.3 %	$< \pm 3$ %

Note: QualiTech EMC labs expanded measurement instrumentation has less uncertainty than the industry norm and compliance is deemed to occur as no measured disturbance exceeds the disturbance limit.

Note: The reported expanded uncertainty is based on a standard uncertainty multiplied by a coverage factor of k=2, providing a level of confidence of approximately 95%.

3. Examination Test Results

3.1. Out-of-Band Rejection

Reference document:	KDB 935210 D05 v01r01		
Method of testing:	KDB 935210 D05 v01r01, Conducted	Done	
Operating conditions:	Under normal test conditions		
Environment conditions:	Ambient Temperature: 22°C	Relative Humidity: 48%	Atmospheric Pressure: 1011.4 hPa
Test Result:	See below	See Plot 3.1	

Test results:

Modulation	±250% of Passband*, MHz	Frequency fo, MHz	-20dB lowest point, MHz	-20dB highest point, MHz
CW	1767.5....2157.5	1940.200	1928.700	1996.300

* 65MHz passband

Plot 3.1: Out-of-Band rejection, CW

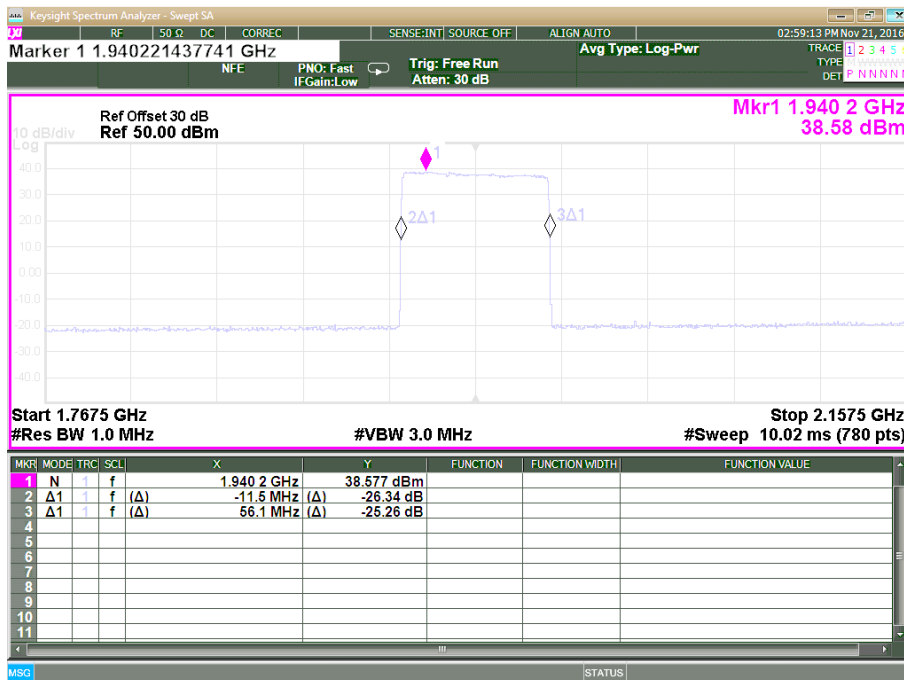

3.2. Occupied Bandwidth - Input-versus-output signal comparison

Reference document:	47 CFR §24.238(b), §2.1049(h)		
Test Requirements:	The emission bandwidth is defined as the width of the signal between two points, one below the carrier center frequency and one above the carrier center frequency, outside of which all emissions are attenuated at least 26 dB below the transmitter power. The spectral plot of the input signal shall be similar to the output signal		
Method of testing:	KDB 935210 D05 v01r01, Conducted	Pass	
Operating conditions:	Under normal test conditions		
Environment conditions:	Ambient Temperature: 22°C	Relative Humidity: 48%	Atmospheric Pressure: 1011.4 hPa
Test Result:	See below	See Plot 3.2.1 - Plot 3.2.2	

Test results:

Mode	Operating Frequency, MHz	26dB Bandwidth, MHz	
		Output	Input
		0.5dB below AGC	0.5dB below AGC
MSK, Gaussian filter 0.3 data rate 270kbps	1962.500	308.360 kHz	321.000 kHz
AWGN 4.1MHz	1962.500	4.665 MHz	4.667 MHz

Note – Only at MSK modulation (GSM) the Composite Output Power transmission is 40dBm

Plot 3.2.1: Input-versus-output signal comparison, MSK, Gaussian filter 0.3 data rate 270kbps

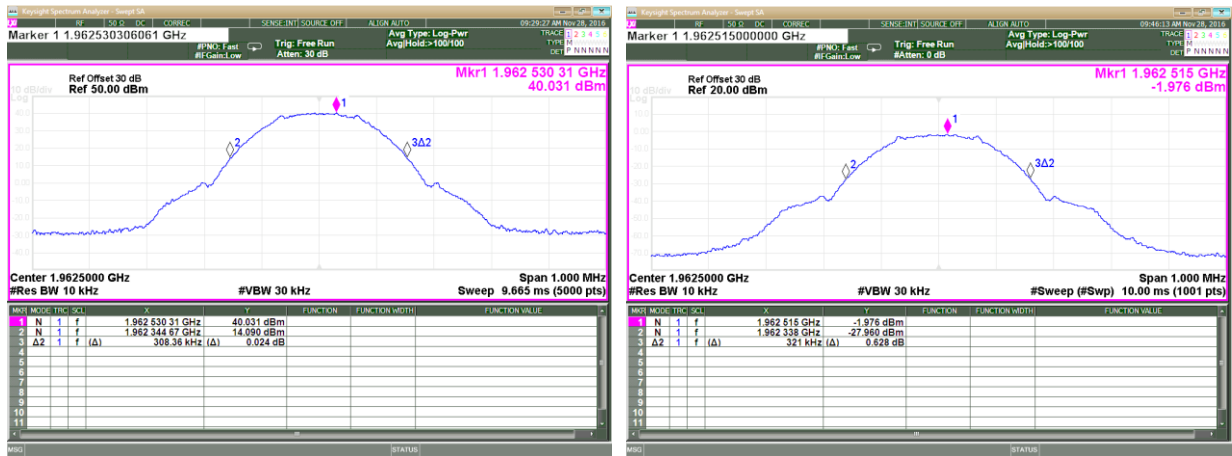

Output

Input

Plot 3.2.2: Input-versus-output signal comparison, AWGN 4.1MHz

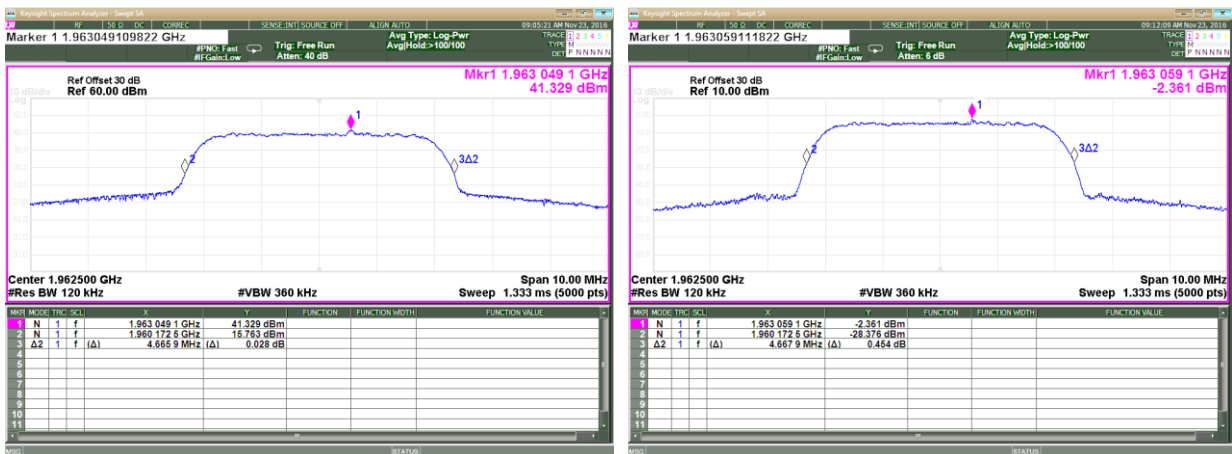

Output

Input

3.3. Mean Output Power and Amplifier/Booster Gain

Reference document:	47 CFR §24.232(a)(1), (a)(2), 47 CFR §2.1046		
Test Requirements:	(a)(1) Base stations with an emission bandwidth of 1 MHz or less are limited to 1640 watts equivalent isotropically radiated power (EIRP) with an antenna height up to 300 meters HAAT; (a)(2) Base stations with an emission bandwidth greater than 1 MHz are limited to 1640 watts/MHz equivalent isotropically radiated power (EIRP) with an antenna height up to 300 meters HAAT		
Method of testing:	For 47CFR: KDB 935210 D05 v01r01, sec 3.5(power meter method);	Pass	
Operating conditions:	Under normal test conditions		
Environment conditions:	Ambient Temperature: 22°C	Relative Humidity: 48%	Atmospheric Pressure: 1011.4 hPa
Test Result:	See below	-	

Test results:

Mode	Operating Frequency (fo) ¹ , MHz	Measured AVG Power				Mean Gain ² [dBm]	Max Ant Gain [dBi]	EIRP Calculated [W]	Power Limit [W/MHz]	Delta	Pass/Fail
		Output		Input							
MSK, Gaussian filter 0.3 data rate 270kbps	1940.2	41.11 dBm	12.912 W	990 micro W	-0.04	41.15	14	324.340	1640	-1315.660	Pass
AWGN 4.1 MHz	1940.2	43.154 dBm	20.654 w	978 micro W	-0.09	43.24	14	518.800	1640	-1121.200	Pass

¹ from "Out-of-Band Rejection" test

² Mean Gain [dB] = Measured AVG Power (Output) [W] - Measured AVG Power (Input) [W]

Note – only at MSK modulation (GSM) the Composite Output Power transmission is 40dBm

3.4. Out-of-Band/Out-of-Block & Intermodulation Emissions Conducted Measurements

Reference document:	47 CFR §24.238(a), §2.1051		
Test Requirements:	<p>§24.238(a) The power of any emission outside of the authorized operating frequency ranges must be attenuated below the transmitting power (P) by a factor of at least $43 + 10 \log(P)$ dB*</p> <p>§2.1051 The radio frequency voltage or powers generated within the equipment and appearing on a spurious frequency shall be checked at the equipment output terminals when properly loaded with a suitable artificial antenna. Curves or equivalent data shall show the magnitude of each harmonic and other spurious emission that can be detected when the equipment is operated under the conditions specified in §2.1049 as appropriate. The magnitude of spurious emissions which are attenuated more than 20 dB below the permissible value need not be specified</p>		
Method of testing:	KDB 935210 D05v01r01, 3.6.2, Conducted	Pass	
Operating conditions:	Under normal test conditions		
S.A. Settings:	RBW: minimum 1% of EBW or 100kHz or 1MHz; VBW: 3 times RBW		
Environment conditions:	Ambient Temperature: 22°C	Relative Humidity: 48%	Atmospheric Pressure: 1011.4 hPa
Test Result:	See below	See Plot 3.4.1 - Plot 3.4.8	

*It translates to a limit of -13dBm

Test results:

Modulation	Operating Frequency, MHz		Emission Frequency, MHz	Emission Level, dBm	Limit, dBm	Delta, dB	Pass/Fail
	Carrier 1	Carrier 2					
MSK Gaussian filter 0.3 data rate 270kbps	1930.200	NA	1930.000	-22.46	-13.00	-9.46	Pass
	1930.200	1930.400	1930.000	-16.23	-13.00	-3.23	Pass
	1994.800	NA	1995.000	-22.45	-13.00	-9.45	Pass
	1994.600	1994.800	1995.000	-23.89	-13.00	-10.89	Pass
AWGN 4.1MHz	1932.500	NA	1930.000	-18.78	-13.00	-5.78	Pass
	1932.500	1937.500	1930.000	-21.77	-13.00	-8.77	Pass
	1992.500	NA	1995.000	-19.45	-13.00	-6.45	Pass
	1992.500	1987.500	1995.000	-20.32	-13.00	-7.32	Pass

Note – Only at MSK Modulation (GSM) the Composite Output Power transmission is 40dBm

Plot 3.4.1: Band Edge test results, MSK Gaussian filter 0.3 data rate 270kbps, Fc = 1930.200 MHz, single test signal

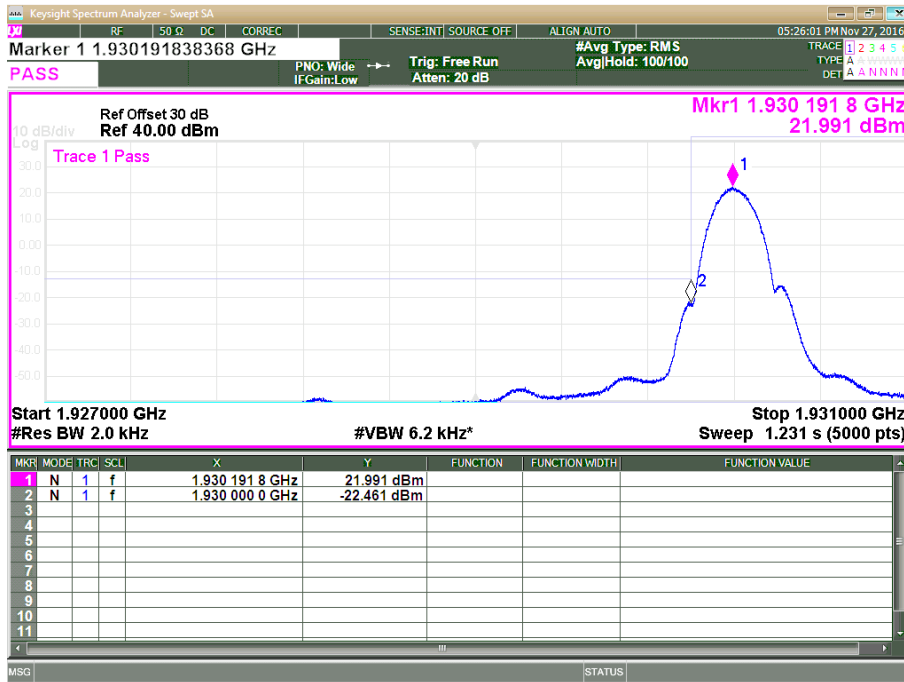

Plot 3.4.2: Band Edge test results, MSK Gaussian filter 0.3 data rate 270kbps, Fc = 1930.200 + 1930.400 MHz, two test signals

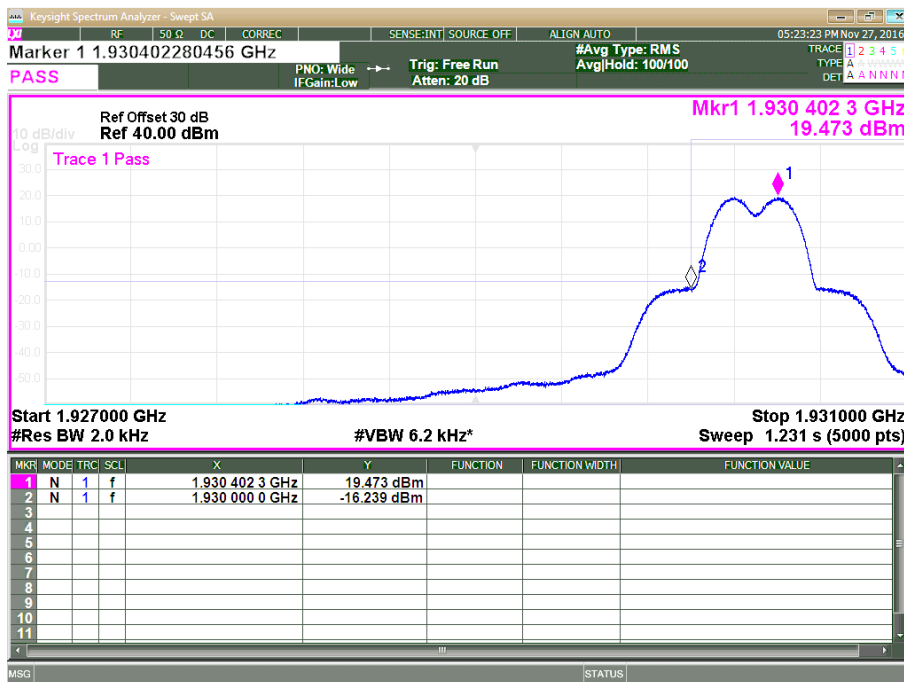

Plot 3.4.3: Band Edge test results, MSK Gaussian filter 0.3 data rate 270kbps, Fc = 1994.800 MHz, single test signal

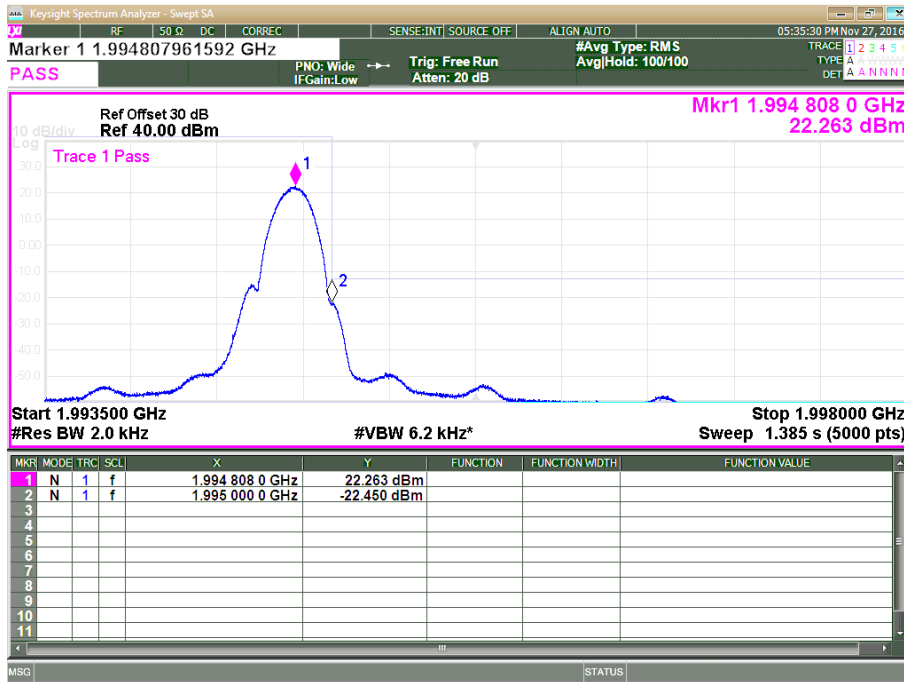

Plot 3.4.4: Band Edge test results, MSK Gaussian filter 0.3 data rate 270kbps, Fc = 1994.600 MHz + 1994.800 MHz, two test signals

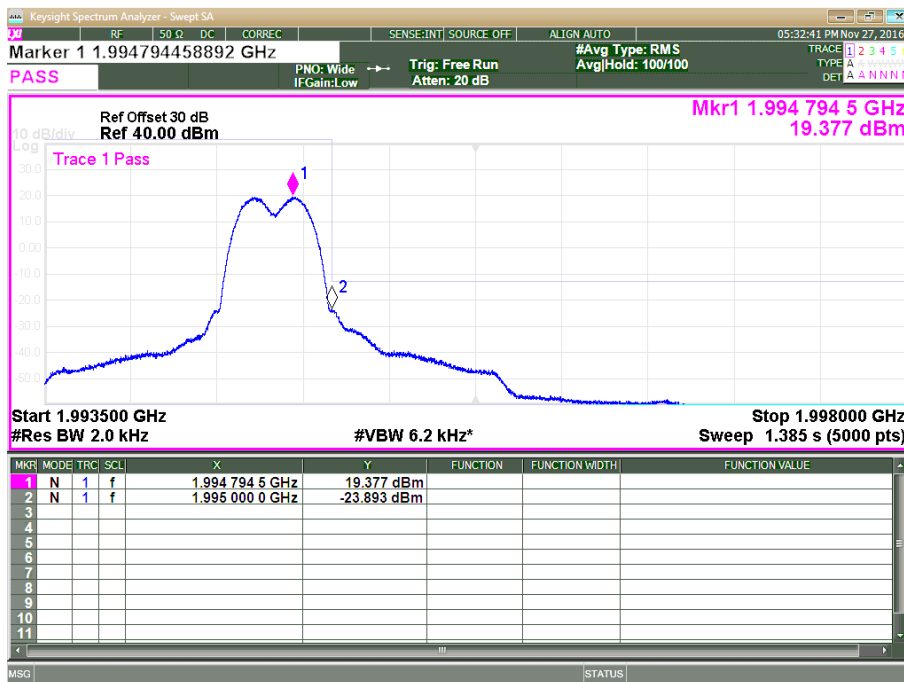

Plot 3.4.5: Band Edge test results, AWGN 4.1MHz, Fc = 1932.500 MHz, single test signal

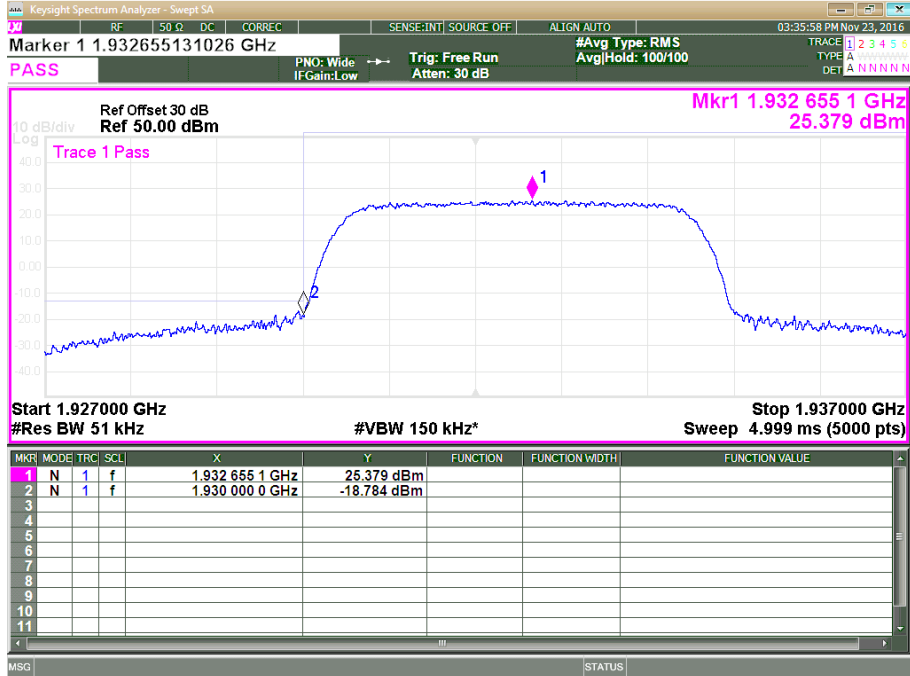

Plot 3.4.6: Band Edge test results, AWGN 4.1MHz, Fc = 1932.500 MHz, +1937.500 MHz, two test signals

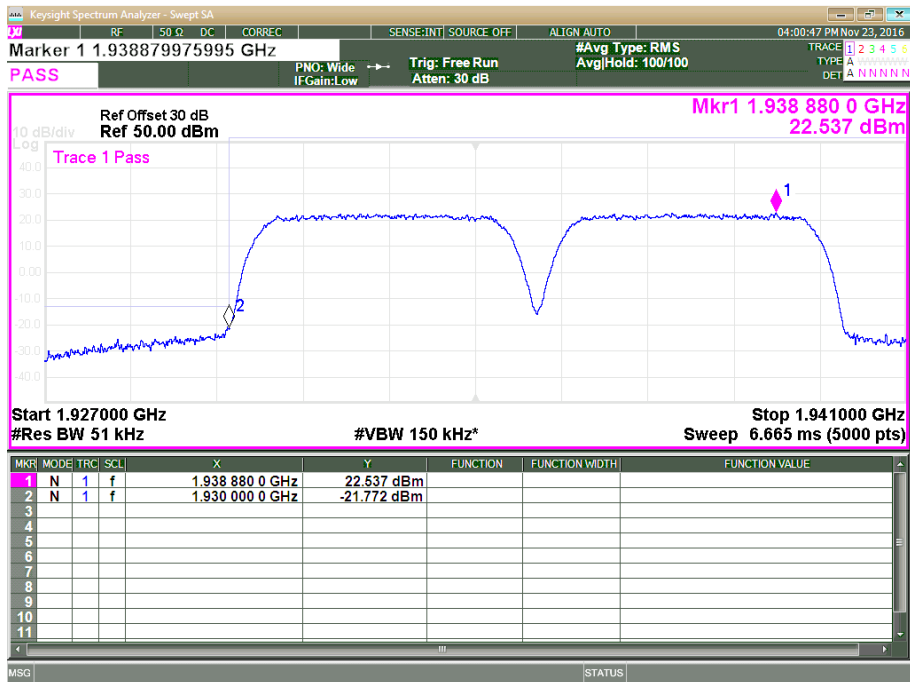

Plot 3.4.7: Band Edge test results, AWGN 4.1MHz, Fc = 1992.500 MHz, single test signal

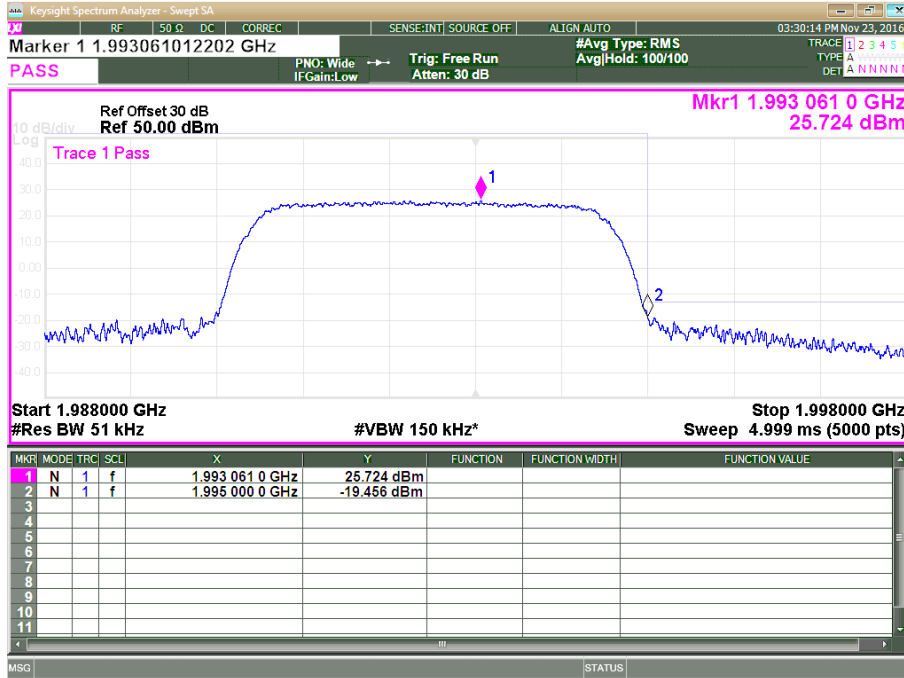

Plot 3.4.8: Band Edge test results, AWGN 4.1MHz, Fc = 1992.500MHz + 1987.500 MHz, two test signals

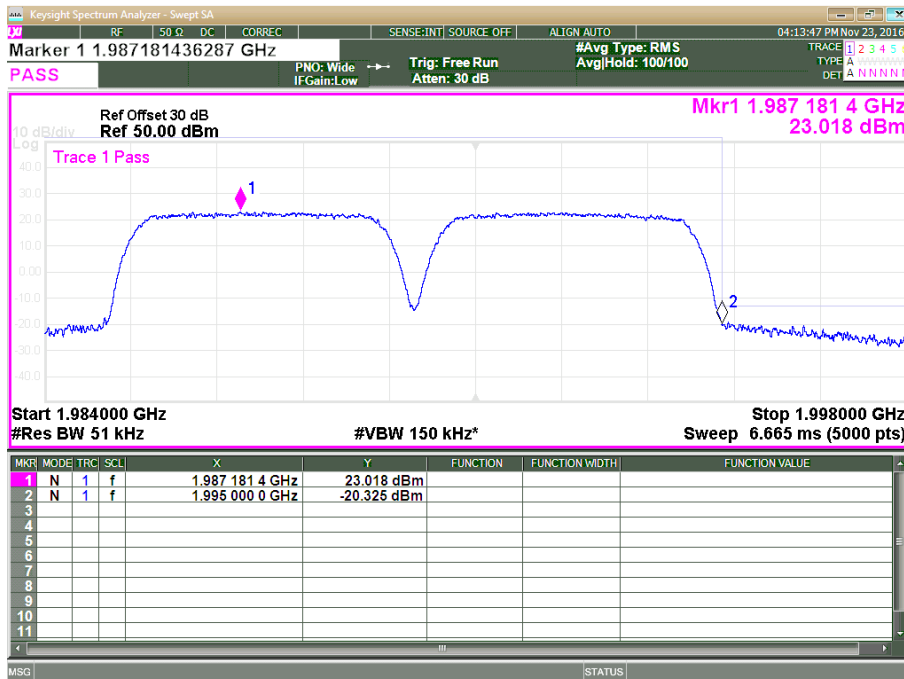

3.5. Spurious Emission Conducted Measurement

Reference document:	47 CFR §24.238(a), 47 CFR §2.1051		
Test Requirements:	<p>§24.238(a) The power of any emission outside of the authorized operating frequency ranges must be attenuated below the transmitting power (P) by a factor of at least $43 + 10 \log(P)$ dB*</p> <p>§2.1051 The radio frequency voltage or powers generated within the equipment and appearing on a spurious frequency shall be checked at the equipment output terminals when properly loaded with a suitable artificial antenna. Curves or equivalent data shall show the magnitude of each harmonic and other spurious emission that can be detected when the equipment is operated under the conditions specified in §2.1049 as appropriate. The magnitude of spurious emissions which are attenuated more than 20 dB below the permissible value need not be specified</p>		
Method of testing:	KDB 935210 D05 v01r01	Pass	
Operating conditions:	Under normal test conditions		
S.A. Settings:	RBW: 1MHz, VBW: 3MHz		
Environment conditions:	Ambient Temperature: 22°C	Relative Humidity: 48%	Atmospheric Pressure: 1011.4 hPa
Test Result:	See below	See Plot 3.5.1 - Plot 3.5.12	

*It translates to a limit of -13dBm

Test Results: all emission were at least 10 dB below the limit

Plot 3.5.1: Spurious Emission Conducted Measurement, MSK Gaussian filter 0.3 data rate 270kbps, Fc = 1930.200 MHz, 9 kHz – 2.5 GHz

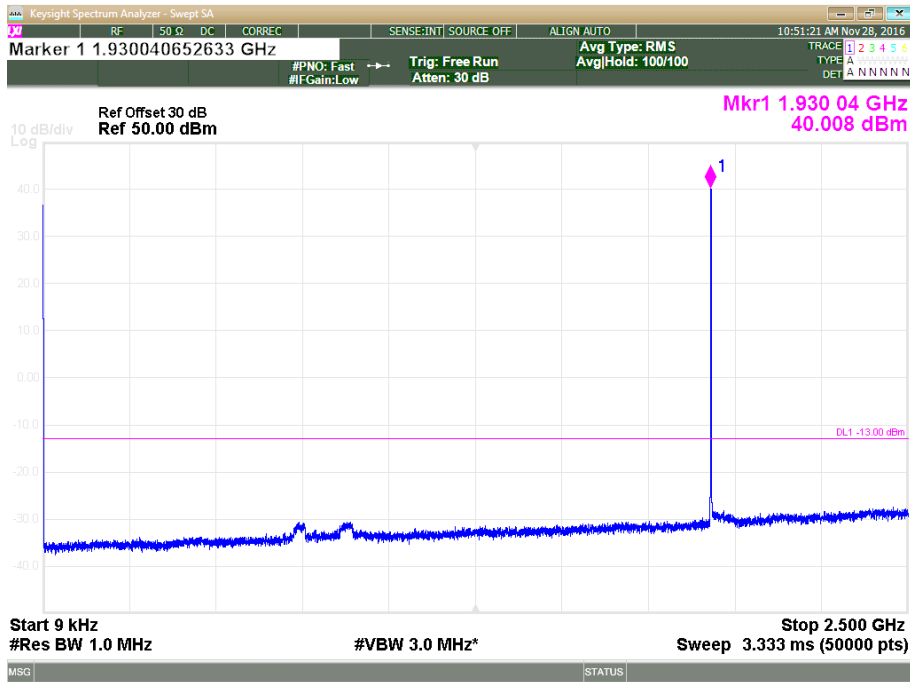

Plot 3.5.2: Spurious Emission Conducted Measurement, MSK Gaussian filter 0.3 data rate 270kbps, Fc = 1930.200 MHz, , 2.5 GHz – 20.0 GHz

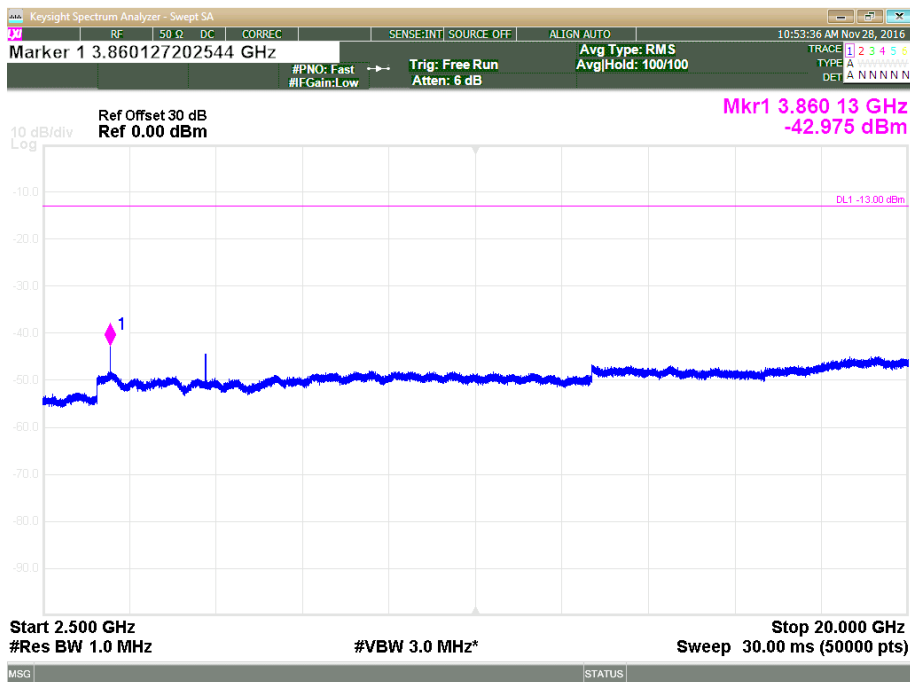

With filter WHK2.4/18G-10EF

Plot 3.5.3: Spurious Emission Conducted Measurement, MSK Gaussian filter 0.3 data rate 270kbps, Fc = 1962.500, 9 kHz – 2.5 GHz

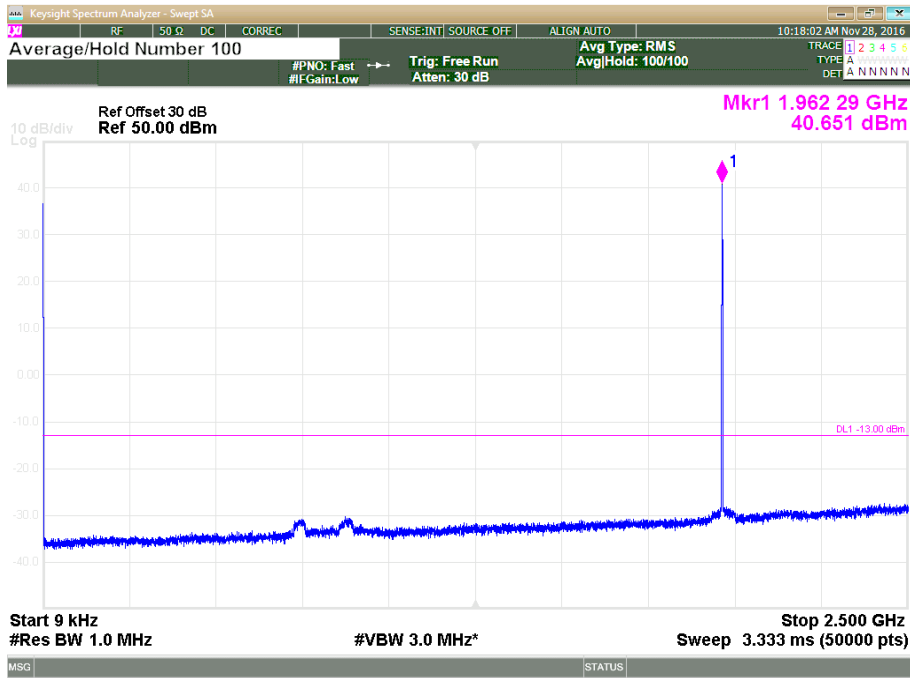

Plot 3.5.4: Spurious Emission Conducted Measurement, MSK Gaussian filter 0.3 data rate 270kbps, Fc = 1962.500, 2.5 GHz – 20.0 GHz

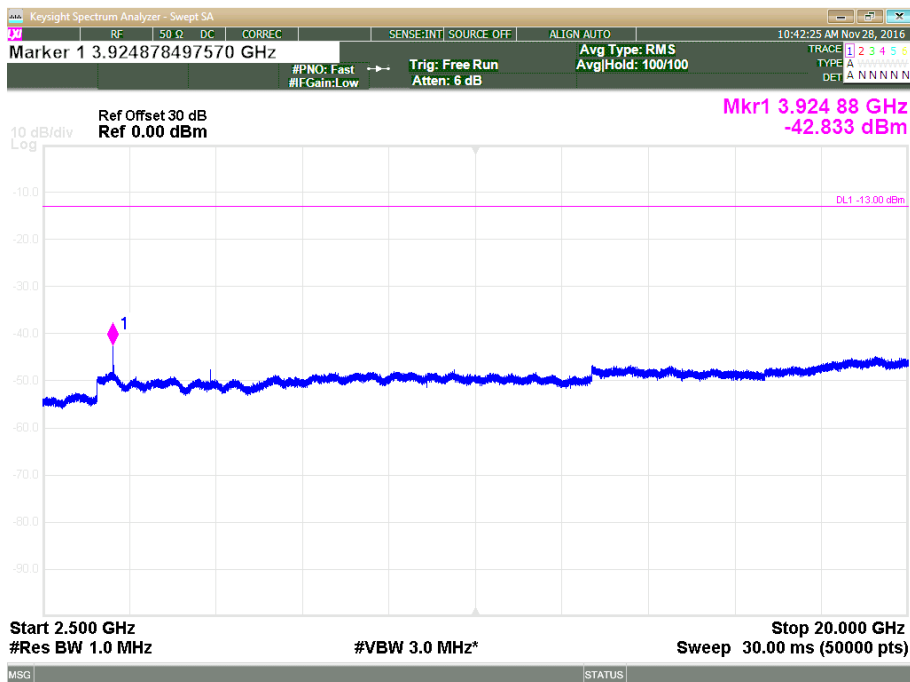

With filter WHK2.4/18G-10EF

**Plot 3.5.5: Spurious Emission Conducted Measurement, MSK Gaussian filter 0.3 data rate 270kbps
Fc = 1994.800 MHz, 9 kHz – 2.5 GHz**

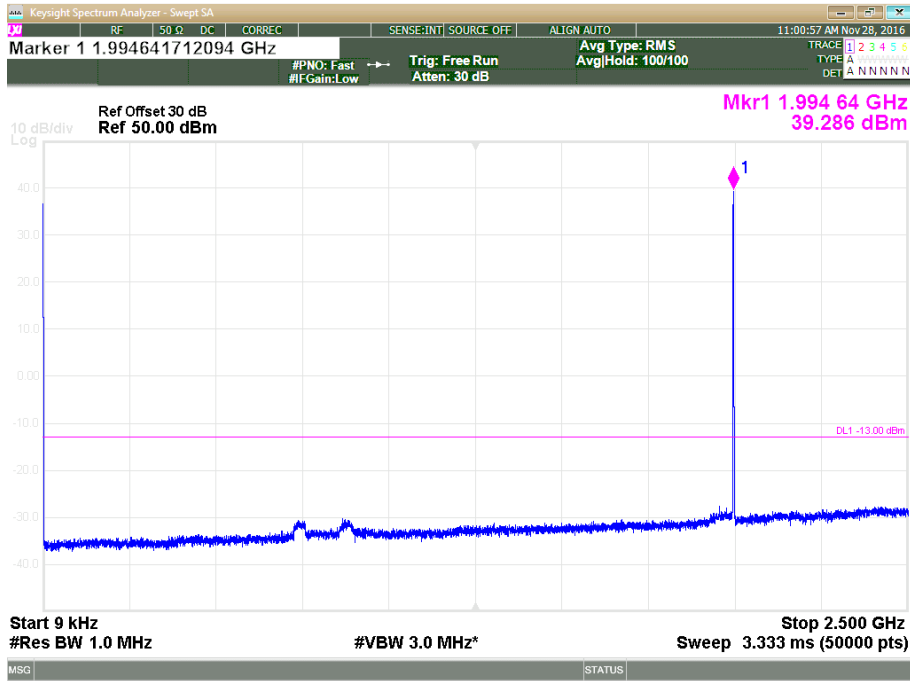

**Plot 3.5.6: Spurious Emission Conducted Measurement, MSK Gaussian filter 0.3 data rate 270kbps,
Fc = 1994.800 MHz, 2.5 GHz – 20.0 GHz**

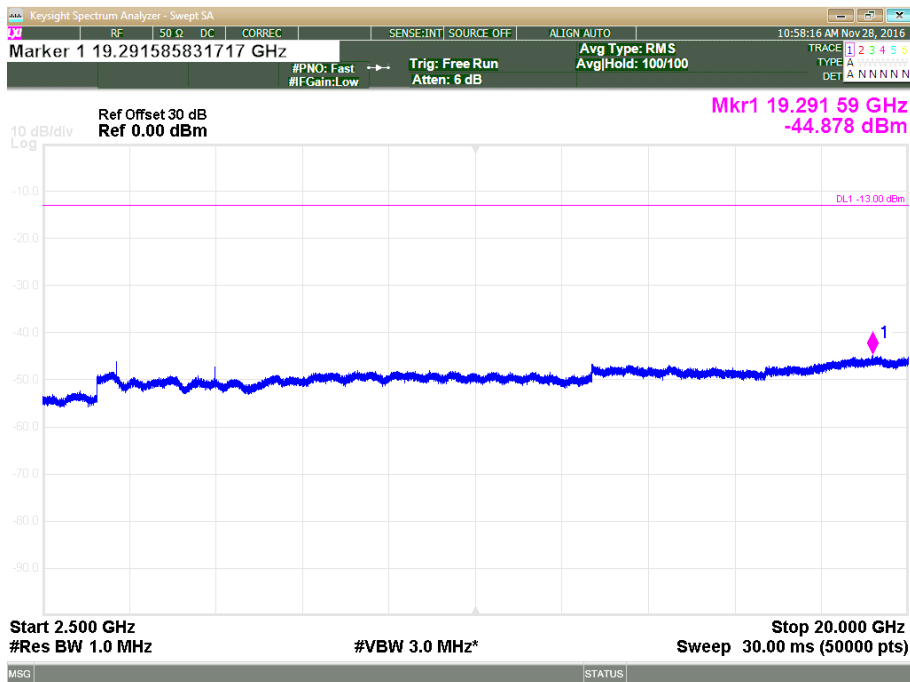

With filter WHK2.4/18G-10EF

Plot 3.5.7: Spurious Emission Conducted Measurement, AWGN 4.1MHz, Fc = 1932.50 MHz, 9 kHz – 2.5 GHz

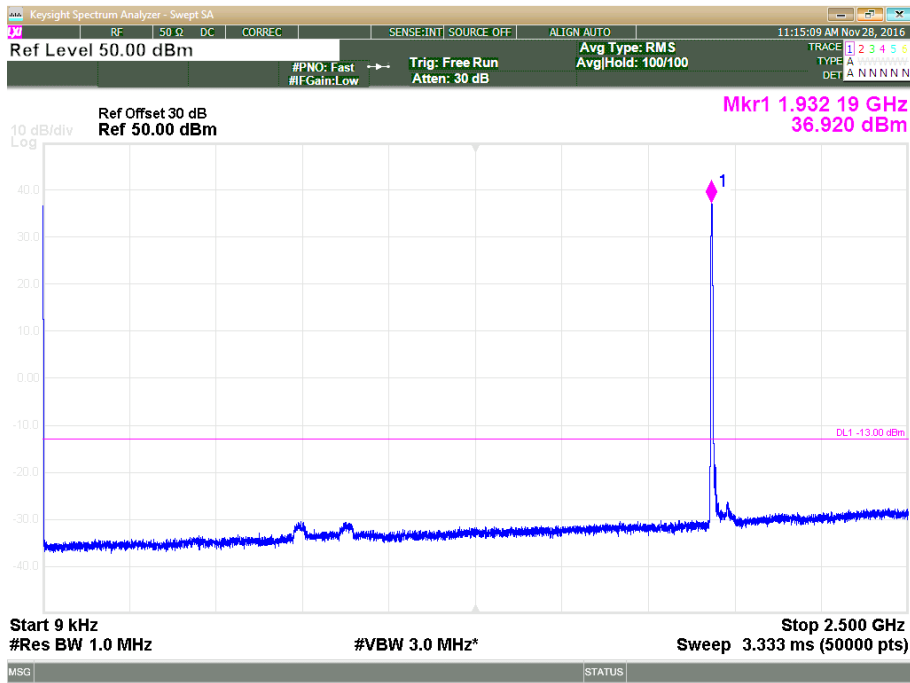

Plot 3.5.8: Spurious Emission Conducted Measurement, AWGN 4.1MHz, Fc = 1932.50 MHz, 2.5 GHz – 20.0 GHz

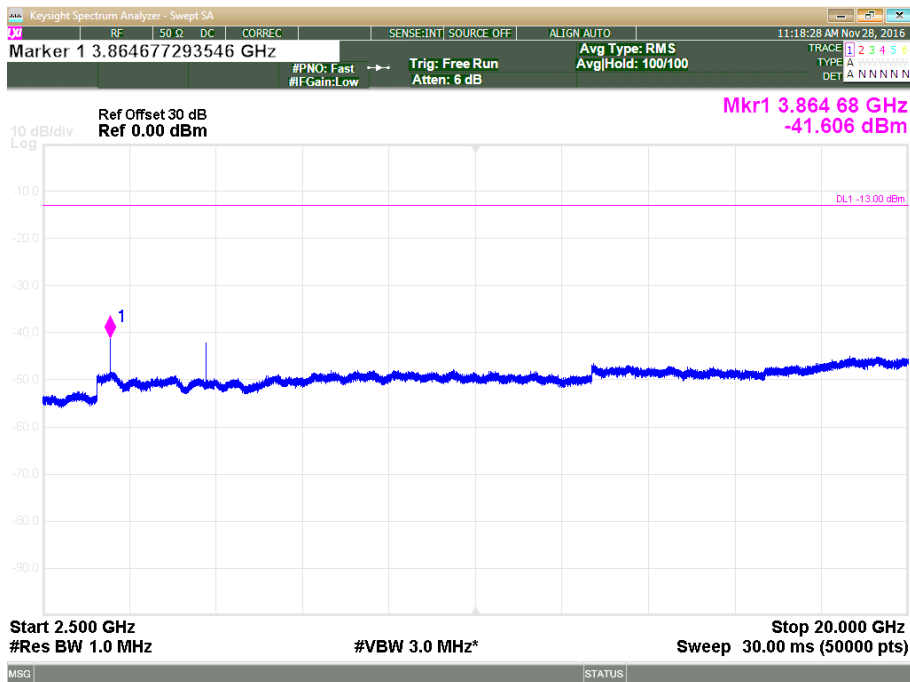

With filter WHK2.4/18G-10EF

Plot 3.5.9: Spurious Emission Conducted Measurement, AWGN 4.1MHz, Fc = 1962.50 MHz, 9 kHz – 30 MHz

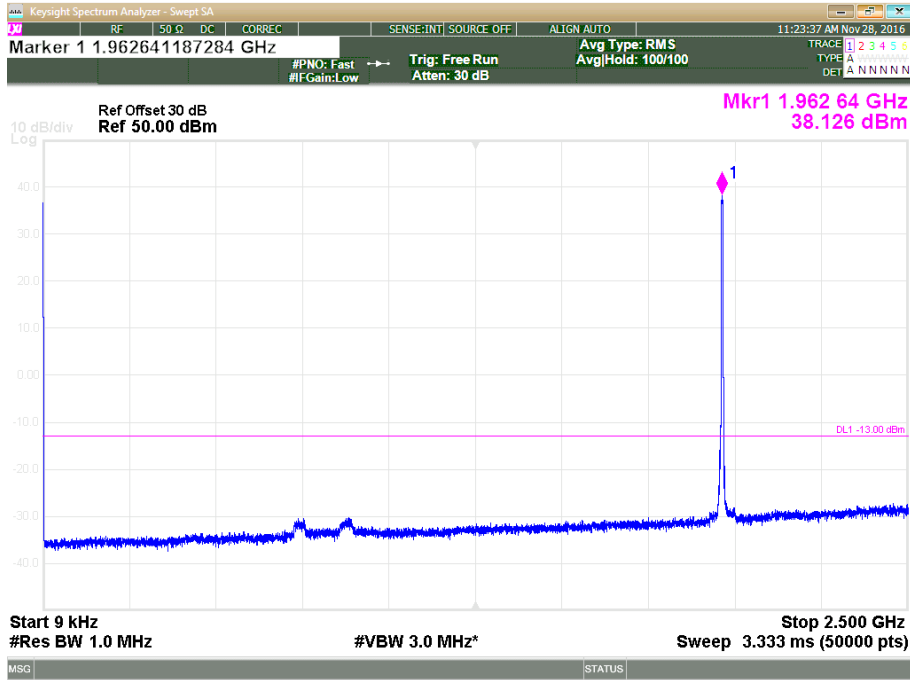

Plot 3.5.10: Spurious Emission Conducted Measurement, AWGN 4.1MHz, Fc = 1962.50 MHz, 2.5 GHz – 20.0 GHz

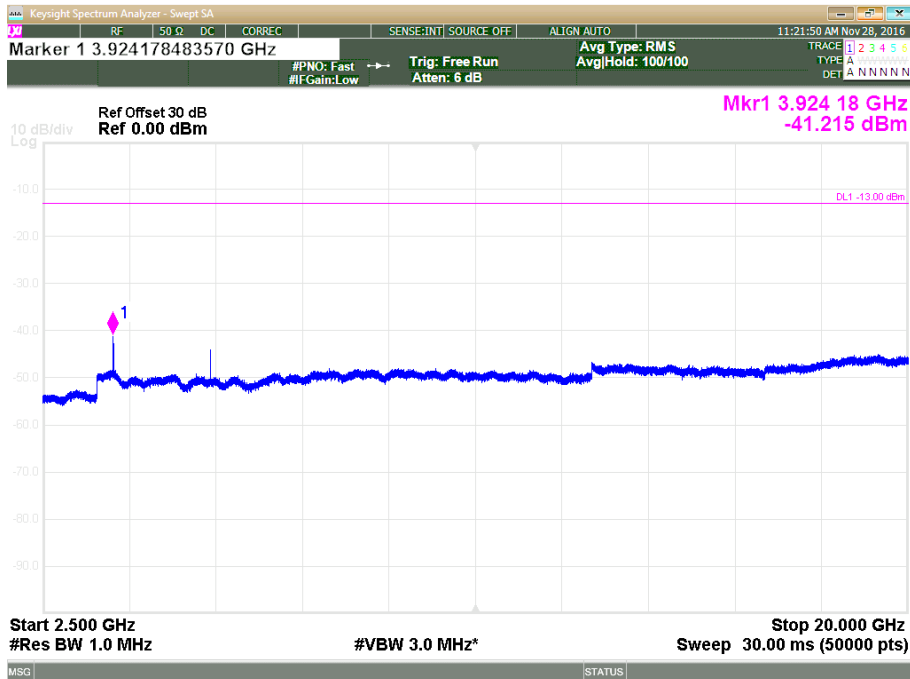

With filter WHK2.4/18G-10EF

Plot 3.5.11: Spurious Emission Conducted Measurement, AWGN 4.1MHz, Fc = 1992.50 MHz, 9 kHz – 2.5 GHz

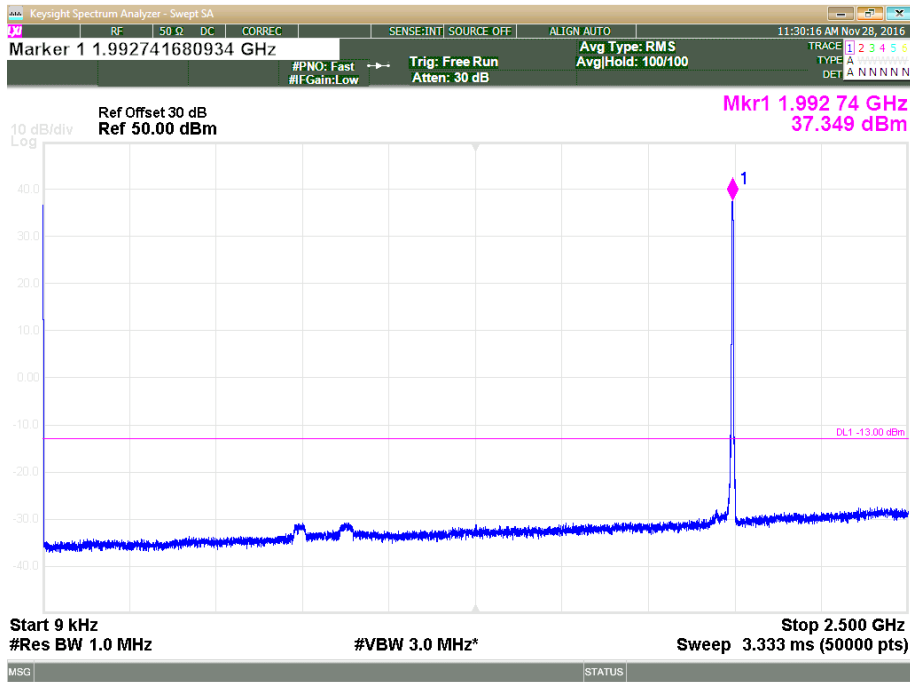

Plot 3.5.12: Spurious Emission Conducted Measurement, AWGN 4.1MHz, Fc = 1992.50, 2.5 GHz – 20.0 GHz

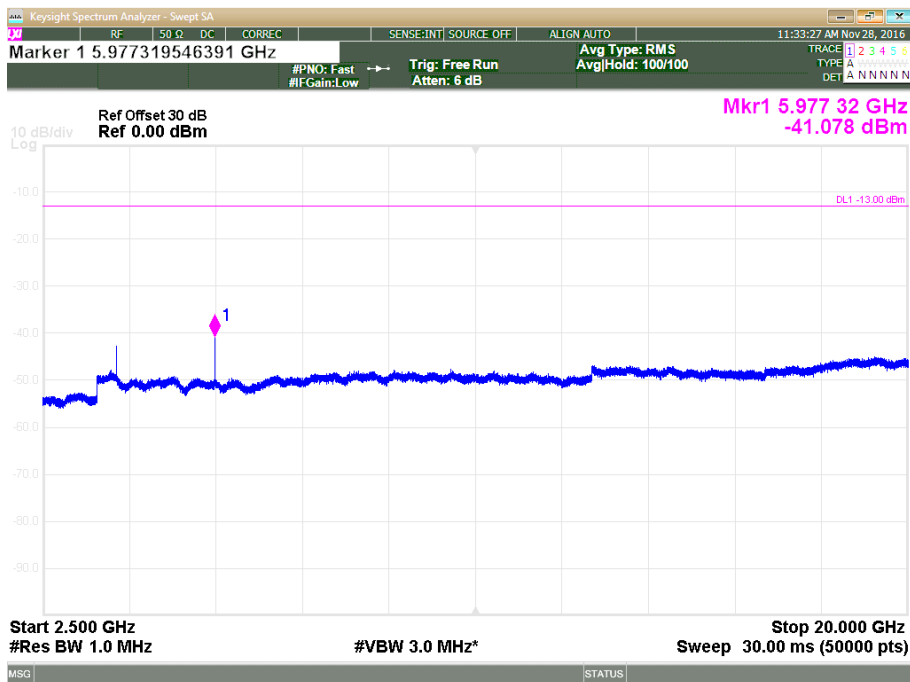

With filter WHK2.4/18G-10EF

3.6. Spurious Emission, Radiated Measurements

Reference document:	47 CFR §24.238 & 47 CFR §2.1053		
Test Requirements:	<p>§24.238(a) The power of any emission outside of the authorized operating frequency ranges must be attenuated below the transmitting power (P) by a factor of at least $43 + 10 \log(P)$ dB* §2.1053 Measurements shall be made to detect spurious emissions that may be radiated directly from the cabinet, control circuits, power leads, or intermediate circuit elements under normal conditions of installation and operation. Curves or equivalent data shall be supplied showing the magnitude of each harmonic and other spurious emission</p>		
Method of testing:	KDB 935210 D05v01r01, Radiated KDB 971168[R8]	Pass	
Operating conditions:	Under normal test conditions		
S.A. Settings:	RBW: 1MHz, VBW: 3MHz		
Environment conditions:	Ambient Temperature: 22°C	Relative Humidity: 48%	Atmospheric Pressure: 1011.4 hPa
Test Result:	See below	Plots 3.6.1-3.6.12	

*It translates to a limit of $-13\text{dBm} = 84 \text{ dB}\mu\text{V/m}$ @3m distance

Note: All measurements performed with 4 simultaneous transmissions:

Low frequency: 728.2 MHz, 862.2 MHz, 1930.2 MHz, 2110.2 MHz

Middle frequency: 737.0 MHz, 865.5 MHz, 1962.5 MHz, 2145.0 MHz

High frequency: 745.8 MHz, 868.8 MHz, 1994.8 MHz, 2179.8 MHz

-All measurements were done in horizontal and vertical polarizations; the table below shows the worst case.

Test Results:

Frequency, MHz	Emission Level, dBμV/m	Antenna Polarization	Substitution Method				Limit [dBm]	Margin, dB	Pass/Fail	Ref Plots
			Signal generator output, [dBm]	Antenna Gain, [dBd]	Cable Loss, dB	Calculated ERP*, [dBm]				
Low Frequency										
863.20	80.34		Transmission frequencies							3.6.1 -3.6.4
1930.20	72.67									
2109.90	68.18									
3860.40	59.49	V	-40.0	7.50	3.50	-36.00	-13.0	-23.00	Pass	
4220.40	73.50	V	-27.0	8.40	3.61	-22.21	-13.0	-9.21	Pass	

Frequency, MHz	Emission Level, dBµV/m	Antenna Polarization	Substitution Method				Limit [dBm]	Margin, dB	Pass/Fail	Ref Plots	
			Signal generator output, [dBm]	Antenna Gain, [dBd]	Cable Loss, dB	Calculated ERP*, [dBm]					
Mid Frequency											
866.60	75.99	Transmission frequencies									3.6.5 - 3.6.8
1962.20	73.83										
2144.90	68.67										
3924.80	68.64	V	-30.9	7.5	3.38	-26.78	-13.0	-13.78	Pass		
4289.80	78.10	V	-22.5	8.2	3.60	-17.9	-13.0	-4.90	Pass		

Frequency, MHz	Emission Level, dBµV/m	Antenna Polarization	Substitution Method				Limit [dBm]	Margin, dB	Pass/Fail	Ref Plots	
			Signal generator output, [dBm]	Antenna Gain, [dBd]	Cable Loss, dB	Calculated ERP*, [dBm]					
High Frequency											
868.50	77.88	Transmission frequencies									3.6.9 - 3.6.12
1994.80	71.89										
2179.00	68.75										
3989.60	70.91	V	-28.7	7.56	3.38	-24.52	-13.0	-11.52	Pass		
4359.30	71.98	V	-28.5	8.20	3.62	-23.92	-13.0	-10.92	Pass		

*Calculated ERP = Signal Generator Output + Antenna Gain – Cable Loss

Plot 3.6.1: Spurious Emission test results, 30 MHz – 1 GHz range, Horizontal polarization, Low Frequency

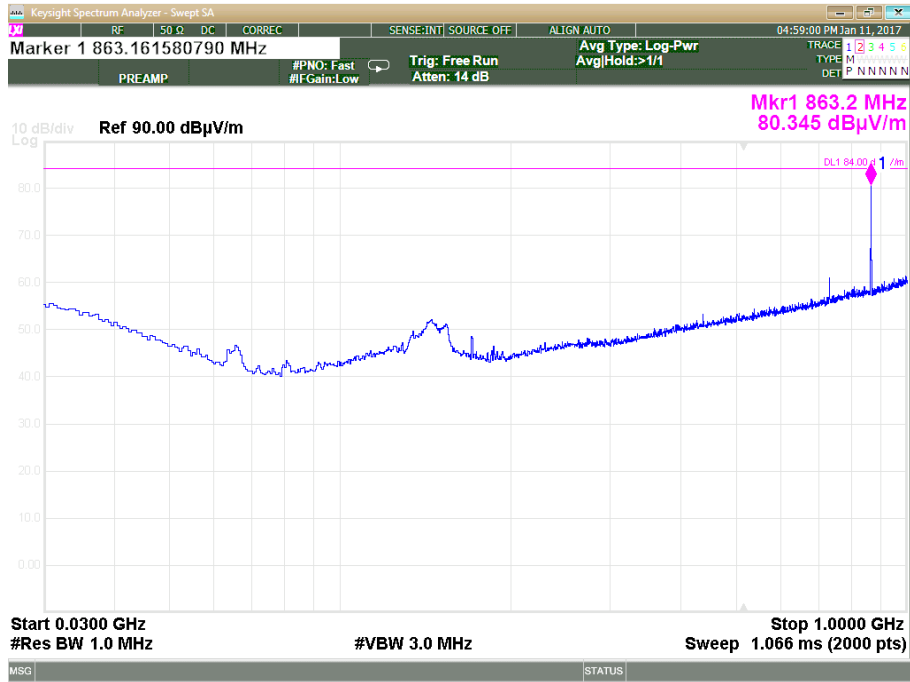

Plot 3.6.2: Spurious Emission test results, 30 MHz – 1 GHz range, Vertical polarization, Low Frequency

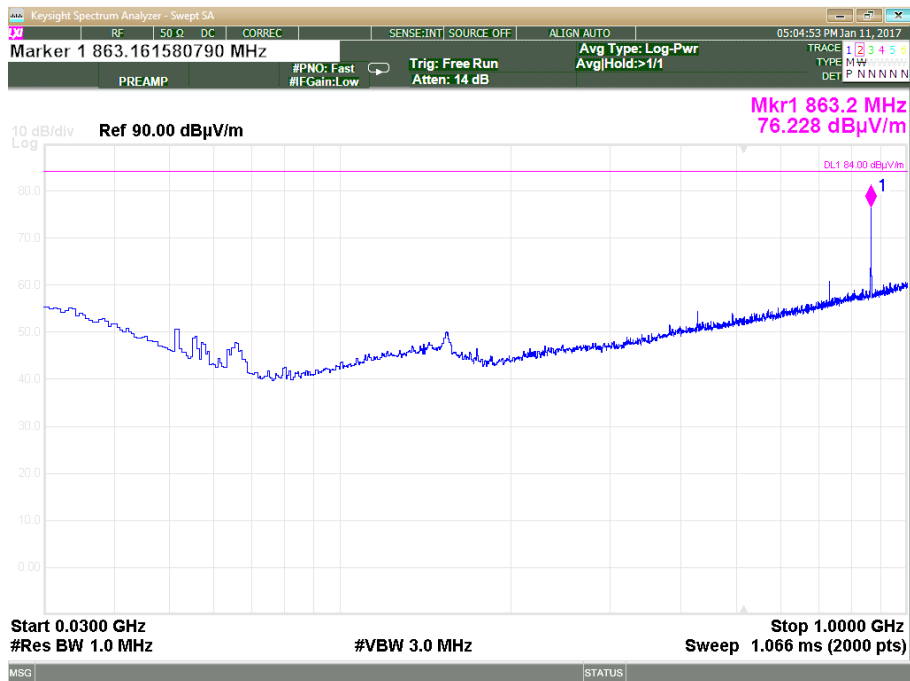

Plot 3.6.3: Spurious Emission test results, 1 GHz – 22 GHz range, Horizontal polarization, Low Frequency

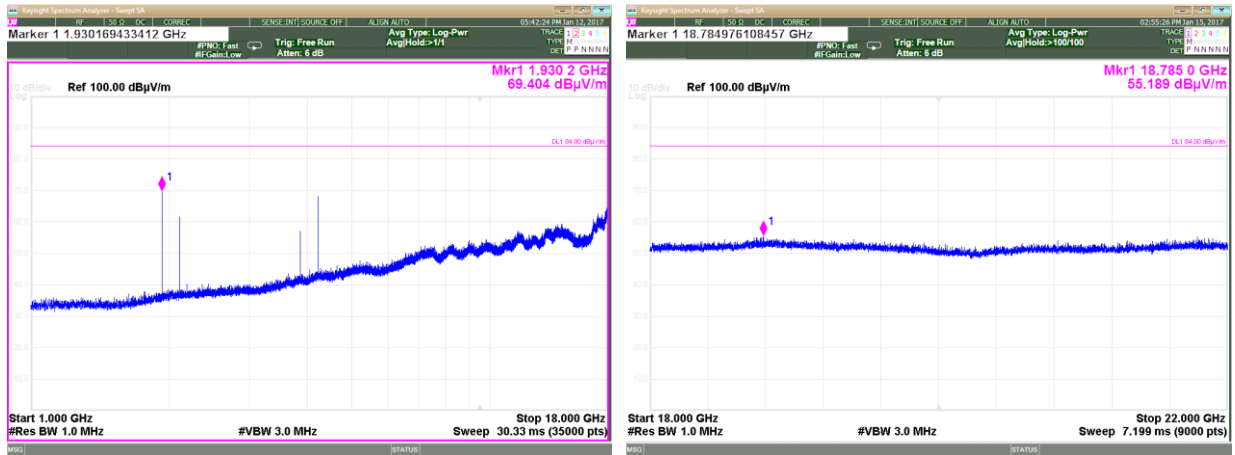

Plot 3.6.4: Spurious Emission test results, 1 GHz – 22 GHz range, Vertical polarization, Low Frequency

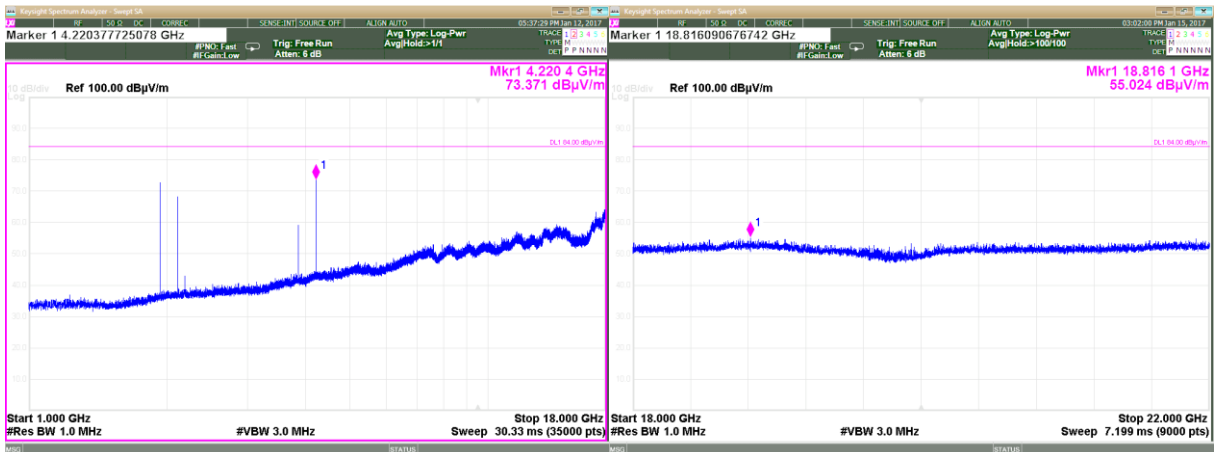

Plot 3.6.5: Spurious Emission test results, 30 MHz – 1 GHz range, Horizontal polarization, Middle Frequency

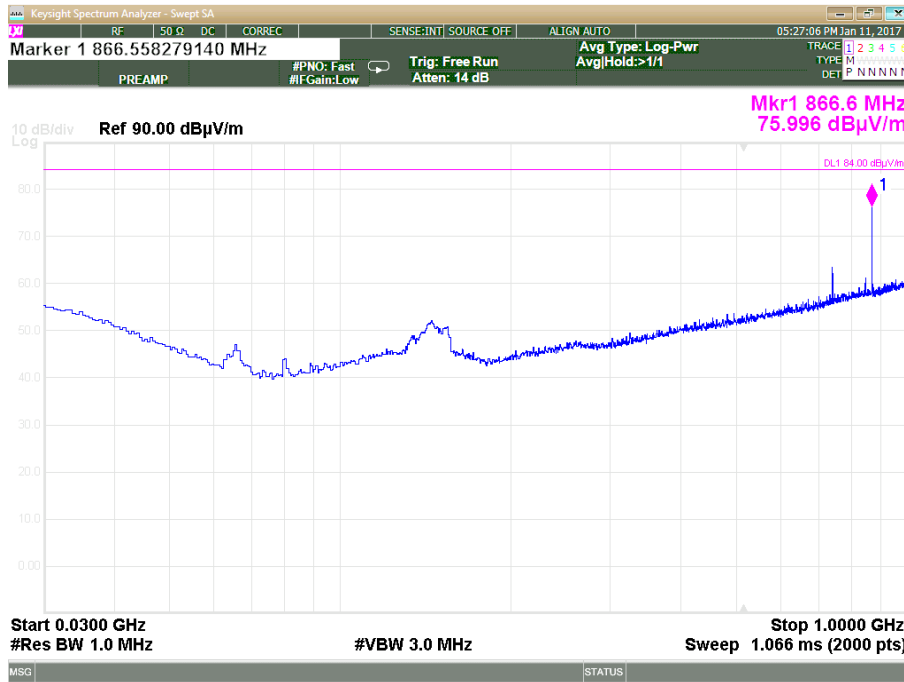

Plot 3.6.6: Spurious Emissions test results, 30 MHz – 1 GHz range, Vertical polarization, Middle Frequency

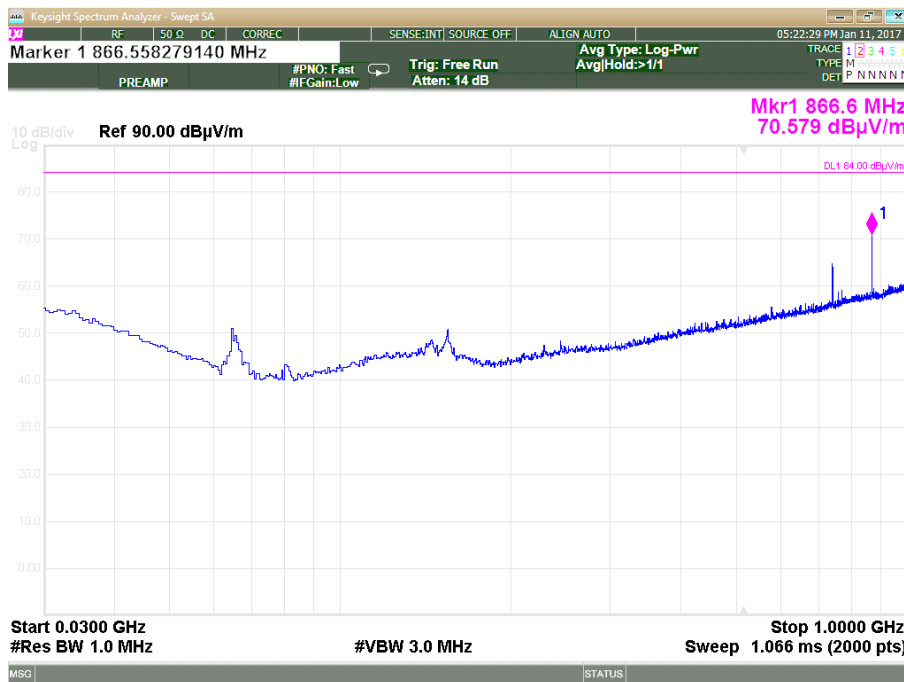

Plot 3.6.7: Spurious Emissions test results, 1 GHz – 22 GHz range, Horizontal polarization, Middle Frequency

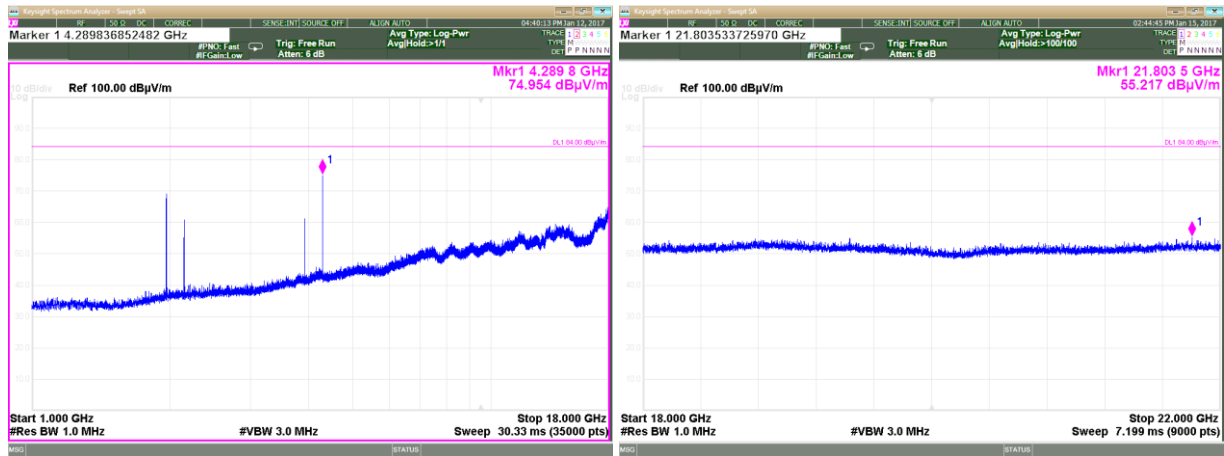

Plot 3.6.8: Spurious Emissions test results, 1 GHz – 22GHz range, Vertical polarization, Middle Frequency

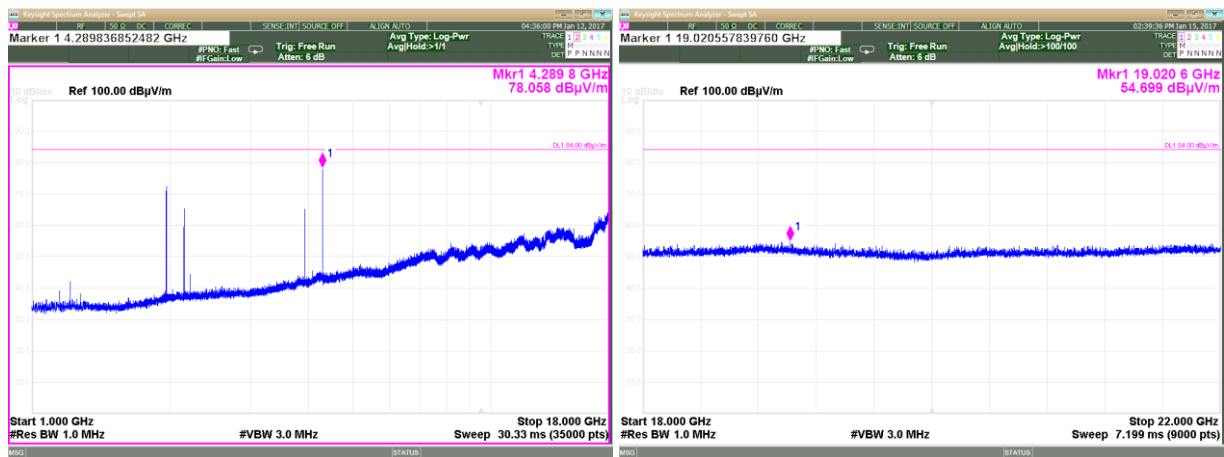

Plot 3.6.9: Spurious Emissions test results, 30 MHz – 1GHz range, Horizontal polarization, High Frequency

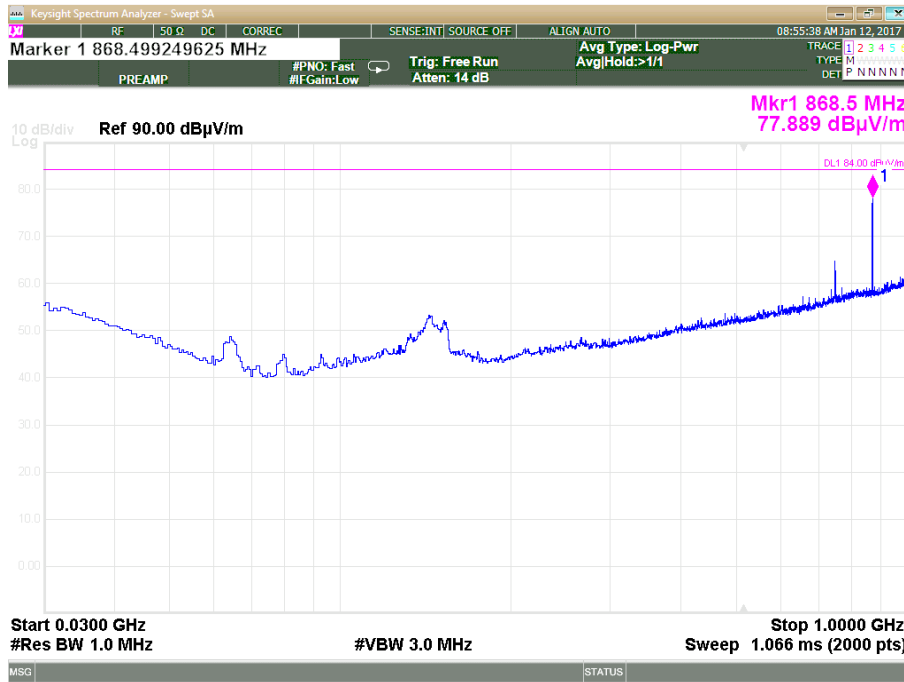

Plot 3.6.10: Spurious Emissions test results, 30 MHz – 1GHz range, Vertical polarization, High Frequency

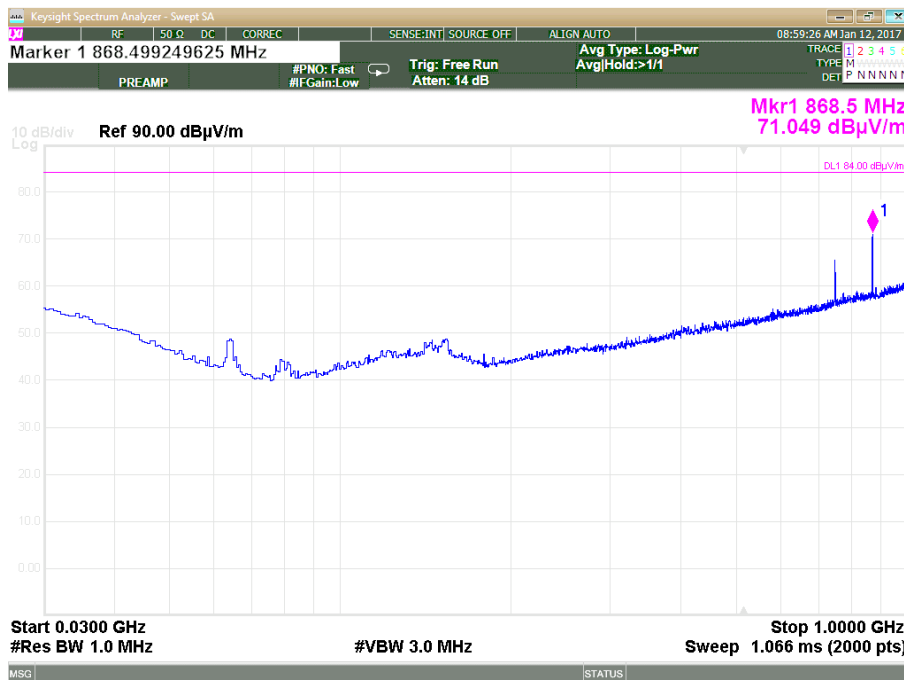

Plot 3.6.11: Spurious Emissions test results, 1 GHz – 22 GHz range, Horizontal polarization, High Frequency

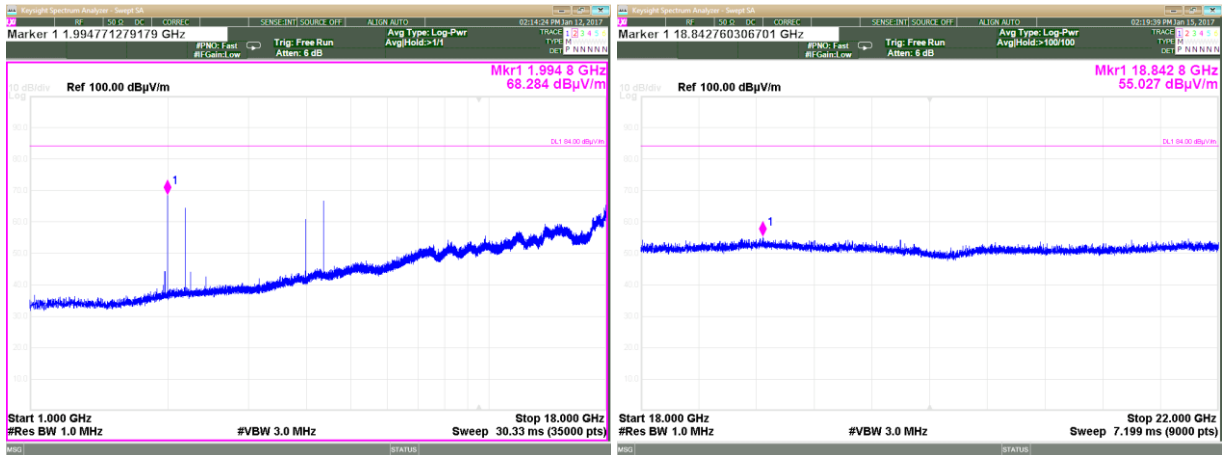

Plot 3.6.12: Spurious Emissions test results, 1 GHz – 22GHz range, Vertical polarization, High Frequency

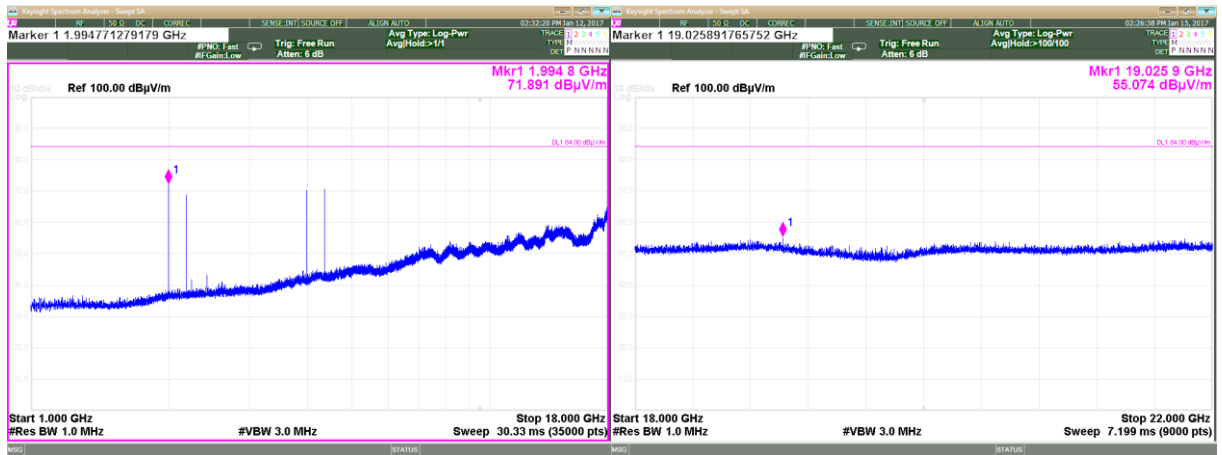

3.7. Frequency stability

Reference document:	47 CFR §24.235, 47 CFR §2.1055		
Test Requirements:	The frequency stability shall be sufficient to ensure that the fundamental emission stays within the authorized frequency block.		
Method of testing:	KDB 935210 D05v01r01, Conducted	Pass	
Operating conditions:	Under normal and extremes test conditions		
Environment conditions:	Ambient Temperature: 22°C	Relative Humidity: 48%	Atmospheric Pressure: 1011.4 hPa
Test Result:	See below	-	

Test results - Fc= 1962.5MHz

Frequency error vs. Voltage

Voltage [Vdc]	Frequency Error [Hz]	Frequency Error [%]	Frequency Error [ppm]	Limit [ppm]	Test Result
Carrier frequency at 20°C (120 VAC): 1962.5 MHz					
102-138	No Frequency Error observed				Pass

Frequency error vs. Temperature

Temperature, °C	Reference Frequency, MHz	Measured Frequency, MHz	Frequency Error, Hz	Frequency Error, ppm	Limit, ppm	Delta	Pass/Fail
-30	1962.500120	1962.500100	20.00	0.010191	1.50	-1.49	Pass
-20	1962.500120	1962.500120	0.00	0.000000	1.50	-1.50	Pass
-10	1962.500120	1962.500120	0.00	0.000000	1.50	-1.50	Pass
0	1962.500120	1962.500140	0.00	0.010191	1.50	-1.49	Pass
10	1962.500120	1962.500120	0.00	0.000000	1.50	-1.50	Pass
20	Reference temperature						
30	1962.500120	1962.500100	0.00	0.010191	1.50	-1.49	Pass
40	1962.500120	1962.500120	0.00	0.000000	1.50	-1.50	Pass
50	1962.500120	1962.500140	0.00	0.010191	1.50	-1.49	Pass

4. Appendix

Appendix A: List of test equipment used

Description	Manufacturer	Model	Serial No.	Cal Due
Anechoic new (large) chamber	-----	-----	-----	10/03/2018
Bilog Antenna	Teseq	CBL 6141B	34119	03/07/2017
EMC Analyzer	Agilent	E7405A	US41160436	02/06/2017
EMI Receiver (2.9GHz)	HP	8546A	3617A00318	23/05/2017
EMI Receiver (6.5GHz)	HP	8546A	3710A00392	09/02/2017
Horn Antenna 1-18GHz	A.R.A	DRG-118/A	17188	18/05/2017
Horn Antenna 15-40 GHz	Schwarzbeck	BBHA 9170	BBHA9170214	06/03/2018
LNA Amplifier 1 GHz to 18 GHz	AMP	7D-010180-30-10P-GW	618653	23/02/2017
Low-Noise Amplifier 18 - 26.5 GHz	Miteq	AMF-5F-18002650-30-10P	945372	23/02/2017
Power Meter	Agilent	N1911A	MY45100784	15/03/2017
RF Filter Section (2.9GHz)	HP	85460A	3448A00282	23/05/2017
RF Filter Section (6.5GHz)	HP	85460A	3704A00366	09/02/2017
Spectrum Analyzer 3Hz-44GHz	Agilent	E4446A	MY46180602	13/03/2017
Wideband Power Sensor	Agilent	N1921A	MY45241242	15/03/2017

Appendix B: Accreditation Certificate



Accredited Laboratory

A2LA has accredited

QUALITECH

Petah-Tikva, Israel

for technical competence in the field of

Electrical Testing

This laboratory is accredited in accordance with the recognized International Standard ISO/IEC 17025:2005 *General requirements for the competence of testing and calibration laboratories*. This accreditation demonstrates technical competence for a defined scope and the operation of a laboratory quality management system (refer to joint ISO-ILAC-IAF Communiqué dated 8 January 2009).



Presented this 28th day of June 2016.



Senior Director of Quality and Communications
For the Accreditation Council
Certificate Number 1633.01
Valid to June 30, 2018

For the tests to which this accreditation applies, please refer to the laboratory's Electrical Scope of Accreditation.

End of the Test Report