



Electromagnetic Compatibility Test Report

Test Report No: AXW 021016 rev.2
Issued on: December 07, 2016

Product Name
RRU Mid Power
FCC ID:NEO30ID7D8C17A19A

Tested According to
FCC 47 CFR, Part 22
869 – 894 MHz Band

Tests Performed for
Axell Wireless
Qiryat Matalon, Petah Tikva, 49002,
Tel: +972-3-918 0180

QualiTech EMC Laboratory, ECI Telecom

30 Hasivim Street,
Petah-Tikva, 49517, Israel
Tel: +972-3-926 6994
Fax: +972-3-928 7490



The information contained herein is the property of QualiTech, EMC Lab and is supplied without liability for errors or omissions.

*The copyright for this document vests in QualiTech, EMC Lab.
All rights reserved.*

This Test Report may not be reproduced, by any method, without the written permission of the QualiTech, EMC Lab.

If and when such permission is granted, the report must be reproduced only in the full format.

Test Personnel



Tests Performed By: -----

Dmitry Isaev



Report Prepared By: -----

Bina Talkar



Report Approved By: -----

Rami Nataf
EMC Lab. Manager
QualiTech EMC Laboratory

Test Report details:

Test commencement date: 26.04.2016
Test completion date: 29.09.2016
Customer's representative: Boaz Reuven
Issued on: 07.12.2016

Revision details:

Version	Date	Details/Reasons
Rev. 1	02.10.2016	-
Rev. 2	07.12.2016	Corrections according to ACB comments

Assessment information:

This report contains an assessment of the EUT against Radio testing based upon tests carried out on the samples submitted. The results contained in this report relate only to the items tested. Manufactured products will not necessarily give identical results due to production and measurement tolerances. QualiTech, Radio Lab does not assume responsibility for any conclusion and generalization drawn from the test results with regards to other specimens or samples of type of the equipment represented by test item.

The EUT was set up and exercised using the configuration, modes of operation and arrangements defined in this report only.

EUT Models:

Per customer's declaration the RRU Mid Power has two models, AC and DC .both models are identical and belong to one product family and differ only in power input supply without any influence to the RF path. Full testing were performed on AC model and Mean Output Power, Radiated spurious emissions, and frequency stability tests for DC model as shown in present document.

Modifications:

Modifications made to the EUT

None.

Modifications made to the Test Standard

None.

Summary of Compliance Status

Test Spec. Clause	Test Case	Remarks
Specific Requirements		
-KDB 935210 D05 v01r01, sec. 3.3	Out-of-Band Rejection	Done
General Requirements		
-47 CFR §2.1049(h) -KDB 935210 D05 v01r01, sec.3.4	Occupied Bandwidth - Input-versus-output signal comparison	Pass
-47 CFR §22.913 -47 CFR §2.1046 -KDB 935210 D05 v01r01, sec 3.5.4	Mean Output Power and Amplifier/Booster Gain	Pass
-47 CFR §22.917(a) -47 CFR §2.1051 -KDB 935210 D05v01r01, sec. 3.6.2, Conducted	Out-of-Band/Out-of-Block & Intermodulation Emissions Conducted Measurements	Pass
-47 CFR §22.917 -47 CFR §2.1051 -KDB 935210 D05v01r01, sec. 3.6.3, Conducted	Spurious Emission - Conducted Measurement	Pass
-47 CFR §22.917 -47 CFR §2.1053 -KDB 935210 D05v01r01, sec. 3.8, Radiated	Spurious Emissions – Radiated Measurement	Pass
-47 CFR §22.355 -47 CFR §2.1055 -KDB 935210 D05v01r01, sec. 3.7, Conducted	Frequency Stability	Pass

Table of Contents

<i>FCC ID:NEO30ID7D8C17A19A</i>	1
1. GENERAL	6
1.1. Referenced documents	6
1.2. Product Description	7
<i>FCC ID:NEO30ID7D8C17A19A</i>	7
<i>Serial Number:16033001</i>	7
2. TEST FACILITY & UNCERTAINTY OF MEASUREMENT	10
2.1. Accreditation/ Registration reference.....	10
2.2. Test Facility description	10
3. EXAMINATION TEST RESULTS	12
3.1. Out-of-Band Rejection.....	12
3.2. Occupied Bandwidth - Input-versus-output signal comparison.....	13
3.3. Mean Output Power and Amplifier/Booster Gain	15
3.4. Out-of-Band/Out-of-Block & Intermodulation Emissions Conducted Measurements.....	16
3.5. Spurious Emission Conducted Measurement	21
3.6. Spurious Emissions, Radiated Measurements	28
3.7. Frequency stability:	42
4. APPENDIX	43

1. General

1.1. Referenced documents

KDB 935210 D05 v01r01: Measurements Guidance for Industrial and Non-consumer Signal Booster, Repeater and Amplifiers Devices

ANSI/TIA-603-D: Land Mobile FM or PM Communications Equipment and Performance Standards

1.2. Product Description

FCC ID:NEO30ID7D8C17A19A

IC:8749A-30ID7817A19

Model Numbers:

id-DAS-RRU-M-3007-3008-3017-3019-AC.

id-DAS-RRU-M-3007-3008-3017-3019-DC.

Serial Number:16033001

Description of the EUT system/test Item:

idRU – The idRU is an IP 65 outdoor as well as indoor four-band remote unit, where two units can be cascaded through a CPRI link to support eight bands. Each band can provide medium-power of $31.5, \pm 0.5$ dB per band. The Remote Units serve as the backhaul port of any IP device or switch in the neighborhood; thus, it distributes combined cellular and data services according to user defined configuration profiles. The idRU is connected to the MSDH via 10 Gbit/s CPRI interfaces, where each interface contains an Embedded 1Gbit/s IP backhaul link.

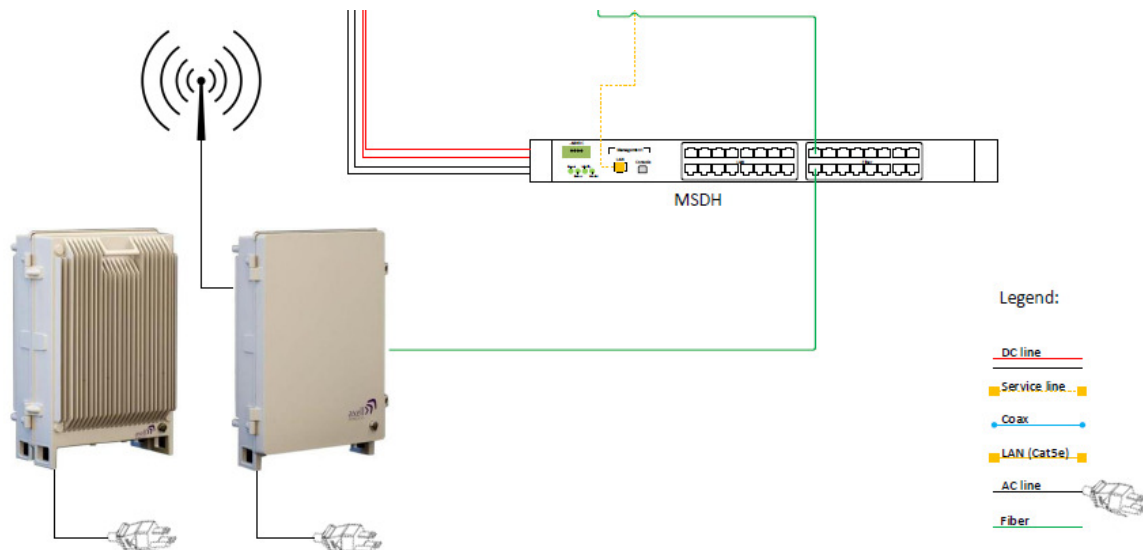

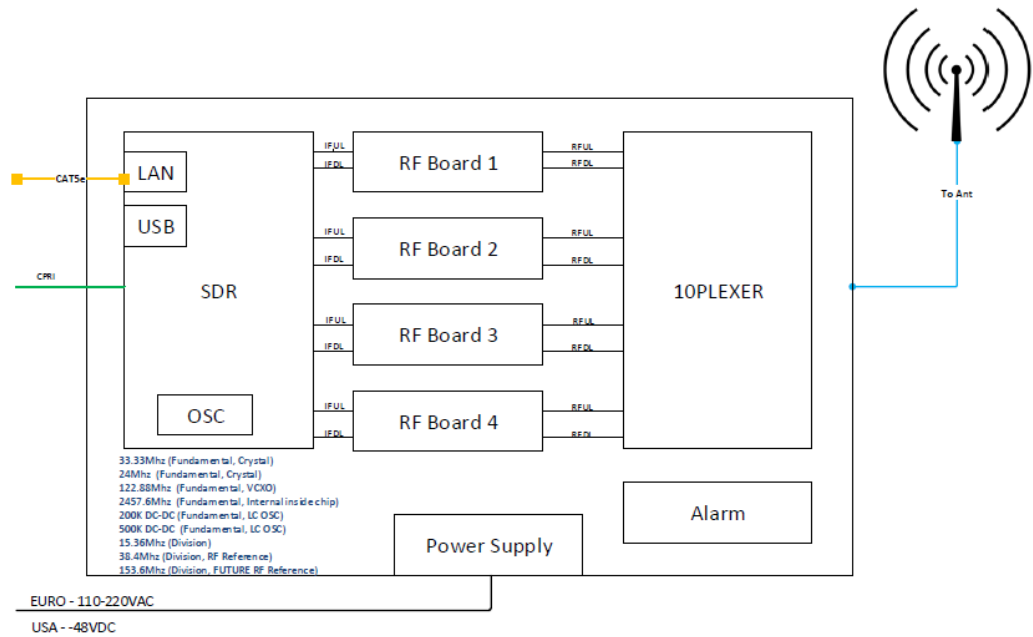

Technology	Direction	Modulation & Bandwidth	Frequency Band	Maximum Measured Output Power
AC Model				
GSM	Downlink	QPSK,0.2 MHz	869 - 894 MHz	31.80
CDMA	Downlink	1.25MHz		31.95
WCDMA	Downlink	5MHz		31.91
LTE	Downlink	64 QAM 1.4MHz		31.80
		64 QAM 5MHz		31.80
		64 QAM 20 MHz		31.40
DC Model				
GSM	Downlink	QPSK,0.2 MHz	869 - 894 MHz	31.75
CDMA	Downlink	1.25MHz		31.94
WCDMA	Downlink	5MHz		31.91
LTE	Downlink	64 QAM 1.4MHz		31.77
		64 QAM 5MHz		31.80
		64 QAM 20 MHz		31.36

Support /Ancillary Equipment:

For the purposes of this test report, ancillary equipment is defined as equipment which is used in conjunction with the EUT to provide operational features to the EUT.

The system was configured in a typical fashion, as it would be normally used. However, the ancillary equipment can influence the test results.

Test Setup and Module Description:

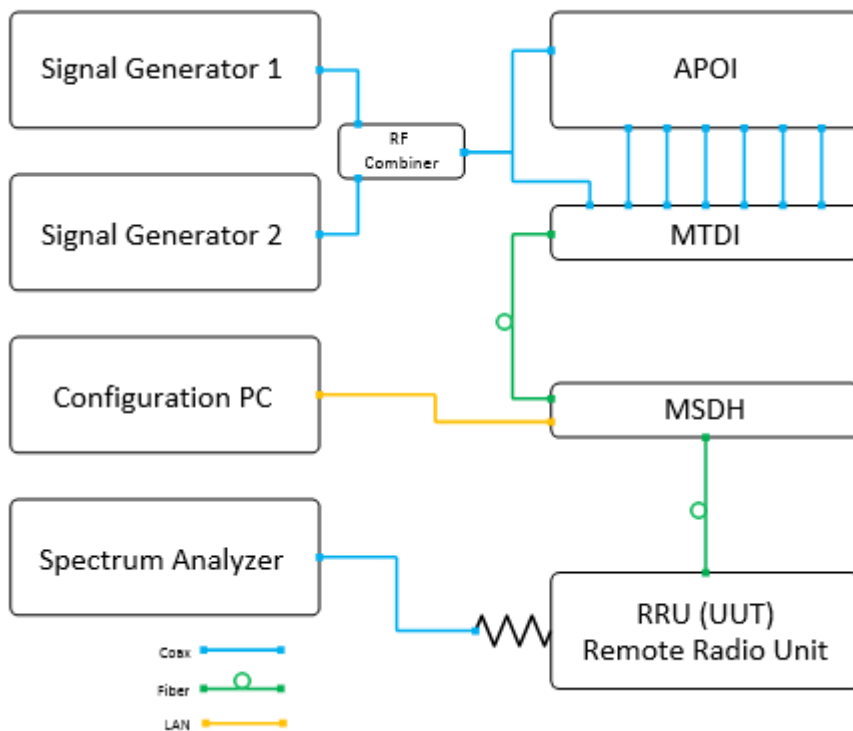

Signal Generator 1 and Signal Generator 2 generates a single tone or two-tones to the system. The tones can be selected to be CW or modulated . The signal can be routed either to the APOI or MTDI via Coax.

The APOI (Active Point of Interface), conditions and controls level of up to 16 low power BTS sectors of up to 30dBm. (Separate low PIM attenuators are used for higher power signals.)

The signals are conditioned by up to eight, band-specific modules, supporting two same-band sectors. The conditioned signals of each module are converged and fed to the corresponding (band-specific) MTDI module for digitization.

The MTDI (Multi Technology Digital Interface) unit digitizes and filters up to 16 conditioned cellular RF sectors from one more A-POI shelves. It then combines the signals over a single CPRI link that is routed towards the MSDH.

The MSDH (Multi Sector Digital Hub) serves as the idDAS central switching hub and control system. It routes digitized cellular resources received from MTDI units, along with data from the Ethernet network, over CPRI links towards the relevant remotes.

2. Test Facility & Uncertainty of Measurement

2.1. Accreditation/ Registration reference

- A2LA Certificate Number: 1633.01
- IC Canada: Site# 4808A-1

2.2. Test Facility description

The tests were performed at the EMC Laboratory, QualiTech Division, ECI Telecom Group

Address: 30, Hasivim St., Petah Tikva, Israel.
Tel: 972-3-926-6994

3m Anechoic Chamber:

The 3m-screened chamber is used in two configurations: the semi-anechoic configuration for Radiated Emission measurements and the full-anechoic configuration for Radiated Immunity tests.

3m Anechoic Chamber:

Measurement distance	3m
Chamber dimensions	9.5m x 6.5m x 5.2m
Antenna height	1 - 4m
Shielding Effectiveness	Magnetic field ≥ 80 dB at 15 kHz ≥ 90 dB at 100 kHz Electric field > 120 dB from 1MHz to 1GHz > 110 dB from 1GHz to 10GHz
Absorbing material	Ferrite tiles on the walls and ceiling Emerson and Cuming absorbing material in selected positions on the walls
Normalized Site Attenuation measured at 5 positions	± 3.9 dB, 30MHz to 200MHz ± 3 dB, 200MHz to 1000MHz
Transmission Loss measured at 5 positions, at 1.5m height	± 3 dB, 1GHz to 18GHz

Uncertainty of Measurement:

The data and results referenced in this document are true and accurate. The reader is cautioned that there may be errors within the calibration limits of the equipment and facilities. The measurement uncertainty was calculated for all measurements listed in this test report according to CISPR 16-4-2 “Specification for radio disturbance and immunity measuring apparatus and methods – Part 4-2: Uncertainties, statistics and limit modelling – Uncertainty in EMC measurements “. Furthermore, component and process variability of devices similar to that tested may result in additional deviation. The manufacturer has the sole responsibility of continued compliance of the device.

Test Name	Test Method & Range	Uncertainty	
		Combined std. Uc(y)	Expanded U
Radiated Emission	30MHz÷230MHz, Horiz. polar.	[dB] 1.8	[dB] 3.6
	30MHz÷230MHz, Ver. polar.	1.967	3.934
	230MHz÷1000MHz, Horiz. polar.	1.487	2.973
	230MHz÷1000MHz, Vert. polar.	1.499	2.998
Conducted Emission	9 kHz÷150 kHz	[dB] 1.378	[dB] 2.756
	150 kHz÷30MHz	1.095	2.190
Radio frequency	Up to 18 GHz	$\pm 1 * 10^{-6}$	$< \pm 1 * 10^{-5}$
Total Conducted RF Power	Up to 18 GHz	± 1.378 dB	$< \pm 1.5$ dB
Conducted Power density	Up to 18 GHz	± 1.378 dB	$< \pm 3$ dB
Temperature	23.6 °C	± 0.6 °C	$< \pm 2$ °C
Humidity	54.9%	± 3.1 %	$< \pm 5$ %
DC Voltage	0-60 VDC	± 0.3 %	$< \pm 3$ %

Note: QualiTech EMC labs expanded measurement instrumentation has less uncertainty than the industry norm and compliance is deemed to occur as no measured disturbance exceeds the disturbance limit.

Note: The reported expanded uncertainty is based on a standard uncertainty multiplied by a coverage factor of k=2, providing a level of confidence of approximately 95%.

3. Examination Test Results

3.1. Out-of-Band Rejection

Reference document:	KDB 935210 D05 v01r01		
Method of testing:	KDB 935210 D05 v01r01, Conducted	Done	
Operating conditions:	Under normal test conditions		
Environment conditions:	Ambient Temperature: 22°C	Relative Humidity: 48%	Atmospheric Pressure: 1011.4 hPa
Test Result:	See below	See Plot 3.1	

Test results:

Modulation	±250% of Passband*, MHz	Frequency fo, MHz	-20dB lowest point, MHz	-20dB highest point, MHz
CW	806.5....956.5	869.679	867.830	895.061

* 25MHz passband

Plot 3.1: Out-of-Band rejection, CW

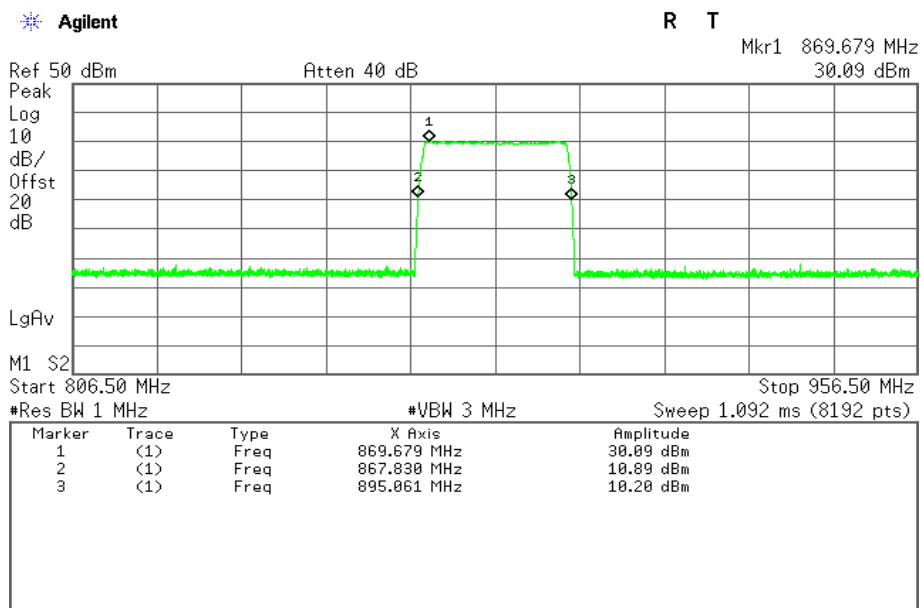

3.2. Occupied Bandwidth - Input-versus-output signal comparison

Reference document:	47 CFR §2.1049(h)		
Test Requirements:	<p>The occupied bandwidth, that is the frequency bandwidth such that, below its lower and above its upper frequency limits, the mean powers radiated are each equal to 0.5 percent of the total mean power radiated by a given emission shall be measured under the following conditions as applicable.</p> <p>A 26 dB bandwidth measurement shall be performed on the input signal and the output signal; alternatively, the 99% OBW can be measured and used.</p> <p>The spectral plot of the input signal shall be similar to the output signal.</p>		
Method of testing:	KDB 935210 D05 v01r01, Conducted	Pass	
Operating conditions:	Under normal test conditions		
Environment conditions:	Ambient Temperature: 22°C	Relative Humidity: 48%	Atmospheric Pressure: 1011.4 hPa
Test Result:	See below	See Plot 3.2.1 - Plot 3.2.2	

Test results:

Mode	Operating Frequency, MHz	26dB Bandwidth, MHz	
		Output	Input
		0.5dB below AGC	0.5dB below AGC
MSK, Gaussian filter 0.3 data rate 270kbps	881.500	305.46 kHz	314.66 kHz
AWGN 4.1MHz	881.500	4.67 MHz	4.67 MHz

Plot 3.2.1: Input-versus-output signal comparison, MSK, Gaussian filter 0.3 data rate 270kbps

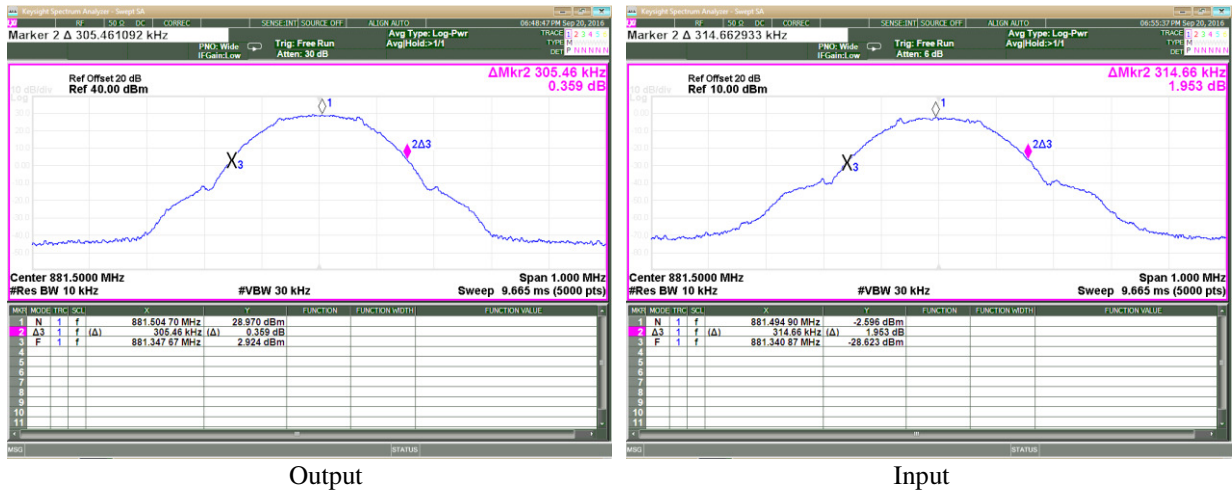

Plot 3.2.2: Input-versus-output signal comparison, AWGN 4.1MHz

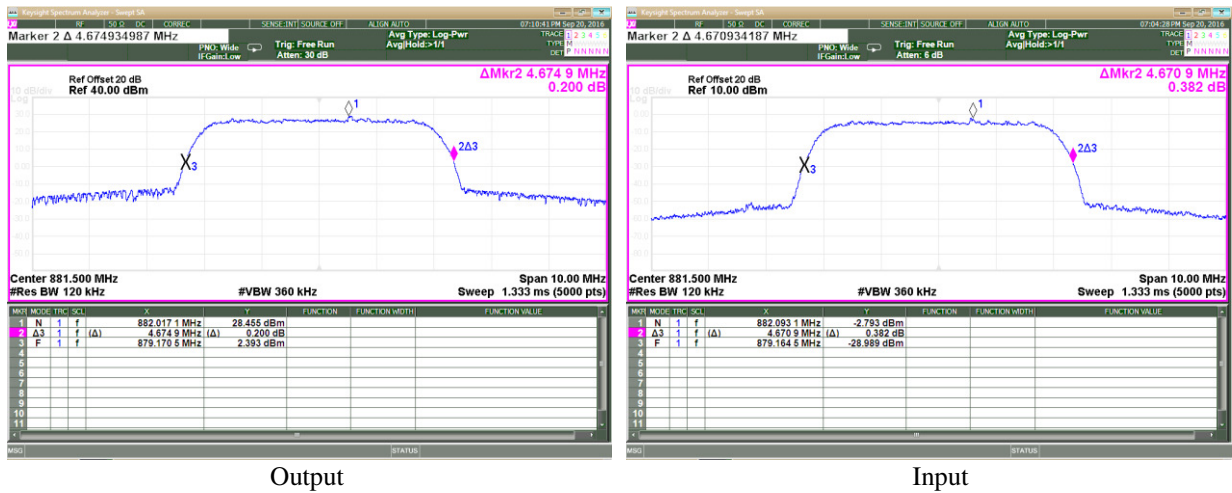

3.3. Mean Output Power and Amplifier/Booster Gain

Reference document:	47 CFR §22.913, 47 CFR §2.1046		
Test Requirements:	The effective radiated power (ERP) of base transmitters and cellular repeaters must not exceed 500 Watts		
Method of testing:	For 47CFR: KDB 935210 D05 v01r01, sec 3.5(power meter method);	Pass	
Operating conditions:	Under normal test conditions		
Environment conditions:	Ambient Temperature: 22°C	Relative Humidity: 48%	Atmospheric Pressure: 1011.4 hPa
Test Result:	See below	-	

Test results:

Mode	Operating Frequency(f _o) ¹ , MHz	Measured AVG Power				Mean Gain ²	Max Antenna Gain dBd	ERP Calculated W	ERP Limit W	Pass/Fail
		Output		Input						
MSK, Gaussian filter 0.3 data rate 270kbps	869.680	1.51 W	31.80 dBm	1.17 mW	0.67 dBm	31.13 dB	11.85	20.99	500	Pass
AWGN 4.1 MHz	871.500	1.51 W	31.80 dBm	1.06 mW	0.27 dBm	31.53 dB	11.85	21.78	500	Pass

¹ from "Out-of-Band Rejection" tests

² Mean Gain [dB] = Measured AVG Power (Output) [W] - Measured AVG Power (Input) [W]

³ Delta [W] = Measured AVG Power (Output) [W] - Power Limit [W]

3.4. Out-of-Band/Out-of-Block & Intermodulation Emissions Conducted Measurements

Reference document:	47 CFR §22.917(a), 47 CFR §2.1051		
Test Requirements:	<p>The power of any emission outside of the authorized operating frequency ranges must be attenuated below the transmitting power (P) by a factor of at least $43 + 10 \log(P)$ dB</p> <p>The radio frequency voltage or powers generated within the equipment and appearing on a spurious frequency shall be checked at the equipment output terminals when properly loaded with a suitable artificial antenna. Curves or equivalent data shall show the magnitude of each harmonic and other spurious emission that can be detected when the equipment is operated under the conditions specified in §2.1049 as appropriate. The magnitude of spurious emissions which are attenuated more than 20 dB below the permissible value need not be specified</p>		
Method of testing:	KDB 935210 D05v01r01, Conducted		Pass
Operating conditions:	Under normal test conditions		
S.A. Settings:	RBW: minimum 1% of EBW or 100kHz or 1MHz; VBW: 3 times RBW		
Environment conditions:	Ambient Temperature: 22°C	Relative Humidity: 48%	Atmospheric Pressure: 1011.4 hPa
Test Result:	See below		See Plot 3.4.1 - Plot 3.4.8

*It translates to a limit of -13dBm

Test results:

Modulation	Operating Frequency, MHz		Emission Frequency, MHz	Emission Level, dBm	Limit, dBm	Delta, dB	Pass/Fail
	Carrier 1	Carrier 2					
MSK Gaussian filter 0.3 data rate 270kbps	869.200	NA	16.908	-26.98	-13.00	-13.98	Pass
	869.200	869.400	13.988	-30.55	-13.00	-17.55	Pass
	893.800	NA	17.048	-27.64	-13.00	-14.64	Pass
	893.800	893.600	14.002	-31.08	-13.00	-18.08	Pass
AWGN 4.1MHz	871.500	NA	17.259	-29.68	-13.00	-16.68	Pass
	871.500	876.500	14.707	-31.79	-13.00	-18.79	Pass
	891.500	NA	17.416	-27.11	-13.00	-14.11	Pass
	891.500	886.500	14.339	-30.49	-13.00	-17.49	Pass

Plot 3.4.1: Band Edge test results, MSK Gaussian filter 0.3 data rate 270kbps, Fc = 869.2 MHz, single test signal

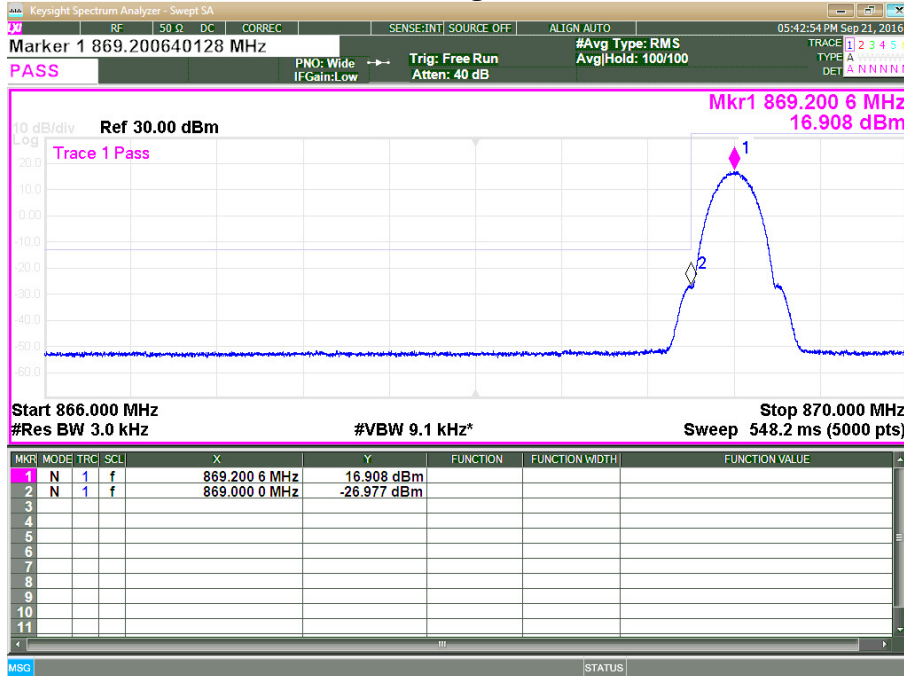

Plot 3.4.2: Band Edge test results, MSK Gaussian filter 0.3 data rate 270kbps, Fc = 869.2 + 869.4 MHz, two test signals

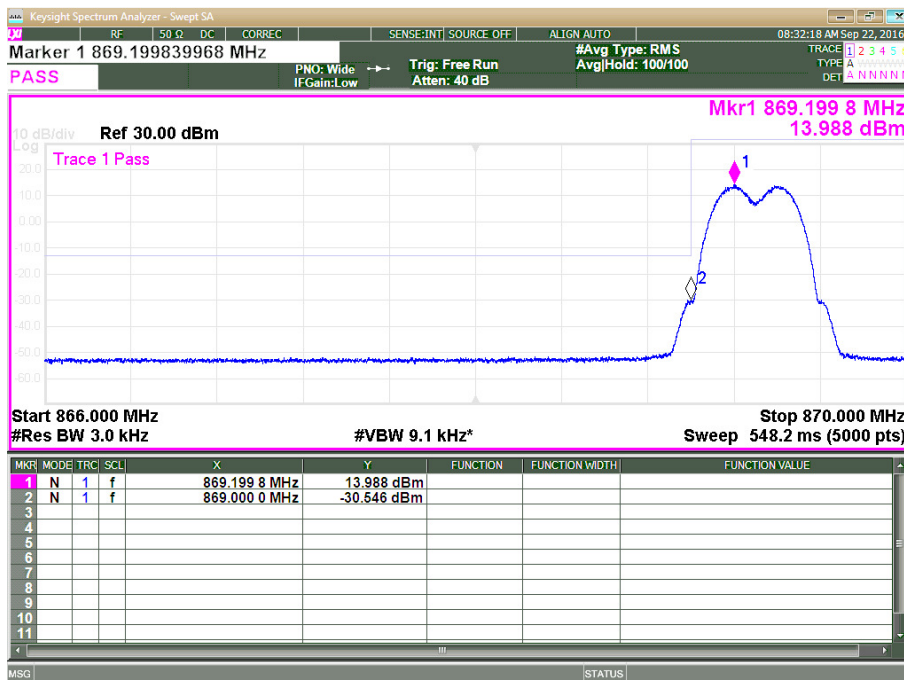

Plot 3.4.3: Band Edge test results, MSK Gaussian filter 0.3 data rate 270kbps, $F_c = 893.8$ MHz, single test signal

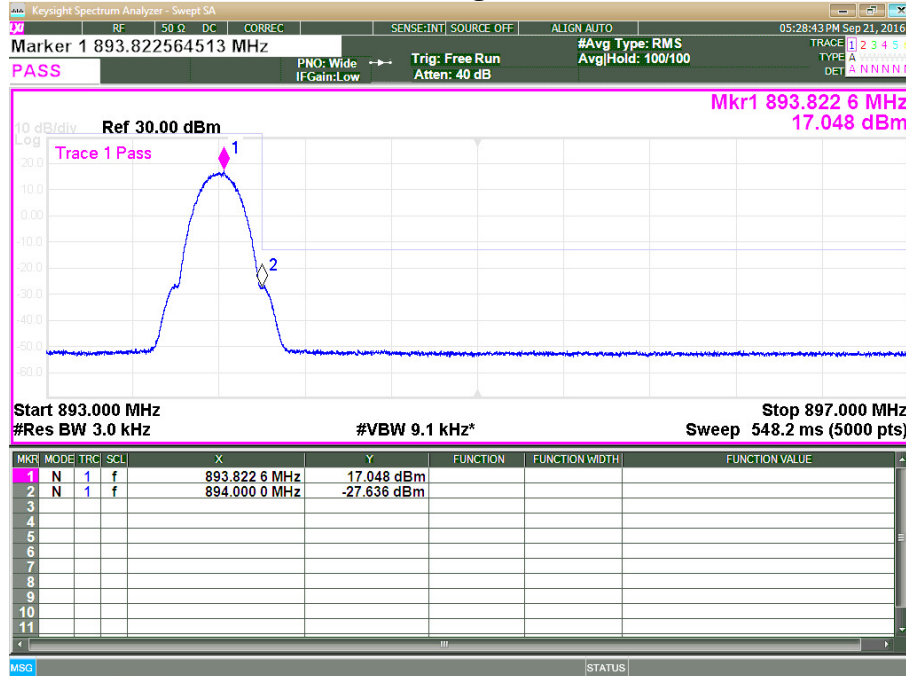

Plot 3.4.4: Band Edge test results, MSK Gaussian filter 0.3 data rate 270kbps, $F_c = 893.8 + 893.6$ MHz, two test signals

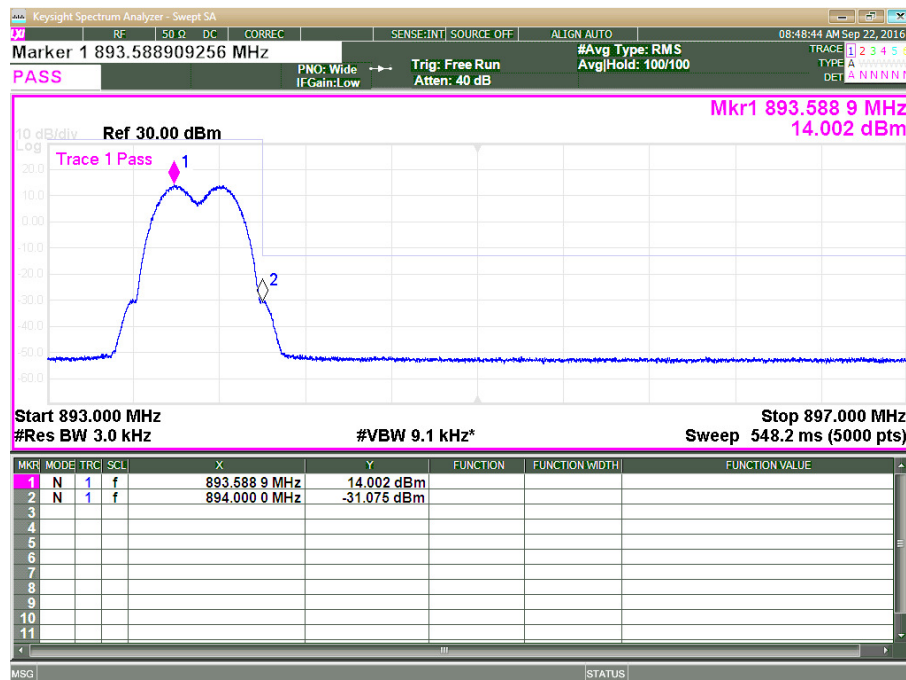

Plot 3.4.5: Band Edge test results, AWGN 4.1MHz, Fc = 871.5 MHz, single test signal

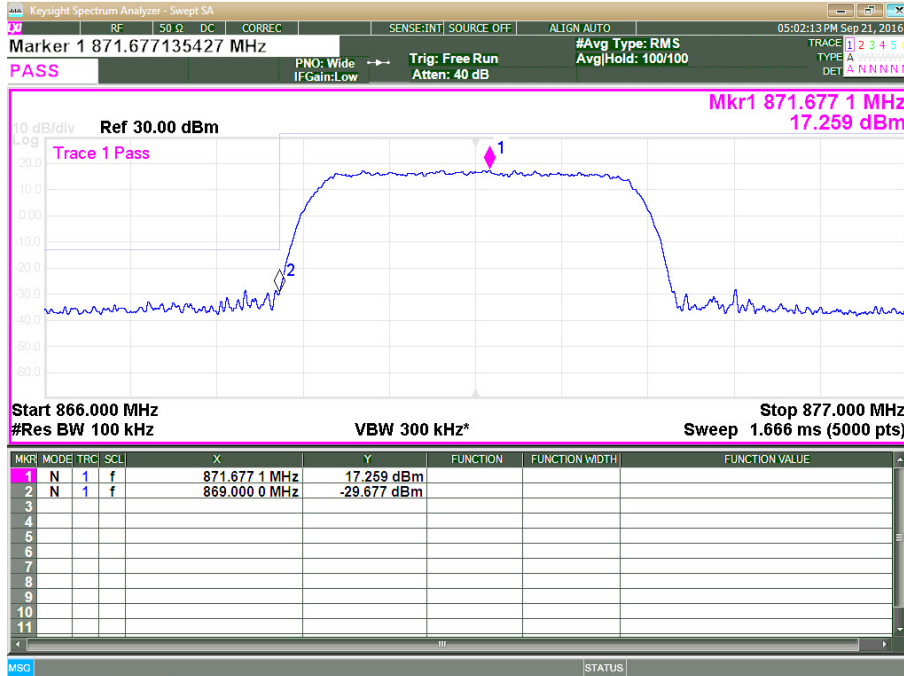

Plot 3.4.6: Band Edge test results, AWGN 4.1MHz, Fc = 871.5 + 876.5 MHz, two test signals

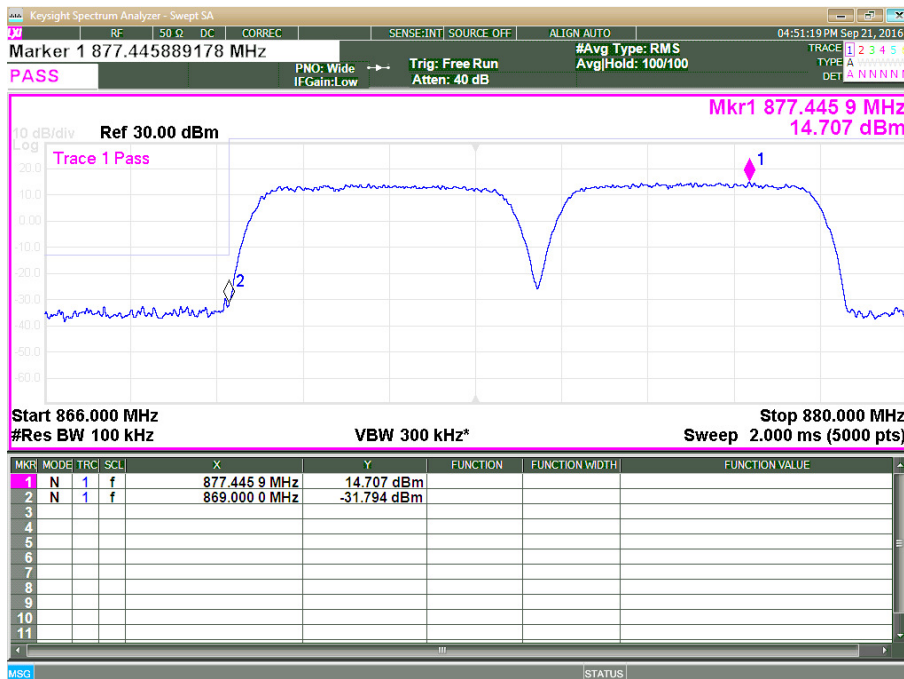

Plot 3.4.7: Band Edge test results, AWGN 4.1MHz, Fc = 891.50 MHz, single test signal

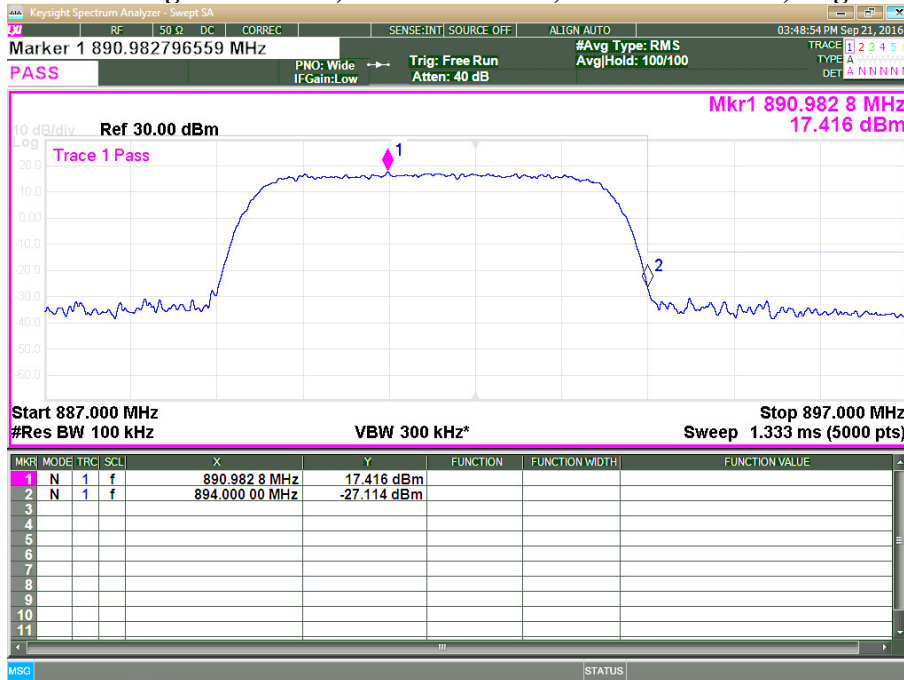

Plot 3.4.8: Band Edge test results, AWGN 4.1MHz, Fc = 891.5 + 886.5 MHz, two test signals

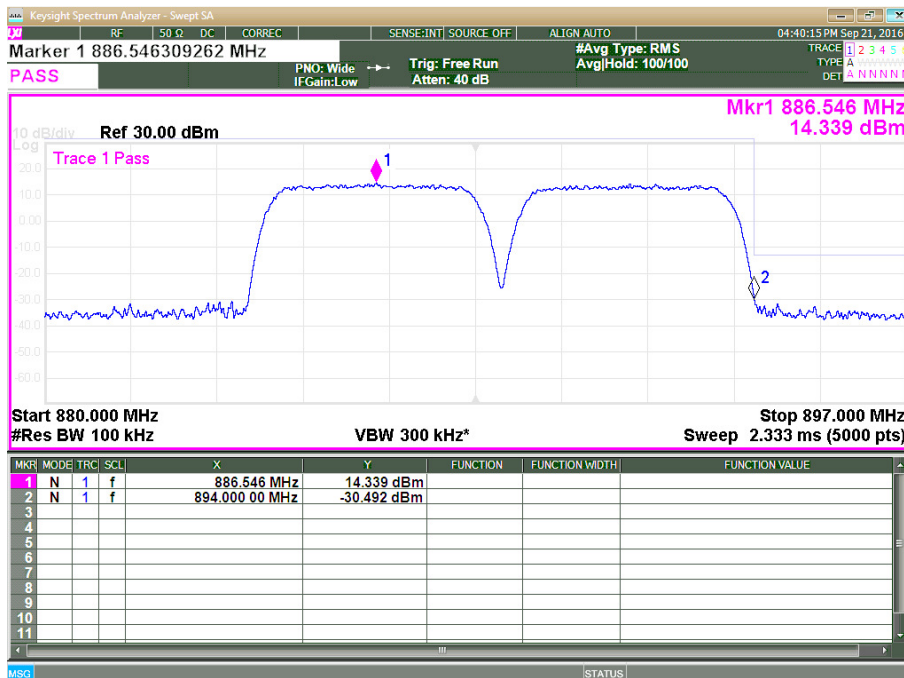

3.5. Spurious Emission Conducted Measurement

Reference document:	47 CFR §22.917, §2.1051		
Test Requirements:	<p>Out of band emissions. The power of any emission outside of the authorized operating frequency ranges must be attenuated below the transmitting power (P) by a factor of at least $43 + 10 \log(P)$ dB</p> <p>The radio frequency voltage or powers generated within the equipment and appearing on a spurious frequency shall be checked at the equipment output terminals when properly loaded with a suitable artificial antenna. Curves or equivalent data shall show the magnitude of each harmonic and other spurious emission that can be detected when the equipment is operated under the conditions specified in §2.1049 as appropriate. The magnitude of spurious emissions which are attenuated more than 20 dB below the permissible value need not be specified</p>		
Method of testing:	KDB 935210 D05 v01r01	Pass	
Operating conditions:	Under normal test conditions		
S.A. Settings:	RBW: 1MHz, VBW: 3MHz		
Environment conditions:	Ambient Temperature: 22°C	Relative Humidity: 48%	Atmospheric Pressure: 1011.4 hPa
Test Result:	See below	See Plot 3.5.1 - Plot 3.5.12	

*It translates to a limit of -13dBm

Test Results: all emission were at least 10 dB below the limit

Plot 3.5.1: Spurious Emission Conducted Measurement, MSK Gaussian filter 0.3 data rate 270kbps, Fc = 869.200 MHz, 9 kHz – 1.3 GHz

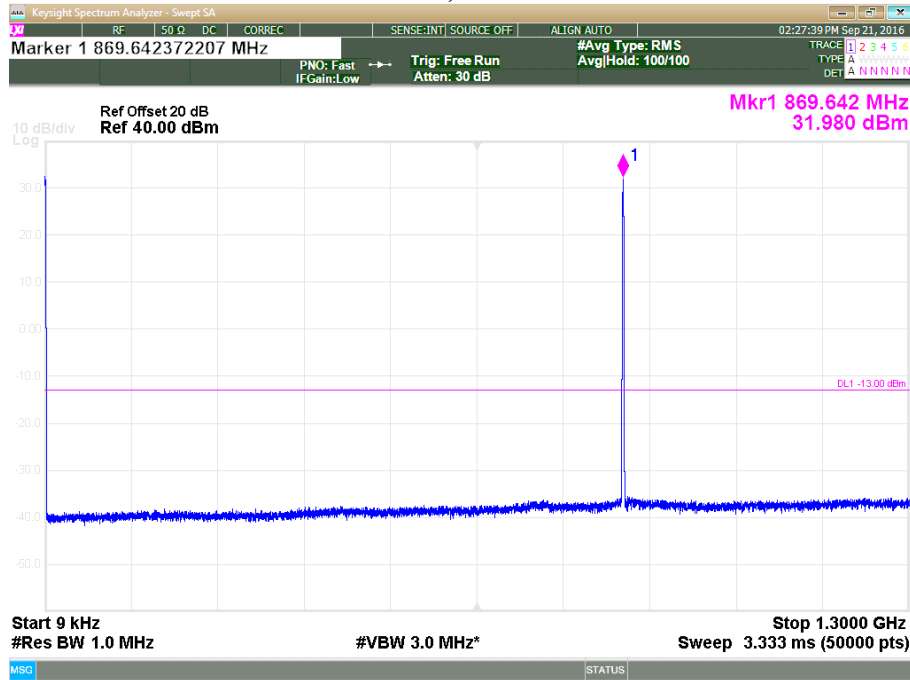

Plot 3.5.2: Spurious Emission Conducted Measurement, MSK Gaussian filter 0.3 data rate 270kbps, Fc = 869.200 MHz, 1.3 GHz – 10.0 GHz

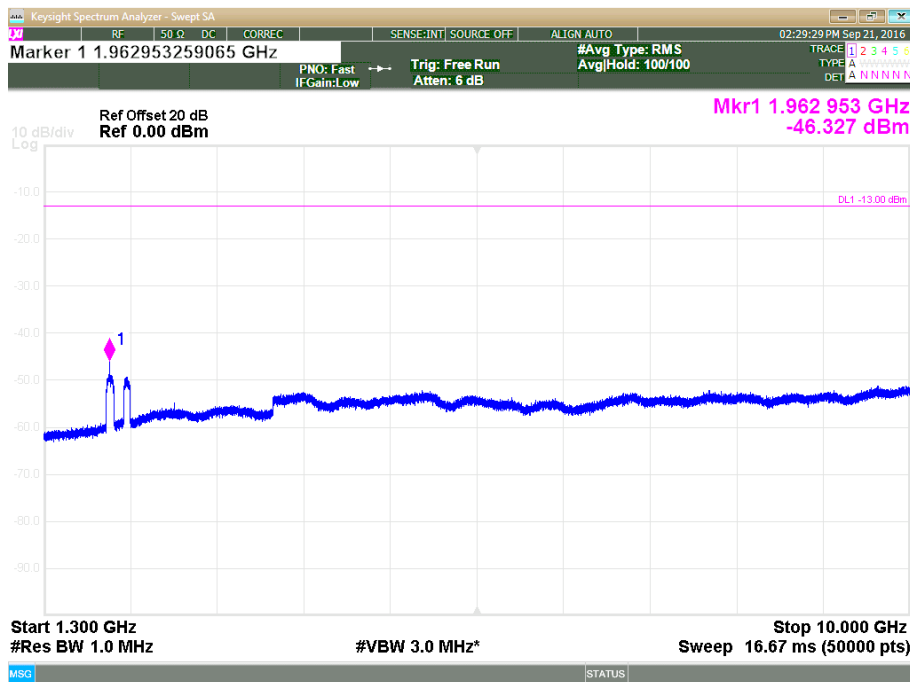

With filter WHK1.2/15GHz

Plot 3.5.3: Spurious Emission Conducted Measurement, MSK Gaussian filter 0.3 data rate 270kbps, Fc = 881.500, 9 kHz – 1.3 GHz

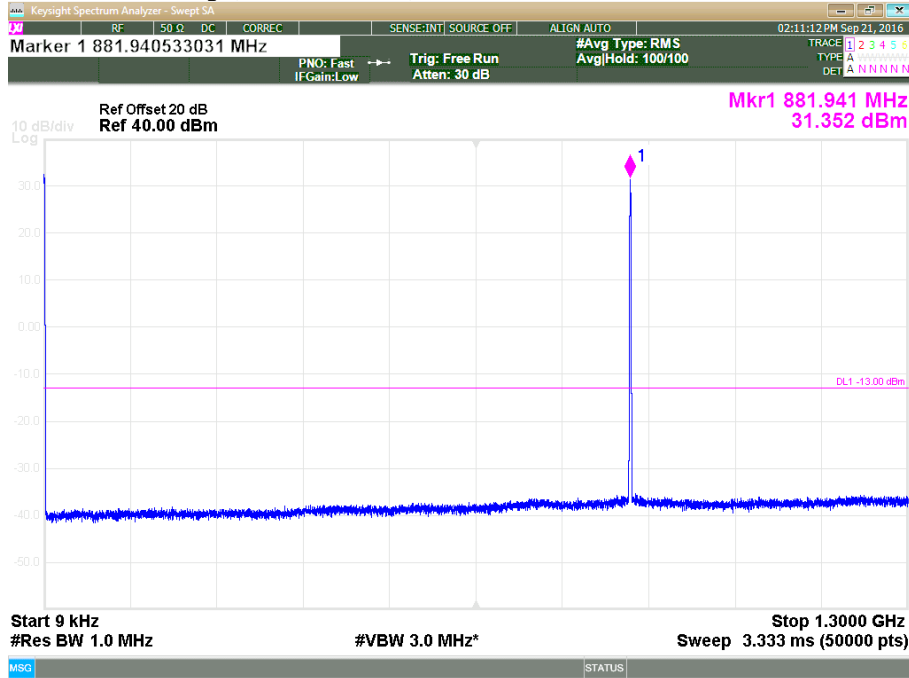

Plot 3.5.4: Spurious Emission Conducted Measurement, MSK Gaussian filter 0.3 data rate 270kbps, Fc = 881.500, 1.3 GHz – 10.0 GHz

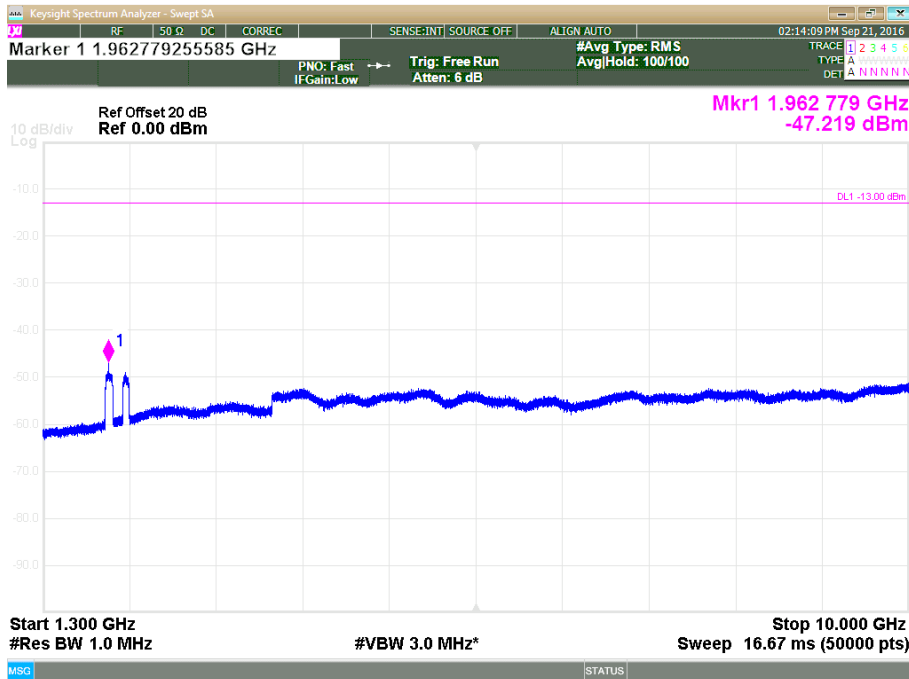

With filter WHK1.2/15GHz

Plot 3.5.5: Spurious Emission Conducted Measurement, MSK Gaussian filter 0.3 data rate 270kbps $F_c = 893.800$ MHz, 9 kHz – 1.3 GHz

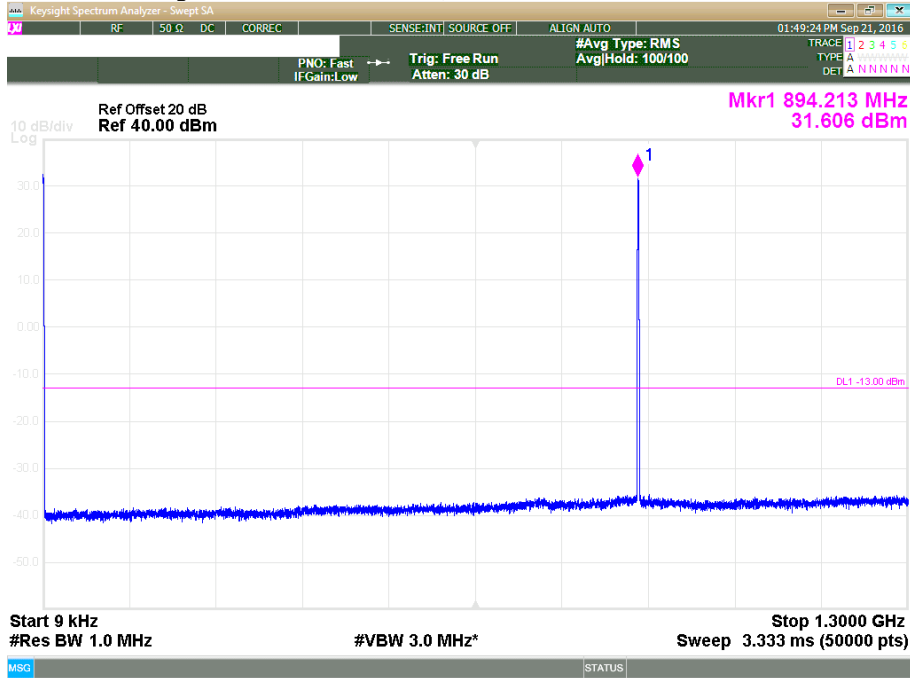

Plot 3.5.6: Spurious Emission Conducted Measurement, MSK Gaussian filter 0.3 data rate 270kbps, $F_c = 893.800$ MHz, 1.3 GHz – 10.0 GHz

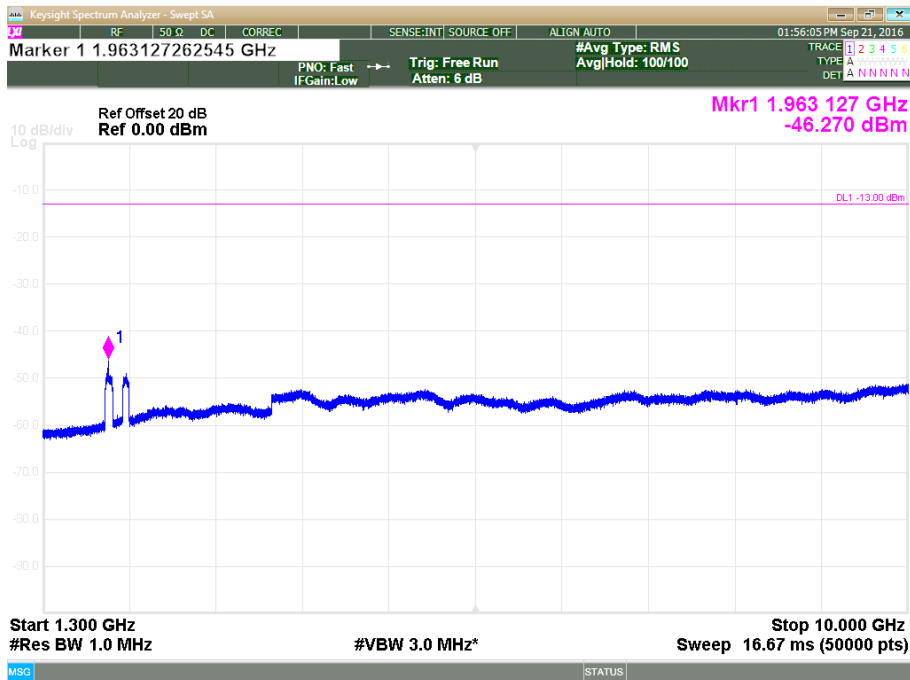

With filter WHK1.2/15GHz

Plot 3.5.7: Spurious Emission Conducted Measurement, AWGN 4.1MHz, Fc = 871.500 MHz, 9 kHz – 1.3 GHz

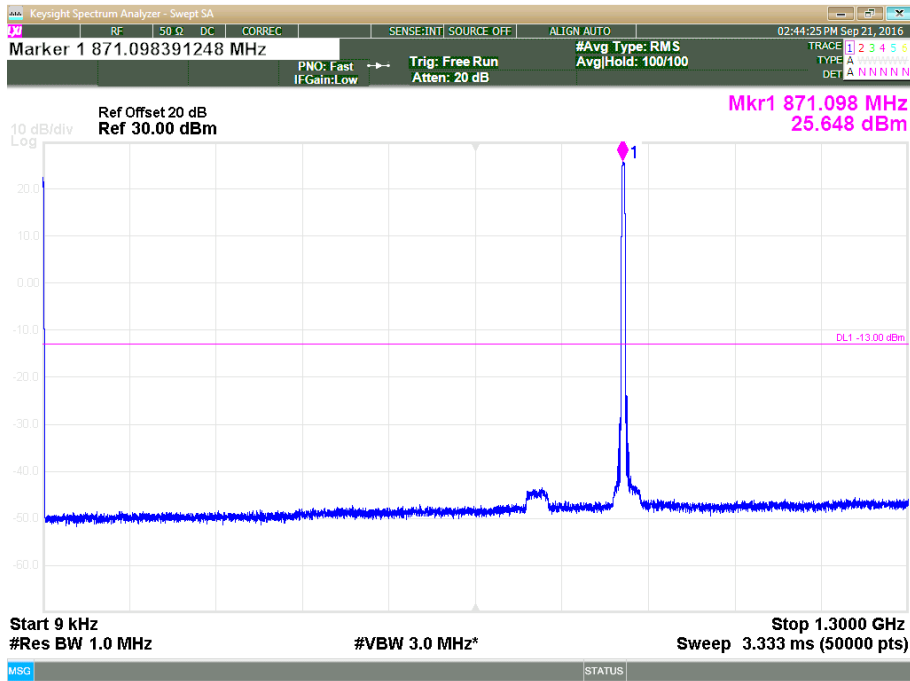

Plot 3.5.8: Spurious Emission Conducted Measurement, AWGN 4.1MHz, Fc = 871.500 MHz, 1.3 GHz – 10.0 GHz

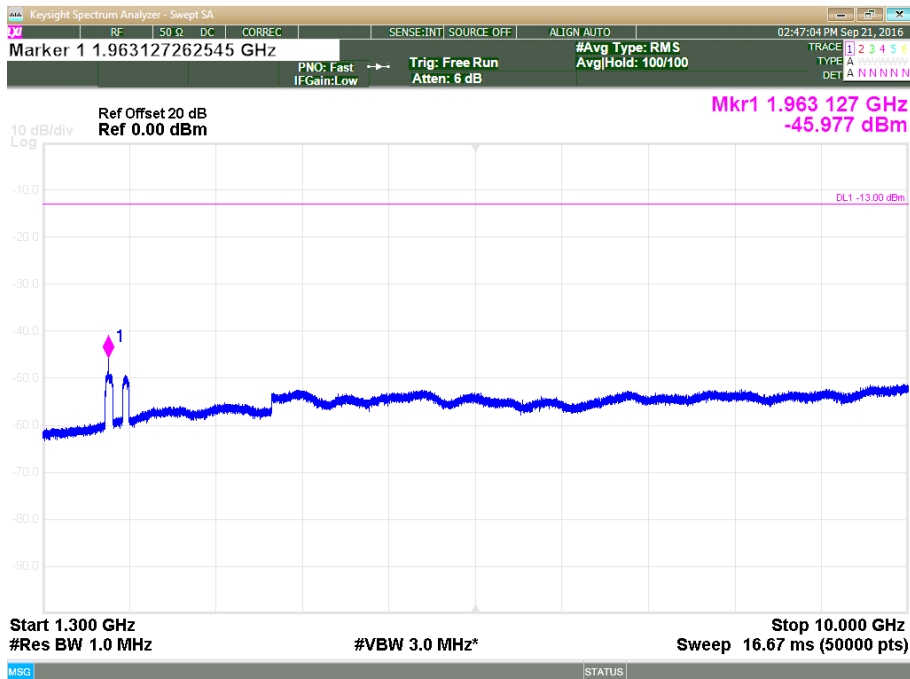

With filter WHK1.2/15GHz

Plot 3.5.9: Spurious Emission Conducted Measurement, AWGN 4.1MHz, Fc = 881.500 MHz, 9 kHz – 1.3 GHz

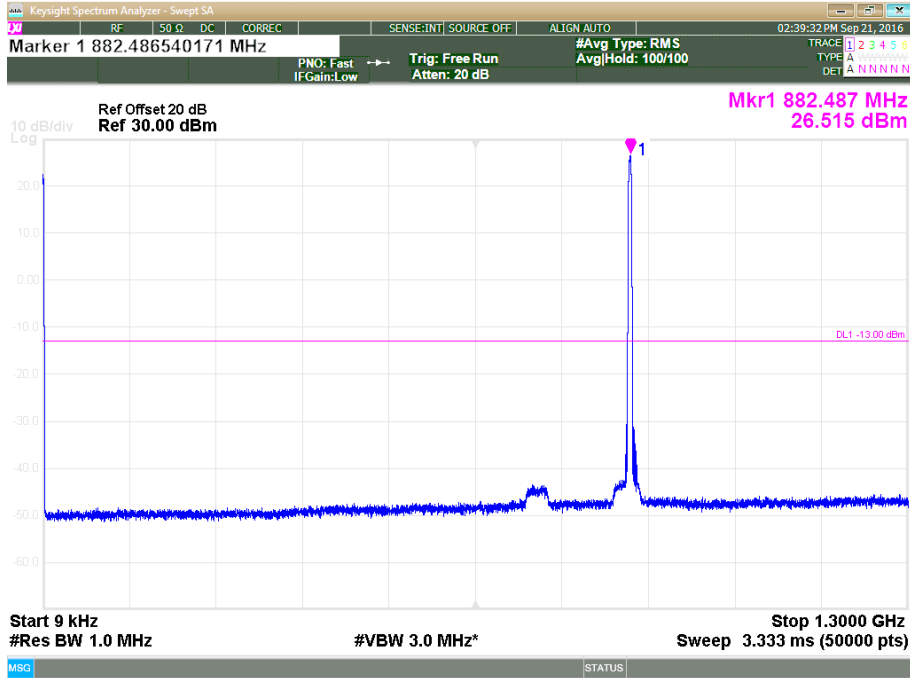

Plot 3.5.10: Spurious Emission Conducted Measurement, AWGN 4.1MHz, Fc = 881.500 MHz, 1.3 GHz – 10.0 GHz

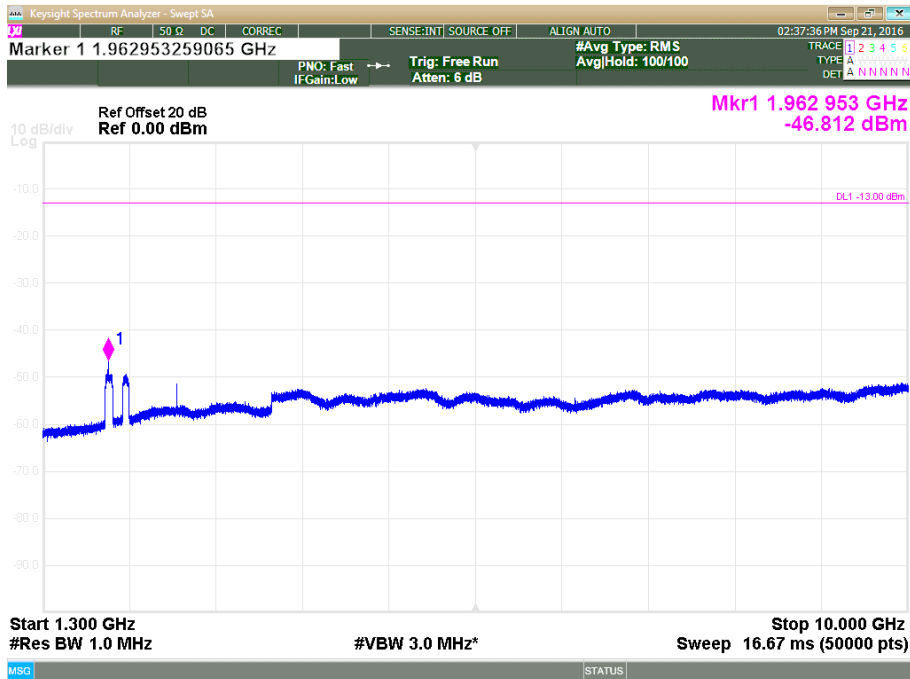

With filter WHK1.2/15GHz

Plot 3.5.11: Spurious Emission Conducted Measurement, AWGN 4.1MHz, Fc = 891.500 MHz, 9 kHz – 1.3 GHz

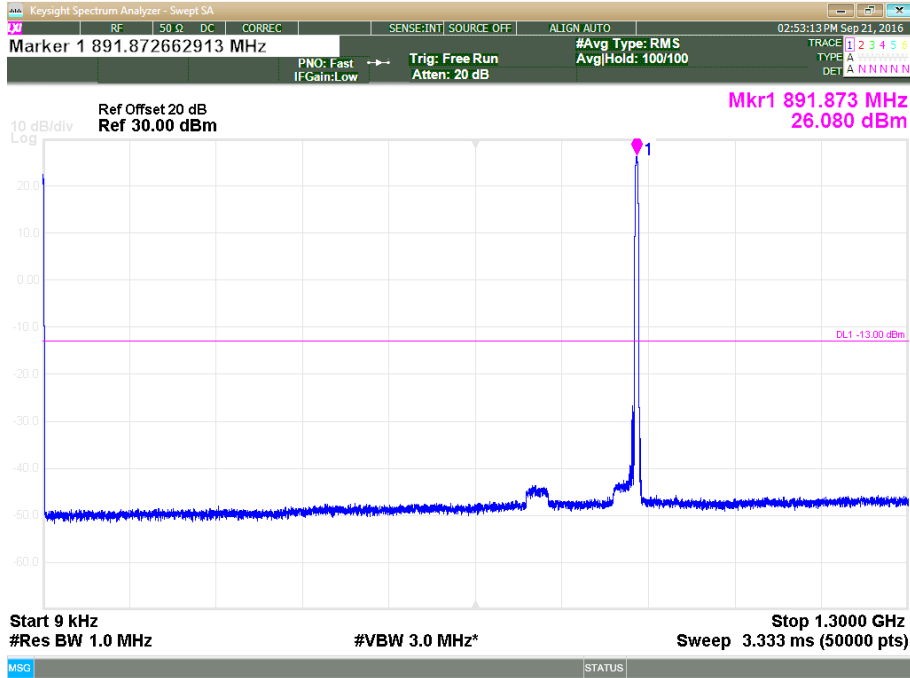

Plot 3.5.12: Spurious Emission Conducted Measurement, AWGN 4.1MHz, Fc = 891.500, 1.3 GHz – 10.0 GHz

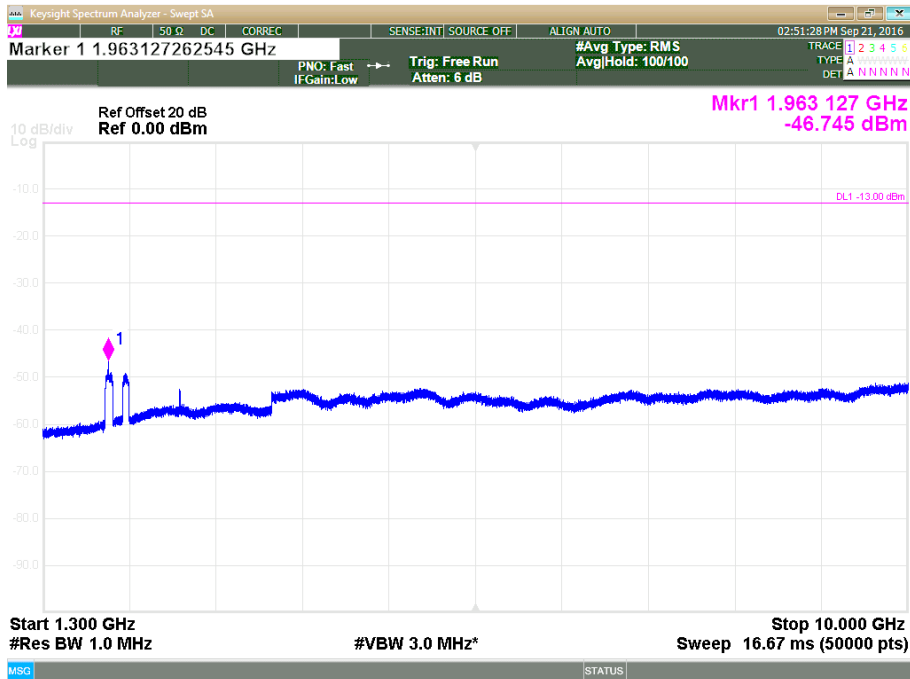

With filter WHK1.2/15GHz

3.6. Spurious Emissions, Radiated Measurements

Reference document:	47 CFR §22.917 & §2.1053		
Test Requirements:	The power of any emission outside of the authorized operating frequency block shall be attenuated below the transmitting power (P, in Watts) by a factor of at least 43+10log(P) dB*.		
Method of testing:	KDB 935210 D05v01r01, Radiated KDB 971168[R8]	Pass	
Operating conditions:	Under normal test conditions		
S.A. Settings:	RBW: 1MHz, VBW: 3MHz		
Environment conditions:	Ambient Temperature: 22°C	Relative Humidity: 48%	Atmospheric Pressure: 1011.4 hPa
Test Result:	See below	AC Model-Plots 3.6.1-3.6.12 DC Model-Plots 3.6.13-3.6.22	

*It translates to a limit of -13dBm = 84 dBµV/m @3m distance

Note: All measurements performed with 2 simultaneous transmissions:

Low frequency: 746.2 MHz, 869.2 MHz

Middle frequency: 751.5 MHz, 881.5 MHz

High frequency: 756.8 MHz, 893.8 MHz

-All measurements were done in horizontal and vertical polarizations; the tables below show the worst case.

Test Results:AC Model

Frequency [MHz]	Radiated Emission Level [dBµV/m]	Radiated Emission Level* EIRP [dBm]	Limit [dBm]	Margin [dB]	Pass/Fail	Ref Plots
All emissions were at least 15dB below the Limit					Pass	3.6.1-3.6.12

Test Results: DC Model

Frequency, MHz	Emission Level, dBµV/m	Antenna Polarization	Substitution Method				Limit [dBm]	Margin, dB	Pass /Fail	Ref Plots
			Signal generator output, [dBm]	Antenna Gain, [dBd]	Cable Loss, dB	Calculated ERP*, [dBm]				
Low Frequency										
70.748	65.7	V	-29.0	-3.9	0.4	-33.3	-13.0	-20.3	Pass	3.6.13-3.6.24
76.450	67.7	V	-29.0	-3.5	0.4	-32.9	-13.0	-19.9	Pass	
94.622	73.0	H	-23.0	-1.8	0.5	-25.3	-13.0	-12.3	Pass	
100.852	71.7	V	-25.7	-1.7	0.5	-27.9	-13.0	-14.9	Pass	

*Calculated ERP = Signal Generator Output + Antenna Gain – Cable Loss

AC Model

Plot 3.6.1: Spurious Emissions test results, 30 MHz – 1 GHz range, Horizontal polarization, Low Frequency

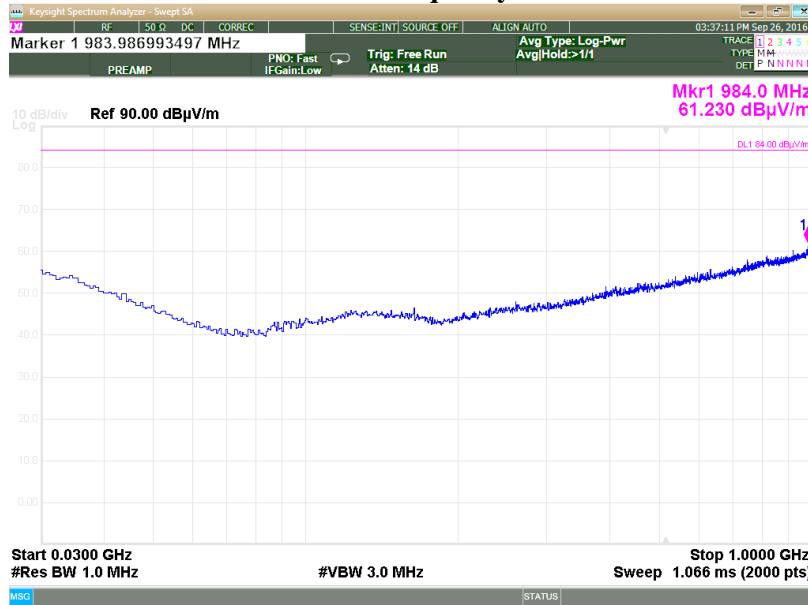

Plot 3.6.2: Spurious Emissions test results, 30 MHz – 1 GHz range, Vertical polarization, Low Frequency

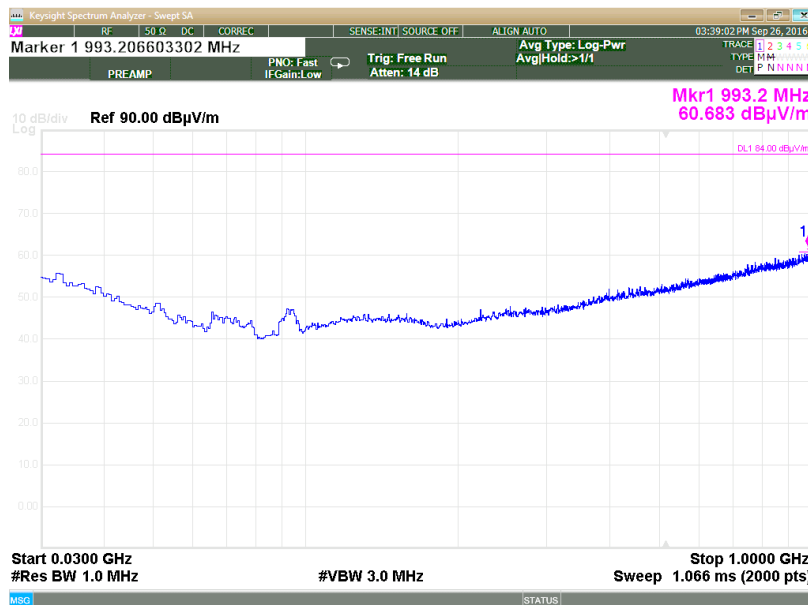

Plot 3.6.3: Spurious Emissions test results, 1 GHz – 18 GHz range, Horizontal polarization, Low Frequency

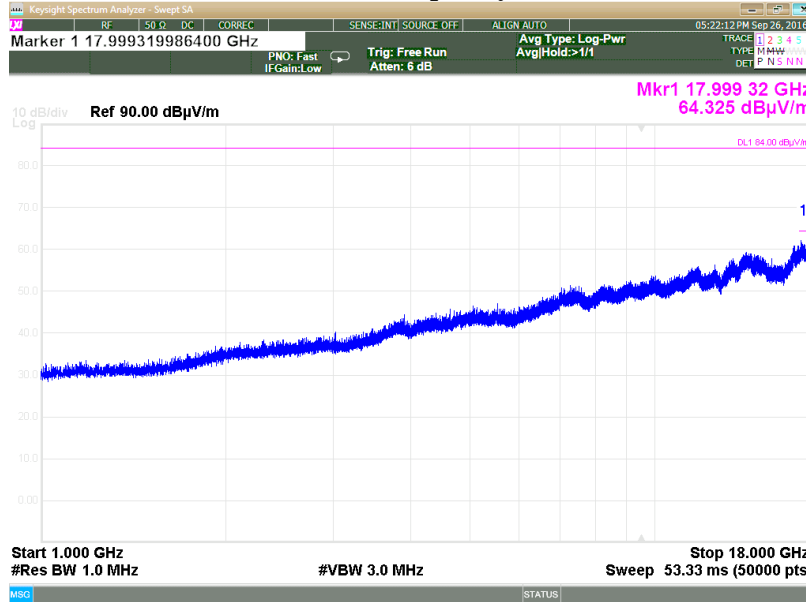

Plot 3.6.4: Spurious Emissions test results, 1 GHz – 18 GHz range, Vertical polarization, Low Frequency

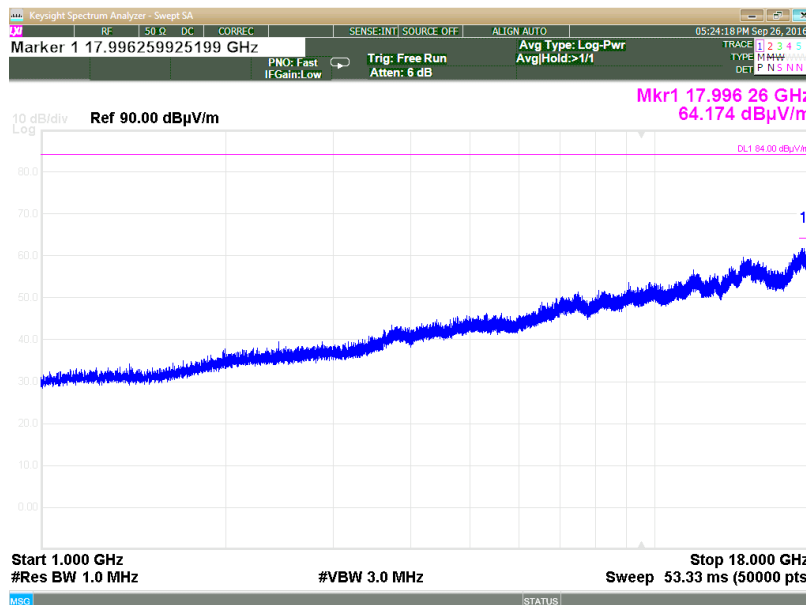

Plot 3.6.5: Spurious Emissions test results, 30 MHz – 1 GHz range, Horizontal polarization, Middle Frequency

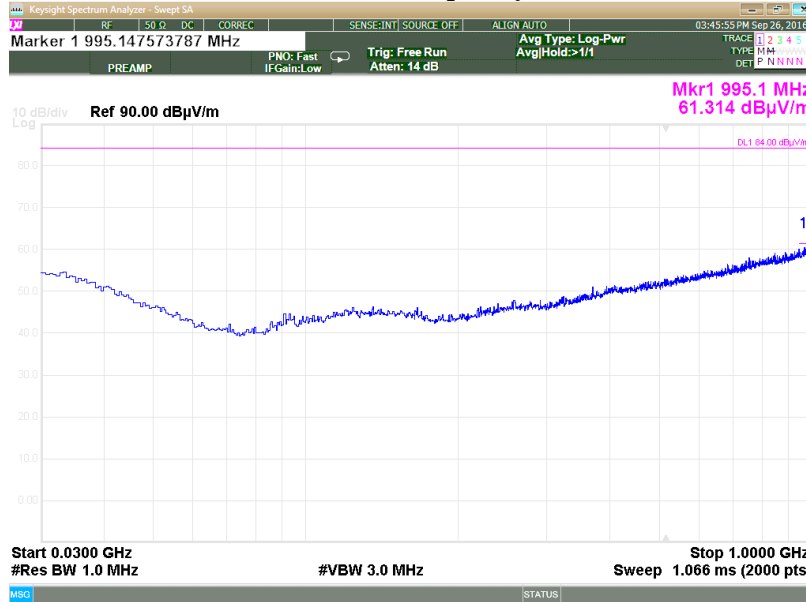

Plot 3.6.6: Spurious Emissions test results, 30 MHz – 1 GHz range, Vertical polarization, Middle Frequency

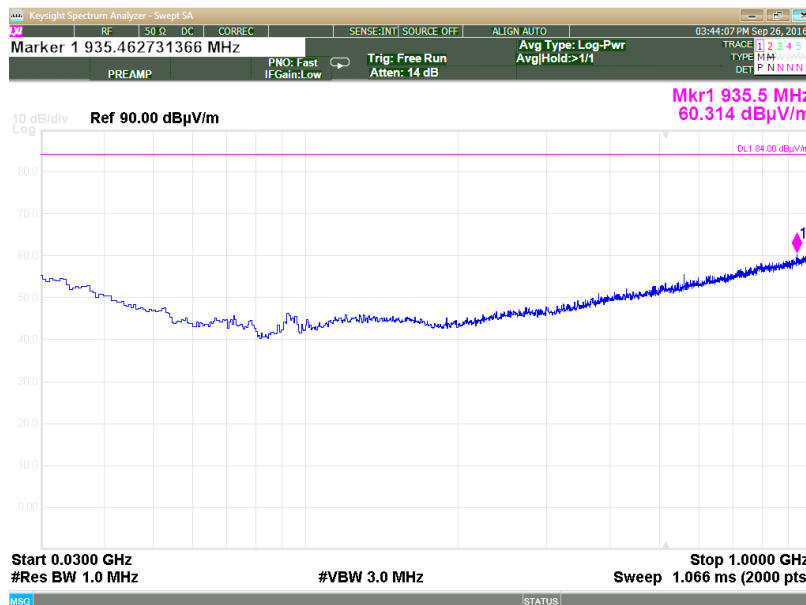

Plot 3.6.7: Spurious Emissions test results, 1 GHz – 18 GHz range, Horizontal polarization, Middle Frequency

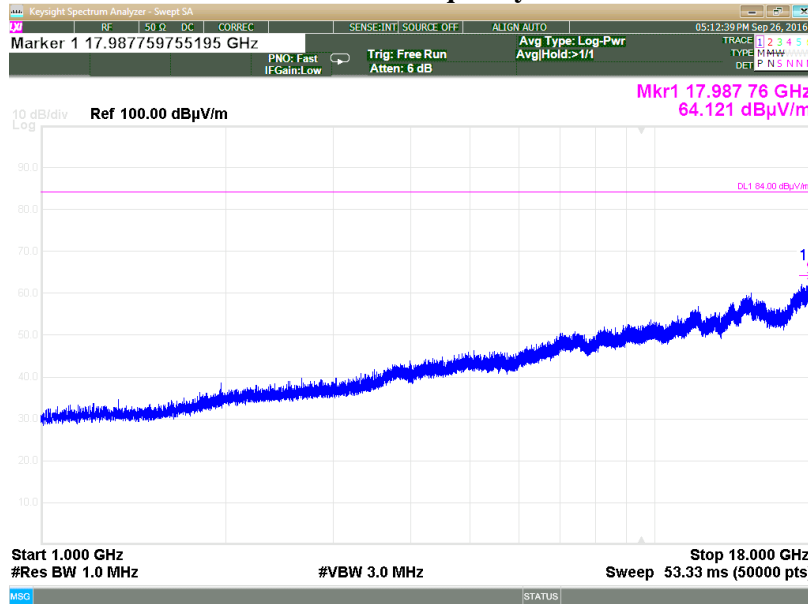

Plot 3.6.8: Spurious Emissions test results, 1 GHz – 18 GHz range, Vertical polarization, Middle Frequency

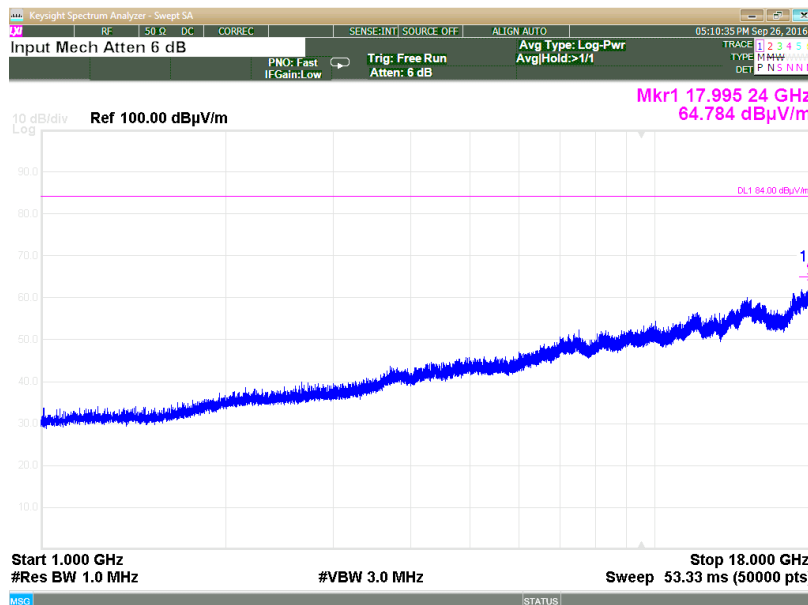

Plot 3.6.9: Spurious Emissions test results, 30 MHz – 1GHz range, Horizontal polarization, High Frequency

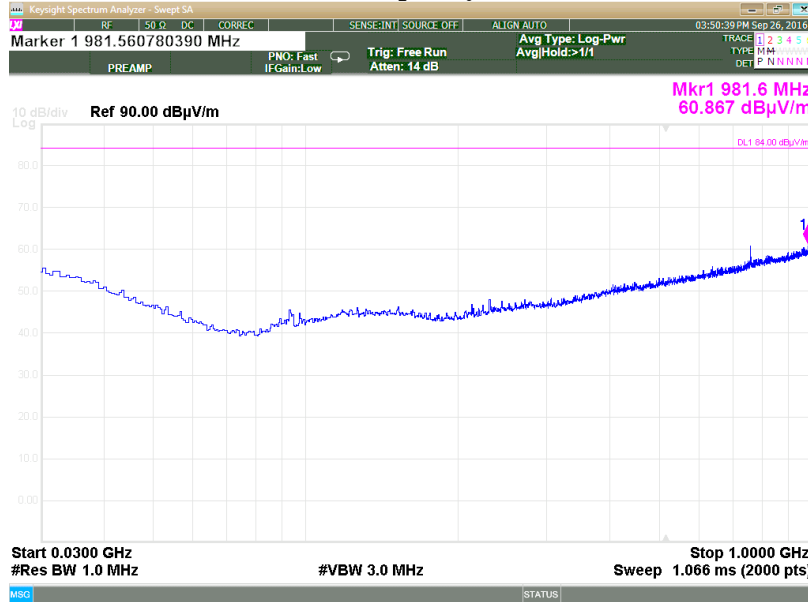

Plot 3.7.10: Spurious Emissions test results, 30 MHz – 1GHz range, Vertical polarization, High Frequency

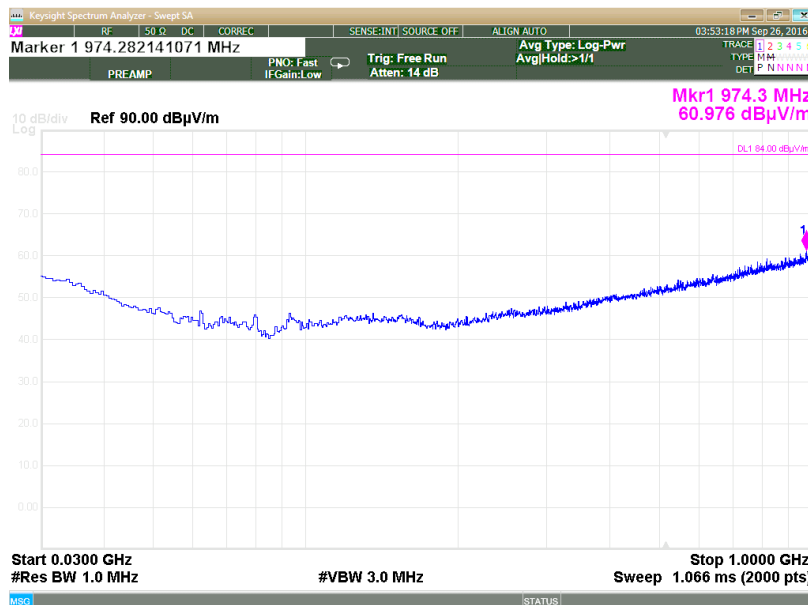

Plot 3.6.11: Spurious Emissions test results, 1 GHz – 18 GHz range, Horizontal polarization, High Frequency

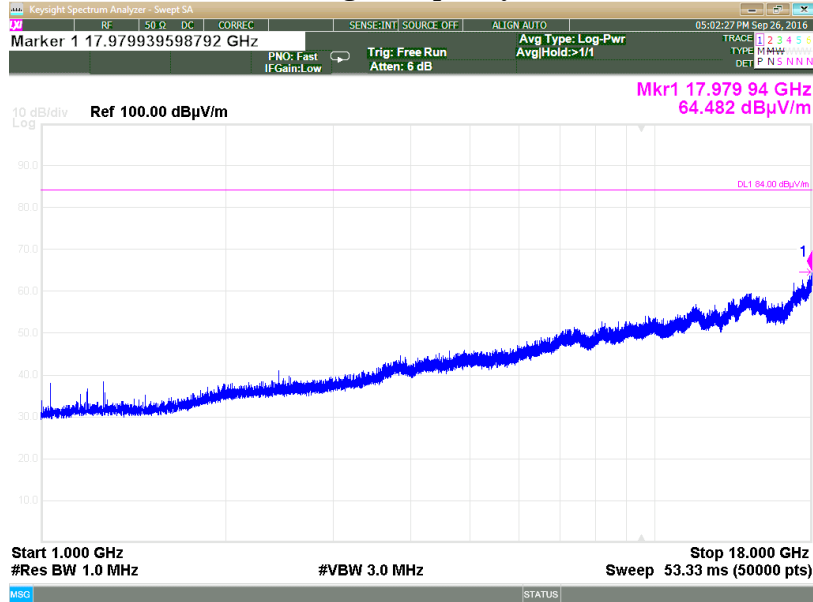

Plot 3.6.12: Spurious Emissions test results, 1 GHz – 18 GHz range, Vertical polarization, High Frequency

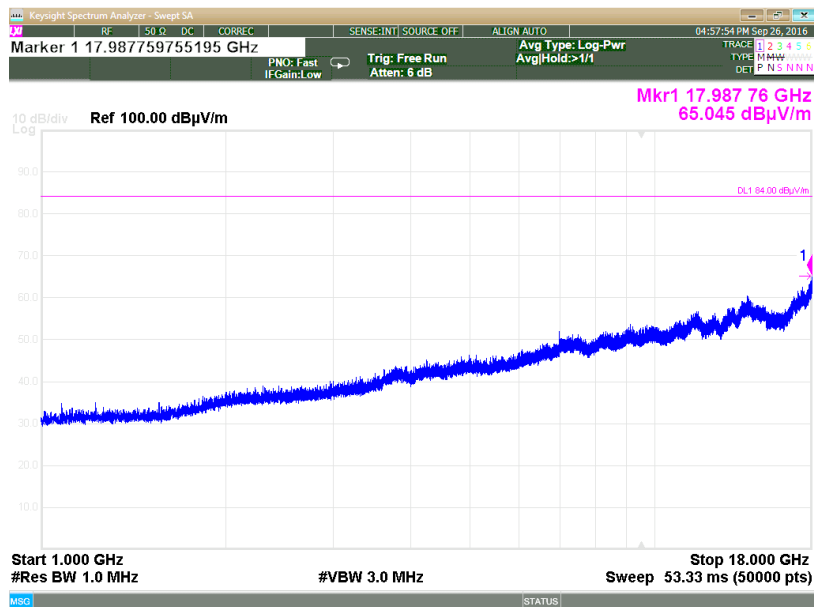

DC Model

Plot 3.6.13: Spurious Emissions test results, 30 MHz – 1 GHz range, Horizontal polarization, Low Frequency



Plot 3.6.14: Spurious Emissions test results, 30 MHz – 1 GHz range, Vertical polarization, Low Frequency

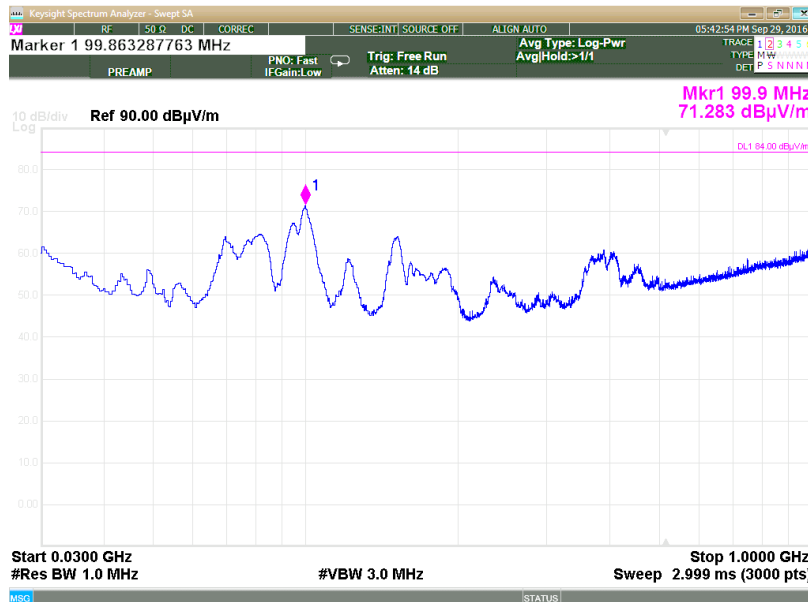

Plot 3.6.15: Spurious Emissions test results, 1 GHz – 18 GHz range, Horizontal polarization, Low Frequency

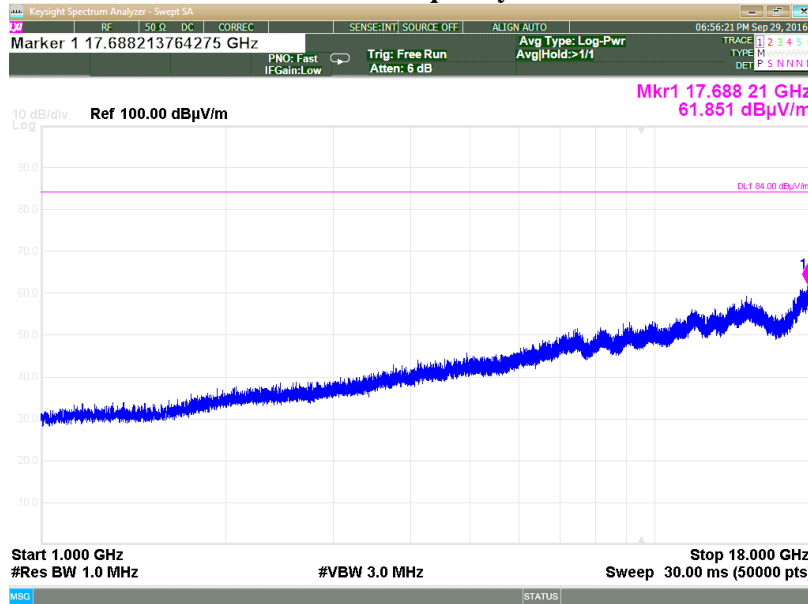

Plot 3.6.16: Spurious Emissions test results, 1 GHz – 18 GHz range, Vertical polarization, Low Frequency

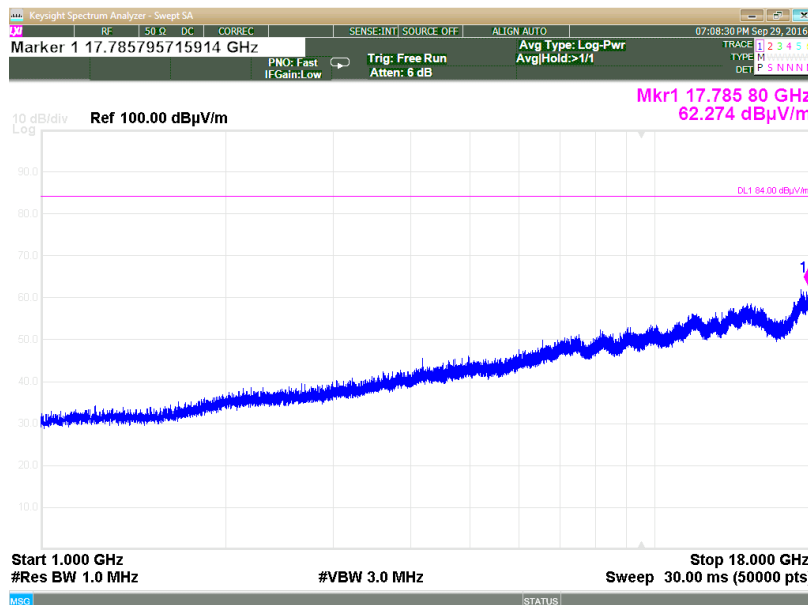

Plot 3.6.17: Spurious Emissions test results, 30 MHz – 1 GHz range, Horizontal polarization, Middle Frequency



Plot 3.6.18: Spurious Emissions test results, 30 MHz – 1 GHz range, Vertical polarization, Middle Frequency

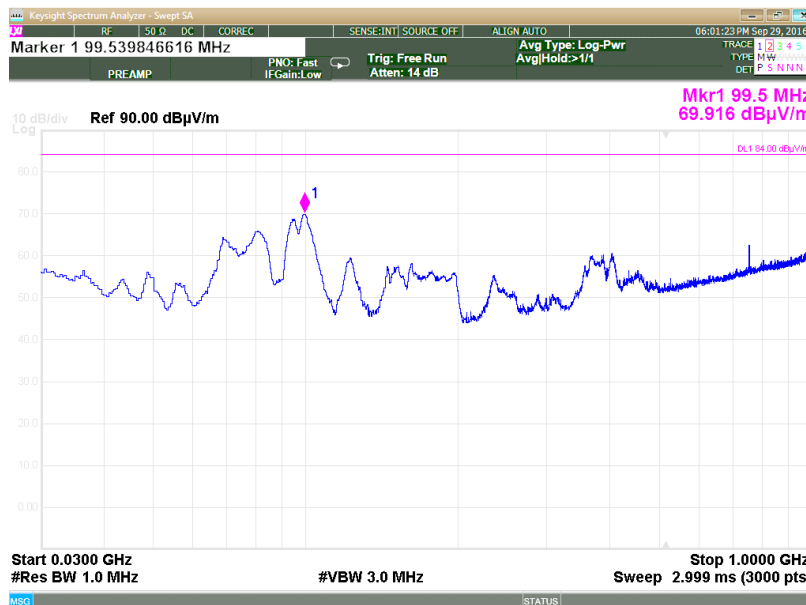

Plot 3.6.19: Spurious Emissions test results, 1 GHz – 18 GHz range, Horizontal polarization, Middle Frequency

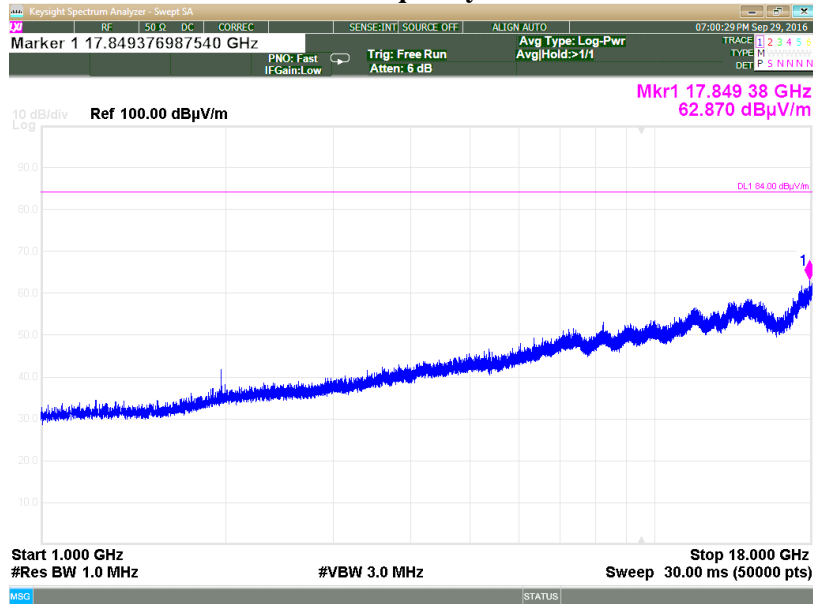

Plot 3.6.20: Spurious Emissions test results, 1 GHz – 18 GHz range, Vertical polarization, Middle Frequency

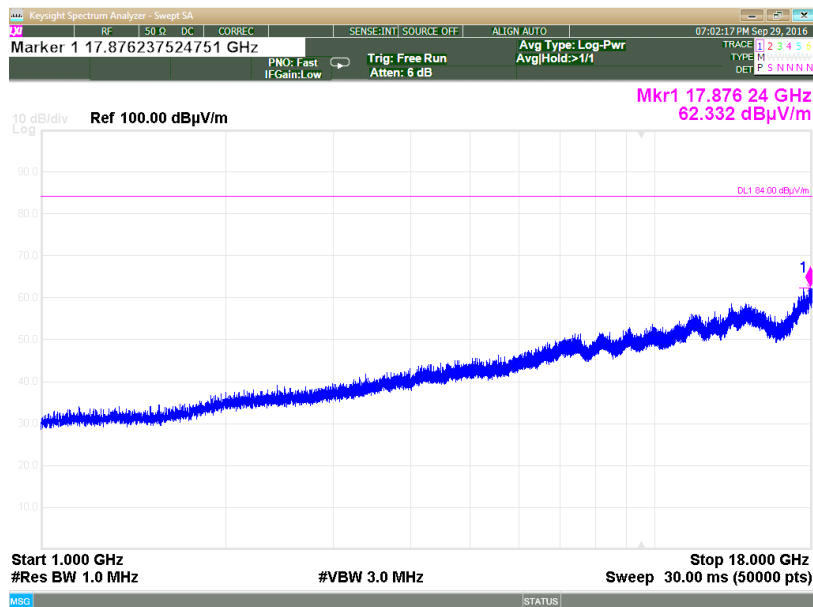

Plot 3.6.21: Spurious Emissions test results, 30 MHz – 1 GHz range, Horizontal polarization, High Frequency

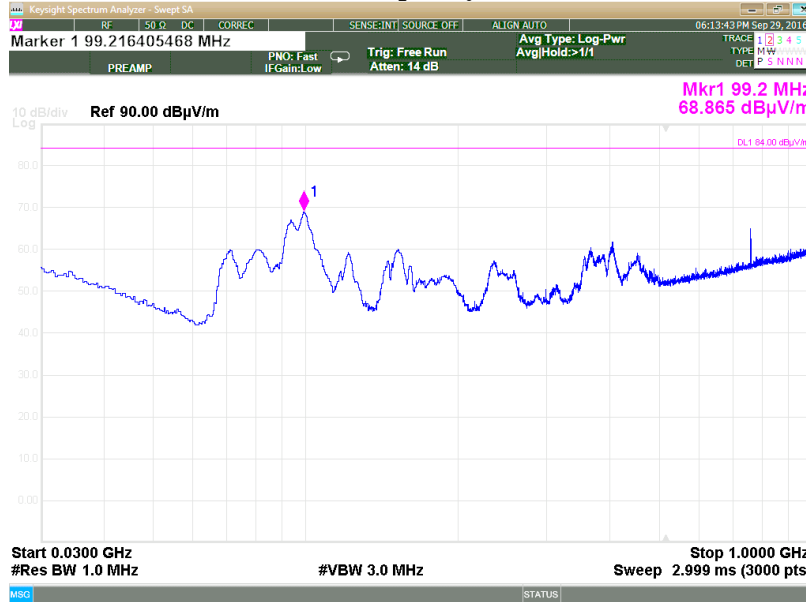

Plot 3.6.22: Spurious Emissions test results, 30 MHz – 1 GHz range, Vertical polarization, High Frequency

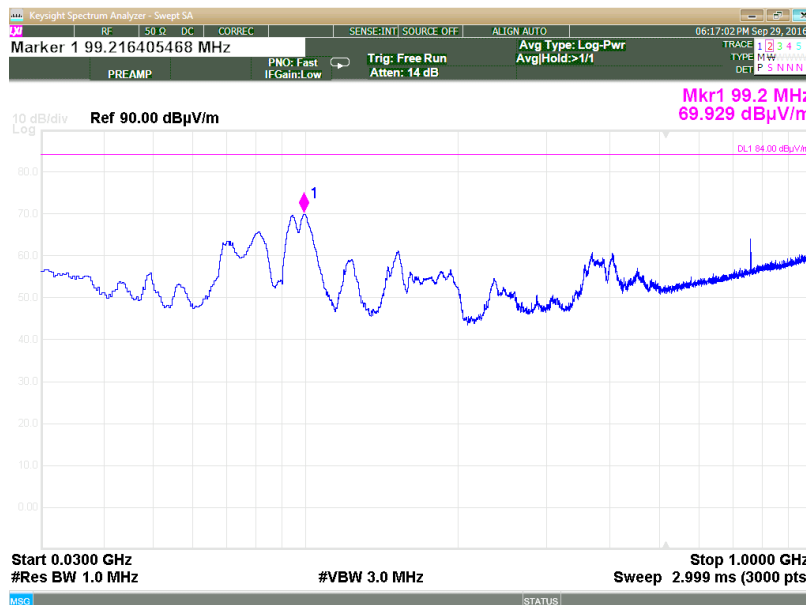

Plot 3.6.23: Spurious Emissions test results, 1 GHz – 18 GHz range, Horizontal polarization, High Frequency

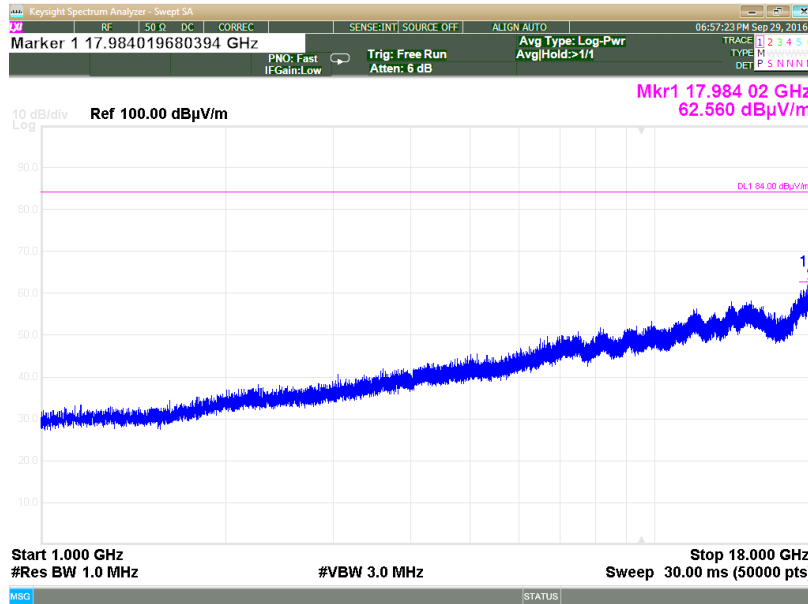

Plot 3.6.24 Spurious Emissions test results, 1 GHz – 18 GHz range, Vertical polarization, High Frequency

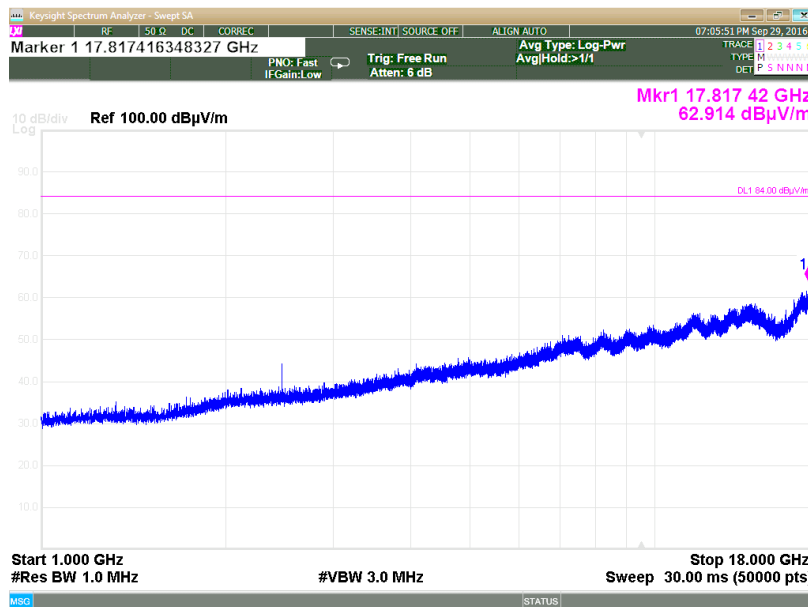

3.7. Frequency stability:

Reference document:	47 CFR §22.355, 47 CFR §2.1055		
Test Requirements:	The frequency stability shall be sufficient to ensure that the fundamental emission stays within the authorized frequency block.		
Method of testing:	KDB 935210 D05v01r01, Conducted	Pass	
Operating conditions:	Under normal and extremes test conditions		
Environment conditions:	Ambient Temperature: 22°C	Relative Humidity: 48%	Atmospheric Pressure: 1011.4 hPa
Test Result:	See below	-	

Test results - Fc= 881.5 MHz

Frequency error vs. Voltage:AC Model

Voltage [VAC]	Frequency Error [Hz]	Frequency Error [%]	Frequency Error [ppm]	Limit [ppm]	Test Result
Carrier frequency at 20°C (120 VAC): 881.5 MHz					
102-138	No Frequency Error observed				Pass

Frequency error vs. Voltage: DC Model

Voltage [Vdc]	Frequency Error [Hz]	Frequency Error [%]	Frequency Error [ppm]	Limit [ppm]	Test Result
Carrier frequency at 20°C (48 VDC): 881.5 MHz					
40.8-55.2	No Frequency Error observed				Pass

Frequency error vs. Temperature

Temperature, °C	Reference Frequency, MHz	Measured Frequency, MHz	Frequency Error, Hz	Frequency Error, ppm	Limit, ppm	Delta	Pass/Fail
-30	881.500150	881.500130	-20.00000	-0.023	1.500	-1.523	Pass
-20	881.500150	881.500130	-20.00000	-0.023	1.500	-1.523	Pass
-10	881.500150	881.500110	-40.00000	-0.045	1.500	-1.545	Pass
0	881.500150	881.500130	-20.00000	-0.023	1.500	-1.523	Pass
10	881.500150	881.500150	0.00000	0.000	1.500	-1.500	Pass
20	Reference temperature						
30	881.500150	881.500150	0.00000	0.000	1.500	-1.500	Pass
40	881.500150	881.500170	20.00000	0.023	1.500	-1.477	Pass
50	881.500150	881.500170	20.00000	0.023	1.500	-1.477	Pass

4. Appendix

Appendix A: List of test equipment used

Description	Manufacturer	Model	Serial No.	Last Cal	Cal Due
Anechoic new (large) chamber	-----	-----	-----	10/03/2016	10/03/2018
Bilog Antenna	Teseq	CBL 6141B	34119	03/07/2016	03/07/2017
EMC Analyzer	Agilent	E7405A	US41160436	02/06/2016	02/06/2017
EMI Receiver (2.9GHz)	HP	8546A	3617A00318	23/05/2016	23/05/2017
EMI Receiver (6.5GHz)	HP	8546A	3710A00392	09/02/2016	09/02/2017
Horn Antenna 1-18GHz	A.R.A	DRG-118/A	17188	18/05/2016	18/05/2017
Horn Antenna 15-40 GHz	Schwarzbeck	BBHA 9170	BBHA9170214	06/03/2015	06/03/2018
LNA Amplifier 1 GHz to 18 GHz	AMP	7D-010180-30-10P-GW	618653	23/02/2016	23/02/2017
Low-Noise Amplifier 18 - 26.5 GHz	Miteq	AMF-5F-18002650-30-10P	945372	23/02/2016	23/02/2017
Power Meter	Agilent	N1911A	MY45100784	15/01/2015	15/01/2017
RF Filter Section (2.9GHz)	HP	85460A	3448A00282	23/05/2016	23/05/2017
RF Filter Section (6.5GHz)	HP	85460A	3704A00366	09/02/2016	09/02/2017
Spectrum Analyzer 3Hz-44GHz	Agilent	E4446A	MY46180602	13/11/2014	13/11/2016
Wideband Power Sensor	Agilent	N1921A	MY45241242	15/01/2015	15/01/2017

Appendix B: Accreditation Certificate



Accredited Laboratory

A2LA has accredited

QUALITECH
Petah-Tikva, Israel

for technical competence in the field of

Electrical Testing

This laboratory is accredited in accordance with the recognized International Standard ISO/IEC 17025:2005 *General requirements for the competence of testing and calibration laboratories*. This accreditation demonstrates technical competence for a defined scope and the operation of a laboratory quality management system (refer to joint ISO-ILAC-IAF Communiqué dated 8 January 2009).



Presented this 28th day of June 2016.



Senior Director of Quality and Communications
For the Accreditation Council
Certificate Number 1633.01
Valid to June 30, 2018

For the tests to which this accreditation applies, please refer to the laboratory's Electrical Scope of Accreditation.

End of the Test Report