

Center for Quality Engineering

Test Report No.: T021FRNN

FCC ID: NE3PCS100

Order No.: T021 **Pages:** 41 **Enclosures:** 0 **Munich,** 6. June 2005

Client: Siemens Communications, Inc.
900 Broken Sound Parkway
Boca Raton, FL33478

Equipment under test: Base Transceiver Station Equipment for W-CDMA
NB-580 UMR4.0

Manufacturer: Siemens AG / NEC

Task: Conformance test according to the below mentioned test
specification

Test Specification(s): 47 CFR

Result: The EUT complies with the requirements of the test specification.

The results relate only to the items tested as described in this test report.

Approved by:	Date	Signature
Dr. - Ing. Khelifi Director 'System Qualification'	6.6.2005	
Bauer Director 'EMC'	8.6.2005	
Alt Director 'Environmental Engineering'	8.6.2005	

CONTENTS

1 Summary	4
2 References	5
2.1 Specifications	5
2.2 Glossary of Terms – General Abbreviations	5
2.3 Bibliography	7
3 General Information	8
3.1 Identification of Client.....	8
3.2 Test Laboratory	8
3.3 Time Schedule	8
3.4 Participants	8
4 Equipment Under Test (EUT)	9
4.1 Description of EUT	9
4.2 Configuration of EUT.....	9
4.3 Operating Conditions	9
5 General Description of Tests	11
5.1 Tested Carrier Frequencies	11
5.2 Modulation Characteristics.....	11
5.3 Test Configuration.....	11
5.4 Calibration of the Test Equipment.....	12
6 Test Results	13
6.1 Test No. 1: RF power output (§ 2.1046).....	13
6.1.1 Purpose	13
6.1.2 EUT Operating Condition	13
6.1.3 Test Configuration	13
6.1.4 Test Procedure and Results	13
6.2 Test No. 2: Modulation Characteristics (§ 2.1047, § 2.201).....	14
6.3 Test No. 3: Occupied Bandwidth (§ 2.1049).....	15
6.3.1 Purpose	15
6.3.2 EUT Operating Condition	15
6.3.3 Test Configuration	15
6.3.4 Test Procedure and Results	15
6.4 Test No. 4: Spurious Emissions at Antenna Terminals (§ 2.1051, § 2.1057, § 24.238).....	16
6.4.1 Purpose	16
6.4.2 Limits	16

6.4.3 EUT Operating Condition	16
6.4.4 Test Configuration	16
6.4.5 Test Procedure and Results	16
6.5 Test No. 5: Field Strength of Spurious Radiation (§ 2.1053, § 2.1057, § 24.238)	18
6.5.1 Purpose	18
6.5.2 Limits	18
6.5.3 EUT Operating Condition	18
6.5.4 Test Configuration	18
6.5.5 Test Procedure	19
6.5.6 Test Results & Limits	19
6.6 Test No. 6: Frequency Stability (§ 2.1055, § 24.235).....	20
6.6.1 Purpose	20
6.6.2 Limits	20
6.6.3 EUT Operating Condition	20
6.6.4 Test Configuration	20
6.6.5 Test Procedure and Results	21
7 Test Data and Screenshots	22
7.1 Part List of the RF Measurement Test Equipment	22
7.2 Spectral Plots	23
7.2.1 Test No. 1: RF Power Output	23
7.2.2 Test No. 2: Modulation Characteristics	25
7.2.3 Test No. 3: Occupied Bandwidth	26
7.2.4 Test No. 4: Spurious Emissions at the Antenna Terminals	28
7.2.5 Test No. 5: Field Strength of Spurious Radiation	38
7.2.6 Test No. 6: Frequency Stability	41

1 Summary

The measurements described in this report were conducted pursuant to 47 CFR § 2.947. All applicable paragraphs of the 47 CFR parts 2 and 24 of the most current version of the rules were considered.

The following tests were performed according to the FCC rules in order to verify the compliance of the EUT with the FCC requirements:

Table 1.1: Results – Summary

Test No.	Measurement	FCC Rule	Page Number of this Report	Result
1	RF Power Output	§ 2.1046	13	compliant
2	Modulation Characteristics	§ 2.1047, § 2.201	14	compliant
3	Occupied Bandwidth	§ 2.1049	15	compliant
4	Spurious Emissions at Antenna Terminals	§ 2.1051, § 2.1057, § 24.238	16	compliant
5	Field Strength of Spurious Radiation	§ 2.1053, § 2.1057, § 24.238	18	compliant
6	Frequency Stability	§ 2.1055, § 24.235	20	compliant

In accordance with the FCC Rule §15.3 (z) the equipment was tested with the limits that are valid for an *unintentional radiator*.

2 References

2.1 Specifications

- [1] 47 CFR Code of Federal Regulations, Title 47: Telecommunication 2004-10

2.2 Glossary of Terms – General Abbreviations

°C	Degrees Celsius
3GPP	3 rd Generation Partnership Project
A	Ampere
AC	Alternating Current
ACLR	Adjacent Channel Leakage Power Ratio
ACS	Adjacent Channel Selectivity
AMR	Adaptive Multi Rate
ANT	Antenna
ATM	Asynchronous Transfer Mode
BB	Base Band
BER	Bit Error Ratio
BLER	Block Error Ratio
BS	Base Station
BTS	Base Transceiver Station
BTSE	Base Transceiver Station Equipment
CAN	Controller Access Network
CE	Channel Element
CPICH	Common Pilot Channel
DAR	Deutscher Akkreditierungsrat (German Accreditation Council)
DATech	Deutsche Akkreditierungsstelle Technik e.V.
dB	Decibel
dBc	Decibel per Carrier
dBm	Decibel per Milliwatt
DC	Direct Current
DCH	Dedicated Channel
DL	Downlink
DPCH	Dedicated Physical Channel
DUT	Device Under Test
EMC	Electromagnetic Compatibility
EN	European Norm
ETR	ETSI Technical Report
ETS	European Telecommunications Standard
ETSI	European Telecommunications Standards Institute
EUT	Equipment Under Test
EVM	Error Vector Magnitude
FACH	Forward Access Channel
FDD	Frequency Division Duplex
FDMA	Frequency Division Multiple Access
GERAN	GSM/EDGE Radio Access Network
GPIB	General Purpose Interface Bus (IEEE-488 bus)
GSM	Global System for Mobile Communications
HF	High Frequency
HU	Height Unit = 44.45 mm for 19" frames
HWIT	Hardware Integration Test
IDN	Identification Number
IEC	International Electrotechnical Commission
IEEE	Name of bus interface type IEEE 488/IEC 625-1
I-ETS	Interim– European Telecommunication Standard
IF	Intermediate Frequency
Iub	Interface between an RNC and a NodeB
kbps	Kilobits per second
LMT	Local Maintenance Terminal
LPT	Line Printer Terminal
max	Maximum

min	Minimum
MOBNET	Mobile Networks
MS	Mobile Station
NB	NodeB
nom	nominal
O&M	Operating & Maintenance
OEM	Original Equipment Manufacturer
OMC	Operation and Maintenance Centre
OMS	Operation and Maintenance System
P	Power
PC	Personal Computer
PCCPCH	Primary Common Control Physical Channel
PCH	Paging Channel
PCPICH	Primary Common Pilot Channel
PDH	Plesiochronous Digital Hierarchy
PICH	Paging Indication Channel
PID	Proportional Integral Differential (Controller)
PLMN	Public Land Mobile Network
Pmax	Maximum Output Power
Prat	Rated Output Power
PSCH	Primary Synchronization Channel
QPSK	Quadrature Phase Shift Keying
R&S	Company "Rohde & Schwarz"
RACH	Random Access Channel
R _b	Measurement channel data rate
RBER	Residual Bit Error Ratio
RBW	Resolution Bandwidth
Ref	Reference
RF	Radio Frequency
RMS	Root Mean Square
RNC	Radio Network Controller
RNS	Radio Network Subsystem
RX	Receive Path
RxDiv	RX Diversity
SCCPCH	Secondary Common Control Physical Channel
SDH	Synchronous Digital Hierarchy
SEM	Spectrum Emission Mask
SMT	Signal Modulated Terminal
SN	Serial Number
SSCH	Secondary Synchronization Channel
STM	Synchronous Transfer Mode
SW	Software
T	Temperature
TC	Testcase
TDD	Time Division Duplex
TDMA	Time Division Multiple Access
TRX	Transceiver
TS	Technical Specification
TX	Transmit Path
TxDiv	TX-Diversity
UARFCN	UTRA Absolute Radio Frequency Channel Number
UE	User Equipment
UL	Uplink
UMR	UMTS Release
UMTS	Universal Mobile Telecommunications System
UTRA	Universal Terrestrial Radio Access
UTRAN	Universal Terrestrial Radio Access Network
Uu	UMTS Air Interface
V	Volt
VC	Virtual Channel
VP	Virtual Path
W	Watt
w/	with
w/o	without

2.3 Bibliography

- | | | | |
|-----|------------------------|---|---------|
| [2] | 3GPP 25.141,
V6.9.0 | Universal Mobile Telecommunications System (UMTS);
Base Station (BS) conformance testing (FDD) | 2005-03 |
| [3] | 3GPP 25.213,
V6.1.0 | Universal Mobile Telecommunications System (UMTS);
Spreading and modulation (FDD) | 2004-12 |

3 General Information

3.1 Identification of Client

Siemens Communications, Inc.
900 Broken Sound Parkway
Boca Raton, FL33478
USA

3.2 Test Laboratory

Center for Quality Engineering
Siemens AG
Hofmannstr. 51
81359 Munich
Germany

3.3 Time Schedule

Test No.:	1, 2, 3, 4	5	6
Delivery of EUT:	31.05.2005	09.05.2005	18.05.2005
Start of Test:	01.06.2005	09.05.2005	19.05.2005
End of Test:	01.06.2005	17.05.2005	25.05.2005

3.4 Participants

Name	Function
Dr. Jochen Beier	Testing (1, 2, 3, 4)
Jan Huber	Testing (5)
Melanie Maurer, Werner Johne	Testing (6)
Jens Jachmann	Supervision of EUT functionality
Mario Krüger	Supervision of EUT functionality
Sanda Pavlisin	Supervision of EUT functionality

4 Equipment Under Test (EUT)

The client affirmed, that the equipment is representative for serial production.

4.1 Description of EUT

The Equipment Under Test (EUT), the NodeB is a part of the UMTS Radio Access Network (UTRAN) developed by Siemens and NEC. The UTRAN consists of one or more Radio Network Subsystems (RNS) containing one Radio Network Control Unit (RNC) and several NodeB. The NodeB is responsible for the radio transmission/reception to/from the User Equipment (UE) via the air interface.

The maximum transmitter output power possible for the NB-580 is 48 dBm = 63.1 W.

4.2 Configuration of EUT

The equipment under test (EUT) was fully equipped with 6 transceivers, although for tests 1 to 4 and 6 only one transceiver was tested for compliance. Test 5 is an over all test that covers the whole EUT. The tested transceivers are listed in the table below.

Table 4.1: Configuration of EUT (NB-580)

Module Name	Siemens Part No.	Serial No.	Test No.
CAT40-3-4UFV1	S30861-U4287-X-03/01	RMX/T4010032	1, 2, 3, 4
DUAMCURETUFV1	S30861-U4270-X-02/01	KSA/T2655787	1, 2, 3, 4
CAT40-3-4UFV1	S30861-U4287-X-02/01	RMX/T2000019	5
CAT40-3-4UFV1	S30861-U4287-X-02/01	RMX/T3010030	5
CAT40-3-4UFV1	S30861-U4287-X-02/01	RMX/T3010019	5
CAT40-3-4UFV1	S30861-U4287-X-02/01	RMX/T2000023	5
CAT40-3-4UFV1	S30861-U4287-X-02/01	RMX/T2000006	5
CAT40-3-4UFV1	S30861-U4287-X-02/01	RMX/T2000011	5
DUAMCURETUFV1	S30861-U4270-X-02/01	KSA/T2403518	5
DUAMCURETUFV1	S30861-U4270-X-02/01	KSA/T2403514	5
DUAMCURETUFV2	S30861-U4273-X-03/01	CRB/T4000049	5
CAT40-3-4UFV1	S30861-U4287-X-B1/01	RMX/T3000001	6
DUAMCURETUFV1	S30861-U4270-X-02/01	KSA/T2403517	6

For a functional description of the modules, please refer to the appropriate related parts and exhibit sections of this certification application.

4.3 Operating Conditions

If not stated otherwise, the following standard setup procedure for the EUT was used:

The NodeB was activated and controlled by an application SW (LMT) running on a PC, connected to the Core Controller of the NodeB via an ethernet connection. A combination of QPSK and 16QAM modulated channels was used to ensure that the influences of both possible modulations are covered by the tests (test model "TM5" with 30 QPSK and 8 16QAM channels as specified in 3GPP 25.141 [2]) (see also section 5.2).

The NB-580 is supplied with -48 V DC.

During the measurements, one carrier channel was tested at a time. The carrier was set to the maximum power level to ensure the maximum emission amplitudes during all measurements.

During the tests the NodeB is transmitting a pseudo random bit pattern on the data channels. This ensures that the measurements of the emission characteristics of the transmitter are pursuant to § 2.1049.

5 General Description of Tests

5.1 Tested Carrier Frequencies

The measurements were performed on 3 carrier frequencies, according to the following table:

Table 5.1: Carrier Frequencies

Carrier Frequency [MHz]	Remark
1932.5	lowest possible carrier frequency
1960.0	frequency at the middle of the band
1987.5	highest possible carrier frequency

5.2 Modulation Characteristics

The EUT supports QPSK and 16QAM modulation. The modulation characteristic of the QPSK and the 16QAM modulation are defined in standard 3GPP TS 25.213 [3].

5.3 Test Configuration

If not stated otherwise, the following measurement configuration was used to perform all measurements (see figure below).

The RF output of the transceiver (cell) under test is connected to a spectrum analyzer (FSIQ26, Rohde&Schwarz) via a high power 30 dB attenuator. The attenuator is used to protect the input of the spectrum analyzer from high RF power levels. A description of the analyzer settings is given in each of the sections describing the measurements. The other transceivers are terminated. The FSIQ is remote controlled from a PC via a GPIB interface.

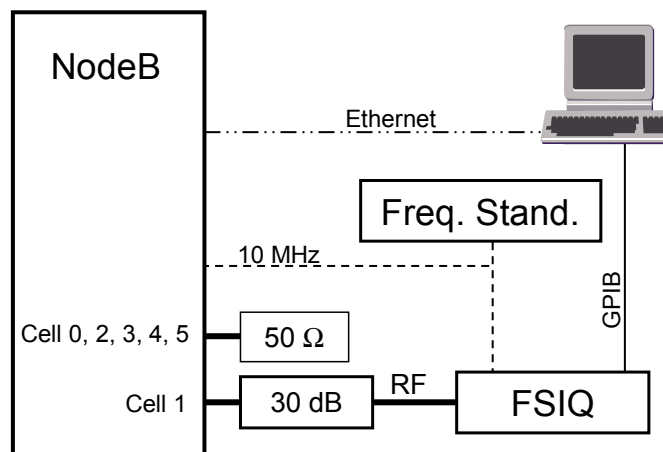

Fig. 1 – Test Configuration

A complete list of the measurement equipment is included on page 22 of this measurement report.

5.4 Calibration of the Test Equipment

All relevant test equipment has a valid calibration from an external calibration laboratory. Additionally the spectrum analyzer has a built-in self-calibration procedure. This calibration procedure was activated prior to the measurements so that the analyzer is deemed accurate. High quality cables were used to connect the measurement equipment to the EUT. The actual loss of the attenuator and the cables was measured with a high precision network analyzer and taken into account for all measurements.

6 Test Results

6.1 Test No. 1: RF power output (§ 2.1046)

6.1.1 Purpose

The RF power output measurements were performed pursuant to § 2.1046 in order to determine the base station maximum RF output power of the EUT.

6.1.2 EUT Operating Condition

The standard setup procedure as described in section 4.3 of this report was used.

6.1.3 Test Configuration

The test configuration used is described in section 5.3 of this report.

6.1.4 Test Procedure and Results

Using a spectrum analyzer the RF power is measured with a frequency sweep across the carrier (see screenshots). The carrier power is calculated from the spectrum analyzer by integration over the result. The base station maximum output power is the sum of the measured carrier power and the external attenuation (cable loss of the test set up).

The following table shows the measured output powers at the antenna connector. Screenshots of the measurements are included on pages 23 – 24 of this report.

Table 6.1: Results – Base Station Maximum Output Power

Carrier Frequency [MHz]	Measured Carrier Power [dBm]	External Attenuation [dB]	Base Station Maximum Output Power	Result
1932.5	12.15	33.67	45.8 dBm = 38.2 W	compliant
1960.0	12.59	33.79	46.4 dBm = 43.4 W	compliant
1987.5	12.50	33.73	46.2 dBm = 42.0 W	compliant

The base station maximum output power was found to be compliant with the manufacturer's specifications and with all requirements of the FCC rules.

6.2 Test No. 2: Modulation Characteristics (§ 2.1047, § 2.201)

The occupied bandwidth was measured to be 4.2 MHz, which represents the 99% power bandwidth (see the following section and screenshots on pages 26 – 27). Therefore, the modulation characteristic of the base stations transceiver is 4M20F9W.

No further testing is required under this section of the FCC rules. No measurements other than the occupied bandwidth are required.

The modulation characteristics were found to be compliant with the manufacturer's specifications and with all requirements of the FCC rules.

6.3 Test No. 3: Occupied Bandwidth (§ 2.1049)

6.3.1 Purpose

The measurements are performed to determine the occupied bandwidth of the EUT pursuant to § 2.1049.

6.3.2 EUT Operating Condition

The standard setup procedure as described in section 4.3 of this report was used.

6.3.3 Test Configuration

The test configuration used is described in section 5.3 of this report.

6.3.4 Test Procedure and Results

The 99% power bandwidth (occupied bandwidth) was determined with the spectrum analyzer (see screenshots on pages 26 – 27 for details). The following table summarizes the results:

Table 6.2: Results – Occupied Bandwidth

Carrier Frequency [MHz]	Occupied Bandwidth [MHz]	Result
1932.5	4.2	compliant
1960.0	4.2	compliant
1987.5	4.2	compliant

The occupied bandwidth was found to be compliant with the manufacturer's specifications and with all requirements of the FCC rules.

6.4 Test No. 4: Spurious Emissions at Antenna Terminals (§ 2.1051, § 2.1057, § 24.238)**6.4.1 Purpose**

The measurements of the spurious emissions at the equipment output terminals were performed pursuant to § 2.1051 in order to verify that all emissions are below the limits given by § 24.238.

6.4.2 Limits

Compliance with § 24.238 requires that any emission be attenuated below the transmitter power by at least $43 + 10 \log_{10} P$ (P = transmitter power in Watts).

The compliance limit was calculated in the following way:

Maximum transmitter output power [W]:	P
Maximum transmitter output power [dBm]:	$30 + 10 \log_{10} P$ (conversion form W to dBm)
Attenuation required by FCC:	$43 + 10 \log_{10} P$

Compliance limit = Maximum transmitter output power - Required attenuation
= $30 + 10 \log_{10} P$ - $(43 + 10 \log_{10} P)$ = -13 dBm

6.4.3 EUT Operating Condition

The standard setup procedure as described in section 4.3 of this report was used.

6.4.4 Test Configuration

The test configuration used is described in section 5.3 of this report.

6.4.5 Test Procedure and Results

The tests were carried out in accordance with § 24.238. For all frequency ranges except two (the one immediately below and the one immediately above the carrier frequency block) a 1 MHz resolution bandwidth was used for the measurements. Thereby the integration method mentioned in § 24.238 was used in the two frequency ranges from 1 MHz to 2.5 MHz distance from the carrier frequency block.

In the 1 MHz frequency bands immediately outside and adjacent to the carrier frequency block a resolution bandwidth of 48 kHz (one percent of the emission bandwidth of the fundamental emission of the transmitter as defined in § 24.238) was employed. Again the integration method was used.

The following figure gives an overview of the bandwidths used for the tests.

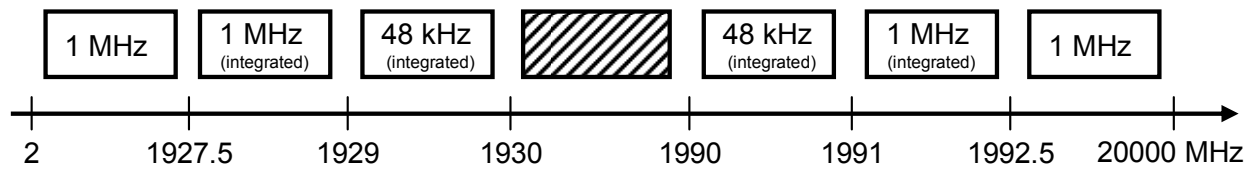

Fig. 2 – Resolution Bandwidths for Spurious Emission Tests

According to § 2.1057, all emission including the fundamental frequency of the transceiver and all frequencies up to the 10th harmonic were investigated.

The following tables summarize the worst case detected emission levels (see screenshots on pages 28 – 37 for details). The external attenuation (cable loss of the set up) is already added in the results. It can be seen separately as the “Offset” value in the screenshots.

Table 6.3: Results - Spurious Emissions

Frequency Range [MHz]	Emission Frequency [MHz]	Maximum Emission Level [dBm]	Compliance Limit [dBm]	Result
Carrier Frequency 1932.5 MHz				
2.0 – 1927.5	1927.5	-23.2	-13	compliant
1927.5 – 1929.0	1929.0	-14.4	-13	compliant
1929.0 – 1930.0	1930.0	-15.4	-13	compliant
1990.0 – 1991.0	1990.7	-48.2	-13	compliant
1991.0 – 1992.5	1991.3	-29.2	-13	compliant
1992.5 – 20000.0	6900.4	-27.8	-13	compliant
Carrier Frequency 1960.0 MHz				
2.0 – 1927.5	1715.3	-35.1	-13	compliant
1927.5 – 1929.0	1928.6	-28.4	-13	compliant
1929.0 – 1930.0	1929.3	-46.5	-13	compliant
1990.0 – 1991.0	1990.7	-47.3	-13	compliant
1991.0 – 1992.5	1991.1	-29.0	-13	compliant
1992.5 – 20000.0	3905.1	-29.3	-13	compliant
Carrier Frequency 1987.5 MHz				
2.0 – 1927.5	1699.8	-35.1	-13	compliant
1927.5 – 1929.0	1927.9	-28.4	-13	compliant
1929.0 – 1930.0	1929.6	-47.0	-13	compliant
1990.0 – 1991.0	1990.0	-15.4	-13	compliant
1991.0 – 1992.5	1991.0	-15.3	-13	compliant
1992.5 – 20000.0	1992.5	-27.6	-13	compliant

The measured conducted emission levels were found to be compliant with the manufacturer’s specifications and with all requirements of the FCC rules.

6.5 Test No. 5: Field Strength of Spurious Radiation (§ 2.1053, § 2.1057, § 24.238)

6.5.1 Purpose

The measurement of spurious radiated emissions was performed pursuant to § 2.1053 and § 2.1057 to verify that the field strength of any spurious emissions radiated directly from the cabinet, control circuits, power leads or intermediate circuit elements are attenuated below the transmitter power P by at least $43 + 10 \log_{10}(P \text{ in Watts})$ dB as is required by § 24.238 (Emission limits).

6.5.2 Limits

Compliance with § 24.238 requires that all spurious emissions be attenuated below the transmitter power by at least $43 + 10 \log_{10} P$ (P = rated maximum transmitter output power in Watts).

The compliance limit was calculated as per the following table:

Rated maximum transmitter output power	63.1 W (= 48.0 dBm)
Required attenuation	$43 + 10 \log_{10} 63.1 = \mathbf{61.0 \text{ dB}}$

According to § 2.1057, all emissions to the 10th harmonic were investigated.

6.5.3 EUT Operating Condition

NodeB was activated with QPSK modulation and controlled by NetHawk RNC/lub simulator via the lub interface (test model "TM1" with 16 channels as specified in 3GPP 25.141 [2]).

During the measurements, one carrier channel was tested at a time. The carrier was set to the maximum power level to ensure the maximum emission amplitudes during all measurements.

During the tests the NodeB is transmitting a pseudo random bit pattern on the data channels. This ensures that the measurements of the emission characteristics of the transmitter are pursuant to § 2.1049.

The radiated spurious emissions were determined for three selected carrier test frequencies, according to section 5.1. During all testing, the EUT's RF output power was terminated into a non-radiating 50Ω dummy load.

6.5.4 Test Configuration

The measurements (scans) were conducted for NB-580. The measurements were performed in an anechoic chamber. The radiated test site complies with the site attenuation requirements listed in ANSI C63.4 1992 and is listed with the FCC.

The test antenna was positioned at a distance of 3 m from the EUT. Photographs of the EUT in the anechoic chamber are shown on page 38 of this measurement report.

6.5.5 Test Procedure

For maximizing the radiated spurious emission measured levels the EUT was rotated 360°. The antenna height was adjusted between 1 m and 4 m. Both, horizontal and vertical polarizations were investigated.

To verify that all spurious emissions are compliant to the limits specified in § 24.238, the substitution method described in the ANSI/TIA/EIA-603-1992 document was used. Initially the EUT’s spurious emission frequencies and field-strength values were measured and recorded. The measured, maximized field strength values were then used as the references levels for dipole substitution measurements.

For substitution measurements the EUT was removed and replaced with a signal generator and a transmitting antenna. TIA/EIA-603 requires that all substitution measurement transmissions have to be done using a “dipole” antenna, as the reference antenna. As per TIA/EIA-603, corrections were done to equate the results to a dipole antenna. Using the same measurement techniques listed above (for maximizing), output power of the signal generator was adjusted until the initial spurious emission reference levels were matched. The signal generator’s indicated output power level was then recorded and corrected to an equivalent level at the transmitting antenna’s input connector.

To determine compliance with the FCC Rules, the corrected dipole substitution powers were then set into relation to the EUT’s (transmitter) power, measured at the antenna connector.

6.5.6 Test Results & Limits

Worst case detected emission levels are reported in the following table (refer to spectral plots included on pages 39 – 40 for details). The antenna factor and cable loss is according to the manufacturer’s specification.

Table 6.4: Results – Field Strength of Spurious Radiation

Spurious Emission Frequency	Spurious Emission Reference Field Strength	Signal Generator Output	Power at dipole antenna ¹	Maximum Transmitter Output Power at the Antenna Port	Spurious Emissions in reference to Output Power of EUT ²	Limit	Result
[MHz]	[dBµV/m]	[dBm]	[dBm]	[dBm]	[dBc]	[dB]	
4953.0000	56.90	-50.0	-57.2	48.0	105.2	61.0	compliant
5133.0000	59.40	-48.0	-55.3	48.0	103.3	61.0	compliant
8417.5000	58.60	-50.0	-56.7	48.0	104.7	61.0	compliant
13714.500	64.00	-44.0	-41.1	48.0	89.1	61.0	compliant
17562.500	62.80	-46.0	-46.1	48.0	94.1	61.0	compliant

The measured emission levels were found to be compliant with the manufacturer’s specifications and with all requirements of the FCC rules.

¹ Power at Dipole Antenna = Signal Generator Output – cable loss + correction factor antenna gain

² [dBc] = Maximum Transmitter Output Power [dBm] - Power at dipole antenna [dBm]

6.6 Test No. 6: Frequency Stability (§ 2.1055, § 24.235)

6.6.1 Purpose

Frequency stability measurements were performed to verify that the frequency deviation of the emission stays within the licensee's frequency block under extreme temperature conditions (-30°C to +50 °C) according to § 2.1055.

6.6.2 Limits

According to § 24.235, the frequency of the fundamental emission is required to stay within the authorized frequency block, independent of the ambient temperature.

6.6.3 EUT Operating Condition

NodeB was activated and controlled by NetHawk RNC/lub simulator via the lub interface. A combination of QPSK and 16QAM modulated channels was used to ensure that the influences of both possible modulations are covered by the tests (test model "TM5" with 6 QPSK and 5 16QAM channels similar as specified in 3GPP 25.141 [2]) (see also section 5.2). A test mobile (TM500) is used to provide the NodeB with the data necessary in uplink direction in order to stimulate the 16QAM channels in downlink direction.

During the measurements, one carrier channel was tested at a time. The carrier was set to the maximum power level to ensure the maximum emission amplitudes during all measurements.

The rated supply voltage of -48 V DC was kept constant for all temperatures. Additionally the supply voltage was set to maximum and minimum voltage at room temperature.

During the tests the NodeB is transmitting a pseudo random bit pattern on the data channels. This ensures that the measurements of the emission characteristics of the transmitter are pursuant to § 2.1049.

The EUT was operated and tested in a climatic chamber.

6.6.4 Test Configuration

The RF output of the transceiver (cell) under test is connected to a spectrum analyzer (FSU26, Rohde&Schwarz) via a high power 30 dB attenuator. The attenuator is used to protect the input of the spectrum analyzer from high RF power levels. The other transceivers are terminated. The FSU is remote controlled from a laptop via a GPIB interface.

A complete list of the measurement equipment is included on page 22 of this measurement report.

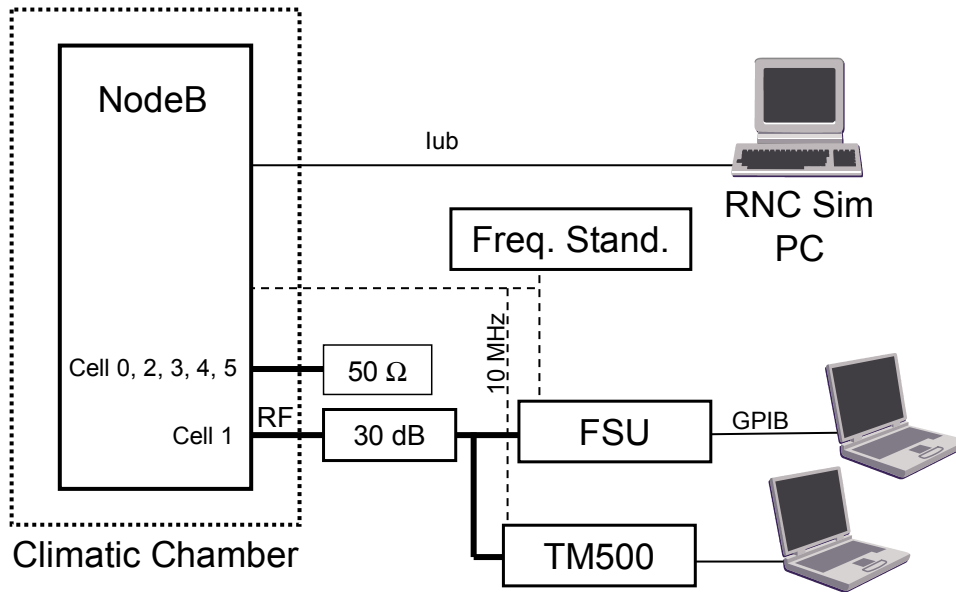

Fig. 3 – Test Configuration for Frequency Stability

6.6.5 Test Procedure and Results

The center frequency deviation of the highest and lowest test frequency was measured at ambient temperature levels from -5°C to +50°C in intervals of not more than 10°C using the rated normal supply voltage. Additionally the center frequency deviation was measured at room temperature using maximum and minimum supply voltage.

The NB-580 is designed for indoor locations. Therefore the EUT does not work below a temperature of -5°C, thus no RF signals were measured at the antenna port.

The following table reports the worst case detected frequency deviations. For the complete measurement data of the frequency stability see page 41.

Table 6.5: Results – Frequency Stability (Normal Supply Voltage)

Ambient Temp. [°C]	Frequency Deviation [ppm]	Manufacturer's Specification [ppm]	Result
-5	0.019	0.05	compliant
0	-0.024	0.05	compliant
+10	-0.029	0.05	compliant
+20	0.023	0.05	compliant
+30	-0.019	0.05	compliant
+40	0.026	0.05	compliant
+50	-0.024	0.05	compliant
+20 V _{min} /V _{max}	0.025	0.05	compliant

In all cases, the fundamental emission stayed within the authorized frequency block.

The measured frequency stability was found to be compliant with the manufacturer's specifications and with all requirements of the FCC rules.

7 Test Data and Screenshots

7.1 Part List of the RF Measurement Test Equipment

No.	Item	Model (Manufacturer)	Serial Number	Test No.
1	Spectrum Analyzer	FSIQ 26 (Rohde & Schwarz)	100230	1, 2, 3, 4
2	Frequency Standard	Rb-TSR (Datum GmbH)	151	1, 2, 3, 4
3	Personal Computer	Scenic Pro M6 (Siemens Nixdorf)	VKO25345	1, 2, 3, 4
4	test chamber	Siemens	-	5
5	antenna	Singer	0273	5
6	amplifier	miteq	909363	5
7	ESMI display section	R&S	849182/009	5
8	ESMI RF section	R&S	849937/003	5
9	controller	Deisel	100/503	5
10	antenna	SCIEN	100	5
11	antenna	Ailtech	2622	5
12	antenna	Chase	1566	5
13	antenna	Emco	8906-3173	5
14	signal generator	R&S	832033/0006	5
15	mast	Deisel	240/445	5
16	Frequency Standard	RubiSource 2000 (Datum GmbH)	224	5
17	RNC lub Simulator	D3 PCI card (NetHawk)	601	5
18	STM1-E1 Converter	ACE 101 (ACE)	27020814	5
19	Personal Computer	FSC	60105622	5
20	Spectrum Analyzer	FSU 26 (Rohde & Schwarz)	100298	6
21	Laptop	Lifebook E-6585 (FSC)	YBPJ005534	6
22	Frequency Standard	RubiSource T&M (Datum GmbH)	107	6
23	Testmobile	TM500 (Ubinetics)	97	6
24	Laptop	E7010 (FSC)	CP131102	6
25	RNC lub Simulator	D3 PCI card (NetHawk)	88	6
26	Personal Computer	FSC	22106657	6

7.2 Spectral Plots

7.2.1 Test No. 1: RF Power Output

The value “CH PWR” is the carrier power measured by the FSIQ. “REF PWR” (and also “Offset”) is the external attenuation (cable loss of the test set up). The sum of both values is base station maximum output power given on page 13. The external attenuation is frequency dependant. Thus the various “Offset” values in the screenshots may differ.

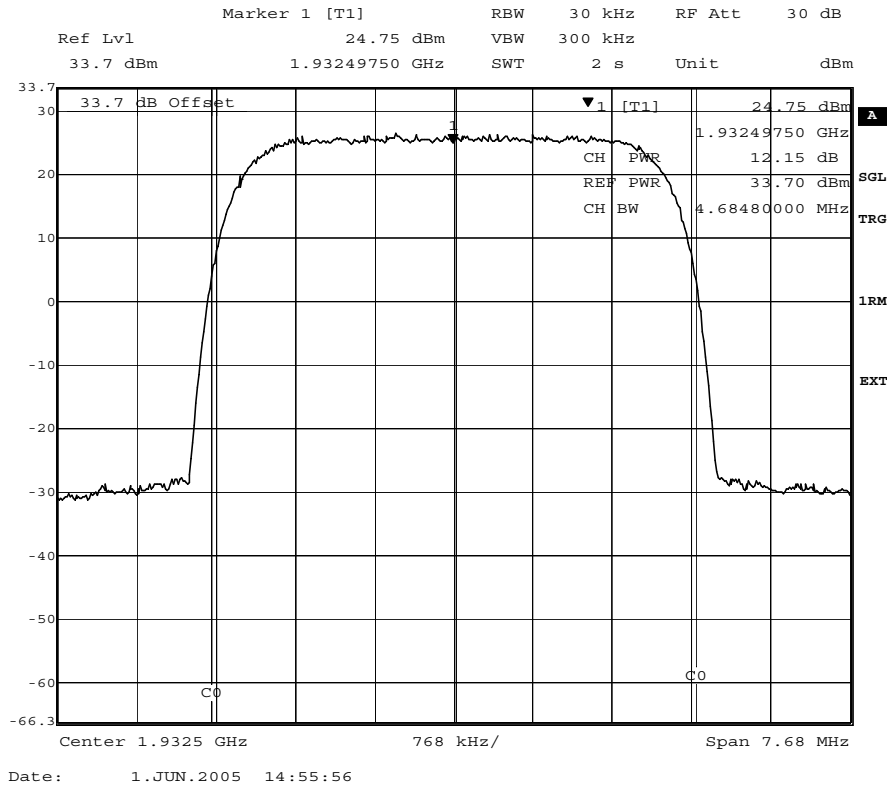

Fig. 4 – Maximum Output Power at the Antenna Connector (1932.5 MHz)

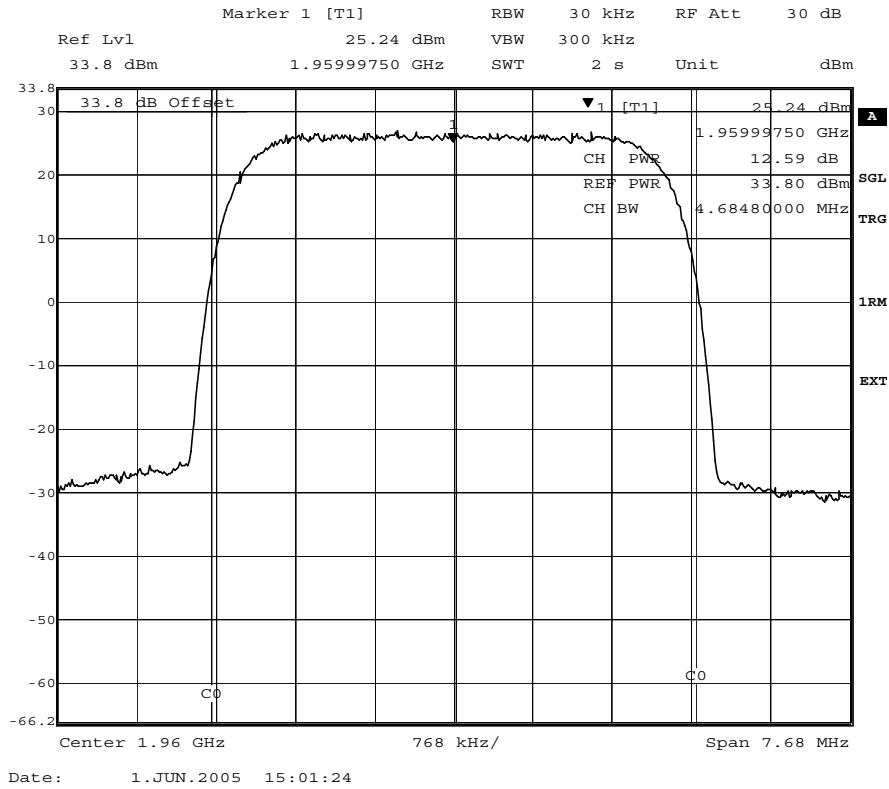

Fig. 5 – Maximum Output Power at the Antenna Connector (1960.0 MHz)

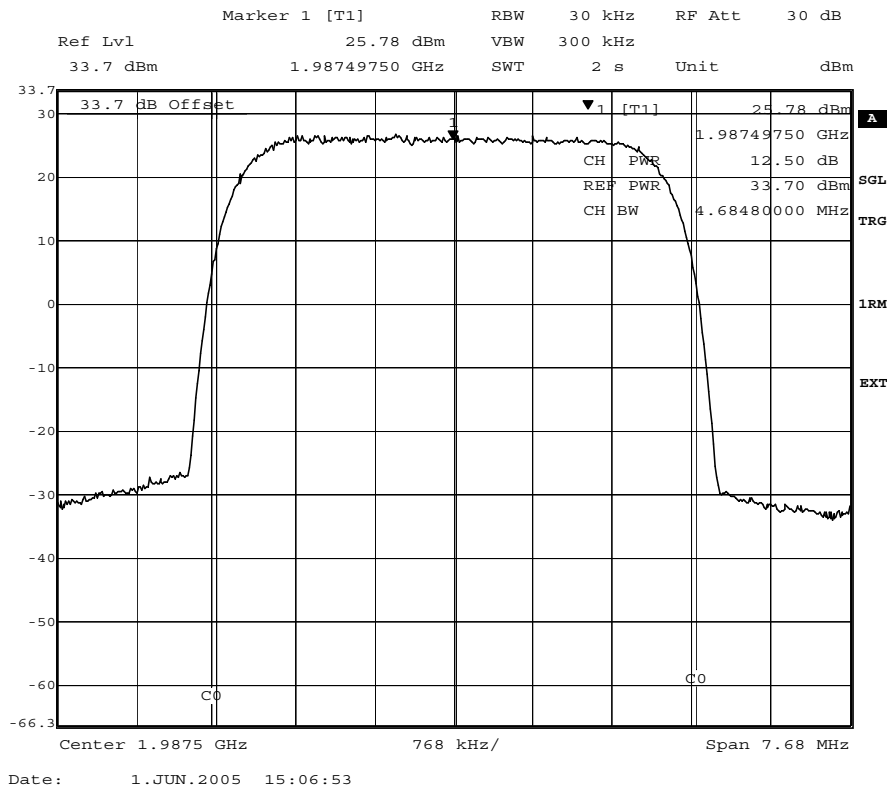

Fig. 6 – Maximum Output Power at the Antenna Connector (1987.5 MHz)

7.2.2 Test No. 2: Modulation Characteristics

No additional measurements are required for the modulation characteristics. Please refer to test no. 3, occupied bandwidth on pages 26 - 27.

7.2.3 Test No. 3: Occupied Bandwidth

The value "OPB" is the measured occupied bandwidth.

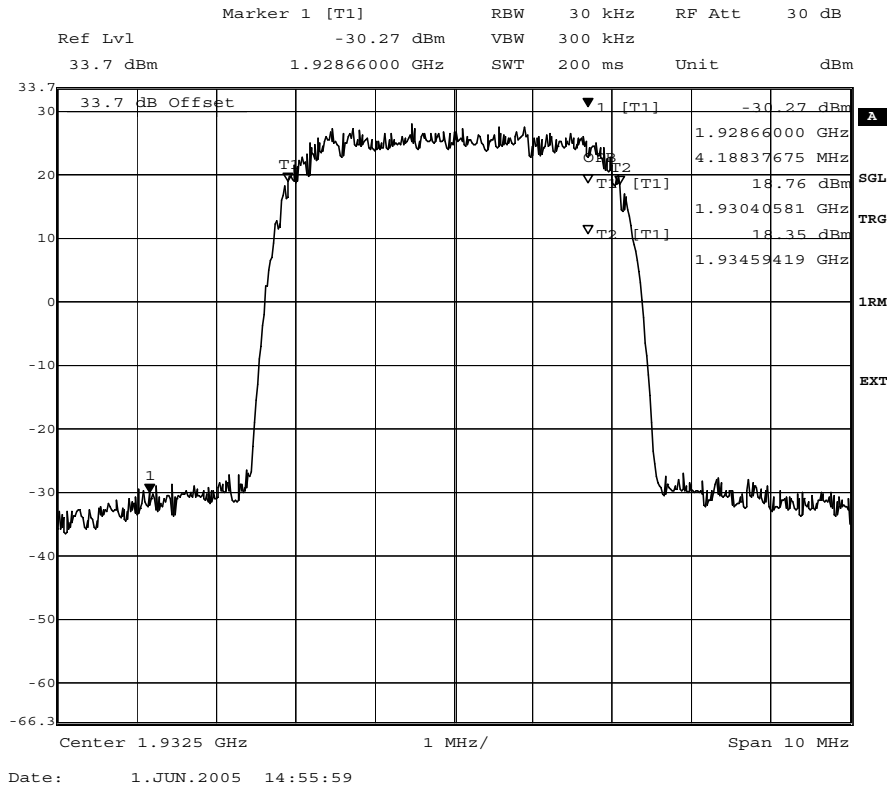

Fig. 7 – Occupied Bandwidth (1932.5 MHz)

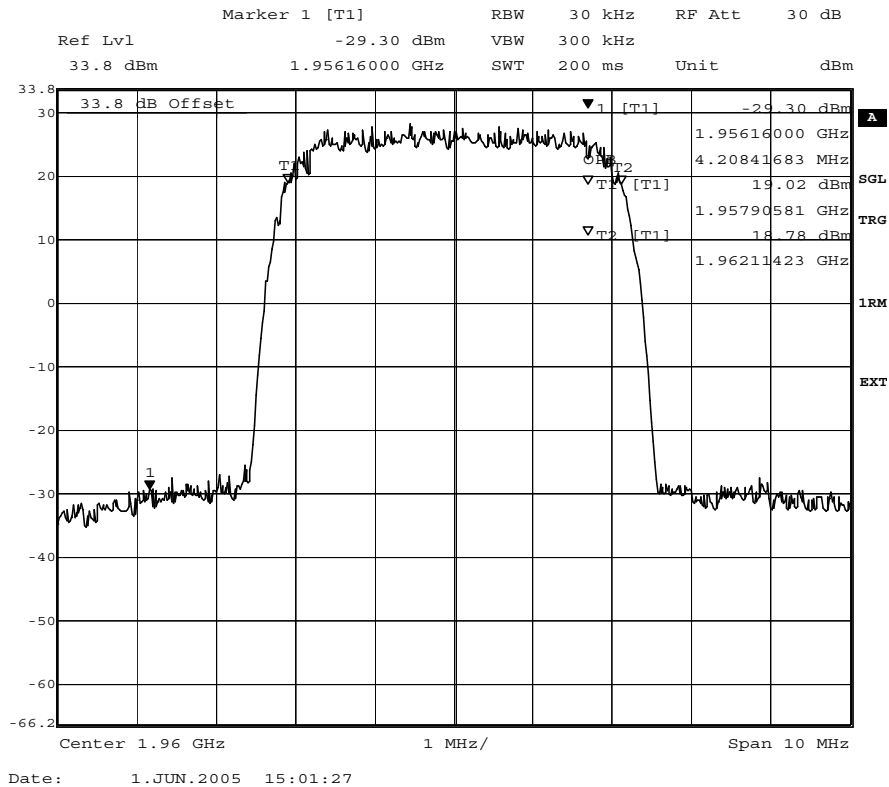

Fig. 8 – Occupied Bandwidth (1960.0 MHz)

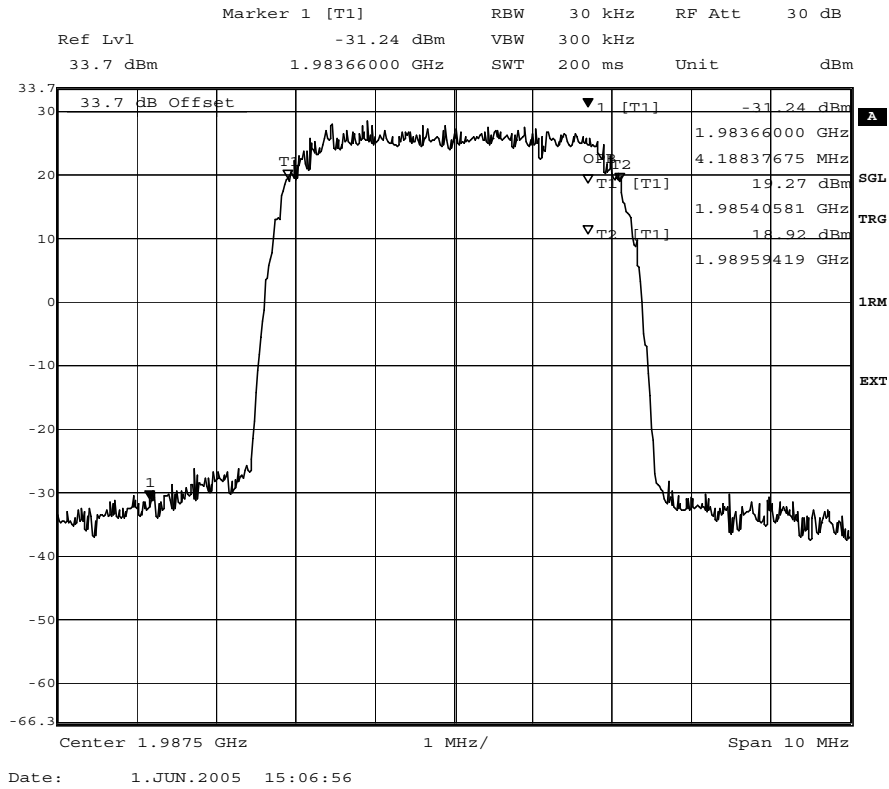
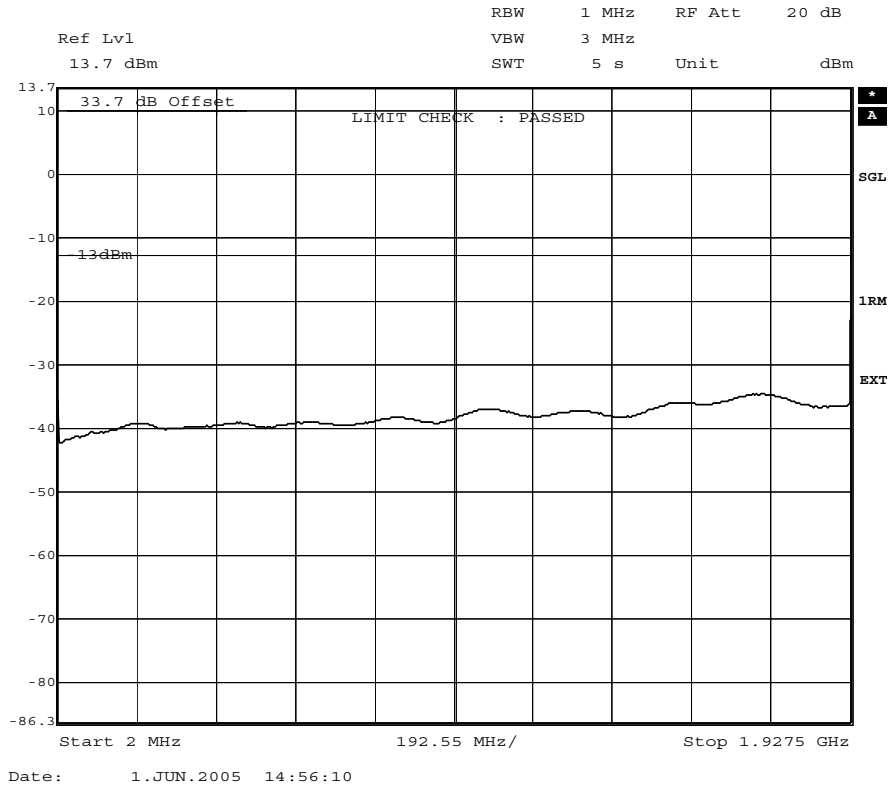

Fig. 9 – Occupied Bandwidth (1987.5 MHz)

7.2.4 Test No. 4: Spurious Emissions at the Antenna Terminals

The external attenuation (cable loss of the setup) can be seen as the “Offset” value in the screenshots. The external attenuation is frequency dependant. Thus the various “Offset” values in the screenshots may differ.



**Fig. 10 – Spurious Emissions 2.0 – 1927.5 MHz
(Carrier Frequency 1932.5 MHz)**

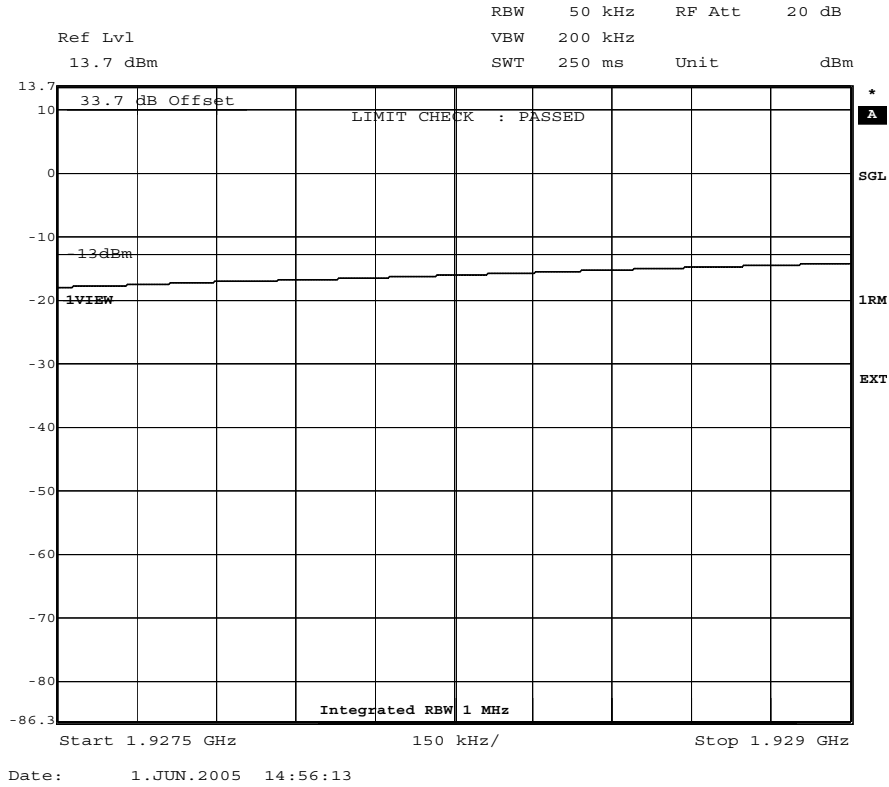

**Fig. 11 – Spurious Emissions 1927.5 – 1929.0 MHz
 (Carrier Frequency 1932.5 MHz)**

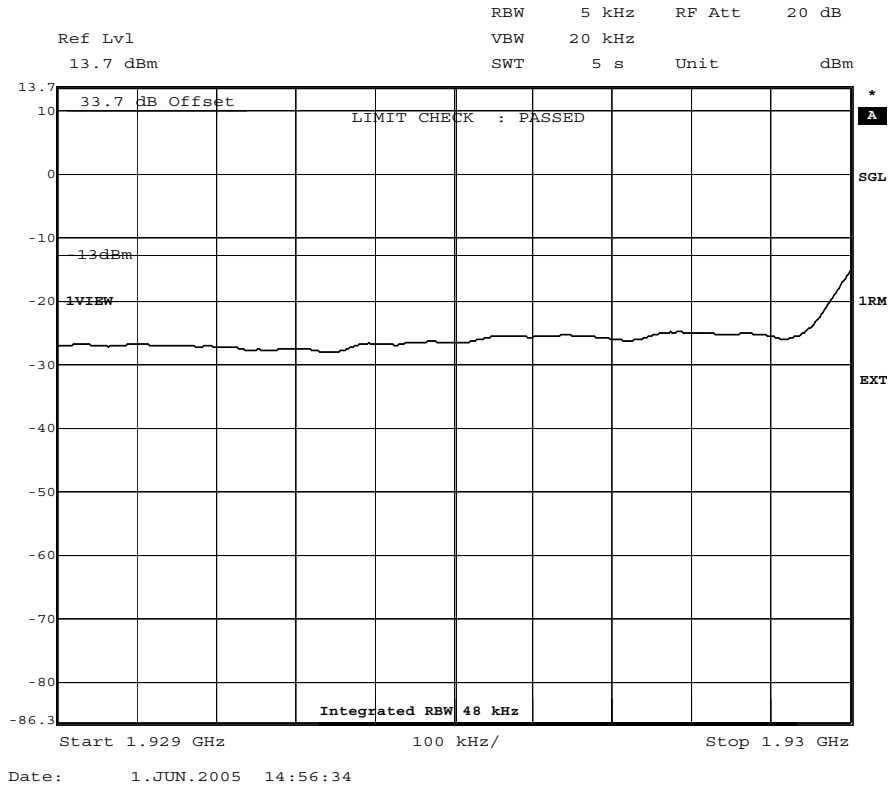

**Fig. 12 – Spurious Emissions 1929.0 – 1930.0 MHz
 (Carrier Frequency 1932.5 MHz)**

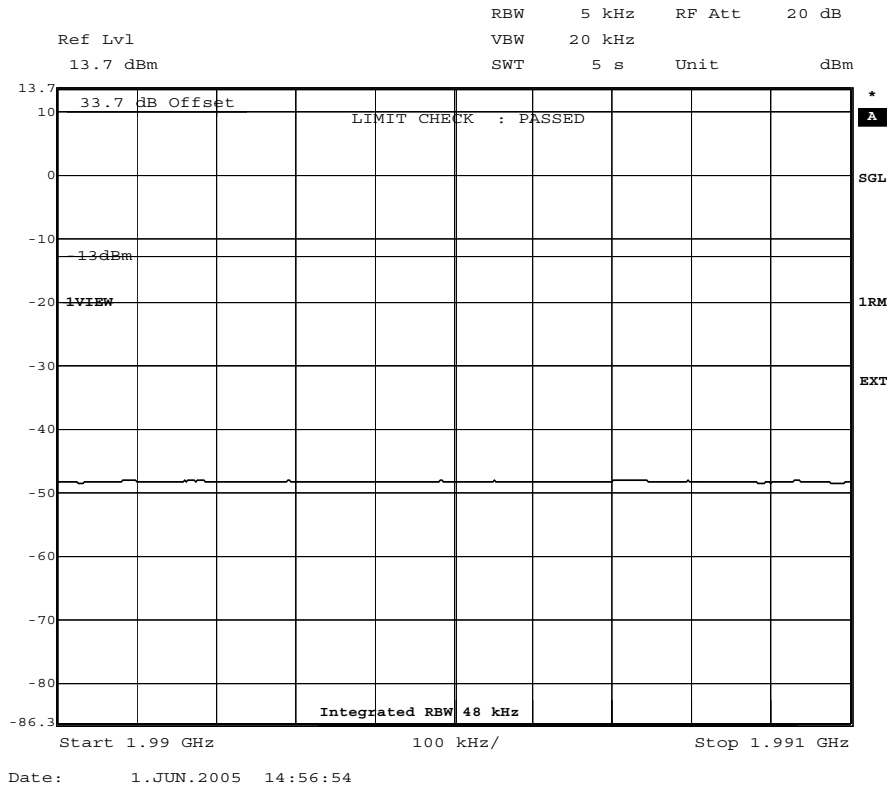

**Fig. 13 – Spurious Emissions 1990.0 – 1991.0 MHz
 (Carrier Frequency 1932.5 MHz)**

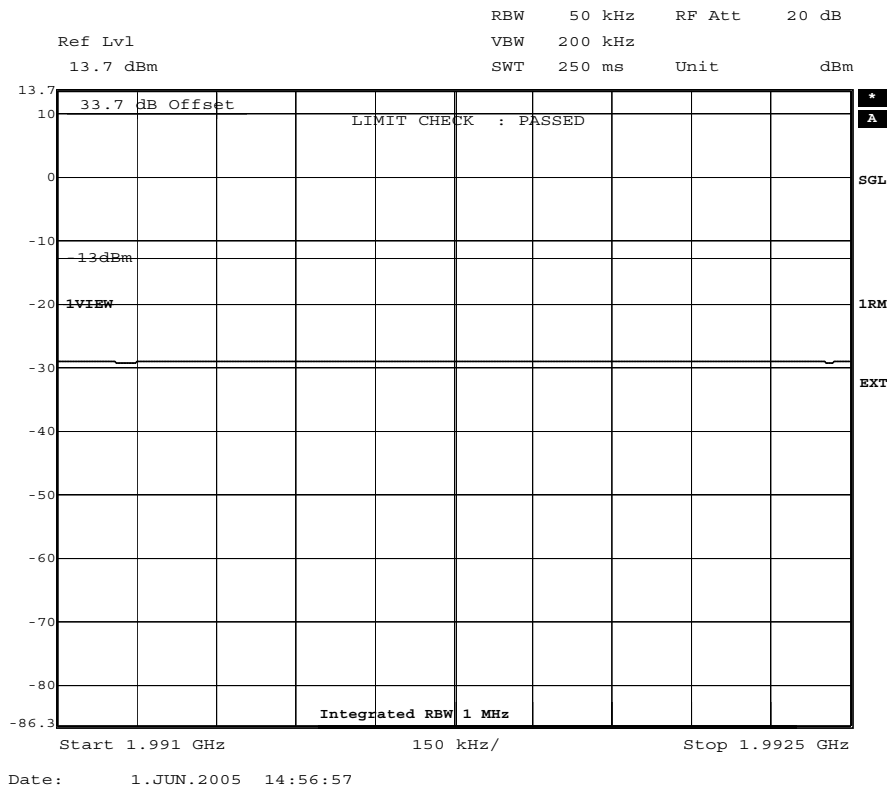

**Fig. 14 – Spurious Emissions 1991.0 – 1992.5 MHz
 (Carrier Frequency 1932.5 MHz)**

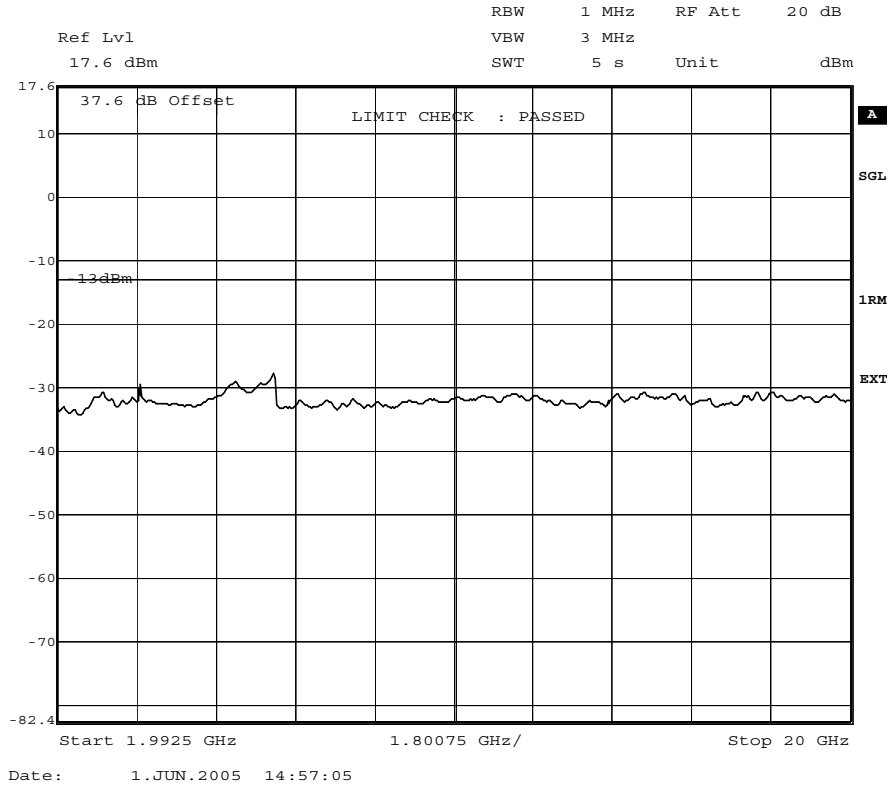

**Fig. 15 – Spurious Emissions 1992.5 – 20000.0 MHz
(Carrier Frequency 1932.5 MHz)**

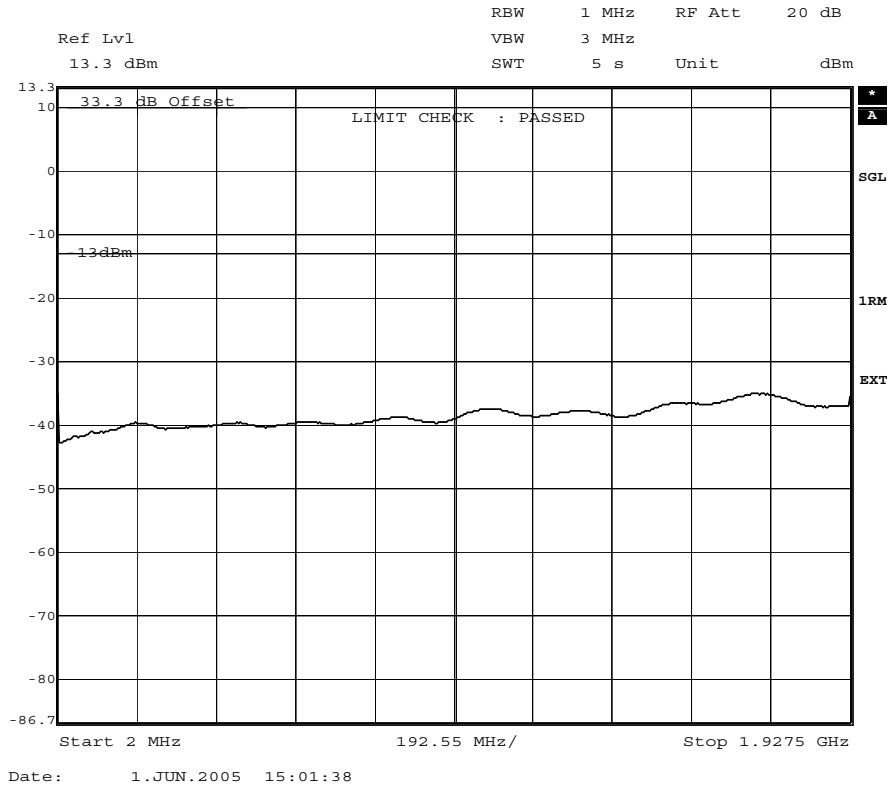

**Fig. 16 – Spurious Emissions 2.0 – 1927.5 MHz
(Carrier Frequency 1960.0 MHz)**

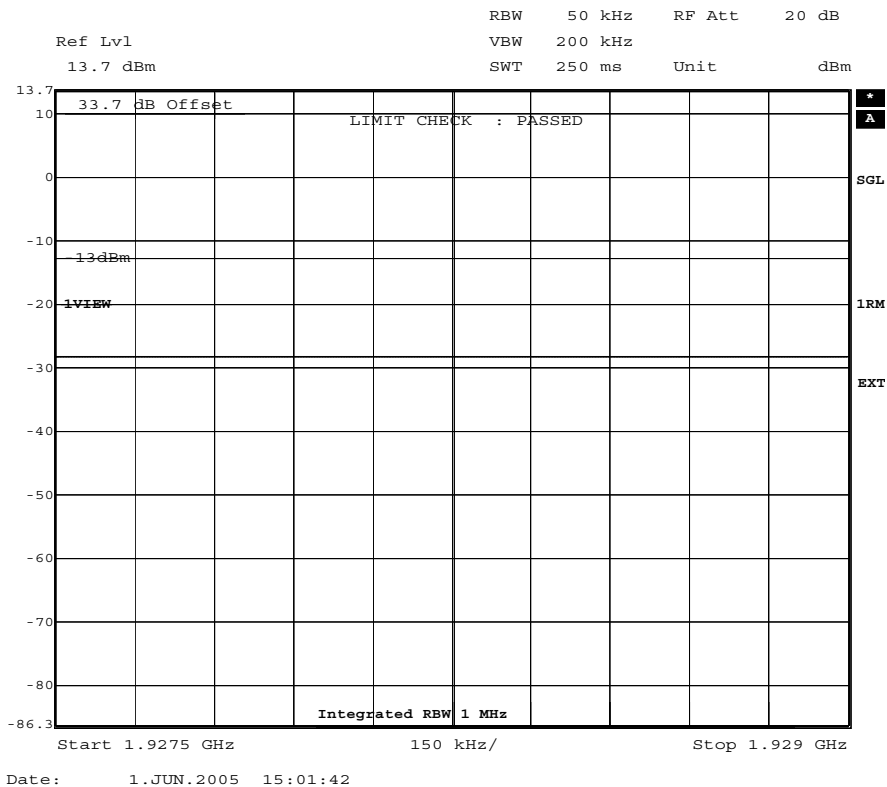

**Fig. 17 – Spurious Emissions 1927.5 – 1929.0 MHz
 (Carrier Frequency 1960.0 MHz)**

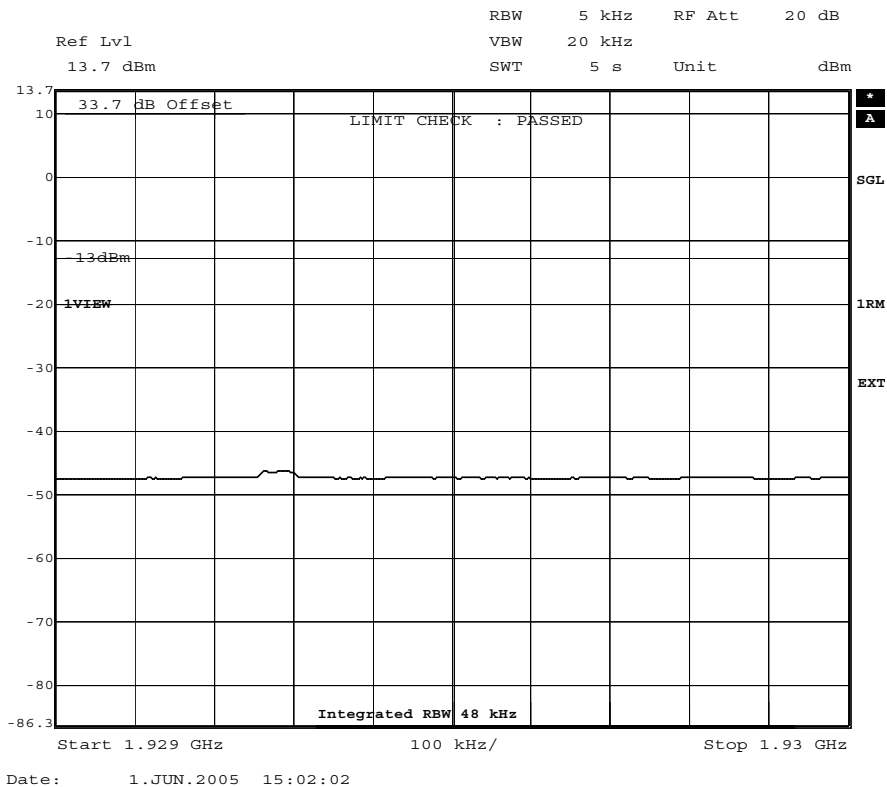

**Fig. 18 – Spurious Emissions 1929.0 – 1930.0 MHz
 (Carrier Frequency 1960.0 MHz)**

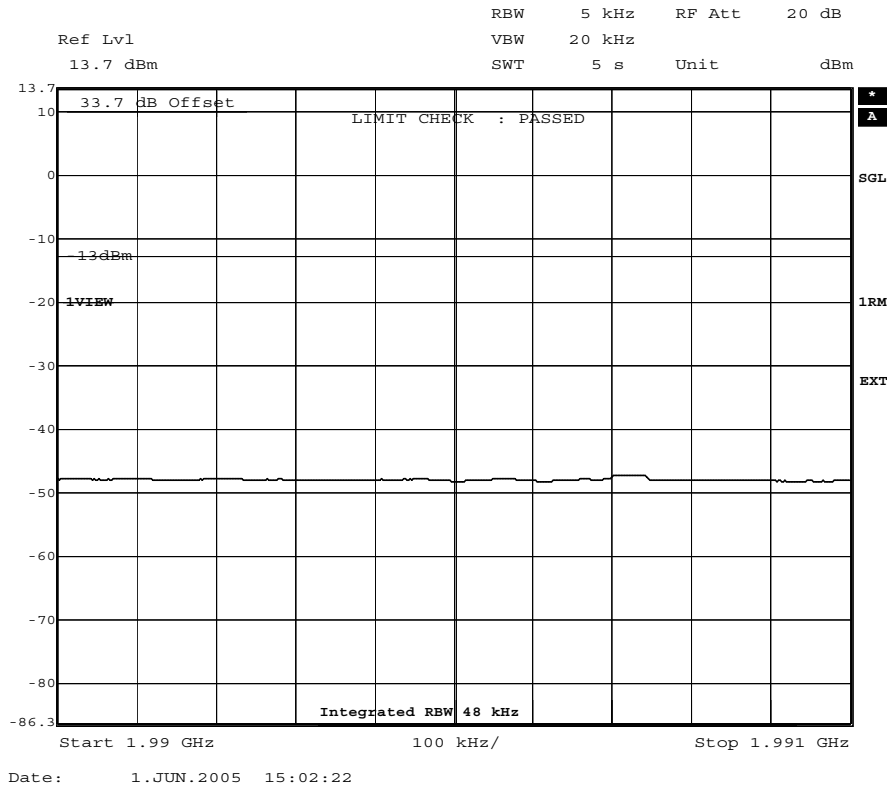

**Fig. 19 – Spurious Emissions 1990.0 – 1991.0 MHz
 (Carrier Frequency 1960.0 MHz)**

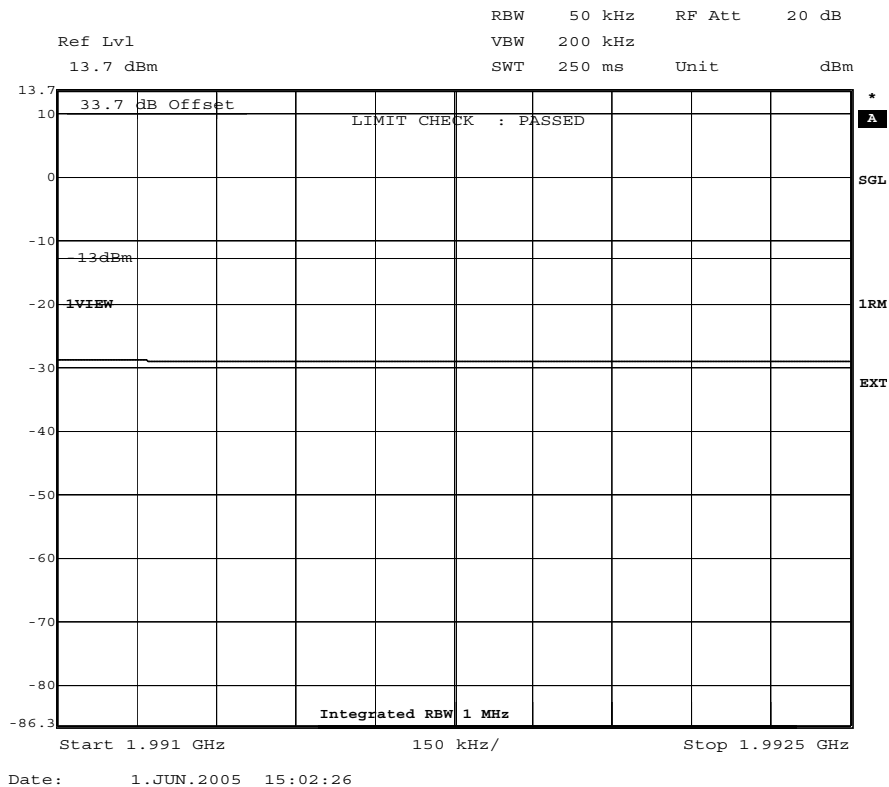

**Fig. 20 – Spurious Emissions 1991.0 – 1992.5 MHz
 (Carrier Frequency 1960.0 MHz)**

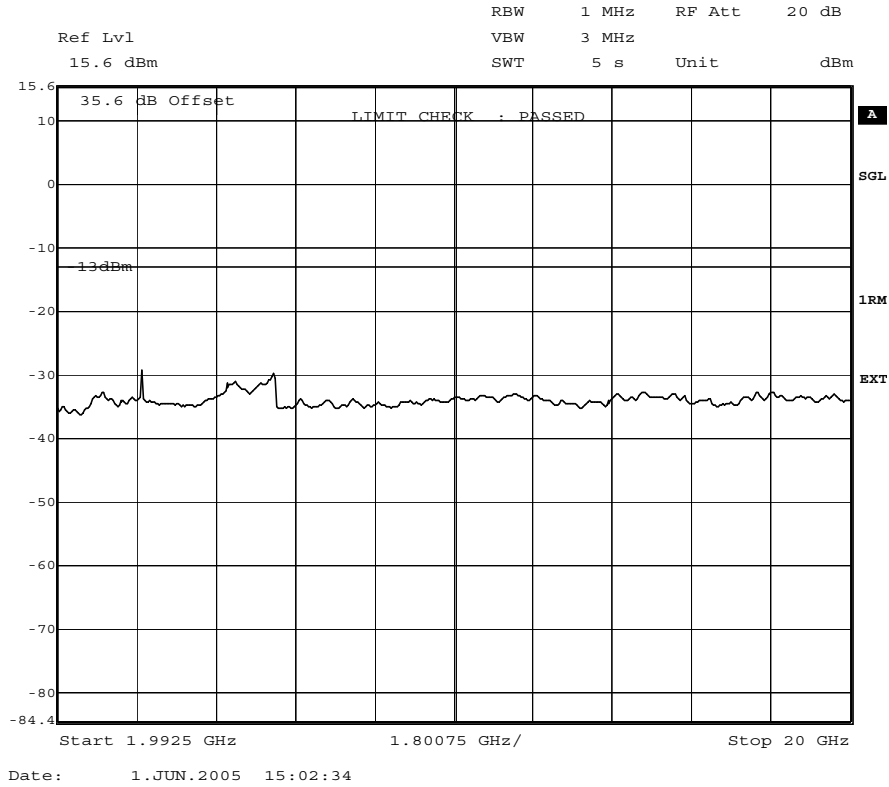

**Fig. 21 – Spurious Emissions 1992.5 – 20000.0 MHz
(Carrier Frequency 1960.0 MHz)**

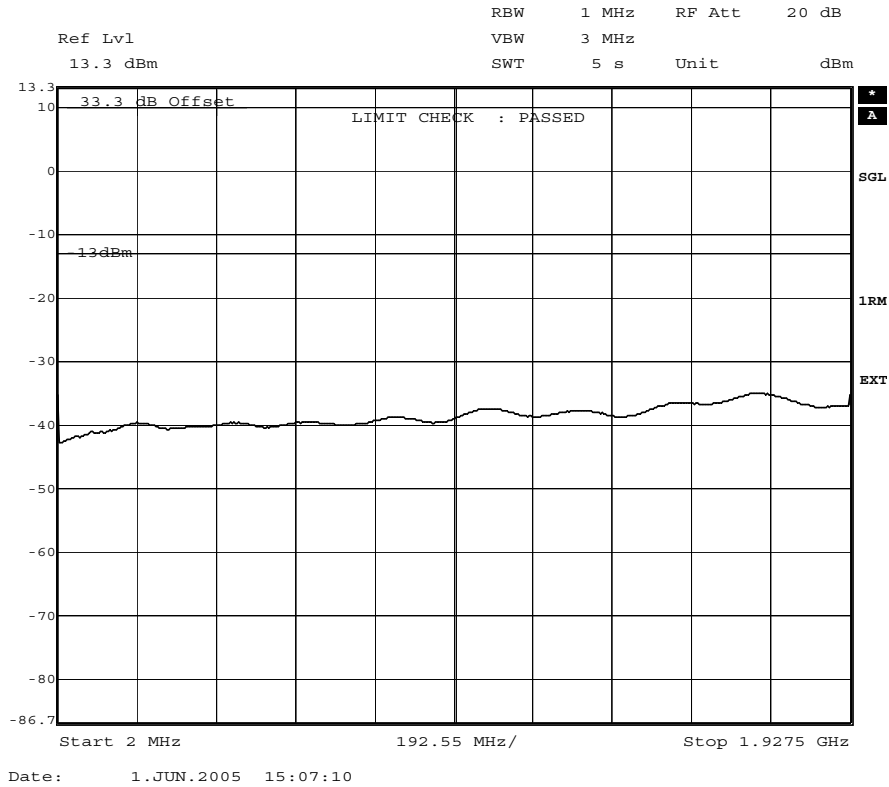

**Fig. 22 – Spurious Emissions 2.0 – 1927.5 MHz
(Carrier Frequency 1987.5 MHz)**

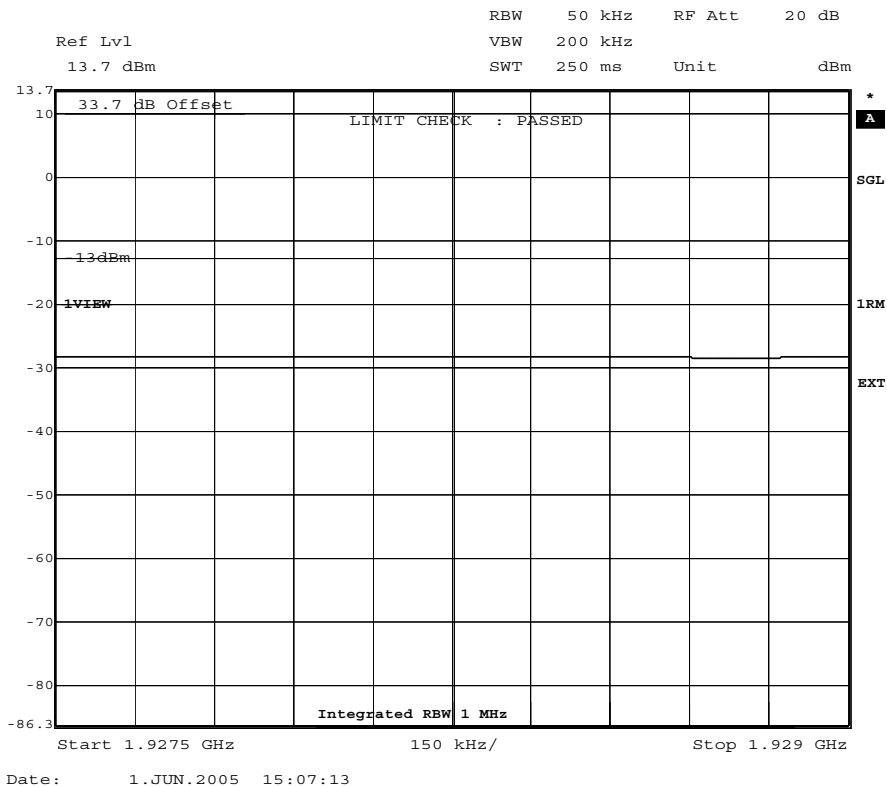

**Fig. 23 – Spurious Emissions 1927.5 – 1929.0 MHz
 (Carrier Frequency 1987.5 MHz)**

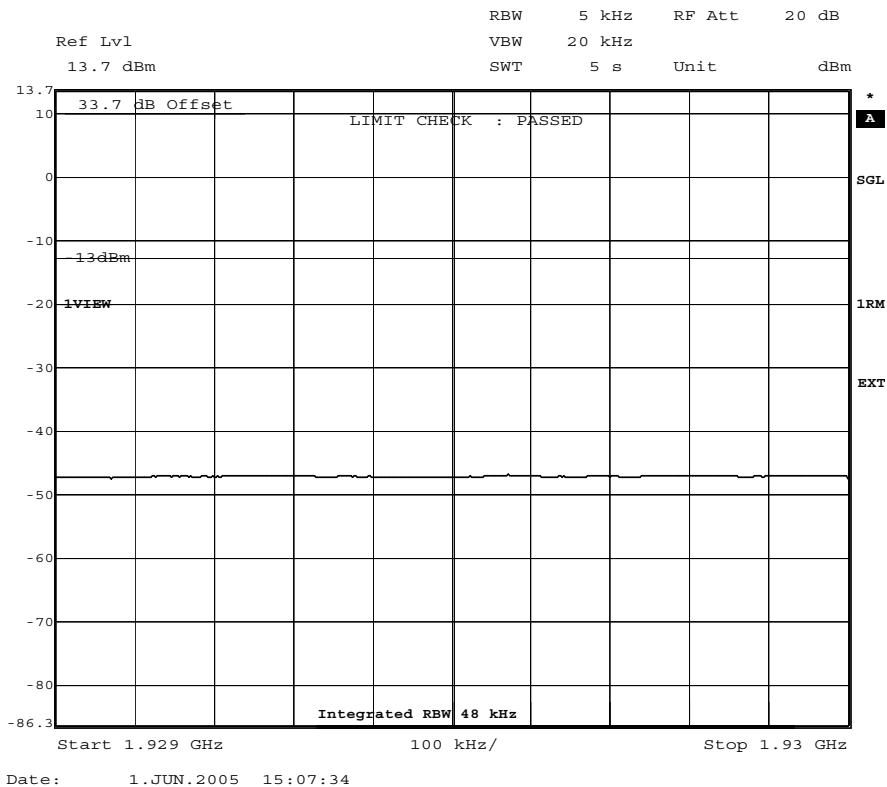

**Fig. 24 – Spurious Emissions 1929.0 – 1930.0 MHz
 (Carrier Frequency 1987.5 MHz)**

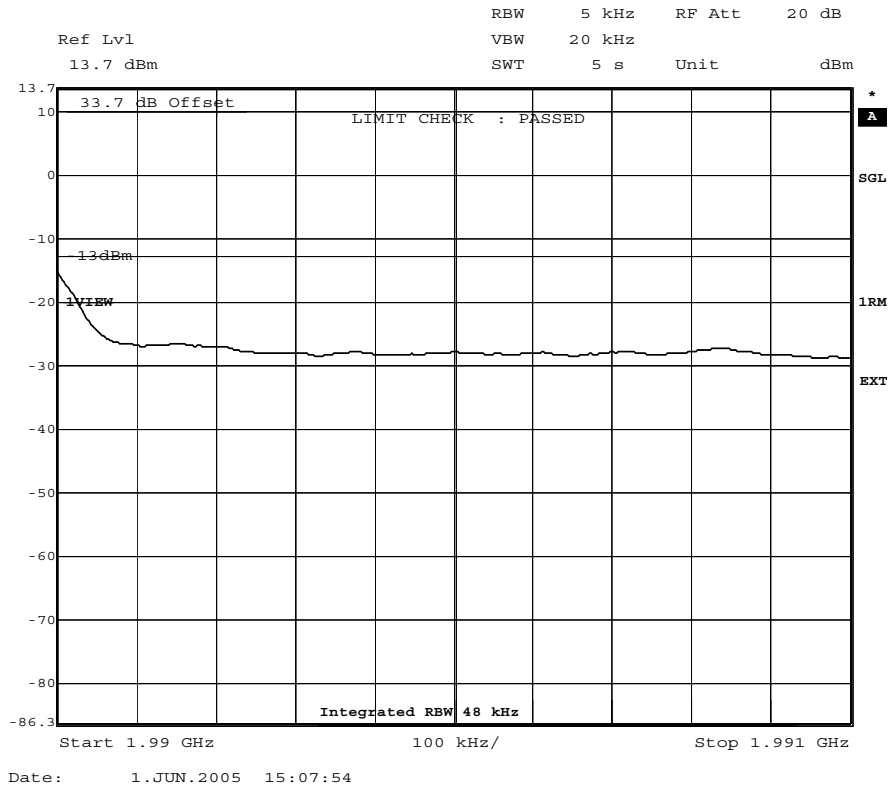

**Fig. 25 – Spurious Emissions 1990.0 – 1991.0 MHz
 (Carrier Frequency 1987.5 MHz)**

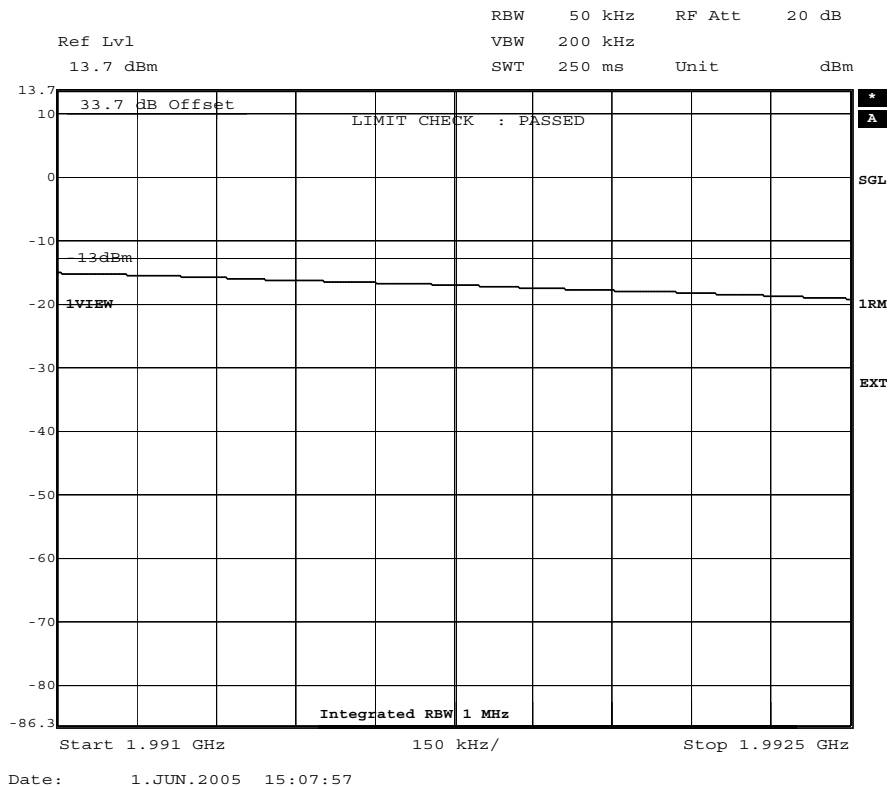

**Fig. 26 – Spurious Emissions 1991.0 – 1992.5 MHz
 (Carrier Frequency 1987.5 MHz)**

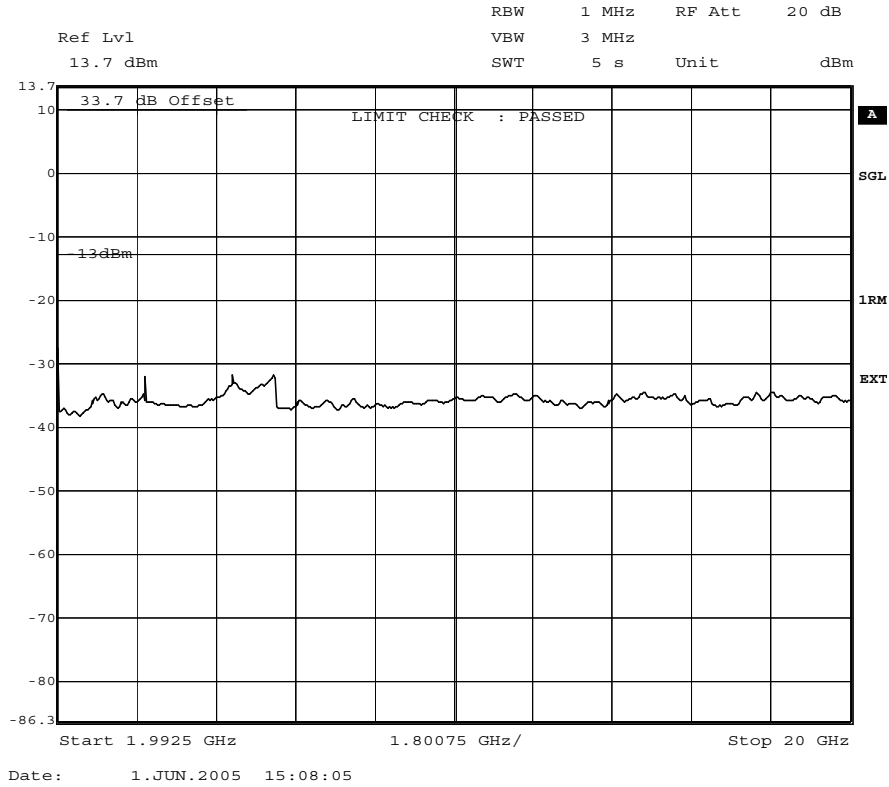

**Fig. 27 – Spurious Emissions 1992.5 – 20000.0 MHz
(Carrier Frequency 1987.5 MHz)**

7.2.5 Test No. 5: Field Strength of Spurious Radiation

Fig. 28 – Photograph of the anechoic chamber with the EUT



Fig. 29 – Photograph of the anechoic chamber with the test configuration for substitution method

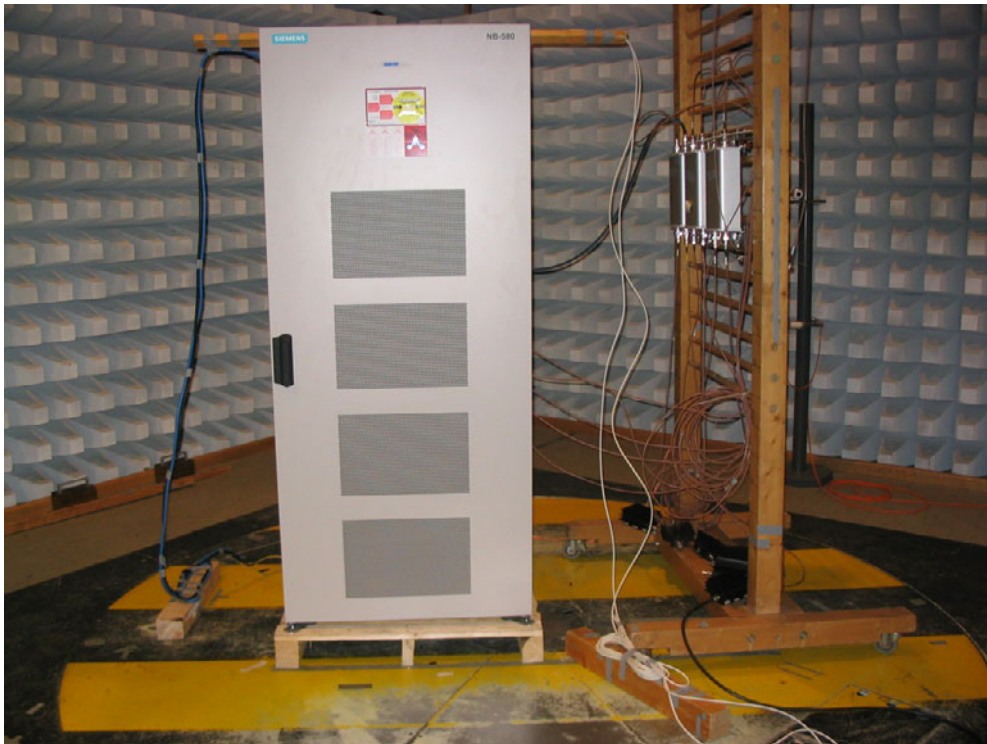
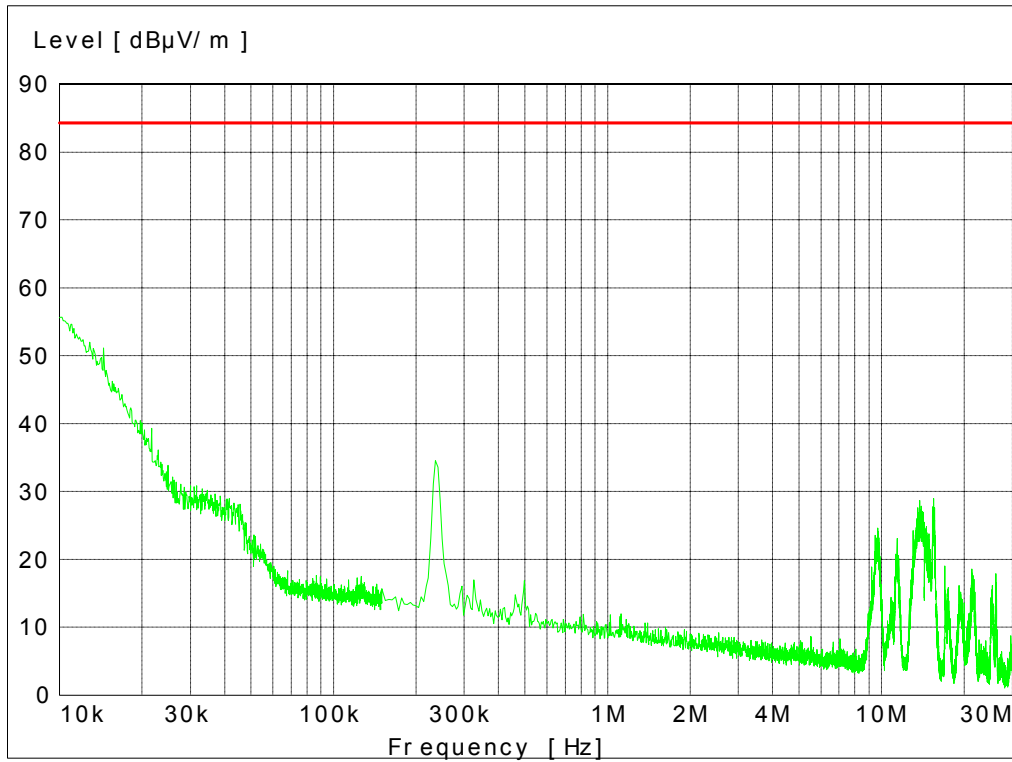

Fig. 30 – Radiated Emission 10 kHz – 30 MHz

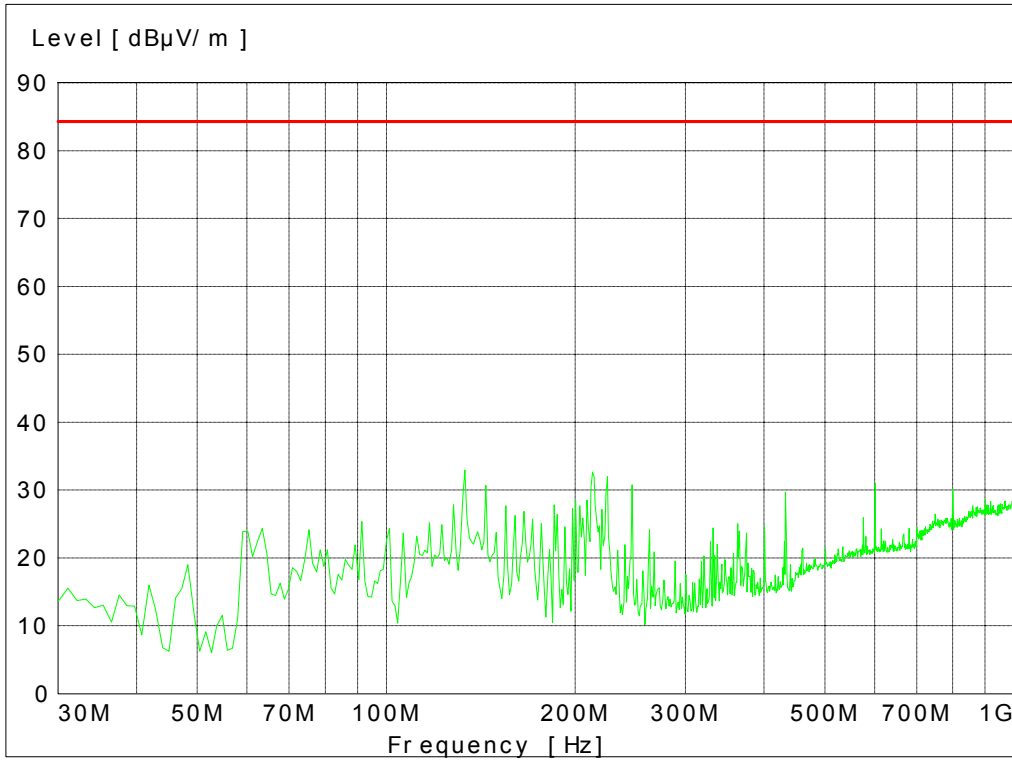

Fig. 31 – Radiated Emission 30 MHz – 1 GHz

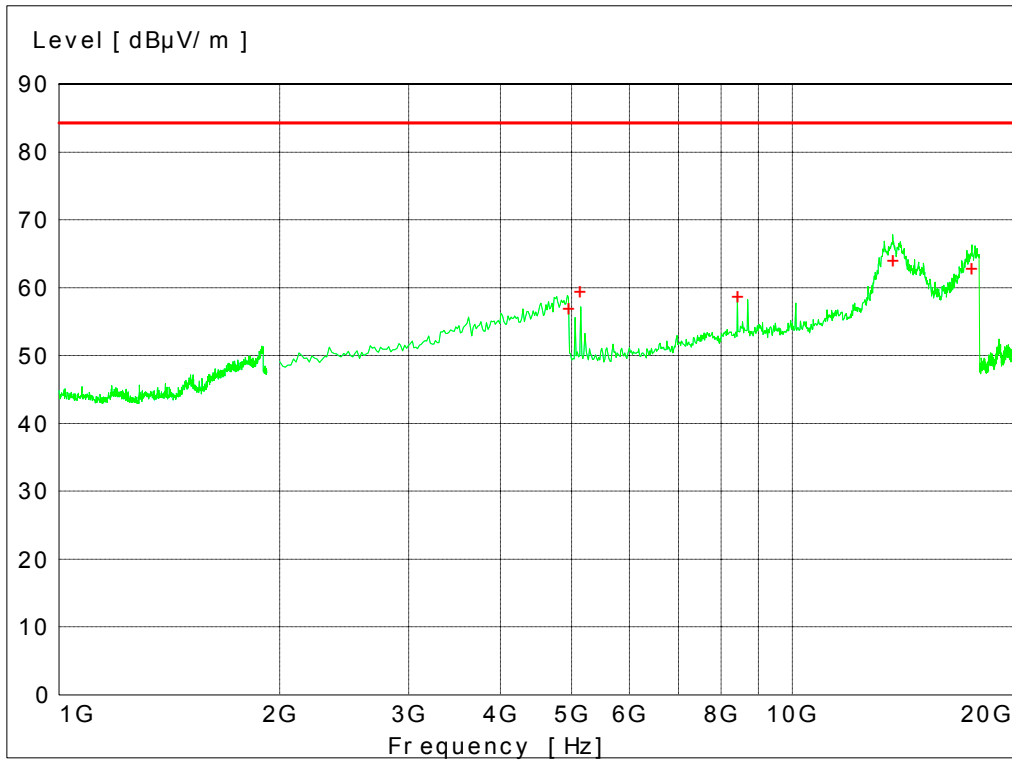

Fig. 32 – Radiated Emission 1 GHz – 20 GHz

Note: The frequencies shown on the plot were used for the spurious emission measurements using the "dipole substitution method".

7.2.6 Test No. 6: Frequency Stability

The following tables give the full test data for the frequency stability measurements.

Table 7.1: Results – Frequency Stability (Normal Supply Voltage)

Ambient Temp. [°C]	Frequency Deviation @ 1932.5 MHz [ppm]	Frequency Deviation @ 1987.5 MHz [ppm]	Manufacturer's Specification [ppm]	Result
-5	-0.016	0.019	0.05	compliant
0	-0.018	-0.024	0.05	compliant
+10	-0.029	0.023	0.05	compliant
+20	0.023	0.023	0.05	compliant
+30	0.017	-0.019	0.05	compliant
+40	0.024	0.026	0.05	compliant
+50	0.020	-0.024	0.05	compliant

Table 7.2: Results – Frequency Stability (Voltage Variation at Room Temperature)

Tested Frequency [MHz]	Frequency Deviation @ -40 V [ppm]	Frequency Deviation @ -57 V [ppm]	Manufacturer's Specification [ppm]	Result
1932.5	0.020	-0.021	0.05	compliant
1987.5	0.019	0.025	0.05	compliant