

Test Plan and Test Results

BS-41U BTS Base Station

FCC ID: NE3PCS009

Name of Applicant

*Siemens Information and Communication Mobile, Inc.
900 Broken Sound Parkway
Boca Raton, FL 33487*

Tester: Mrs. Maurer

Author: Mrs. Maurer

Approved: Dr.-Ing. Khelifi
Director QE 21

Signature:



Date: 5/22/2003

5/22/2003

5/22/2003

Phone: +49 89 722 53148

+49 89 722 53148

+49 89 722 34180

The Institute for Quality Engineering and Testing of the Information and Communication Networks Group of the Siemens AG
COMPONENTS TESTING ENVIRONMENTAL ENGINEERING ELECTROMAGNETIC COMPATIBILITY PRODUCT SAFETY
TELECOM CONFORMANCE TESTS

Address: Siemens AG, ICN TQM QE, Hofmannstr. 51, D-81359 München, Phone +49 89-722-41660, Fax +49 89-722-22648, Internet <http://www.pruefinstitut.de>

TABLE OF CONTENTS

1	EQUIPMENT UNDER TEST (EUT)	4
2	MEASUREMENTS	5
2.1	General description	5
2.2	Summary of the measurements	5
2.2.1	EUT configuration and operating conditions	5
2.2.2	Selected carrier test frequencies	6
2.2.3	Modulation characteristics	6
2.2.4	Measurement test configuration	7
2.2.5	Calibration of the measurement equipment	7
2.3	Test No. 1: RF power output (§ 2.1046)	8
2.3.1	Purpose	8
2.3.2	EUT operation condition	8
2.3.3	Test configuration	8
2.3.4	Measurement procedure	8
2.3.5	Measurement results	8
2.4	Test No. 2: Modulation characteristics (§ 2.1047, § 2.201)	9
2.5	Test No. 3: Occupied bandwidth (§ 2.1049)	10
2.5.1	Purpose	10
2.5.2	EUT operation condition	10
2.5.3	Test configuration	10
2.5.4	Measurement procedure and results	10
2.6	Test No. 4: Spurious emissions at antenna terminals (§ 2.1051, § 2.1057, § 24.238)	11
2.6.1	Purpose	11
2.6.2	Limits	11
2.6.3	EUT operation condition	11
2.6.4	Test configuration	11
2.6.5	Measurement procedure and results	11
2.7	Test No. 5: Field strength of spurious radiation (§ 2.1053, § 2.1057, § 24.238)	15
2.7.1	Purpose	15
2.7.2	Limits	15
2.7.3	EUT operation condition	15
2.7.4	Test configuration	15
2.7.5	Measurement procedure	16
2.7.6	Measurement results & limits	16
2.8	Test No. 6: Frequency stability (§ 2.1055, § 24.235)	18
2.8.1	Purpose	18
2.8.2	Limits	18
2.8.3	EUT operation condition	18
2.8.4	Test configuration	18
2.8.5	Measurement procedure	19
2.8.6	Measurement results	19
2.9	Test No. 7: Slow frequency hopping	20
2.9.1	Introduction	20
2.9.2	Purpose	20
2.9.3	EUT operation condition	20
2.9.4	Test configuration	20

2.9.5	Measurement procedure	20
2.9.6	Measurement results	21
3	MEASUREMENT DATA AND SPECTRAL PLOTS	22
3.1	Part list of the RF measurement test equipment	22
3.2	Part list of the climate measurement test equipment	22
3.3	Part list of the EMC measurement test equipment	23
3.4	Spectral plots	24

1 Equipment under test (EUT)

The equipment under test (EUT) comprises the modules listed in the table below.

Module Name	Siemens Part No.	Serial No.
DUAMCO2HPPV2	S30861-U2364-X-01/01	FMM/P5004055
DUAMCO2HPPV2	S30861-U2364-X-01/01	FMM/P5004035
ECUPHPV3	S30861-U2372-X-D1/01	RX+/PD244221
ECUPHPV3	S30861-U2372-X-D1/01	RX+/PD244219
DUAMCO2PV4	S30861-U2105-X-02/01	FMM/M5001858
ECUPV2	S30861-U2301-X-K1/01	RX+/P2249639
ECUPV2	S30861-U2301-X-K1/01	RX+/P2249642
ECUPV2	S30861-U2301-X-Z1/01	RX+/P2249640

If not stated otherwise, all tests were executed with ECUPHPV3 as the worst case test condition concerning the maximum transmit power.

For a functional description of the modules, please refer to the appropriate related parts and exhibit sections of this certification application.

The tests were conducted with the modules installed in a BS-41U. Worst-case measurement data is reported.

The tested system was equipped as per Fig. 1 on page 7 with its maximum number of 4 transceivers. Although only one transceiver (EUT) was tested for compliance, the other transceivers were investigated to ensure that the worst case test condition/transceiver was measured.

To comply with the FCC rules (§2.1051, §24.238), the maximum transmit power of channel numbers 512 (1930.2 MHz) and 810 (1989.8 MHz) has to be decreased according to the following table.

Type of ECU	Carrier Frequency [MHz]	Channel No.	Maximum RF power output GMSK	Maximum RF power output 8PSK
ECUPV2	1930.2 MHz	512	42.1 dBm = 16.2 W	44.7dBm = 29.5 W
ECUPV2	1989.8 MHz	810	44.4 dBm = 27.5 W	47.1 dBm = 51.3 W
ECUPHPV3	1930.2 MHz	512	39.6 dBm = 9.1 W	42.7 dBm = 18.6 W
ECUPHPV3	1989.8 MHz	810	41.8 dBm = 15.1 W	44.9 dBm = 30.9 W

A complete description of the transceiver's calibration/tuning procedure is included in the Parts List and TuneUp exhibit section of this application.

2 Measurements

2.1 General description

2.2 Summary of the measurements

The measurements described in the following sections were conducted pursuant to 47 CFR § 2.947. All applicable paragraphs of the 47 CFR parts 2 and 24 of the most current version of the rules were considered.

The measurements were performed at Siemens AG, Institute for Quality Engineering and Testing, Hofmannstr. 50, 81359 Munich, Germany.

The following tests were performed according to the FCC rules in order to verify the compliance of the EUT with the FCC requirements:

Test No.	Measurement	FCC Rule	Page Number of this Report	Results
1	RF power output	§ 2.1046	8	compliant
2	Modulation characteristics	§ 2.1047, § 2.201	9	compliant
3	Occupied bandwidth	§ 2.1049	10	compliant
4	Spurious emissions at antenna terminals	§ 2.1051, § 2.1057, § 24.238	11	compliant
5	Field strength of spurious radiation	§ 2.1053, § 2.1057, § 24.238	15	compliant
6	Frequency stability	§ 2.1055, § 24.235	18	compliant
7	Slow frequency hopping	N/A	20	compliant

In accordance with the FCC Rule §15.3 (z) the equipment was tested with the limits that are valid for an *unintentional radiator*.

2.2.1 EUT configuration and operating conditions

If not stated otherwise, the following standard setup procedure for the EUT under test was used:

A Protocol Tester K1297 is used to control the EUT. The K1297 is connected to the EUT via the A_{bis} Link. For detailed test system equipment configuration please refer to Fig. 1 on page 7.

The transmitter modules were tuned up according to the procedure described in the TuneUp exhibit section of this application.

During the measurements, one carrier channel was tested at a time. The carrier was set to the maximum power level with all timeslots activated to ensure the maximum emission amplitudes during all measurements.

A pseudo random bit pattern was applied to the digital modulator. This ensures that the measurements of the emission characteristics of the transmitter are pursuant to § 2.1049.

2.2.2 Selected carrier test frequencies

The measurements were performed at 3 selected carrier test frequencies, according to the following table:

Carrier Test Frequency [MHz]	Remark
1930.2	lowest possible carrier frequency
1960.0	frequency at the middle of the band
1989.8	highest possible carrier frequency

2.2.3 Modulation characteristics

The EUT supports two types of modulation: GMSK and 8PSK. The modulation characteristic of the GMSK and the 8PSK modulation is defined in standard 3GPP TS 05.04.

During all measurements described below, a pseudo random sequence was applied to the digital modulator to ensure that the emission characteristics of the transmitter are pursuant to § 2.1049.

2.2.4 Measurement test configuration

If not stated otherwise, the following measurement configuration was used to perform all measurements (see figure below):

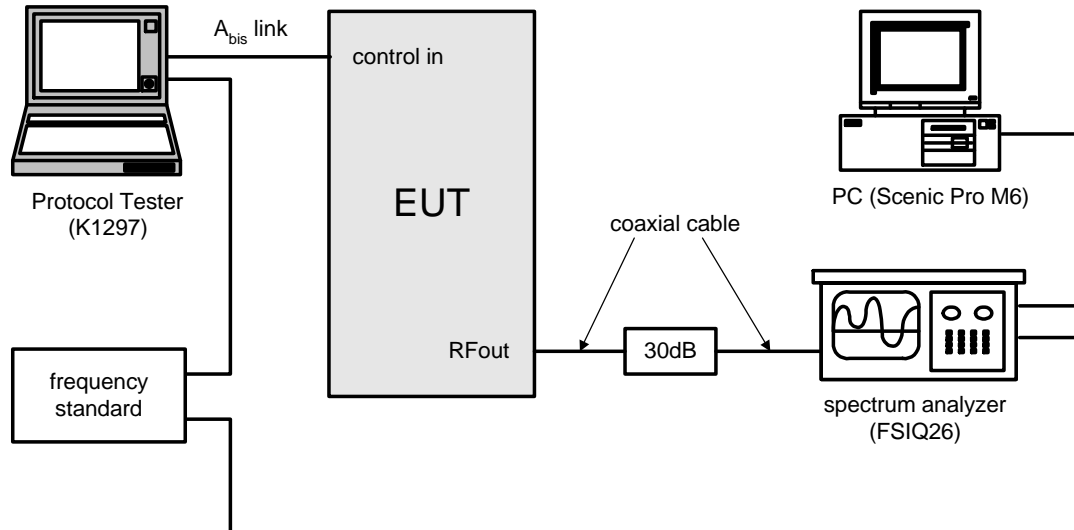

Fig. 1 – Measurement Test Configuration

The EUT is controlled by a protocol tester Tektronix K1297 via the serial Abis Link. The RF output signal is injected into a spectrum analyzer Rohde&Schwarz FSIQ26 via a high power 30 dB attenuator. The attenuator is used to protect the input of the spectrum analyzer from high RF power levels. A description of the analyzer settings is given in each of the sections describing the measurements. A complete list of the measurement equipment is included on page 22 of this measurement report.

2.2.5 Calibration of the measurement equipment

The spectrum analyzer has a built-in self-calibration procedure. This calibration procedure was activated prior to the measurements so that the analyzer is deemed accurate. The attenuation of the attenuator is within the manufacturer's specified limits. High quality cables were used to connect the measurement equipment to the EUT. The maximum loss of the cable is within the manufacturer's limits.

2.3 Test No. 1: RF power output (§ 2.1046)

2.3.1 Purpose

The RF power output measurements were performed pursuant to § 2.1046 in order to determine the peak rated RF output power of the EUT.

2.3.2 EUT operation condition

The standard setup procedure as described in section 2.2.1 of this report was used. The maximum transmit power of channel number 512 (1930.2 MHz) and 810 (1989.8 MHz) was set according to section 1.

2.3.3 Test configuration

The test configuration used is described in the block diagram in section 2.2.4. See page 7 for a block diagram (Fig. 1).

2.3.4 Measurement procedure

The RBW setting of the spectrum analyzer was increased until the measured power reached a stable upper limit (RBW = 1MHz).

2.3.5 Measurement results

The following table shows the measured output powers at the RF output terminal. Spectral plots are included on pages 24 – 33 of this report.

Note:

The offset value indicated on the spectral plots represents the external attenuation value that includes the fixed attenuator plus the cable loss.

GMSK modulation

Carrier Test Frequency [MHz]	Indicated Power Level [dBm]	External Attenuation [dB]	RF Power	Results
1930.2	6.4	34.7	41.1 dBm = 12.9 W	compliant
1930.4	12.2	34.7	46.9 dBm = 49.0 W	compliant
1960.0	12.8	34.7	47.5 dBm = 56.2 W	compliant
1989.6	12.3	34.7	47.0 dBm = 50.1 W	compliant
1989.8	8.7	34.7	43.4 dBm = 21.9 W	compliant

8PSK modulation

Carrier Test Frequency [MHz]	Indicated Power Level [dBm]	External Attenuation [dB]	RF Power	Results
1930.2	9.0	34.7	43.7 dBm = 23.4 W	compliant
1930.4	11.7	34.7	46.4 dBm = 43.7 W	compliant
1960.0	12.5	34.7	47.2 dBm = 52.5 W	compliant
1989.6	12.2	34.7	46.9 dBm = 49.0 W	compliant
1989.8	11.4	34.7	46.1 dBm = 40.7 W	compliant

The measured power levels were found to be compliant with the manufacturer's specifications and with all requirements of the FCC rules.

2.4 Test No. 2: Modulation characteristics (§ 2.1047, § 2.201)

The occupied bandwidth was measured to be 252.5 kHz, which represents the 99% power bandwidth (refer to the spectral plots included on pages 35 – 44 and the following section). Three carrier test frequencies were investigated. Therefore, the modulation characteristic of the base stations transceiver is 253KGXW. No further testing measurements are required under this section of the rules.

No measurements are required here other than the occupied bandwidth.

The modulation characteristics were found to be compliant with the manufacturer's specifications and with all requirements of the FCC rules.

2.5 Test No. 3: Occupied bandwidth (§ 2.1049)

2.5.1 Purpose

The measurements are performed to determine the occupied bandwidth of the EUT pursuant to § 2.1049.

2.5.2 EUT operation condition

The EUT was set up according to section 2.2.1 of this test report. A pseudo random bit pattern was applied to the modulator. First the test transceiver was modulated using GMSK modulation. Afterwards the measurements were repeated with 8PSK modulation. For a specific modulation technique description, please see section XII of the “Certification Application Overview”, located in the cover letter section of this application. For circuit diagrams of the modulator, please refer to the Schematics exhibit section of this application. The maximum transmit power of channel number 512 (1930.2 MHz) and 810 (1989.8 MHz) was set according to section 1.

2.5.3 Test configuration

The test configuration used is described in the block diagram in section 2.2.4. See page 7 for a block diagram (Fig. 1).

2.5.4 Measurement procedure and results

The occupied bandwidth was determined for each of the test frequencies listed in the table below. See the spectral plots included on pages 35 – 44 for details. The 99% power bandwidth was determined with the spectrum analyzer. The following table summarizes the measurement results:

GMSK modulation:

Carrier Test Frequency [MHz]	Occupied Bandwidth [kHz]	Results
1930.2	248.5	compliant
1930.4	244.5	compliant
1960.0	248.5	compliant
1989.6	244.5	compliant
1989.8	248.5	compliant

8PSK modulation:

Carrier Test Frequency [MHz]	Occupied Bandwidth [kHz]	Results
1930.2	244.5	compliant
1930.4	244.5	compliant
1960.0	248.5	compliant
1989.6	244.5	compliant
1989.8	252.5	compliant

The occupied bandwidth was found to be compliant with the manufacturer’s specifications and with all requirements of the FCC rules.

2.6 Test No. 4: Spurious emissions at antenna terminals (§ 2.1051, § 2.1057, § 24.238)

2.6.1 Purpose

The measurements of the spurious emissions at the equipment output terminals were performed pursuant to § 2.1051 in order to verify that any emissions are below the limits given by § 24.238.

2.6.2 Limits

Compliance with § 24.238 requires that any emission be attenuated below the transmitter power by at least $43 + 10 \log_{10} P$ (P = transmitter power in Watts).

The compliance limit was calculated as per the following table:

GMSK modulation:

Maximum transmitter output power	70.79W (= 48.5 dBm)
Required attenuation	$43 + 10 \log_{10} 70.79 = 61.5$ dB
Maximum transmitter output power – required attenuation = compliance limit	48.5 dBm – 61.5 dB = –13 dBm

8PSK modulation:

Maximum transmitter output power	70.79W (= 48.5 dBm)
Required attenuation	$43 + 10 \log_{10} 70.79 = 61.5$ dB
Maximum transmitter output power – required attenuation = compliance limit	48.5 dBm – 61.5 dB = –13 dBm

2.6.3 EUT operation condition

The standard setup procedure as described in section 2.2.1 of this report was used. The maximum transmit power of channel number 512 (1930.2 MHz) and 810 (1989.8 MHz) was set according to section 1.

2.6.4 Test configuration

The test configuration used is described in the block diagram in section 2.2.4. See page 7 for a block diagram (Fig. 1).

2.6.5 Measurement procedure and results

In accordance with § 24.238, a 1 MHz resolution bandwidth was used for the measurements. However, in the 1 MHz frequency bands immediately outside and adjacent to the frequency block a resolution bandwidth of approximately one percent of the emission bandwidth of the fundamental emission of the transmitter was employed. The emission bandwidth is 249 kHz (refer to the spectral plot on page 68). Thus, the measurements were conducted using a 3 kHz resolution bandwidth and no video filtering.

Due to the imperfect resolution filter in the spectrum analyzer¹, the FCC allows continuing the use of the 3 kHz RBW in the 5 MHz frequency bands immediately outside and adjacent to the frequency block with an increased attenuation specification. This is depicted in the following diagram:

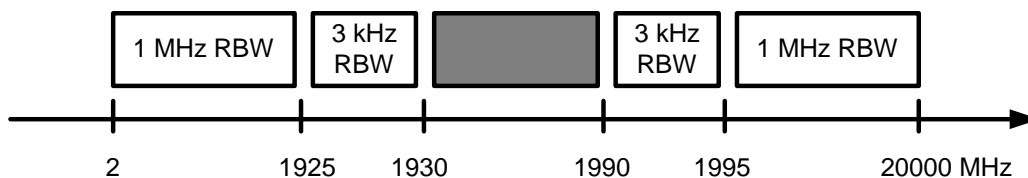

Pursuant to the FCC, the (effective) attenuation specification has to be increased by the same ratio of required RBW setting to actual RBW setting². In this case, use of 3 kHz beyond the original 1 MHz region would result in a 25.2 dB increase in the attenuation specification. As a result the compliance limit is $-13 \text{ dBm} - 25.2 \text{ dB} = -38.2 \text{ dBm}$ in the frequency ranges 1925-1929 MHz and 1991-1995 MHz.

According to § 2.1057, all emission including the fundamental frequency of the transceiver and all frequencies up to the 10th harmonic were investigated.

The measurements were performed at all 3 selected carrier test frequencies. Refer to section 2.2.2 of this test report.

The following table summarizes the worst case detected emission levels (refer to spectral plots included on pages 45 – 67 for details):

¹ A spectral plot showing the frequency response of the 1 MHz resolution filter of the spectrum analyzer is included on page of this report.

² E-Mail Frank Coperich, FCC to Mike Nicolay, CTJC 02/25/2000

Note:

The offset value indicated on the spectral plots represents the external attenuation value that includes the fixed attenuator plus the cable loss.

GMSK modulation:

Frequency Marker Indication [MHz]	Indicated Power Level [dBm]	External Attn. [dB]	Worst Case Emission Level [dBm]	Compliance Limit [dBm]	Spectral Plot on Page:	Results
Carrier Test Frequency 1930.2 MHz						
1061.77	-72.0	34.7	-37.3	-13.0	45	compliant
1928.87	-96.0	34.7	-61.3	-38.0	46	compliant
1929.98	-45.1	30.7	-14.4	-13.0	48	compliant
1990.95	-96.9	34.7	-62.2	-13.0	49	compliant
1993.47	-96.7	34.7	-62.0	-38.0	50	compliant
4903.65	-71.9	34.7	-37.2	-13.0	51	compliant
16122.24	-64.7	34.7	-30.0	-13.0	52	compliant
Carrier Test Frequency 1960.0 MHz						
1015.53	-72.7	34.7	-38.0	-13.0	53	compliant
1927.97	-94.5	34.7	-59.8	-38.0	54	compliant
1929.59	-96.4	34.7	-61.7	-13.0	55	compliant
1990.46	-95.5	34.7	-60.8	-13.0	56	compliant
1991.80	-95.4	34.7	-60.7	-38.0	57	compliant
4451.99	-72.4	34.7	-37.7	-13.0	58	compliant
17474.95	-66.3	34.7	-31.6	-13.0	59	compliant
Carrier Test Frequency 1989.8 MHz						
1042.50	-72.4	34.7	-37.7	-13.0	60	compliant
1927.07	-97.1	34.7	-62.4	-38.0	61	compliant
1929.44	-96.1	34.7	-61.4	-13.0	62	compliant
1990.02	-44.8	30.7	-14.1	-13.0	64	compliant
1992.32	-95.0	34.7	-60.3	-38.0	65	compliant
3705.26	-71.5	34.7	-36.8	-13.0	66	compliant
19488.98	-66.6	34.7	-31.9	-13.0	67	compliant

Note:

The offset value indicated on the spectral plots represents the external attenuation value that includes the fixed attenuator plus the cable loss.

8PSK modulation:

Frequency Marker Indication [MHz]	Indicated Power Level [dBm]	External Attn. [dB]	Worst Case Emission Level [dBm]	Compliance Limit [dBm]	Spectral Plot on Page:	Results
Carrier Test Frequency 1930.2 MHz						
988.55	-73.0	34.7	-38.3	-13.0	45	compliant
1928.71	-95.7	34.7	-61.0	-38.0	46	compliant
1929.98	-44.6	30.7	-13.9	-13.0	48	compliant
1991.00	-96.0	34.7	-61.3	-13.0	49	compliant
1993.93	-96.0	34.7	-61.3	-38.0	50	compliant
3741.39	-71.7	34.7	-37.0	-13.0	51	compliant
6623.25	-66.1	34.7	-31.4	-13.0	52	compliant
Carrier Test Frequency 1960.0 MHz						
1061.77	-72.9	34.7	-38.2	-13.0	53	compliant
1927.62	-95.4	34.7	-60.7	-38.0	54	compliant
1929.67	-96.1	34.7	-61.4	-13.0	55	compliant
1990.41	-96.1	34.7	-61.4	-13.0	56	compliant
1991.66	-96.2	34.7	-61.5	-38.0	57	compliant
3693.22	-70.9	34.7	-36.2	-13.0	58	compliant
10891.78	-66.7	34.7	-32.0	-13.0	59	compliant
Carrier Test Frequency 1989.8 MHz						
1308.41	-72.5	34.7	-37.8	-13.0	60	compliant
1927.04	-95.8	34.7	-61.1	-38.0	61	compliant
1929.38	-96.6	34.7	-61.9	-13.0	62	compliant
1990.00	-45.0	30.7	-14.3	-13.0	64	compliant
1991.32	-94.5	34.7	-59.8	-38.0	65	compliant
2452.68	-71.8	34.7	-37.1	-13.0	66	compliant
15130.26	-66.3	34.7	-31.6	-13.0	67	compliant

The measured conducted emission levels were found to be compliant with the manufacturer's specifications and with all requirements of the FCC rules.

2.7 Test No. 5: Field strength of spurious radiation (§ 2.1053, § 2.1057, § 24.238)

2.7.1 Purpose

The measurement of spurious radiated emissions was performed pursuant to § 2.1053 and § 2.1057 to verify that the field strength of any spurious emissions radiated directly from the cabinet, control circuits, power leads or intermediate circuit elements are attenuated below the transmitter power P by at least $43 + 10 \log_{10} (P \text{ in Watts})$ dB as is required by § 24.238 (Emission limits).

2.7.2 Limits

Compliance with § 24.238 requires that all spurious emissions be attenuated below the transmitter power by at least $43 + 10 \log_{10} P$ (P = rated maximum transmitter output power in Watts).

The compliance limit was calculated as per the following table:

GMSK modulation:

Rated maximum transmitter output power	70.79W (=48.5 dBm)
Required attenuation	$43 + 10 \log_{10} 70.79 = 61.5 \text{ dB}$

8PSK modulation:

Rated maximum transmitter output power	70.79W (=48.5 dBm)
Required attenuation	$43 + 10 \log_{10} 70.79 = 61.5 \text{ dB}$

According to § 2.1057, all emissions to the 10th harmonic were investigated.

2.7.3 EUT operation condition

The EUT was configured and operating as described in section 2.2.1. The radiated spurious emissions were determined for three selected carrier test frequencies, according to section 2.2.2. During all testing, the EUT's RF output power was terminated into a non-radiating 50 Ω dummy load.

2.7.4 Test configuration

The measurements (scans) were conducted for BS-41U. The measurements were performed in the anechoic chamber at the Siemens AG EMC Center, Hofmannstraße 51, 81359 Munich, Germany. The radiated test site complies with the site attenuation requirements listed in ANSI C63.4 1992 and is listed with the FCC.

The test antenna was positioned at a distance of 3 m from the EUT. Photographs of the EUT in the anechoic chamber are shown on page 69 of this measurement report.

2.7.5 Measurement procedure

For maximizing the radiated spurious emission measured levels the EUT was rotated 360°. The antenna height was adjusted between 1 m and 4 m. Both, horizontal and vertical polarizations were investigated.

To verify that all spurious emissions are compliant to the limits specified in § 24.238, the substitution method described in the ANSI/TIA/EIA-603-1992 document was used. Initially the EUT's spurious emission frequencies and field-strength values were measured and recorded. The measured, maximized field strength values were then used as the references levels for dipole substitution measurements.

For substitution measurements the EUT was removed and replaced with a signal generator and a transmitting antenna. TIA/EIA-603 requires that all substitution measurement transmissions have be done using a "dipole" antenna, as the reference antenna. As per TIA/EIA-603, corrections were done to equate the results to a dipole antenna. Using the same measurement techniques listed above (for maximizing), the signal generators output power was adjusted until the initial spurious emission reference levels were matched. The signal generator's indicated output power level was then recorded and corrected to an equivalent level at the transmitting antenna's input connector.

To determine compliance with the FCC Rules, the corrected dipole substitution powers were then set into relation to the EUT's (transmitter) power, measured at the antenna connector.

2.7.6 Measurement results & limits

Worst case detected emission levels are reported in the following table (refer to spectral plots included on pages 70 – 72 for details). The antenna factor and cable loss is according to the manufacturer's specification.

GMSK modulation:

Spurious Emission Frequency	Spurious Emission Reference Field Strength	Signal Generator Output	Power at dipole antenna ³	Maximum Transmitter Output Power at the Antenna Port	Spurious Emissions in reference to Output Power of EUT ⁴	Limit	Results
[MHz]	[dBμV/m]	[dBm]	[dBm]	[dBm]	[dBc]	[dB]	
1893.5	46.90	-58.0	-53.34	48.5	101.84	61.5	compliant
3146.0	48.10	-57.1	-53.58	48.5	102.08	61.5	compliant
3861.0	57.90	-46.7	-43.17	48.5	91.67	61.5	compliant
4766.0	55.10	-50.1	-46.35	48.5	94.85	61.5	compliant
7252.5	51.50	-54.1	-50.35	48.5	98.85	61.5	compliant
9835.5	55.20	-50.0	-46.55	48.5	95.05	61.5	compliant
13408.0	63.80	-41.4	-43.68	48.5	92.18	61.5	compliant
13787.0	65.60	-39.6	-42.15	48.5	90.65	61.5	compliant

³ Power at Dipole Antenna = Signal Generator Output – cable loss + correction factor antenna gain

⁴ [dBc] = Maximum Transmitter Output Power [dBm] - Power at dipole antenna [dBm]

8PSK modulation:

Spurious Emission Frequency	Spurious Emission Reference Field Strength	Signal Generator Output	Power at dipole antenna ⁵	Maximum Transmitter Output Power at the Antenna Port	Spurious Emissions in reference to Output Power of EUT ⁶	Limit	Results
[MHz]	[dBμV/m]	[dBm]	[dBm]	[dBm]	[dBc]	[dB]	
1886.0	46.90	-58.0	-53.34	48.5	101.84	61.5	compliant
3861.0	57.90	-48.0	-44.47	48.5	92.97	61.5	compliant
7535.0	51.50	-53.7	-49.95	48.5	98.45	61.5	compliant
9835.5	55.20	-50.0	-46.55	48.5	95.05	61.5	compliant
13408.0	63.80	-41.4	-43.65	48.5	92.15	61.5	compliant
13787.0	65.60	-39.6	-42.15	48.5	90.65	61.5	compliant

The measured emission levels were found to be compliant with the manufacturer's specifications and with all requirements of the FCC rules.

⁵ Power at Dipole Antenna = Signal Generator Output – cable loss + correction factor antenna gain

⁶ [dBc] = Maximum Transmitter Output Power [dBm] - Power at dipole antenna [dBm]

2.8 Test No. 6: Frequency stability (§ 2.1055, § 24.235)

2.8.1 Purpose

Frequency stability measurements were performed to verify that the frequency deviation of the emission stays within the licensee's frequency block under extreme temperature conditions (-30°C to +50°C) according to § 2.1055.

2.8.2 Limits

According to § 24.235, the frequency of the fundamental emission is required to stay within the authorized frequency block, independent of the ambient temperature.

2.8.3 EUT operation condition

The standard setup procedure as described in section 2.2.1 of this report is used. The EUT was operated and tested in a climatic chamber.

2.8.4 Test configuration

The EUT was controlled by a protocol tester Tektronix K1297 via the serial Abis Link. The RF output signal is injected into a mobile communication tester Rohde&Schwarz CMU300 via a high power 20 dB attenuator. The attenuator is used to protect the input of the measurement equipment from high RF power levels. A complete list of the measurement equipment is included on page 22 of this measurement report.

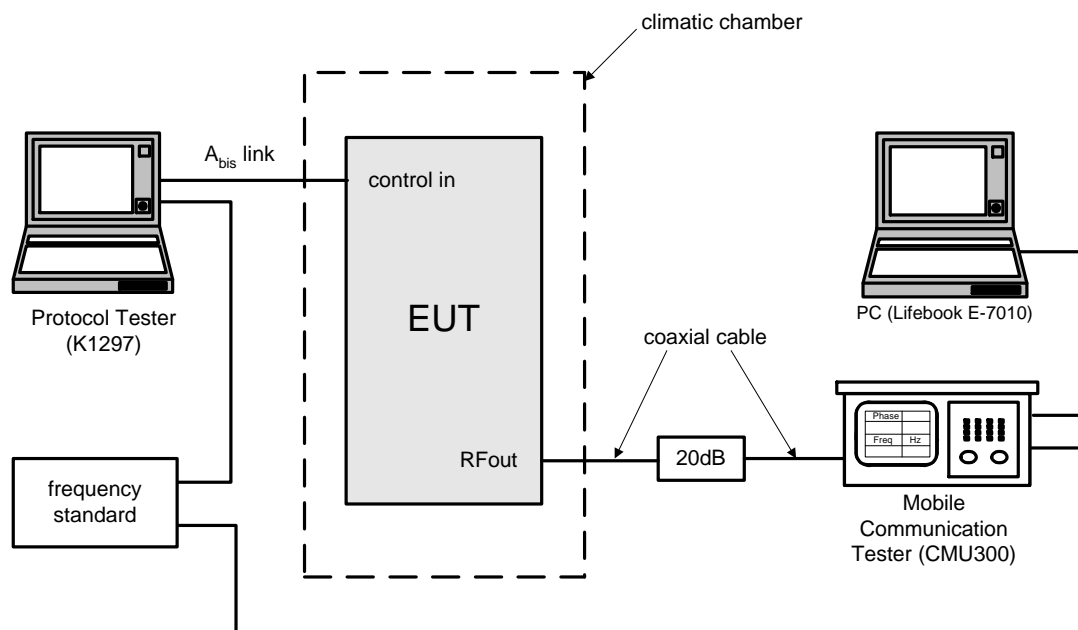

Fig. 2 – Measurement Test Configuration

2.8.5 Measurement procedure

The center frequency deviation of the highest and lowest test frequency was measured at ambient temperature levels from -30°C to +50°C in intervals of not more than 10°C.

At each temperature level, the frequency was measured over a certain time period, taking ten measurement values. Worst-case measurement data is reported.

2.8.6 Measurement results

The following table includes the worst case detected frequency deviations. For complete measurement data see plots on pages 73 – 76.

GMSK modulation:

Ambient Temp. [°C]	Frequency Deviation @ 102V [ppm]	Frequency Deviation @ 120V [ppm]	Frequency Deviation @ 138V [ppm]	Manufacturer's Specification [ppm]	Results
-30	0.007	0.008	0.008	0.05	compliant
-20	0.007	0.008	0.008	0.05	compliant
-10	0.007	0.008	0.008	0.05	compliant
0	0.008	0.008	0.007	0.05	compliant
+10	0.007	0.007	0.008	0.05	compliant
+20	0.007	0.007	0.007	0.05	compliant
+30	0.006	0.007	0.007	0.05	compliant
+40	0.009	0.007	0.007	0.05	compliant
+50	0.006	0.007	0.007	0.05	compliant

8PSK modulation:

Ambient Temp. [°C]	Frequency Deviation @ 102V [ppm]	Frequency Deviation @ 120V [ppm]	Frequency Deviation @ 138V [ppm]	Manufacturer's Specification [ppm]	Results
-30	0.009	0.009	0.008	0.05	compliant
-20	0.010	0.009	0.010	0.05	compliant
-10	0.009	0.009	0.011	0.05	compliant
0	0.009	0.010	0.009	0.05	compliant
+10	0.010	0.009	0.010	0.05	compliant
+20	0.010	0.009	0.009	0.05	compliant
+30	0.010	0.009	0.010	0.05	compliant
+40	0.010	0.010	0.011	0.05	compliant
+50	0.010	0.010	0.010	0.05	compliant

A pseudo random bit sequence was applied to the modulator during all testing. No variation of the frequency deviation due to keying was observed. No variation of the frequency deviation due to keying was observed. Also, no variation of the frequency deviation due to the EUT's heater element was observed at any temperature level (refer to measurement data above).

In all cases, the fundamental emission stayed within the authorized frequency block.

The measured frequency stability was found to be compliant with the manufacturer's specifications and with all requirements of the FCC rules.

2.9 Test No. 7: Slow frequency hopping

2.9.1 Introduction

Slow frequency hopping (SFH) is a feature of GSM transceiver systems used to improve the signal quality under fading conditions. When SFH is activated, the carrier frequency is shifted to a different value on a timeslot per timeslot basis. This is depicted in the figure below (carrier test frequencies 1930.2 MHz, 1960.0 MHz, and 1989.8 MHz).

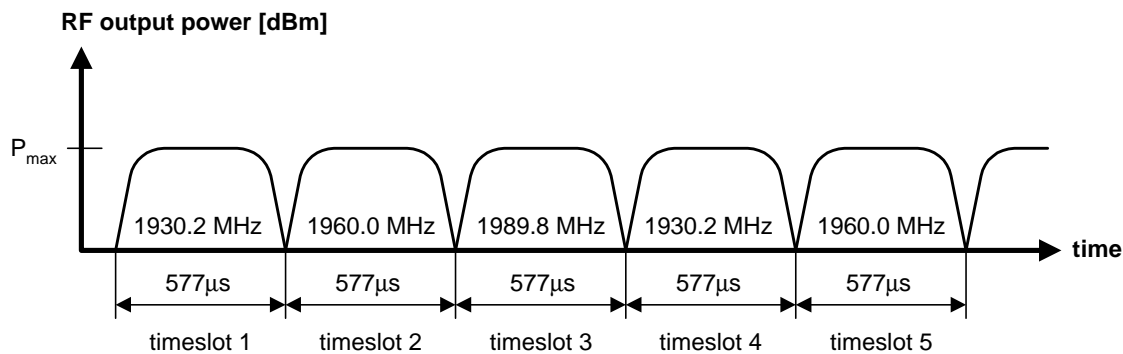

Fig. 3 – Slow frequency hopping (SFH) comprising 3 carrier test frequencies (1930.2 MHz, 1960.0 MHz, and 1989.8 MHz).

SFH allows only one carrier per transmitter being activated at a time. This ensures that no intermodulation products are produced.

2.9.2 Purpose

These measurements were performed to verify that under SFH operating conditions, spurious emissions due to intermodulation products and periodically shifting the carrier frequency were not produced above the compliance level required under § 2.1051 of the FCC rules.

2.9.3 EUT operation condition

The EUT was configured and operating in a typical operation mode as described in section 2.2.1. The SFH operating mode was switched on throughout the measurements. 3 hopping test frequencies were measured in accordance with section 2.2.2 of this application. Please refer to Fig. 3 for the hopping scheme.

2.9.4 Test configuration

A test configuration was as described in section 2.2.4 of this application. See page 7 for a block diagram (Fig. 1).

2.9.5 Measurement procedure

A spectrum analyzer model Rohde&Schwarz FSIQ 26 was used to verify that all emissions are below the permissible limit.

2.9.6 Measurement results

SFH did not cause any detectable emissions above the compliance limits required by the FCC rules. The following table summarizes the worst case detected emission levels:

Note:

The offset value indicated on the spectral plots represents the external attenuation value that includes the fixed attenuator plus the cable loss.

GMSK modulation:

Frequency [MHz]	Indicated Power Level [dBm]	External Attenuation [dB]	Measured Power Level [dBm]	Compliance Limit [dBm]	Results
1950.18	-59.4	34.7	-24.7	-13.0	compliant
2030.74	-65.0	34.7	-30.3	-13.0	compliant
2012.97	-82.4	34.7	-47.7	-13.0	compliant
1988.97	-83.5	34.7	-48.8	-13.0	compliant

8PSK modulation:

Frequency [MHz]	Indicated Power Level [dBm]	External Attenuation [dB]	Measured Power Level [dBm]	Compliance Limit [dBm]	Results
1943.37	-60.7	34.7	-26.0	-13.0	compliant
1943.37	-65.1	34.7	-30.4	-13.0	compliant
1942.97	-82.6	34.7	-47.9	-13.0	compliant
1941.84	-84.1	34.7	-49.4	-13.0	compliant

The above listed emission levels were taken from measurements conducted using three different RBW (resolution bandwidth) settings (1 MHz, 300 kHz, and 3 kHz). Copies of the spectral plots can be found on pages 77 – 80.

It was verified through measurements that SFH does not cause any adverse effects on other parameters of the transmitter (RF power output, modulation characteristics, occupied bandwidth, spurious emissions, and frequency stability).

The measurement values were found to be compliant with the manufacturer's specifications and with all requirements of the FCC rules.

3 Measurement data and spectral plots

3.1 Part list of the RF measurement test equipment

No.	Item	Model	Serial Number
1	Personal computer	Fujitsu Siemens SCENIC PRO M6	VK019941
2	Spectrum analyzer	Rohde & Schwarz FSIQ 26	825556/007
3	Atomic clock reference	Datum GmbH RubiSource 2000	187
4	Protocol Tester	Tektronix K1297	7KK1297-1FA01

3.2 Part list of the climate measurement test equipment

No.	Item	Model	Serial Number
1	Personal computer	Fujitsu Siemens Lifebook E-7010	YBDC007725
2	Communication Tester	Rohde & Schwarz CMU300	100059
3	Atomic clock reference	Datum GmbH RubiSource 2000	150
4	Protocol Tester	Tektronix K1297	DE9908-2613
5	AC Power Supply	Heiden-Electronics 1609-214	0801-183998 / 00092908 / 500080
6	Climatic chamber	Brabender KKE20.700/60	87000563

3.3 Part list of the EMC measurement test equipment

No.	Item	Model	Serial Number
1	Protocol Tester	Tektronix K1297	DE9908-2613
2	Radio Communication Tester	Rohde & Schwarz CMU 300	100059
3	Radio Communication Tester	Rohde & Schwarz CMU 300	100060
4	Personal Computer	Fujitsu Siemens Lifebook	YBDC007725
5	Personal Computer	Fujitsu Siemens Lifebook	YBDC007722
6	Atomic clock reference	Datum GmbH RubiSource 2000	150
7	signal generator	Rohde & Schwarz SMR 20	100370
8	antenna	Ailtech 96001	2622
9	antenna	SCIEN 12-18	100
10	antenna	SING 95010-1	0273
11	ESMI display section	Rohde & Schwarz ESAI-D	835862/003
12	ESMI RF section	Rohde & Schwarz ESMI-RF	837059/006
13	EMI Receiver	Rohde & Schwarz ESCS30	100099
14	controller	Deisel HD100	100/503
15	antenna	Emco 3105	2020
16	antenna	Chase CBL6111	1566
17	LISN	Rohde & Schwarz ESH2-Z5	893406/019
18	signal generator	Rohde & Schwarz SMR 20	832033/0006

3.4 Spectral plots

Test No. 1: RF Power Output (Carrier Test Frequency = 1930.2 MHz)

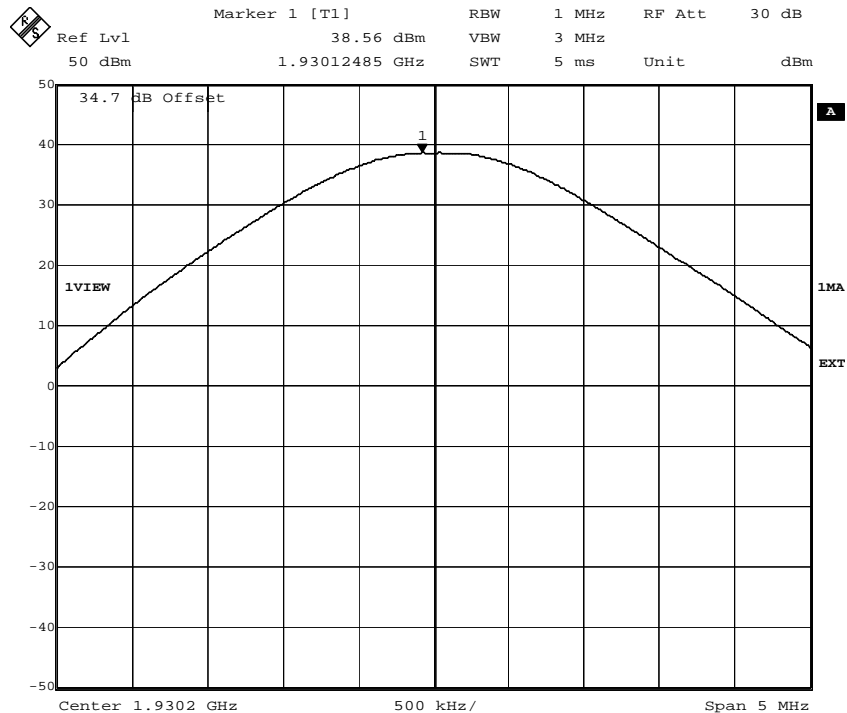

Date: 16.MAY.2003 13:12:04

Fig. 4 – RF power at the antenna connector (GMSK modulation).

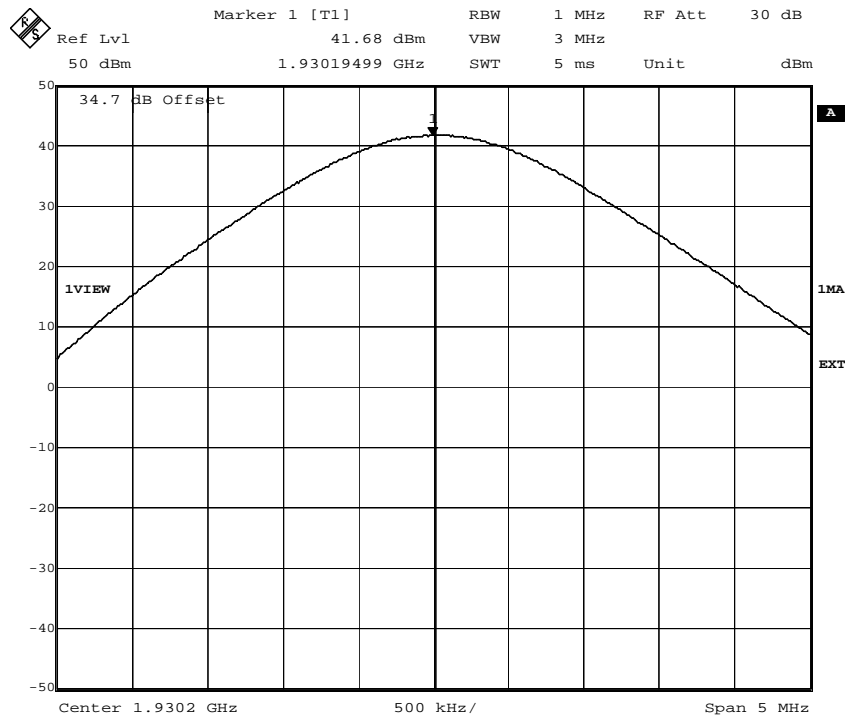

Date: 16.MAY.2003 13:17:22

Fig. 5 – RF power at the antenna connector (8PSK modulation).

Note: The external attenuation of 34.7 dB is included in the spectral plot. This accounts for the external attenuator and the cable loss during the testing.

Test No. 1: RF Power Output (Carrier Test Frequency = 1930.2 MHz)

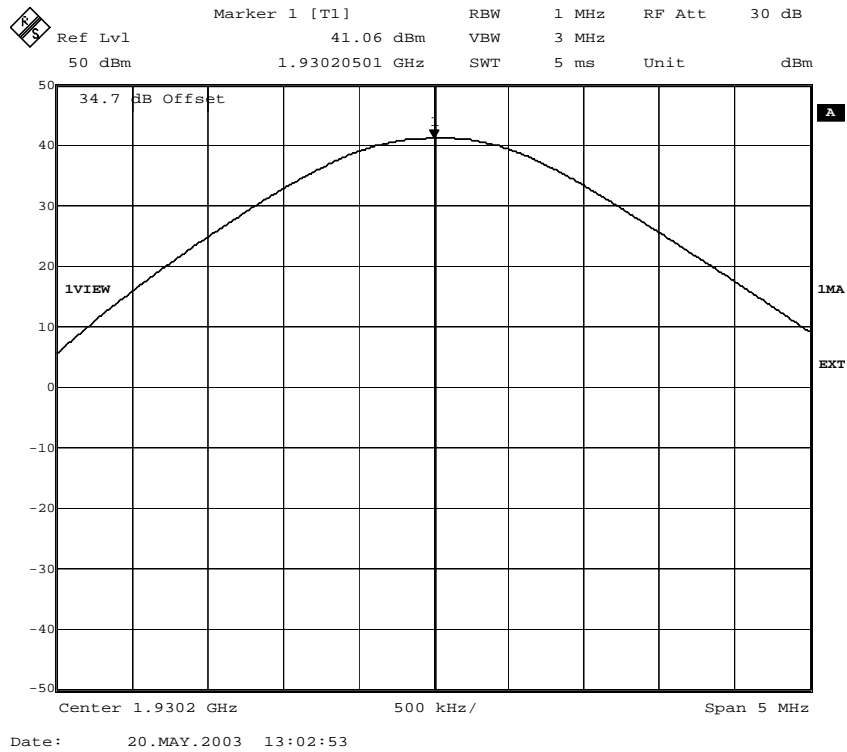

Fig. 6 – RF power at the antenna connector (GMSK modulation) for ECUPV2.

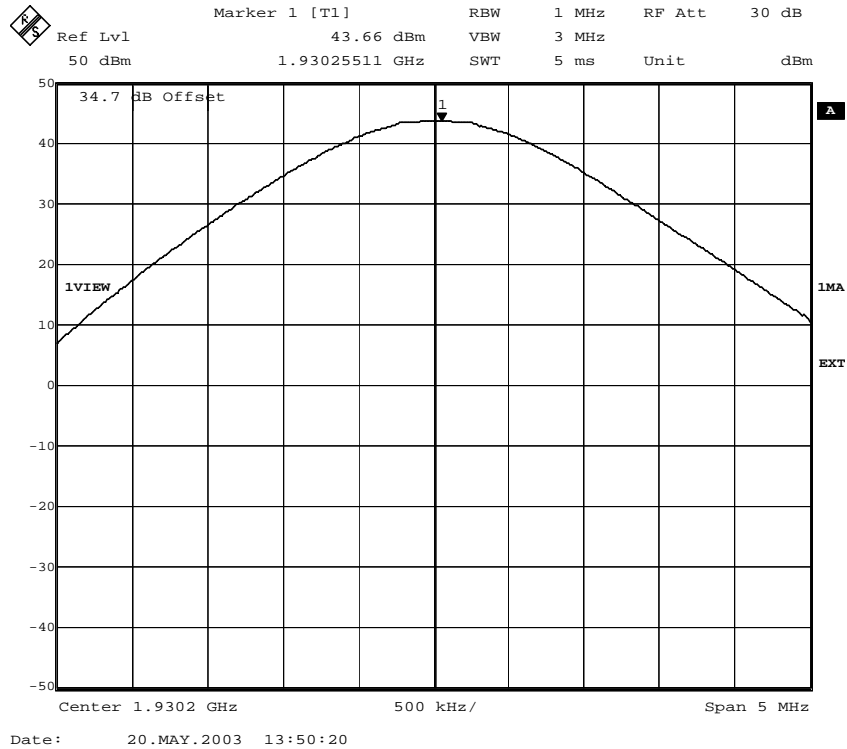

Fig. 7 – RF power at the antenna connector (8PSK modulation) for ECUPV2.

Note: The external attenuation of 34.7 dB is included in the spectral plot. This accounts for the external attenuator and the cable loss during the testing.

Test No. 1: RF Power Output (Carrier Test Frequency = 1930.4 MHz)

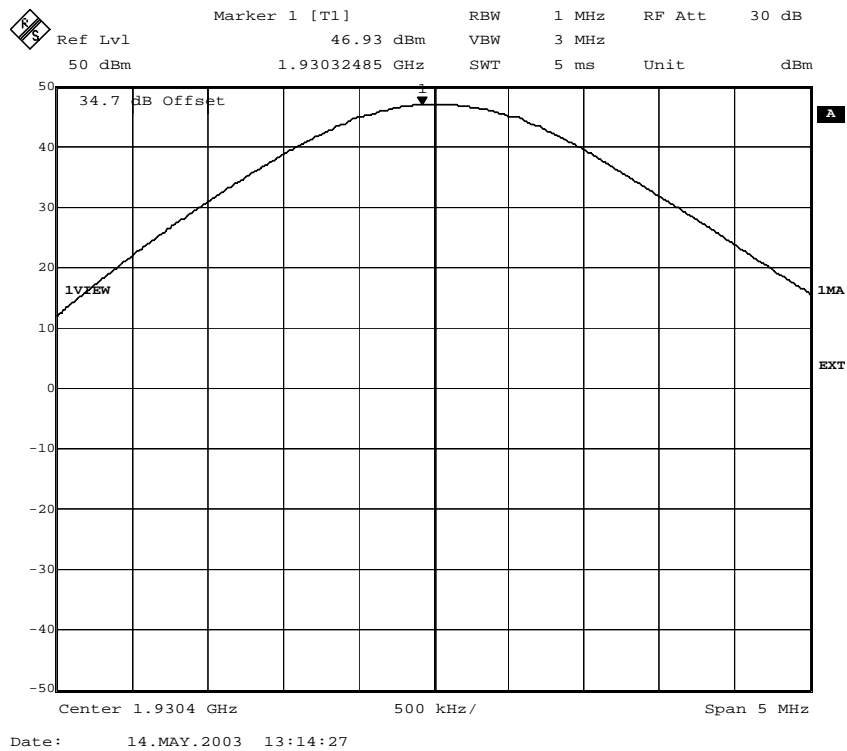

Fig. 8 – RF power at the antenna connector (GMSK modulation).

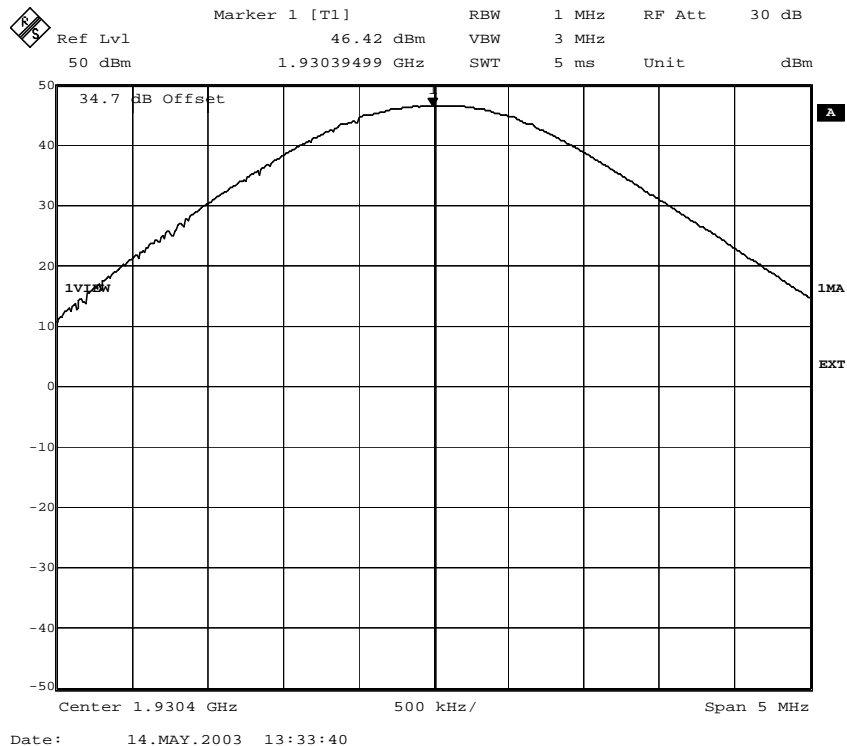

Fig. 9 – RF power at the antenna connector (8PSK modulation).

Note: The external attenuation of 34.7 dB is included in the spectral plot. This accounts for the external attenuator and the cable loss during the testing.

Test No. 1: RF Power Output (Carrier Test Frequency = 1930.4 MHz)

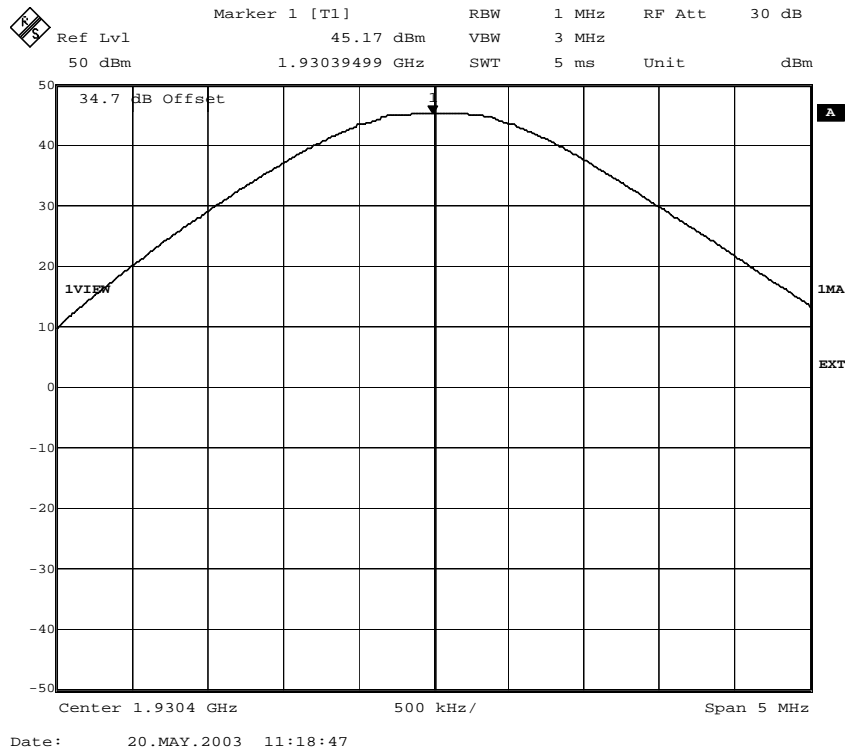

Fig. 10 – RF power at the antenna connector (GMSK modulation) for ECUPV2.

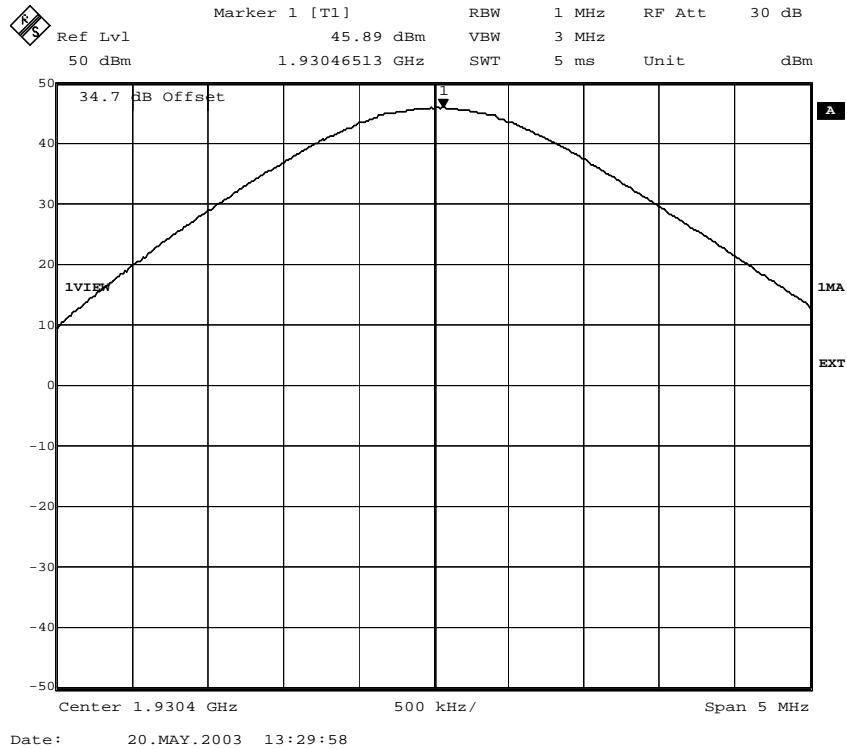

Fig. 11 – RF power at the antenna connector (8PSK modulation) for ECUPV2.

Note: The external attenuation of 34.7 dB is included in the spectral plot. This accounts for the external attenuator and the cable loss during the testing.

Test No. 1: RF Power Output (Carrier Test Frequency = 1960.0 MHz)

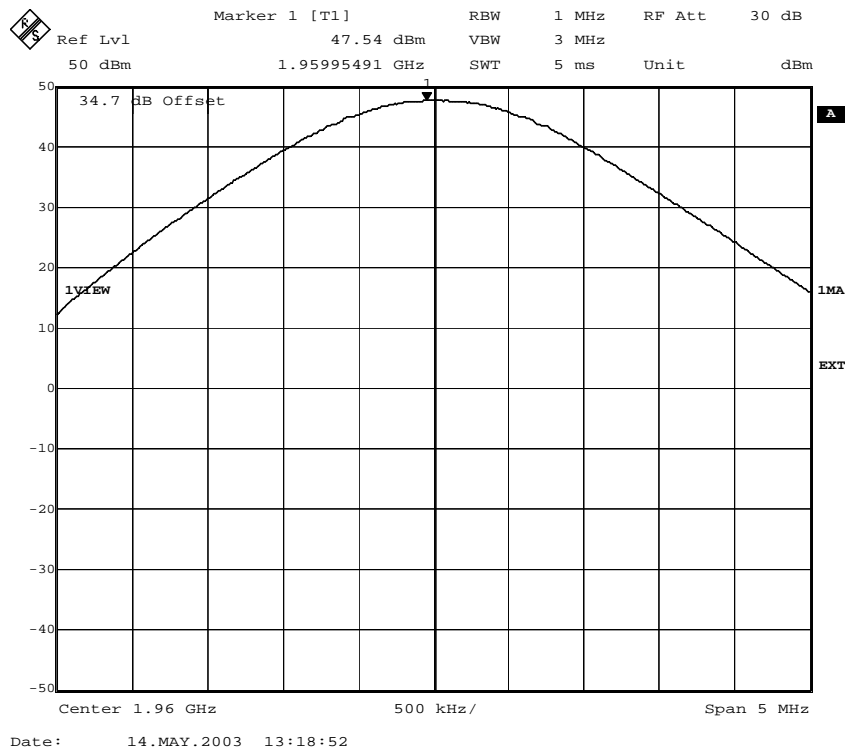

Fig. 12 – RF power at the antenna connector (GMSK modulation).

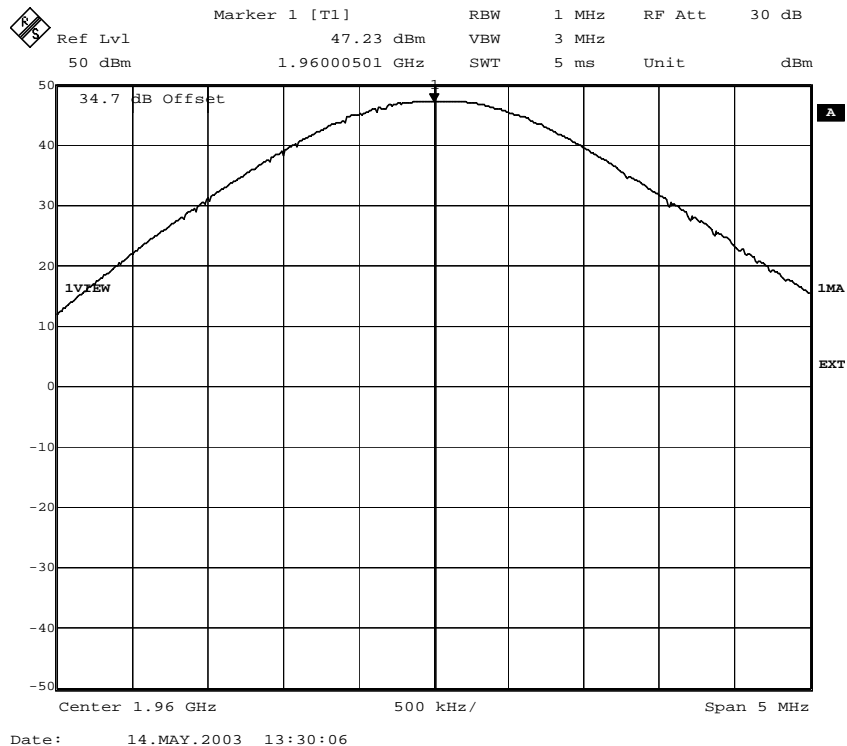

Fig. 13 – RF power at the antenna connector (8PSK modulation).

Note: The external attenuation of 34.7 dB is included in the spectral plot. This accounts for the external attenuator and the cable loss during the testing.

Test No. 1: RF Power Output (Carrier Test Frequency = 1960.0 MHz)

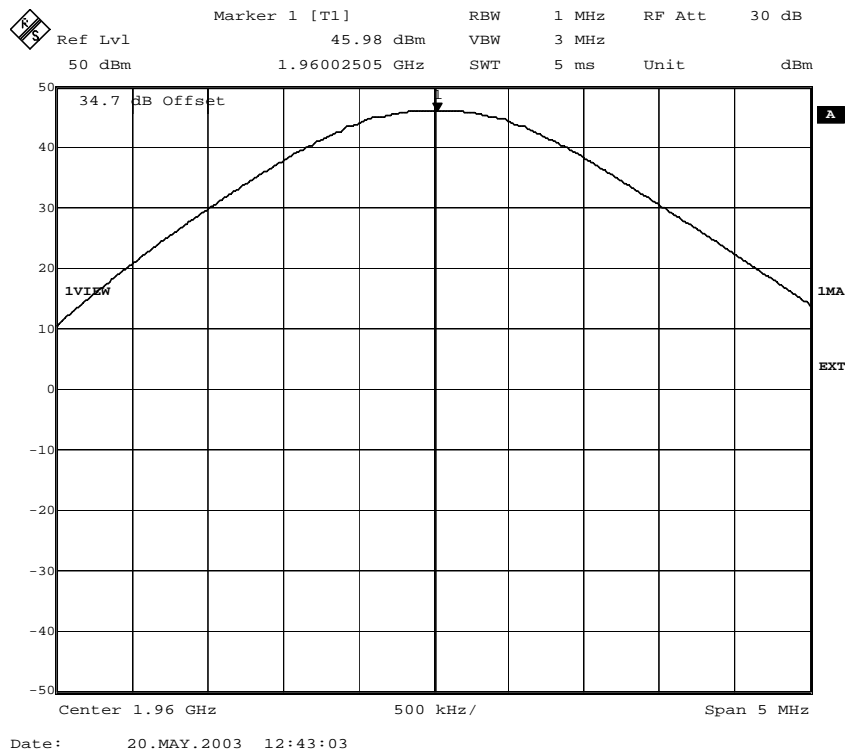

Fig. 14 – RF power at the antenna connector (GMSK modulation) for ECUPV2.

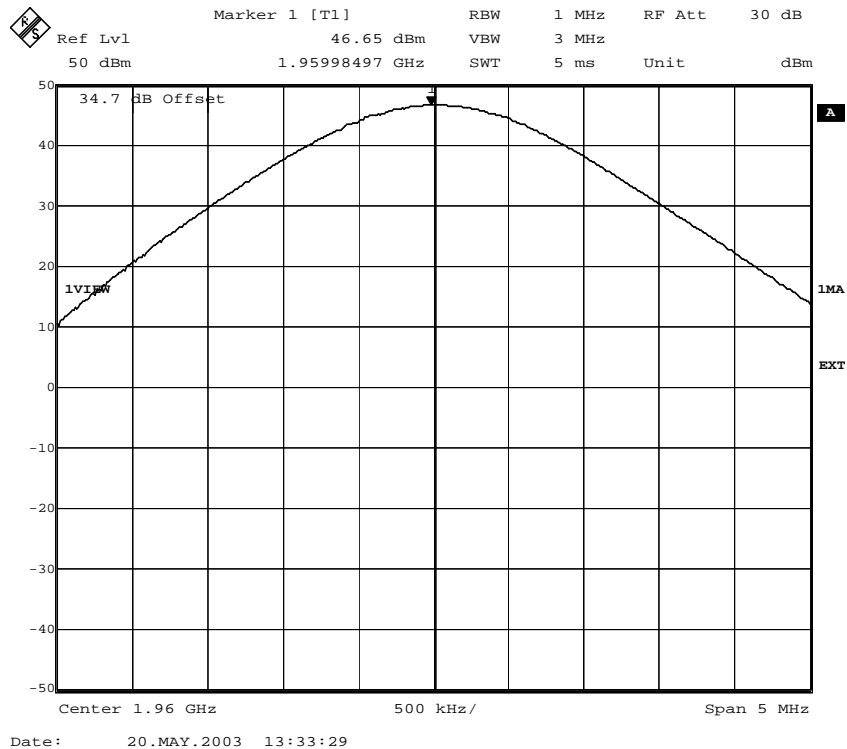

Fig. 15 – RF power at the antenna connector (8PSK modulation) for ECUPV2.

Note: The external attenuation of 34.7 dB is included in the spectral plot. This accounts for the external attenuator and the cable loss during the testing.

Test No. 1: RF Power Output (Carrier Test Frequency = 1989.6 MHz)

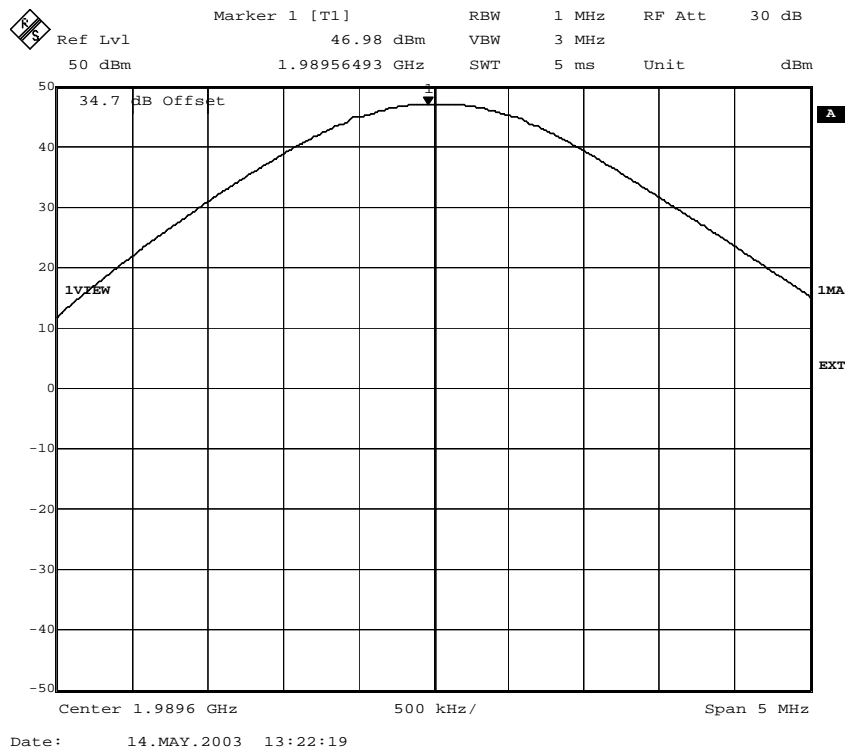

Fig. 16 – RF power at the antenna connector (GMSK modulation).

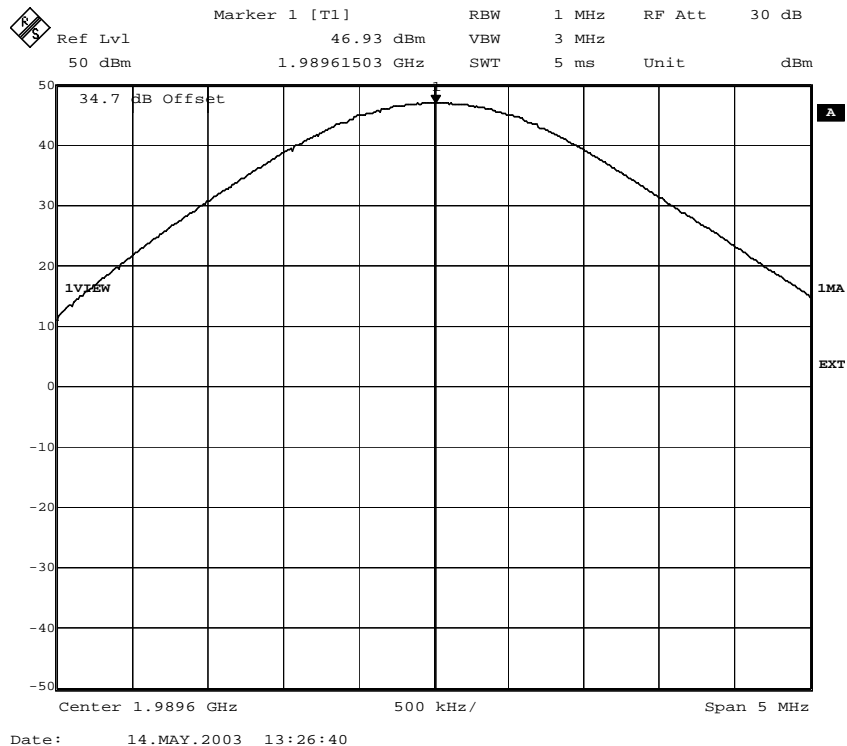

Fig. 17 – RF power at the antenna connector (8PSK modulation).

Note: The external attenuation of 34.7 dB is included in the spectral plot. This accounts for the external attenuator and the cable loss during the testing.

Test No. 1: RF Power Output (Carrier Test Frequency = 1989.6 MHz)

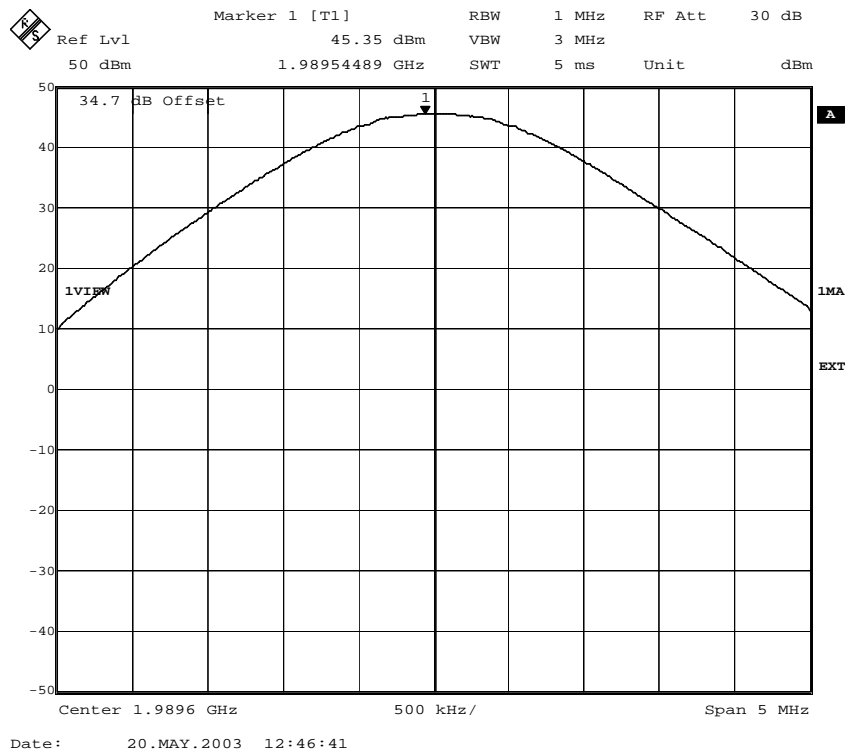

Fig. 18 – RF power at the antenna connector (GMSK modulation) for ECUPV2.

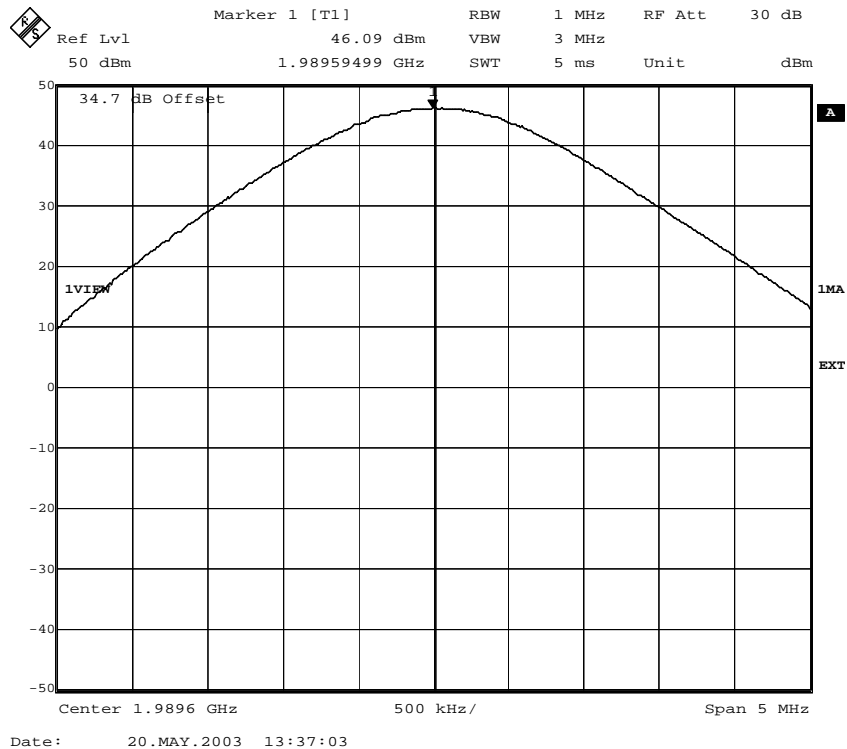

Fig. 19 – RF power at the antenna connector (8PSK modulation) for ECUPV2.

Note: The external attenuation of 34.7 dB is included in the spectral plot. This accounts for the external attenuator and the cable loss during the testing.

Test No. 1: RF Power Output (Carrier Test Frequency = 1989.8 MHz)

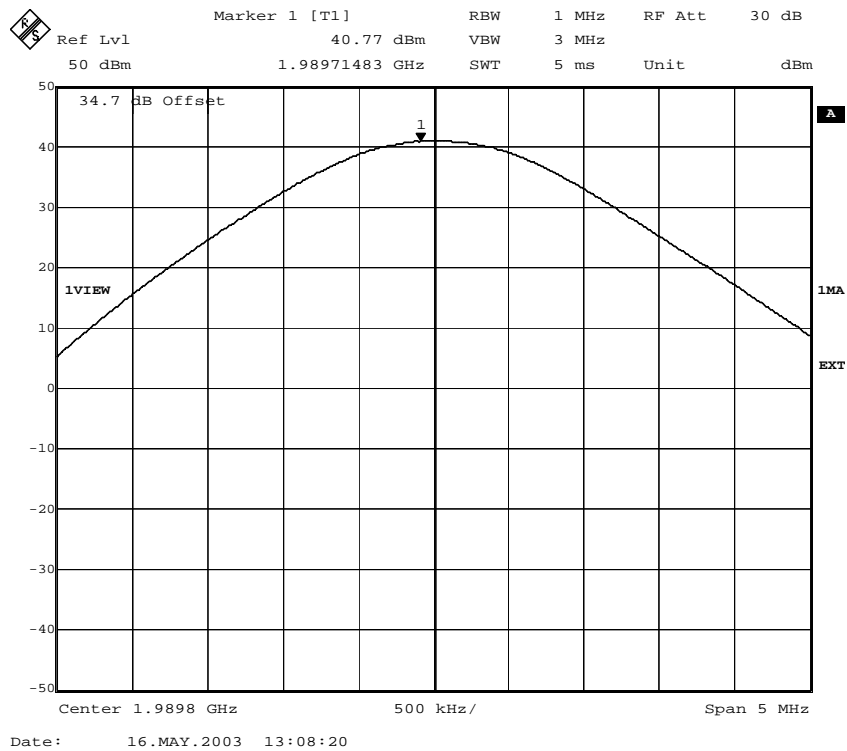

Fig. 20 – RF power at the antenna connector (GMSK modulation).

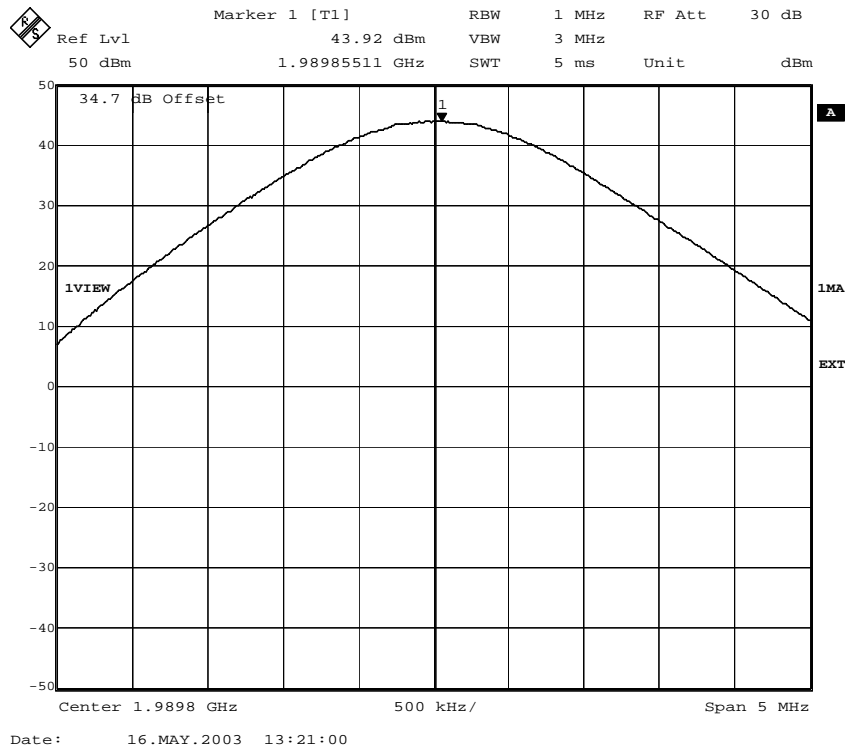

Fig. 21 – RF power at the antenna connector (8PSK modulation).

Note: The external attenuation of 34.7 dB is included in the spectral plot. This accounts for the external attenuator and the cable loss during the testing.

Test No. 1: RF Power Output (Carrier Test Frequency = 1989.8 MHz)

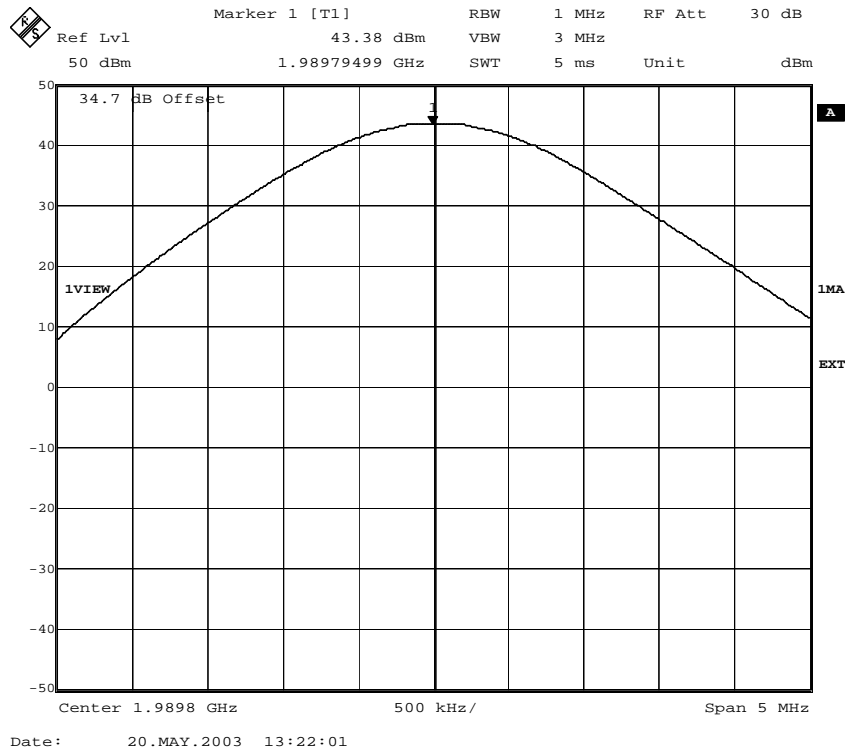

Fig. 22 – RF power at the antenna connector (GMSK modulation) for ECUPV2.

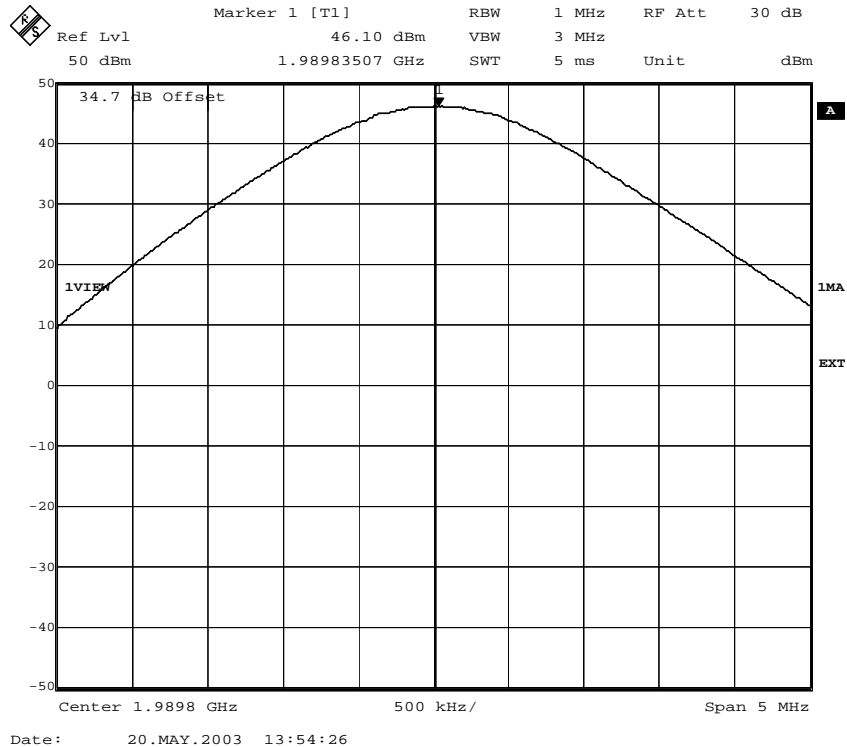

Fig. 23 – RF power at the antenna connector (8PSK modulation) for ECUPV2.

Note: The external attenuation of 34.7 dB is included in the spectral plot. This accounts for the external attenuator and the cable loss during the testing..

Test No. 2: Modulation Characteristics

No additional measurements are required for the modulation characteristics. Please refer to test no. 3, occupied bandwidth on pages 35 - 44.

Test No. 3: Occupied Bandwidth (Carrier Test Frequency = 1930.2 MHz)

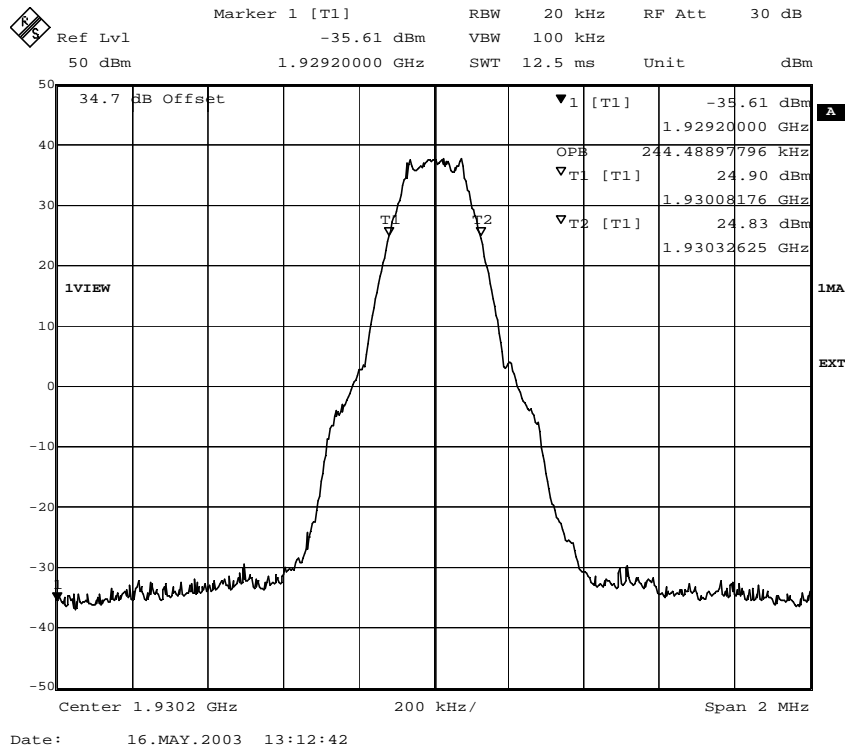

Fig. 24 – Occupied bandwidth (GMSK modulation).

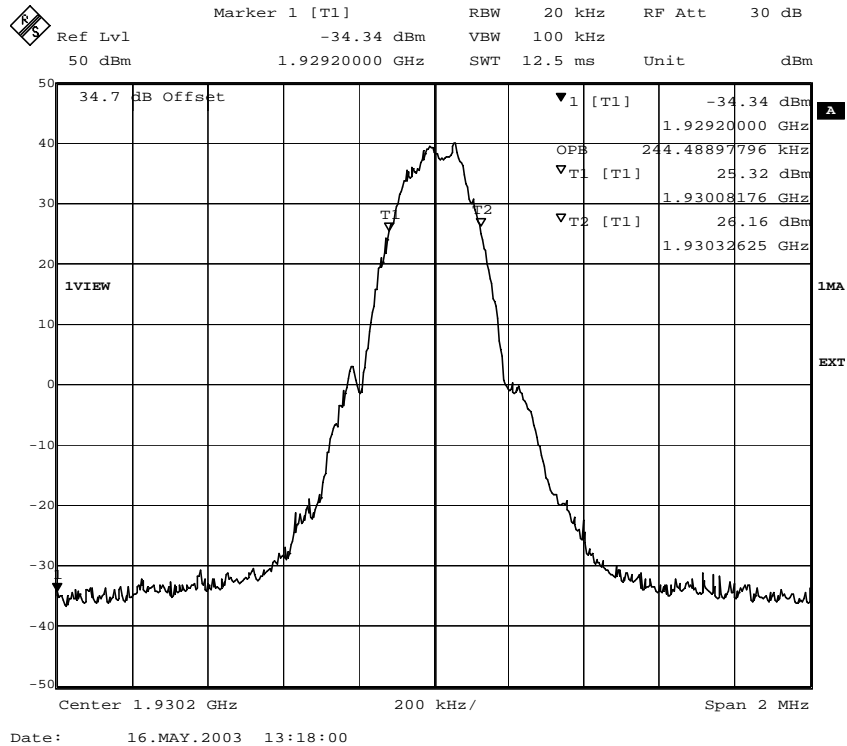

Fig. 25 – Occupied bandwidth (8PSK modulation).

Note: The external attenuation of 34.7 dB is included in the spectral plot. This accounts for the external attenuator and the cable loss during the testing.

Test No. 3: Occupied Bandwidth (Carrier Test Frequency = 1930.2 MHz)

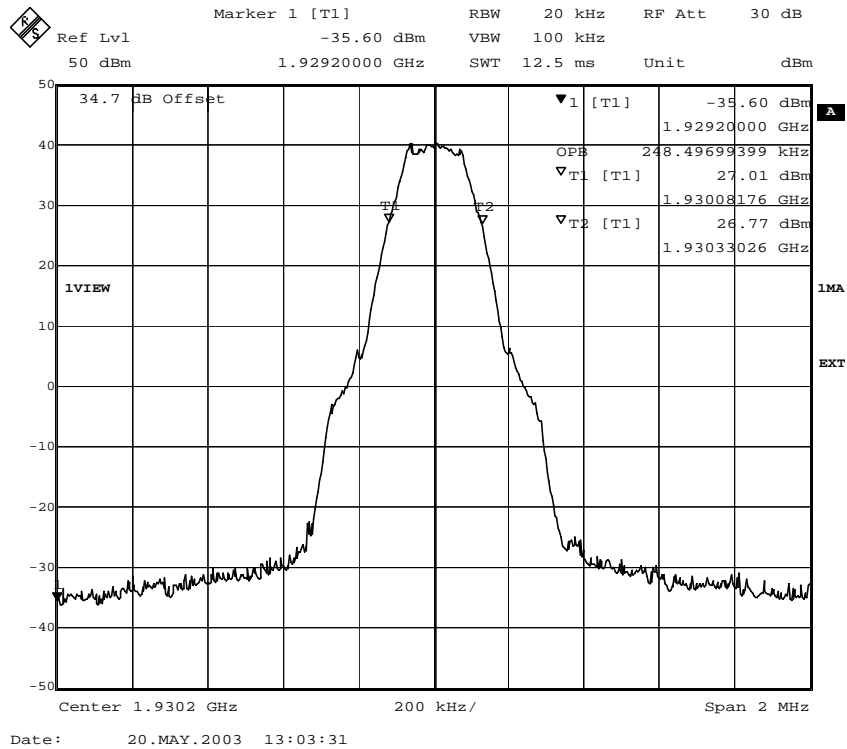

Fig. 26 – Occupied bandwidth (GMSK modulation) for ECUPV2.

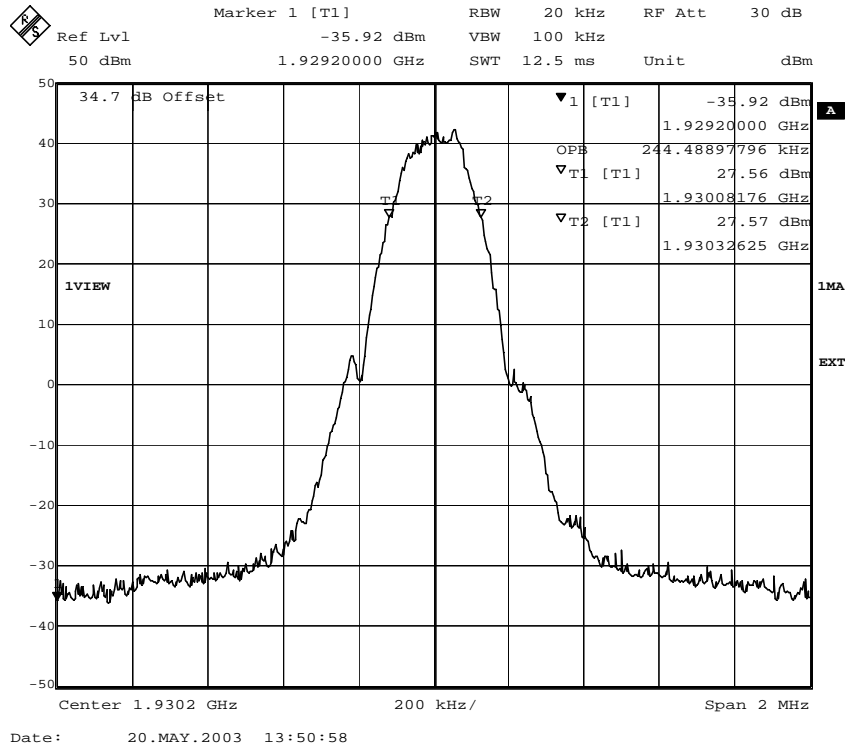

Fig. 27 – Occupied bandwidth (8PSK modulation) for ECUPV2.

Note: The external attenuation of 34.7 dB is included in the spectral plot. This accounts for the external attenuator and the cable loss during the testing.

Test No. 3: Occupied Bandwidth (Carrier Test Frequency = 1930.4 MHz)

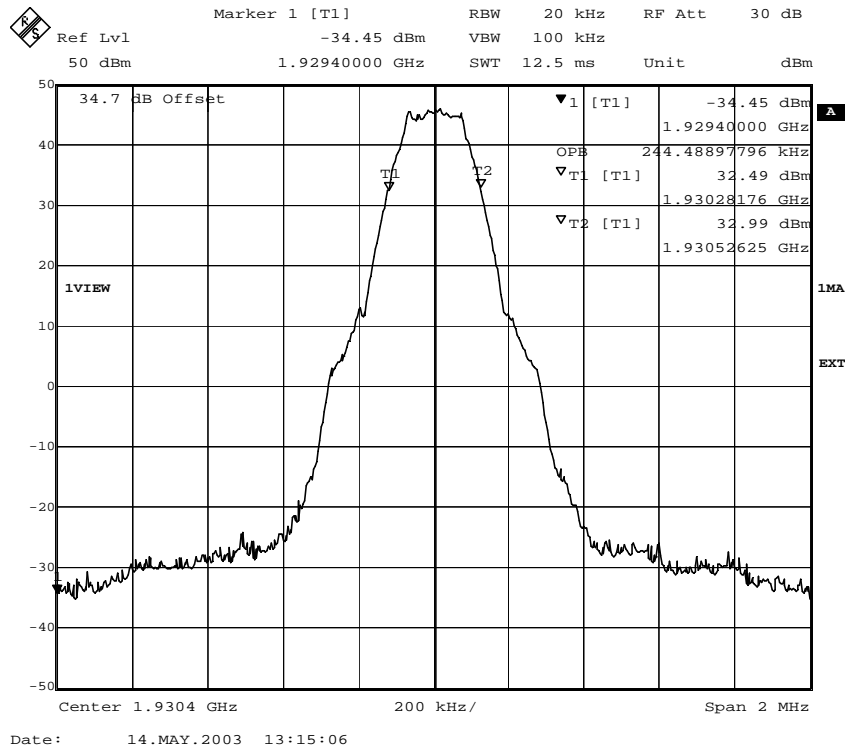

Fig. 28 – Occupied bandwidth (GMSK modulation).

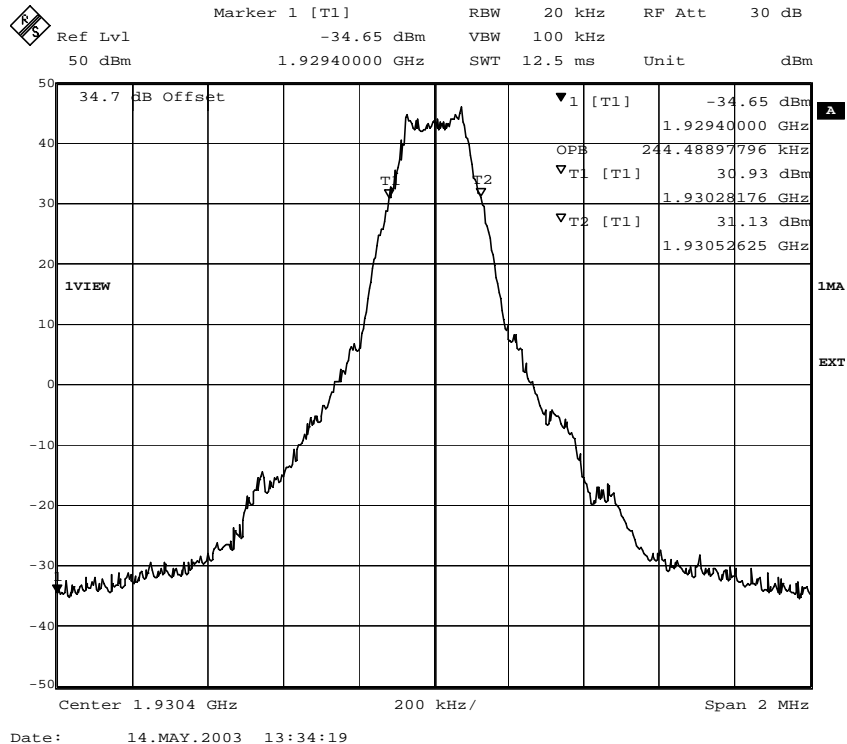

Fig. 29 – Occupied bandwidth (8PSK modulation).

Note: The external attenuation of 34.7 dB is included in the spectral plot. This accounts for the external attenuator and the cable loss during the testing.

Test No. 3: Occupied Bandwidth (Carrier Test Frequency = 1930.4 MHz)

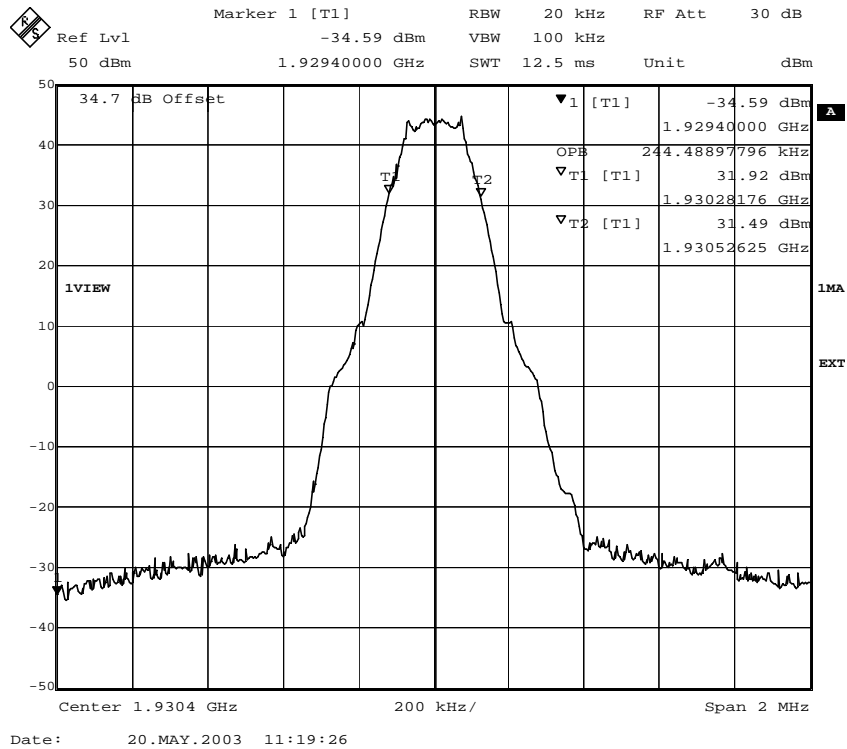

Fig. 30 – Occupied bandwidth (GMSK modulation) for ECUPV2.

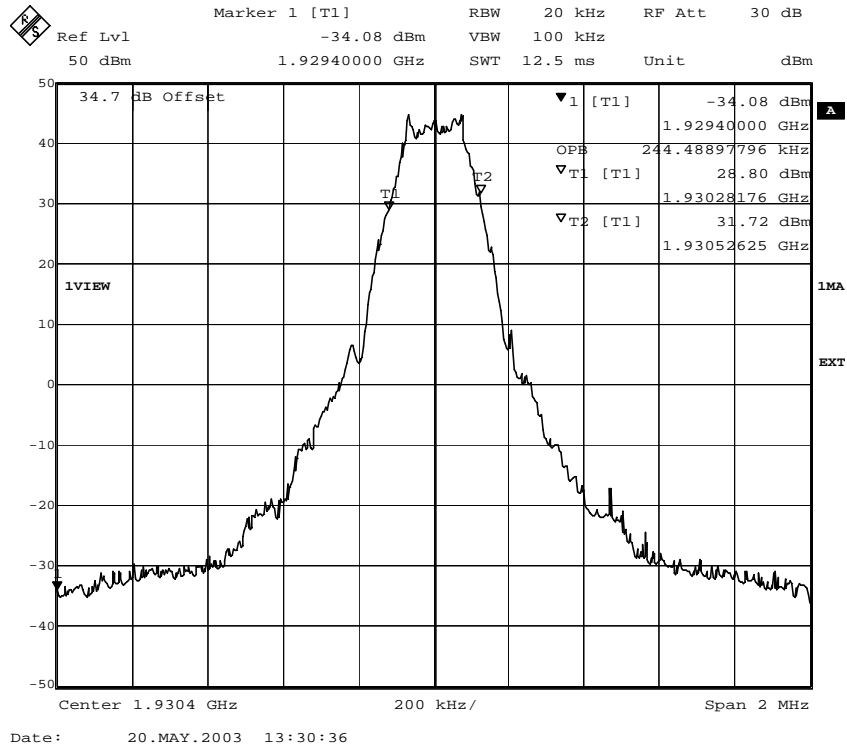

Fig. 31 – Occupied bandwidth (8PSK modulation) for ECUPV2.

Note: The external attenuation of 34.7 dB is included in the spectral plot. This accounts for the external attenuator and the cable loss during the testing.

Test No. 3: Occupied Bandwidth (Carrier Test Frequency = 1960.0 MHz)

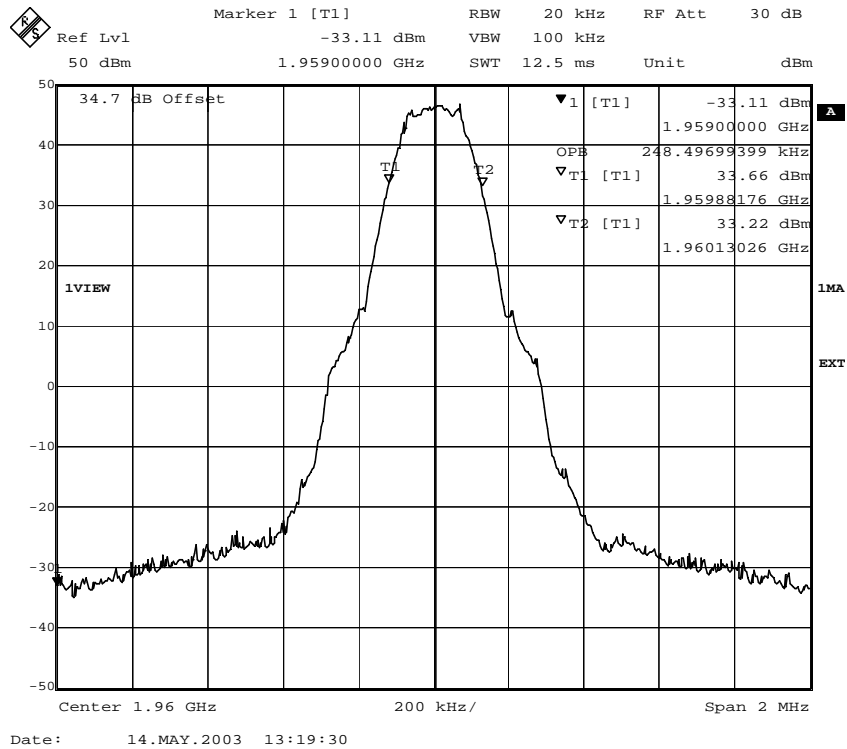

Fig. 32 – Occupied bandwidth (GMSK modulation).

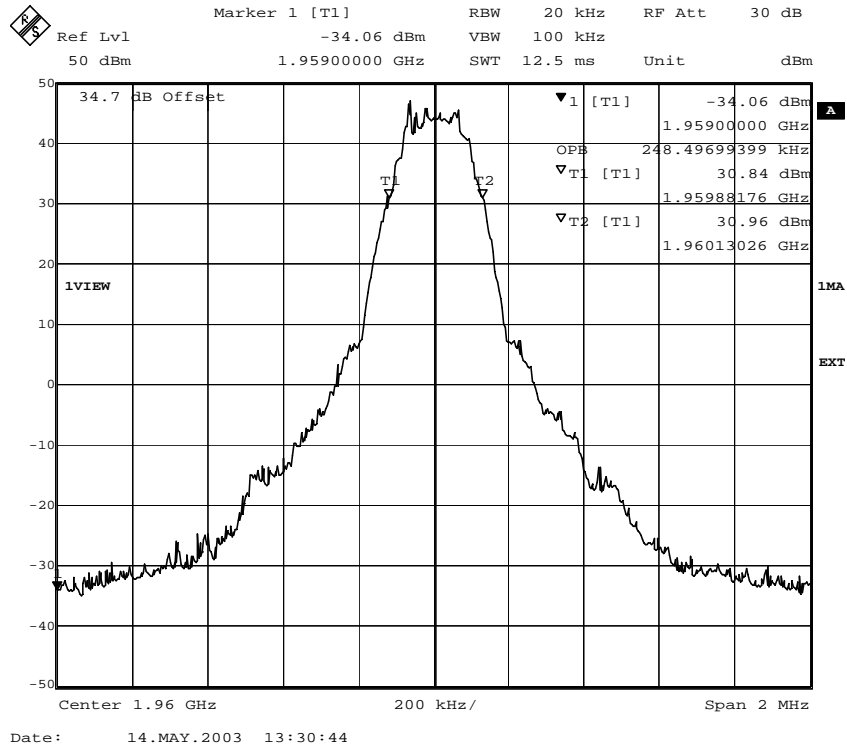

Fig. 33 – Occupied bandwidth (8PSK modulation).

Note: The external attenuation of 34.7 dB is included in the spectral plot. This accounts for the external attenuator and the cable loss during the testing.

Test No. 3: Occupied Bandwidth (Carrier Test Frequency = 1960.0 MHz)

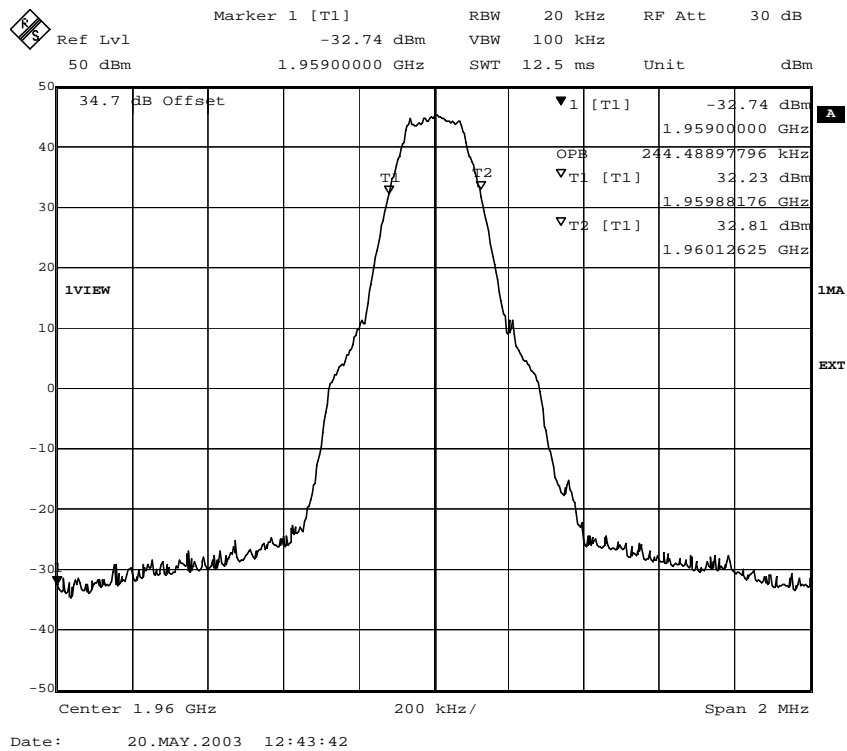

Fig. 34 – Occupied bandwidth (GMSK modulation) for ECUPV2.

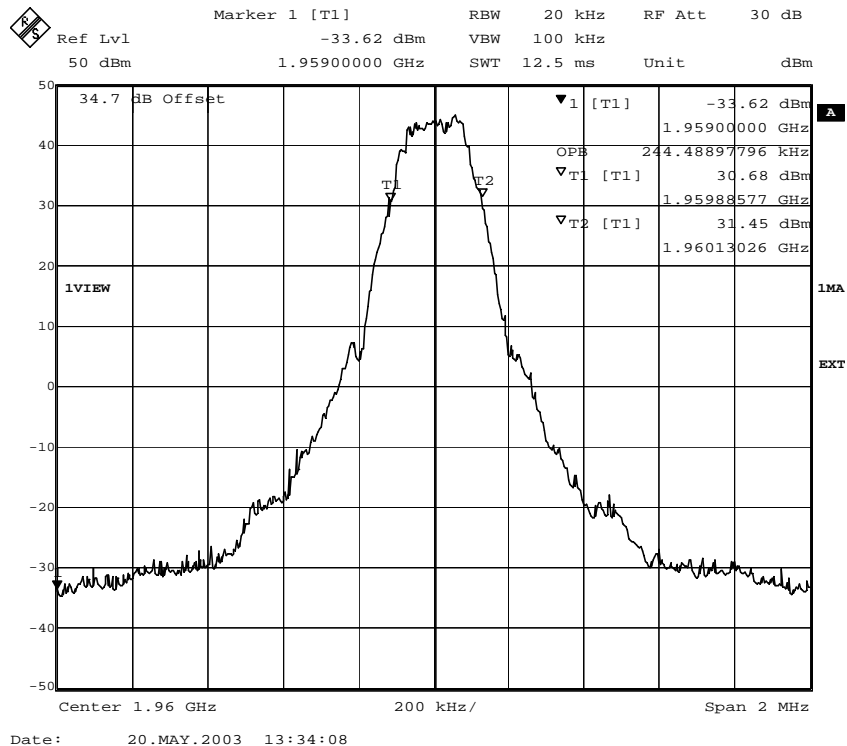

Fig. 35 – Occupied bandwidth (8PSK modulation) for ECUPV2.

Note: The external attenuation of 34.7 dB is included in the spectral plot. This accounts for the external attenuator and the cable loss during the testing.

Test No. 3: Occupied Bandwidth (Carrier Test Frequency = 1989.6 MHz)

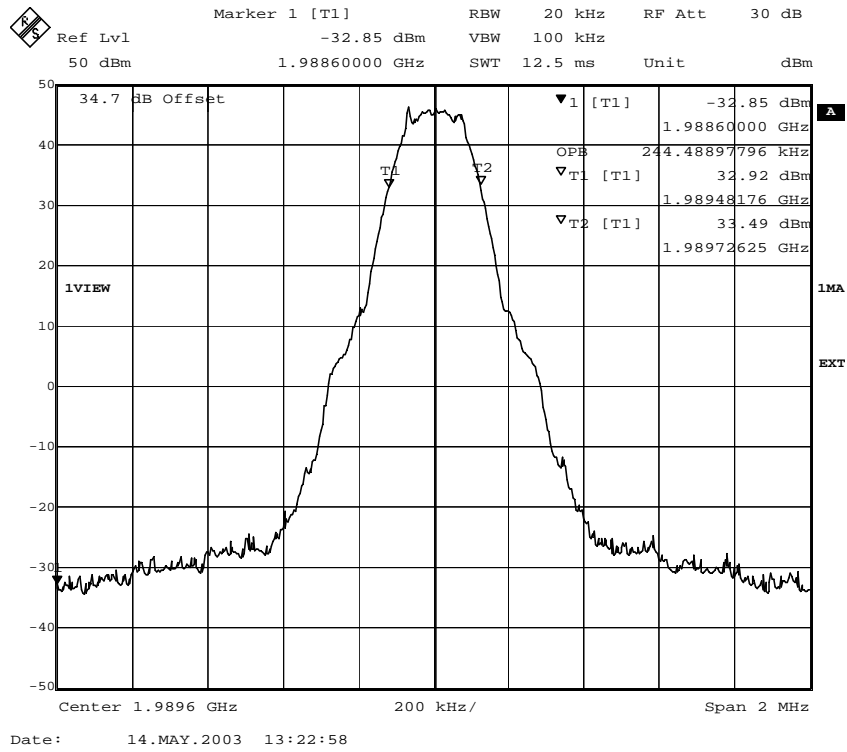

Fig. 36 – Occupied bandwidth (GMSK modulation).

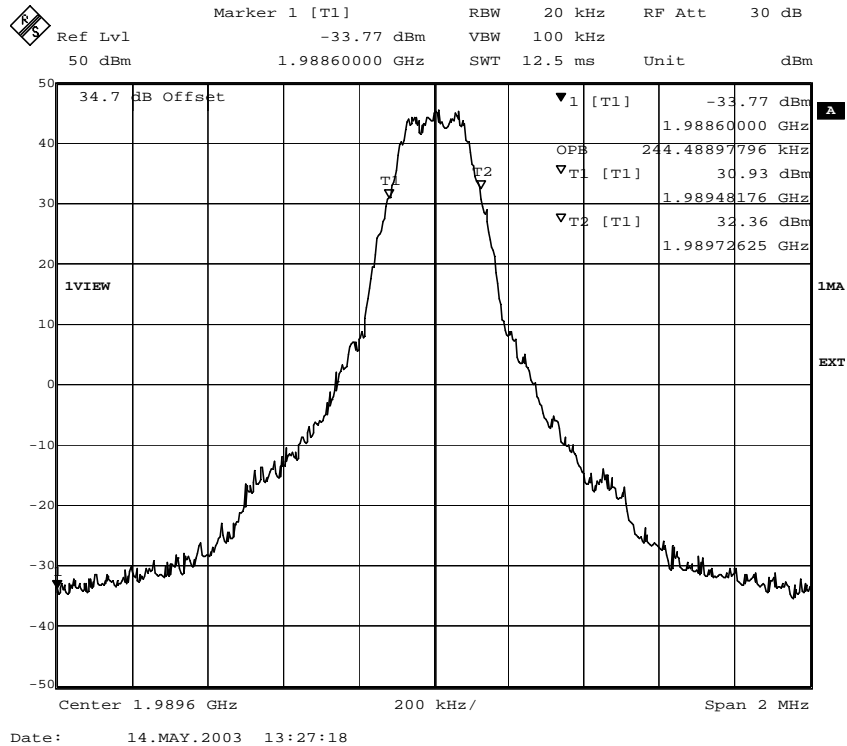

Fig. 37 – Occupied bandwidth (8PSK modulation).

Note: The external attenuation of 34.7 dB is included in the spectral plot. This accounts for the external attenuator and the cable loss during the testing.

Test No. 3: Occupied Bandwidth (Carrier Test Frequency = 1989.6 MHz)

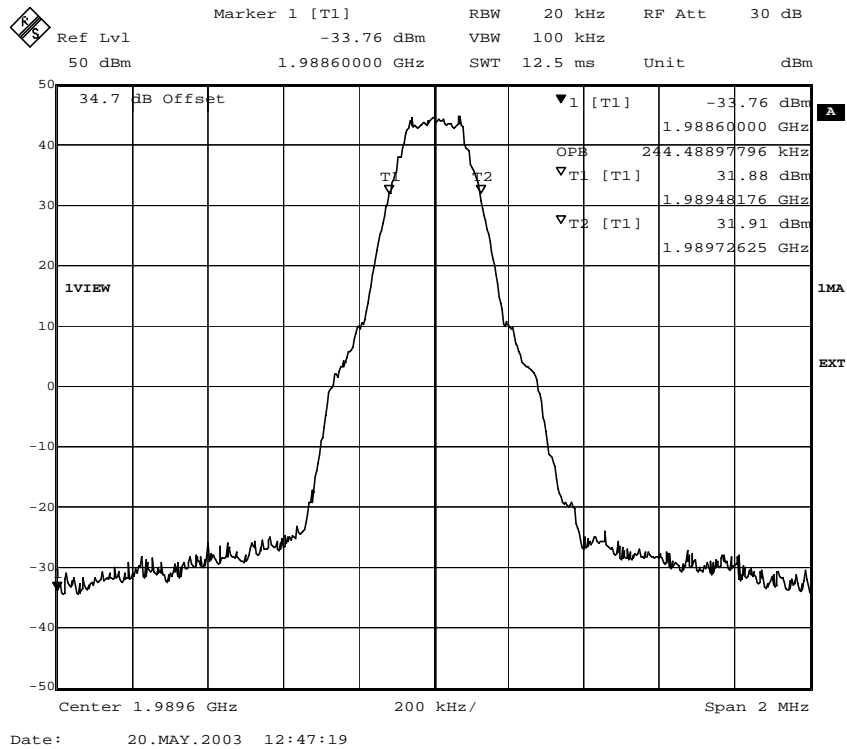

Fig. 38 – Occupied bandwidth (GMSK modulation) for ECUPV2.

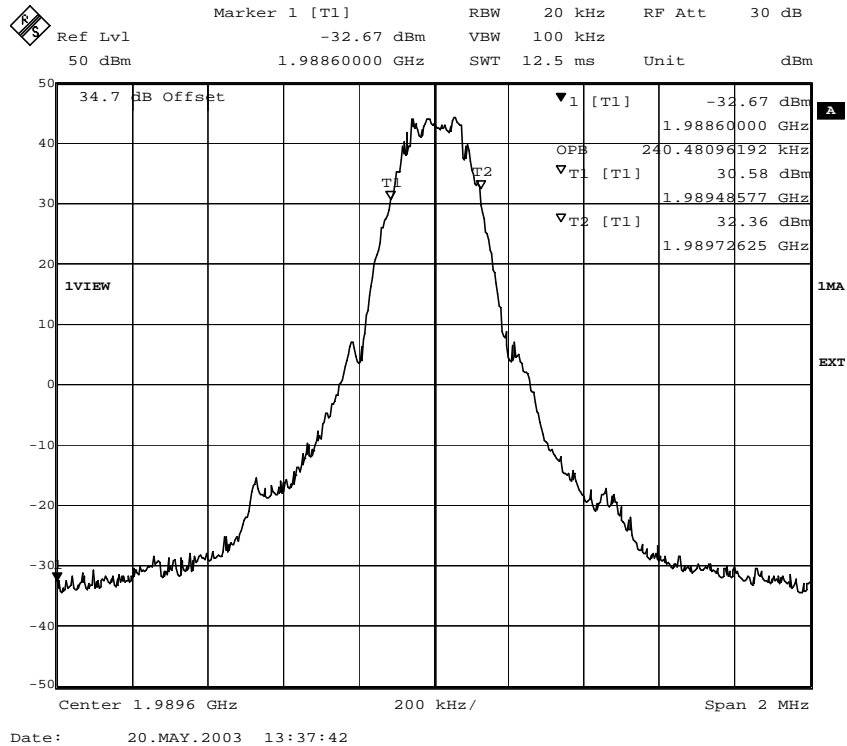

Fig. 39 – Occupied bandwidth (8PSK modulation) for ECUPV2.

Note: The external attenuation of 34.7 dB is included in the spectral plot. This accounts for the external attenuator and the cable loss during the testing.

Test No. 3: Occupied Bandwidth (Carrier Test Frequency = 1989.8 MHz)

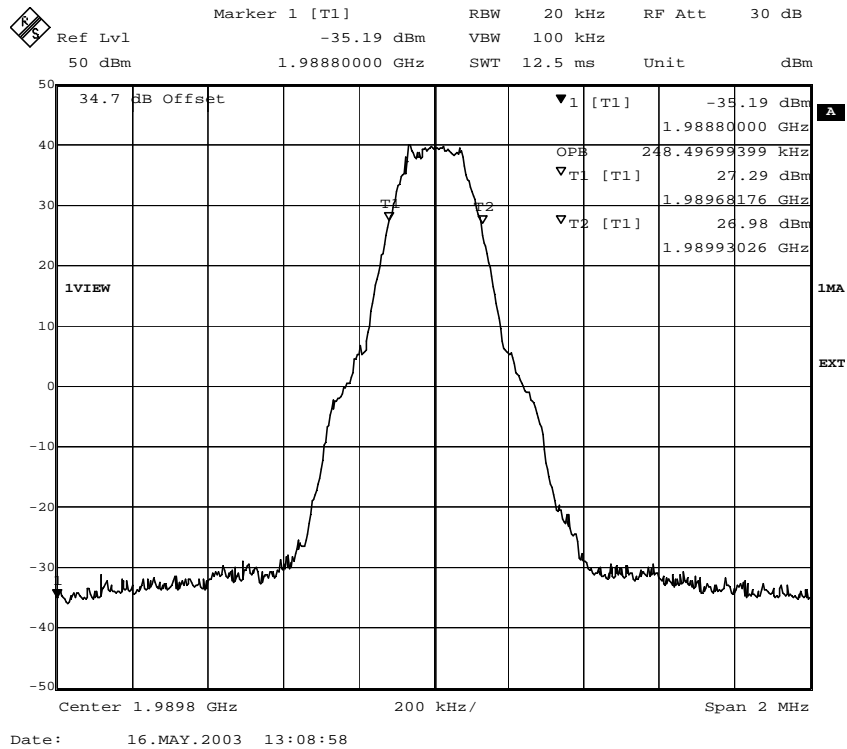

Fig. 40 – Occupied bandwidth (GMSK modulation).

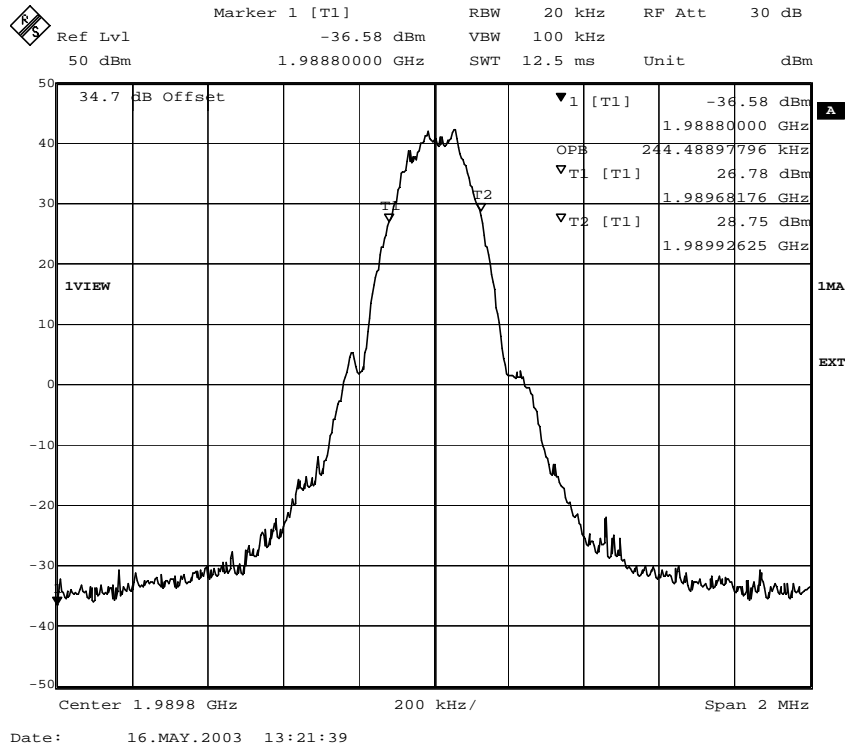

Fig. 41 – Occupied bandwidth (8PSK modulation).

Note: The external attenuation of 34.7 dB is included in the spectral plot. This accounts for the external attenuator and the cable loss during the testing.

Test No. 3: Occupied Bandwidth (Carrier Test Frequency = 1989.8 MHz)

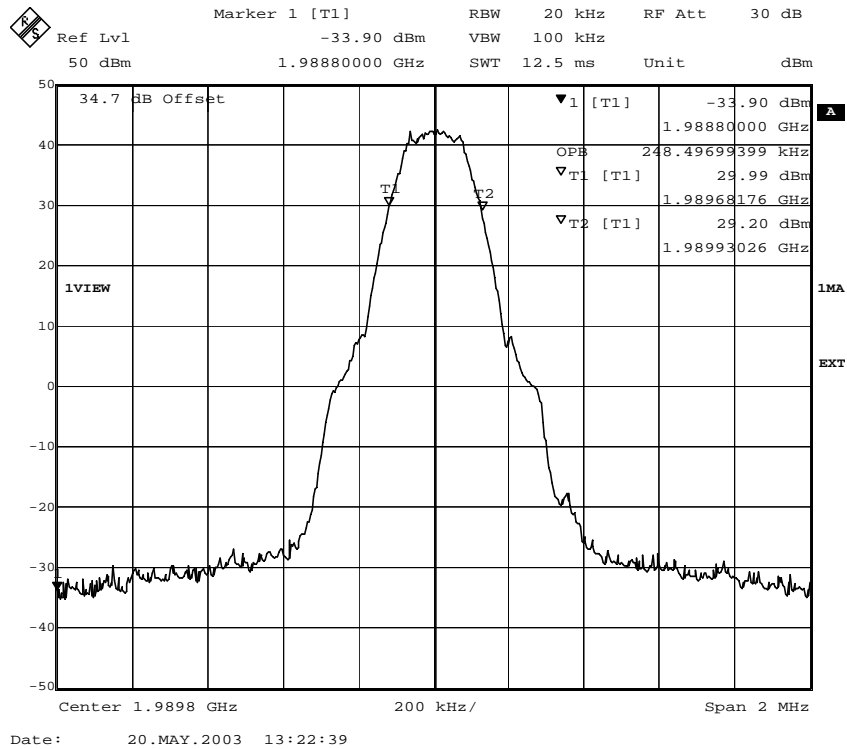

Fig. 42 – Occupied bandwidth (GMSK modulation) for ECUPV2.

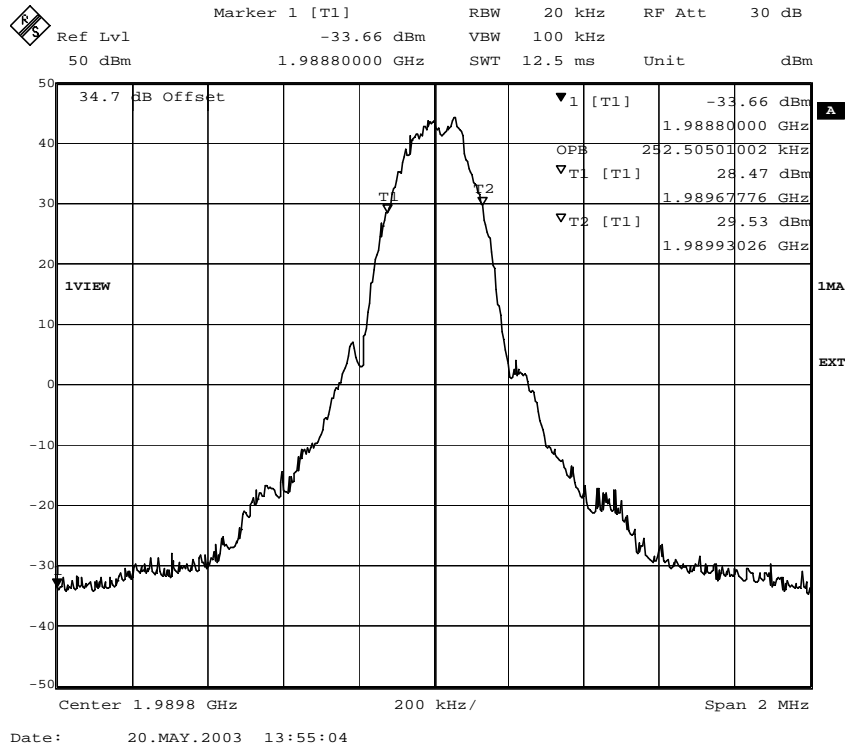

Fig. 43 – Occupied bandwidth (8PSK modulation) for ECUPV2.

Note: The external attenuation of 34.7 dB is included in the spectral plot. This accounts for the external attenuator and the cable loss during the testing.

**Test No. 4: Spurious Emissions at the Antenna Terminals
(Carrier Test Frequency = 1930.2 MHz)**

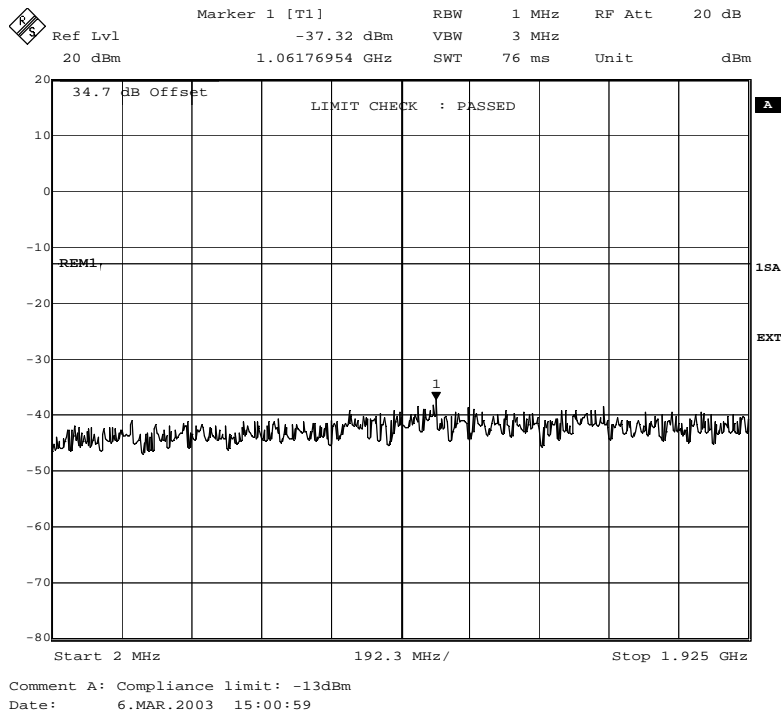

Fig. 44 – Spurious emissions in the frequency range 2 MHz – 1925 MHz (GMSK modulation).

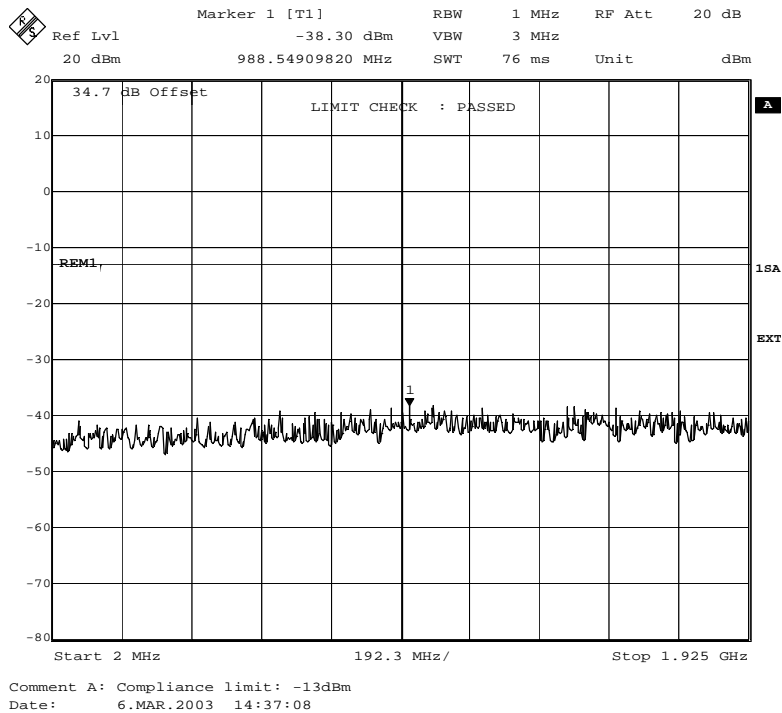
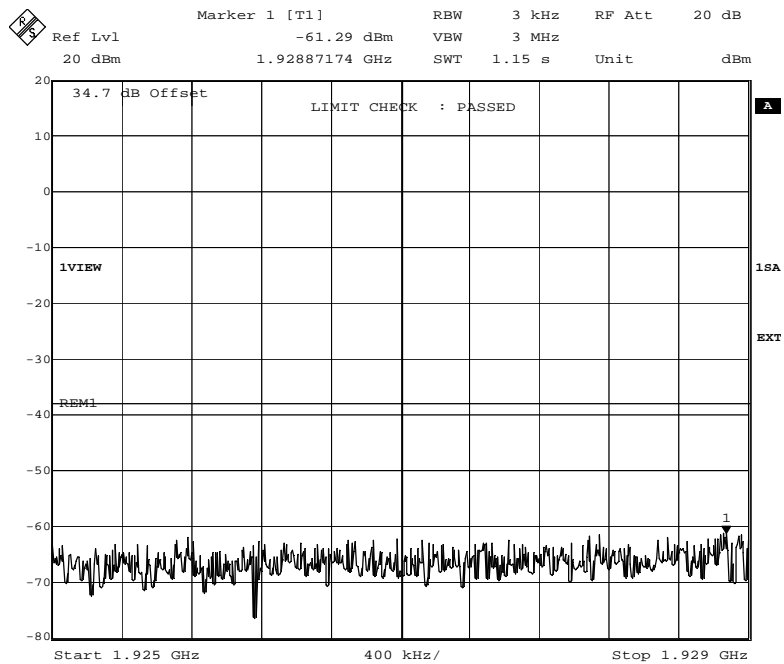

Fig. 45 – Spurious emissions in the frequency range 2 MHz – 1925 MHz (8PSK modulation).

Note: The external attenuation of 34.7 dB is included in the spectral plot. This accounts for the external attenuator and the cable loss during the testing.

**Test No. 4: Spurious Emissions at the Antenna Terminals
(Carrier Test Frequency = 1930.2 MHz)**



**Fig. 46 – Spurious emissions in the frequency range 1925 MHz–1929 MHz (GMSK modulation).
Limit: -13dBm–25.2dB=-38.2dBm**

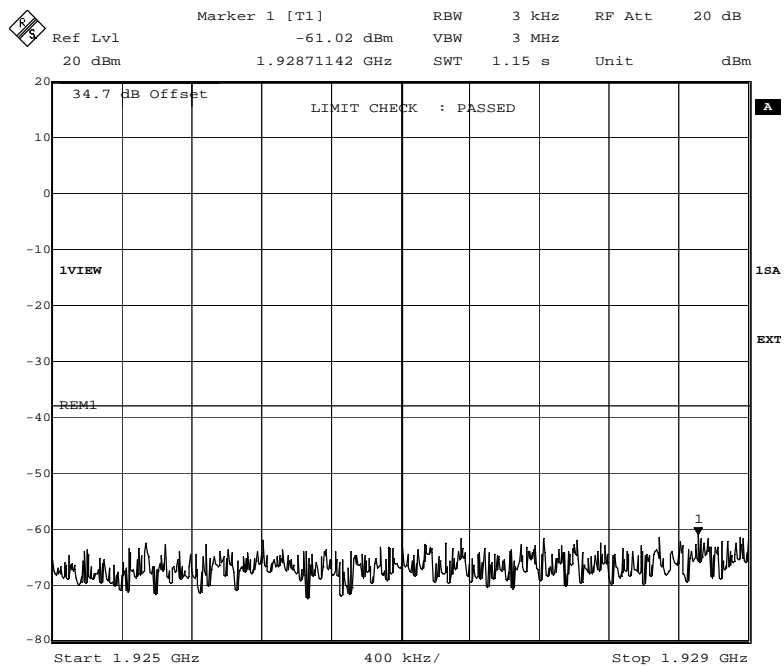

**Fig. 47 – Spurious emissions in the frequency range 1925 MHz–1929 MHz (8PSK modulation).
Limit: -13dBm–25.2dB=-38.2dBm**

Note: The external attenuation of 34.7 dB is included in the spectral plot. This accounts for the external attenuator and the cable loss during the testing.

Test No. 4: Spurious Emissions at the Antenna Terminals
(Carrier Test Frequency = 1930.2 MHz)

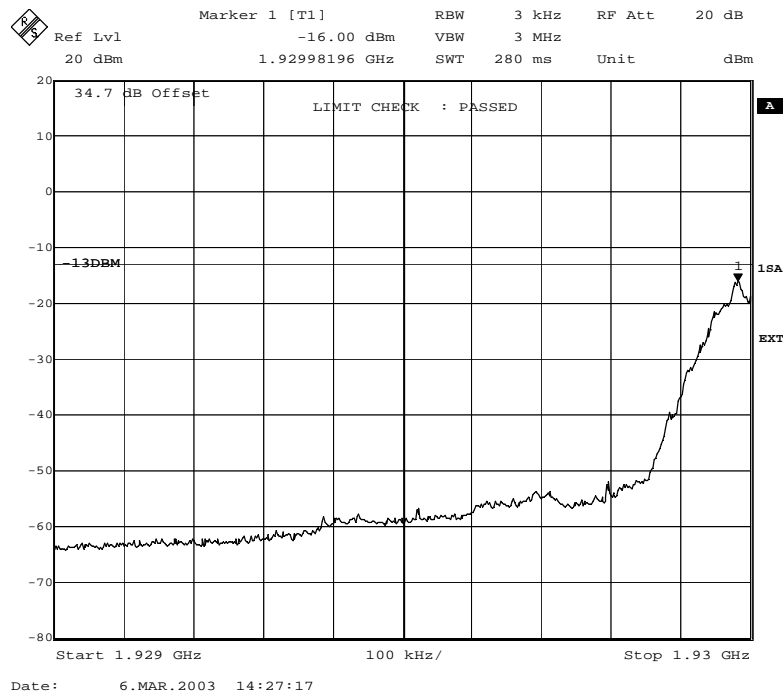

Fig. 48 – Spurious emissions in the frequency range 1929 MHz – 1930 MHz (GMSK modulation).

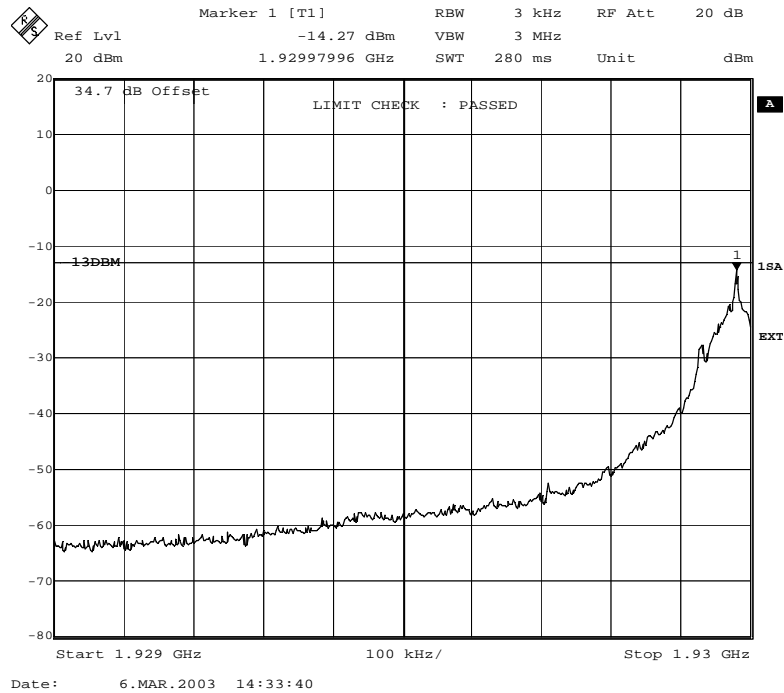

Fig. 49 – Spurious emissions in the frequency range 1929 MHz – 1930 MHz (8PSK modulation).

Note: The external attenuation of 34.7 dB is included in the spectral plot. This accounts for the external attenuator and the cable loss during the testing.

**Test No. 4: Spurious Emissions at the Antenna Terminals
(Carrier Test Frequency = 1930.2 MHz)**

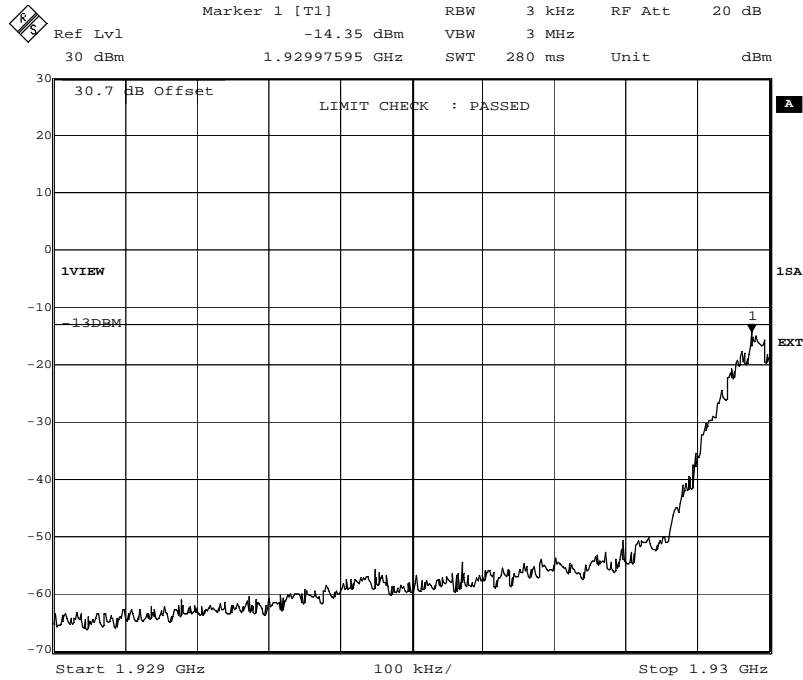

Fig. 50 – Spurious emissions in the frequency range 1929 MHz – 1930 MHz (GMSK modulation) for ECUPV2.

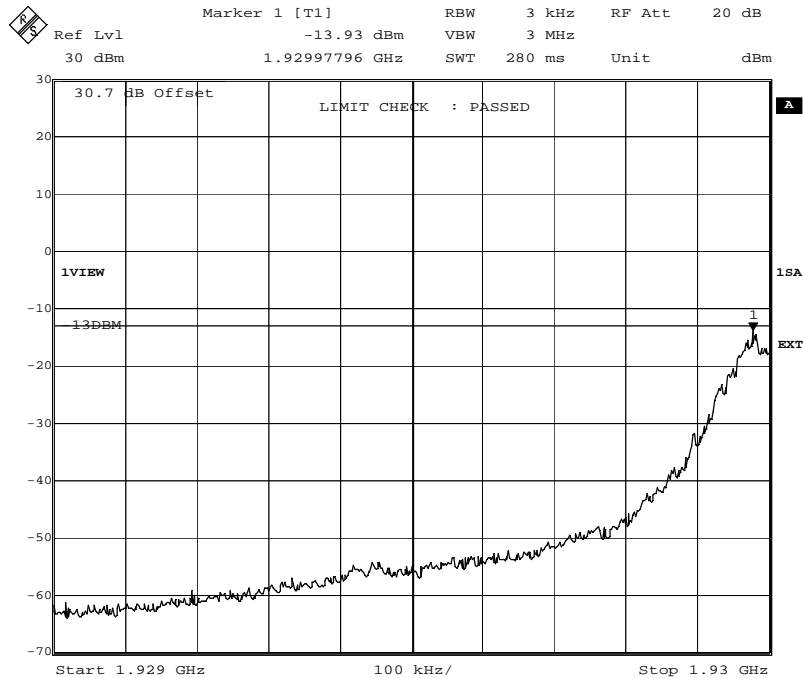

Fig. 51 – Spurious emissions in the frequency range 1929 MHz – 1930 MHz (8PSK modulation) for ECUPV2.

Note: The external attenuation of 30.7 dB is included in the spectral plot. This accounts for the external attenuator and the cable loss during the testing.

**Test No. 4: Spurious Emissions at the Antenna Terminals
(Carrier Test Frequency = 1930.2 MHz)**

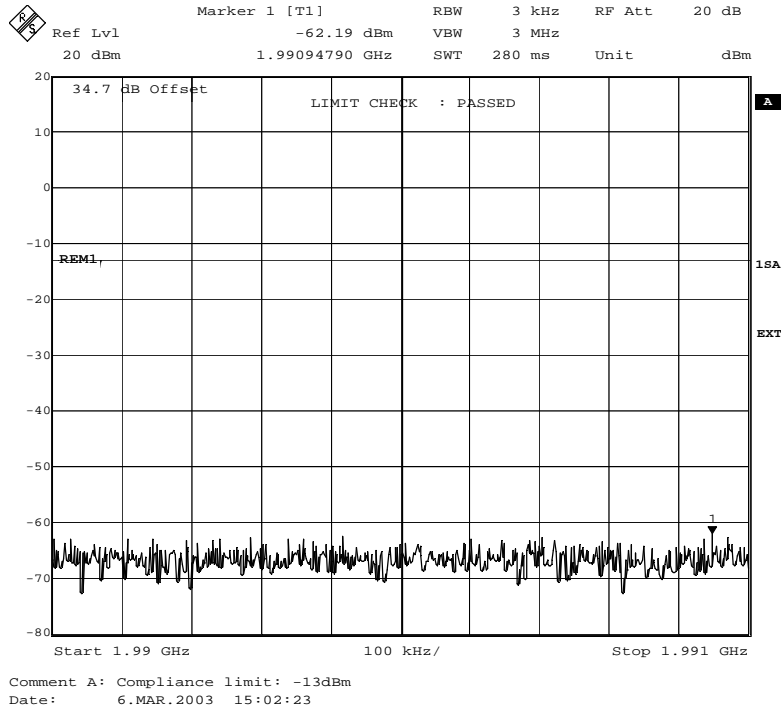

Fig. 52 – Spurious emissions in the frequency range 1990 MHz – 1991 MHz (GMSK modulation).

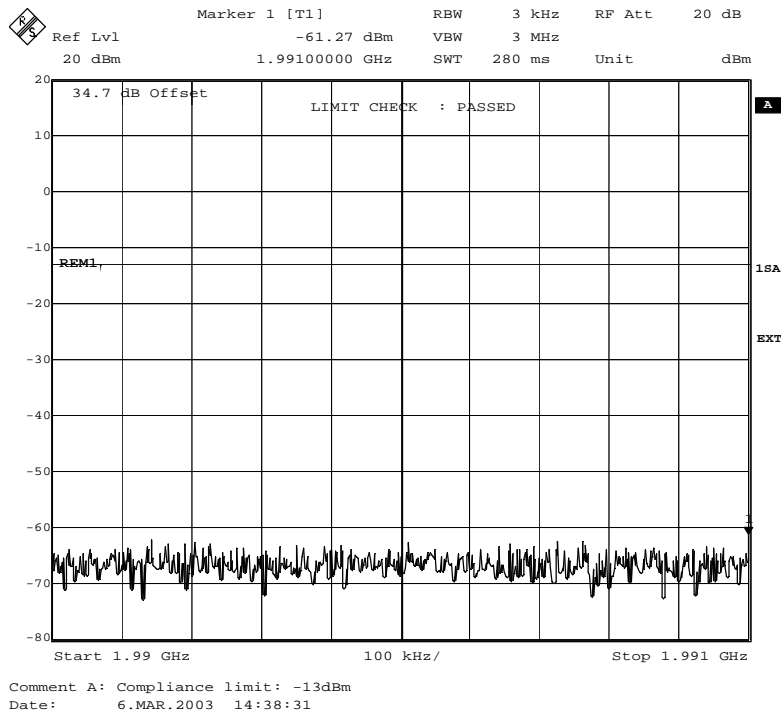
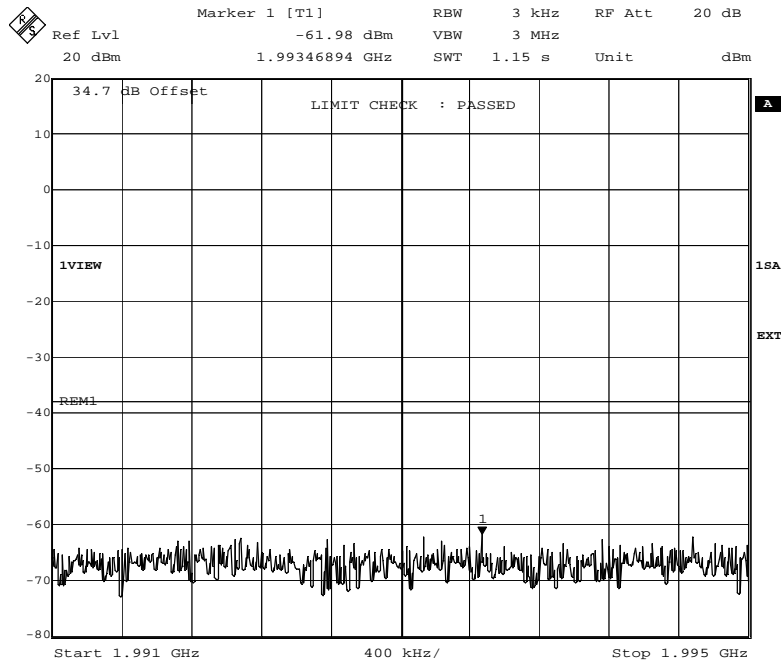

Fig. 53 – Spurious emissions in the frequency range 1990 MHz – 1991 MHz (8PSK modulation).

Note: The external attenuation of 34.7 dB is included in the spectral plot. This accounts for the external attenuator and the cable loss during the testing.

**Test No. 4: Spurious Emissions at the Antenna Terminals
(Carrier Test Frequency = 1930.2 MHz)**



**Fig. 54 – Spurious emissions in the frequency range 1991 MHz – 1995 MHz (GMSK modulation).
Limit: -13dBm-25.2dB=-38.2dBm**

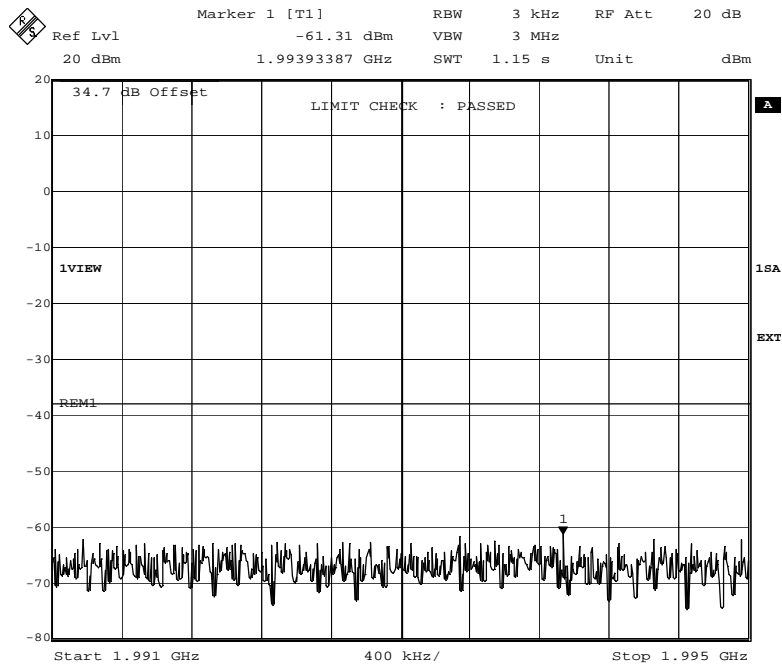

**Fig. 55 – Spurious emissions in the frequency range 1991 MHz – 1995 MHz (8PSK modulation).
Limit: -13dBm-25.2dB=-38.2dBm**

Note: The external attenuation of 34.7 dB is included in the spectral plot. This accounts for the external attenuator and the cable loss during the testing.

**Test No. 4: Spurious Emissions at the Antenna Terminals
(Carrier Test Frequency = 1930.2 MHz)**

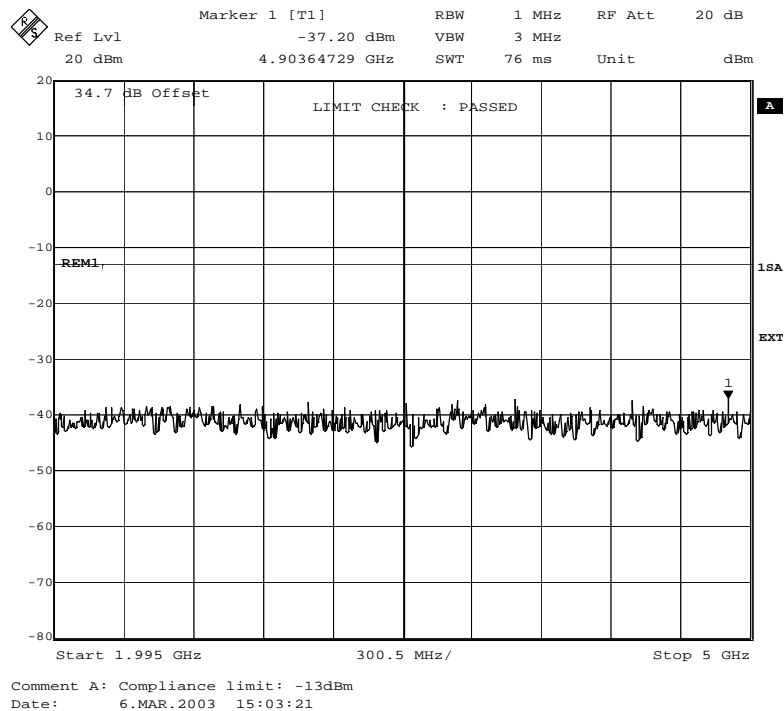

Fig. 56 – Spurious emissions in the frequency range 1995 MHz – 5000 MHz (GMSK modulation).

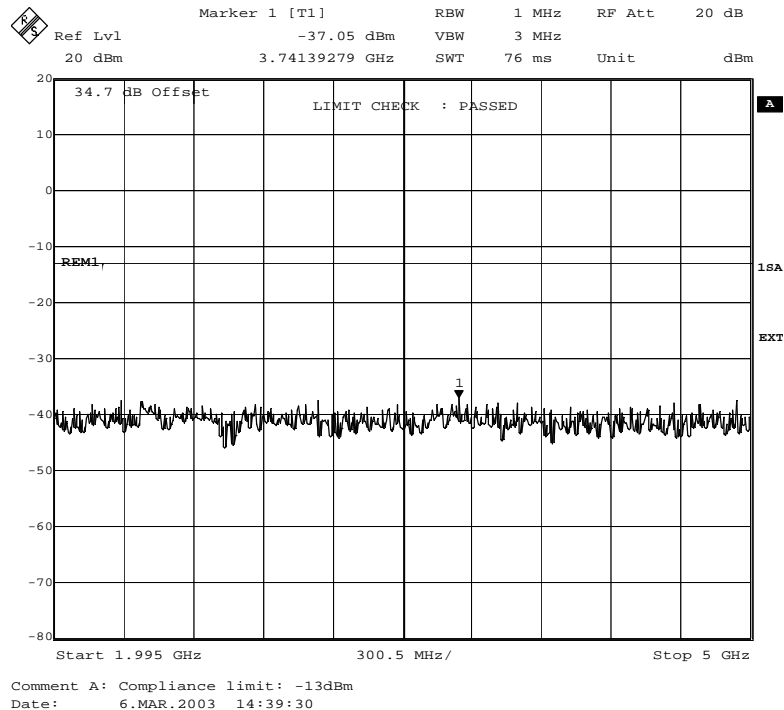

Fig. 57 – Spurious emissions in the frequency range 1995 MHz – 5000 MHz (8PSK modulation).

Note: The external attenuation of 34.7 dB is included in the spectral plot. This accounts for the external attenuator and the cable loss during the testing.

**Test No. 4: Spurious Emissions at the Antenna Terminals
(Carrier Test Frequency = 1930.2 MHz)**

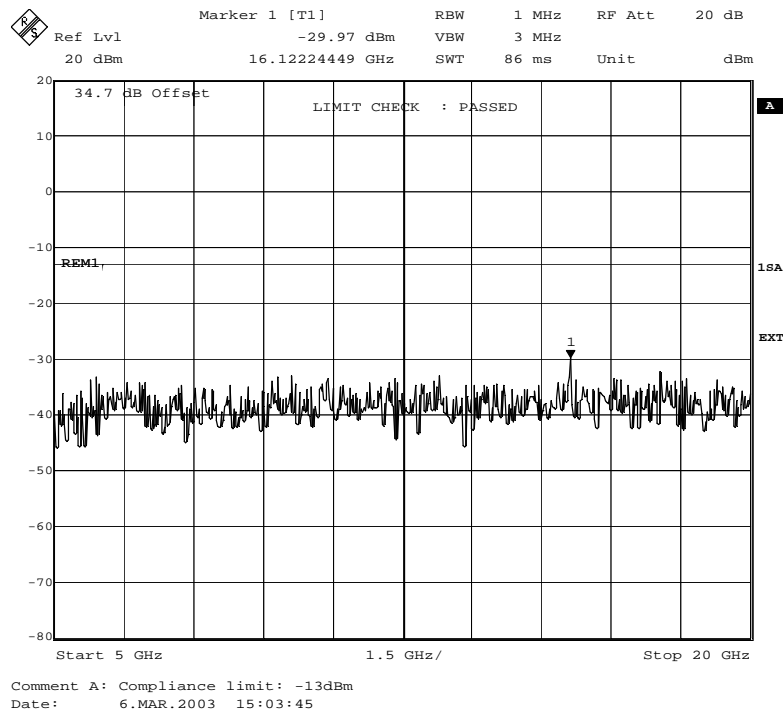

Fig. 58 – Spurious emissions in the frequency range 5000 MHz–20000 MHz (GMSK modulation).

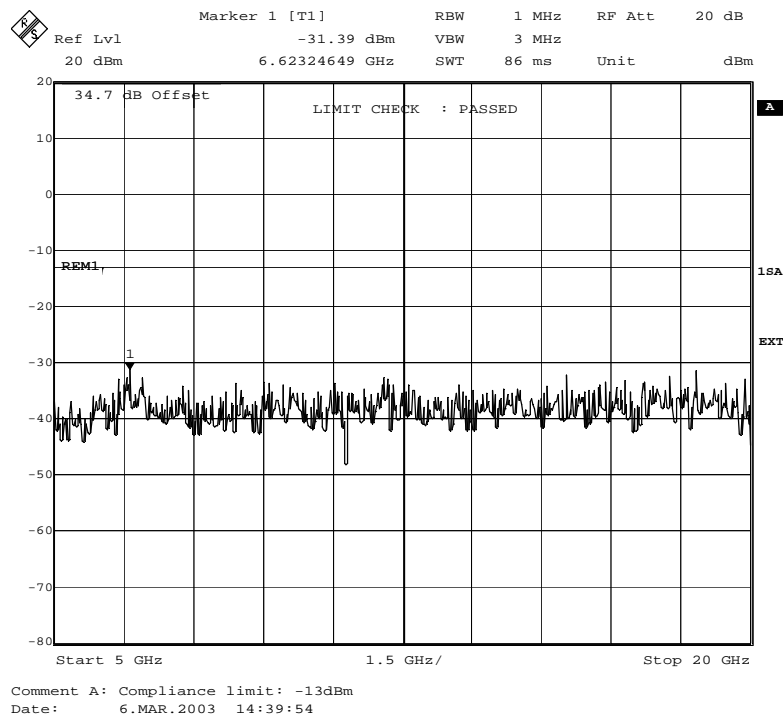

Fig. 59 – Spurious emissions in the frequency range 5000 MHz–20000 MHz (8PSK modulation).

Note: The external attenuation of 34.7 dB is included in the spectral plot. This accounts for the external attenuator and the cable loss during the testing.

**Test No. 4: Spurious Emissions at the Antenna Terminals
(Carrier Test Frequency = 1960.0 MHz)**

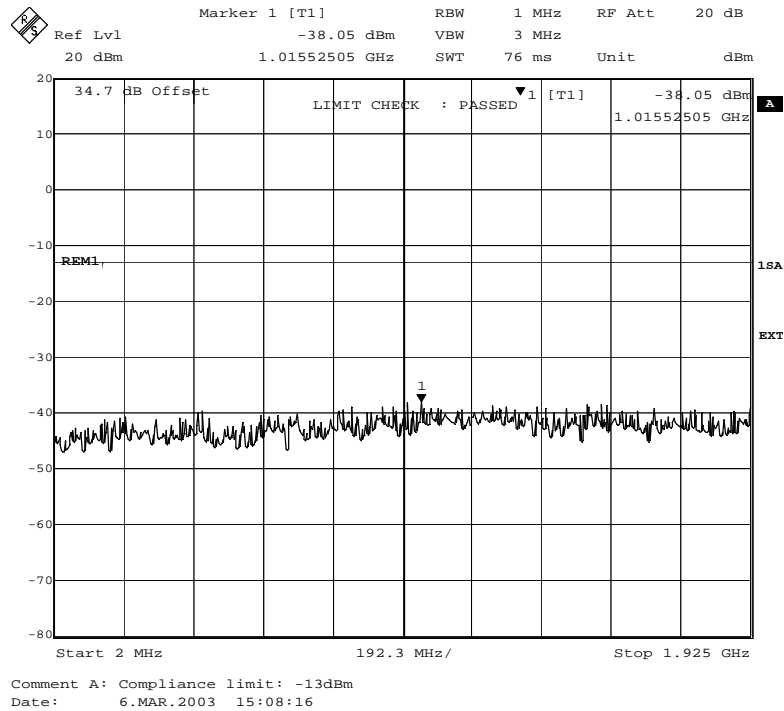

Fig. 60 – Spurious emissions in the frequency range 2 MHz – 1925 MHz (GMSK modulation).

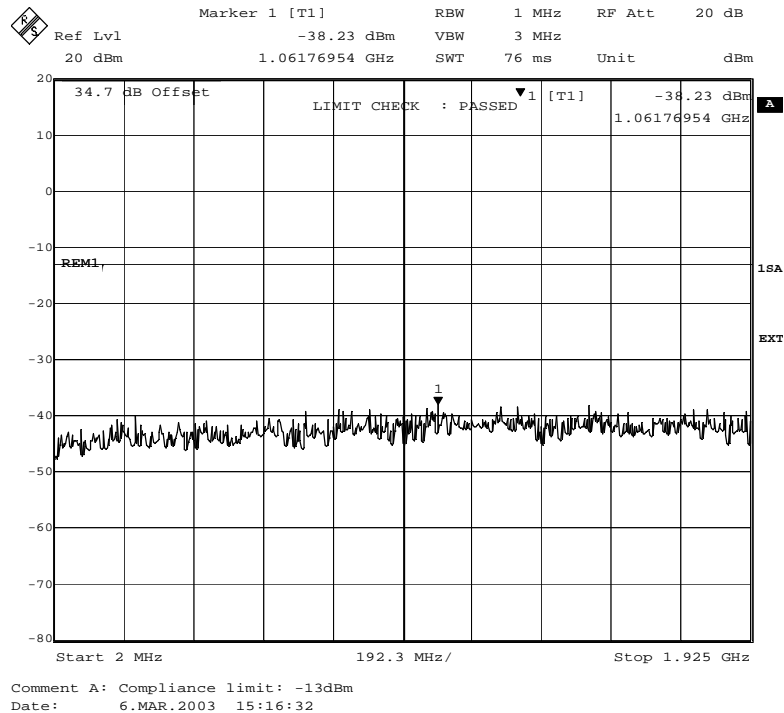

Fig. 61 – Spurious emissions in the frequency range 2 MHz – 1925 MHz (8PSK modulation).

Note: The external attenuation of 34.7 dB is included in the spectral plot. This accounts for the external attenuator and the cable loss during the testing.

Test No. 4: Spurious Emissions at the Antenna Terminals
(Carrier Test Frequency = 1960.0 MHz)

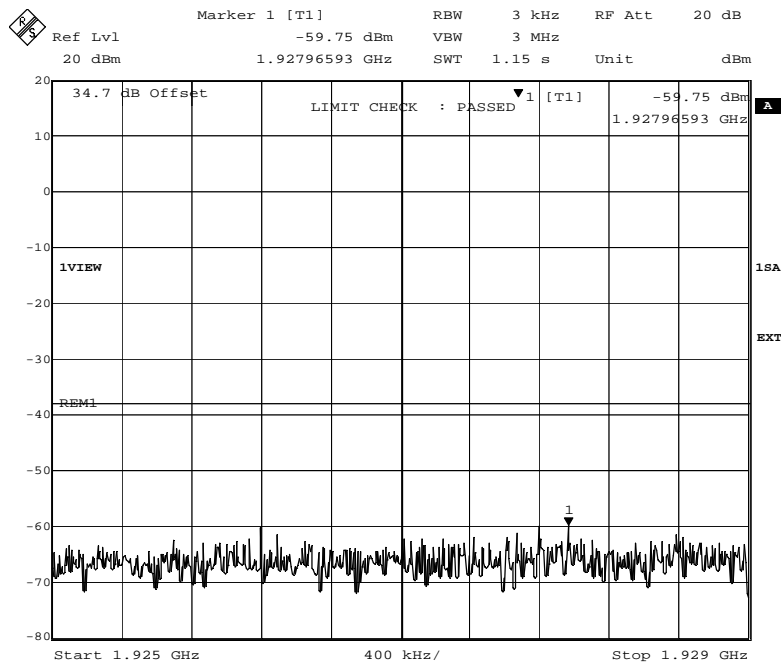

Fig. 62 – Spurious emissions in the frequency range 1925 MHz–1929 MHz (GMSK modulation).
Limit: -13dBm–25.2dB=-38.2dBm

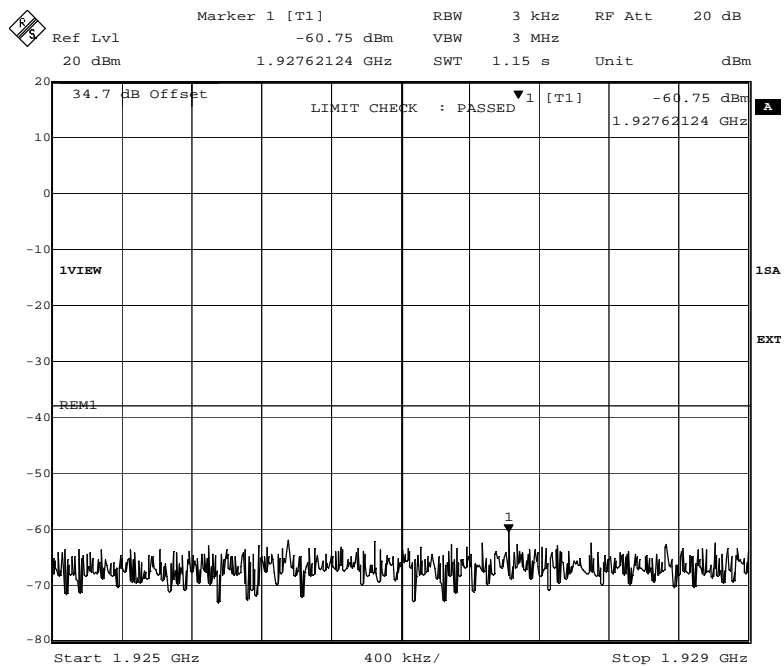

Fig. 63 – Spurious emissions in the frequency range 1925 MHz–1929 MHz (8PSK modulation).
Limit: -13dBm–25.2dB=-38.2dBm

Note: The external attenuation of 34.7 dB is included in the spectral plot. This accounts for the external attenuator and the cable loss during the testing.

**Test No. 4: Spurious Emissions at the Antenna Terminals
(Carrier Test Frequency = 1960.0 MHz)**

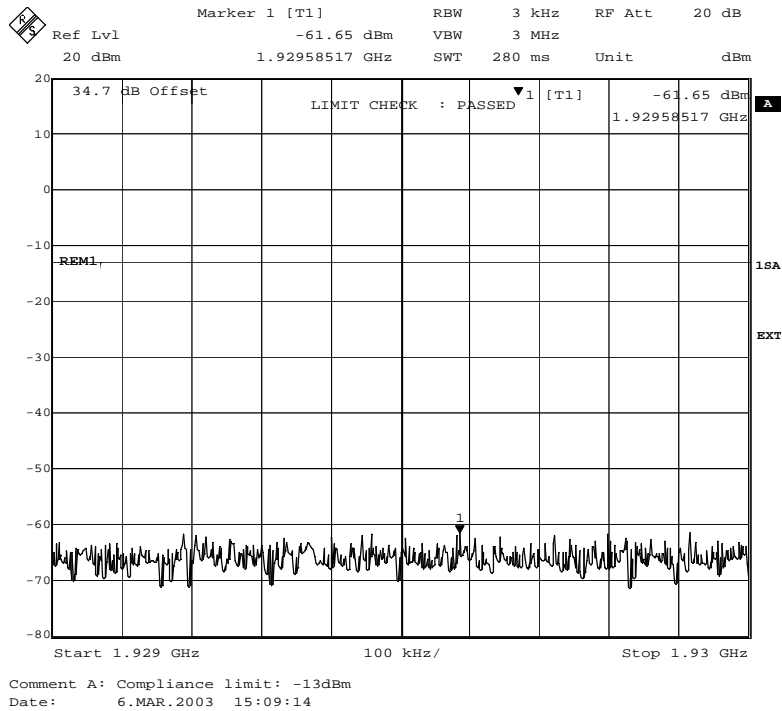

Fig. 64 – Spurious emissions in the frequency range 1929 MHz – 1930 MHz (GMSK modulation).

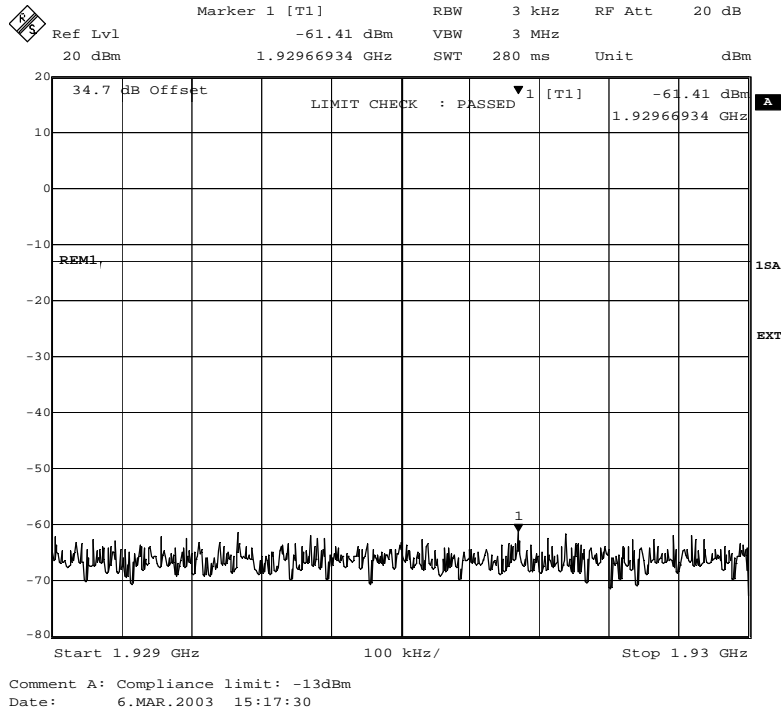

Fig. 65 – Spurious emissions in the frequency range 1929 MHz – 1930 MHz (8PSK modulation).

Note: The external attenuation of 34.7 dB is included in the spectral plot. This accounts for the external attenuator and the cable loss during the testing.

**Test No. 4: Spurious Emissions at the Antenna Terminals
(Carrier Test Frequency = 1960.0 MHz)**

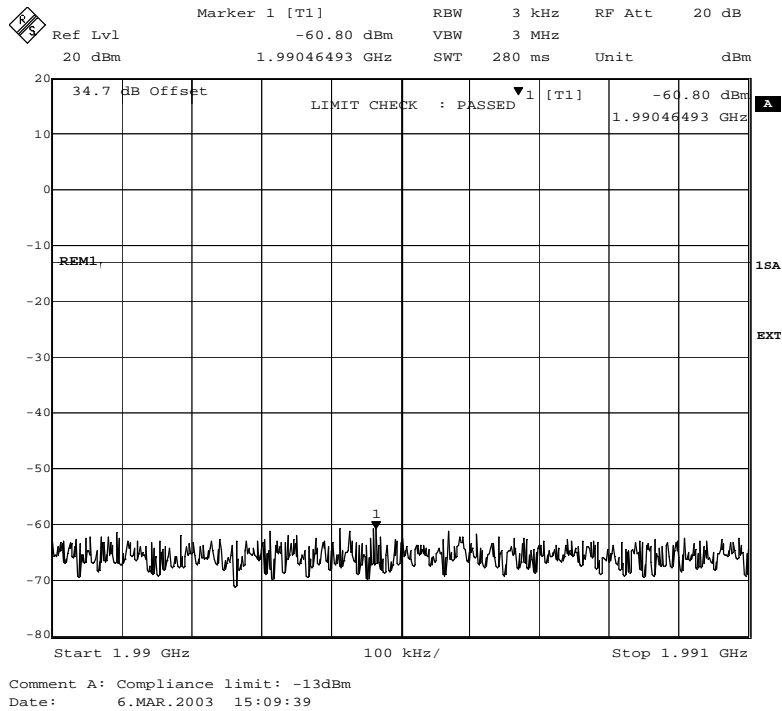

Fig. 66 – Spurious emissions in the frequency range 1990 MHz – 1991 MHz (GMSK modulation).

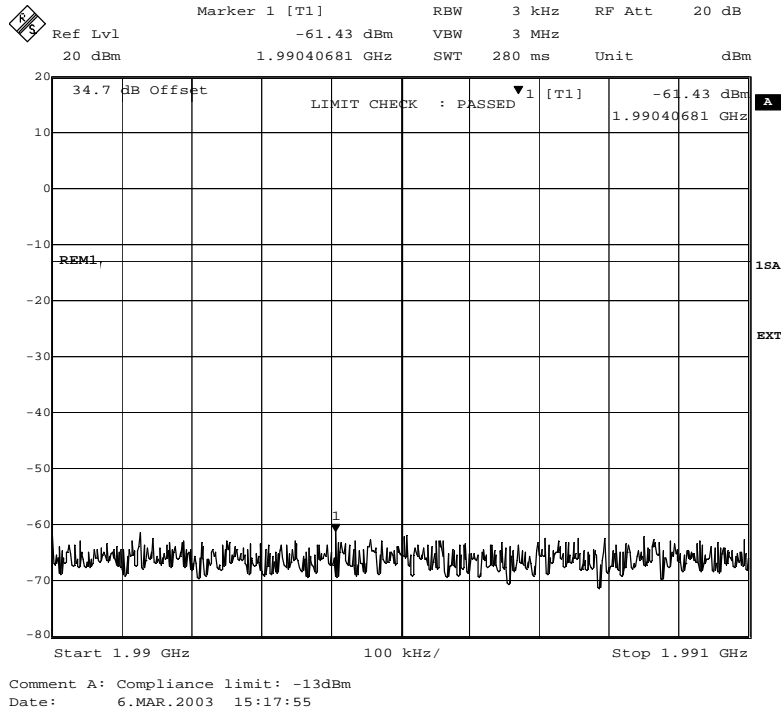
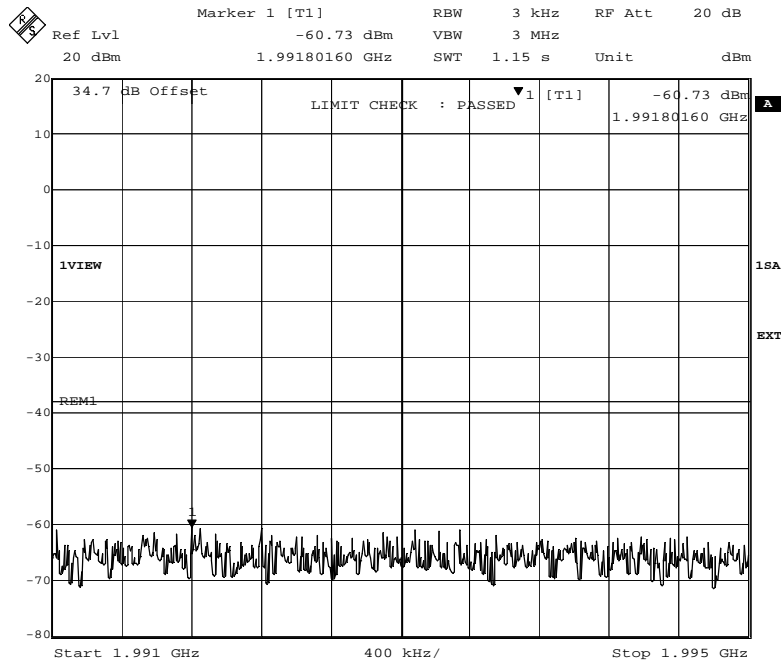

Fig. 67 – Spurious emissions in the frequency range 1990 MHz – 1991 MHz (8PSK modulation).

Note: The external attenuation of 34.7 dB is included in the spectral plot. This accounts for the external attenuator and the cable loss during the testing.

**Test No. 4: Spurious Emissions at the Antenna Terminals
(Carrier Test Frequency = 1960.0 MHz)**



**Fig. 68 – Spurious emissions in the frequency range 1991 MHz – 1995 MHz (GMSK modulation).
Limit: -13dBm-25.2dB=-38.2dBm**

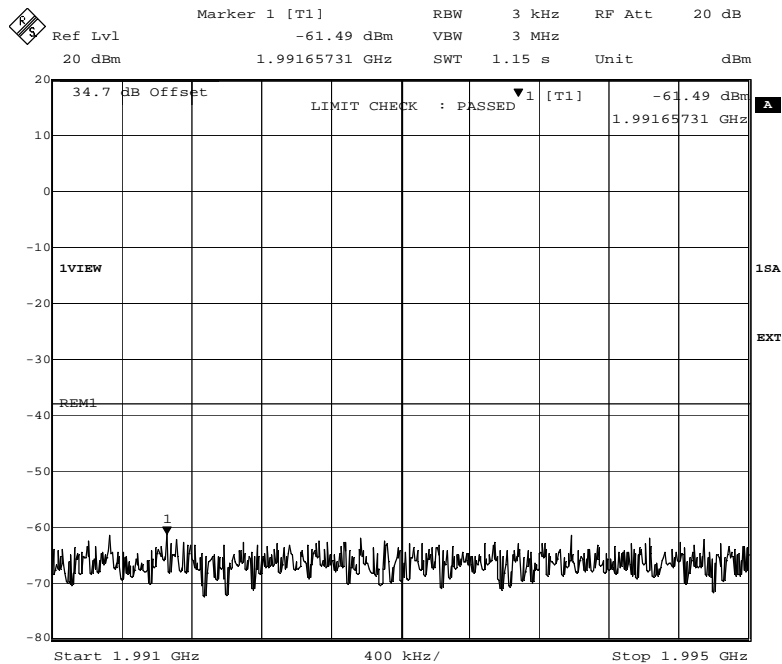

**Fig. 69 – Spurious emissions in the frequency range 1991 MHz – 1995 MHz (8PSK modulation).
Limit: -13dBm-25.2dB=-38.2dBm**

Note: The external attenuation of 34.7 dB is included in the spectral plot. This accounts for the external attenuator and the cable loss during the testing.

**Test No. 4: Spurious Emissions at the Antenna Terminals
(Carrier Test Frequency = 1960.0 MHz)**

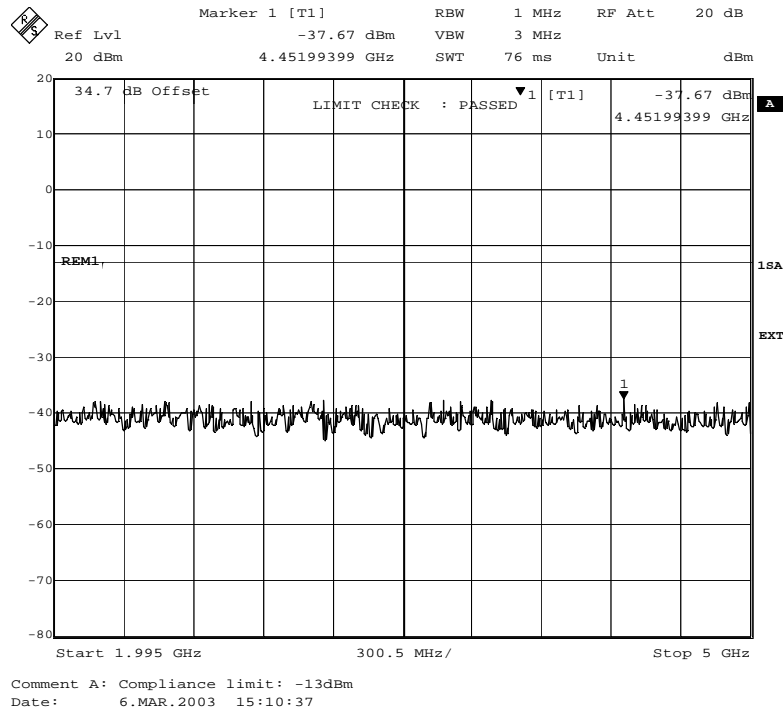

Fig. 70 – Spurious emissions in the frequency range 1995 MHz – 5000 MHz (GMSK modulation).

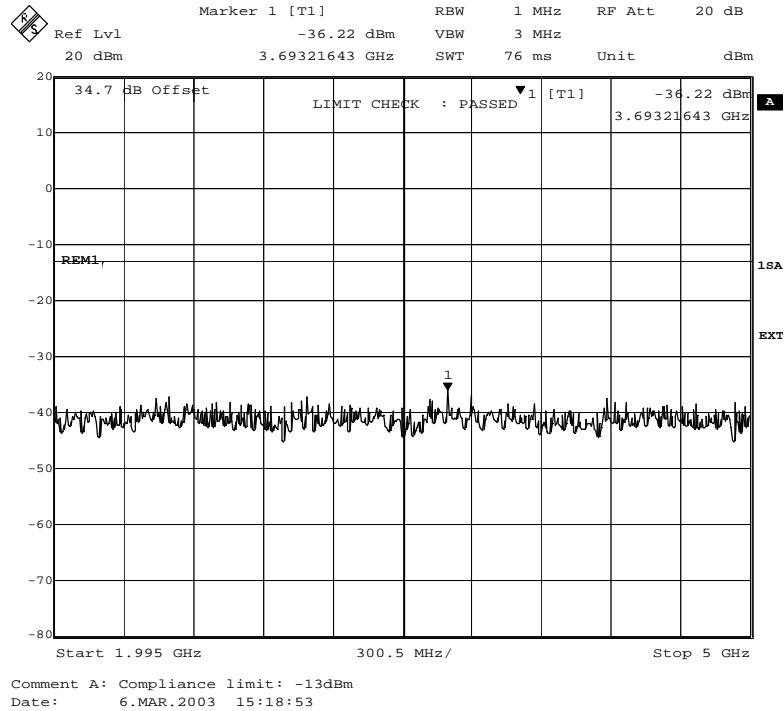

Fig. 71 – Spurious emissions in the frequency range 1995 MHz – 5000 MHz (8PSK modulation).

Note: The external attenuation of 34.7 dB is included in the spectral plot. This accounts for the external attenuator and the cable loss during the testing.

**Test No. 4: Spurious Emissions at the Antenna Terminals
(Carrier Test Frequency = 1960.0 MHz)**

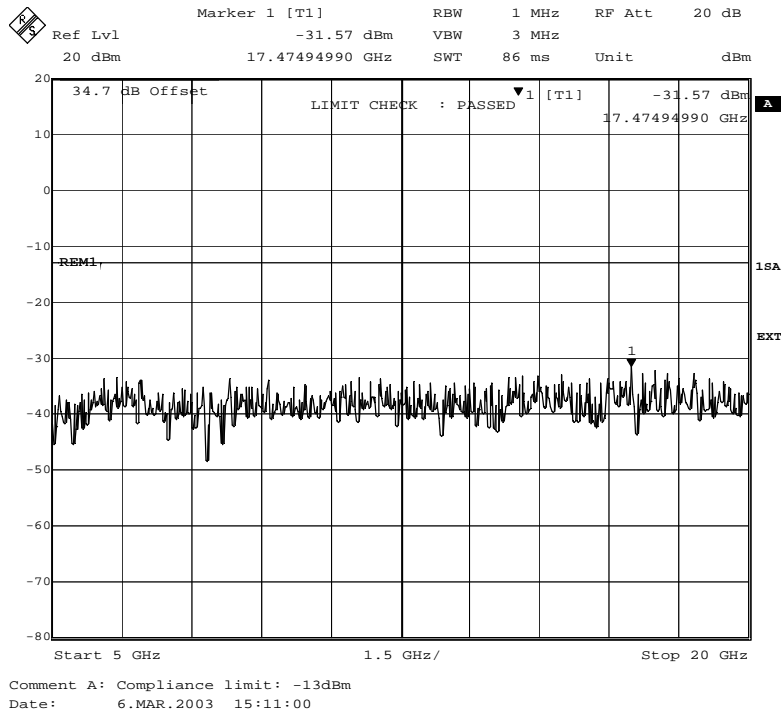

Fig. 72 – Spurious emissions in the frequency range 5000 MHz–20000 MHz (GMSK modulation).

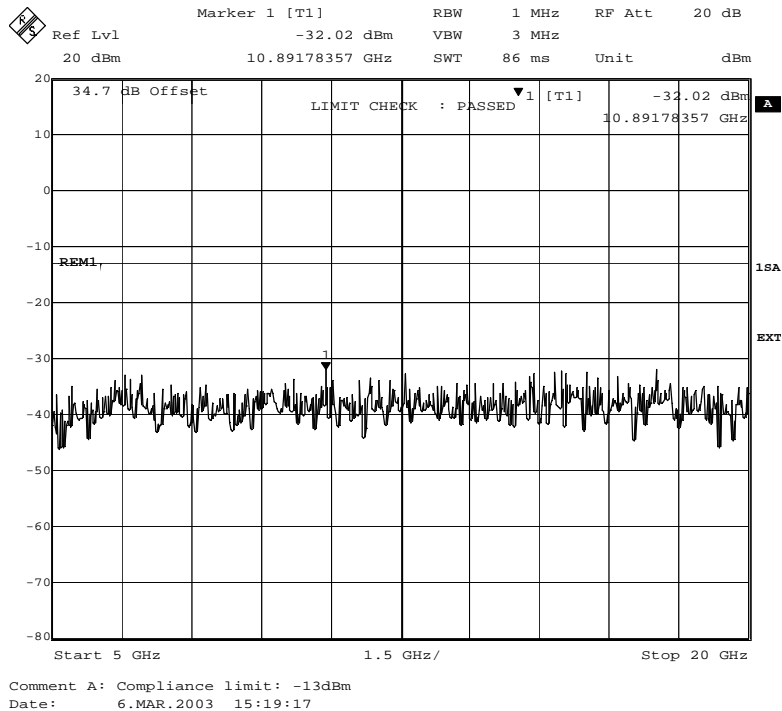

Fig. 73 – Spurious emissions in the frequency range 5000 MHz–20000 MHz (8PSK modulation).

Note: The external attenuation of 34.7 dB is included in the spectral plot. This accounts for the external attenuator and the cable loss during the testing.

**Test No. 4: Spurious Emissions at the Antenna Terminals
(Carrier Test Frequency = 1989.8 MHz)**

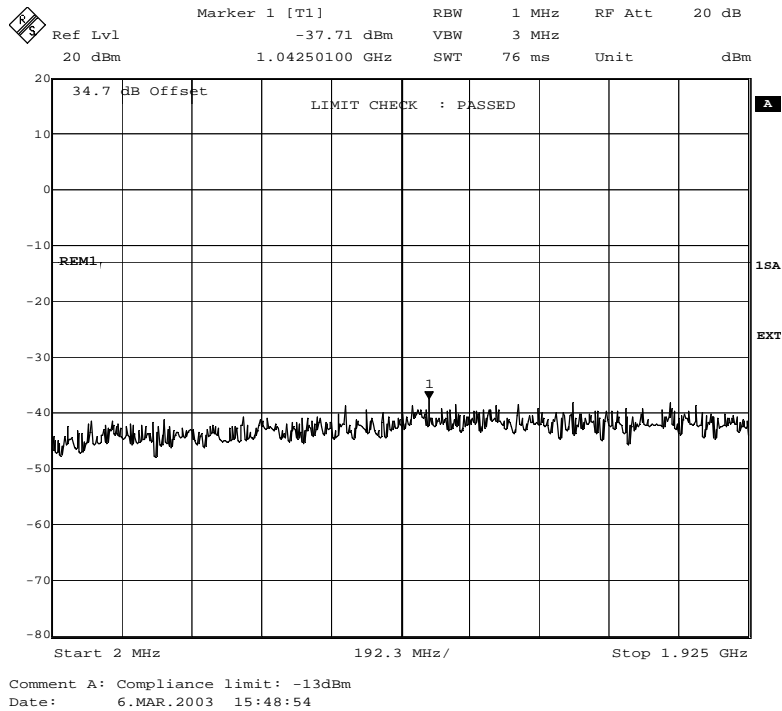

Fig. 74 – Spurious emissions in the frequency range 2 MHz – 1925 MHz (GMSK modulation).

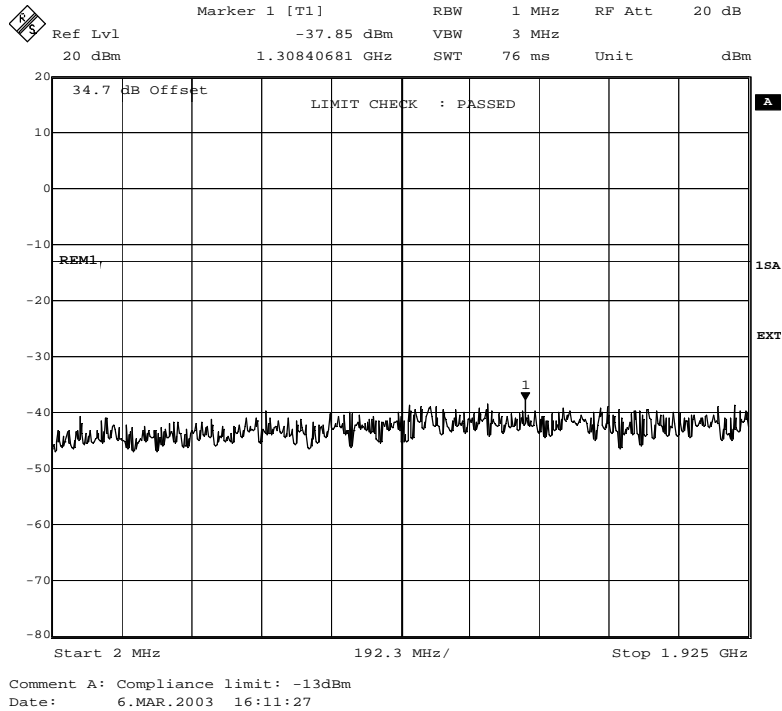
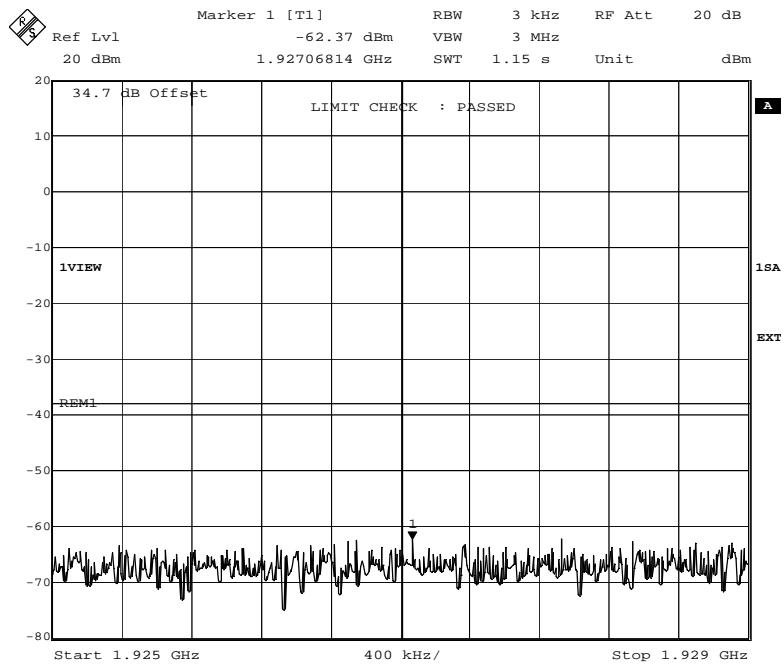

Fig. 75 – Spurious emissions in the frequency range 2 MHz – 1925 MHz (8PSK modulation).

Note: The external attenuation of 34.7 dB is included in the spectral plot. This accounts for the external attenuator and the cable loss during the testing.

**Test No. 4: Spurious Emissions at the Antenna Terminals
(Carrier Test Frequency = 1989.8 MHz)**



**Fig. 76 – Spurious emissions in the frequency range 1925 MHz – 1929 MHz (GMSK modulation).
Limit: -13dBm-25.2dB=-38.2dBm**

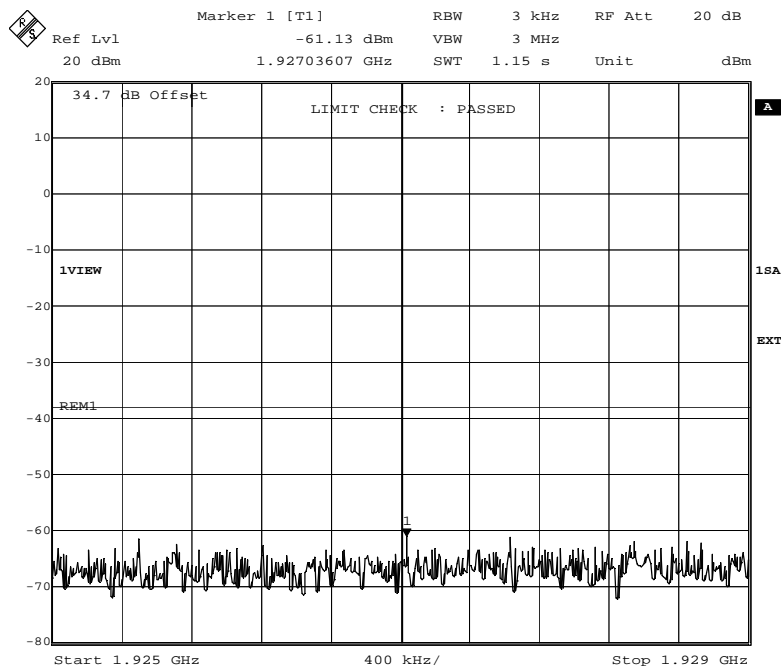

**Fig. 77 – Spurious emissions in the frequency range 1925 MHz – 1929 MHz (8PSK modulation).
Limit: -13dBm-25.2dB=-38.2dBm**

Note: The external attenuation of 34.7 dB is included in the spectral plot. This accounts for the external attenuator and the cable loss during the testing.

**Test No. 4: Spurious Emissions at the Antenna Terminals
(Carrier Test Frequency = 1989.8 MHz)**

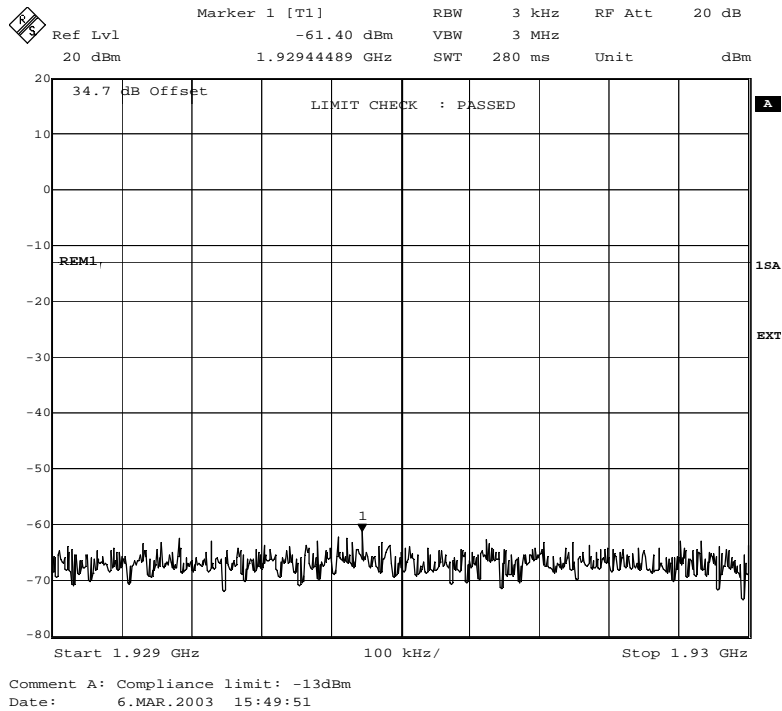

Fig. 78 – Spurious emissions in the frequency range 1929 MHz – 1930 MHz (GMSK modulation).

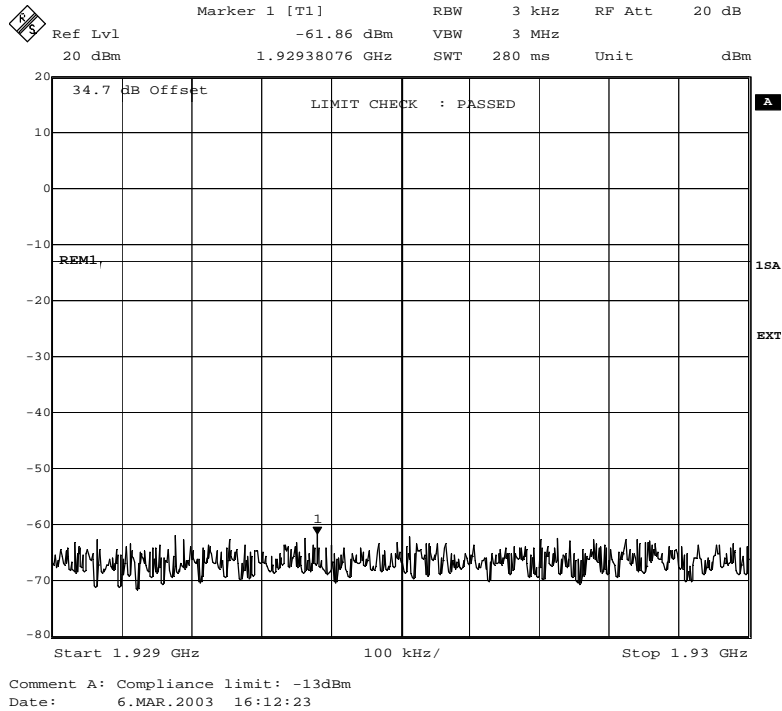

Fig. 79 – Spurious emissions in the frequency range 1929 MHz – 1930 MHz (8PSK modulation).

Note: The external attenuation of 34.7 dB is included in the spectral plot. This accounts for the external attenuator and the cable loss during the testing.

**Test No. 4: Spurious Emissions at the Antenna Terminals
(Carrier Test Frequency = 1989.8 MHz)**

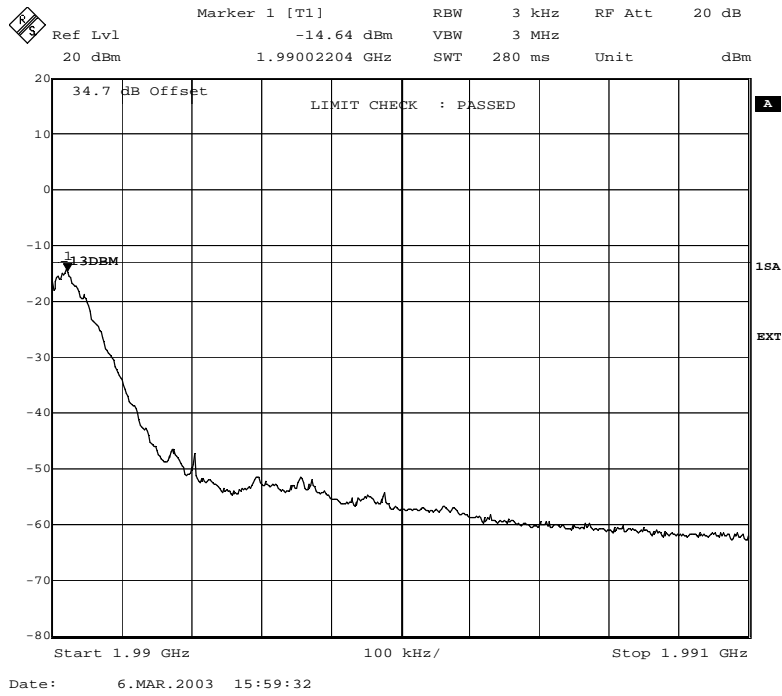

Fig. 80 – Spurious emissions in the frequency range 1990 MHz – 1991 MHz (GMSK modulation).

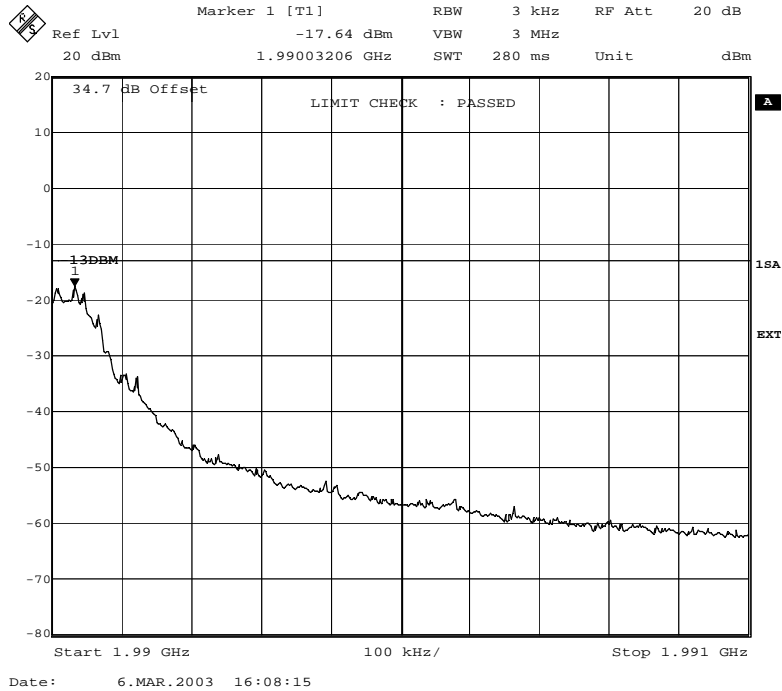

Fig. 81 – Spurious emissions in the frequency range 1990 MHz – 1991 MHz (8PSK modulation).

Note: The external attenuation of 34.7 dB is included in the spectral plot. This accounts for the external attenuator and the cable loss during the testing.

**Test No. 4: Spurious Emissions at the Antenna Terminals
(Carrier Test Frequency = 1989.8 MHz)**

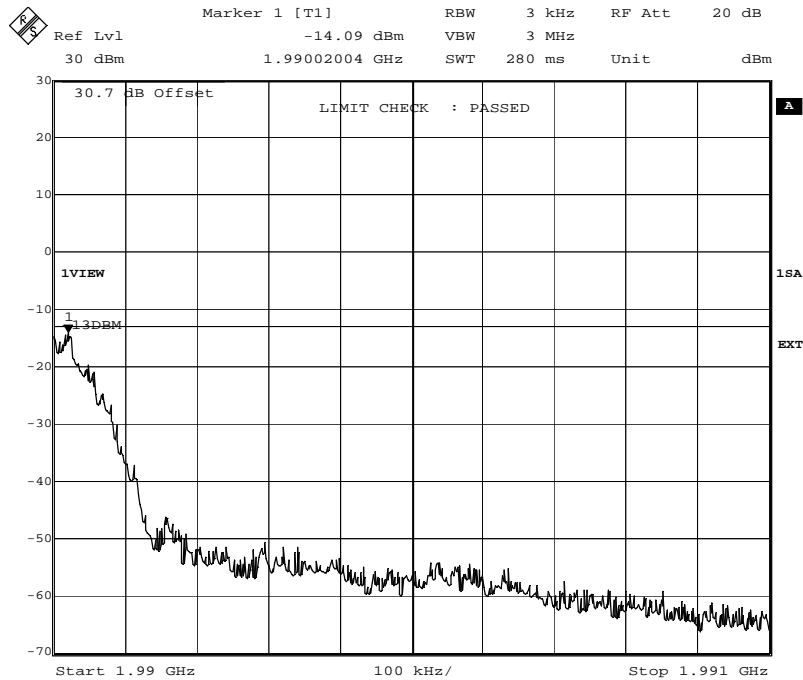

Fig. 82 – Spurious emissions in the frequency range 1990 MHz – 1991 MHz (GMSK modulation) for ECUPV2.

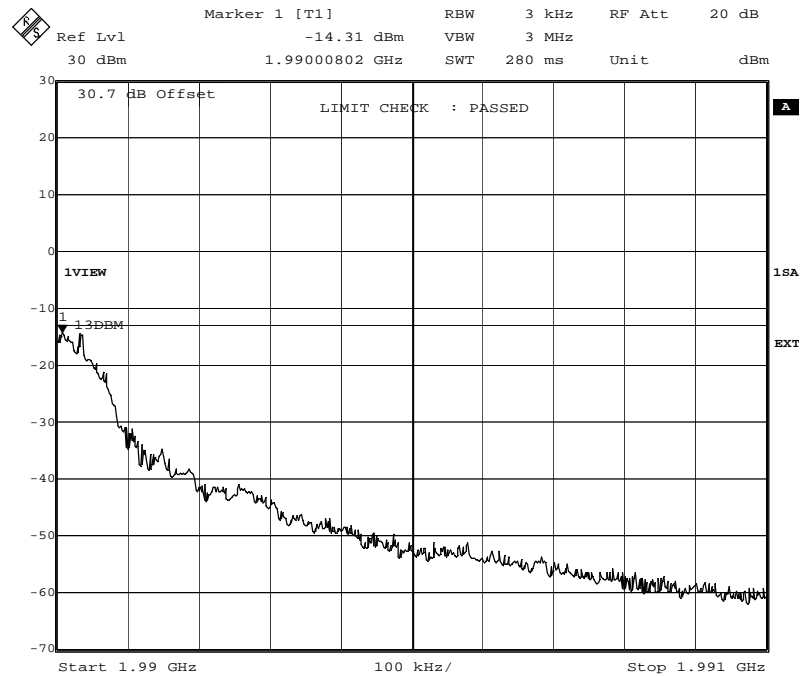
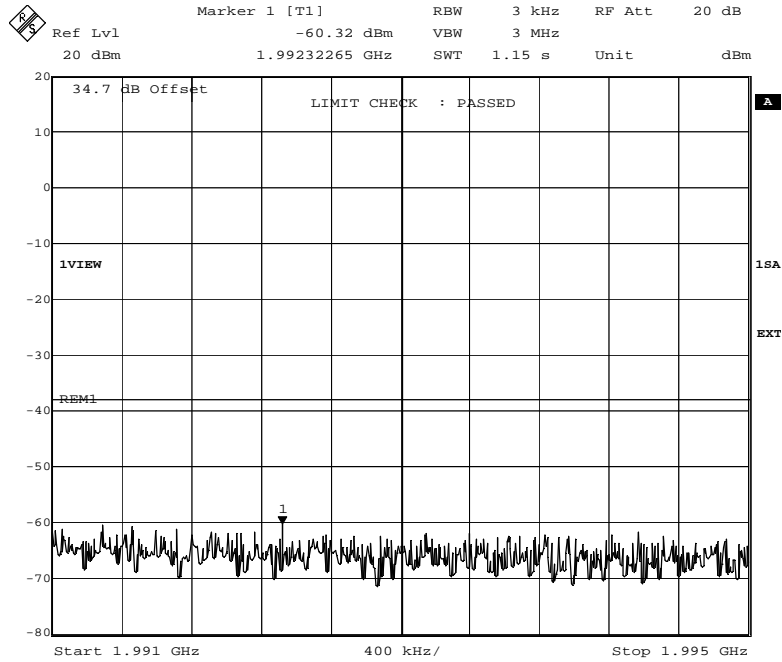

Fig. 83 – Spurious emissions in the frequency range 1990 MHz – 1991 MHz (8PSK modulation) for ECUPV2.

Note: The external attenuation of 30.7 dB is included in the spectral plot. This accounts for the external attenuator and the cable loss during the testing.

**Test No. 4: Spurious Emissions at the Antenna Terminals
(Carrier Test Frequency = 1989.8 MHz)**



**Fig. 84 – Spurious emissions in the frequency range 1991 MHz – 1995 MHz (GMSK modulation).
Limit: -13dB–25.2dB–38.2dBm**

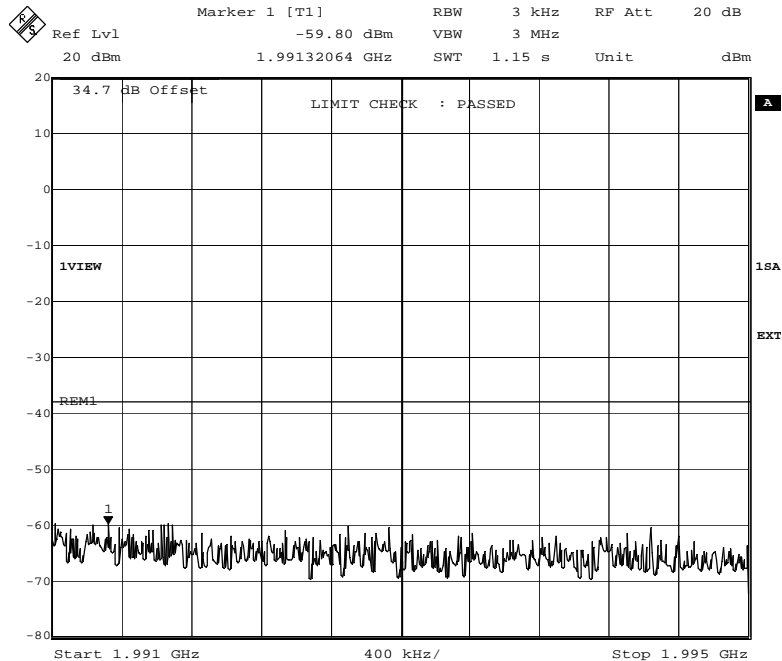

**Fig. 85 – Spurious emissions in the frequency range 1991 MHz – 1995 MHz (8PSK modulation).
Limit: -13dB–25.2dB–38.2dBm**

Note: The external attenuation of 34.7 dB is included in the spectral plot. This accounts for the external attenuator and the cable loss during the testing.

**Test No. 4: Spurious Emissions at the Antenna Terminals
(Carrier Test Frequency = 1989.8 MHz)**

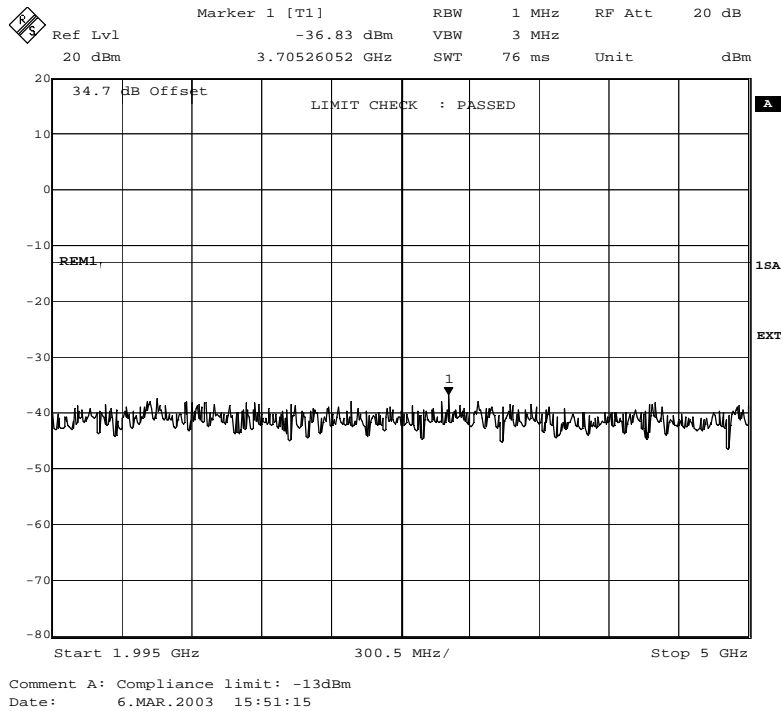

Fig. 86 – Spurious emissions in the frequency range 1995 MHz – 5000 MHz (GMSK modulation).

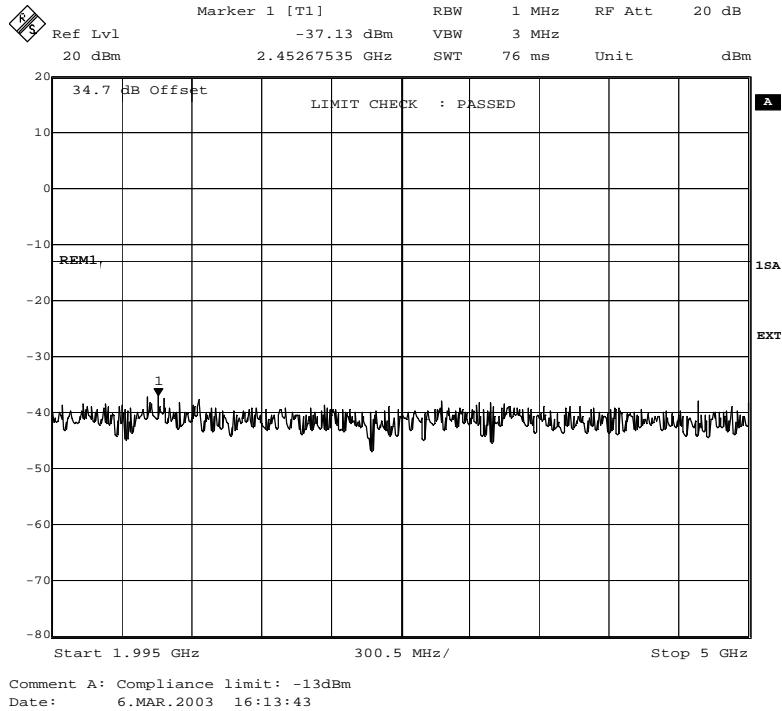

Fig. 87 – Spurious emissions in the frequency range 1995 MHz – 5000 MHz (8PSK modulation).

Note: The external attenuation of 34.7 dB is included in the spectral plot. This accounts for the external attenuator and the cable loss during the testing.

**Test No. 4: Spurious Emissions at the Antenna Terminals
(Carrier Test Frequency = 1989.8 MHz)**

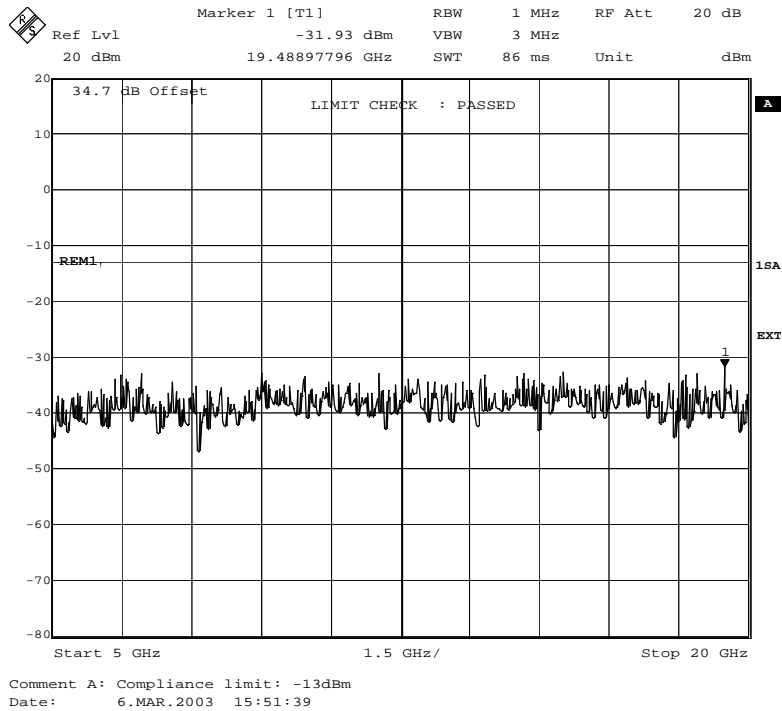

Fig. 88 – Spurious emissions in the frequency range 5000 MHz–20000 MHz (GMSK modulation).

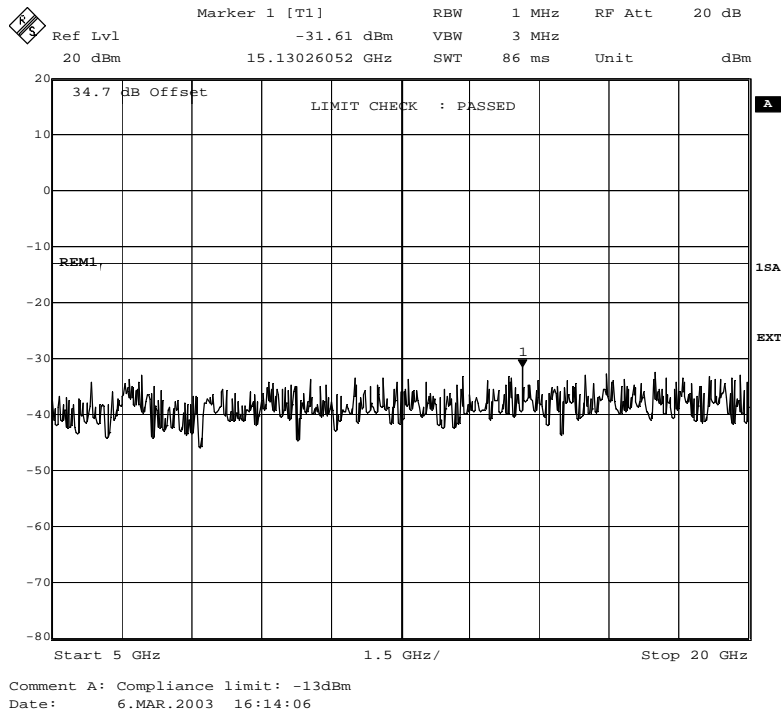

Fig. 89 – Spurious emissions in the frequency range 5000 MHz–20000 MHz (8PSK modulation).

Note: The external attenuation of 34.7 dB is included in the spectral plot. This accounts for the external attenuator and the cable loss during the testing.

**Test No. 4: Spurious Emissions at the Antenna Terminals:
Filter Characteristic of the FSIQ26 Spectrum Analyzer's Resolution Filter**

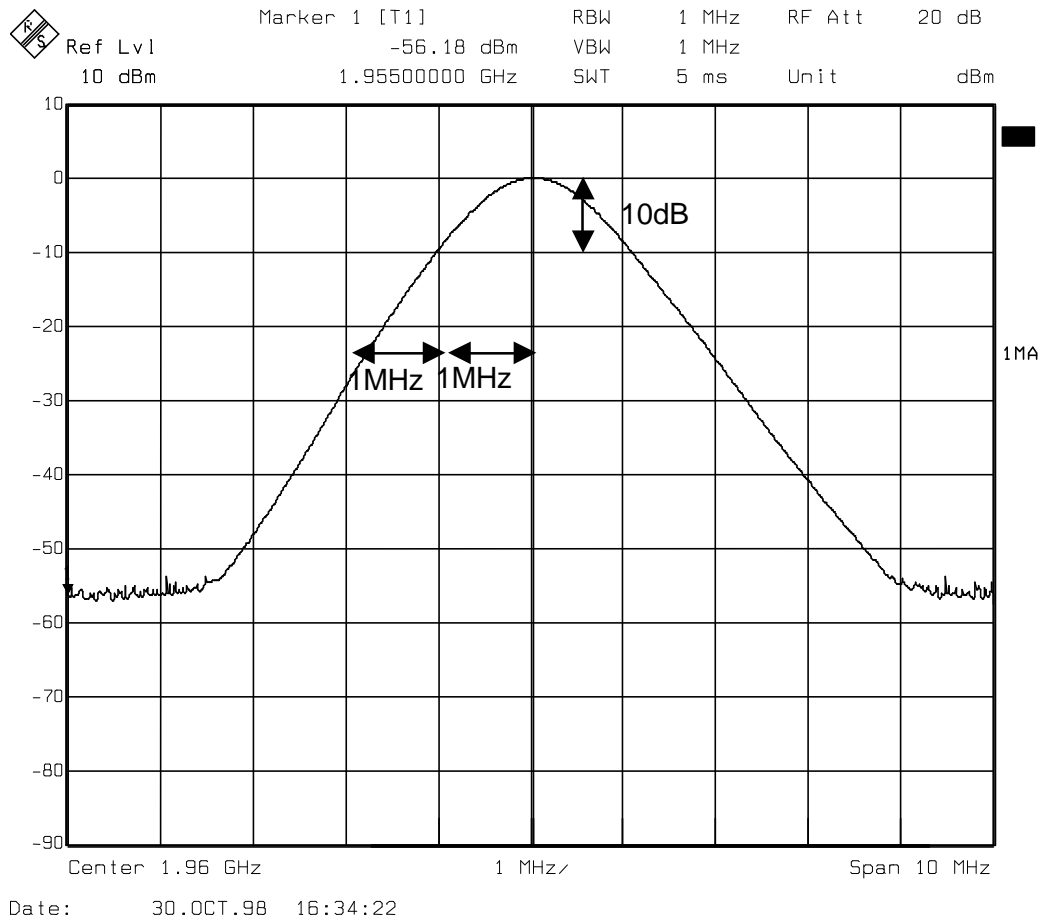

Fig. 90 – Filter characteristic of the 1 MHz resolution filter.

Test No. 5: Field Strength of Spurious Radiation

Fig. 91 -- Test setup for radiated emission measurement, 10 kHz to 30 MHz



Fig. 92 – Photograph of the anechoic chamber with the test configuration for substitution method

Test No. 5: Field strength of spurious radiation

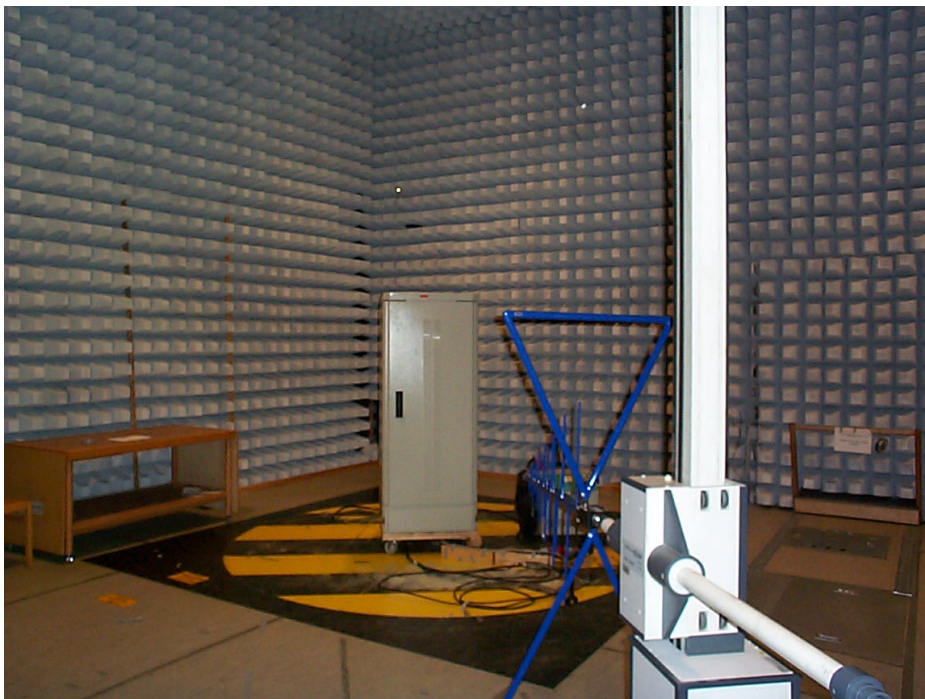
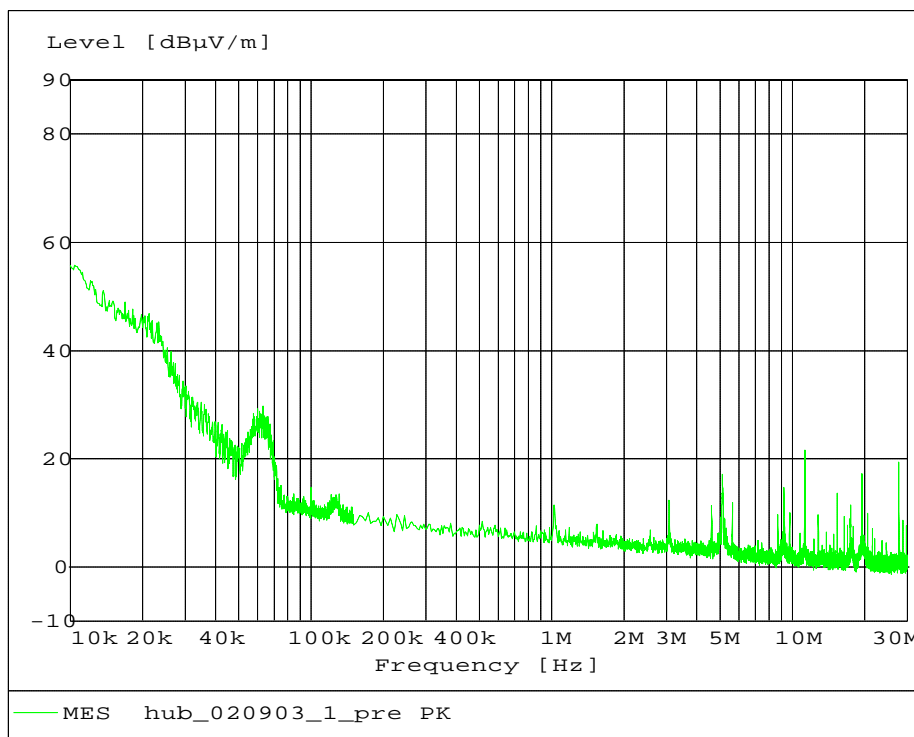

Fig. 93 – Radiated Emission 10 kHz – 30 MHz, GMSK modulation.

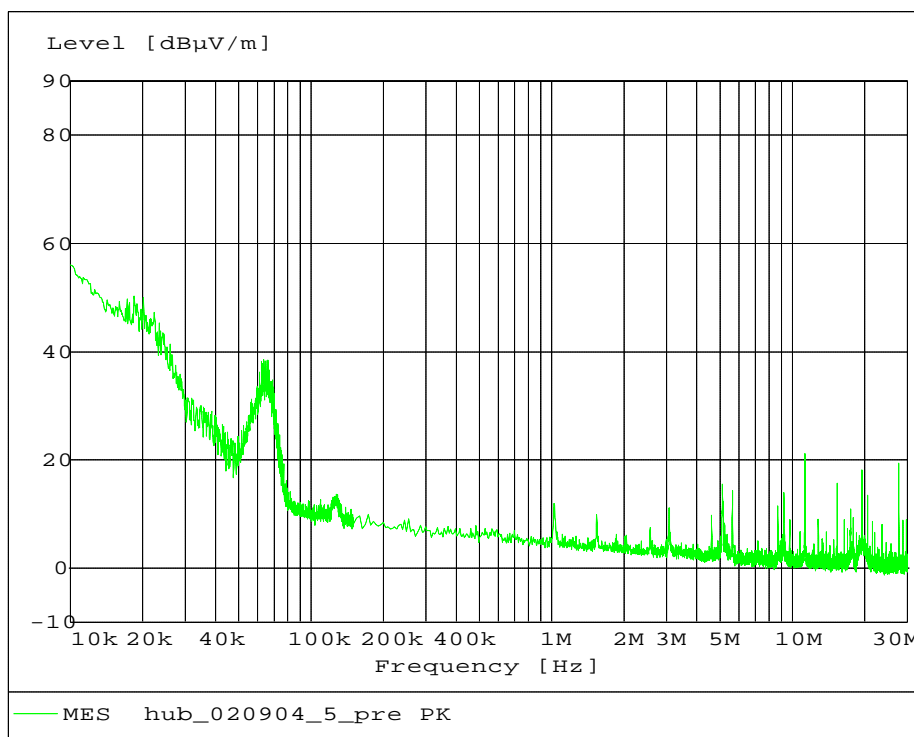

Fig. 94 – Radiated Emission 10 kHz – 30 MHz, 8PSK modulation.

Test No. 5: Field strength of spurious radiation

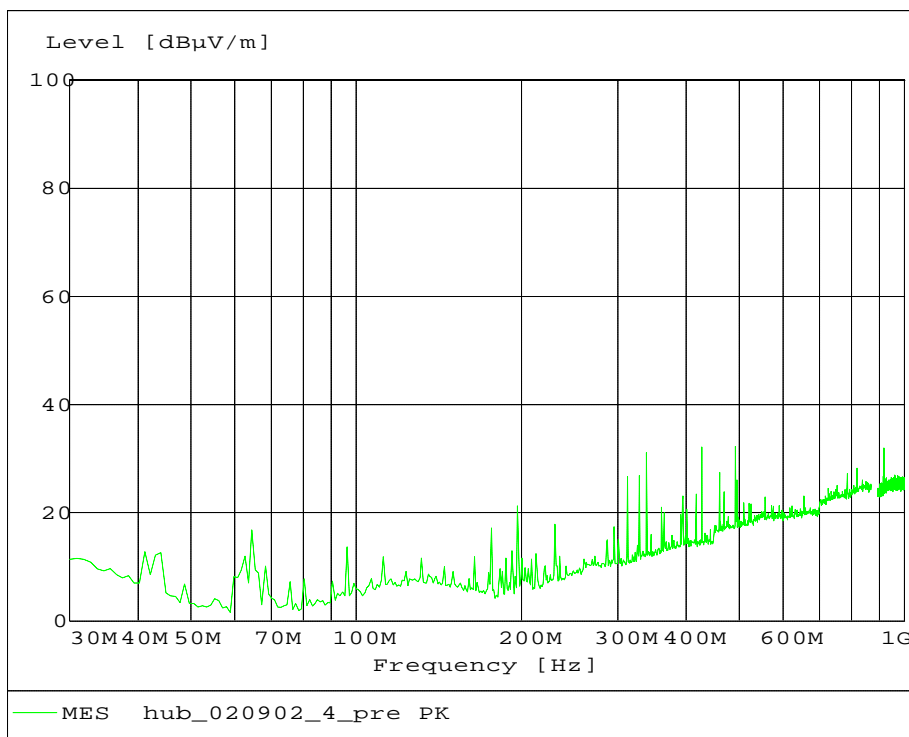

Fig. 95 – Radiated Emission 30 MHz – 1 GHz, GMSK modulation.

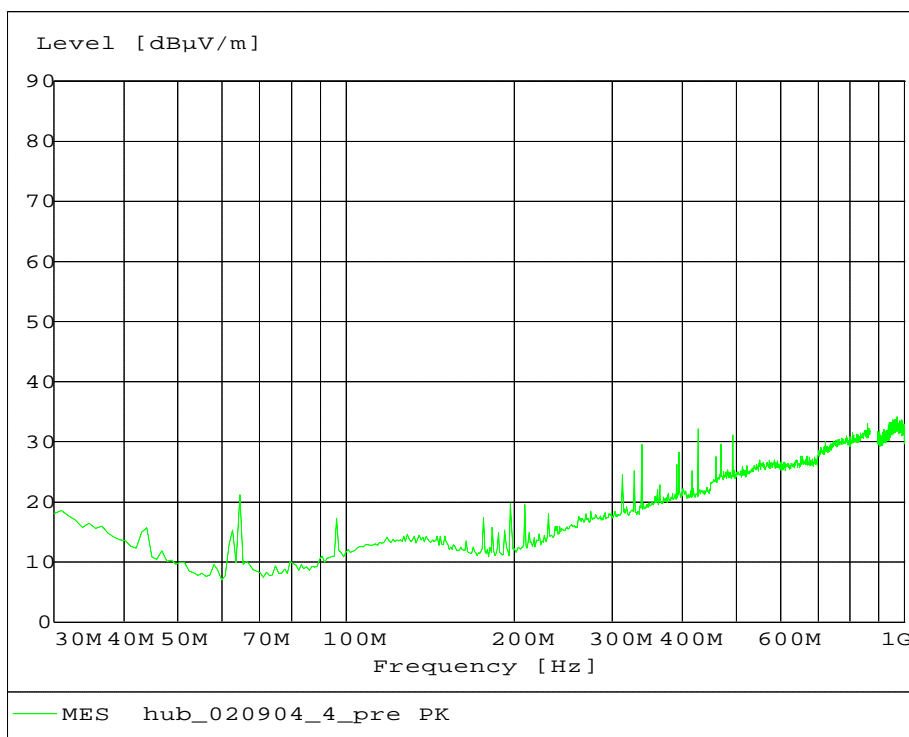

Fig. 96 – Radiated Emission 30 MHz – 1 GHz, 8PSK modulation.

Test No. 5: Field strength of spurious radiation

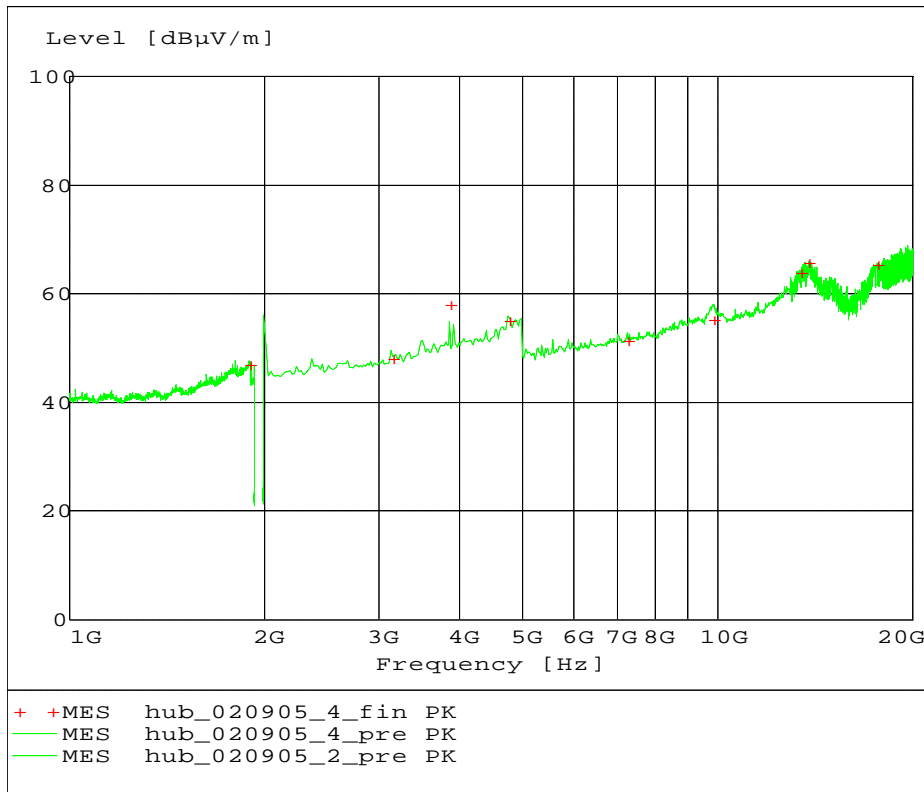

Fig. 97 – Radiated Emission 1 GHz – 20 GHz, GMSK modulation.

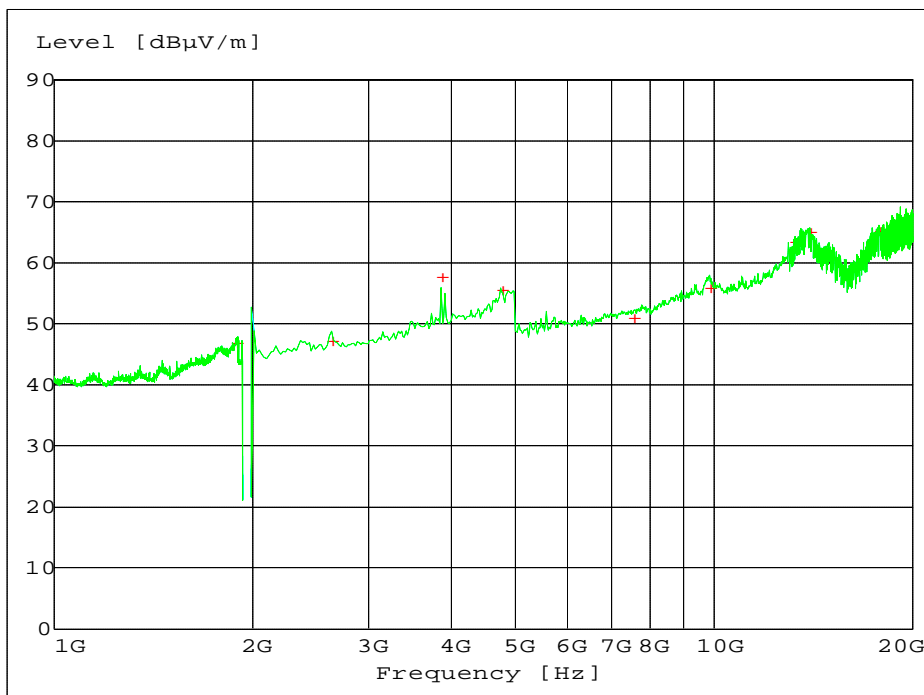

Fig. 98 – Radiated Emission 1 GHz – 20 GHz, 8PSK modulation.

Note: The frequencies shown on the plot were used for the spurious emission measurements using the "dipole substitution method".

Test No. 6: Frequency Stability

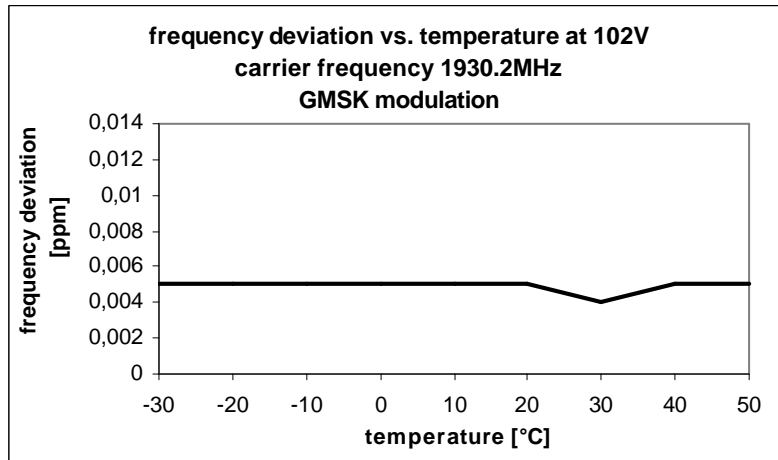

Fig. 99 – Frequency deviation vs. temperature (102V, 1930.2 MHz, GMSK modulation)

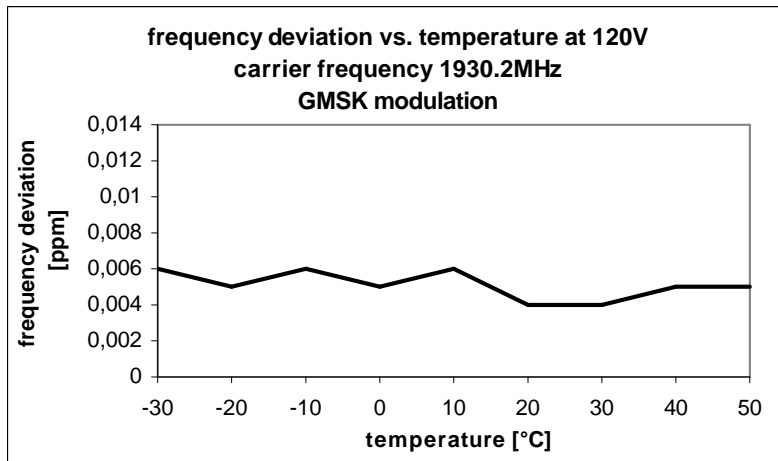

Fig. 100 – Frequency deviation vs. temperature (120V, 1930.2 MHz, GMSK modulation)

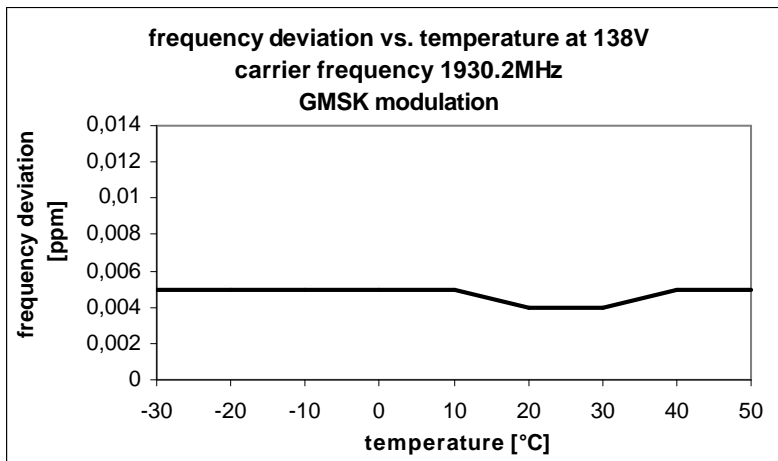

Fig. 101 – Frequency deviation vs. temperature (138V, 1930.2 MHz, GMSK modulation)

Test No. 6: Frequency Stability

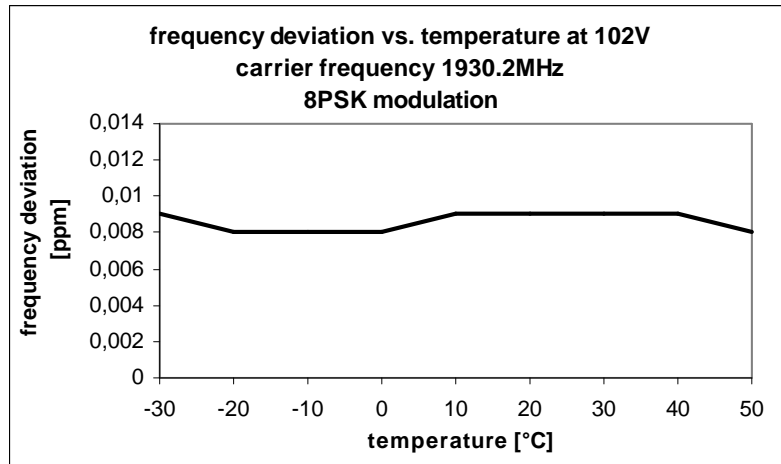

Fig. 102 – Frequency deviation vs. temperature (102V, 1930.2 MHz, 8PSK modulation)

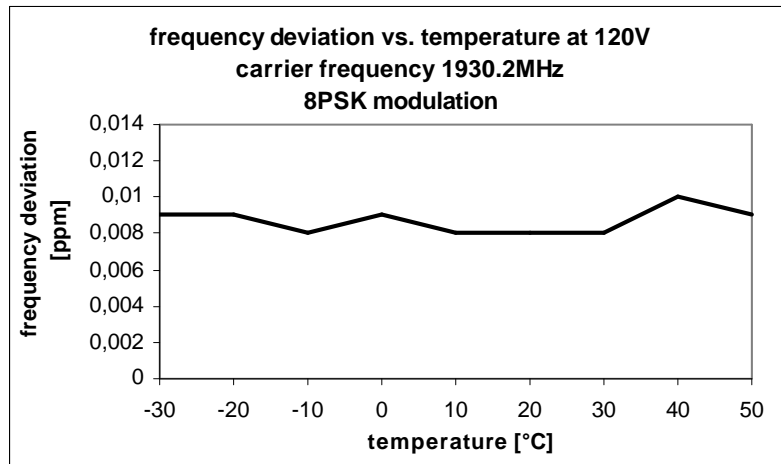

Fig. 103 – Frequency deviation vs. temperature (120V, 1930.2 MHz, 8PSK modulation)

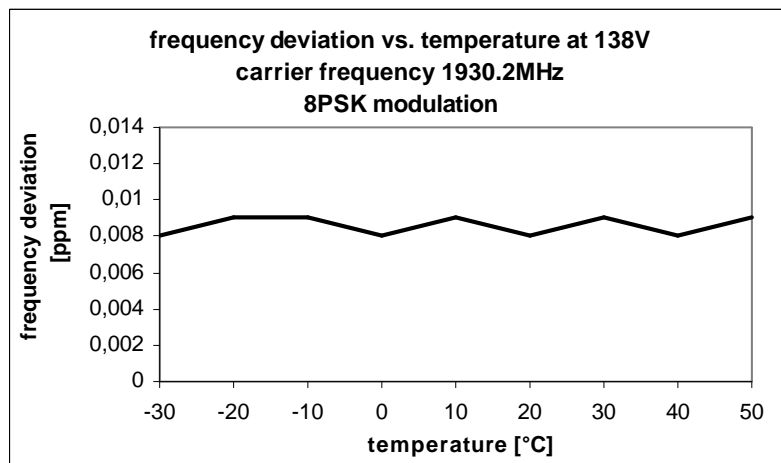

Fig. 104 – Frequency deviation vs. temperature (138V, 1930.2 MHz, 8PSK modulation)

Test No. 6: Frequency Stability

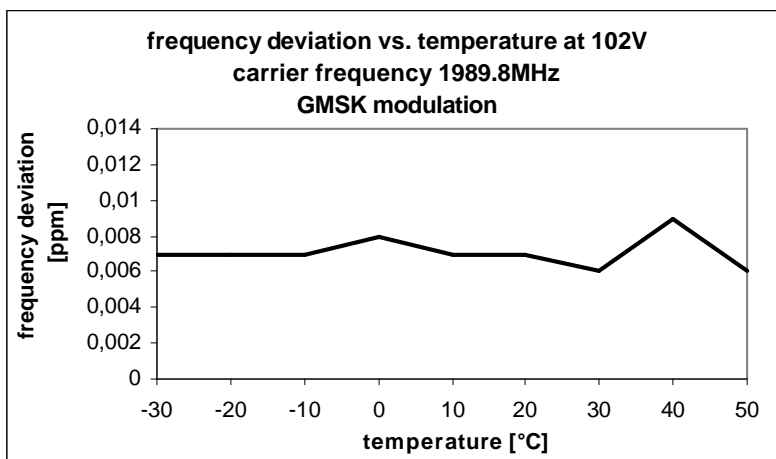

Fig. 105 – Frequency deviation vs. temperature (102V, 1989.8 MHz, GMSK modulation)

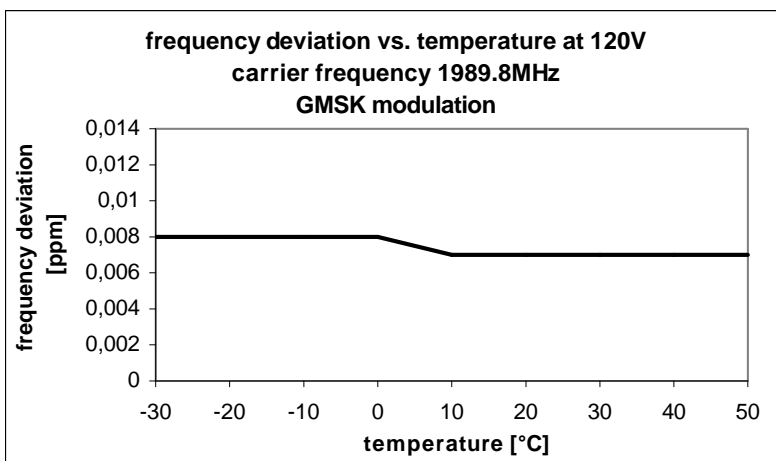

Fig. 106 – Frequency deviation vs. temperature (120V, 1989.8 MHz, GMSK modulation)

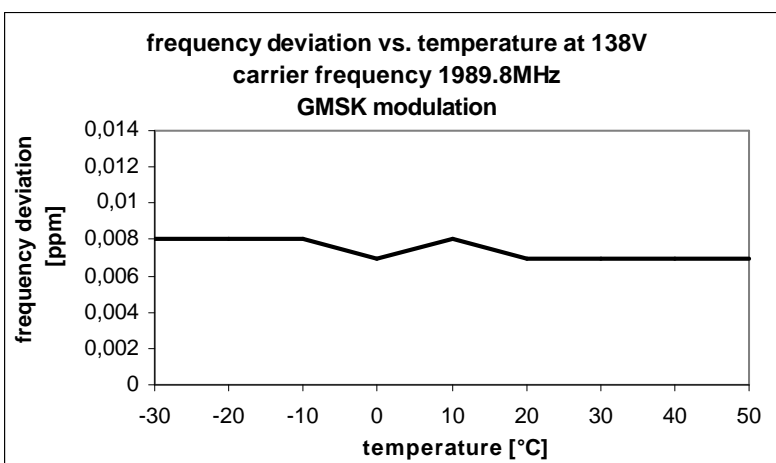

Fig. 107 – Frequency deviation vs. temperature (138V, 1989.8 MHz, GMSK modulation)

Test No. 6: Frequency Stability

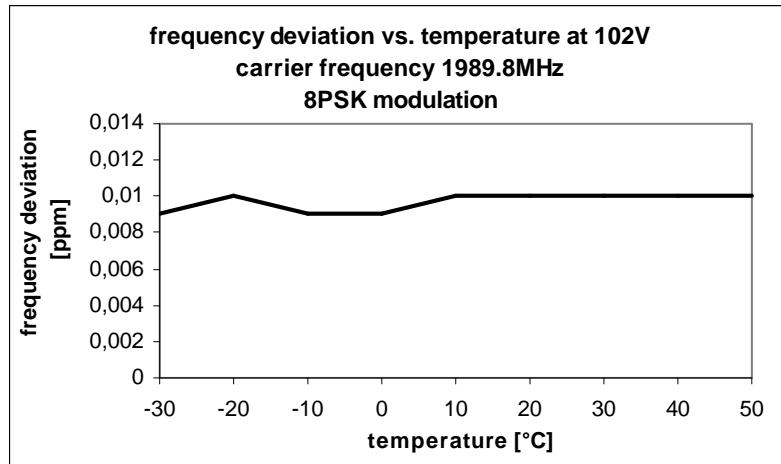

Fig. 108 – Frequency deviation vs. temperature (102V, 1989.8 MHz, 8PSK modulation)

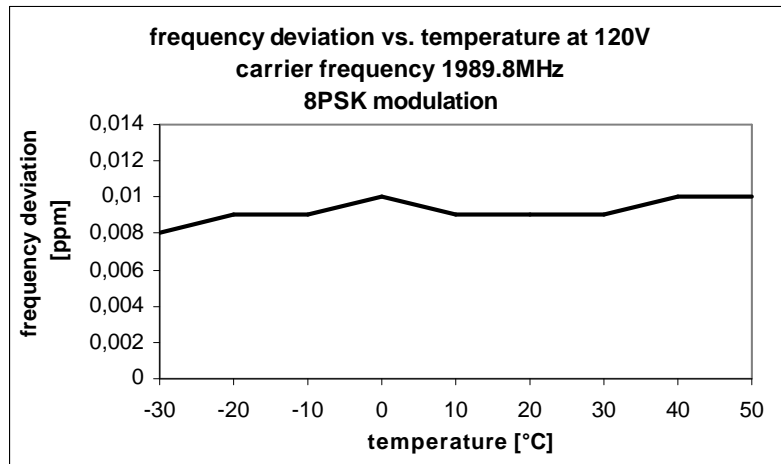

Fig. 109 – Frequency deviation vs. temperature (120V, 1989.8 MHz, 8PSK modulation)

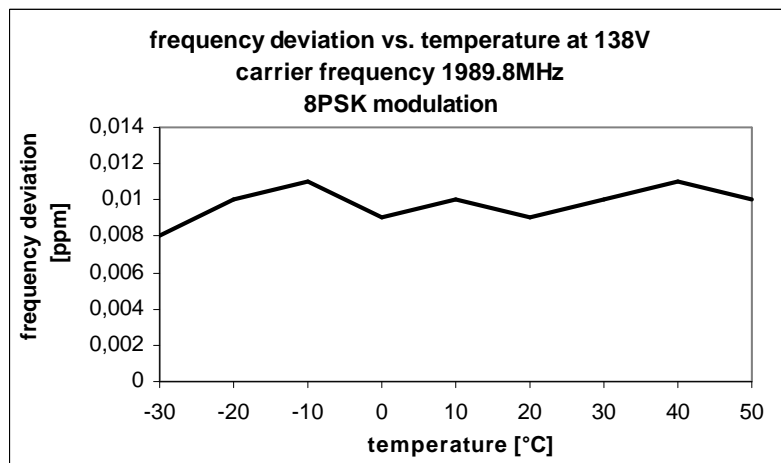

Fig. 110 – Frequency deviation vs. temperature (138V, 1989.8 MHz, 8PSK modulation)

Test No. 7: Slow Frequency Hopping

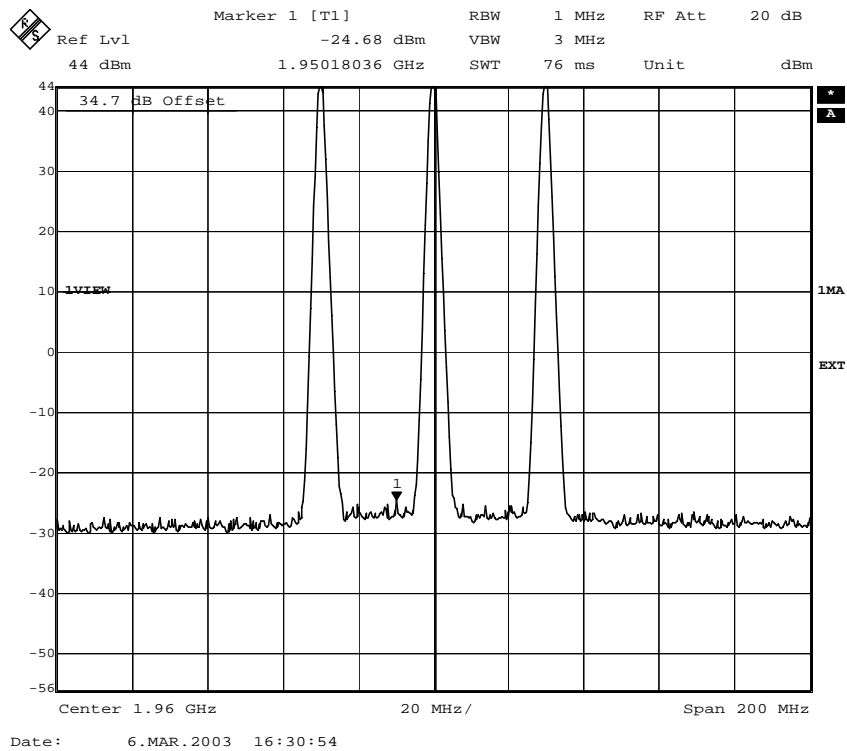

Fig. 111 – Slow frequency hopping – RBW = 1 MHz (GMSK modulation)

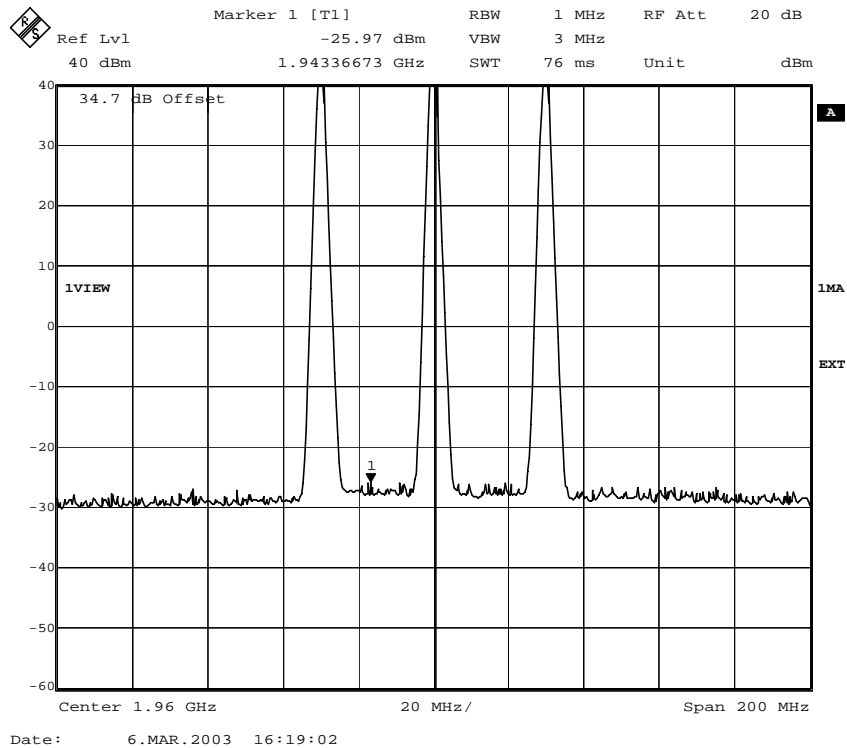

Fig. 112 – Slow frequency hopping – RBW = 1 MHz (8PSK modulation)

Note: The external attenuation of 34.7 dB is included in the spectral plot. This accounts for the external attenuator and the cable loss during the testing.

Test No. 7: Slow Frequency Hopping

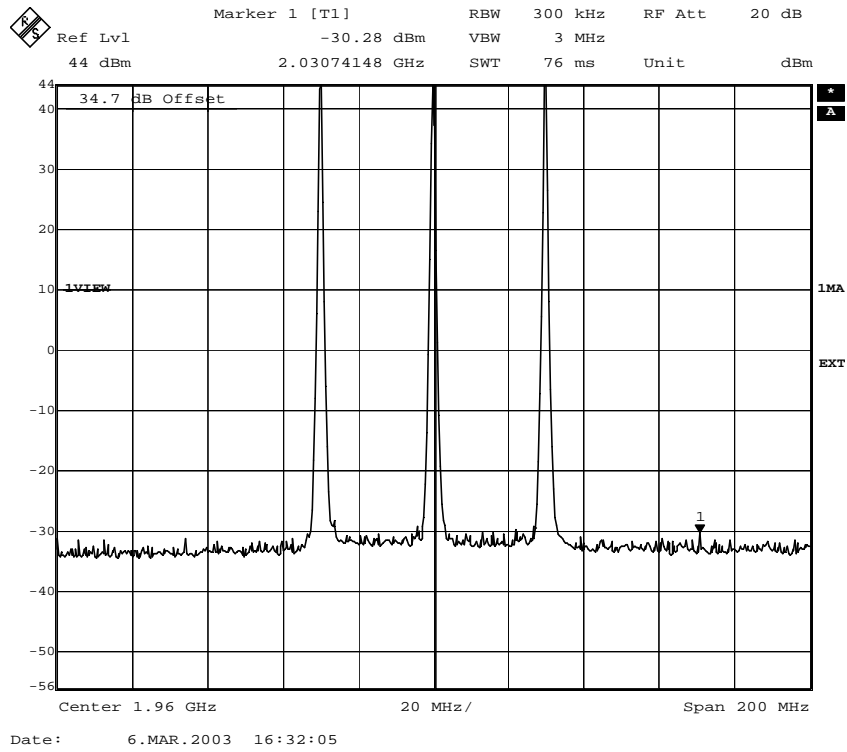

Fig. 113 – Slow frequency hopping – RBW = 300 kHz (GMSK modulation)

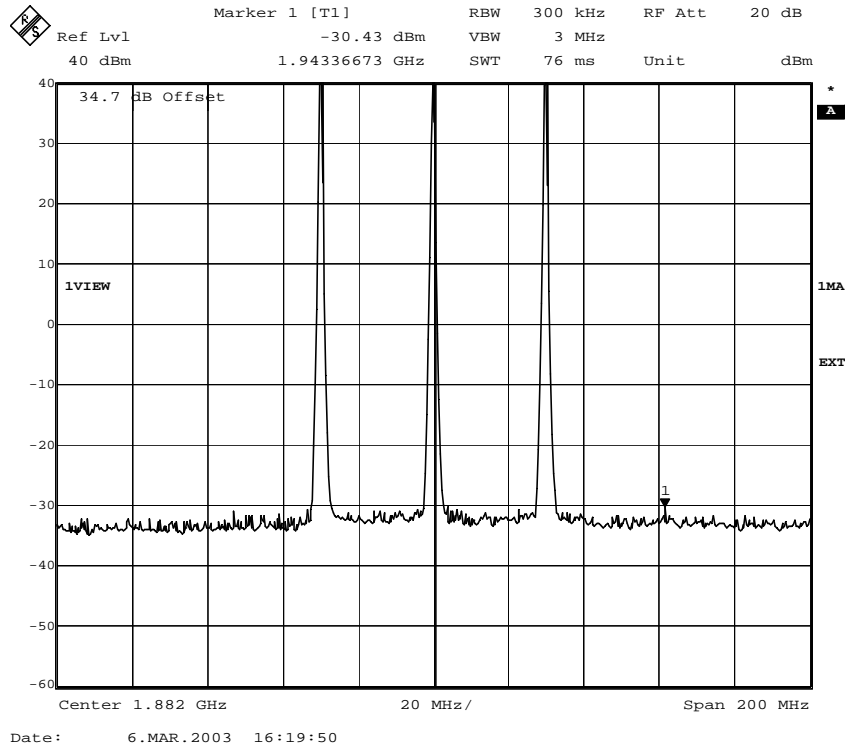

Fig. 114 – Slow frequency hopping – RBW = 300 kHz (8PSK modulation)

Note: The external attenuation of 34.7 dB is included in the spectral plot. This accounts for the external attenuator and the cable loss during the testing.

Test No. 7: Slow Frequency Hopping

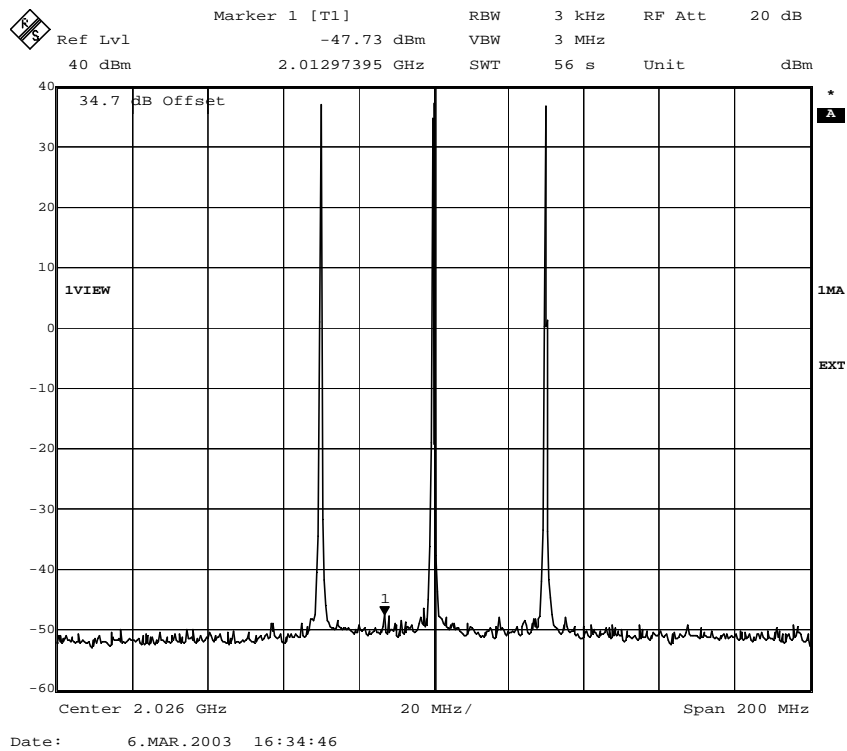

Fig. 115 – Slow frequency hopping – RBW = 3 kHz (GMSK modulation)

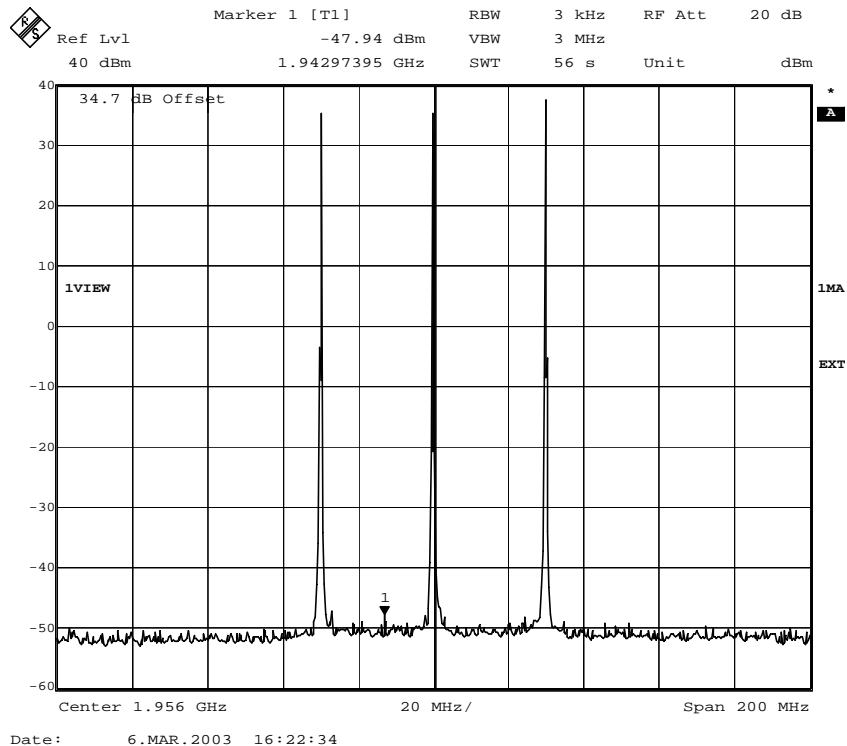

Fig. 116 – Slow frequency hopping – RBW = 3 kHz (8PSK modulation)

Note: The external attenuation of 34.7 dB is included in the spectral plot. This accounts for the external attenuator and the cable loss during the testing.

Test No. 7: Slow Frequency Hopping

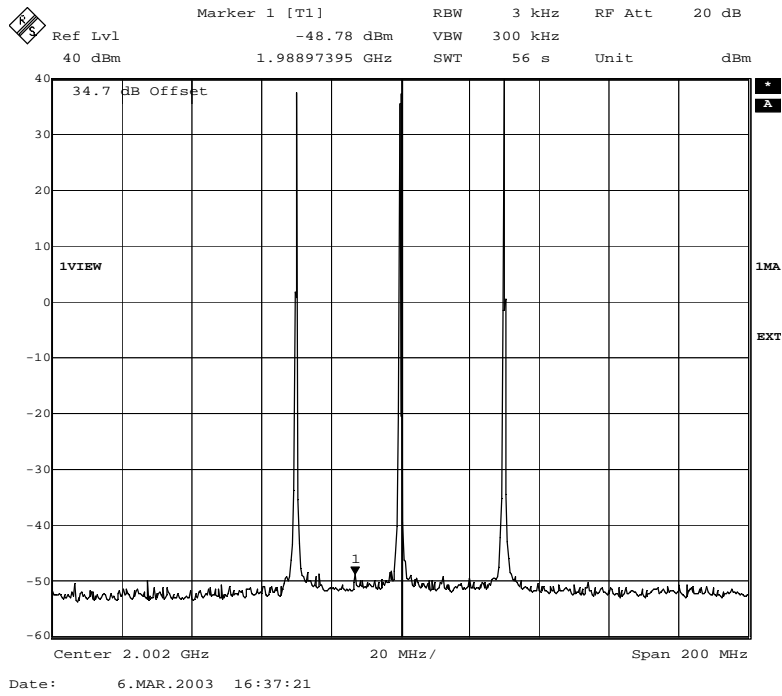

Fig. 117 – Slow frequency hopping – RBW = 3 kHz, reduced video bandwidth VBW = 300kHz (GMSK modulation)

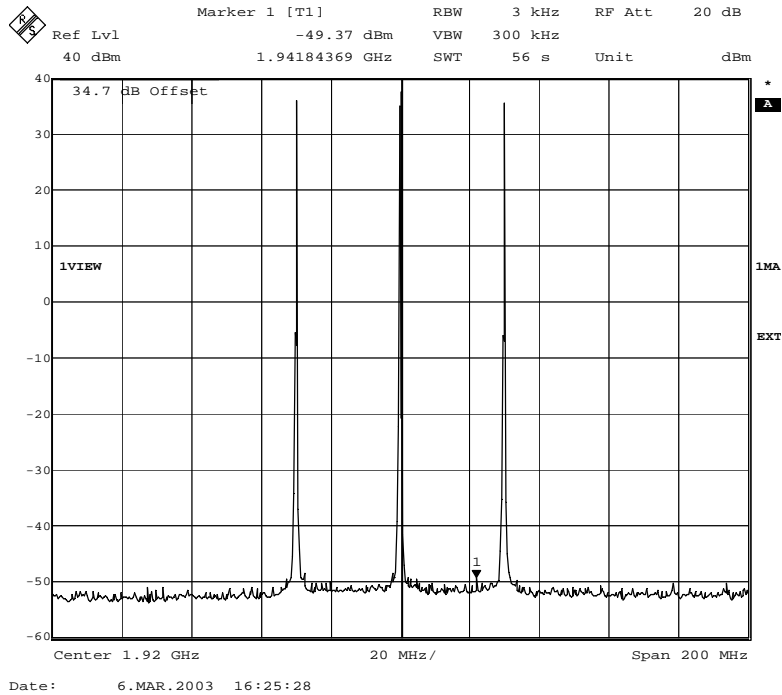

Fig. 118 – Slow frequency hopping – RBW = 3 kHz, reduced video bandwidth VBW = 300kHz (8PSK modulation)

Note: The external attenuation of 34.7 dB is included in the spectral plot. This accounts for the external attenuator and the cable loss during the testing.