

Test Plan and Test Results

BS240/241 BTS PCS Base Station

FCC ID:NE3PCS003

Name of Applicant

*Siemens Information and Communication Networks, Inc.
900 Broken Sound Parkway
Boca Raton, FL 33487*

TABLE OF CONTENTS

1	EQUIPMENT UNDER TEST (EUT)	4
2	MEASUREMENTS	5
2.1	General description	5
2.2	Summary of the measurements	5
2.2.1	EUT configuration and operating conditions	5
2.2.2	Selected carrier test frequencies	6
2.2.3	Modulation characteristics	6
2.2.4	Measurement test configuration	6
2.2.5	Calibration of the measurement equipment	7
2.3	Test No. 1: RF power output (§ 2.1046)	8
2.3.1	Purpose	8
2.3.2	EUT operation condition	8
2.3.3	Test configuration	8
2.3.4	Measurement procedure	8
2.3.5	Measurement results	8
2.4	Test No. 2: Modulation characteristics (§ 2.1047, § 2.201)	9
2.5	Test No. 3: Occupied bandwidth (§ 2.1049)	10
2.5.1	Purpose	10
2.5.2	EUT operation condition	10
2.5.3	Test configuration	10
2.5.4	Measurement procedure and results	10
2.6	Test No. 4: Spurious emissions at antenna terminals (§ 2.1051, § 2.1057, § 24.238)	11
2.6.1	Purpose	11
2.6.2	Limits	11
2.6.3	EUT operation condition	11
2.6.4	Test configuration	11
2.6.5	Measurement procedure and results	11
2.7	Test No. 5: Field strength of spurious radiation (§ 2.1053, § 2.1057, § 24.238)	14
2.7.1	Purpose	14
2.7.2	Limits and field strength calculations	14
2.7.3	EUT operation condition	14
2.7.4	Test configuration	15
2.7.5	Measurement procedure	15
2.7.6	Measurement results & limits	15
2.8	Test No. 6: Frequency stability (§ 2.1055, § 24.235)	16
2.8.1	Purpose	16
2.8.2	Limits	16
2.8.3	EUT operation condition	16
2.8.4	Test configuration	16

2.8.5	Measurement procedure	17
2.8.6	Measurement results	17
2.9	Test No. 7: Slow frequency hopping	18
2.9.1	Introduction	18
2.9.2	Purpose	18
2.9.3	EUT operation condition	18
2.9.4	Test configuration	18
2.9.5	Measurement procedure	18
2.9.6	Measurement results	18
3	MEASUREMENT DATA AND SPECTRAL PLOTS	20
3.1	Part list of the measurement test equipment	20
3.2	Spectral plots	21

1 Equipment under test (EUT)

The equipment under test (EUT) comprises the modules listed in the table below.

Module Name	Siemens Part No.	Serial No.
DUAMCO2PV4	S30861-U2105-X-01/01	FMM/M1000000
CUPV4	S30861-U2094-X-B1/01	RX+/M2409183
CUPV4	S30861-U2094-X-B1/01	RX+/M2409184

For a functional description of the modules, please refer to the appropriate related parts and exhibit sections of this certification application.

The tests were conducted with the modules installed in a BS-240U and in a BS-241U. Worst case measurement data is reported.

The tested system was equipped as per Fig. 1 on page 6 with its maximum number of 8 transceivers. Although only one transceiver (EUT) was tested for compliance, the other transceiver was investigated to ensure that the worst case test condition/transceiver was measured.

To comply with the FCC rules (§2.1051, §24.238), the lowest and highest authorized channel frequencies in each of the PCS frequency blocks are disabled and cannot be activated by the user. Refer to section IV of the “Certification Application Overview”, located in the cover letter section, for details on how the channels are disabled.

A complete description of the transceiver’s calibration/tuning procedure is included in the Parts List and TuneUp exhibit section of this application.

2 Measurements

2.1 General description

2.2 Summary of the measurements

The measurements described in the following sections were conducted pursuant to 47 CFR § 2.947. All applicable paragraphs of the 47 CFR parts 2 and 24 of the most current version of the rules were considered.

The measurements were performed at Siemens AG, Institute for Quality Engineering, Testing, and Approvals, Hofmannstr. 51, 81359 Munich, Germany.

The following tests were performed according to the FCC rules in order to verify the compliance of the EUT with the FCC requirements:

Test No.	Measurement	FCC Rule	Page Number of this Report	Results
1	RF power output	§ 2.1046	8	compliant
2	Modulation characteristics	§ 2.1047, § 2.201	9	compliant
3	Occupied bandwidth	§ 2.1049	10	compliant
4	Spurious emissions at antenna terminals	§ 2.1051, § 2.1057, § 24.238	11	compliant
5	Field strength of spurious radiation	§ 2.1053, § 2.1057, § 24.238	14	compliant
6	Frequency stability	§ 2.1055, § 24.235	16	compliant
7	Slow frequency hopping	N/A	18	compliant

In accordance with the FCC Rule §15.3 (z) the equipment was tested with the limits that are valid for an *unintentional radiator*.

2.2.1 EUT configuration and operating conditions

If not stated otherwise, the following standard setup procedure for the EUT under test was used:

A CMD57 is used to control the EUT. The CMD57 is connected to the EUT via the A_{bis} Link. For detailed test system equipment configuration please refer to Fig. 1 on page 6.

The transmitter modules were tuned up according to the procedure described in the TuneUp exhibit section of this application.

During the measurements, one carrier channel was tested at a time. The carrier was set to the maximum power level with all timeslots activated to ensure the maximum emission amplitudes during all measurements. A pseudo random bit pattern was applied to the digital modulator in order to produce the maximum modulation. This ensures that the measurements of the emission characteristics of the transmitter are pursuant to § 2.1049.

2.2.2 Selected carrier test frequencies

The measurements were performed at 3 selected carrier test frequencies, according to the following table:¹

Carrier Test Frequency [MHz]	Remark
1930.4	lowest possible carrier frequency
1960.0	frequency at the middle of the band
1989.6	highest possible carrier frequency

2.2.3 Modulation characteristics

The modulation characteristic of the GMSK modulation used in the PCS system is defined in standard J-STD-007 Air Interface Specification Volume 1. During all measurements described below, a pseudo random sequence was applied to the digital modulator to ensure emission characteristics of the transmitter are pursuant to § 2.1049.

2.2.4 Measurement test configuration

If not stated otherwise, the following measurement configuration was used to perform all measurements (see figure below):

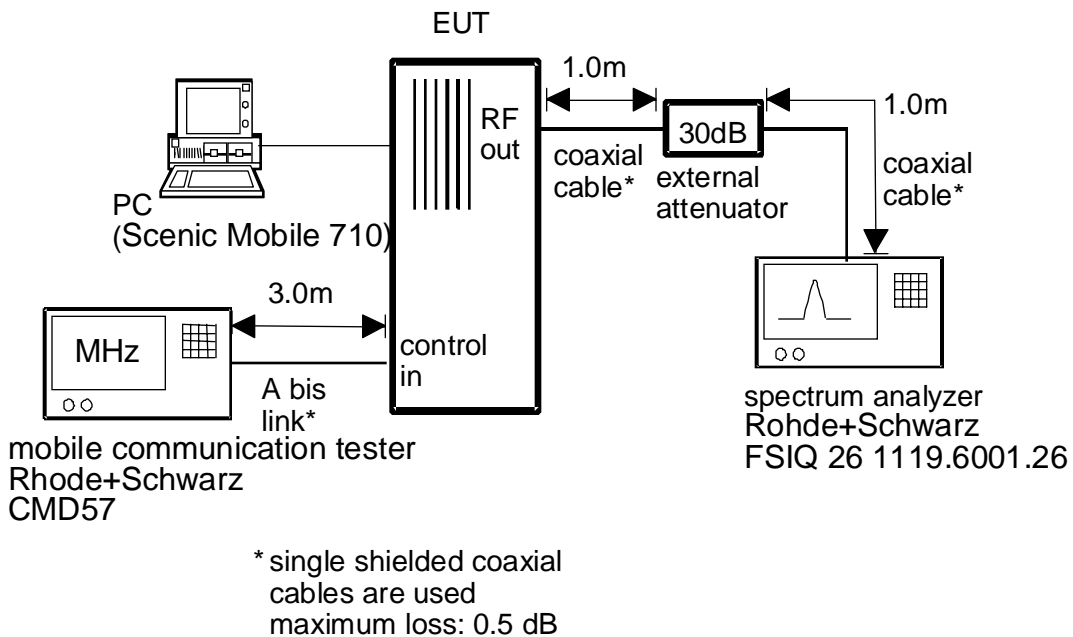

Fig. 1 – Measurement Test Configuration

¹ The uppermost and lowermost channels of each frequency block are disabled in order to be compliant with the emission limit requirements of § 24.238. See section IV of the “Certification Application Overview”, located in the cover letter section, for details.

The EUT is controlled by a mobile communication tester Rohde&Schwarz CMD57 via the serial Abis Link. The RF output signal is injected into a spectrum analyzer Rohde&Schwarz FSIQ26 via a high power 30 dB attenuator. The attenuator is used to protect the input of the spectrum analyzer from high RF power levels. All measurements of the analyzer are performed in peak detector (max hold) mode in order to ensure that the highest possible emission amplitudes of the EUT are captured by the measurement equipment. No video filtering was used throughout the measurements. A description of the analyzer settings is given in each of the sections describing the measurements. A complete list of the measurement equipment is included on page 20 of this measurement report.

2.2.5 Calibration of the measurement equipment

The spectrum analyzer has a built-in self-calibration procedure. This calibration procedure was activated prior to the measurements so that the analyzer is deemed accurate. The attenuation of the attenuator is within the manufacturer's specified limits. High quality cables were used to connect the measurement equipment to the EUT. The maximum loss of the cable is within the manufacturer's limits.

2.3 Test No. 1: RF power output (§ 2.1046)

2.3.1 Purpose

The RF power output measurements were performed pursuant to § 2.1046 in order to determine the peak rated RF output power of the EUT.

2.3.2 EUT operation condition

The EUT was configured and operating as described in section 2.2.1. The RF output power was determined at three selected carrier test frequencies according to section 2.2.2 of this application. Measurements were carried out at both outputs. Only worst case results are included in this test report.

2.3.3 Test configuration

The test configuration used is described in the block diagram in section 2.2.4. See page 6 for a block diagram (Fig. 1).

2.3.4 Measurement procedure

The RBW setting of the spectrum analyzer was increased until the measured power reached a stable upper limit (RBW = 1MHz).

2.3.5 Measurement results

The following table shows the measured output powers at the output.

Note:

The offset value indicated on the spectral plots represents the external attenuation value that includes the fixed attenuator plus the cable loss.

Carrier Test Frequency [MHz]	Indicated Power Level [dBm]	External Attenuation [dB]	RF Power	Results
1930.4	12.3	31.0	43.3 dBm = 21.4 W	compliant
1960.0	13.2	31.0	44.2 dBm = 26.3 W	compliant
1989.6	12.6	31.0	43.6 dBm = 22.9 W	compliant

Spectral plots are included on pages 21 – 23 of this report.

The measured power levels were found to be compliant with the manufacturer’s specifications and with all requirements of the FCC rules.

2.4 Test No. 2: Modulation characteristics (§ 2.1047, § 2.201)

The occupied bandwidth was measured to be 245 kHz, which represents the 99% power bandwidth (refer to the spectral plots included on pages 25 – 27 and the following section). Three carrier test frequencies were investigated. Therefore, the modulation characteristic of the PCS base stations transceiver is 245KGXW. No further testing measurements are required under this section of the rules. No measurements are required here other than the occupied bandwidth.

The modulation characteristics were found to be compliant with the manufacturer's specifications and with all requirements of the FCC rules.

2.5 Test No. 3: Occupied bandwidth (§ 2.1049)

2.5.1 Purpose

The measurements are performed to determine the occupied bandwidth of the EUT pursuant to § 2.1049.

2.5.2 EUT operation condition

The EUT was set up according to section 2.2.1 of this test report. A pseudo random bit pattern is applied to the modulator. The test transceiver was modulated using standard GMSK modulation, as is typical for our PCS systems. For a specific modulation technique description, please see section XII of the “Certification Application Overview”, located in the cover letter section of this application. For circuit diagrams of the modulator, please refer to the Schematics exhibit section of this application.

2.5.3 Test configuration

The test configuration used is described in the block diagram in section 2.2.4. See page 6 for a block diagram (Fig. 1).

2.5.4 Measurement procedure and results

The occupied bandwidth was determined for each of the test frequencies listed in the table below. See the spectral plots included on pages 25 – 27 for details.

The 99% power bandwidth was determined with the spectrum analyzer. The following table summarizes the measurement results:

Carrier Test Frequency [MHz]	Occupied Bandwidth [kHz]	Results
1930.4	244.5	compliant
1960.0	240.5	compliant
1989.6	244.5	compliant

The occupied bandwidth was found to be compliant with the manufacturer’s specifications and with all requirements of the FCC rules.

2.6 Test No. 4: Spurious emissions at antenna terminals (§ 2.1051, § 2.1057, § 24.238)

2.6.1 Purpose

The measurements of the spurious emissions at the equipment output terminals were performed pursuant to § 2.1051 in order to verify that any emissions are below the limits given by § 24.238.

2.6.2 Limits

Compliance with § 24.238 requires that any emission be attenuated below the transmitter power by at least $43 + 10 \log_{10} P$ (P = transmitter power in Watts).

The compliance limit was calculated as per the following table:

Rated maximum transmitter output power	23.99W (=43.8 dBm)
Required attenuation	$43 + 10 \log_{10} 23.99 = 56.8 \text{ dB}$
Rated maximum transmitter output power – required attenuation = compliance limit	43.8 dBm – 56.8 dB = –13 dBm

2.6.3 EUT operation condition

The standard setup procedure as described in section 2.2.1 of this report was used.

2.6.4 Test configuration

The test configuration used is described in the block diagram in section 2.2.4. See page 6 for a block diagram (Fig. 1).

2.6.5 Measurement procedure and results

In accordance with § 24.238, a 1 MHz resolution bandwidth was used for the measurements. However, in the 1 MHz frequency bands immediately outside and adjacent to the frequency block a resolution bandwidth of approximately one percent of the emission bandwidth of the fundamental emission of the transmitter was employed. The emission bandwidth is 245 kHz (refer to the spectral plot on page 25). Thus, the measurements were conducted using a 3 kHz resolution bandwidth and no video filtering.

Due to the imperfect resolution filter in the spectrum analyzer², the FCC allows continuing the use of the 3 kHz RBW in the 5 MHz frequency bands immediately outside and adjacent to the frequency block with an increased attenuation specification. This is depicted in the following diagram:

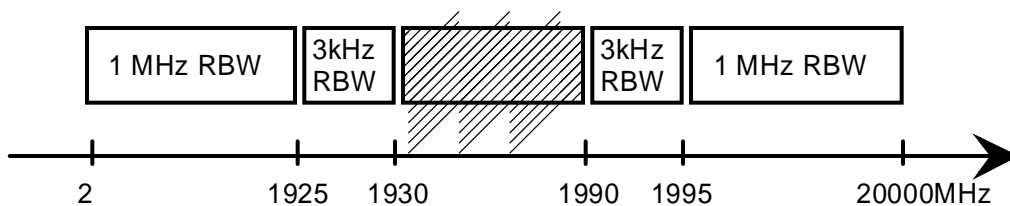

Pursuant to the FCC, the (effective) attenuation specification has to be increased by the same ratio of required RBW setting to actual RBW setting³. In this case, use of 3 kHz beyond the original 1 MHz region would result in a

² A spectral plot showing the frequency response of the 1 MHz resolution filter of the spectrum analyzer is included on page 49 of this report.

25.2 dB increase in the attenuation specification. As a result the compliance limit is $-13 \text{ dBm} - 25.2 \text{ dB} = -38.2 \text{ dBm}$ in the frequency ranges 1925-1929 MHz and 1991-1995 MHz.

According to § 2.1057, all emission including the fundamental frequency of the transceiver and all frequencies up to the 10th harmonic were investigated.

The measurements were performed at all 3 selected carrier test frequencies. Refer to section 2.2.2 of this test report.

The following table summarizes the worst case detected emission levels (refer to spectral plots included on pages 28 – 48 for details):

Note:

The offset value indicated on the spectral plots represents the external attenuation value that includes the fixed attenuator plus the cable loss.

³ E-Mail Frank Coperich, FCC to Mike Nicolay, CTJC 02/25/2000

Carrier Test Frequency [MHz]	Spectral Plot on Page:	Frequency Marker Indication [MHz]	Indicated Power Level [dBm]	External Attn. [dB]	Worst Case Emission Level [dBm]	Compliance Limit [dBm]	Results
1930.4	28PAGER EF	1100.3	-61.1	31	-30.1	-13.0	compliant
1930.4	28PAGER EF	1928.9	-78.5	31	-47.5	-38.0	compliant
1930.4	29PAGER EF	1930.0	-62.2	31	-31.2	-13.0	compliant
1930.4	30PAGER EF	1990.7	-81.5	31	-50.2	-13.0	compliant
1930.4	31PAGER EF	1991.1	-81.8	31	-50.8	-38.0	compliant
1930.4	32PAGER EF	3861.8	-54.5	31	-23.5	-13.0	compliant
1930.4	33PAGER EF	6893.8	-55.9	31	-24.9	-13.0	compliant
1960.0	34PAGER EF	1501.1	-61.1	31	-30.1	-13.0	compliant
1960.0	35	1928.0	-80.6	31	-49.6	-38.0	compliant
1960.0	36	1930.0	-78.8	31	-47.8	-13.0	compliant
1960.0	37	1990.1	-79.5	31	-48.5	-13.0	compliant
1960.0	38	1992.4	-81.8	31	-50.8	-38.0	compliant
1960.0	39	3922.1	-55.0	31	-24.0	-13.0	compliant
1960.0	40	5871.7	-54.7	31	-23.7	-13.0	compliant
1989.6	41	1007.8	-61.3	31	-30.3	-13.0	compliant
1989.6	42	1928.9	-82.3	31	-51.3	-38.0	compliant
1989.6	43	1929.7	-82.2	31	-51.2	-13.0	compliant
1989.6	44	1990.0	-61.2	31	-30.2	-13.0	compliant
1989.6	45	1991.0	-77.7	31	-46.7	-38.0	compliant
1989.6	46	3982.3	-55.6	31	-24.6	-13.0	compliant
1989.6	47	5961.9	-54.4	31	-23.4	-13.0	compliant

Note:

The measured conducted emission levels were found to be compliant with the manufacturer’s specifications and with all requirements of the FCC rules.

2.7 Test No. 5: Field strength of spurious radiation (§ 2.1053, § 2.1057, § 24.238)

2.7.1 Purpose

The measurement of spurious radiated emissions was performed pursuant to § 2.1053 and § 2.1057 to verify that the field strength of any spurious emissions radiated directly from the cabinet, control circuits, power leads or intermediate circuit elements are attenuated below the transmitter power P by at least 43 + 10 log₁₀ (P in Watts) dB as is required by § 24.238 (Emission limits).

2.7.2 Limits and field strength calculations

Compliance with § 24.238 requires that all spurious emissions be attenuated below the transmitter power by at least 43 + 10 log₁₀ P (P = rated maximum transmitter output power in Watts).

The compliance field strength limit for radiated emissions is as follows:⁴:

$$E_{reference} = \frac{\sqrt{49.2 \cdot P}}{R}$$

where:

- E_{reference} = Electric field strength in Volts/Meter
- P = Rated maximum transmitter output power in Watts
- R = Distance in Meters

Using a fixed distance, R = 3 m, between the EUT and the receiver antenna and a rated maximum transmitter output power of 12.74 W, the radiated emission limit is:

$$E_{reference} = \frac{\sqrt{49.2 \cdot 23.99}}{3.0} = 11.45V / m = 141.18dB\mu V/m$$

Paragraph 24.238 requires that any emission be attenuated below the transmitter power by at least 43+10log₁₀ P (P = rated maximum transmitter output power).

The compliance limit was calculated as per the following table:

Rated maximum transmitter output power	23.99 W (=43.8 dBm)
Reference electric field strength (acc. 23.99 W)	141.18 dBμV/m
Required attenuation	43 + 10 log ₁₀ 23.99 = 56.8 dB
Reference electric field strength – required attenuation	141.18 dBμV/m – 56.8 dB
= compliance field strength limit	= 84.38 dBμV/m

According to § 2.1057, all emissions to the 10th harmonic were investigated.

2.7.3 EUT operation condition

The EUT was configured and operating as described in section 2.2.1. The radiated spurious emissions were determined for three selected carrier test frequencies, according to section 2.2.2. During all testing, the EUT's RF output power was terminated into a 50 Ω dummy load.

⁴ Reference Data for Radio Engineers, Page 676. International Telephone and Telegraph Corporation, Fourth Edition.

2.7.4 Test configuration

The measurements (scans) were conducted for BS-240U with two configurations. In configuration A the BS-240U base rack with 8 transceivers was used. For configuration B the BS-204U was extended by a service rack and an extension rack. The extension rack could carry also up to 8 transceivers and is controlled completely by the base rack.

The measurements were performed in the anechoic chamber at the Siemens AG EMC Center, Hofmannstraße 51, 81359 Munich, Germany. The radiated test site complies with the site attenuation requirements listed in ANSI C63.4 1992 and is listed with the FCC.

The test antenna was positioned at a distance of 3 m from the EUT. Photographs of the EUT in the anechoic chamber are shown on page 50 of this measurement report.

2.7.5 Measurement procedure

The EUT was rotated 360°. The antenna height was adjusted between 1 m and 4 m. Both, horizontal and vertical polarizations were investigated.

2.7.6 Measurement results & limits

Worst case detected emission levels are reported in the following table (refer to spectral plots included on pages 51 – 54 for details). The antenna factor and cable loss is according to the manufacturer’s specification.

Frequency [MHz]	Configuration	Meas. Value [dBµV]	Antenna Factor + Cable Loss [dB]	Field Strength [dBµV/m]	Compliance Level [dBµV/m]	Results
1961.8	A	51.0	28.9	79.9	84.3	compliant
12900.8	A	29.9	46.6	76.5	84.3	compliant
13952.6	A	27.7	50.5	78.2	84.3	compliant
17478.7	A	24.9	49.2	74.1	84.3	compliant
1943.0	B	46.7	28.8	75.5	84.3	compliant
7774.3	B	34.5	38.4	72.9	84.3	compliant

The measured conducted emission levels were found to be compliant with the manufacturer’s specifications and with all requirements of the FCC rules.

2.8 Test No. 6: Frequency stability (§ 2.1055, § 24.235)

2.8.1 Purpose

Frequency stability measurements were performed to verify that the frequency deviation of the emission stays within the licensee’s frequency block under extreme temperature conditions (-30°C to +50°C) and under variant power supply voltages (102 V to 138 V) (according to § 2.1055).

2.8.2 Limits

According to § 24.235, the frequency of the fundamental emission is required to stay within the authorized frequency block, independent of the ambient temperature and the power supply voltage level.

2.8.3 EUT operation condition

The standard setup procedure as described in section 2.2.1 of this report is used. The EUT was operated and tested in a climatic chamber.

2.8.4 Test configuration

The test configuration as described in section 2.2.4 of this application was used for the frequency stability measurements. A Rohde&Schwarz CMD57 mobile communication tester was used for all measurements.

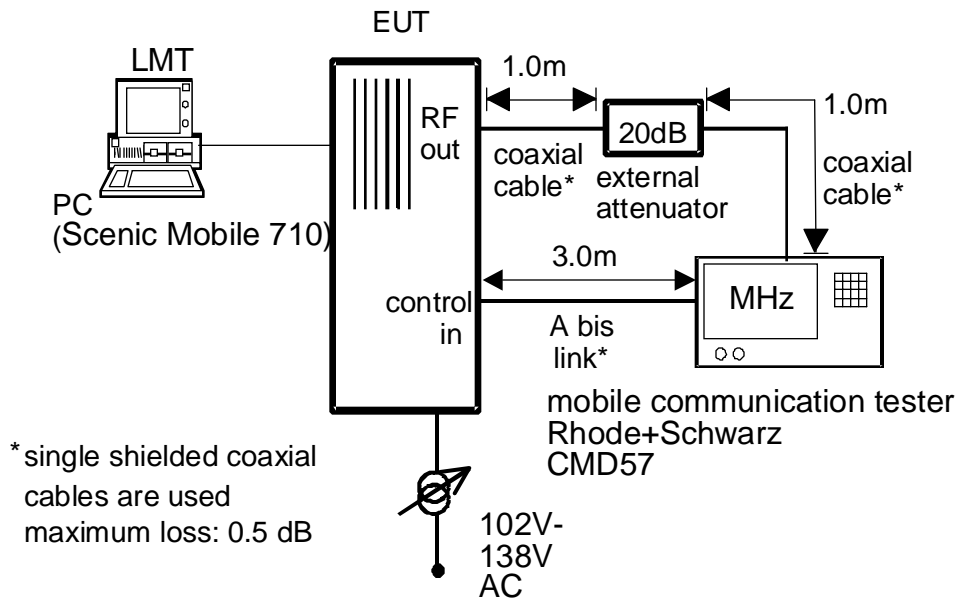

Note: An atomic clock reference (Efratom 4202) was used to increase the frequency resolution of the CMD 57

2.8.5 Measurement procedure

The center frequency deviation of the highest and lowest test frequency was measured at ambient temperature levels from -30°C to +50°C in 10°C intervals.

At each temperature level, the frequency was measured over a time period of 10 minutes, taking one measurement value every minute. In addition, all measurements were carried out at 3 different power supply voltage levels, ±15% of the rated operating voltage.

The supply voltage is measured at the power supply terminals of the EUT.

2.8.6 Measurement results

The following table includes the worst case detected frequency deviations. For complete measurement data see plots on pages 55 – 57.

Ambient Temp. [°C]	Frequency Deviation @ 85%=102V	Frequency Deviation @ 100%=120V	Frequency Deviation @ 115%=138V	Manufacturer's Specification	Results
-30	-0.00000080	-0.00000080	-0.00000093	0.000005 %	compliant
-20	-0.00000093	-0.00000085	-0.00000083	0.000005 %	compliant
-10	-0.00000070	-0.00000085	-0.00000083	0.000005 %	compliant
0	-0.00000085	-0.00000088	-0.00000109	0.000005 %	compliant
+10	-0.00000075	-0.00000078	-0.00000073	0.000005 %	compliant
+20	-0.00000088	-0.00000065	-0.00000073	0.000005 %	compliant
+30	-0.00000088	-0.00000093	-0.00000080	0.000005 %	compliant
+40	-0.00000093	-0.00000093	-0.00000088	0.000005 %	compliant
+50	-0.00000109	-0.00000106	-0.00000095	0.000005 %	compliant

A pseudo random bit sequence was applied to the modulator during all testing. No variation of the frequency deviation due to keying was observed. Also, no variation of the frequency deviation due to the EUT's heater element was observed at any temperature level or at any power supply voltage level (refer to measurement data above).

In all cases, the fundamental emission stayed within the authorized frequency block.

The measured frequency stability was found to be compliant with the manufacturer's specifications and with all requirements of the FCC rules.

2.9 Test No. 7: Slow frequency hopping

2.9.1 Introduction

Slow frequency hopping (SFH) is a new feature of PCS transceiver systems used to improve the signal quality under fading conditions. When SFH is activated, the carrier frequency is shifted to a different value on a timeslot per timeslot basis. This is depicted in the figure below (carrier test frequencies 1930.4 MHz, 1960.0 MHz, and 1989.6 MHz).

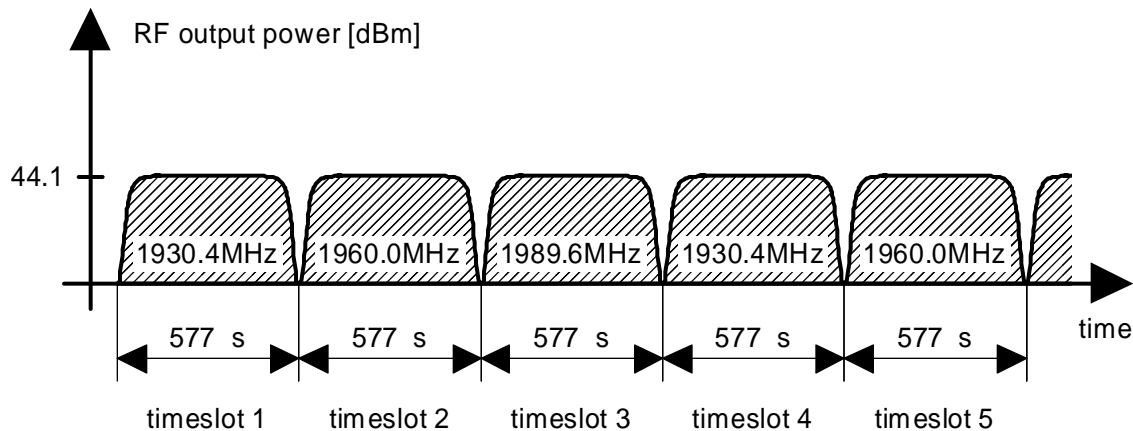

Fig. 2 – Slow frequency hopping (SFH) comprising 3 carrier test frequencies (1930.4 MHz, 1960.0 MHz, and 1989.6 MHz).

SFH allows only one carrier per transmitter being activated at a time. This ensures that no intermodulation products are produced.

2.9.2 Purpose

These measurements were performed to verify that under SFH operating conditions, spurious emissions due to intermodulation products and periodically shifting the carrier frequency were not produced above the compliance level required under § 2.1051 of the FCC rules.

2.9.3 EUT operation condition

The EUT was configured and operating in a typical operation mode as described in section 2.2.1. The SFH operating mode was switched on throughout the measurements. 3 hopping test frequencies were measured in accordance with section 2.2.2 of this application. Please refer to Fig. 2 for the hopping scheme.

2.9.4 Test configuration

A test configuration was as described in section 2.2.4 of this application. See page 6 for a block diagram (Fig. 1).

2.9.5 Measurement procedure

A spectrum analyzer model Rohde&Schwarz FSIQ 26 was used to verify that all emission are below the permissible limit.

2.9.6 Measurement results

SFH did not cause any detectable emissions above the compliance limits required by the FCC rules.

The following table summarizes the worst case detected emission levels.

Note:

The offset value indicated on the spectral plots represents the external attenuation value that includes the fixed attenuator plus the cable loss.

Frequency [MHz]	Indicated Power Level [dBm]	External Attenuation [dB]	Measured Power Level [dBm]	Compliance Limit [dBm]	Results
1923.3	-51.5	31.0	-20.5	-13.0	compliant
1934.1	-55.2	31.0	-24.2	-13.0	compliant
1944.6	-51.4	31.0	-20.4	-13.0	compliant
1947.8	-54.4	31.0	-23.4	-13.0	compliant
1981.0	-51.2	31.0	-20.2	-13.0	compliant
1982.6	-55.1	31.0	-24.1	-13.0	compliant

The above listed emission levels were taken from measurements conducted using three different RBW (resolution bandwidth) settings (1 MHz, 300 kHz, and 3 kHz). The MaxHold mode of the spectrum analyzer was activated to capture worst case emission levels. Copies of the spectral plots can be found on pages 58 – 61.

Note:

It was verified through measurements that SFH does not cause any adverse effects on other parameters of the transmitter (RF power output, modulation characteristics, occupied bandwidth, spurious emissions, and frequency stability).

The measurement values were found to be compliant with the manufacturer's specifications and with all requirements of the FCC rules.

3 Measurement data and spectral plots

3.1 Part list of the measurement test equipment

No.	Item	Model	Serial Number
1	Personal computer	Scenic Mobile 710	98520197
2	Spectrum analyzer	FSIQ 26	1119.6001.26
3	Mobile Communication Tester	CMD57	1050.9008.57/838770/0005
4	Atomic clock reference	Efratom 4202	81600000/001
5	Attenuator	BN 74 53 95	5/93
6	Automatic EMI Measuring System: 20Hz - 26.5GHz: Receivers: 20Hz-26.5GHz (Conducted/Radiated Emissions) 30MHz-1000MHz (Radiated Emission) EMI Testsoftware ES-K1,Version 1.40C	Rohde & Schwarz ESMI ESVP	System No.5 Cal. valid Nov.97
7	3-Phase LISN)* 32 Amps	Rohde & Schwarz ESH3-Z5	893406/019
8	Bilog-Antenna 30MHz-1GHz	CHASE CBL6111A	1566
9	Automatic Antenna Mast	Deisel MA240	240/333

Remark)* ... The impedance characteristic of this LISN complies with that as defined in FCC requirements and CISPR 16-1.

3.2 Spectral plots

**Test No. 1: RF Power Output
(Carrier Test Frequency = 1930.4 MHz)**

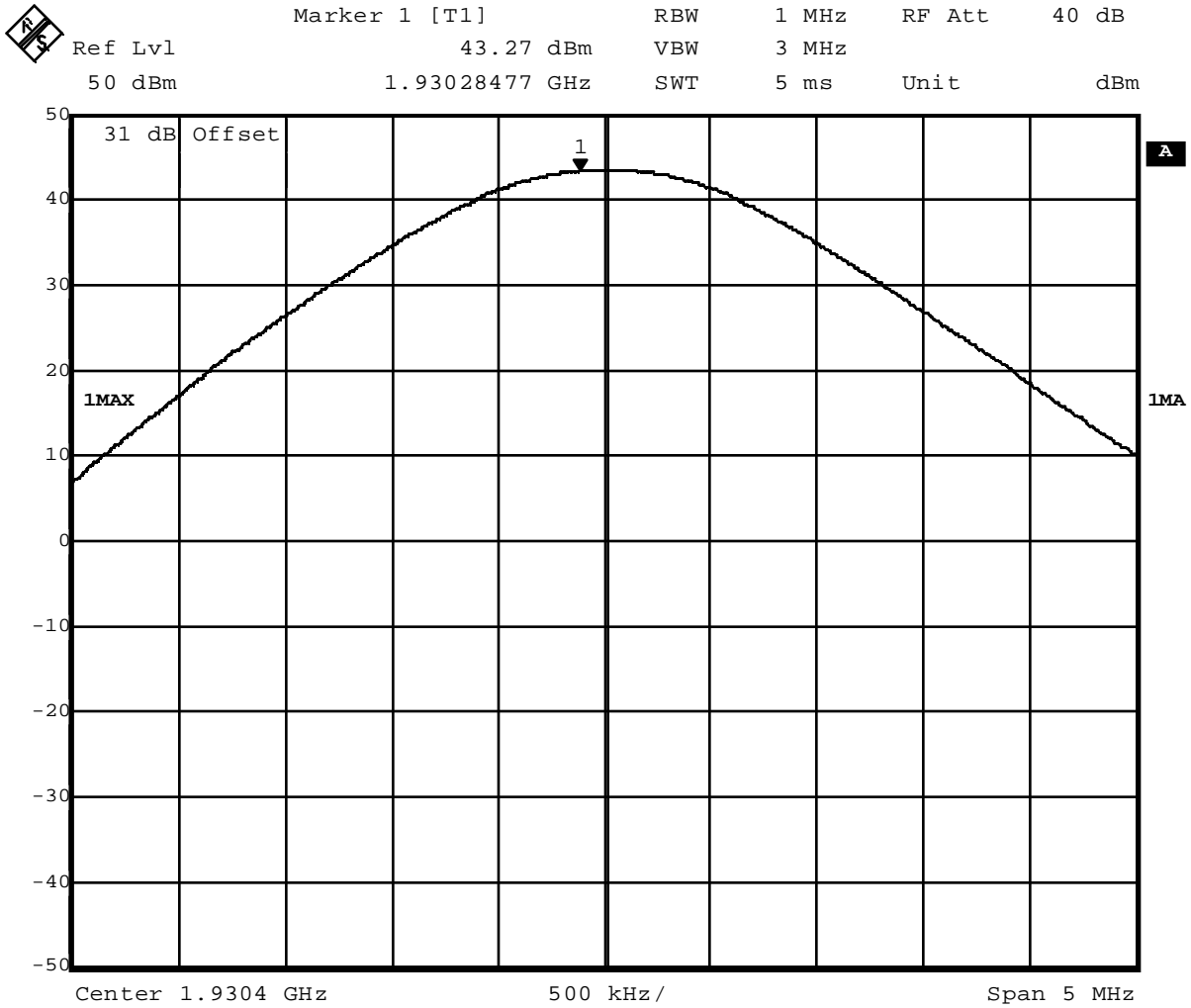

Date: 20.MAR.2000 15:37:40

Fig. 3 – RF power at the antenna connector.

Note:

The external attenuation of 31 dB is included in the spectral plot. This accounts for the external attenuator and the cable loss during the testing.

Test No. 1: RF Power Output
(Carrier Test Frequency = 1960.0 MHz)

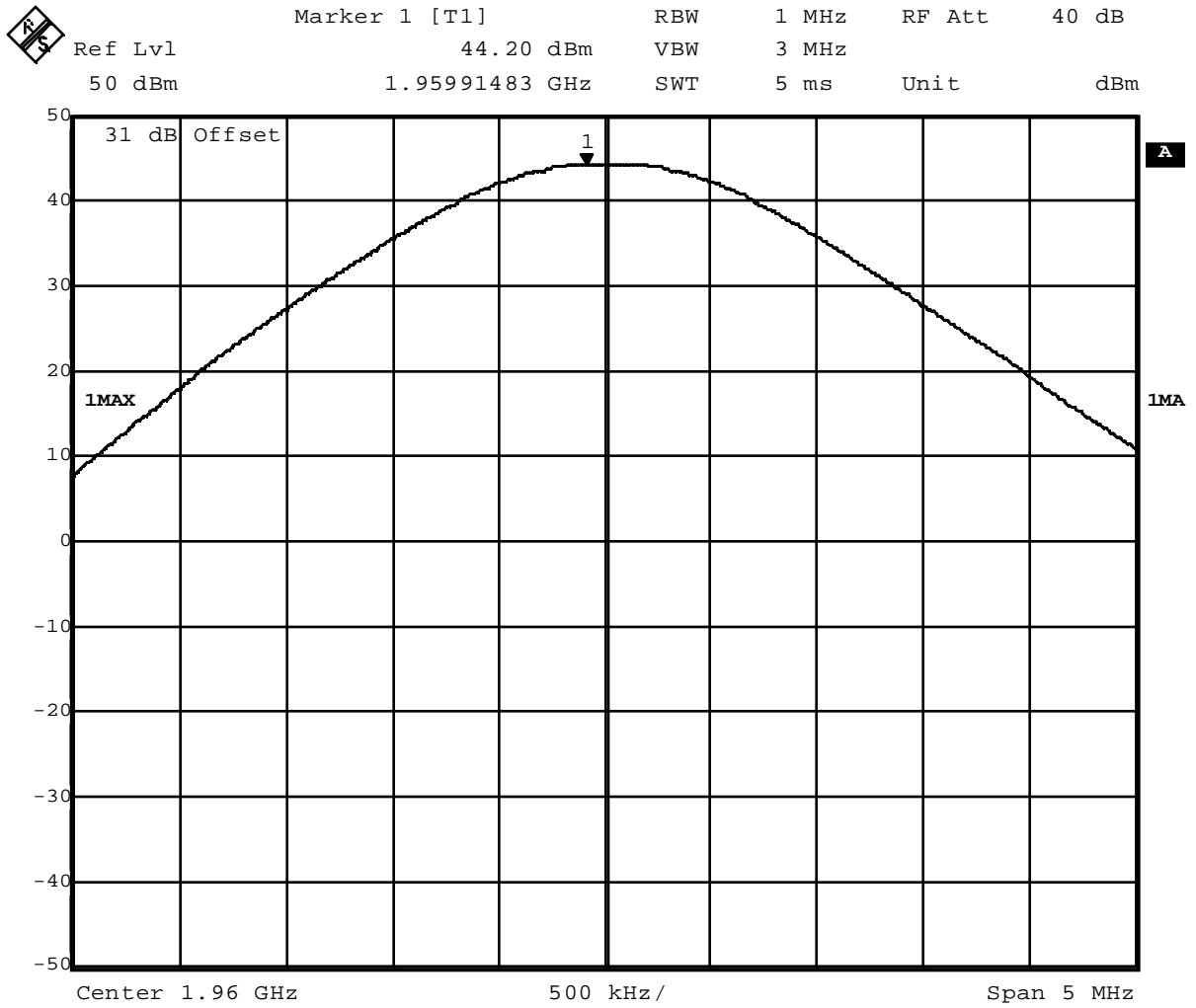

Date: 20.MAR.2000 15:29:53

Fig. 4 – RF power at the antenna connector.

Note:

The external attenuation of 31 dB is included in the spectral plot. This accounts for the external attenuator and the cable loss during the testing.

Test No. 1: RF Power Output
(Carrier Test Frequency = 1989.6 MHz)

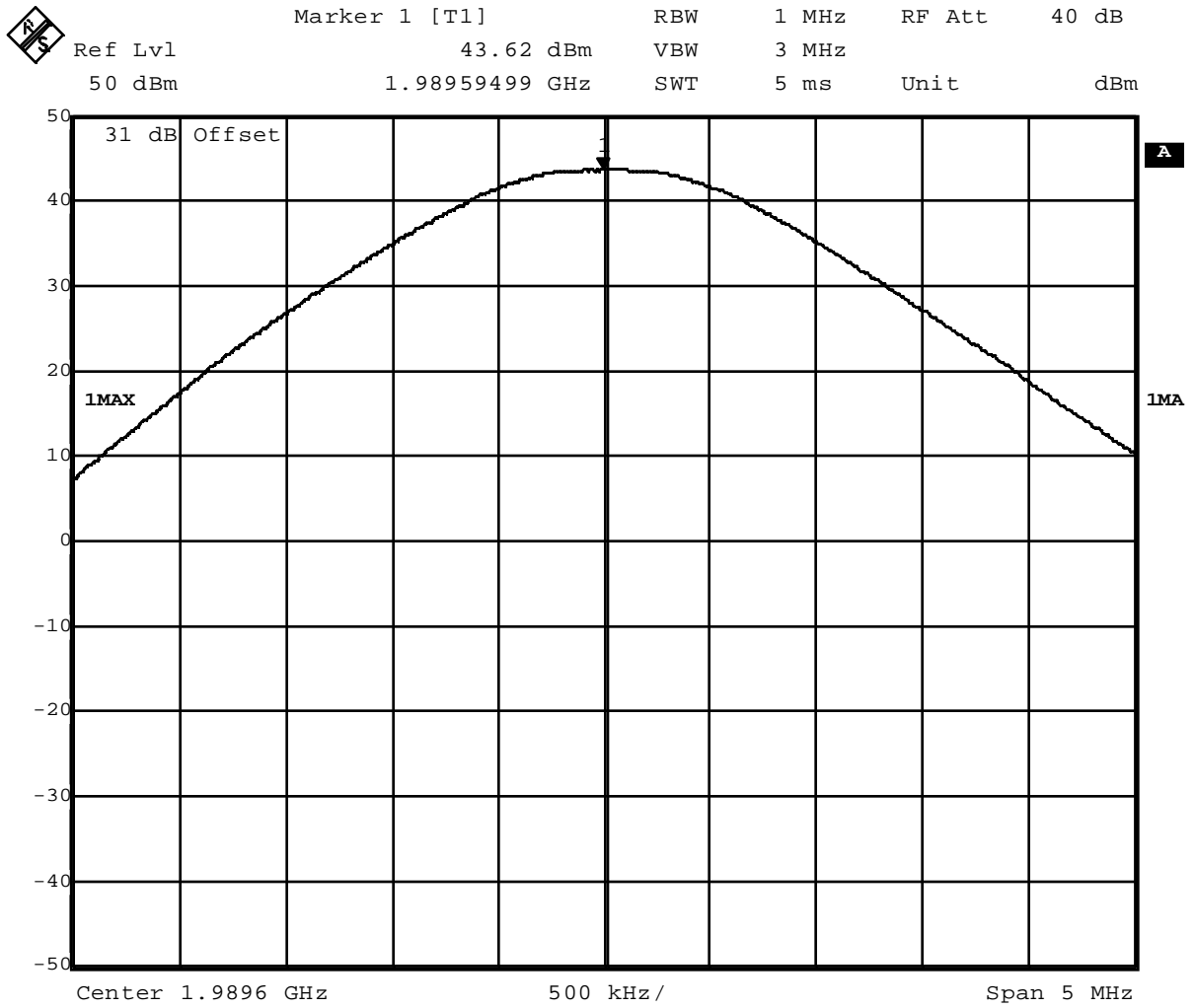

Date: 20.MAR.2000 15:50:42

Fig. 5 – RF power at the antenna connector.

Note:

The external attenuation of 31 dB is included in the spectral plot. This accounts for the external attenuator and the cable loss during the testing.

Test No. 2: Modulation Characteristics

No additional measurements are required for the modulation characteristics. Please refer to test no. 3, occupied bandwidth on page 10.

**Test No. 3: Occupied Bandwidth
(Carrier Test Frequency = 1930.4 MHz)**

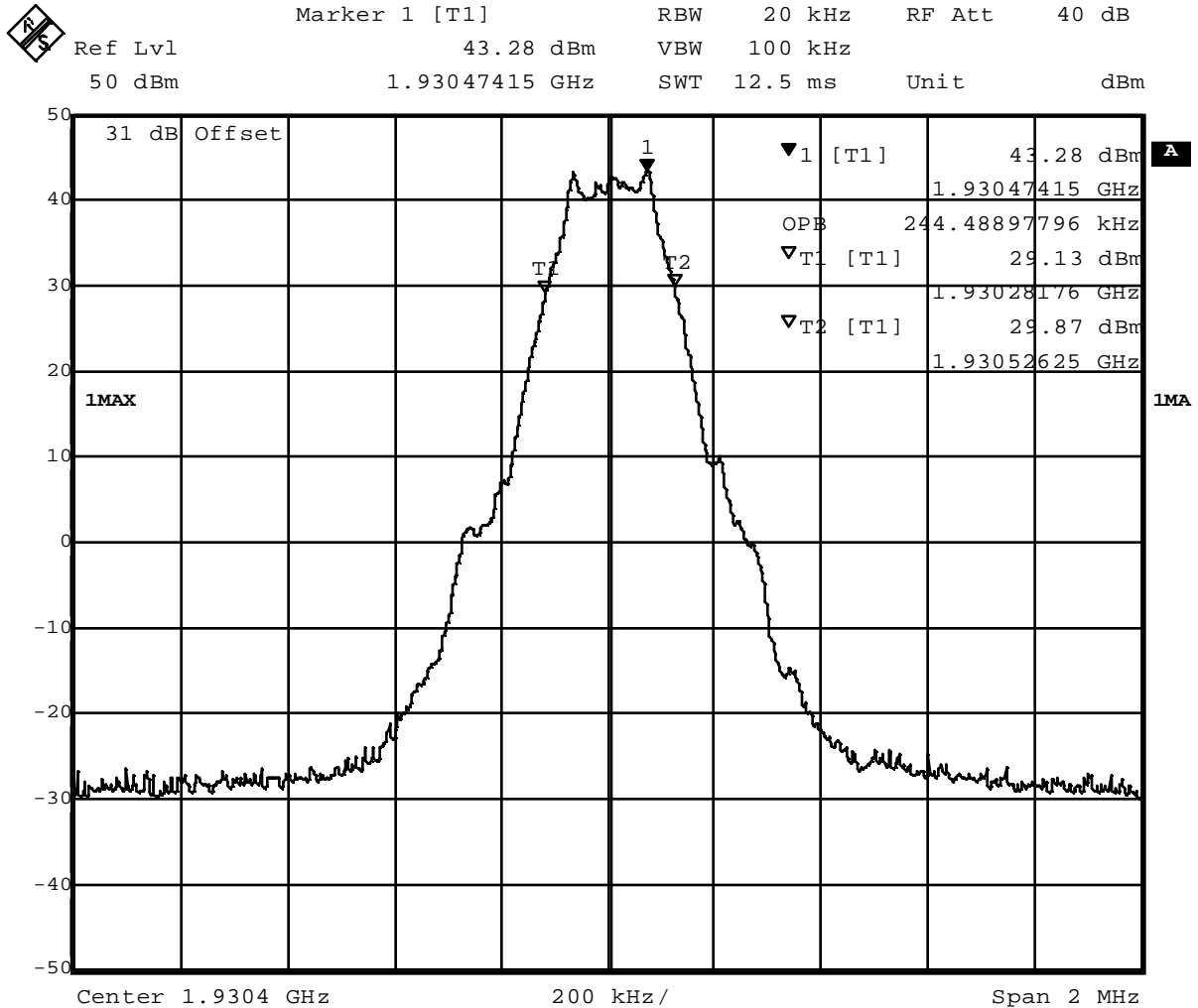

Date: 20.MAR.2000 15:38:17

Fig. 6 – Occupied bandwidth.

Note:

The external attenuation of 31 dB is included in the spectral plot. This accounts for the external attenuator and the cable loss during the testing.

**Test No. 3: Occupied Bandwidth
(Carrier Test Frequency = 1960.0 MHz)**

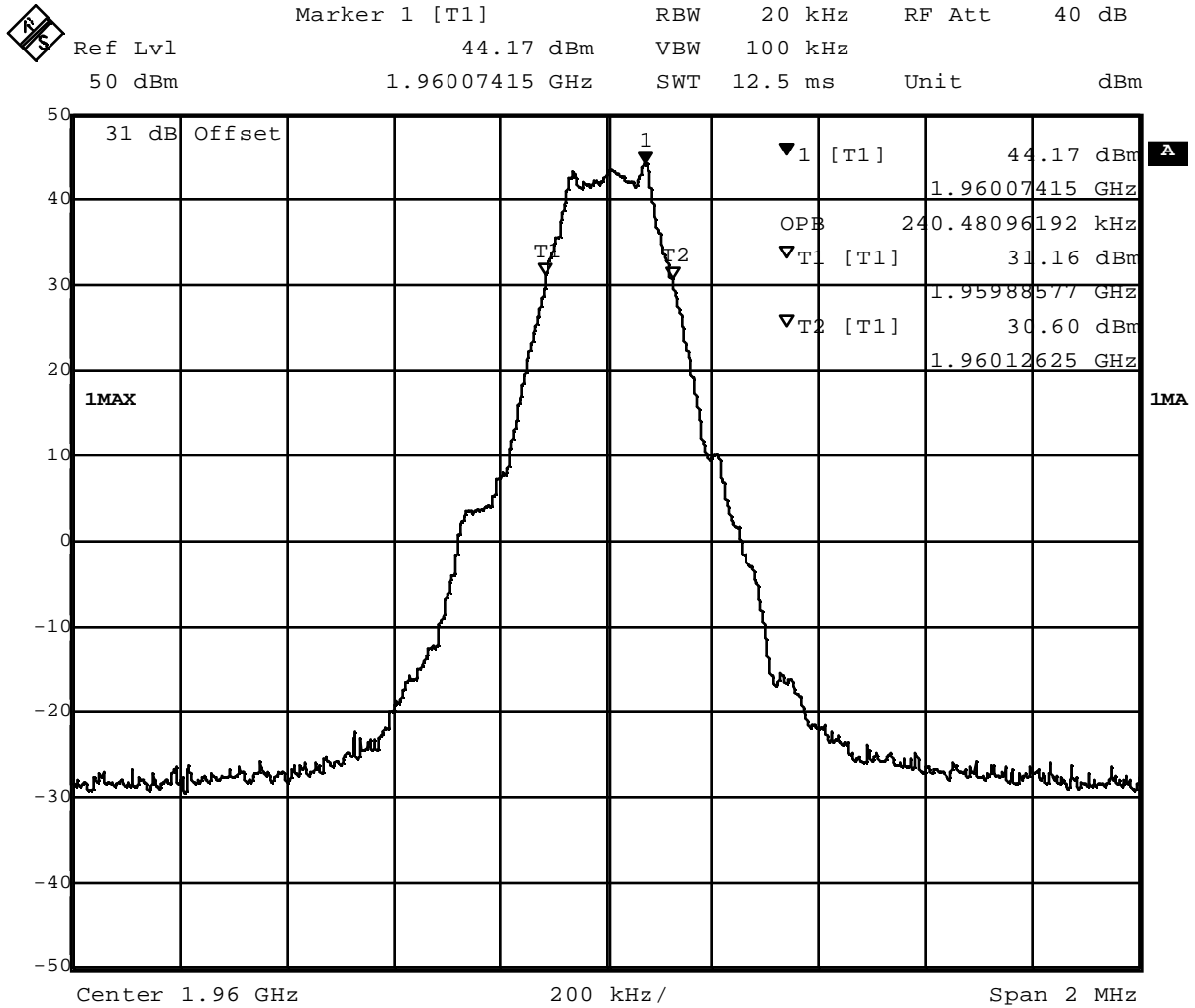

Date: 20.MAR.2000 15:30:30

Fig. 7 – Occupied bandwidth.

Note:

The external attenuation of 31 dB is included in the spectral plot. This accounts for the external attenuator and the cable loss during the testing.

**Test No. 4: Spurious Emissions at the Antenna Terminals
(Carrier Test Frequency = 1930.4 MHz)**

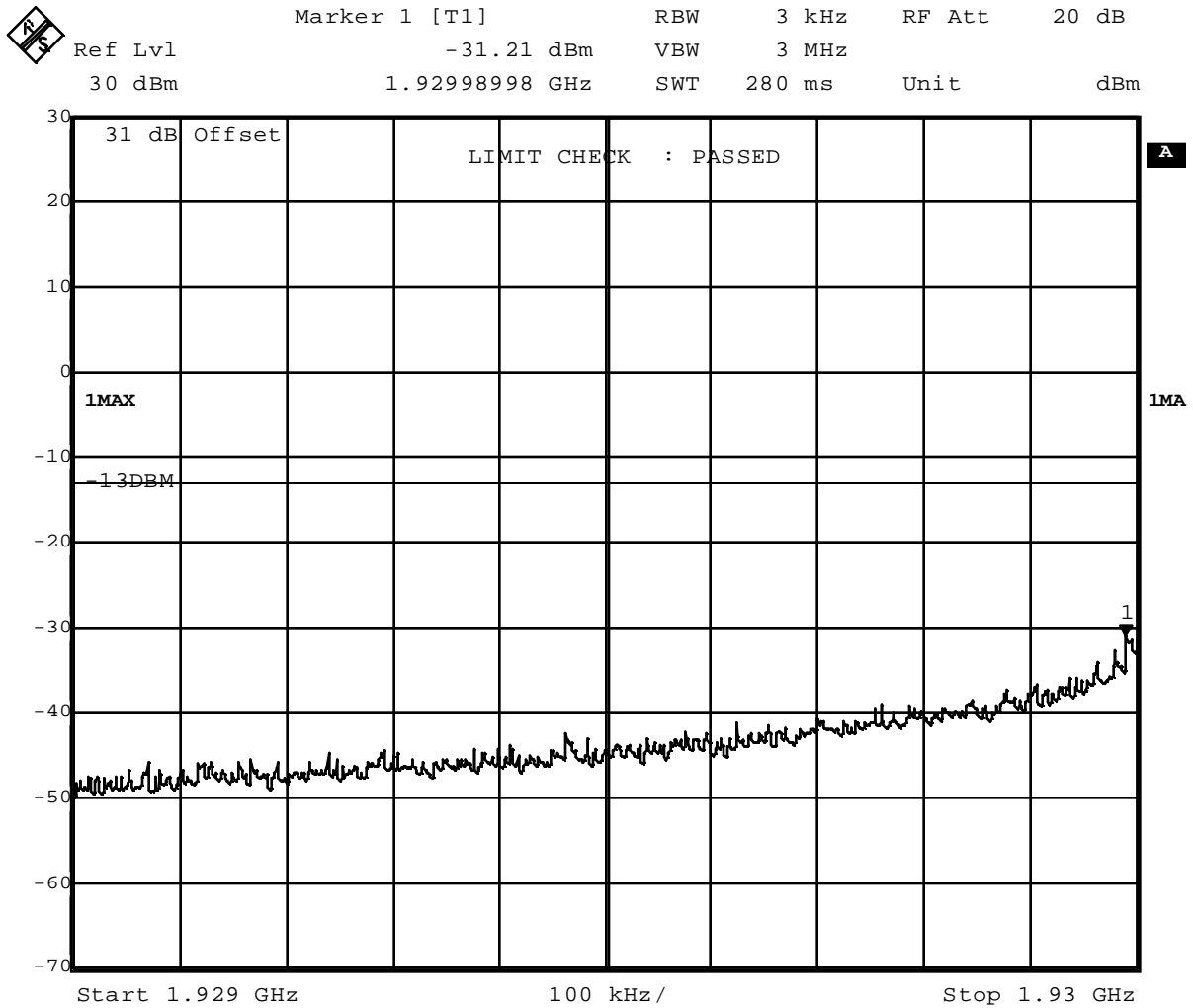

Comment A: Compliance Limit: -13 dBm
 Date: 20.MAR.2000 15:39:12

Fig. 11 – Spurious emissions in the frequency range 1929 MHz – 1930 MHz.

Note:
 The external attenuation of 31 dB is included in the spectral plot. This accounts for the external attenuator and the cable loss during the testing.

**Test No. 4: Spurious Emissions at the Antenna Terminals
(Carrier Test Frequency = 1930.4 MHz)**

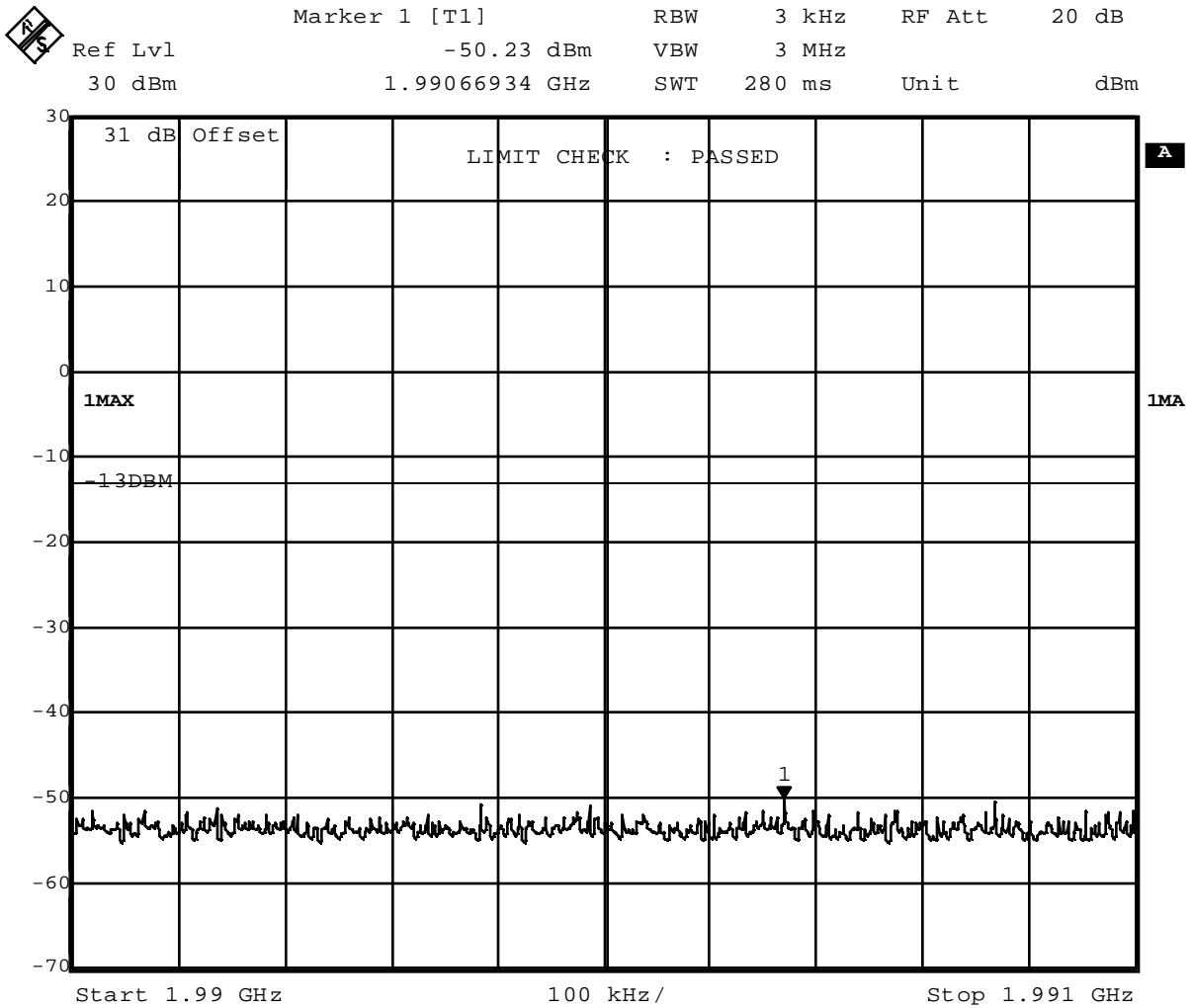

Comment A: Compliance Limit: -13 dBm
Date: 20.MAR.2000 16:24:21

Fig. 12 – Spurious emissions in the frequency range 1990 MHz – 1991 MHz.

Note:

The external attenuation of 31 dB is included in the spectral plot. This accounts for the external attenuator and the cable loss during the testing.

**Test No. 4: Spurious Emissions at the Antenna Terminals
(Carrier Test Frequency = 1930.4 MHz)**

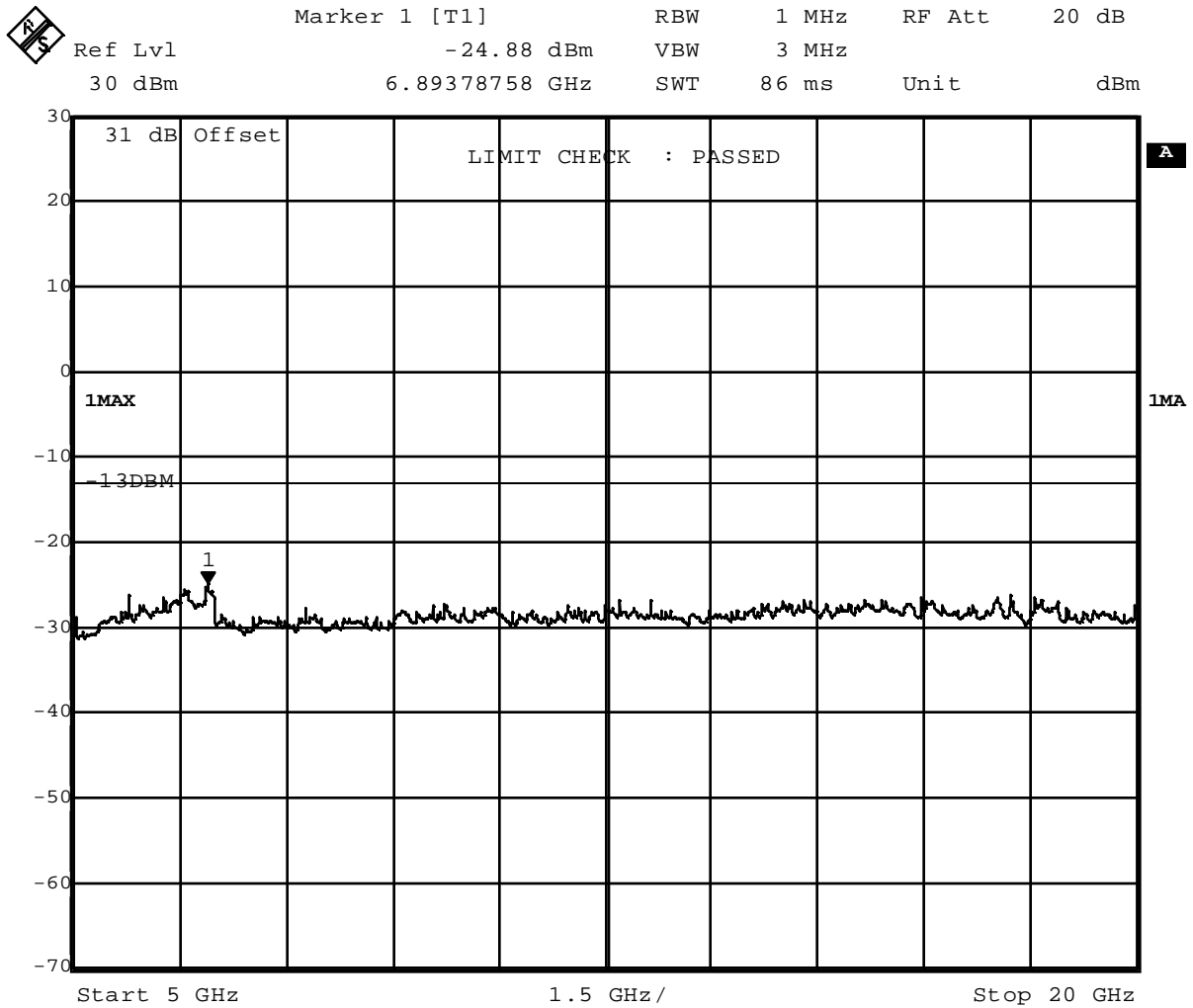

Comment A: Compliance Limit: -13 dBm
Date: 20.MAR.2000 15:40:44

Fig. 15 – Spurious emissions in the frequency range 5000 MHz – 20000 MHz.

Note:

The external attenuation of 31 dB is included in the spectral plot. This accounts for the external attenuator and the cable loss during the testing.

**Test No. 4: Spurious Emissions at the Antenna Terminals
(Carrier Test Frequency = 1960.0 MHz)**

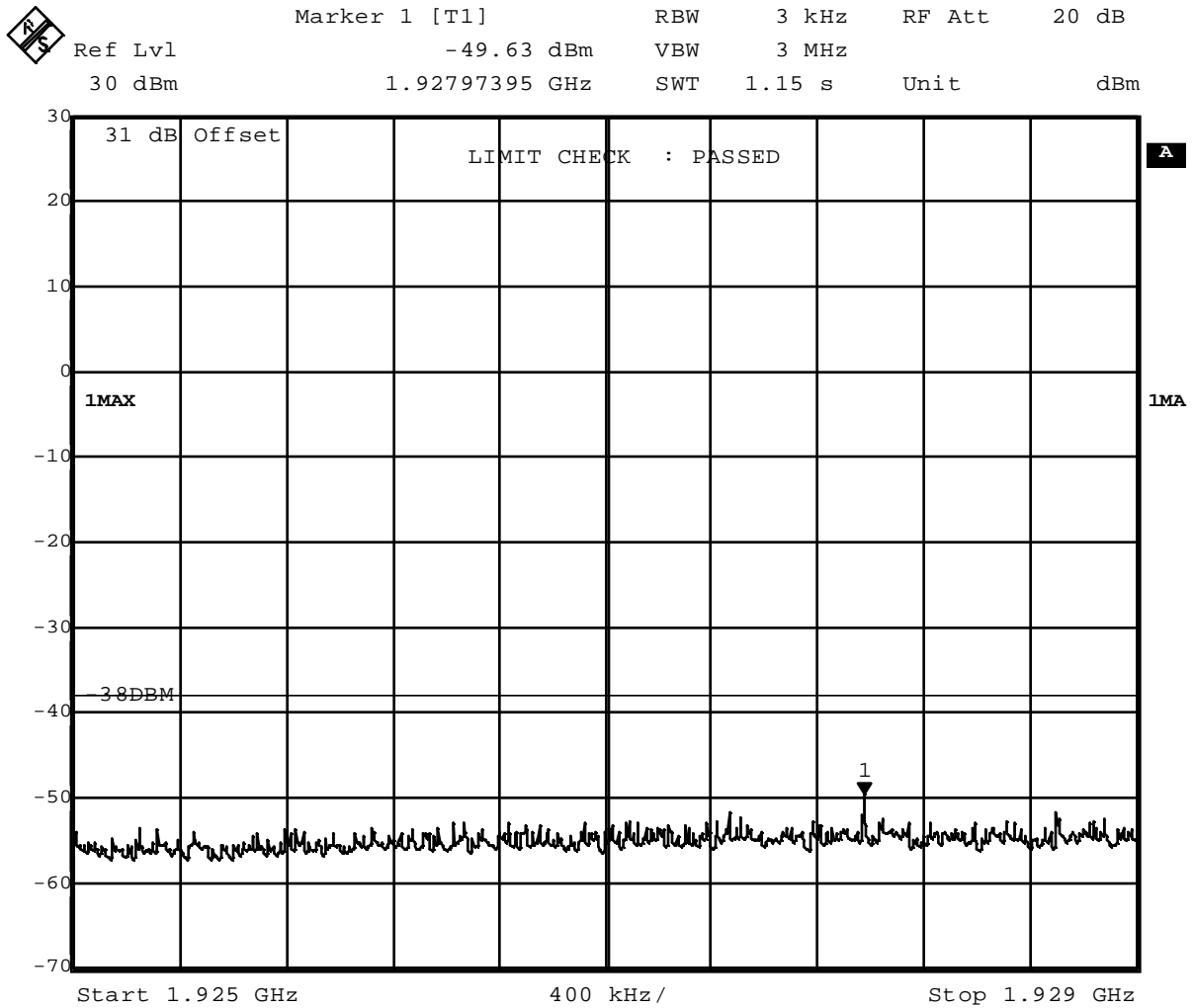

Comment A: Compliance Limit: -13dBm-25.2dB=-38.2dBm
 Date: 20.MAR.2000 16:34:36

**Fig. 17 – Spurious emissions in the frequency range 1925 MHz – 1929 MHz.
 Limit: -13dBm-25.2dB=-38.2dBm**

Note:
 The external attenuation of 31 dB is included in the spectral plot. This accounts for the external attenuator and the cable loss during the testing.

**Test No. 4: Spurious Emissions at the Antenna Terminals
(Carrier Test Frequency = 1960.0 MHz)**

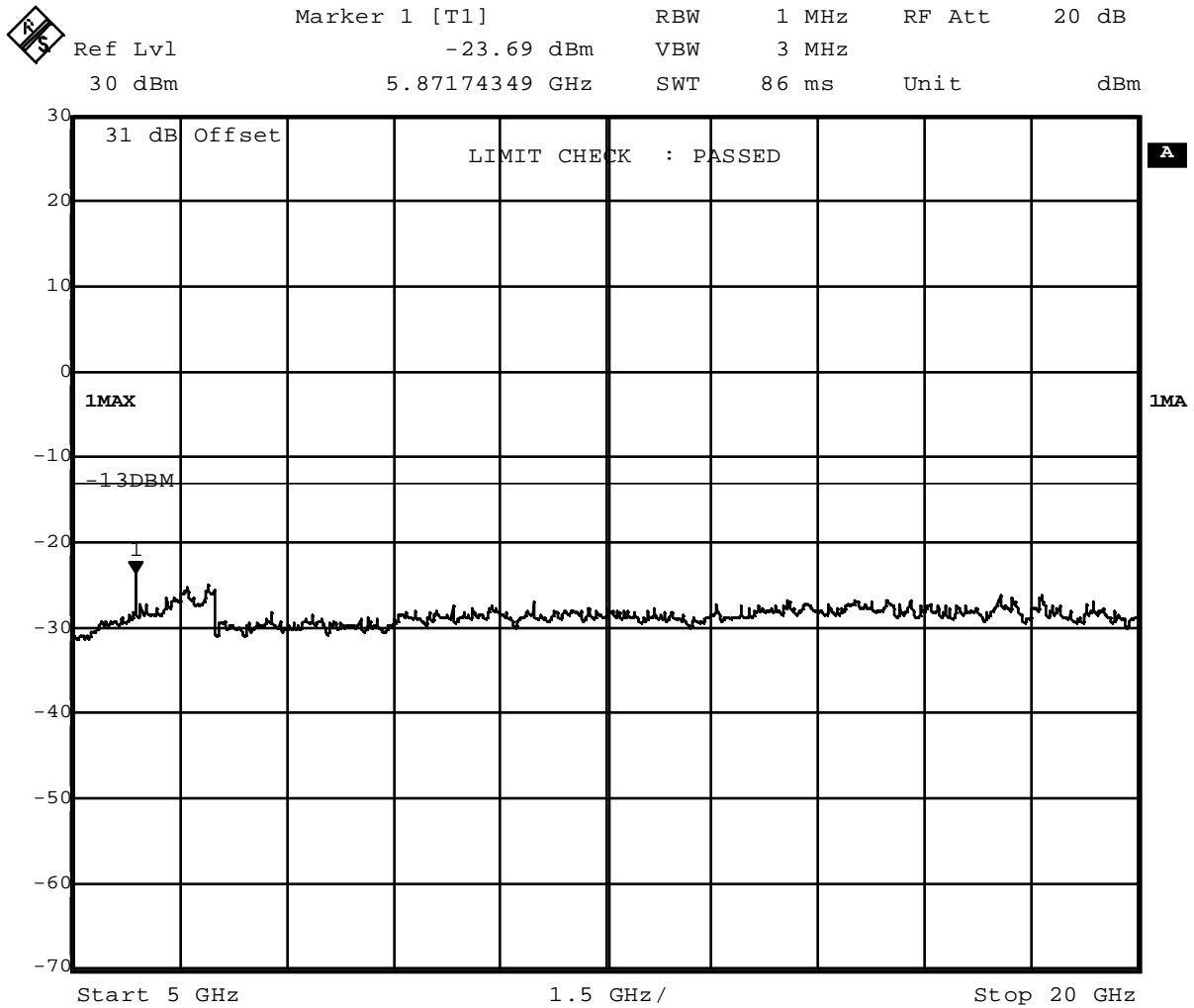

Comment A: Compliance Limit: -13 dBm
Date: 20.MAR.2000 15:32:57

Fig. 22 – Spurious emissions in the frequency range 5000 MHz – 20000 MHz.

Note:

The external attenuation of 31 dB is included in the spectral plot. This accounts for the external attenuator and the cable loss during the testing.

**Test No. 4: Spurious Emissions at the Antenna Terminals
(Carrier Test Frequency = 1989.6 MHz)**

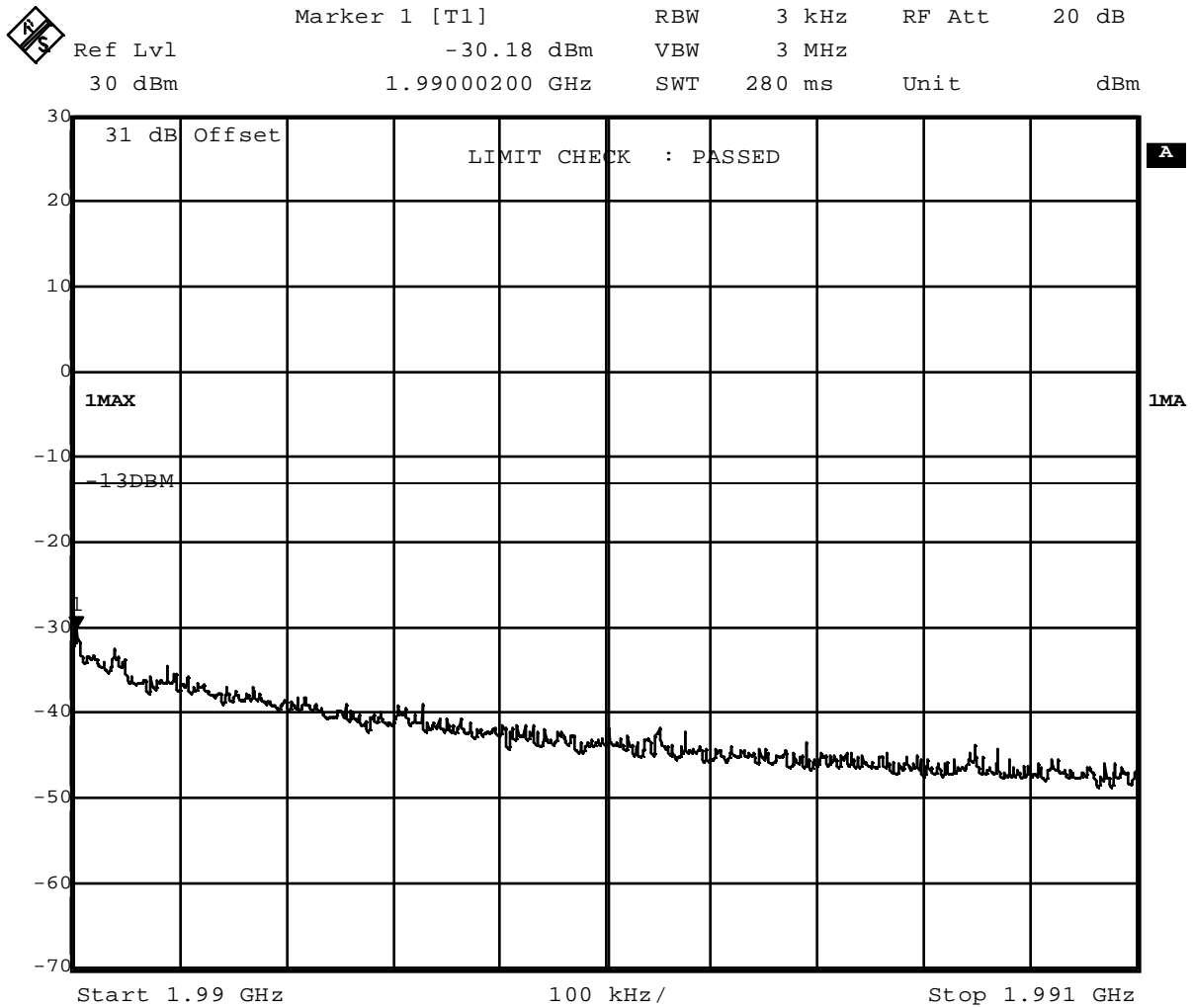

Comment A: Compliance Limit: -13 dBm
Date: 20.MAR.2000 16:41:35

Fig. 26 – Spurious emissions in the frequency range 1990 MHz – 1991 MHz.

Note:

The external attenuation of 31 dB is included in the spectral plot. This accounts for the external attenuator and the cable loss during the testing.

**Test No. 4: Spurious Emissions at the Antenna Terminals
(Carrier Test Frequency = 1989.6 MHz)**

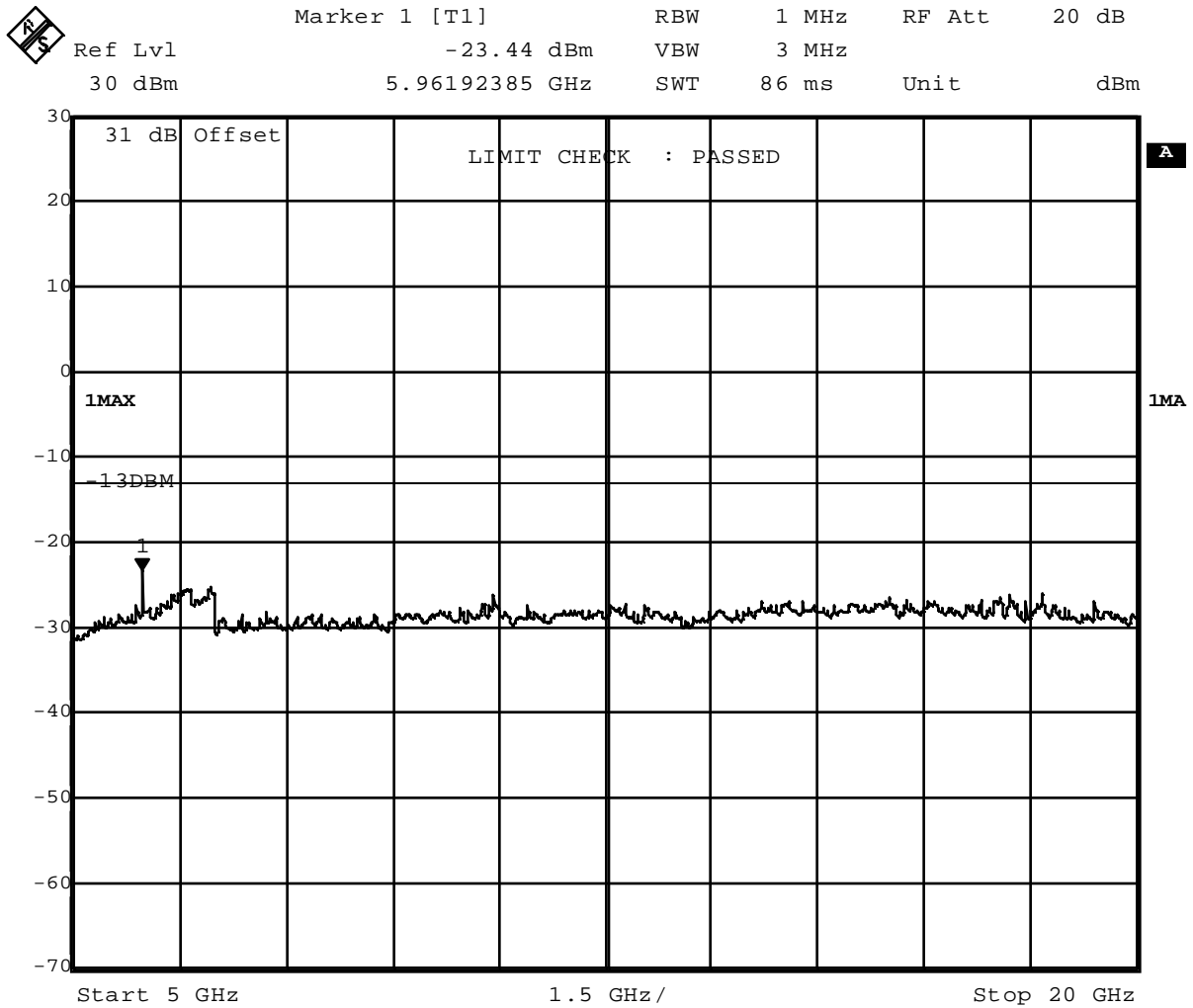

Comment A: Compliance Limit: -13 dBm
Date: 20.MAR.2000 15:53:46

Fig. 29 – Spurious emissions in the frequency range 5000 MHz – 20000 MHz.

Note:

The external attenuation of 31 dB is included in the spectral plot. This accounts for the external attenuator and the cable loss during the testing.

**Test No. 4: Spurious Emissions at the Antenna Terminals:
Filter Characteristic of the FSIQ26 Spectrum Analyzer's Resolution Filter**

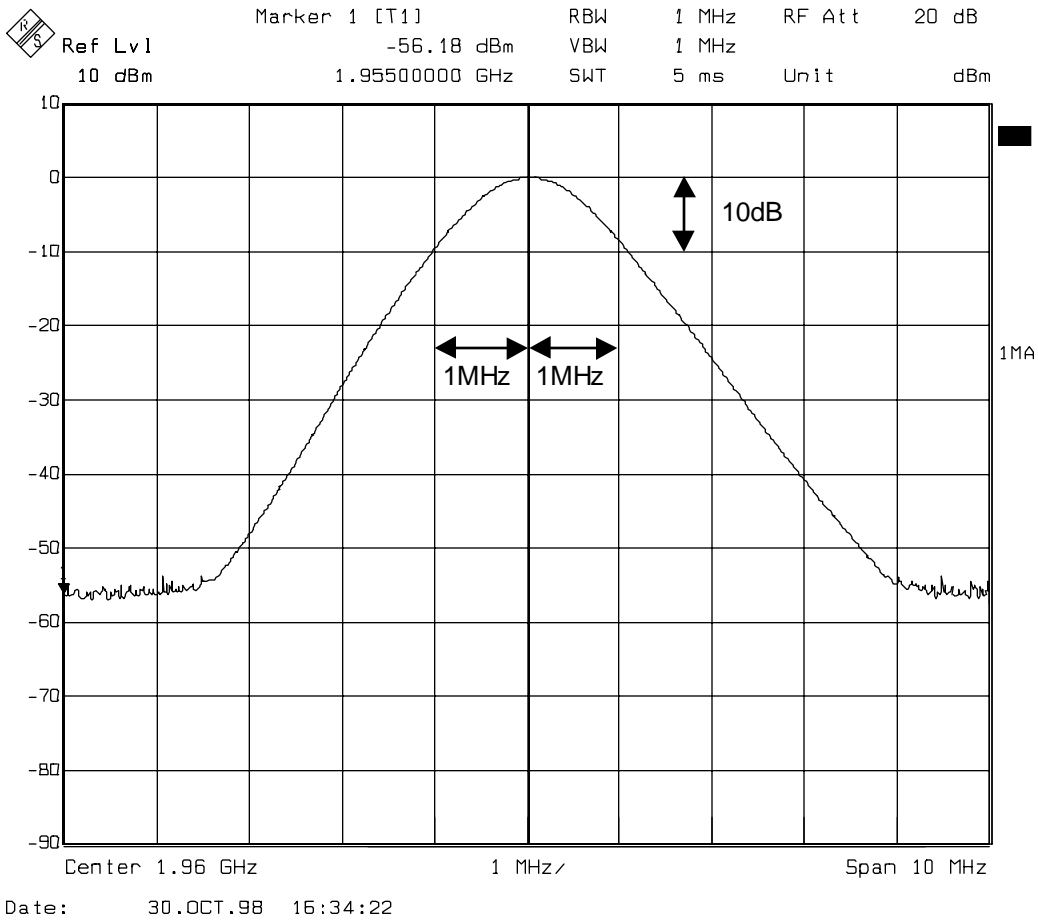

Fig. 30 – Filter characteristic of the 1 MHz resolution filter.

Test No. 5: Field Strength of Spurious Radiation

Fig. 31 -- Photograph of the anechoic chamber with the EUT (configuration A).

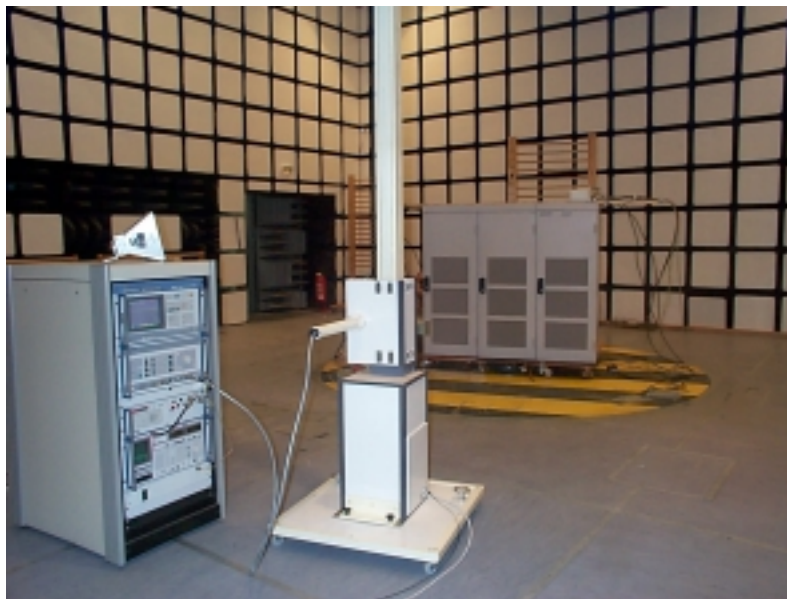

Fig. 32 – Photograph of the anechoic chamber with the EUT (configuration B) and antenna.

Test No. 5: Field strength of spurious radiation

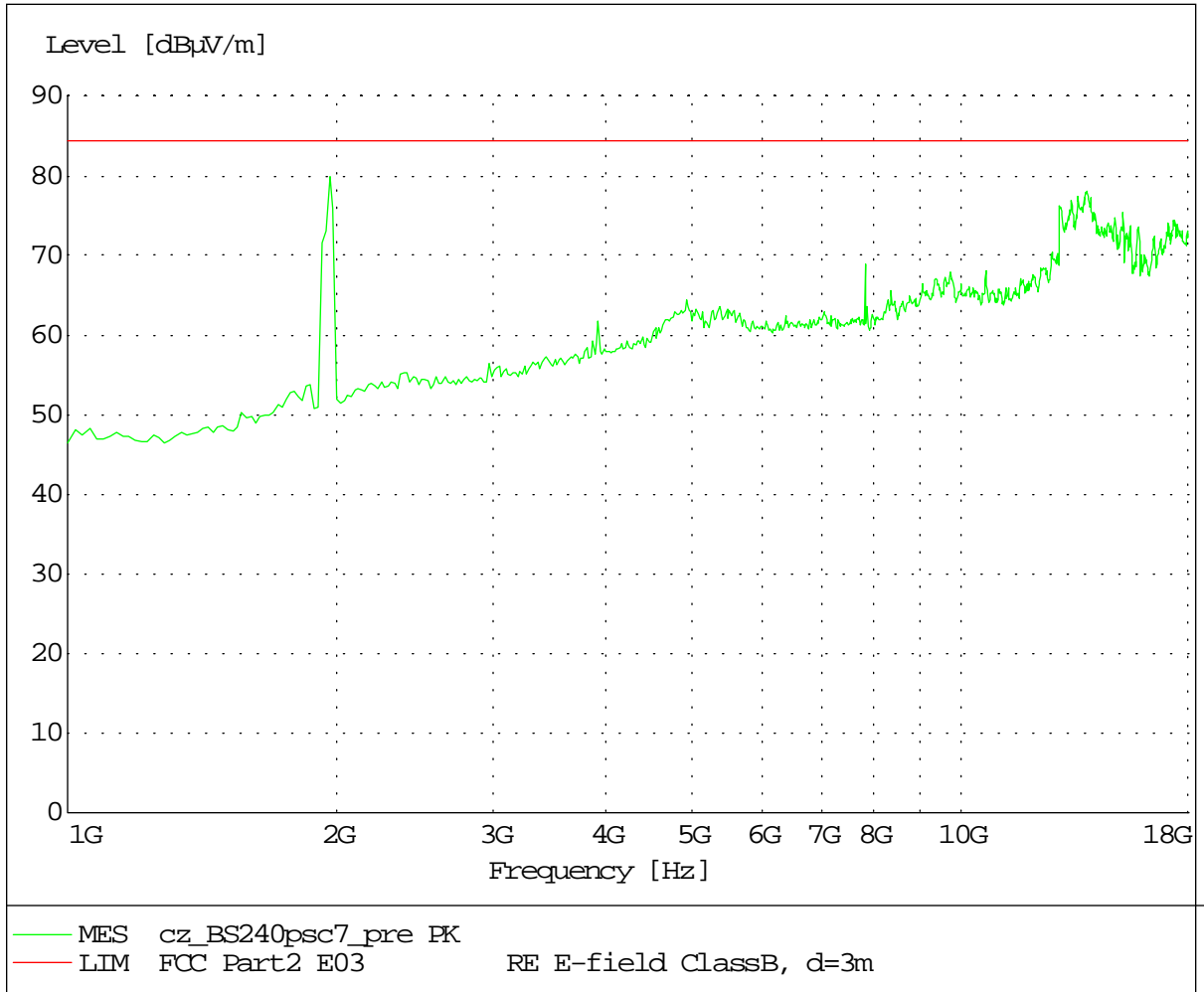

Fig. 33 – Radiated Emission 1GHz – 18 GHz, configuration A.

Test No. 5: Field strength of spurious radiation

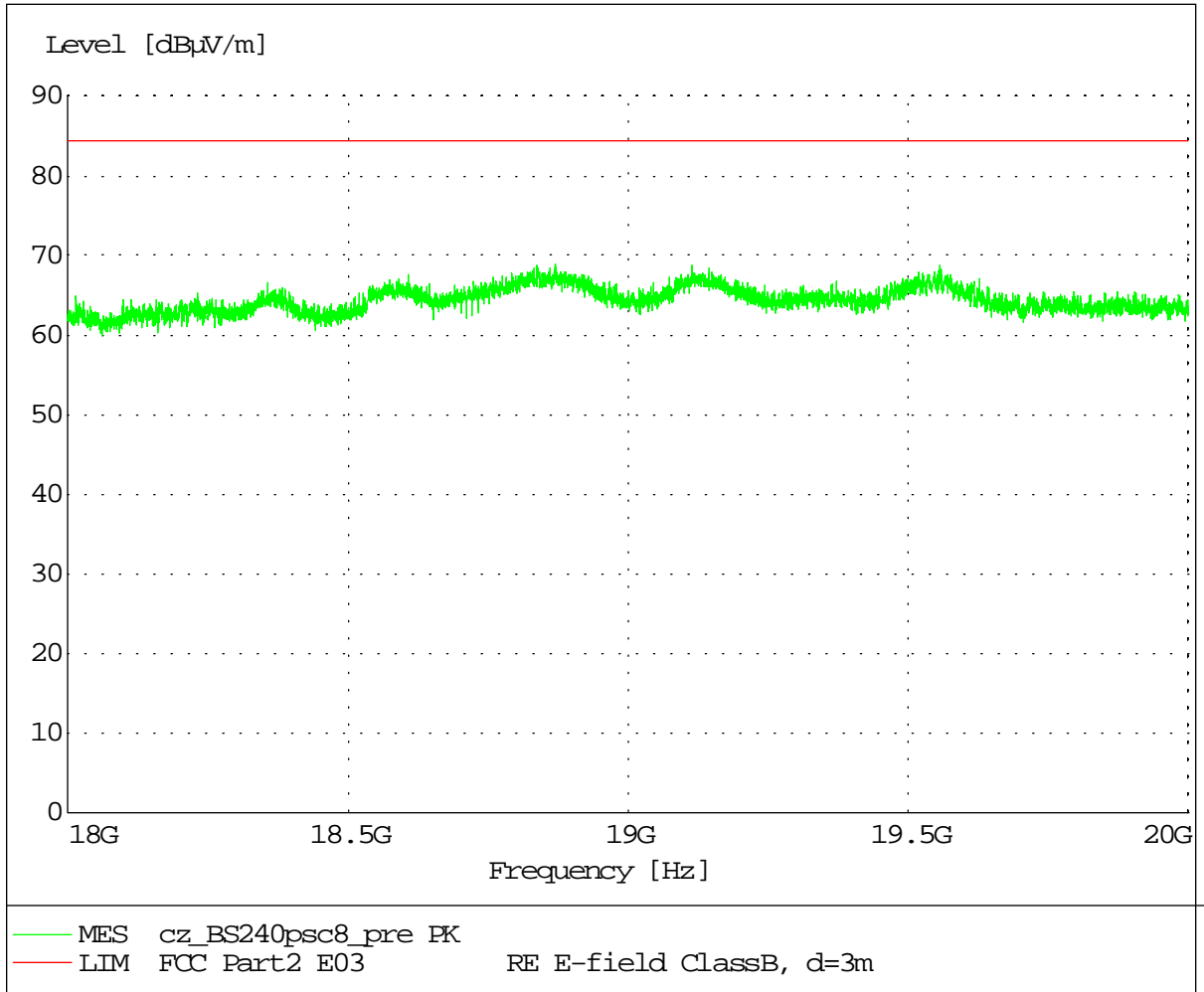

Fig. 34 – Radiated Emission 18 GHz – 20 GHz, configuration A.

Test No. 5: Field strength of spurious radiation

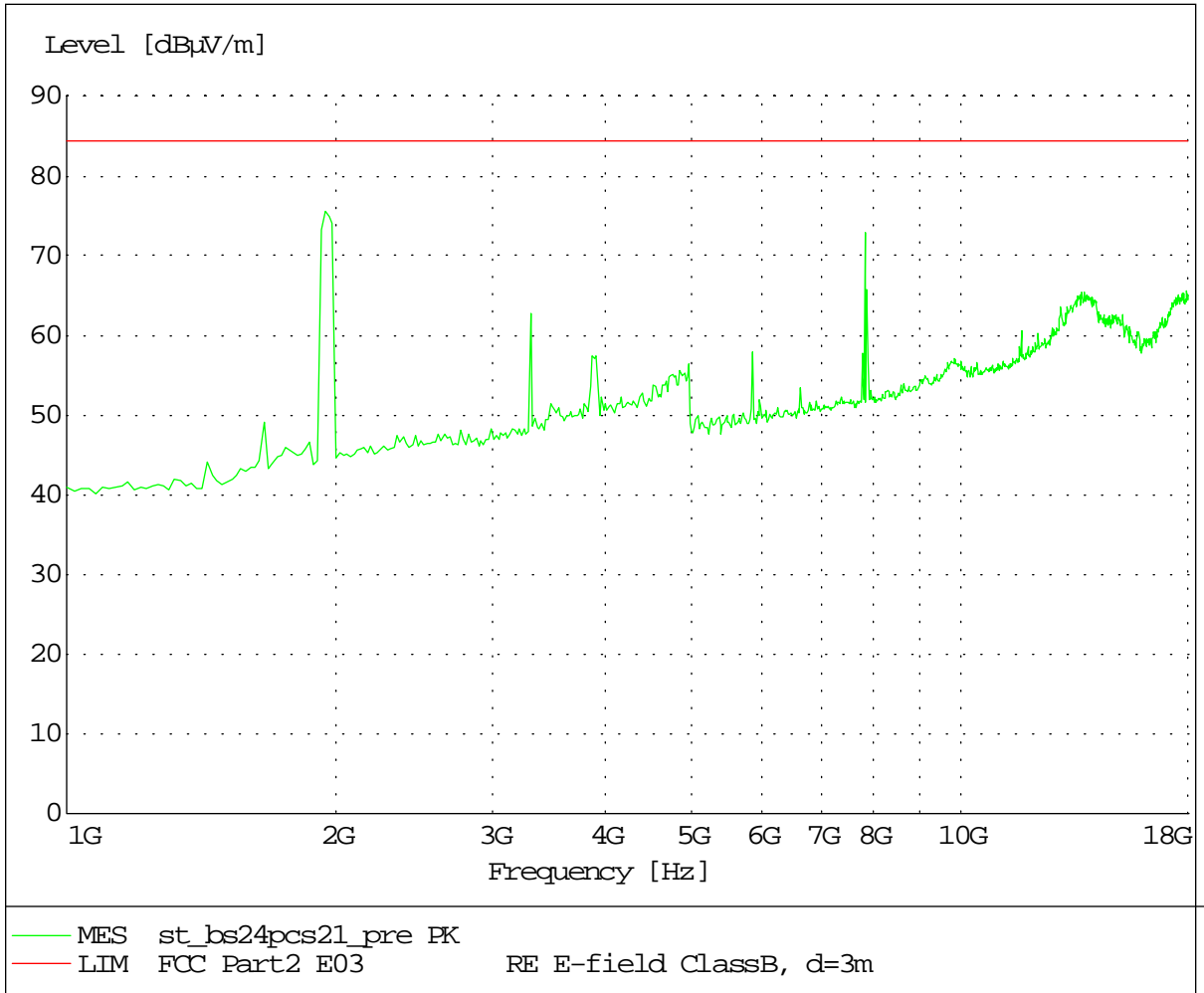

Fig. 35 – Radiated Emission 1GHz – 18 GHz, configuration B.

Test No. 5: Field strength of spurious radiation

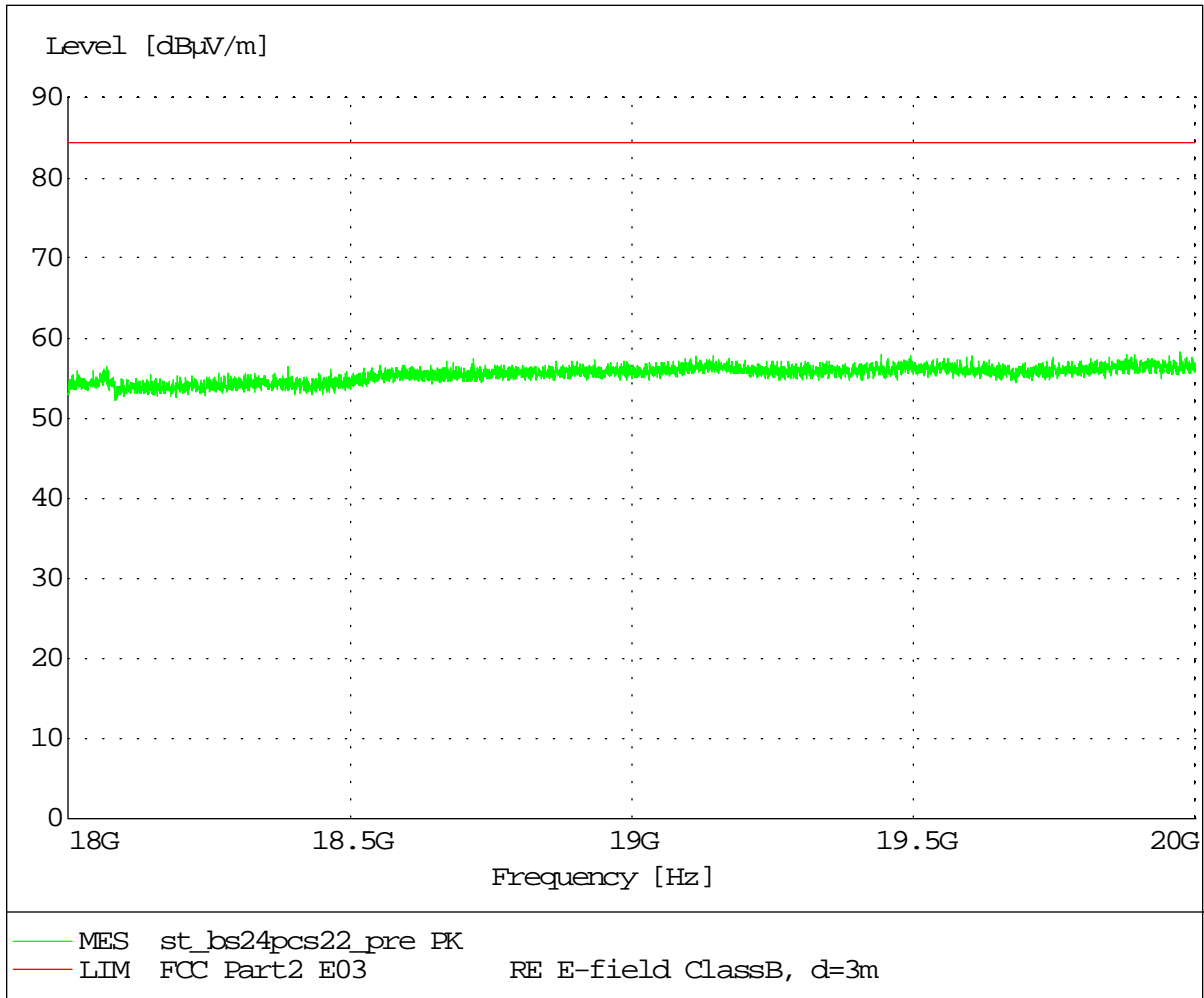

Fig. 36– Radiated Emission 18 GHz – 20 GHz, configuration B.

Test No. 6: Frequency Stability

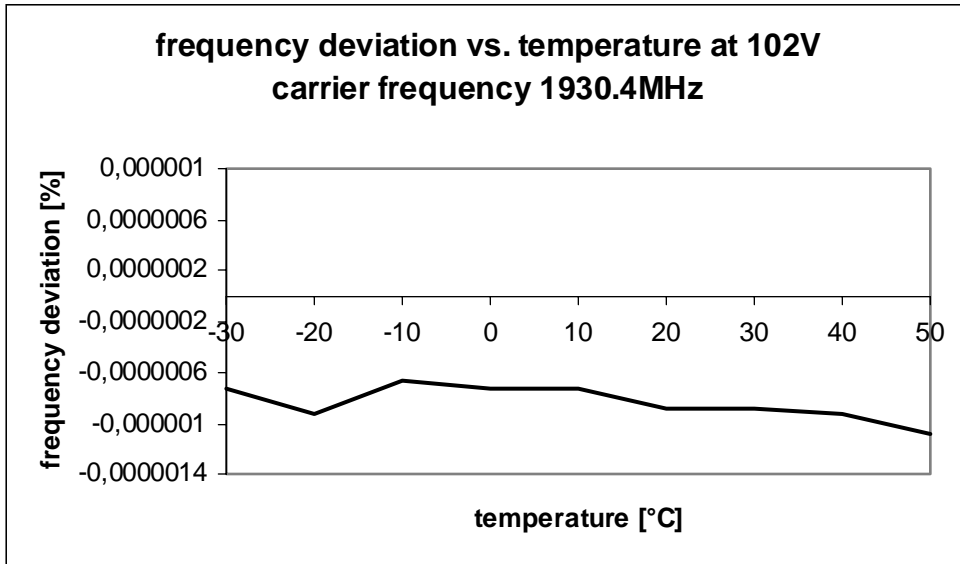

Fig. 37 – Frequency deviation vs. temperature (102V, 1930.4 MHz)

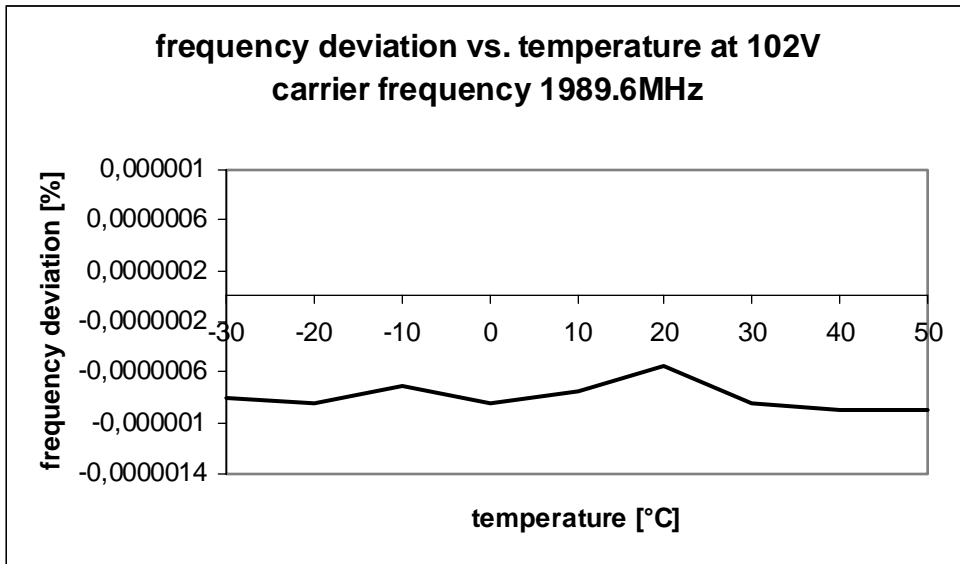

Fig. 38 – Frequency deviation vs. temperature (102V, 1989.6 MHz)

Test No. 6: Frequency Stability

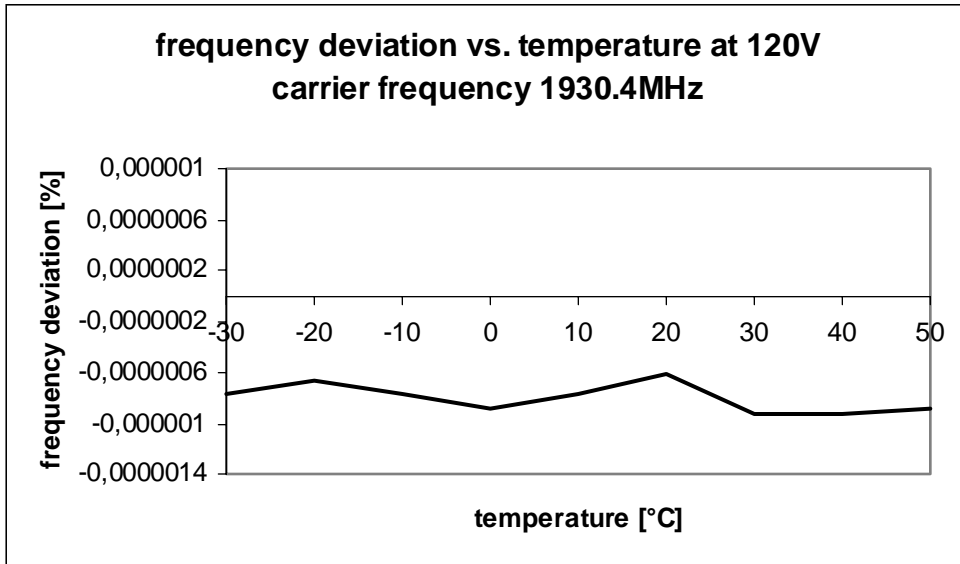

Fig. 39 – Frequency deviation vs. temperature (120V, 1930.4 MHz)

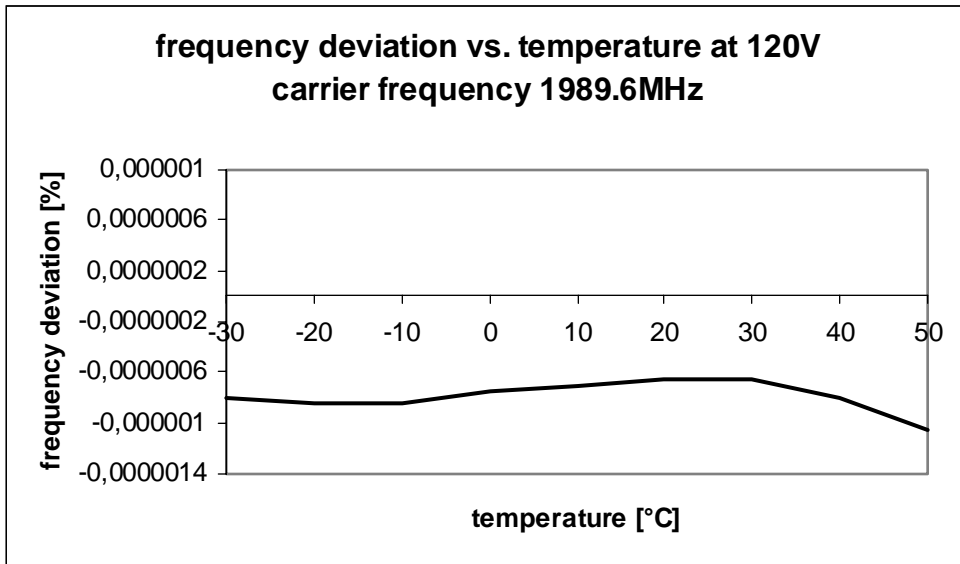

Fig. 40 – Frequency deviation vs. temperature (120V, 1989.6 MHz)

Test No. 6: Frequency Stability

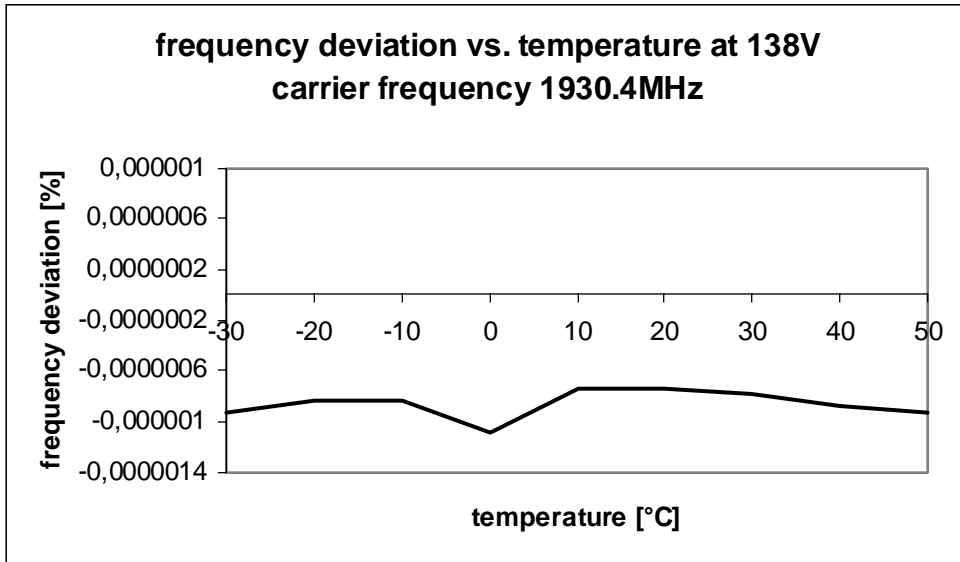

Fig. 41 – Frequency deviation vs. temperature (138V, 1930.4 MHz)

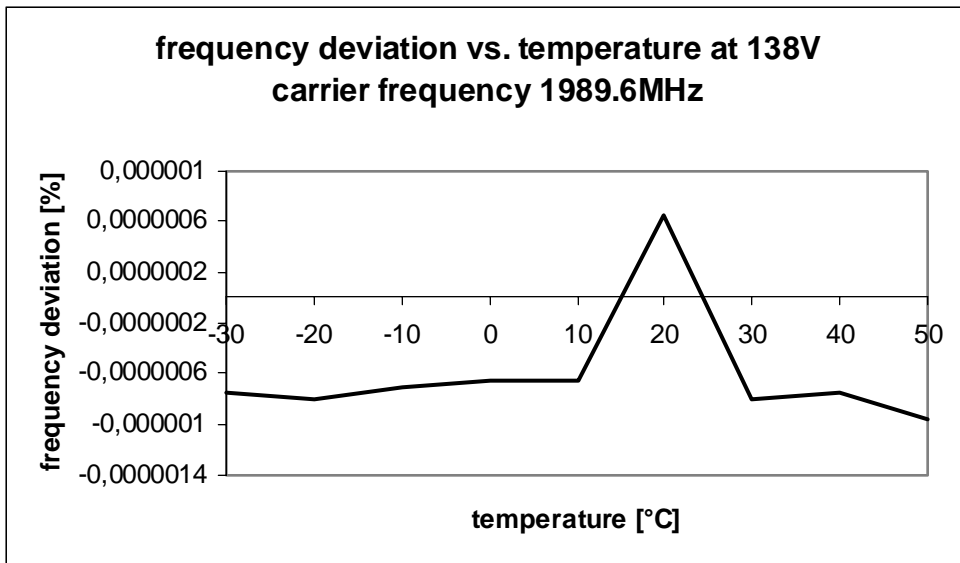
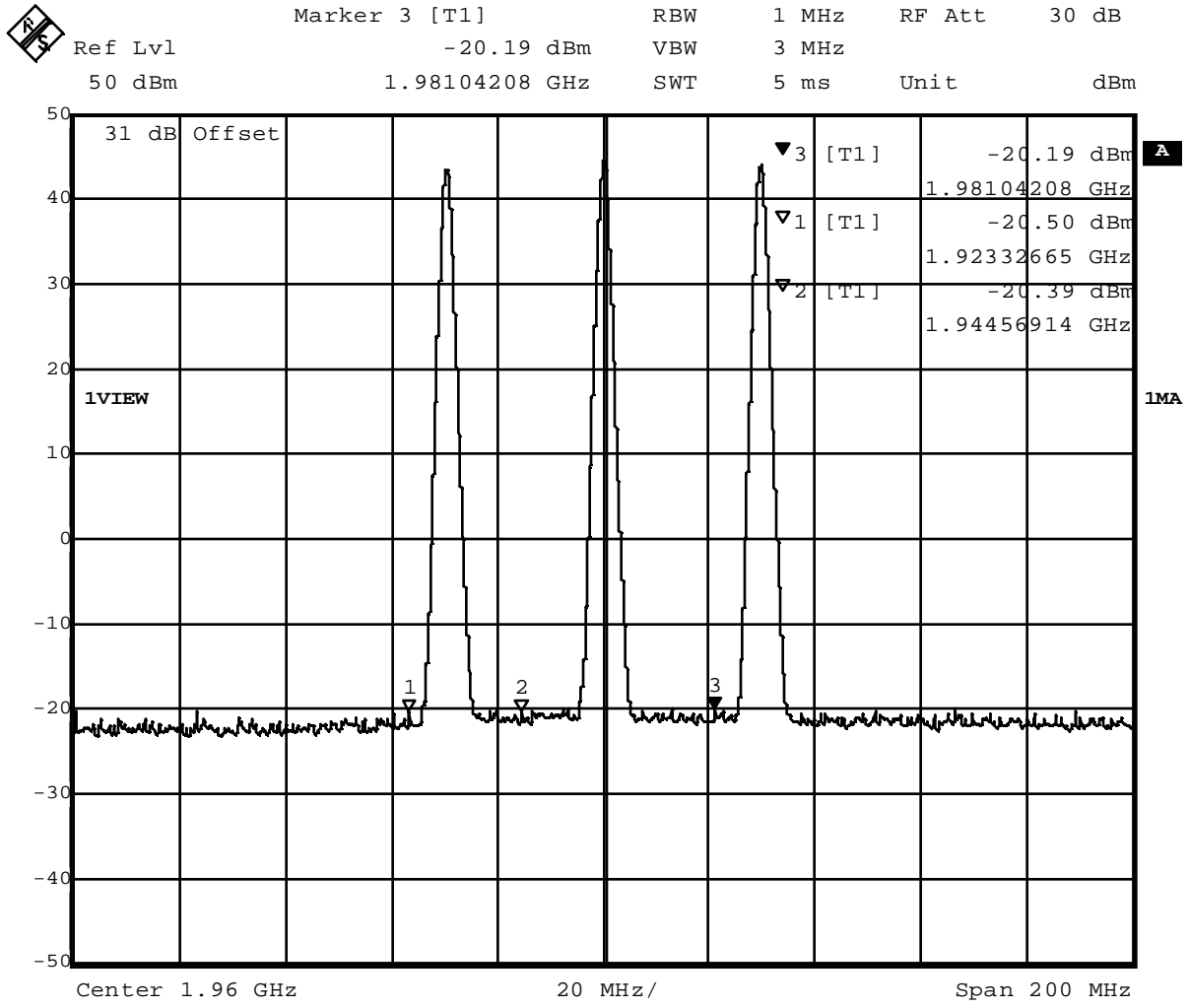

Fig. 42 – Frequency deviation vs. temperature (138V, 1989.6 MHz)

Test No. 7: Slow Frequency Hopping



Date: 21.MAR.2000 13:41:14

Fig. 43 – Slow frequency hopping – RBW = 1 MHz

Note:

The external attenuation of 31 dB is included in the spectral plot. This accounts for the external attenuator and the cable loss during the testing.

Test No. 7: Slow Frequency Hopping

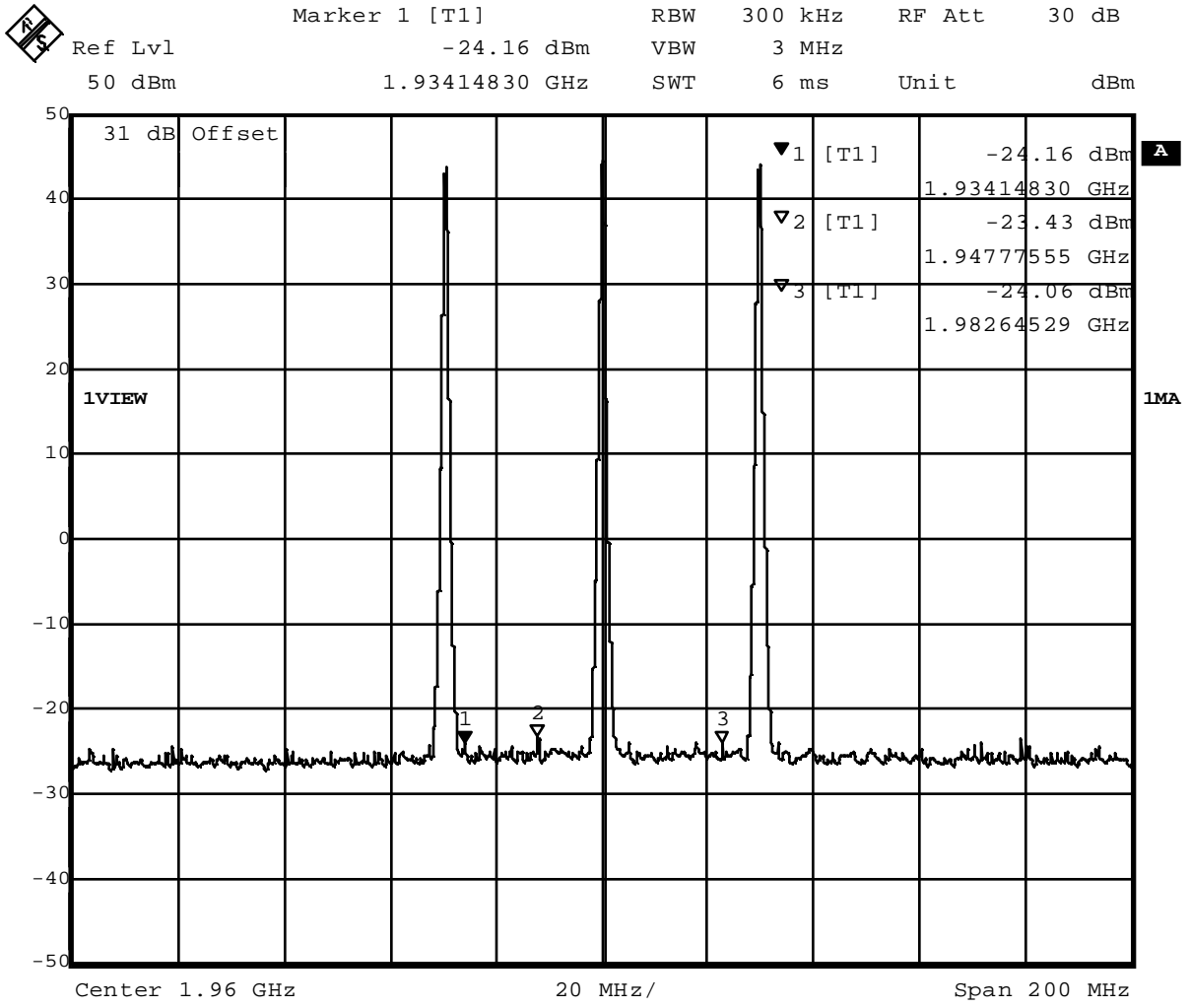

Date: 21.MAR.2000 13:43:23

Fig. 44 – Slow frequency hopping – RBW = 300 kHz

Note:

The external attenuation of 31 dB is included in the spectral plot. This accounts for the external attenuator and the cable loss during the testing.

Test No. 7: Slow Frequency Hopping

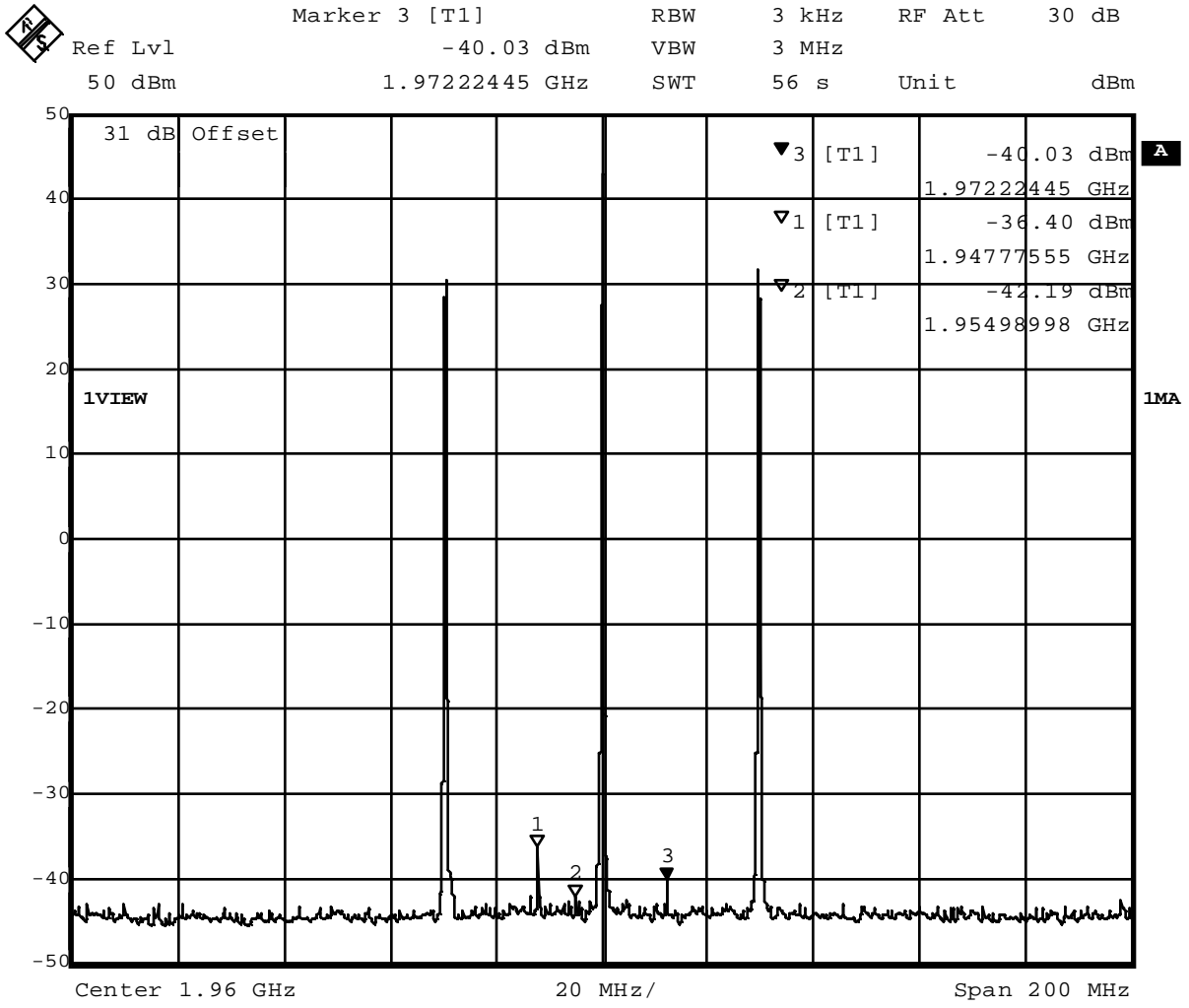
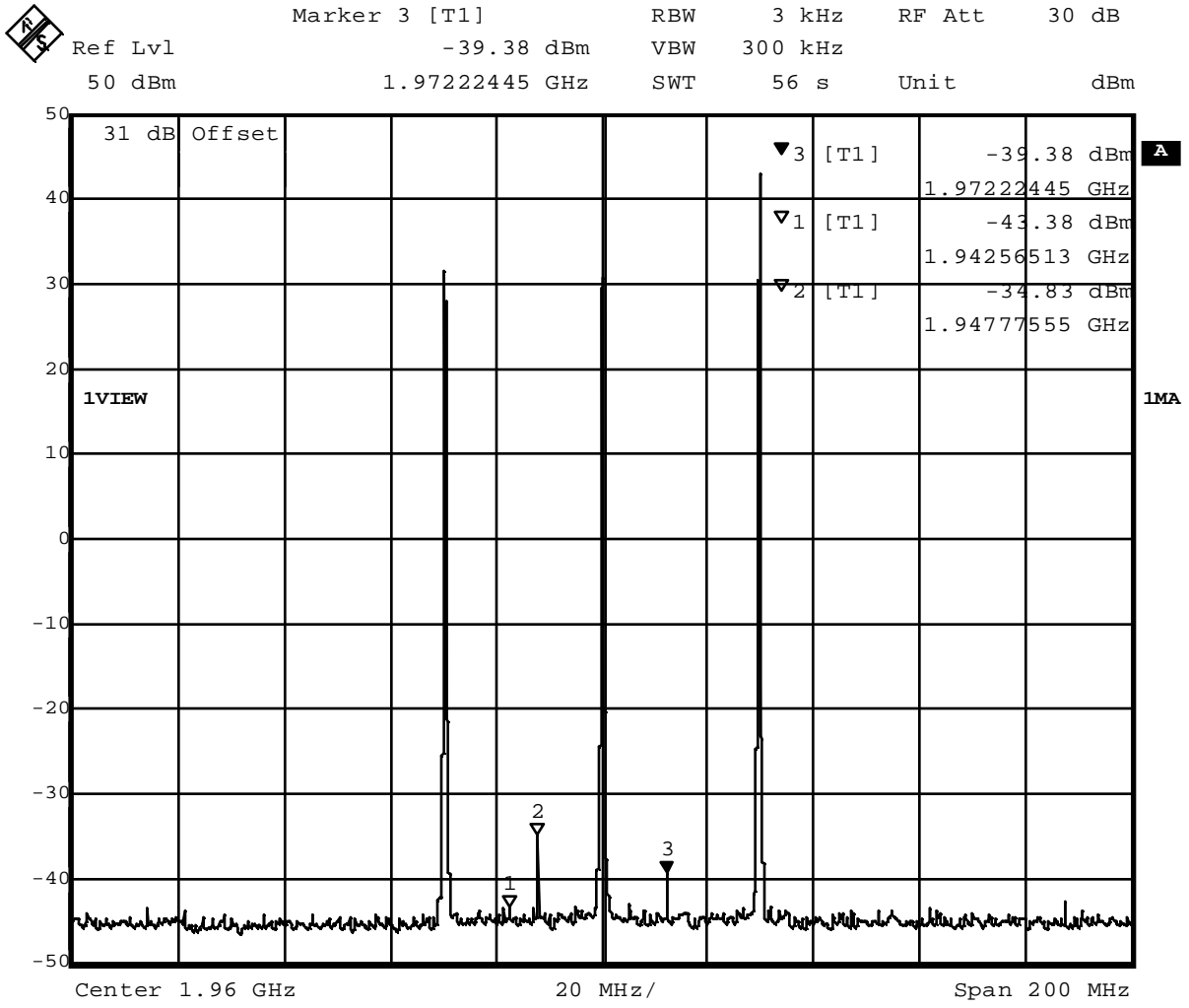

Fig. 45 – Slow frequency hopping – RBW = 3 kHz

Note:

The external attenuation of 31 dB is included in the spectral plot. This accounts for the external attenuator and the cable loss during the testing.

Test No. 7: Slow Frequency Hopping



Date: 21.MAR.2000 13:49:37

Fig. 46 – Slow frequency hopping – RBW = 3 kHz, reduced video bandwidth VBW = 300kHz.

Note:

The external attenuation of 31 dB is included in the spectral plot. This accounts for the external attenuator and the cable loss during the testing.