



# FCC TEST REPORT (Bluetooth)

according to

## FCC Rules and Regulations Part 15 Subpart C

Applicant	: Partner Tech Corp.
Address	: 10F, No. 233-2, Pao Chiao Rd., Shin Tien, Taipei, Taiwan 231, R.O.C.
Equipment	: Handheld Terminal
Model No.	: OT-100
FCC ID	: NDPOT-100
Trade Name	: Partner

Laboratory Accreditation



Testing Laboratory  
1332

- The test result refers exclusively to the test presented test model / sample.,
- Without written approval of **CerpPASS Technology Corp.** the test report shall not be reproduced except in full.
- The EUT is also considered as a kind of computer peripheral, because the connection to computer is necessary for typical use. It has been verified to comply with the requirements of FCC Part 15, Subpart B, Class B (DoC). The test report has been issued separately.



## Contents

<b>1. Report of Measurements and Examinations</b> .....	<b>5</b>
1.1 List of Measurements and Examinations.....	5
<b>2. Test Configuration of Equipment under Test</b> .....	<b>6</b>
2.1 Feature of Equipment under Test.....	6
2.2 Test Mode & Test Software .....	6
2.3 Description of Test System.....	6
2.4 Connection Diagram of Test System.....	7
2.5 General Information of Test.....	8
2.6 Measurement Uncertainty .....	8
2.7 History of this test report .....	9
<b>3. Antenna Requirements</b> .....	<b>10</b>
3.1 Standard Applicable .....	10
3.2 Antenna Construction and Directional Gain.....	10
<b>4. Test of Conducted Emission</b> .....	<b>11</b>
4.1 Test Limit.....	11
4.2 Test Procedures.....	11
4.3 Typical Test Setup .....	12
4.4 Measurement equipment .....	12
4.5 Test Result and Data.....	13
4.6 Test Photographs .....	19
<b>5. Test of Radiated Emission</b> .....	<b>20</b>
5.1 Test Limit.....	20
5.2 Test Procedures.....	20
5.3 Typical Test Setup .....	21
5.4 Measurement equipment .....	21
5.5 Test Result and Data.....	22
5.6 Test Photographs .....	52
<b>6. 20dB Bandwidth Measurement Data</b> .....	<b>53</b>
6.1 Test Limit .....	53
6.2 Test Procedures .....	53
6.3 Test Setup Layout .....	53
6.4 Measurement equipment .....	53
6.5 Test Result and Data.....	54
<b>7. Frequencies Separation</b> .....	<b>60</b>
7.1 Test Limit .....	60
7.2 Test Procedures .....	60
7.3 Test Setup Layout .....	60
7.4 Measurement equipment .....	60
7.5 Test Result and Data.....	61
<b>8. Dwell Time on each channel</b> .....	<b>67</b>
8.1 Test Limit .....	67
8.2 Test Procedures .....	67
8.3 Test Setup Layout .....	67
8.4 Measurement equipment .....	67



8.5 Test Result and Data..... 68

**9. Number of Hopping Channels ..... 78**

9.1 Test Limit ..... 78

9.2 Test Procedures ..... 78

9.3 Test Setup Layout ..... 78

9.4 Measurement equipment ..... 78

9.5 Test Result and Data..... 78

**10. Maximum Peak Output Power ..... 81**

10.1 Test Limit ..... 81

10.2 Test Procedures ..... 81

10.3 Test Setup Layout ..... 81

10.4 Measurement equipment ..... 81

10.5 Test Result and Data..... 82

**11. Band Edges Measurement ..... 88**

11.1 Test Limit ..... 88

11.2 Test Procedure : ..... 88

11.3 Test Setup Layout ..... 88

11.4 List of Measuring Equipment Used ..... 88

11.5 Test Result and Data..... 89

11.6 Restrict band emission Measurement Data..... 96

**12. Restricted Bands of Operation ..... 98**

12.1 Labeling Requirement..... 98

**Appendix A. Photographs of EUT.....A1 ~ A11**



# CERTIFICATE OF COMPLIANCE

according to

## FCC Rules and Regulations Part 15 Subpart C

Applicant : Partner Tech Corp.  
Address : 10F, No. 233-2, Pao Chiao Rd., Shin Tien,  
Taipei, Taiwan 231, R.O.C.  
Equipment : Handheld Terminal  
Model No. : OT-100  
FCC ID : NDPOT-100

### I HEREBY CERTIFY THAT :

The measurements shown in this test report were made in accordance with the procedures given in **ANSI C63.4** The equipment was **passed** the test performed according to **FCC Rules and Regulations Part 15 Subpart C (2007)**.

The test was carried out on Oct. 20, 2009 at **Cerpass Technology Corp.**

Signature

  
Jonson Lee  
EMC/RF B.U. Senior Manager



# 1. Report of Measurements and Examinations

## 1.1 List of Measurements and Examinations

FCC Rule	Description of Test	Result
15.203	. Antenna Requirement	Pass
15.207	. Conducted Emission	Pass
15.209	. Radiated Emission	Pass
15.247(a)(1)	. Channel Carrier Frequencies Separation	Pass
15.247(a)(1)	. 20dB Bandwidth Measurement	Pass
15.247(a)(1)	. Dwell Time	Pass
15.247(b)	. Number of Hopping Channels	Pass
15.247(b)	. Peak Output Power Measurement Data	Pass
15.247(d)	. Band Edges Measurement Data	Pass



## 2. Test Configuration of Equipment under Test

### 2.1 Feature of Equipment under Test

CPU	Freescale i.MX31/i.MX31L (Co-layout) CPU @ 532MHz/133MHz
RAM	Mobile DDR 128MB, NAND flash 128MB
LCD	4.3" widescreen (resolution 480*272)
WiFi	802.11b/g
Bluetooth	Class2
Audio	Line out, speaker, internal microphone, external mic jack
Storage	SD card
Connectors	Mini USB
Special features	Vibration Direction sensor
Battery	Li-ion 2200mAh
Ruggedness	IP54, 1.2 meter drop test
Accessories	Multi-charger, hand strap, leather pouch
Extension modules	MSR, IC card, RFID
OS	Windows CE 5.0
Weight	240g
Dimensions	133 * 82 * 19 mm(H x W x D)

### 2.2 Test Mode & Test Software

- a. During testing, the interface cables and equipment positions were varied according to ANSI C63.4
- b. The complete test system included EUT for EMI test.
- c. The EUT was executed to keep transmitting and receiving data via Bluetooth.
- d. The following test mode was performed for conduction and radiation test:
  - GFSK: CH 00: 2402MHz, CH 39: 2441MHz, CH 78: 2480MHz.
  - $\pi/4$ -DQPSK: CH 00: 2402MHz, CH 39: 2441MHz, CH 78: 2480MHz.
  - 8DPSK: CH 00: 2402MHz, CH 39: 2441MHz, CH 78: 2480MHz.

### 2.3 Description of Test System

The EUT was tested alone. No support devices is needed for testing.



## 2.4 Connection Diagram of Test System

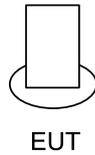

\* The EUT keeps to transmit and receive data via Wireless.



## 2.5 General Information of Test

Test Site :	Cerpass Technology Corp. 2F-11, No. 3, Yuan Qu St. (Nankang Software Park), Taipei, Taiwan 115, R.O.C.
Test Site Location (OATS1-SD):	No. 7-2, Moshihkeng, Fongtian Village, Shihding Township, Taipei County, Taiwan, R.O.C.
FCC Registration Number :	TW1049, TW1059, 982971, 488071
IC Registration Number :	4934C-1, 4934D-1
VCCI Registration Number :	T-543 for Telecommunication Test C-3328 for Conducted emission test R-3013 for Radiated emission test
Test Voltage:	AC 120V/ 60Hz
Test in Compliance with:	ANSI C63.4-2003 FCC Part 15 Subpart C
Frequency Range Investigated:	Conducted: from 150kHz to 30 MHz Radiation: from 30 MHz to 24620MHz
Test Distance:	The test distance of radiated emission from antenna to EUT is 3 M.

## 2.6 Measurement Uncertainty

Measurement Item	Measurement Frequency	Polarization	Uncertainty
Conducted Emission	9 kHz ~ 30 MHz	LINE/NEUTRAL	2.71 dB
Radiated Emission	30 MHz ~ 1GHz	Vertical	4.11 dB
		Horizontal	4.10 dB
6 dB Bandwidth	---	---	7500 Hz
Maximum Peak Output Power	---	---	1.4 dB
100kHz Bandwidth of Frequency Band Edges	---	---	2.2 dB
Power Spectral Density	---	---	2.2 dB





### 3. Antenna Requirements

#### 3.1 Standard Applicable

For intentional device, according to FCC 47 CFR Section 15.203, an intentional radiator shall be designed to ensure that no antenna other than that furnished by the responsible party shall be used with the device.

And according to FCC 47 CFR Section 15.247 (b), if transmitting antennas of directional gain greater than 6dBi are used, the power shall be reduced by the amount in dB that the directional gain of the antenna exceeds 6dBi.

#### 3.2 Antenna Construction and Directional Gain

Antenna type: PCB Antenna

Antenna Gain: 3.49 dBi



## 4. Test of Conducted Emission

### 4.1 Test Limit

Conducted Emissions were measured from 150 kHz to 30 MHz with a bandwidth of 9 KHz on the 120 VAC power and return leads of the EUT according to the methods defined in ANSI C63.4-2003 Section 3.1. The EUT was placed on a nonmetallic stand in a shielded room 0.8 meters above the ground plane as shown in section 2.2. The interface cables and equipment positioning were varied within limits of reasonable applications to determine the position produced maximum conducted emissions.

Frequency (MHz)	Quasi Peak (dB $\mu$ V)	Average (dB $\mu$ V)
0.15 – 0.5	66-56*	56-46*
0.5 – 5.0	56	46
5.0 – 30.0	60	50

\*Decreases with the logarithm of the frequency.

### 4.2 Test Procedures

- a. The EUT was placed 0.4 meter from the conducting wall of the shielding room was kept at least 80 centimeters from any other grounded conducting surface.
- b. Connect EUT to the power mains through a line impedance stabilization network (LISN).
- c. All the support units are connecting to the other LISN.
- d. The LISN provides 50 ohm coupling impedance for the measuring instrument.
- e. The FCC states that a 50 ohm, 50 micro-Henry LISN should be used.
- f. Both sides of AC line were checked for maximum conducted interference.
- g. The frequency range from 150 kHz to 30 MHz was searched.
- h. Set the test-receiver system to Peak Detect Function and Specified Bandwidth with Maximum Hold Mode.



### 4.3 Typical Test Setup

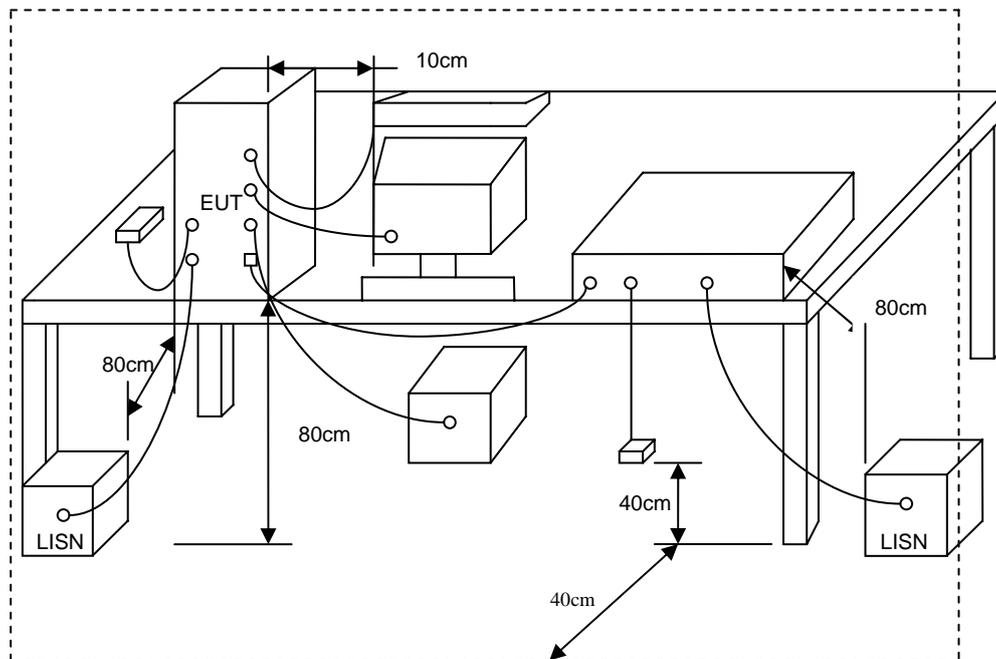

### 4.4 Measurement equipment

Instrument/Ancillary	Manufacturer	Model No.	Serial No.	Calibration Date	Valid Date.
EMI Receiver	R&S	ESCI	100443	2008/12/19	2009/12/18
LISN	NSLK 8127	Schwarzbeck	8127-516	2009/05/15	2010/05/14
LISN	ROLF HEINE	NNB-2/16Z	03/10058	2009/04/18	2010/04/17



4.5 Test Result and Data

Power	: AC 120V	Pol/Phase	: LINE
Test Mode	: GFSK CH0	Temperature	: 25 °C
Memo	:	Humidity	: 56 %

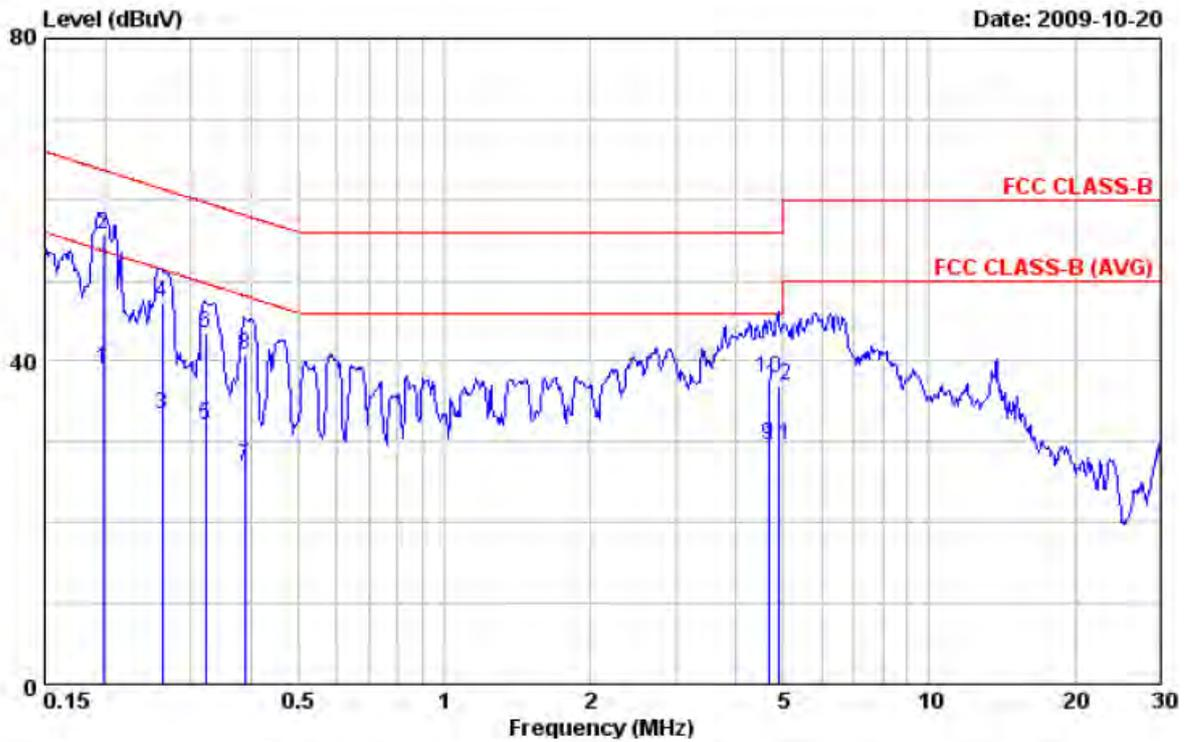

Item	Freq	Read Value	Factor	Result	Limit	Margin	Remark
	MHz	dBuV	dB/m	dBuV/m	dBuV/m	dB	
1	0.20	38.94	0.11	39.05	53.68	-14.63	Average
2	0.20	55.70	0.11	55.81	63.68	-7.87	QP
3	0.26	33.32	0.11	33.43	51.35	-17.92	Average
4	0.26	47.21	0.11	47.32	61.35	-14.03	QP
5	0.32	31.90	0.12	32.02	49.64	-17.62	Average
6	0.32	43.41	0.12	43.53	59.64	-16.11	QP
7	0.39	26.90	0.11	27.01	48.12	-21.11	Average
8	0.39	40.57	0.11	40.68	58.12	-17.44	QP
9	4.67	29.42	0.33	29.75	46.00	-16.25	Average
10	4.67	37.51	0.33	37.84	56.00	-18.16	QP
11	4.87	29.22	0.34	29.56	46.00	-16.44	Average
12	4.87	36.73	0.34	37.07	56.00	-18.93	QP

Notes:

1. Result = Read Value + Factor
2. Factor = LISN Factor + Cable Loss
3. According to technical experiences, all spurious emission of GFSK mode at channel 0,39,78 are almost the same below 1GHz, so that the channel 0 was chosen as representative in final test.
4. The data is worst case.



Power	: AC 120V	Pol/Phase	: NEUTRAL
Test Mode	: GFSK CH0	Temperature	: 25 °C
Memo	:	Humidity	: 56 %

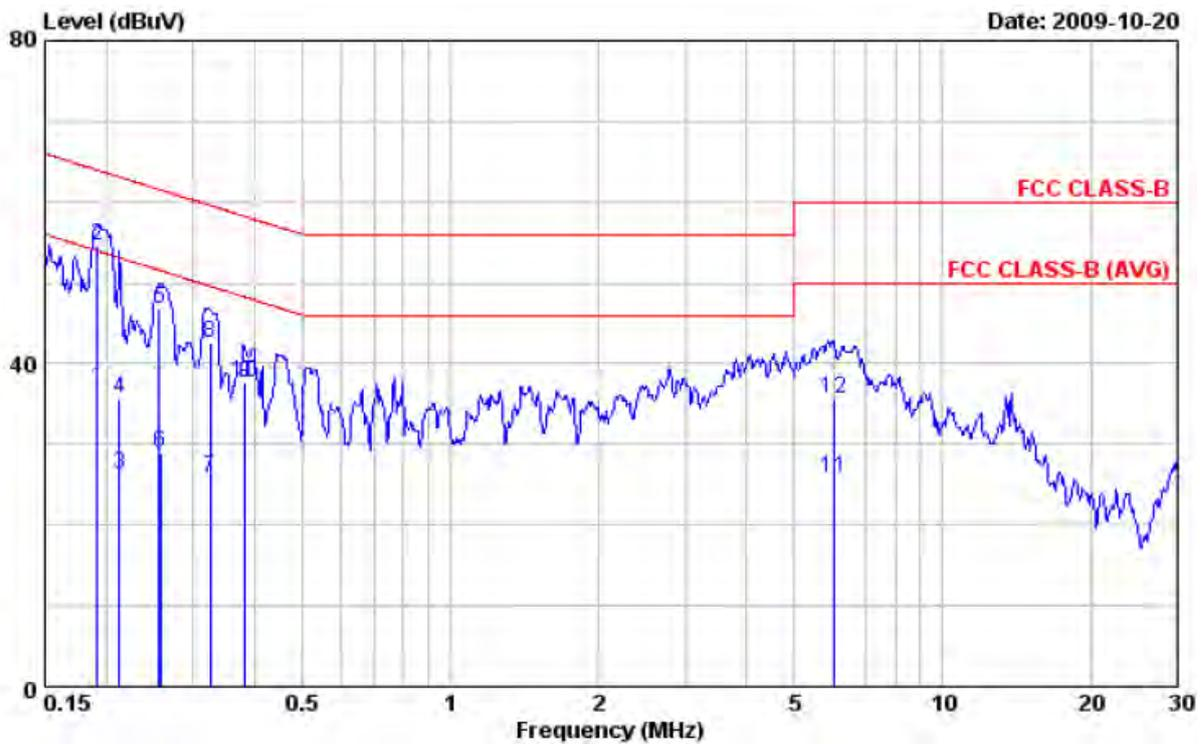

Item	Freq	Read Value	Factor	Result	Limit	Margin	Remark
	MHz	dBuV	dB/m	dBuV/m	dBuV/m	dB	
1	0.19	36.85	0.14	36.99	53.96	-16.97	Average
2	0.19	54.44	0.14	54.58	63.96	-9.38	QP
3	0.21	26.22	0.13	26.35	53.10	-26.75	Average
4	0.21	35.63	0.13	35.76	63.10	-27.34	QP
5	0.26	46.65	0.13	46.78	61.56	-14.78	QP
6	0.26	28.92	0.13	29.05	51.51	-22.46	Average
7	0.32	25.65	0.14	25.79	49.59	-23.80	Average
8	0.32	42.52	0.14	42.66	59.59	-16.93	QP
9	0.38	37.50	0.14	37.64	58.20	-20.56	QP
10	0.38	37.49	0.14	37.63	58.20	-20.57	QP
11	6.01	25.55	0.35	25.90	50.00	-24.10	Average
12	6.01	35.30	0.35	35.65	60.00	-24.35	QP

Notes:

1. Result = Read Value + Factor
2. Factor = LISN Factor + Cable Loss
3. According to technical experiences, all spurious emission of GFSK mode at channel 0,39,78 are almost the same below 1GHz, so that the channel 0 was chosen as representative in final test.
4. The data is worst case.



Power	: AC 120V	Pol/Phase	: LINE
Test Mode	: $\pi/4$ -DQPSK CH0	Temperature	: 25 °C
Memo	:	Humidity	: 56 %

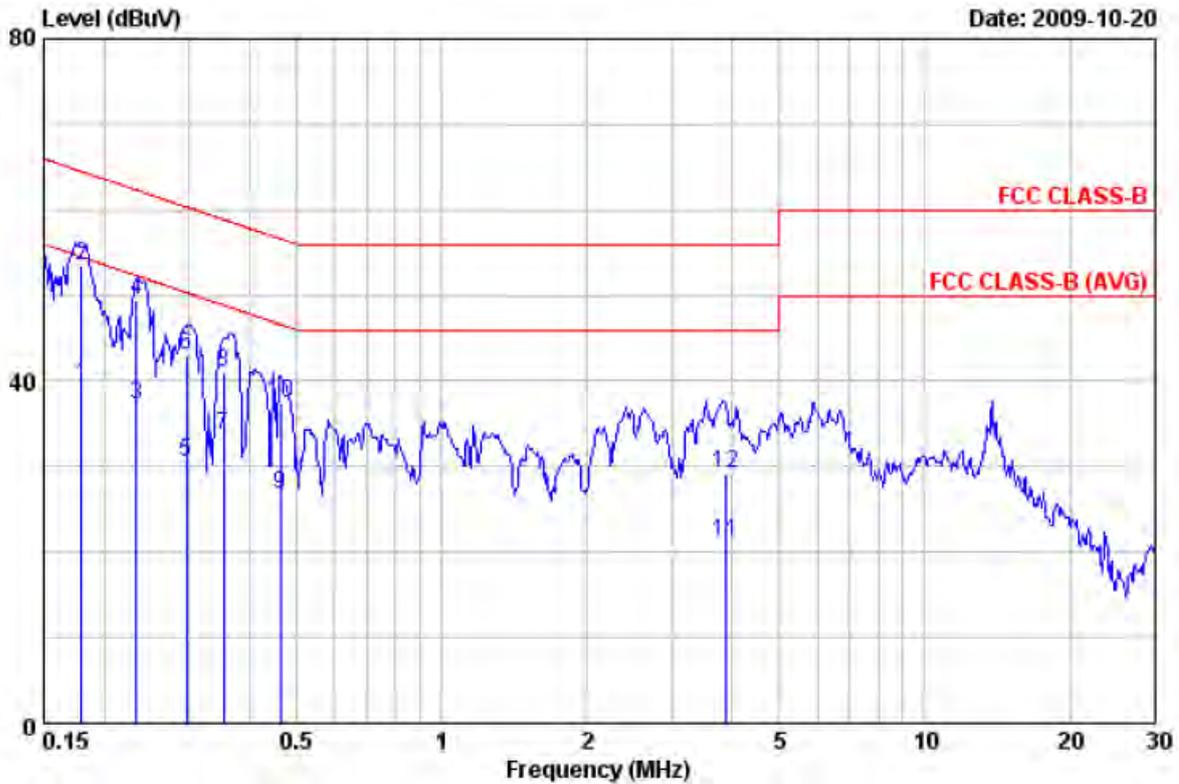

Item	Freq	Read Value	Factor	Result	Limit	Margin	Remark
	MHz	dBuV	dB/m	dBuV/m	dBuV/m	dB	
1	0.18	39.27	0.11	39.38	54.50	-15.12	Average
2	0.18	53.33	0.11	53.44	64.50	-11.06	QP
3	0.23	37.03	0.11	37.14	52.35	-15.21	Average
4	0.23	49.27	0.11	49.38	62.35	-12.97	QP
5	0.30	30.47	0.12	30.59	50.34	-19.75	Average
6	0.30	42.95	0.12	43.07	60.34	-17.27	QP
7	0.35	33.49	0.11	33.60	48.86	-15.26	Average
8	0.35	40.99	0.11	41.10	58.86	-17.76	QP
9	0.46	26.64	0.11	26.75	46.63	-19.88	Average
10	0.46	37.26	0.11	37.37	56.63	-19.26	QP
11	3.87	20.85	0.32	21.17	46.00	-24.83	Average
12	3.87	28.83	0.32	29.15	56.00	-26.85	QP

Notes:

1. Result = Read Value + Factor
2. Factor = LISN Factor + Cable Loss
3. According to technical experiences, all spurious emission of  $\pi/4$ -DQPSK mode at channel 0,39,78 are almost the same below 1GHz, so that the channel 0 was chosen as representative in final test.
4. The data is worst case.



Power	: AC 120V	Pol/Phase	: NEUTRAL
Test Mode	: $\pi/4$ -DQPSK CH0	Temperature	: 25 °C
Memo	:	Humidity	: 56 %

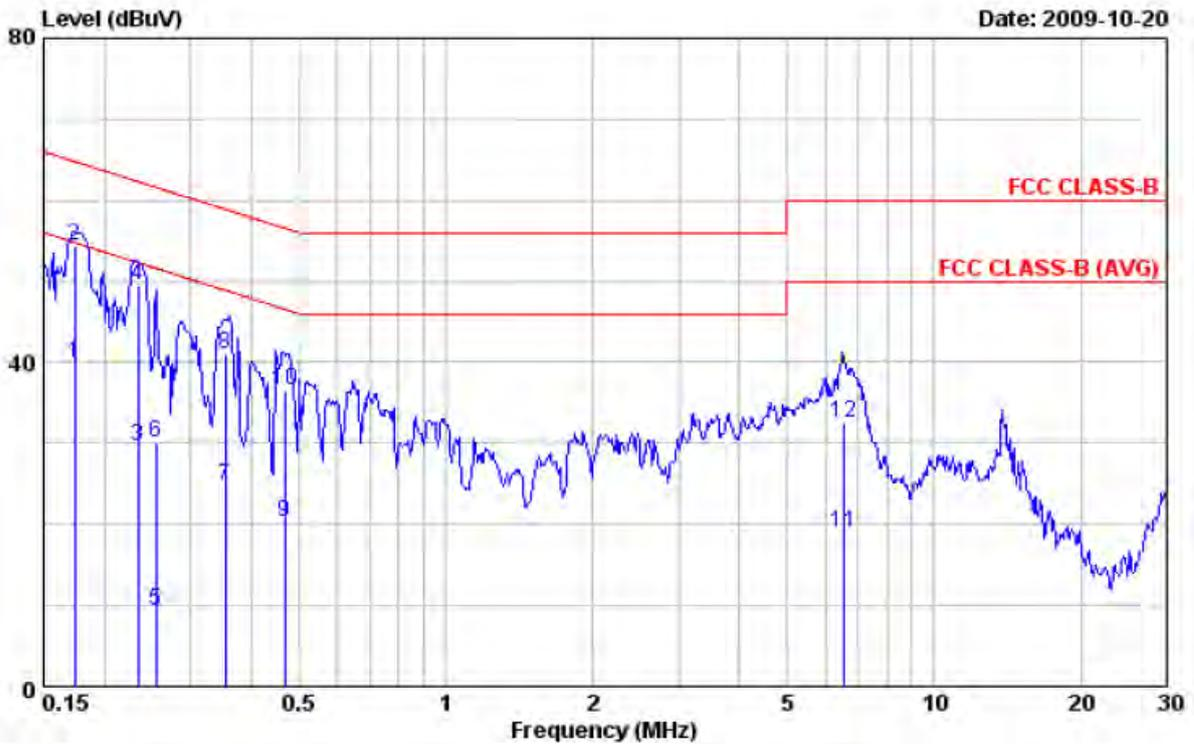

Item	Freq	Read Value	Factor	Result	Limit	Margin	Remark
	MHz	dBuV	dB/m	dBuV/m	dBuV/m	dB	
1	0.17	39.66	0.14	39.80	54.79	-14.99	Average
2	0.17	54.18	0.14	54.32	64.79	-10.47	QP
3	0.23	29.59	0.13	29.72	52.28	-22.56	Average
4	0.23	49.38	0.13	49.51	62.28	-12.77	QP
5	0.25	9.19	0.13	9.32	51.60	-42.28	Average
6	0.25	30.03	0.13	30.16	61.60	-31.44	QP
7	0.35	24.68	0.14	24.82	48.87	-24.05	Average
8	0.35	40.86	0.14	41.00	58.87	-17.87	QP
9	0.47	20.11	0.14	20.25	46.57	-26.32	Average
10	0.47	36.39	0.14	36.53	56.57	-20.04	QP
11	6.53	18.51	0.37	18.88	50.00	-31.12	Average
12	6.53	32.12	0.37	32.49	60.00	-27.51	QP

Notes:

1. Result = Read Value + Factor
2. Factor = LISN Factor + Cable Loss
3. According to technical experiences, all spurious emission of  $\pi/4$ -DQPSK mode at channel 0,39,78 are almost the same below 1GHz, so that the channel 0 was chosen as representative in final test.
4. The data is worst case.



Power	: AC 120V	Pol/Phase	: LINE
Test Mode	: 8DPSK CH0	Temperature	: 25 °C
Memo	:	Humidity	: 56 %

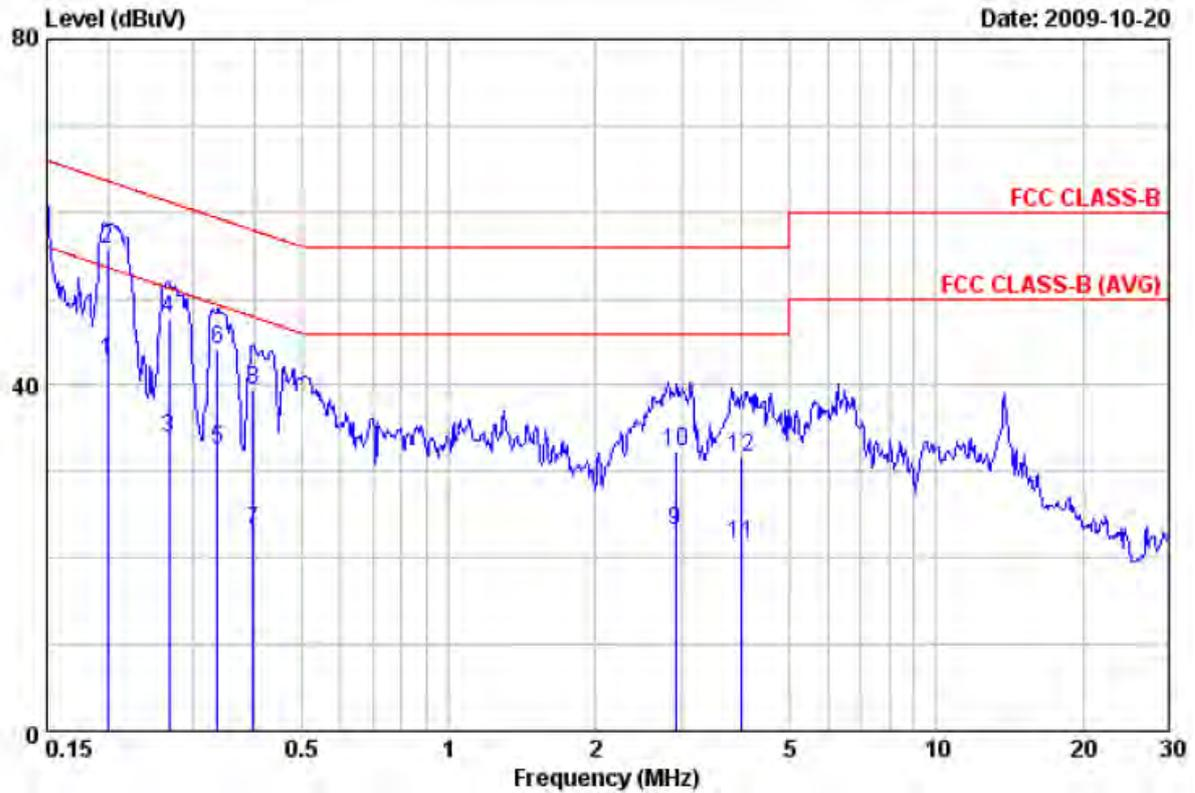

Item	Freq	Read Value	Factor	Result	Limit	Margin	Remark
	MHz	dBuV	dB/m	dBuV/m	dBuV/m	dB	
1	0.20	42.60	0.11	42.71	53.61	-10.90	Average
2	0.20	55.62	0.11	55.73	63.61	-7.88	QP
3	0.27	33.68	0.11	33.79	51.19	-17.40	Average
4	0.27	47.56	0.11	47.67	61.19	-13.52	QP
5	0.34	32.33	0.12	32.45	49.30	-16.85	Average
6	0.34	44.04	0.12	44.16	59.30	-15.14	QP
7	0.40	23.11	0.11	23.22	47.90	-24.68	Average
8	0.40	39.31	0.11	39.42	57.90	-18.48	QP
9	2.92	22.91	0.27	23.18	46.00	-22.82	Average
10	2.92	32.01	0.27	32.28	56.00	-23.72	QP
11	3.99	21.35	0.32	21.67	46.00	-24.33	Average
12	3.99	31.28	0.32	31.60	56.00	-24.40	QP

Notes:

1. Result = Read Value + Factor
2. Factor = LISN Factor + Cable Loss
3. According to technical experiences, all spurious emission of 8DPSK mode at channel 0,39,78 are almost the same below 1GHz, so that the channel 0 was chosen as representative in final test.
4. The data is worst case.



Power	: AC 120V	Pol/Phase	: NEUTRAL
Test Mode	: 8DPSK CH0	Temperature	: 25 °C
Memo	:	Humidity	: 56 %

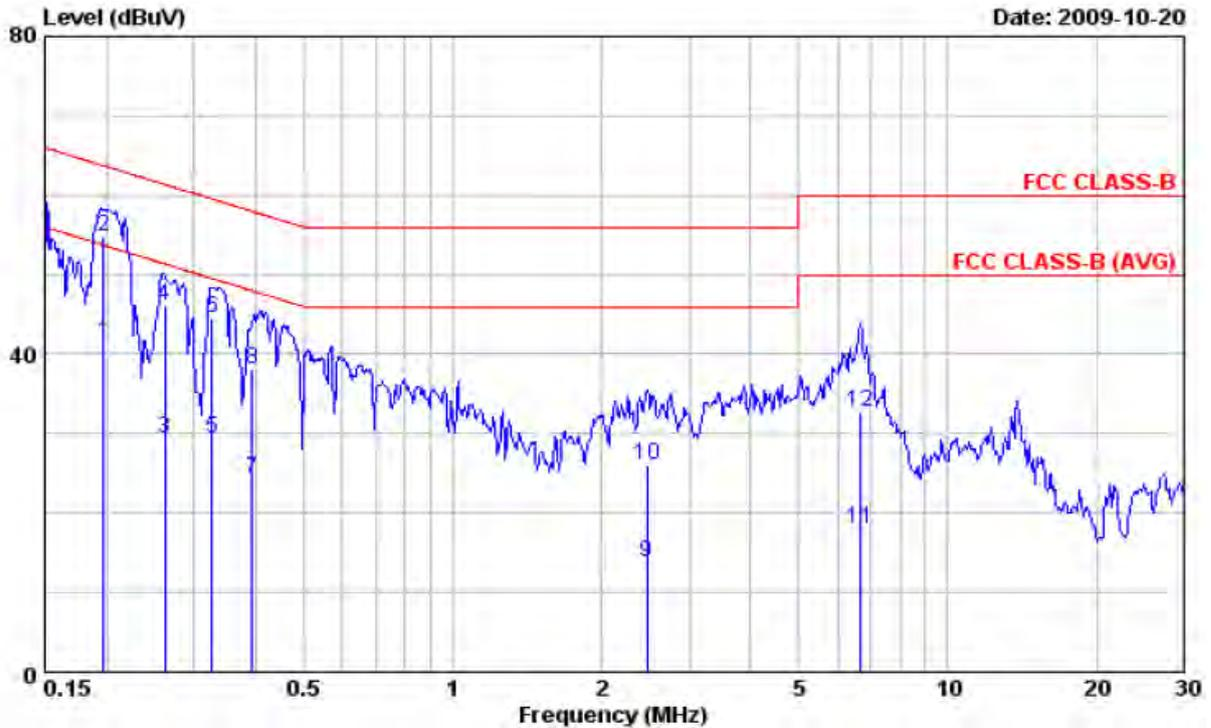

Item	Freq	Read Value	Factor	Result	Limit	Margin	Remark
	MHz	dBuV	dB/m	dBuV/m	dBuV/m	dB	
1	0.20	41.30	0.14	41.44	53.71	-12.27	Average
2	0.20	54.60	0.14	54.74	63.71	-8.97	QP
3	0.26	29.26	0.13	29.39	51.35	-21.96	Average
4	0.26	46.05	0.13	46.18	61.35	-15.17	QP
5	0.33	29.20	0.14	29.34	49.53	-20.19	Average
6	0.33	44.35	0.14	44.49	59.53	-15.04	QP
7	0.39	24.21	0.14	24.35	47.99	-23.64	Average
8	0.39	38.05	0.14	38.19	57.99	-19.80	QP
9	2.47	13.47	0.24	13.71	46.00	-32.29	Average
10	2.47	25.88	0.24	26.12	56.00	-29.88	QP
11	6.66	17.64	0.37	18.01	50.00	-31.99	Average
12	6.66	32.43	0.37	32.80	60.00	-27.20	QP

Notes:

1. Result = Read Value + Factor
2. Factor = LISN Factor + Cable Loss
3. According to technical experiences, all spurious emission of 8DPSK mode at channel 0,39,78 are almost the same below 1GHz, so that the channel 0 was chosen as representative in final test.
4. The data is worst case.

Test engineer: Ben



## 5. Test of Radiated Emission

### 5.1 Test Limit

Radiated emissions from 30 MHz to 25 GHz were measured according to the methods defines in ANSI C63.4-2003. The EUT was placed, 0.8 meter above the ground plane, as shown in section 5.6.3. The interface cables and equipment positions were varied within limits of reasonable applications to determine the positions producing maximum radiated emissions For unintentional device, according to § 15.109(a), except for Class A digital devices, the field strength of radiated emissions from unintentional radiators at a distance of 3 meters shall not exceed the following values:

Frequency (MHz)	Distance Meters	Radiated ( $\mu$ V / M)	Radiated (dB $\mu$ V / M)
30-88	3	100	40.0
88-216	3	150	43.5
216-960	3	200	46.0
Above 960	3	500	54.0

For unintentional device, according to CISPR PUB.22, for Class B digital devices, the general requirement of field strength of radiated emissions from intentional radiators at a distance of 10 meters shall not exceed the above table.

Frequency (MHz)	Distance Meters	Radiated (dB $\mu$ V / M)
30-230	10	30
230-1000	10	37

### 5.2 Test Procedures

- The EUT was placed on a rotatable table top 0.8 meter above ground.
- The EUT was set 3 meters from the interference receiving antenna which was mounted on the top of a variable height antenna tower.
- The table was rotated 360 degrees to determine the position of the highest radiation.
- The antenna is a broadband antenna and its height is varied between one meter and four meters above ground to find the maximum value of the field strength both horizontal polarization and vertical polarization of the antenna are set to make the measurement.
- For each suspected emission the EUT was arranged to its worst case and then tune the antenna tower (from 1 M to 4 M) and turn table (from 0 degree to 360 degrees) to find the maximum reading.
- Set the test-receiver system to Peak or CISPR quasi-peak Detect Function and specified bandwidth with Maximum Hold Mode.
- If the emission level of the EUT in peak mode was 3 dB lower than the limit specified, then testing will be stopped and peak values of EUT will be reported, otherwise, the emissions which do not have 3 dB margin will be repeated one by one using the quasi-peak method and reported.
- For testing above 1GHz, the emission level of the EUT in peak mode was 20dB lower than average limit (that means the emission level in peak mode also complies with the limit in average mode), then testing will be stopped and peak values of EUT will be reported, otherwise, the emissions will be measured in average mode again and reported.



### 5.3 Typical Test Setup

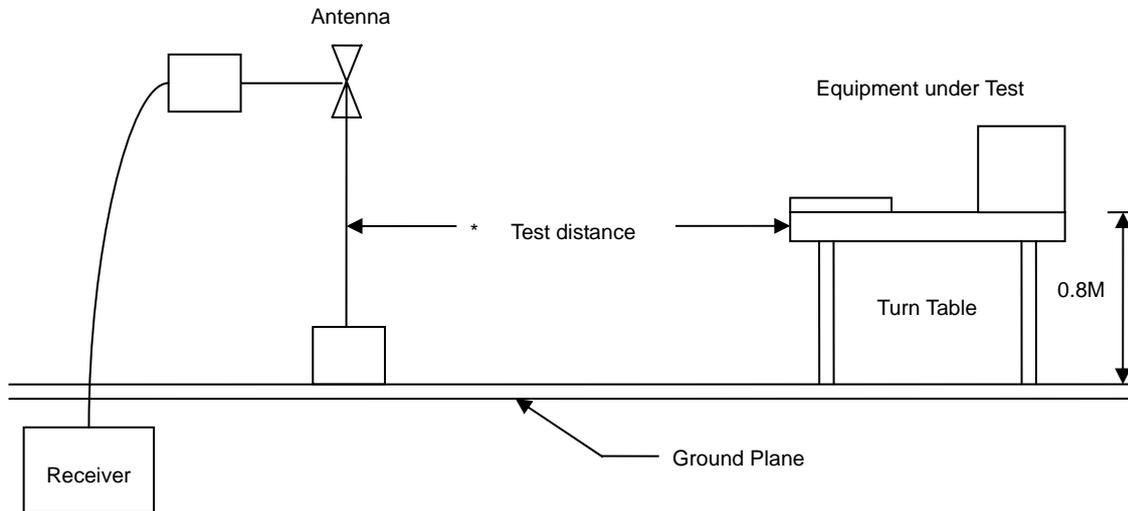

### 5.4 Measurement equipment

Instrument/Ancillary	Manufacturer	Model No.	Serial No.	Calibration Date	Valid Date
Bilog Antenna	Schaffner	CBL6112B	2840	2009/05/14	2010/05/13
EMI Receiver	R&S	ESCI	100443	2008/12/19	2009/12/18
Amplifier	Agilent	8447D	2944A10593	2009/05/21	2010/05/20
AC Power Converter	APC	AFC-11005	F103120008	N/A	N/A



5.5 Test Result and Data

Power	: AC 120V	Pol/Phase	: VERTICAL
Test Mode	: Transmit / Receive	Temperature	: 27 °C
Operation Channel	: 0	Humidity	: 55 %
Modulation Type	: GFSK	Atmospheric Pressure	: 1021 hPa
Memo	:	Rate	: 1 Mbps

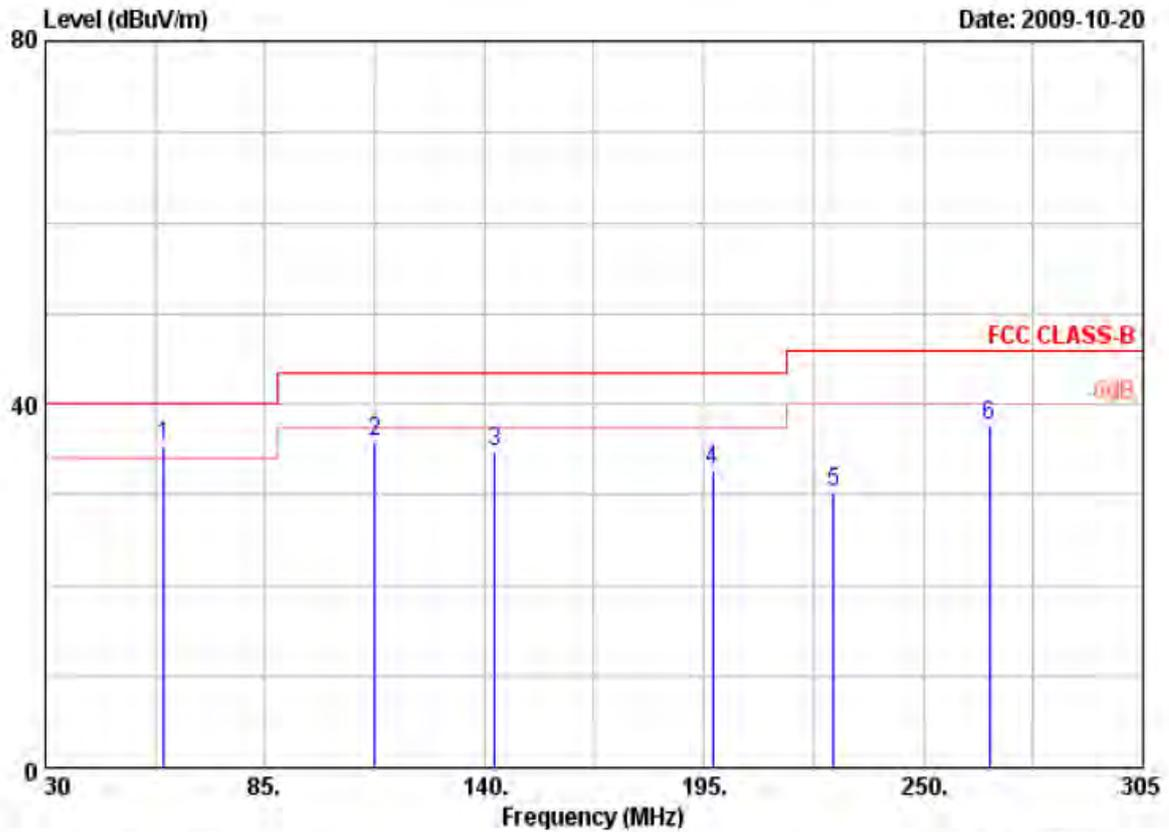

Item	Freq	Read Value	Factor	Result	Limit	Margin	Remark	Ant Pos	Tab Pos
	MHz	dBuV	dB/m	dBuV/m	dBuV/m	dB		cm	Deg
1	59.70	48.20	-12.75	35.45	40.00	-4.55	QP	105	360
2	112.50	46.60	-10.65	35.95	43.50	-7.55	Peak	105	360
3	142.75	45.89	-11.18	34.71	43.50	-8.79	Peak	105	360
4	197.20	42.70	-9.99	32.71	43.50	-10.79	Peak	105	360
5	227.45	41.31	-10.90	30.41	46.00	-15.59	Peak	105	360
6	266.50	50.26	-12.51	37.75	46.00	-8.25	Peak	105	360

- Remarks:
1. Result = Read Value + Factor
  2. Factor = Antenna Factor + Cable Loss - Amplifier
  3. According to technical experiences, all spurious emission of FM mode at channel 0,39,78 are almost the same below 1GHz, so that the channel 0 was chosen as representative in final test.
  4. The data is worst case.



Power	: AC 120V	Pol/Phase	: VERTICAL
Test Mode	: Transmit / Receive	Temperature	: 27 °C
Operation Channel	: 0	Humidity	: 55 %
Modulation Type	: GFSK	Atmospheric Pressure	: 1021 hPa
Memo	:	Rate	: 1 Mbps

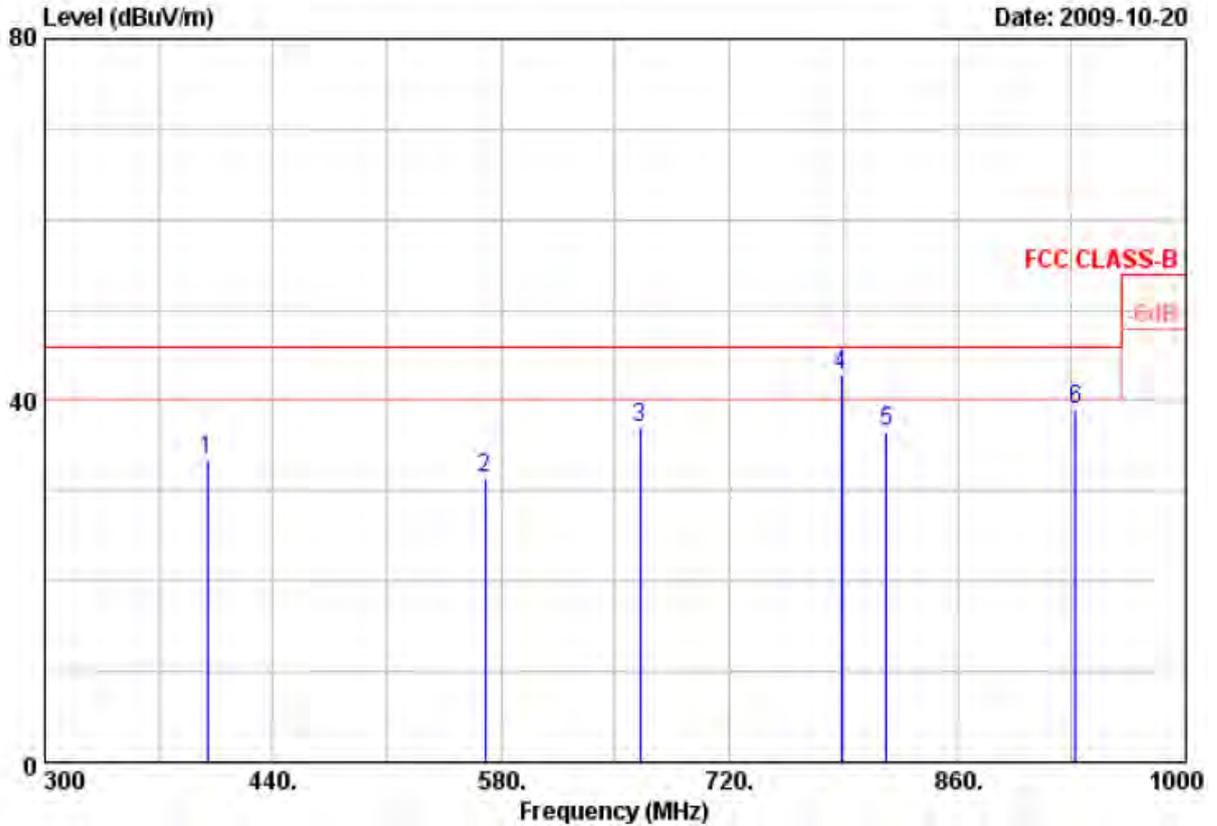

Item	Freq	Read Value	Factor	Result	Limit	Margin	Remark	Ant Pos	Tab Pos
	MHz	dBuV	dB/m	dBuV/m	dBuV/m	dB		cm	Deg
1	399.40	40.48	-6.97	33.51	46.00	-12.49	Peak	105	0
2	570.20	34.29	-2.92	31.37	46.00	-14.63	Peak	105	0
3	665.40	41.16	-4.22	36.94	46.00	-9.06	Peak	105	0
4	788.60	44.67	-1.97	42.70	46.00	-3.30	QP	105	0
5	816.60	36.91	-0.46	36.45	46.00	-9.55	Peak	105	0
6	932.10	34.38	4.62	39.00	46.00	-7.00	Peak	105	0

- Remarks:
1. Result = Read Value + Factor
  2. Factor = Antenna Factor + Cable Loss - Amplifier
  3. According to technical experiences, all spurious emission of FM mode at channel 0,39,78 are almost the same below 1GHz, so that the channel 0 was chosen as representative in final test.
  4. The data is worst case.



Power	: AC 120V	Pol/Phase	: HORIZONTAL
Test Mode	: Transmit / Receive	Temperature	: 27 °C
Operation Channel	: 0	Humidity	: 55 %
Modulation Type	: GFSK	Atmospheric Pressure	: 1021 hPa
Memo	:	Rate	: 1 Mbps

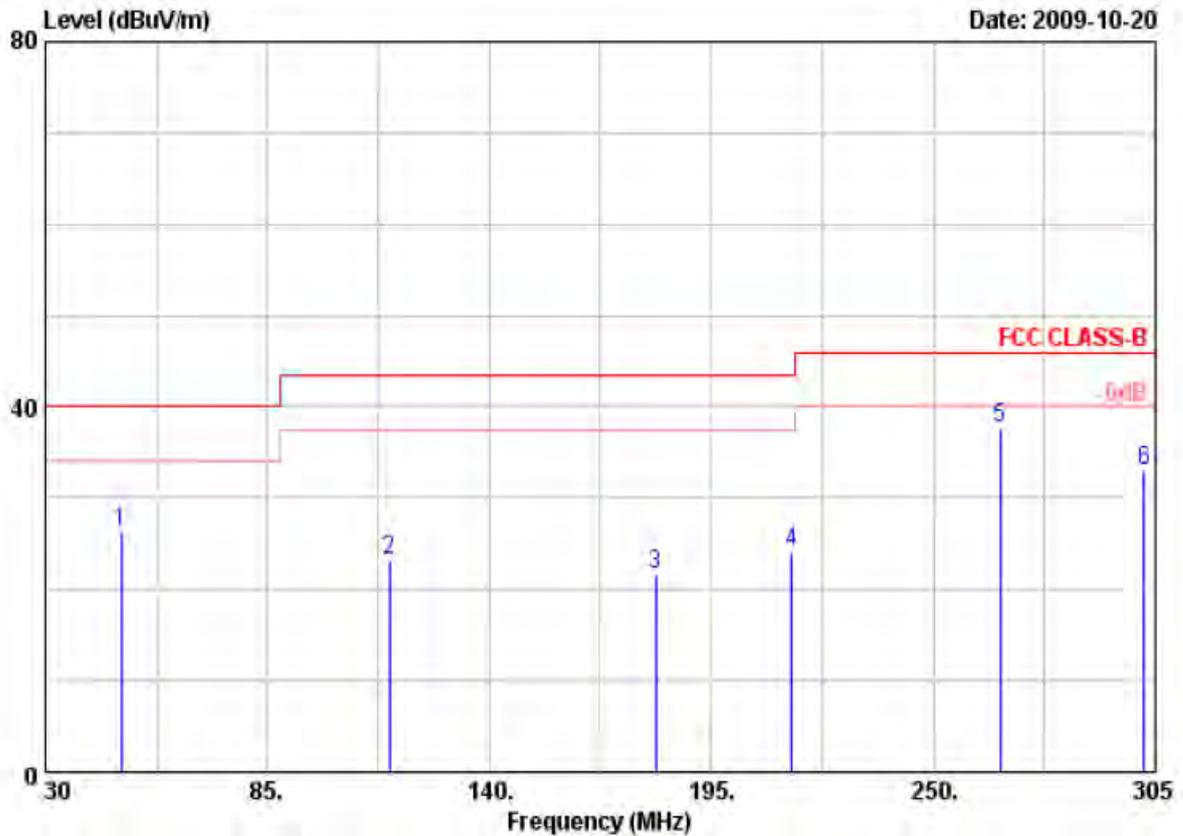

Item	Freq	Read Value	Factor	Result	Limit	Margin	Remark	Ant Pos	Tab Pos
	MHz	dBuV	dB/m	dBuV/m	dBuV/m	dB		cm	Deg
1	48.70	40.84	-14.64	26.20	40.00	-13.80	Peak	105	360
2	115.25	40.61	-17.46	23.15	43.50	-20.35	Peak	105	360
3	181.25	38.78	-17.27	21.51	43.50	-21.99	Peak	105	360
4	214.80	40.71	-16.59	24.12	43.50	-19.38	Peak	105	360
5	266.50	51.32	-13.58	37.74	46.00	-8.26	Peak	105	360
6	302.25	45.54	-12.60	32.94	46.00	-13.06	Peak	105	360

- Remarks:
1. Result = Read Value + Factor
  2. Factor = Antenna Factor + Cable Loss - Amplifier
  3. According to technical experiences, all spurious emission of FM mode at channel 0,39,78 are almost the same below 1GHz, so that the channel 0 was chosen as representative in final test.
  4. The data is worst case.



Power	: AC 120V	Pol/Phase	: HORIZONTAL
Test Mode	: Transmit / Receive	Temperature	: 27 °C
Operation Channel	: 0	Humidity	: 55 %
Modulation Type	: GFSK	Atmospheric Pressure	: 1021 hPa
Memo	:	Rate	: 1 Mbps

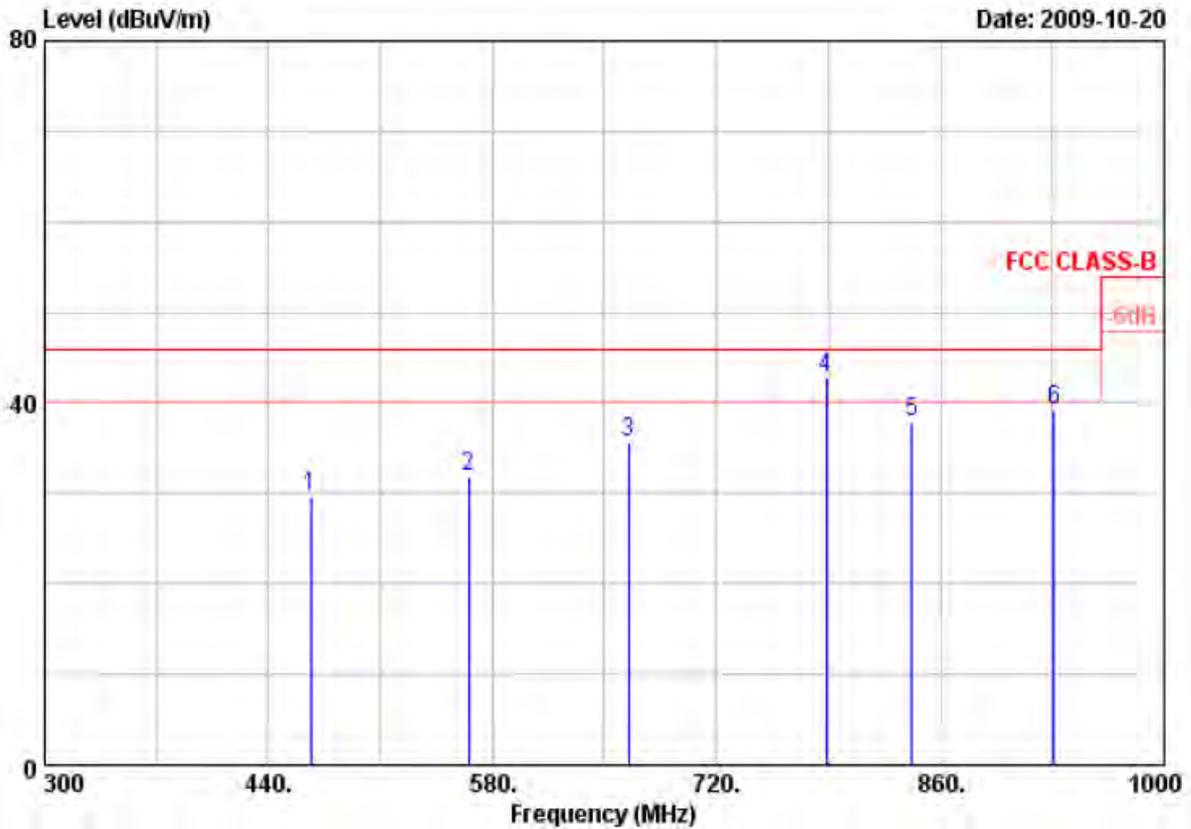

Item	Freq	Read Value	Factor	Result	Limit	Margin	Remark	Ant. Pos	Tab Pos
	MHz	dBuV	dB/m	dBuV/m	dBuV/m	dB		cm	Deg
1	466.60	35.38	-5.77	29.61	46.00	-16.39	Peak	105	0
2	565.30	33.54	-1.65	31.89	46.00	-14.11	Peak	105	0
3	665.40	39.47	-3.89	35.58	46.00	-10.42	Peak	105	0
4	788.60	43.11	-0.29	42.82	46.00	-3.18	QP	105	0
5	842.50	36.69	1.24	37.93	46.00	-8.07	Peak	105	0
6	931.40	36.84	2.41	39.25	46.00	-6.75	Peak	105	0

- Remarks:
1. Result = Read Value + Factor
  2. Factor = Antenna Factor + Cable Loss - Amplifier
  3. According to technical experiences, all spurious emission of FM mode at channel 0,39,78 are almost the same below 1GHz, so that the channel 0 was chosen as representative in final test.
  4. The data is worst case.



Power	: AC 120V	Pol/Phase	: VERTICAL
Test Mode	: Transmit / Receive	Temperature	: 26 °C
Operation Channel	: 0	Humidity	: 60 %
Modulation Type	: GFSK	Atmospheric Pressure	: 1007 hPa
Memo	:	Rate	: 1 Mbps

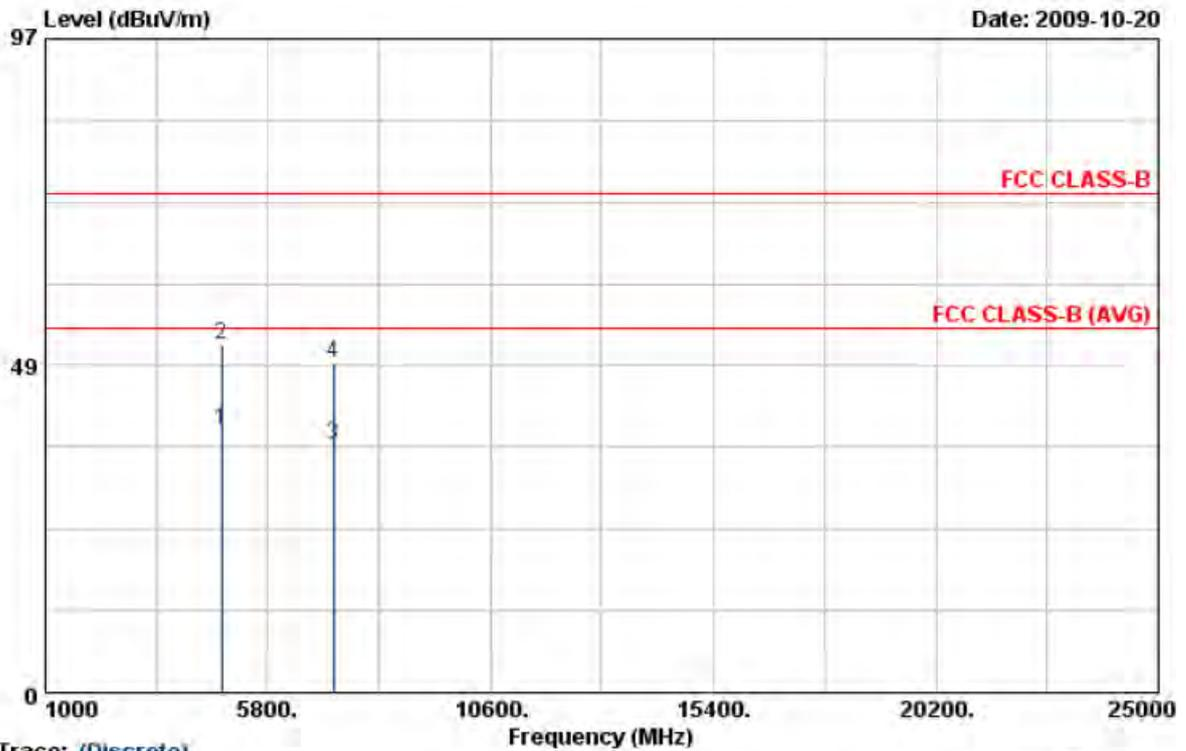

Trace: (Discrete)

Item	Freq	Read Value	Factor	Result	Limit	Margin	Remark	Ant Pos	Tab Pos
	MHz	dBuV	dB/m	dBuV/m	dBuV/m	dB		cm	Deg
1	4804.03	36.31	2.67	38.98	54.00	-15.02	Average	119	240
2	4804.03	48.98	2.67	51.65	74.00	-22.35	Peak	119	240
3	7205.43	29.63	7.07	36.70	54.00	-17.30	Average	119	240
4	7205.43	41.91	7.07	48.98	74.00	-25.02	Peak	119	240

Notes:

1. Result = Read Value + Factor
2. Factor = Antenna Factor + Cable Loss - Amplifier
3. The resolution bandwidth of test receiver/spectrum analyzer is 120KHz and video bandwidth is 300kHz for Peak detection and Quasi-peak detection at frequency below 1GHz.
4. The resolution bandwidth of test receiver/spectrum analyzer is 1MHz and video bandwidth is 3MHz for Peak detection at frequency above 1GHz.
5. The resolution bandwidth of test receiver/spectrum analyzer is 1MHz and video bandwidth is 10Hz for Average detection at frequency above 1GHz.
6. The other emissions is too low to be measured.
7. The data is worse case.



Power	: AC 120V	Pol/Phase	: HORIZONTAL
Test Mode	: Transmit / Receive	Temperature	: 26 °C
Operation Channel	: 0	Humidity	: 60 %
Modulation Type	: GFSK	Atmospheric Pressure	: 1007 hPa
Memo	:	Rate	: 1 Mbps

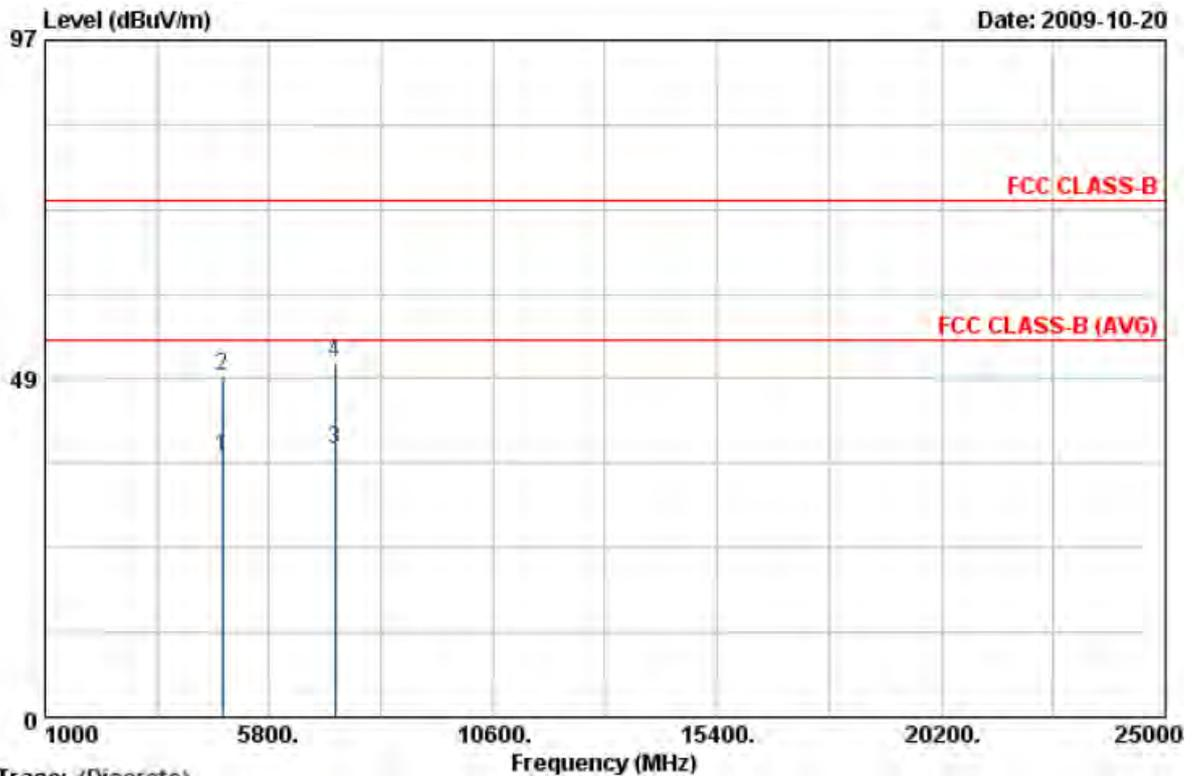

Trace: (Discrete)

Item	Freq	Read Value	Factor	Result	Limit	Margin	Remark	Ant Pos	Tab Pos
	MHz	dBuV	dB/m	dBuV/m	dBuV/m	dB		cm	Deg
1	4803.95	34.64	2.67	37.31	54.00	-16.69	Average	150	250
2	4803.95	46.21	2.67	48.88	74.00	-25.12	Peak	150	250
3	7205.65	31.29	7.07	38.36	54.00	-15.64	Average	150	250
4	7205.65	43.72	7.07	50.79	74.00	-23.21	Peak	150	250

Notes:

1. Result = Read Value + Factor
2. Factor = Antenna Factor + Cable Loss - Amplifier
3. The resolution bandwidth of test receiver/spectrum analyzer is 120KHz and video bandwidth is 300kHz for Peak detection and Quasi-peak detection at frequency below 1GHz.
4. The resolution bandwidth of test receiver/spectrum analyzer is 1MHz and video bandwidth is 3MHz for Peak detection at frequency above 1GHz.
5. The resolution bandwidth of test receiver/spectrum analyzer is 1MHz and video bandwidth is 10Hz for Average detection at frequency above 1GHz.
6. The other emissions is too low to be measured.
7. The data is worse case.



Power	: AC 120V	Pol/Phase	: VERTICAL
Test Mode	: Transmit / Receive	Temperature	: 26 °C
Operation Channel	: 39	Humidity	: 60 %
Modulation Type	: GFSK	Atmospheric Pressure	: 1007 hPa
Memo	:	Rate	: 1 Mbps

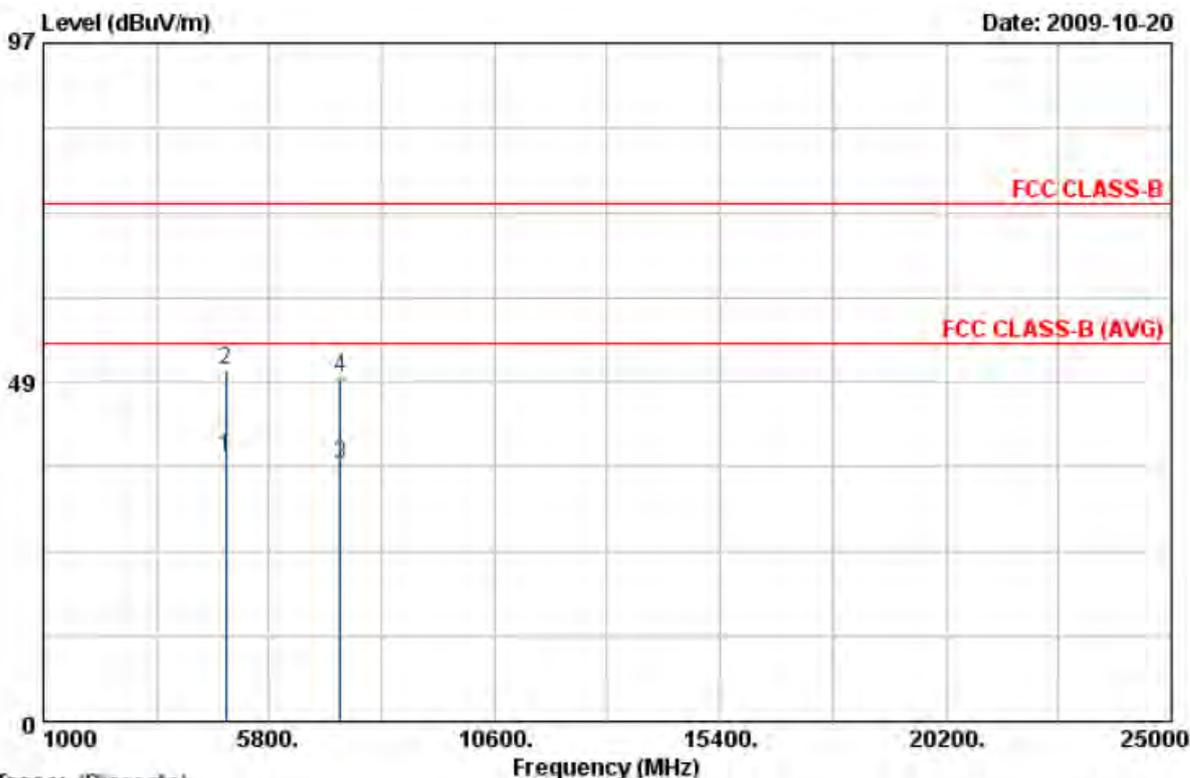

Trace: (Discrete)

Item	Freq	Read Value	Factor	Result	Limit	Margin	Remark	Ant Pos	Tab Pos
	MHz	dBuV	dB/m	dBuV/m	dBuV/m	dB		cm	Deg
1	4882.03	34.87	2.89	37.76	54.00	-16.24	Average	119	240
2	4882.03	47.48	2.89	50.37	74.00	-23.63	Peak	119	240
3	7322.88	29.28	7.43	36.71	54.00	-17.29	Average	119	240
4	7322.88	41.84	7.43	49.27	74.00	-24.73	Peak	119	240

Notes:

1. Result = Read Value + Factor
2. Factor = Antenna Factor + Cable Loss - Amplifier
3. The resolution bandwidth of test receiver/spectrum analyzer is 120KHz and video bandwidth is 300kHz for Peak detection and Quasi-peak detection at frequency below 1GHz.
4. The resolution bandwidth of test receiver/spectrum analyzer is 1MHz and video bandwidth is 3MHz for Peak detection at frequency above 1GHz.
5. The resolution bandwidth of test receiver/spectrum analyzer is 1MHz and video bandwidth is 10Hz for Average detection at frequency above 1GHz.
6. The other emissions is too low to be measured.
7. The data is worse case.



Power	: AC 120V	Pol/Phase	: HORIZONTAL
Test Mode	: Transmit / Receive	Temperature	: 26 °C
Operation Channel	: 39	Humidity	: 60 %
Modulation Type	: GFSK	Atmospheric Pressure	: 1007 hPa
Memo	:	Rate	: 1 Mbps

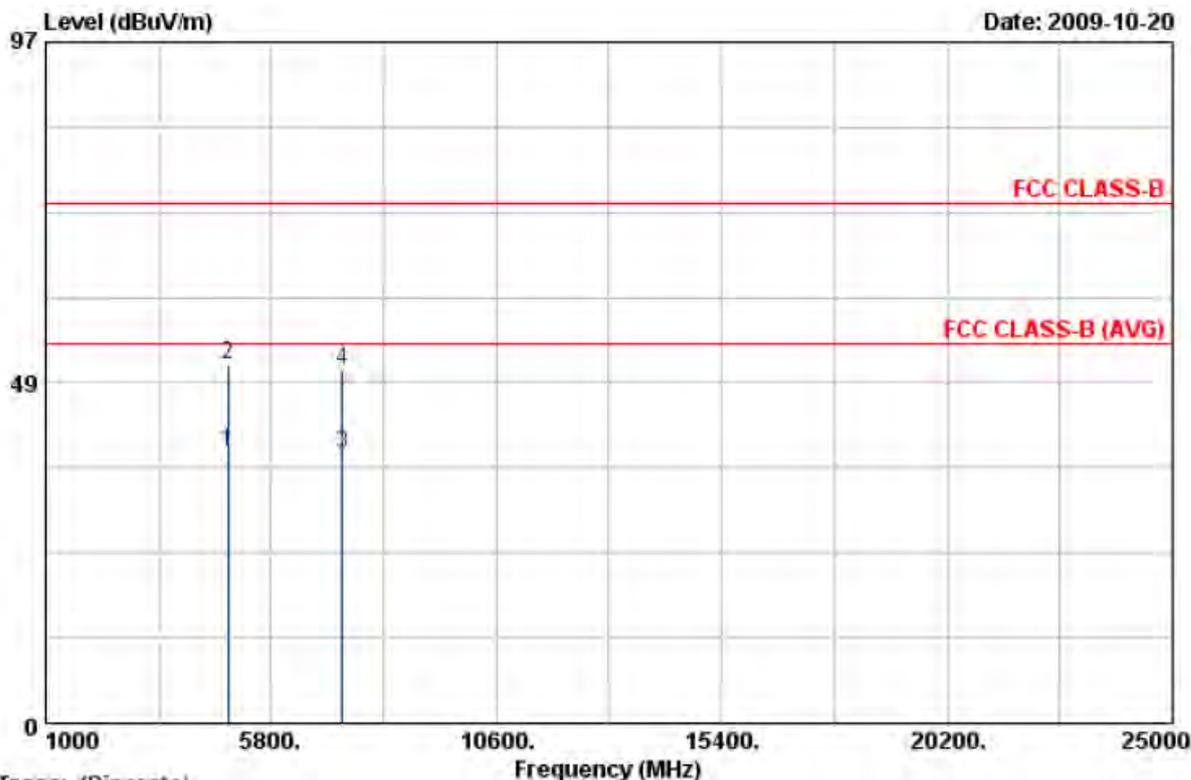

Trace: (Discrete)

Item	Freq	Read Value	Factor	Result	Limit	Margin	Remark	Ant Pos	Tab Pos
	MHz	dBuV	dB/m	dBuV/m	dBuV/m	dB		cm	Deg
1	4682.08	35.85	2.89	38.74	54.00	-15.26	Average	150	250
2	4682.08	48.19	2.89	51.08	74.00	-22.92	Peak	150	250
3	7322.05	30.82	7.43	38.25	54.00	-15.75	Average	150	250
4	7322.05	42.72	7.43	50.15	74.00	-23.85	Peak	150	250

Notes:

1. Result = Read Value + Factor
2. Factor = Antenna Factor + Cable Loss - Amplifier
3. The resolution bandwidth of test receiver/spectrum analyzer is 120KHz and video bandwidth is 300kHz for Peak detection and Quasi-peak detection at frequency below 1GHz.
4. The resolution bandwidth of test receiver/spectrum analyzer is 1MHz and video bandwidth is 3MHz for Peak detection at frequency above 1GHz.
5. The resolution bandwidth of test receiver/spectrum analyzer is 1MHz and video bandwidth is 10Hz for Average detection at frequency above 1GHz.
6. The other emissions is too low to be measured.
7. The data is worse case.



Power	: AC 120V	Pol/Phase	: VERTICAL
Test Mode	: Transmit / Receive	Temperature	: 26 °C
Operation Channel	: 78	Humidity	: 60 %
Modulation Type	: GFSK	Atmospheric Pressure	: 1007 hPa
Memo	:	Rate	: 1 Mbps

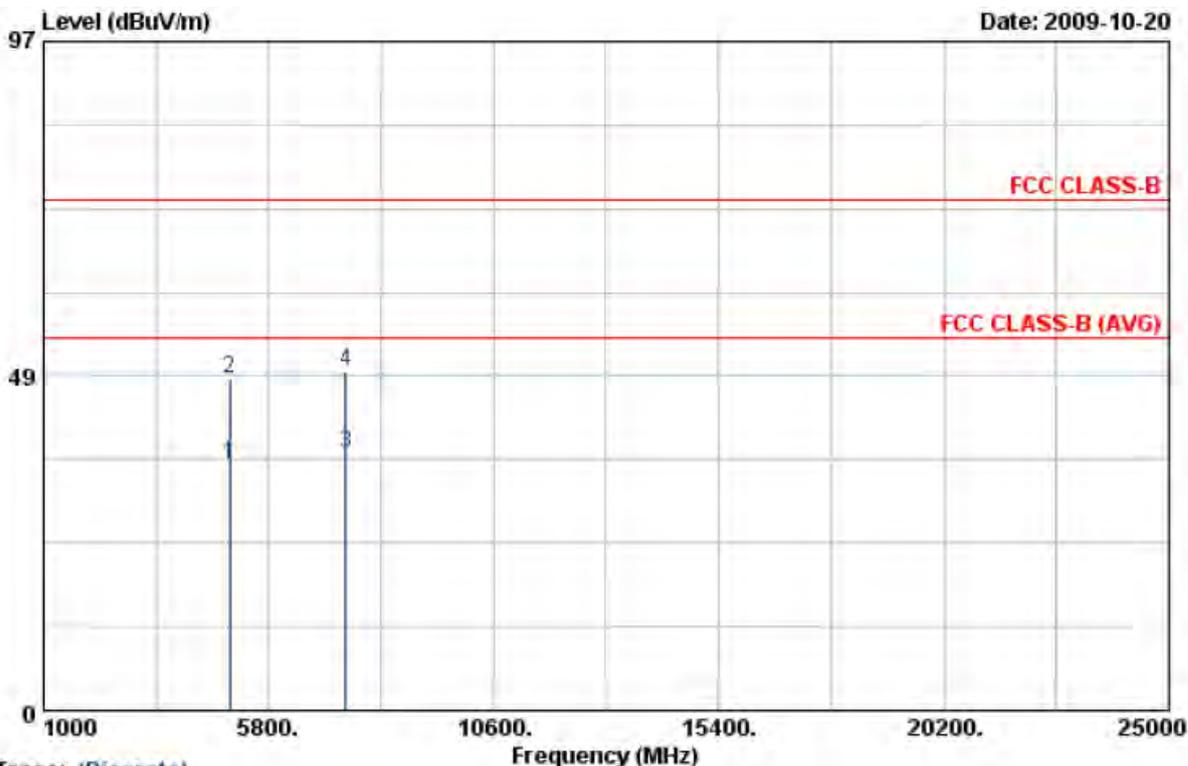

Trace: (Discrete)

Item	Freq	Read Value	Factor	Result	Limit	Margin	Remark	Ant Pos	Tab Pos
	MHz	dBuV	dB/m	dBuV/m	dBuV/m	dB		cm	Deg
1	4959.93	32.57	3.11	35.68	54.00	-18.32	Average	119	240
2	4959.93	44.96	3.11	48.07	74.00	-25.93	Peak	119	240
3	7439.93	29.43	7.79	37.22	54.00	-16.78	Average	119	240
4	7439.93	41.52	7.79	49.31	74.00	-24.69	Peak	119	240

Notes:

1. Result = Read Value + Factor
2. Factor = Antenna Factor + Cable Loss - Amplifier
3. The resolution bandwidth of test receiver/spectrum analyzer is 120KHz and video bandwidth is 300kHz for Peak detection and Quasi-peak detection at frequency below 1GHz.
4. The resolution bandwidth of test receiver/spectrum analyzer is 1MHz and video bandwidth is 3MHz for Peak detection at frequency above 1GHz.
5. The resolution bandwidth of test receiver/spectrum analyzer is 1MHz and video bandwidth is 10Hz for Average detection at frequency above 1GHz.
6. The other emissions is too low to be measured.
7. The data is worse case.



Power	: AC 120V	Pol/Phase	: HORIZONTAL
Test Mode	: Transmit / Receive	Temperature	: 26 °C
Operation Channel	: 78	Humidity	: 60 %
Modulation Type	: GFSK	Atmospheric Pressure	: 1007 hPa
Memo	:	Rate	: 1 Mbps

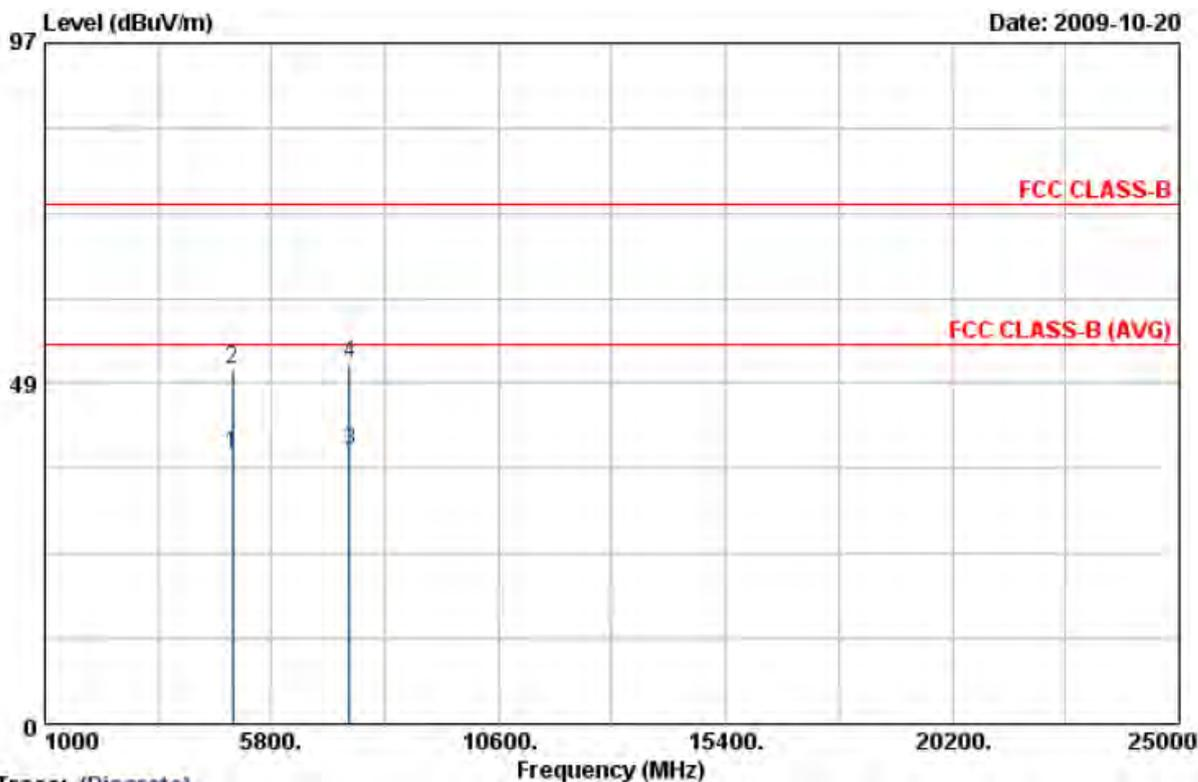

Trace: (Discrete)

Item	Freq MHz	Read		Result dBuV/m	Limit dBuV/m	Margin dB	Remark	Ant Pos cm	Tab Pos Deg
		Value dBuV	Factor dB/m						
1	4960.05	35.28	3.11	38.39	54.00	-15.61	Average	150	250
2	4960.05	47.37	3.11	50.48	74.00	-23.52	Peak	150	250
3	7444.78	31.22	7.81	39.03	54.00	-14.97	Average	150	250
4	7444.78	43.53	7.81	51.34	74.00	-22.66	Peak	150	250

Notes:

1. Result = Read Value + Factor
2. Factor = Antenna Factor + Cable Loss - Amplifier
3. The resolution bandwidth of test receiver/spectrum analyzer is 120KHz and video bandwidth is 300kHz for Peak detection and Quasi-peak detection at frequency below 1GHz.
4. The resolution bandwidth of test receiver/spectrum analyzer is 1MHz and video bandwidth is 3MHz for Peak detection at frequency above 1GHz.
5. The resolution bandwidth of test receiver/spectrum analyzer is 1MHz and video bandwidth is 10Hz for Average detection at frequency above 1GHz.
6. The other emissions is too low to be measured.
7. The data is worse case.



Power	: AC 120V	Pol/Phase	: VERTICAL
Test Mode	: Transmit / Receive	Temperature	: 27 °C
Operation Channel	: 0	Humidity	: 55 %
Modulation Type	: $\pi/4$ -DQPSK	Atmospheric Pressure	: 1021 hPa
Memo	:	Rate	: 2 Mbps

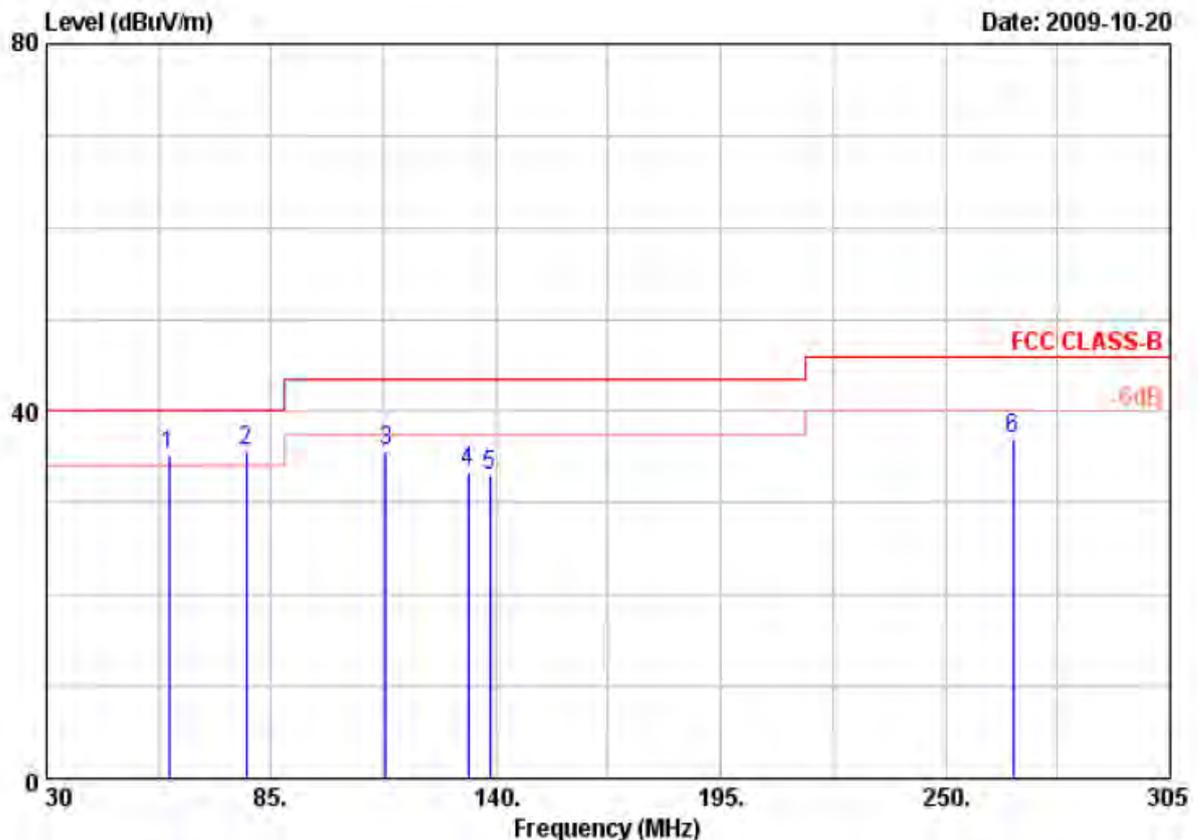

Item	Freq	Read Value	Factor	Result	Limit	Margin	Remark	Ant Pos	Tab Pos
	MHz	dBuV	dB/m	dBuV/m	dBuV/m	dB		cm	Deg
1	59.98	47.87	-12.76	35.11	40.00	-4.89	QP	100	0
2	78.95	50.24	-14.51	35.73	40.00	-4.27	QP	100	0
3	113.05	46.31	-10.61	35.70	43.50	-7.80	Peak	100	0
4	133.13	42.84	-9.47	33.37	43.50	-10.13	Peak	100	0
5	138.63	43.76	-10.82	32.94	43.50	-10.56	Peak	100	0
6	266.50	49.55	-12.51	37.04	46.00	-8.96	Peak	100	0

- Remarks:
1. Result = Read Value + Factor
  2. Factor = Antenna Factor + Cable Loss - Amplifier
  3. According to technical experiences, all spurious emission of BT mode at channel 0,39,78 are almost the same below 1GHz, so that the channel 0 was chosen as representative in final test.
  4. The data is worst case.



Power	: AC 120V	Pol/Phase	: VERTICAL
Test Mode	: Transmit / Receive	Temperature	: 27 °C
Operation Channel	: 0	Humidity	: 55 %
Modulation Type	: $\pi/4$ -DQPSK	Atmospheric Pressure	: 1021 hPa
Memo	:	Rate	: 2 Mbps

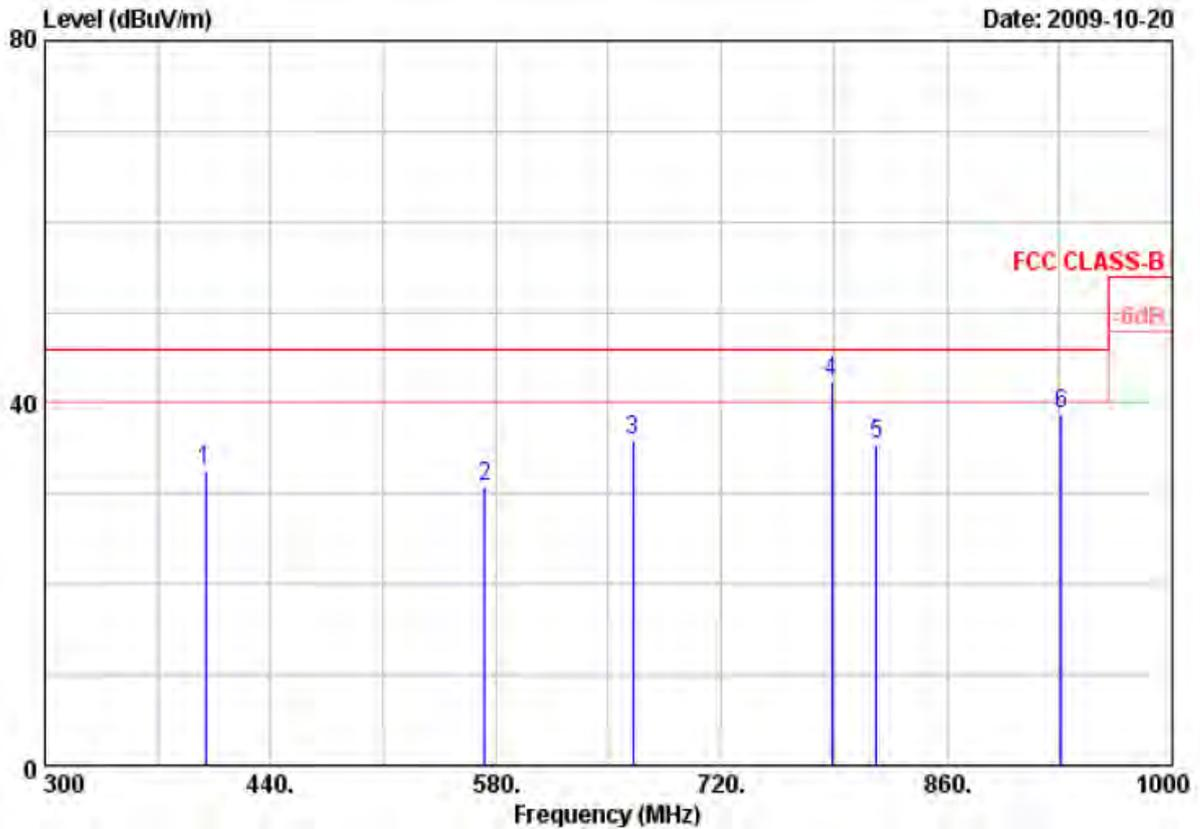

Item	Freq	Read Value	Factor	Result	Limit	Margin	Remark	Ant Pos	Tab Pos
	MHz	dBuV	dB/m	dBuV/m	dBuV/m	dB		cm	Deg
1	399.40	39.48	-6.97	32.51	46.00	-13.49	Peak	105	0
2	573.00	34.10	-3.27	30.83	46.00	-15.17	Peak	105	0
3	665.40	40.05	-4.22	35.83	46.00	-10.17	Peak	105	0
4	788.60	44.28	-1.97	42.31	46.00	-3.69	QP	105	0
5	816.60	35.96	-0.46	35.50	46.00	-10.50	Peak	105	0
6	931.40	34.05	4.75	38.80	46.00	-7.20	Peak	105	0

- Remarks:
1. Result = Read Value + Factor
  2. Factor = Antenna Factor + Cable Loss - Amplifier
  3. According to technical experiences, all spurious emission of FM mode at channel 0,39,78 are almost the same below 1GHz, so that the channel 0 was chosen as representative in final test.
  4. The data is worst case.



Power	: AC 120V	Pol/Phase	: HORIZONTAL
Test Mode	: Transmit / Receive	Temperature	: 27 °C
Operation Channel	: 0	Humidity	: 55 %
Modulation Type	: $\pi/4$ -DQPSK	Atmospheric Pressure	: 1021 hPa
Memo	:	Rate	: 2 Mbps

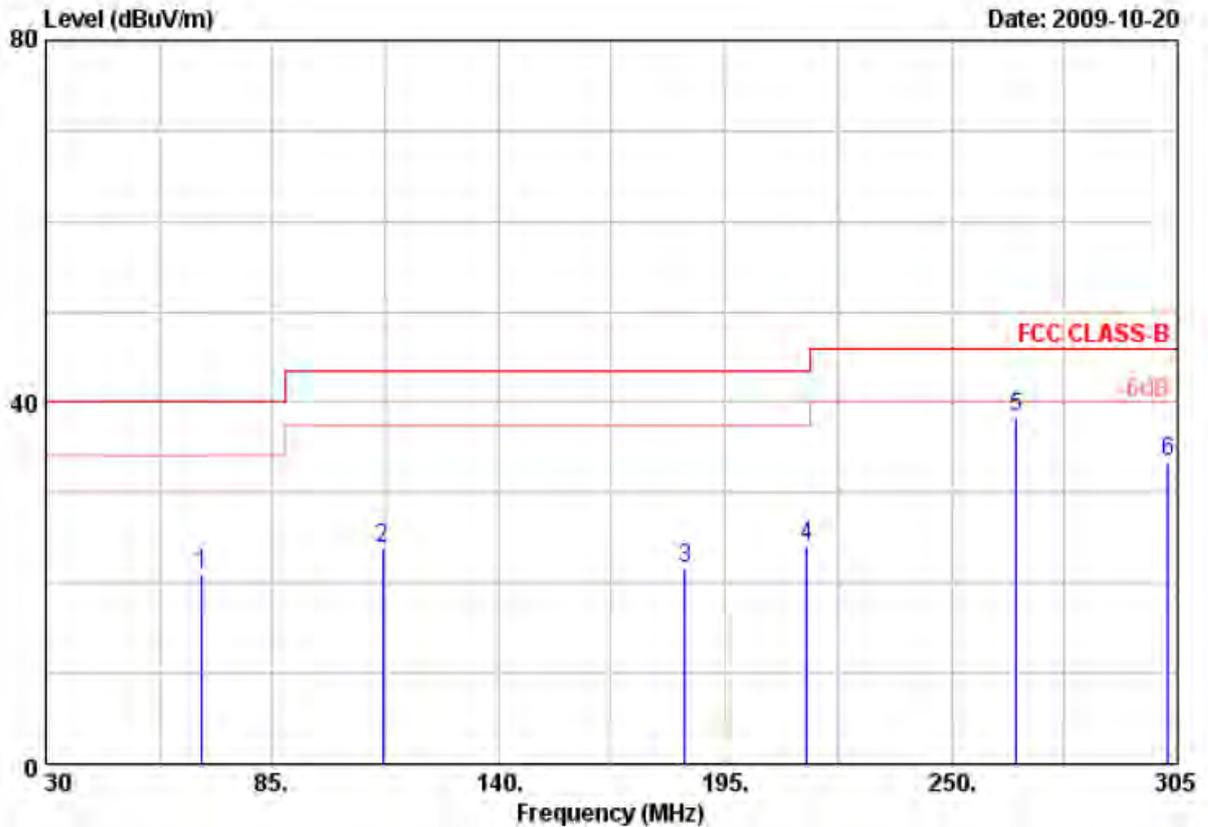

Item	Freq MHz	Read Value dBuV	Factor dB/m	Result dBuV/m	Limit dBuV/m	Margin dB	Remark	Ant Pos cm	Tab Pos Deg
1	67.95	42.07	-21.22	20.85	40.00	-19.15	Peak	105	360
2	111.95	41.51	-17.72	23.79	43.50	-19.71	Peak	105	360
3	185.38	39.14	-17.42	21.72	43.50	-21.78	Peak	105	360
4	214.80	40.71	-16.59	24.12	43.50	-19.38	Peak	105	360
5	265.95	51.99	-13.64	38.35	46.00	-7.65	Peak	105	360
6	302.80	46.05	-12.52	33.53	46.00	-12.47	Peak	105	360

- Remarks:
1. Result = Read Value + Factor
  2. Factor = Antenna Factor + Cable Loss - Amplifier
  3. According to technical experiences, all spurious emission of FM mode at channel 0,39,78 are almost the same below 1GHz, so that the channel 0 was chosen as representative in final test.
  4. The data is worst case.



Power	: AC 120V	Pol/Phase	: HORIZONTAL
Test Mode	: Transmit / Receive	Temperature	: 27 °C
Operation Channel	: 0	Humidity	: 55 %
Modulation Type	: $\pi/4$ -DQPSK	Atmospheric Pressure	: 1021 hPa
Memo	:	Rate	: 2 Mbps

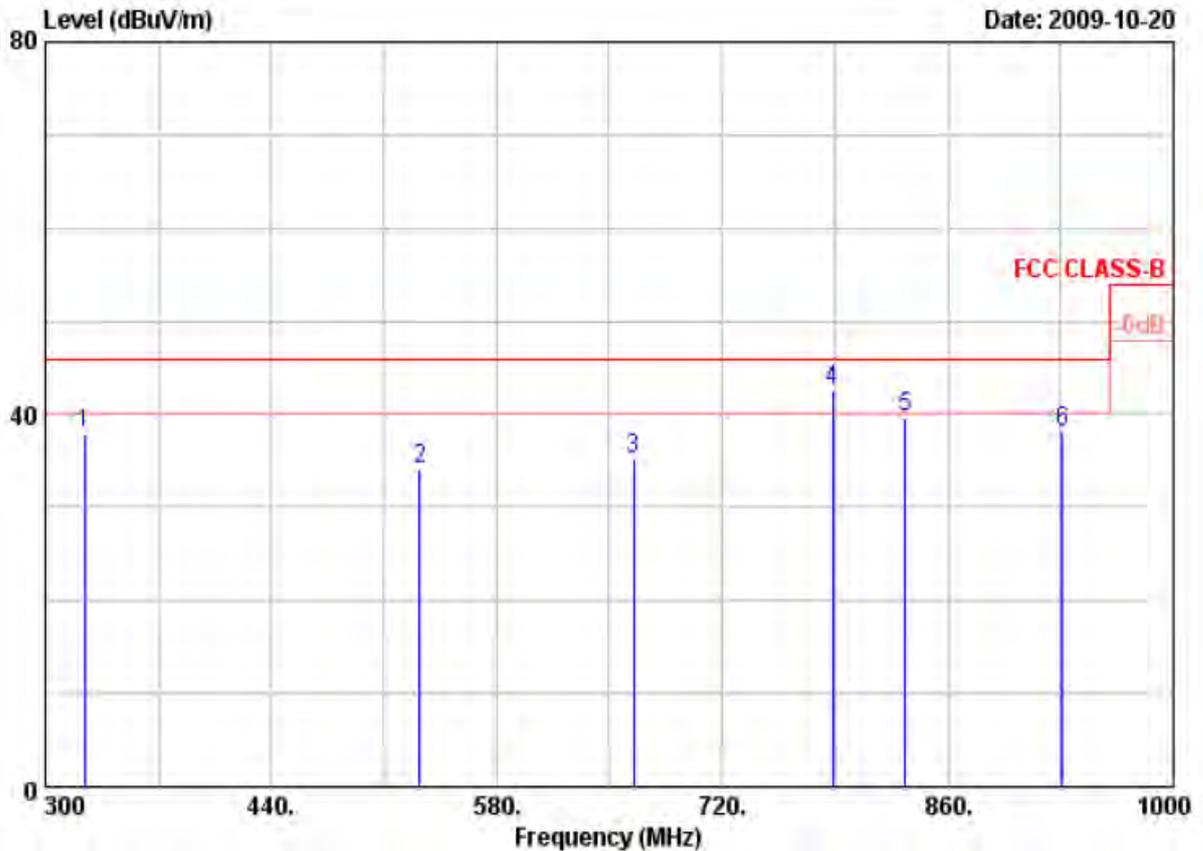

Item	Freq	Read Value	Factor	Result	Limit	Margin	Remark	Ant Pos	Tab Pos
	MHz	dBuV	dB/m	dBuV/m	dBuV/m	dB		cm	Deg
1	324.50	49.73	-11.95	37.78	46.00	-8.22	Peak	105	0
2	532.40	39.77	-5.57	34.20	46.00	-11.80	Peak	105	0
3	665.40	39.03	-3.89	35.14	46.00	-10.86	Peak	105	0
4	788.60	42.85	-0.29	42.56	46.00	-3.44	QP	105	0
5	833.40	37.95	1.78	39.73	46.00	-6.27	Peak	105	0
6	931.40	35.72	2.41	38.13	46.00	-7.87	Peak	105	0

Remarks: 1. Result = Read Value + Factor  
 2. Factor = Antenna Factor + Cable Loss - Amplifier  
 3. According to technical experiences, all spurious emission of FM mode at channel 0, 39.78 are almost the same below 1GHz, so that the channel 0 was chosen as representative in final test.  
 4. The data is worst case.



Power	: AC 120V	Pol/Phase	: VERTICAL
Test Mode	: Transmit / Receive	Temperature	: 26 °C
Operation Channel	: 0	Humidity	: 60 %
Modulation Type	: $\pi/4$ -DQPSK	Atmospheric Pressure	: 1007 hPa
Memo	:	Rate	: 2 Mbps

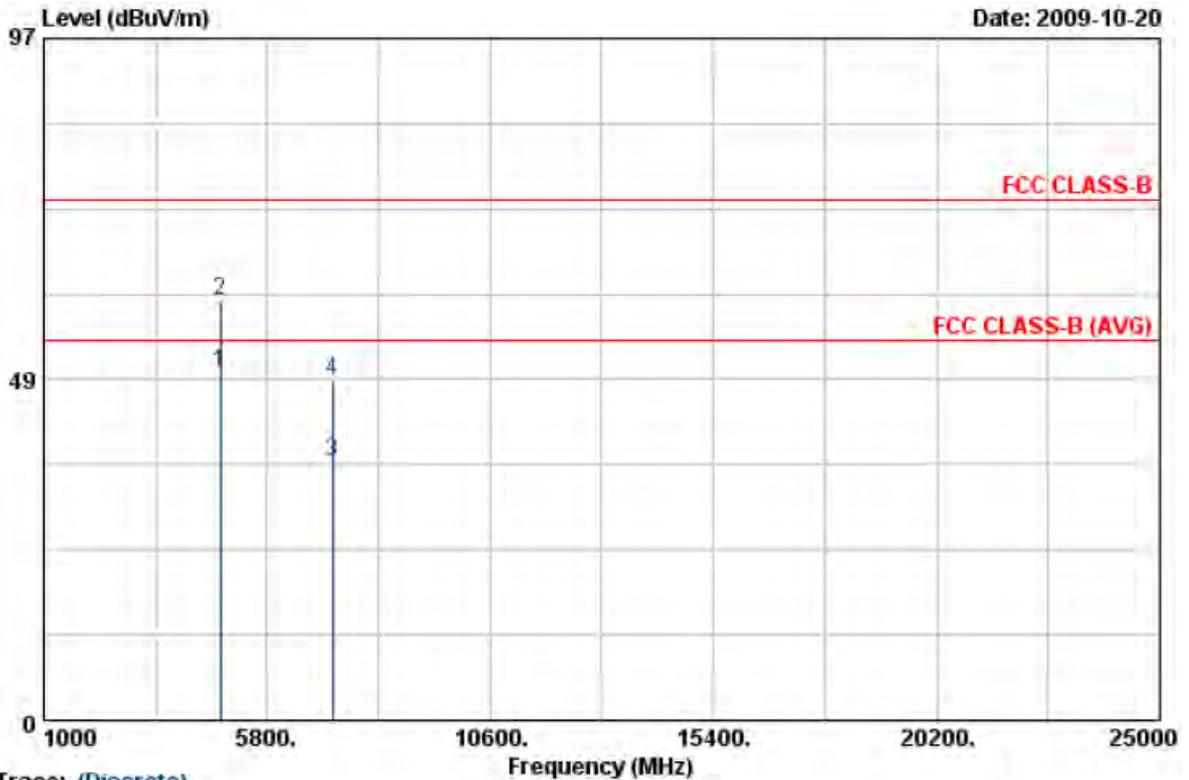

Trace: (Discrete)

Item	Freq	Read Value	Factor	Result	Limit	Margin	Remark	Ant Pos	Tab Pos
	MHz	dBuV	dB/m	dBuV/m	dBuV/m	dB		cm	Deg
1	4803.98	46.78	2.67	49.45	54.00	-4.55	Average	119	240
2	4803.98	56.95	2.67	59.62	74.00	-14.38	Peak	119	240
3	7205.98	29.54	7.07	36.61	54.00	-17.39	Average	119	240
4	7205.98	41.19	7.07	48.26	74.00	-25.74	Peak	119	240

Notes:

1. Result = Read Value + Factor
2. Factor = Antenna Factor + Cable Loss - Amplifier
3. The resolution bandwidth of test receiver/spectrum analyzer is 120KHz and video bandwidth is 300kHz for Peak detection and Quasi-peak detection at frequency below 1GHz.
4. The resolution bandwidth of test receiver/spectrum analyzer is 1MHz and video bandwidth is 3MHz for Peak detection at frequency above 1GHz.
5. The resolution bandwidth of test receiver/spectrum analyzer is 1MHz and video bandwidth is 10Hz for Average detection at frequency above 1GHz.
6. The other emissions is too low to be measured.
7. The data is worse case.



Power	: AC 120V	Pol/Phase	: VERTICAL
Test Mode	: Transmit / Receive	Temperature	: 26 °C
Operation Channel	: 0	Humidity	: 60 %
Modulation Type	: $\pi/4$ -DQPSK	Atmospheric Pressure	: 1007 hPa
Memo	:	Rate	: 2 Mbps

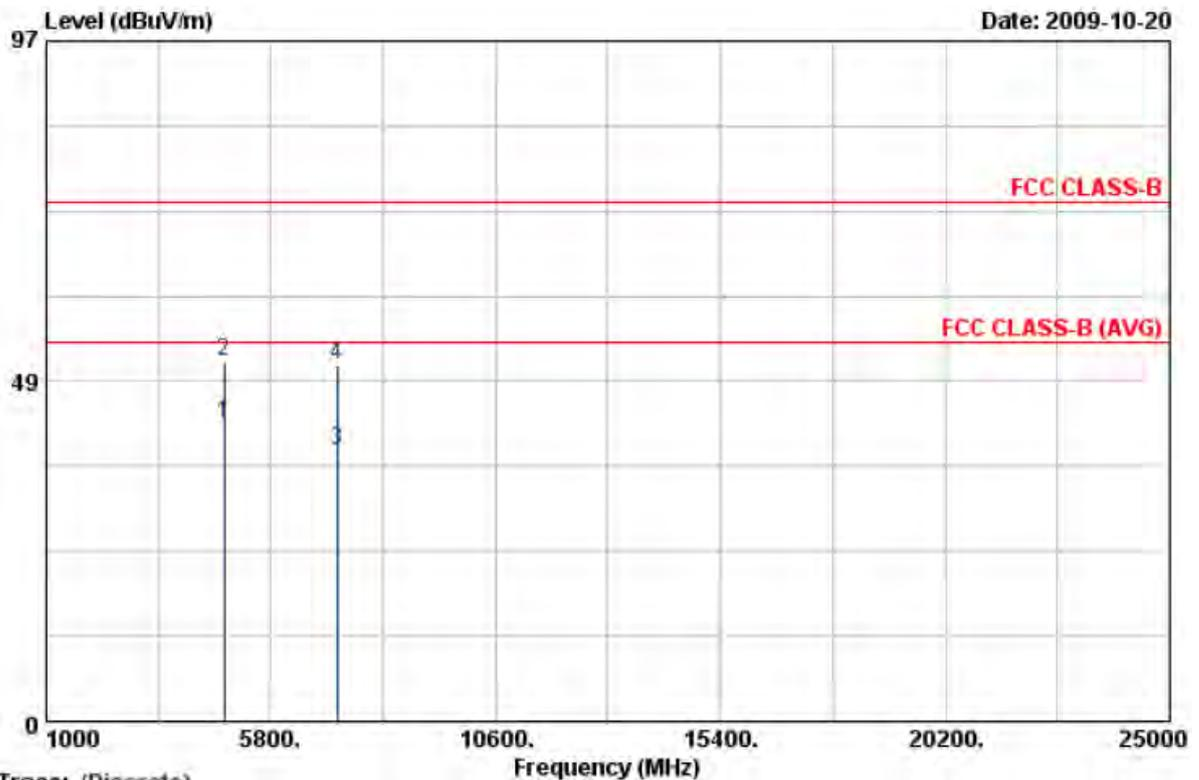

Trace: (Discrete)

Item	Freq	Read Value	Factor	Result	Limit	Margin	Remark	Ant Pos	Tab Pos
	MHz	dBuV	dB/m	dBuV/m	dBuV/m	dB		cm	Deg
1	4804.00	39.74	2.67	42.41	54.00	-11.59	Average	150	250
2	4804.00	48.60	2.67	51.27	74.00	-22.73	Peak	150	250
3	7206.03	31.48	7.07	38.55	54.00	-15.45	Average	150	250
4	7206.03	43.81	7.07	50.88	74.00	-23.12	Peak	150	250

Notes:

1. Result = Read Value + Factor
2. Factor = Antenna Factor + Cable Loss - Amplifier
3. The resolution bandwidth of test receiver/spectrum analyzer is 120KHz and video bandwidth is 300kHz for Peak detection and Quasi-peak detection at frequency below 1GHz.
4. The resolution bandwidth of test receiver/spectrum analyzer is 1MHz and video bandwidth is 3MHz for Peak detection at frequency above 1GHz.
5. The resolution bandwidth of test receiver/spectrum analyzer is 1MHz and video bandwidth is 10Hz for Average detection at frequency above 1GHz.
6. The other emissions is too low to be measured.
7. The data is worse case.



Power	: AC 120V	Pol/Phase	: VERTICAL
Test Mode	: Transmit / Receive	Temperature	: 26 °C
Operation Channel	: 39	Humidity	: 60 %
Modulation Type	: $\pi/4$ -DQPSK	Atmospheric Pressure	: 1007 hPa
Memo	:	Rate	: 2 Mbps

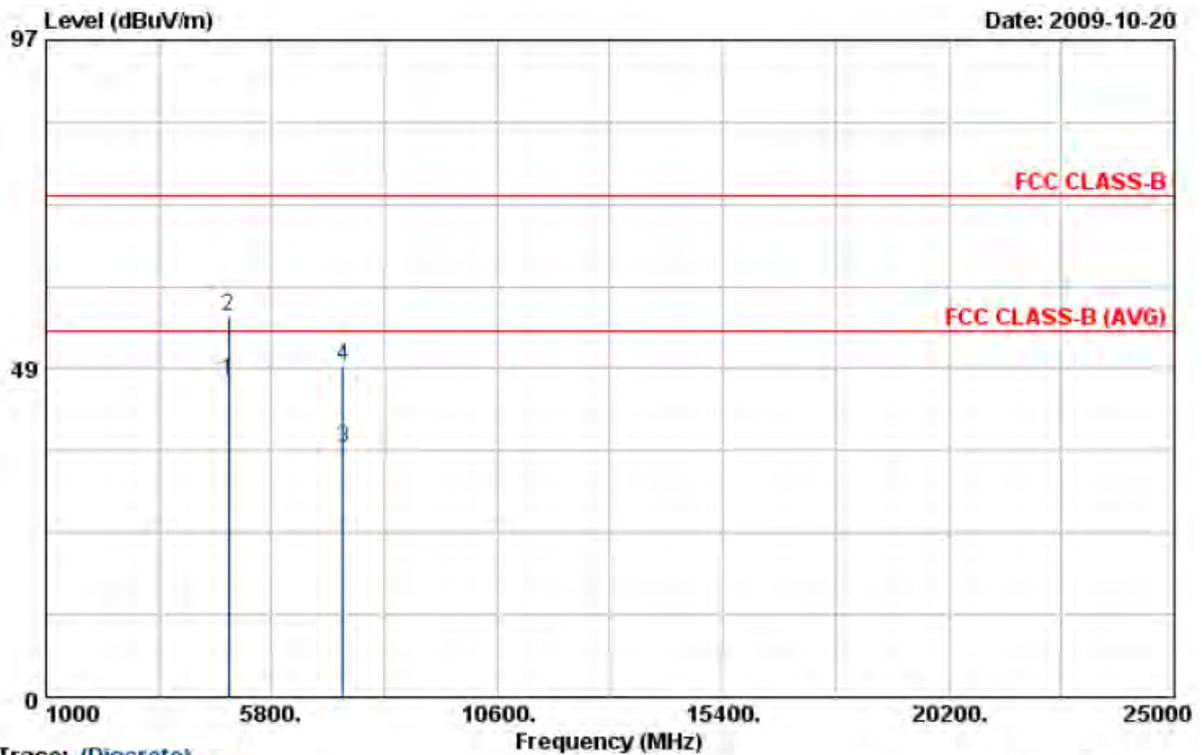

Trace: (Discrete)

Item	Freq	Read Value	Factor	Result	Limit	Margin	Remark	Ant. Pos	Tab Pos
	MHz	dBuV	dB/m	dBuV/m	dBuV/m	dB		cm	Deg
1	4882.00	43.77	2.89	46.66	54.00	-7.34	Average	119	240
2	4882.00	53.30	2.89	56.19	74.00	-17.81	Peak	119	240
3	7323.03	29.28	7.43	36.71	54.00	-17.29	Average	119	240
4	7323.03	41.43	7.43	48.86	74.00	-25.14	Peak	119	240

Notes:

1. Result = Read Value + Factor
2. Factor = Antenna Factor + Cable Loss - Amplifier
3. The resolution bandwidth of test receiver/spectrum analyzer is 120kHz and video bandwidth is 300kHz for Peak detection and Quasi-peak detection at frequency below 1GHz.
4. The resolution bandwidth of test receiver/spectrum analyzer is 1MHz and video bandwidth is 3MHz for Peak detection at frequency above 1GHz.
5. The resolution bandwidth of test receiver/spectrum analyzer is 1MHz and video bandwidth is 10Hz for Average detection at frequency above 1GHz.
6. The other emissions is too low to be measured.
7. The data is worse case.



Power	: AC 120V	Pol/Phase	: HORIZONTAL
Test Mode	: Transmit / Receive	Temperature	: 26 °C
Operation Channel	: 39	Humidity	: 60 %
Modulation Type	: $\pi/4$ -DQPSK	Atmospheric Pressure	: 1007 hPa
Memo	:	Rate	: 2 Mbps

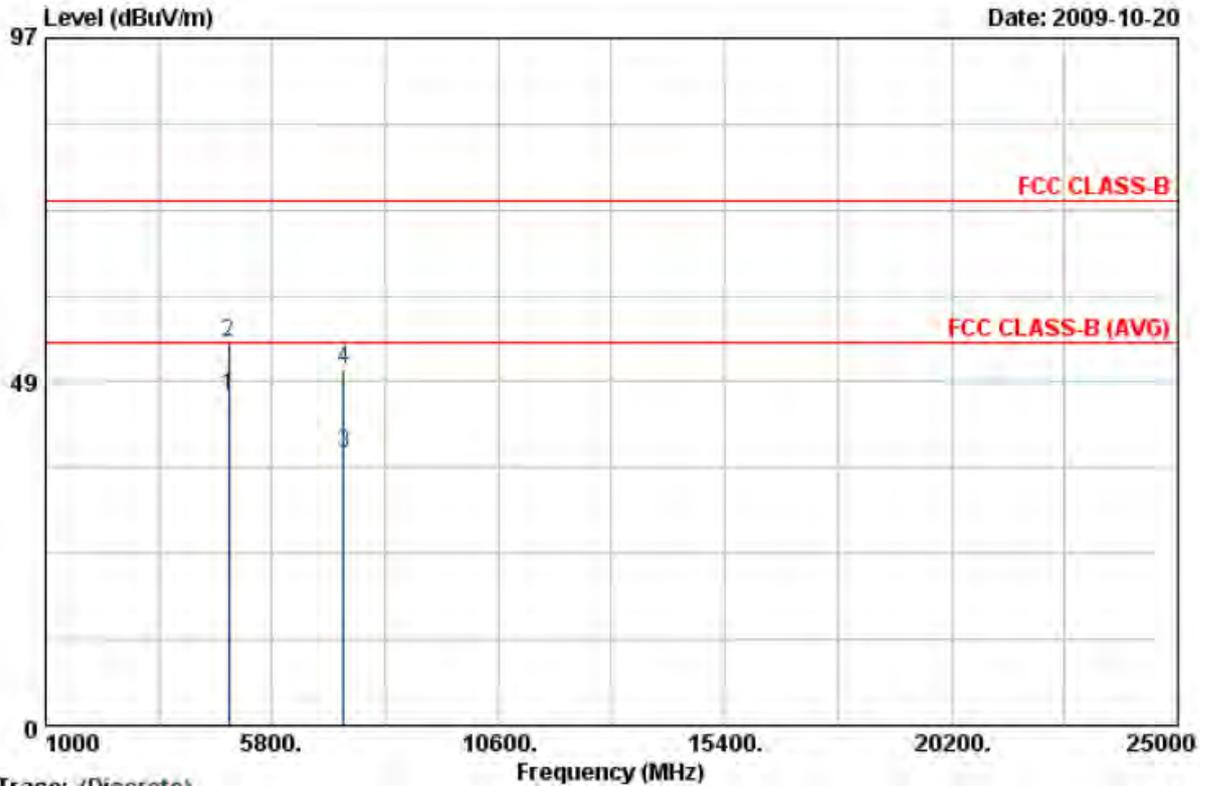

Trace: (Discrete)

Item	Freq	Read Value	Factor	Result	Limit	Margin	Remark	Ant Pos	Tab Pos
	MHz	dBuV	dB/m	dBuV/m	dBuV/m	dB		cm	Deg
1	4882.03	43.62	2.89	46.51	54.00	-7.49	Average	150	250
2	4882.03	51.12	2.89	54.01	74.00	-19.99	Peak	150	250
3	7323.15	30.87	7.43	38.30	54.00	-15.70	Average	150	250
4	7323.15	42.80	7.43	50.23	74.00	-23.77	Peak	150	250

Notes:

1. Result = Read Value + Factor
2. Factor = Antenna Factor + Cable Loss - Amplifier
3. The resolution bandwidth of test receiver/spectrum analyzer is 120KHz and video bandwidth is 300kHz for Peak detection and Quasi-peak detection at frequency below 1GHz.
4. The resolution bandwidth of test receiver/spectrum analyzer is 1MHz and video bandwidth is 3MHz for Peak detection at frequency above 1GHz.
5. The resolution bandwidth of test receiver/spectrum analyzer is 1MHz and video bandwidth is 10Hz for Average detection at frequency above 1GHz.
6. The other emissions is too low to be measured.
7. The data is worse case.



Power	: AC 120V	Pol/Phase	: VERTICAL
Test Mode	: Transmit / Receive	Temperature	: 26 °C
Operation Channel	: 78	Humidity	: 60 %
Modulation Type	: $\pi/4$ -DQPSK	Atmospheric Pressure	: 1007 hPa
Memo	:	Rate	: 2 Mbps

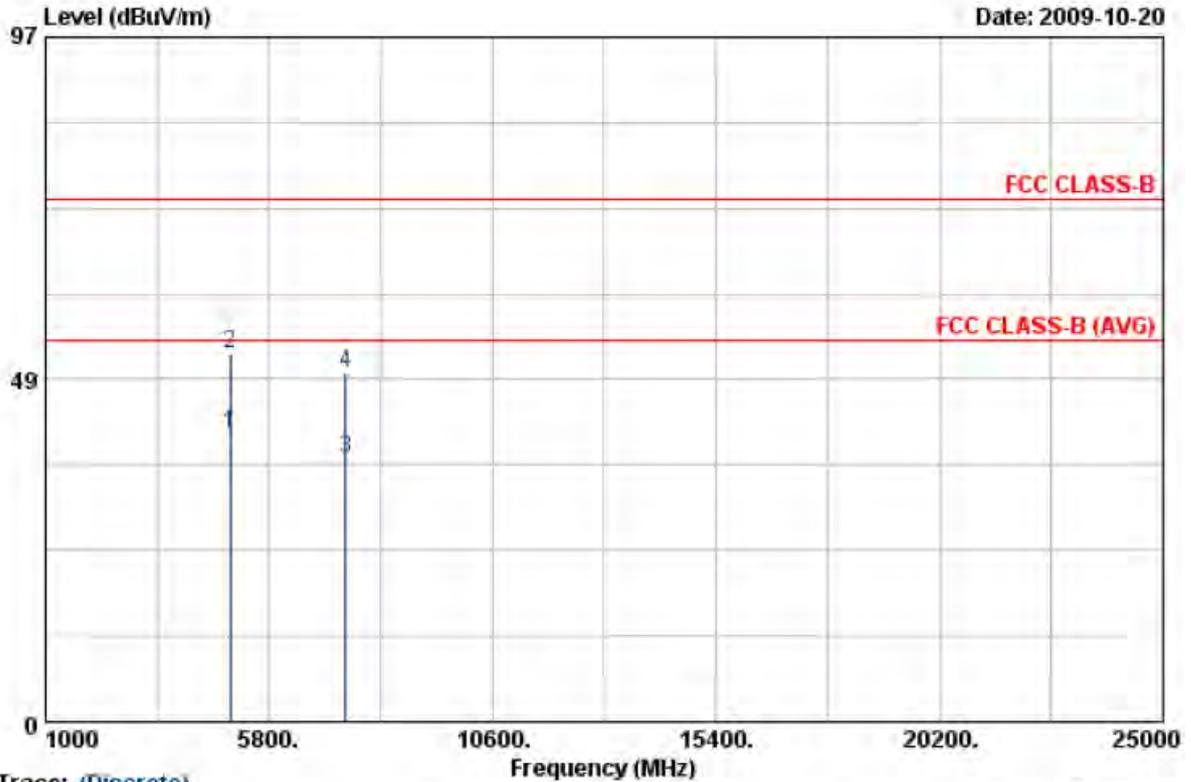

Trace: (Discrete)

Item	Freq	Read Value	Factor	Result	Limit	Margin	Remark	Ant Pos	Tab Pos
	MHz	dBuV	dB/m	dBuV/m	dBuV/m	dB		cm	Deg
1	4960.00	37.58	3.11	40.69	54.00	-13.31	Average	119	240
2	4960.00	49.05	3.11	52.16	74.00	-21.84	Peak	119	240
3	7442.50	29.50	7.80	37.30	54.00	-16.70	Average	119	240
4	7442.50	41.61	7.80	49.41	74.00	-24.59	Peak	119	240

Notes:

1. Result = Read Value + Factor
2. Factor = Antenna Factor + Cable Loss - Amplifier
3. The resolution bandwidth of test receiver/spectrum analyzer is 120KHz and video bandwidth is 300kHz for Peak detection and Quasi-peak detection at frequency below 1GHz.
4. The resolution bandwidth of test receiver/spectrum analyzer is 1MHz and video bandwidth is 3MHz for Peak detection at frequency above 1GHz.
5. The resolution bandwidth of test receiver/spectrum analyzer is 1MHz and video bandwidth is 10Hz for Average detection at frequency above 1GHz.
6. The other emissions is too low to be measured.
7. The data is worse case.



Power	: AC 120V	Pol/Phase	: HORIZONTAL
Test Mode	: Transmit / Receive	Temperature	: 26 °C
Operation Channel	: 78	Humidity	: 60 %
Modulation Type	: $\pi/4$ -DQPSK	Atmospheric Pressure	: 1007 hPa
Memo	:	Rate	: 2 Mbps

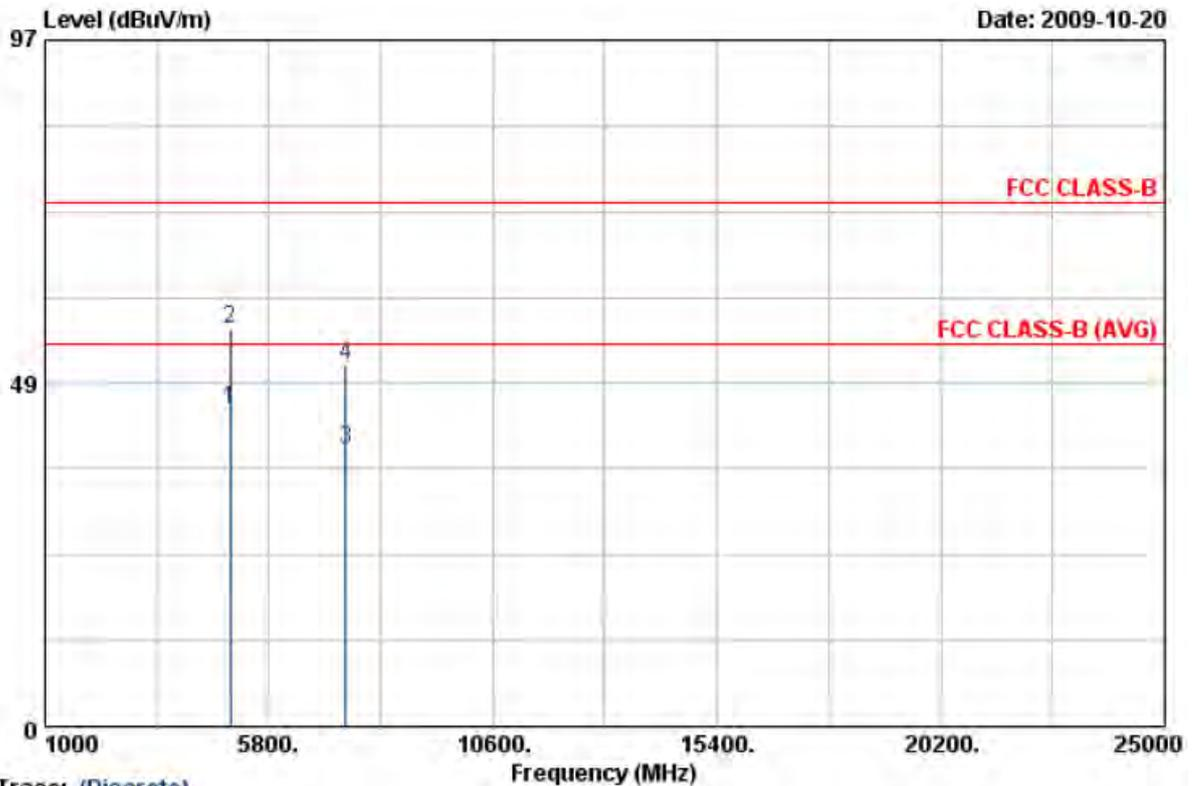

Trace: (Discrete)

Item	Freq	Read Value	Factor	Result	Limit	Margin	Remark	Ant Pos	Tab Pos
	MHz	dBuV	dB/m	dBuV/m	dBuV/m	dB		cm	Deg
1	4959.98	41.64	3.11	44.75	54.00	-9.25	Average	150	250
2	4959.98	53.01	3.11	56.12	74.00	-17.88	Peak	150	250
3	7442.50	31.28	7.80	39.08	54.00	-14.92	Average	150	250
4	7442.50	43.18	7.80	50.98	74.00	-23.02	Peak	150	250

Notes:

1. Result = Read Value + Factor
2. Factor = Antenna Factor + Cable Loss - Amplifier
3. The resolution bandwidth of test receiver/spectrum analyzer is 120KHz and video bandwidth is 300kHz for Peak detection and Quasi-peak detection at frequency below 1GHz.
4. The resolution bandwidth of test receiver/spectrum analyzer is 1MHz and video bandwidth is 3MHz for Peak detection at frequency above 1GHz.
5. The resolution bandwidth of test receiver/spectrum analyzer is 1MHz and video bandwidth is 10Hz for Average detection at frequency above 1GHz.
6. The other emissions is too low to be measured.
7. The data is worse case.