

OT-100

User Manual



Copyright

This publication, including all photographs, illustrations and software, is protected under international copyright laws, with all rights reserved. Neither this manual, nor any of the material contained herein, may be reproduced without written consent of PARTNER Tech Corp.

Disclaimer

The information in this document is subject to change without notice. The manufacturer makes no representations or warranties with respect to the contents hereof and specifically disclaims any implied warranties of merchantability or fitness for any particular purpose. The manufacturer reserves the right to revise this publication and to make changes from time to time in the content hereof without obligation of the manufacturer to notify any person of such revision or changes.

Trademark recognition

All product names used in this manual are the properties of their respective owners and are acknowledged.

Federal Communications Commission (FCC)

This equipment has been tested and found to comply with the limits for a Class B digital device, pursuant to Part 15 of the FCC Rules. These limits are designed to provide reasonable protection against harmful interference in a residential installation. This equipment generates, uses, and can radiate radio frequency energy and, if not installed and used in accordance with the instructions, may cause harmful interference to radio communications. However, there is no guarantee that interference will not occur in a particular installation. If this equipment does cause harmful interference to radio or television reception, which can be determined by turning the equipment off and on, the user is encouraged to try to correct the interference by one or more of the following measures:

Reorient or relocate the receiving antenna.

Increase the separation between the equipment and the receiver.

Connect the equipment onto an outlet on a circuit different from that to which the receiver is connected.

Consult the dealer or an experienced radio/TV technician for help.

Shielded interconnect cables and a shielded AC power cable must be employed with this equipment to ensure compliance with the pertinent RF emission limits governing this device. Changes or modifications not expressly approved by the system's manufacturer could void the user's authority to operate the equipment.

Important Note

This device has been SAR-evaluated for use with Laptop/Notebook computers and meets the FCC RF exposure guidelines for an uncontrolled environment. 0.255 W/kg.

Declaration of conformity

This device complies with part 15 of the FCC rules. Operation is subject to the following conditions:

This device may not cause harmful interference, and

This device must accept any interference received, including interference that may cause undesired operation.

About this manual

This manual is intended for system administrators who are familiar with setting up a new system and installing programs.

The manual consists of the following sections:

Chapter 1 Getting Started:	This section covers unpacking and checking the package contents, identifying components, charge the battery, install the SD card and power it on..
Chapter 2 Learning The Basics:	The chapter provides information how to use the basic features.
Chapter 3 Using The Accessories:	This section provides information how to use the accessories.
Appendix:	The appendix covers troubleshooting, information on having the OT-100 serviced, and technical specifications.

Safety information

Before installing and using the OT-100, take note of the following precautions:

Request service for damaged products: Turn off the product, unplug it from the electrical outlet, and request service from a service partner under the following conditions:

- The power cord or plug is damaged.
- Liquid has been spilled into the product.
- An object has fallen into the product.
- The product has been exposed to rain or water.
- The product has been dropped or damaged.
- The product does not operate normally when you follow the operating instructions.

Avoid hot areas: The product should be placed away from heat sources such as radiators, heat registers, stoves, and other products (such as amplifiers) that produce heat.

Allow the product to cool: Allow the product to cool before removing covers and touching internal components.

Avoid wet areas: Never use the product in a wet location.

Avoid inserting objects into product: Never insert objects of any kind into slots or other openings in the product.

Clean the product properly: Unplug the product from the wall outlet before cleaning it. Do not use liquid cleaners or aerosol cleaners. Use a soft cloth dampened with water for cleaning exterior components, but NEVER apply water directly to the product or to an LCD screen.

Use recommended mounting accessories: Do not use the product on an unstable table, cart, stand, tripod, or bracket. Mount the product according to the manufacturer's instructions, and use a mounting accessory recommended by the manufacturer.

Use the product with approved equipment: Use your product only with the computers and accessories identified as suitable for use with your product.

Adjust the volume: Turn down the volume before using headphones or other audio devices.

Revision history

Version 1.0, April 2009

TABLE OF CONTENTS

CHAPTER 1 GETTING STARTED	1
Unpacking the OT-100	1
Checking the package contents	2
Identifying components	4
Charge Cradle	8
Setup the OT-100.....	9
Charging the OT-100 / battery in the cradle	12
Battery Handling Precaution	13
Using SD cards	14
Install a SD card.....	14
Viewing content of a SD card.....	16
CHAPTER 2 LEARNING THE BASICS	17
Entering text.....	17
Shortcut menus	17
Performing a reset.....	17
Opening and closing programs	18
Program switch	18
Windows CE help.....	18
Adjusting the volume.....	18
Changing the device name	20
Recalibrating the screen	23
Setting the date and time	24
Install and remove programs.....	32
Upgrading OS Image or Bootloader.....	34
CHAPTER 3 USING THE ACCESSORIES	37
Using the leather pouch	37
Attaching the stylus cord.....	38
Attaching the hand strap	39
Using the shoulder strap	40
APPENDIX	41
Troubleshooting	41
Tips for Troubleshooting.....	41
General Problems	41

Having the OT-100 Serviced 42
Guidelines for care and maintenance 43
 Using the device 43
 Cleaning the device 43
 Carrying or storing the device..... 43
Specifications 44

CHAPTER 1 GETTING STARTED

This chapter describes the procedures from unpacking the OT-100, to powering it on. The following topics are described.

- Unpacking the OT-100 on page 1
- Checking the package contents on page 2
- Identifying components on page 4
- Charge Cradle on page 8
- Setup the OT-100 on page 9
- Charging the OT-100 / battery in the cradle on page 12
- Using SD cards on page 14
- Install a SD card on page 14
- Viewing content of a SD card on page 16

Unpacking the OT-100

The device and accessories are packed in a cardboard carton with foam padding for protection during shipping.

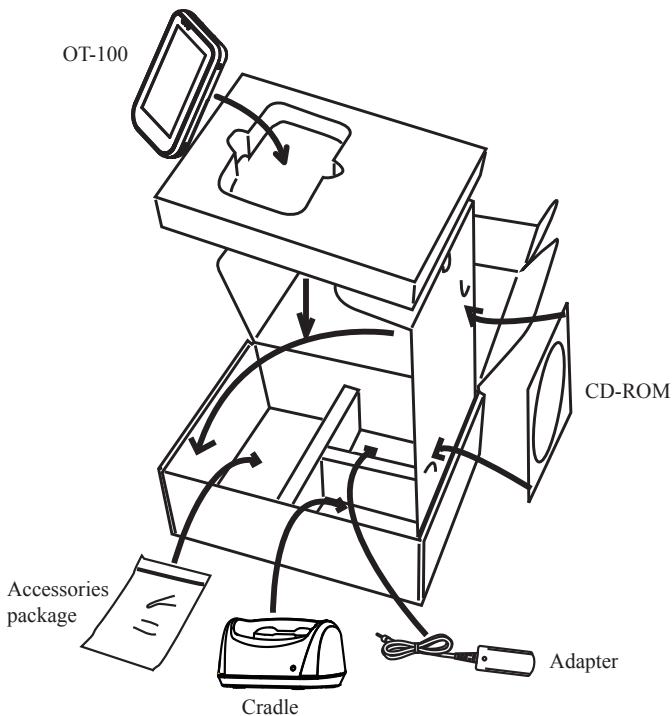
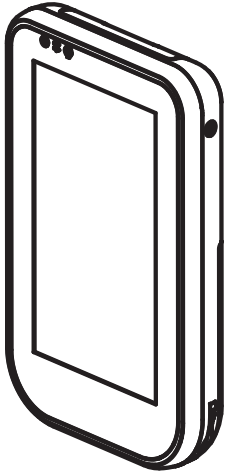

Figure 1.1 Unpacking the OT-100

Carefully unpack the machine and keep the packing materials. If you need to ship it in the future, repack it as shown in Figure 1.1.

Checking the package contents

After you unpack the device check that the following items are included.



OT-100

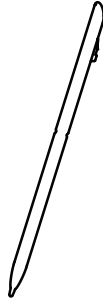

Stylus

need the
picture

High quality stylus

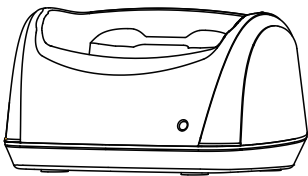

Cradle

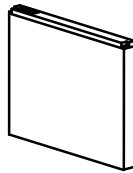

Battery

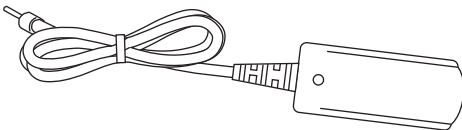

AC adapter

need the
picture

Leather pouch

need the
picture

Leather pouch cord

need the
picture

Stylus cord

need the
picture

Hand strap

need the
picture

Shoulder strap

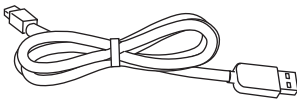

mini-USB to USB cable



2 screws



Plastic bit

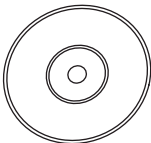

CD-ROM



Quick start guide

If any item is missing or appears damaged, contact your dealer immediately.

Identifying components

This section describes the parts and connectors on the OT-100.

Front panel components

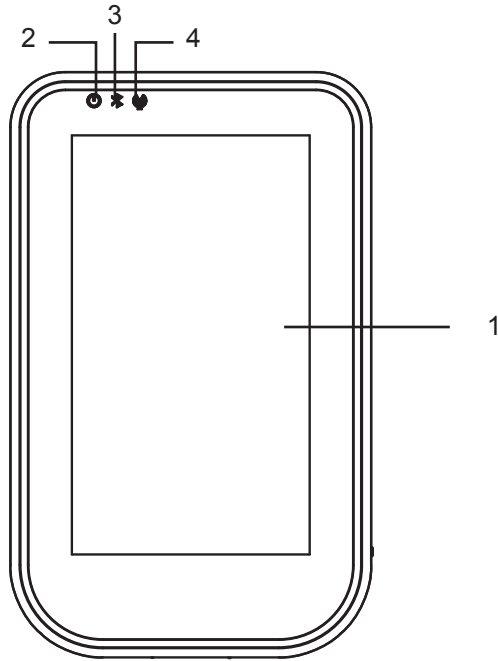

Figure 1.2 Front view

Component	Description
1	4.3-inch touch screen
2	Power indicator (Green: power on, Red: charging)
3	Bluetooth indicator (Light: Bluetooth is functional)
4	WiFi indicator (Light: WiFi is functional)

Top and bottom panel components

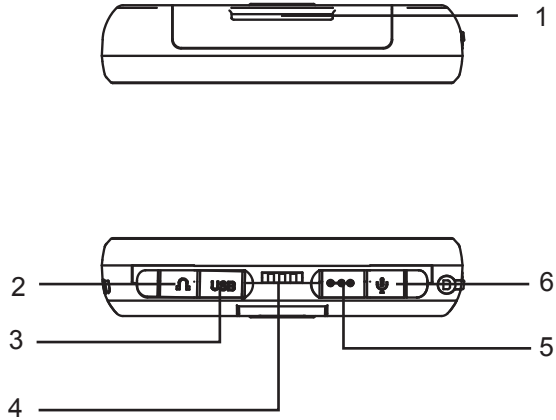

Figure 1.3 Top and bottom view

Component	Description
1	Top hand strap eyelet
2	3.5mm headphone jack
3	Mini-USB port
4	Cradle connector
5	DC power jack
6	3.5mm microphone jack

Left and right side components

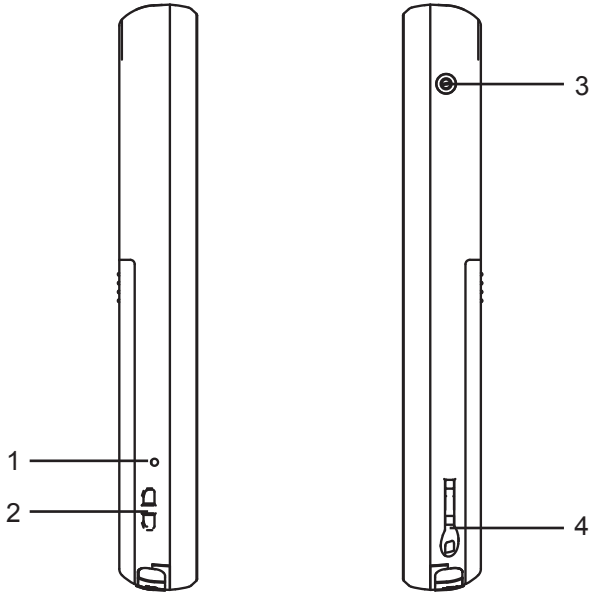

Figure 1.4 Left and right side view

Connector	Description
1	Reset button
2	Hand strap eyelet
3	Power button
4	Stylus dock

Back panel components

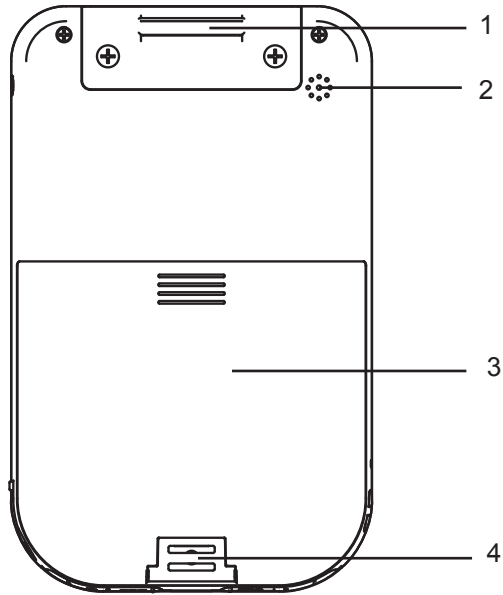

Figure 1.5 Back view

Connector	Description
1	Top hand strap eyelet
2	Speaker
3	Battery cover
4	Bottom hand strap eyelet

Charge Cradle

This section interdicts the charge cradle for the OT-100.

The charge cradle can use to charge the OT-100, it has a second slot for charging a spare battery.

Top and front view of the cradle

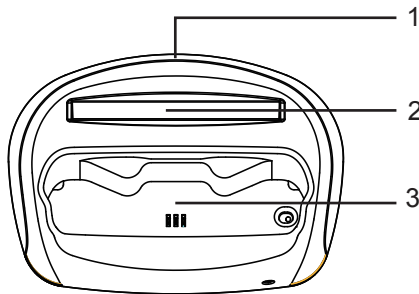

Figure 1.6 Top view of the cradle

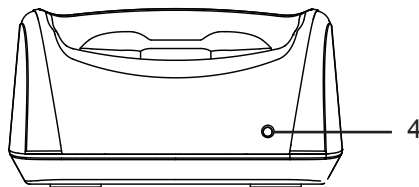
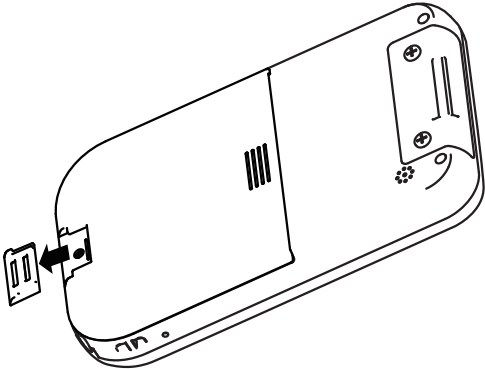
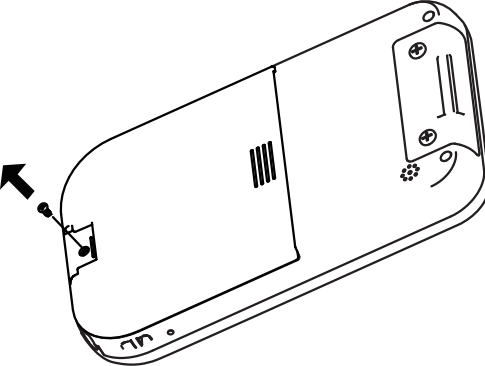
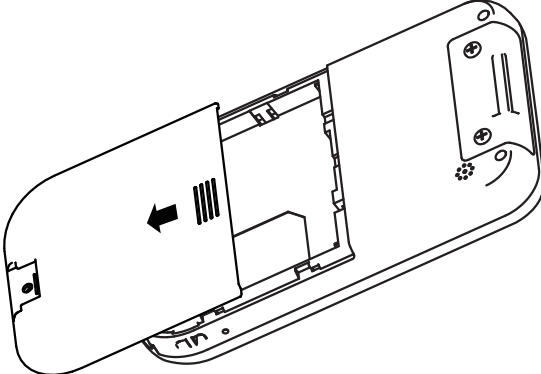

Figure 1.7 Front view of the cradle

Connector	Description
1	DC power connector
2	Second battery slot
3	OT-100 socket
4	LED charging indicator

Setup the OT-100

Refer to the following to setup the OT-100.

<p>1. Remove the plastic bit.</p>	 <p>Slide the plastic bit down and away from the battery cover.</p>
<p>2. Remove the screw if the battery cover is locked.</p>	 <p></p>
<p>3. Remove the battery cover.</p>	 <p>Slide the cover down and away from the OT-100.</p>

4. Install the battery.

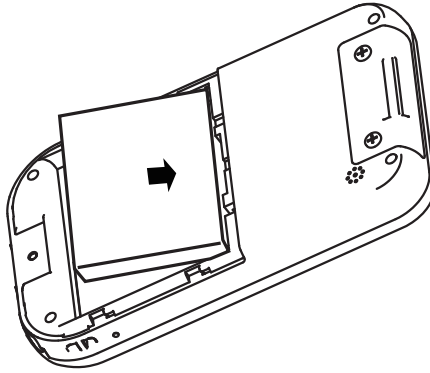

Align the battery connectors on the battery with the pins in the battery compartment and insert the battery.

5. Replace the battery cover.

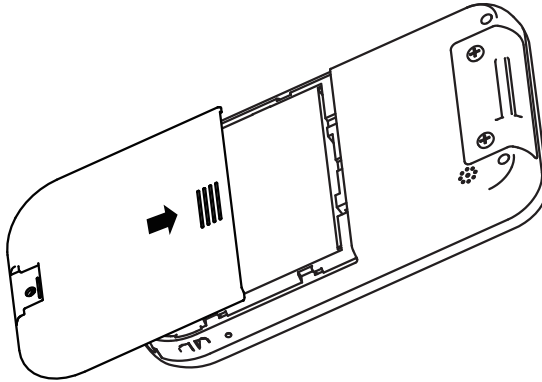

6. Reinstall the screw.

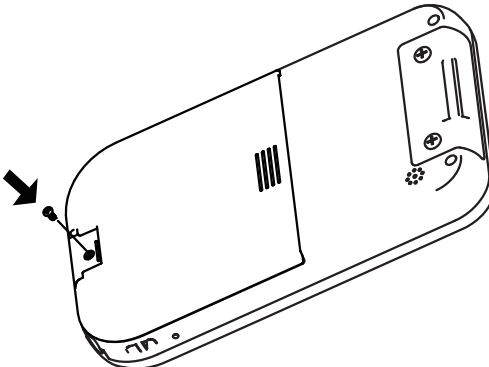

7. Replace the plastic bit.

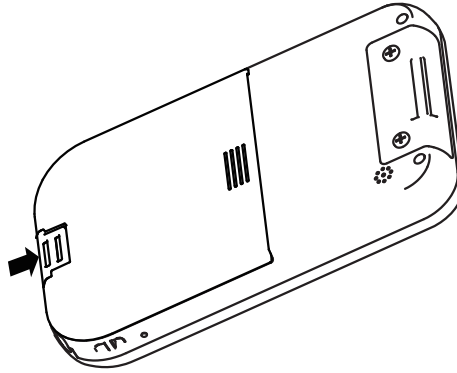

8. Charge the battery.

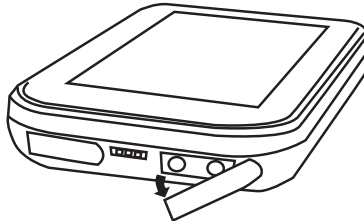

Open the power jack cover.

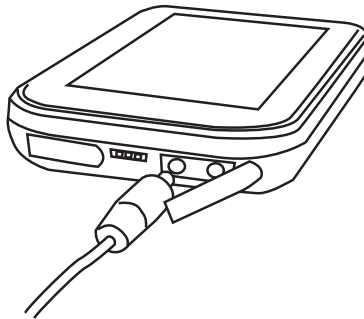

Plug the AC adapter power cord into an electrical outlet, then connect the DC plug of the adapter cable to the OT-100. It takes approximately 2–4 hours to fully charge the battery for the first time. Subsequent charges might take longer.



CAUTION

To avoid damaging OT-100 or the AC adapter, make sure all connectors are properly.

9. Press the Power button to turn on the OT-100.

Charging the OT-100 / battery in the cradle

You can charge the battery in the cradle that is more convenient. You can charge a spare battery (optional) individually or simultaneously as well.

1. Plug the AC adapter power cord into an electrical outlet, then connect the DC plug of the adapter cable to the power jack at the back of cradle.
2. Align the cradle connector on the OT-100 with the pins in the OT-100 slot of the cradle, then install the OT-100 in the direction of the arrow.
3. Align the battery connectors on the battery with the pins in the second battery slot of the cradle, then install the battery in the direction of the arrow.

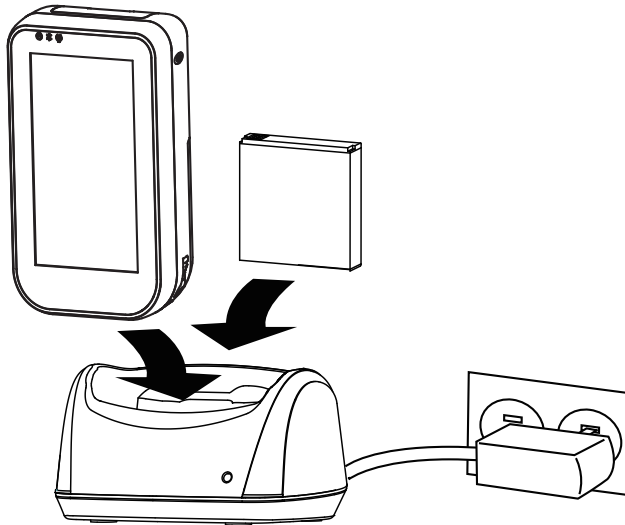

4. After charging, unplug the cradle and remove the OT-100 / battery from it.



IMPORTANT

To protect and prolong the life of the battery, do not charge it for 24 hours or longer at a time.



NOTE

The LED indicator on the cradle will light while the OT-100 / battery is charging. It will off when the charge is complete.



NOTE

Charge the battery within a temperature range 0°C to 45°C.

Battery Handling Precaution

- **Do not attempt to disassemble or reconstruct the packs.** The battery has safety function and protection circuit avoid the danger. If they get serious damage. It will cause the generating heat, smoke, rupture, or flame .
- **Do not short circuit battery.** Neither short connect the positive terminal and negative terminal with metals nor catty or store the battery with metal objects .if the battery is short circuited, excessive large current will flow and then the generating heat , rupture or flame will occur . and also ,it will cause generating heat at metals. Please cover the plug with waterproof cap when not use the battery.
- **Do not incinerate or heat the battery.** They will cause the melting of insulator, damage of gas release vent , lost of safety function ,or ignition on electrolyte. Above mentioned matters will cause the generating heating , smoke, rupture or flame.
- **Do not use nearby heated place.** Do not use or leave battery nearby fire, stove or heated place (more than 80°C). In case that separator made of polymer is melted by high temperature, the internal short circuit occurs in individual cells and then it causes the generating heat ,smoke, rupture or flame.
- **Do not immerse the battery in water or seawater or get it wet.** In case that depredator made of polymer is melted high temperature , the internal short circuit occurs in individual cells and then it cause the generating heat ,smoke, rupture or flame.
- **Do not charge battery nearby the fire or under the blazing sun.** if the protection circuit does not avoid the danger works under high temperature or it is broken, the battery will be charged at abnormal current (or voltage)and abnormal chemical reaction will occur. It causes the generating heat , smoke, rupture or flame.
- **Do use the special charge and observe charging requirement.** If the battery is charge in unusual condition ,it will cause lost of safety function or the abnormal chemical reaction and heat, smoke ,rupture or flame will occur.
- **Do not try to damage the battery.** Do not drive a nail into the battery strike it by hammer, or tread it. The impact will cause leakage or generate heat, smoke, rupture or flame.
- **Do not use the direct soldering on battery.** As the insulator is melted by heat or the gas release vent is broken , it cause the generating heat, smoke, rupture or flame.
- **Do not connect battery to the plug socket or car-cigarette-plug.** Added high voltage to the battery ,the excessive current will flow in it and then it will cause the generating heat, smoke, rupture or flame.
- **Do not use battery for other equipment.** If the battery is used for other equipment, it will deteriorate its performance and cycle-life. At worst, abnormal current will flow or battery may generate heat ,smoke, rupture or flame.
- **Do not touch a leaked battery directly.** In case the leaked electrolyte gets into eyes, wash them with fresh water as soon as possible without rubbing eyes. And then, see a doctor immediately.
- **Do not continue to charge over specified time.** If the battery is not finished charging over regulated time ,let it stop charging .There is possibility that the battery might generate heat ,smoke ,deformation or flame.
- **Do not get it into a microwave or high pressure container.** It causes the generating heat ,smoke ,deformation or flame because of a sudden heat or damage of sealing condition of battery
- **Do not put leaked battery near fire.** If the liquid leaks from the battery (or the battery give out bad smell), let the battery leave flammable objects immediately .Otherwise ,the electrolyte leaked from battery will catch fire and other danger.
- **Do not use an abnormal battery.** In case the battery has bad smell, changes color, deforms , or causes something wrong in using ,take it out from equipment or charger and do not use it. If an abnormal battery is used , it will generate heat ,smoke, rupture or flame.

Using SD cards

Use optional SD cards for:

- Expanding the memory of the OT-100
- Adding functionality

You can use SD cards for additional data storage. The micro SD and mini SD cards can also be used with an SD adapter in the OT-100.



NOTE

SD cards must be purchased separately and are not included with the OT-100.

Install a SD card

Refer to the following to install a SD card.

1. Press the power button to turn off the OT-100.
2. Remove the plastic bit.

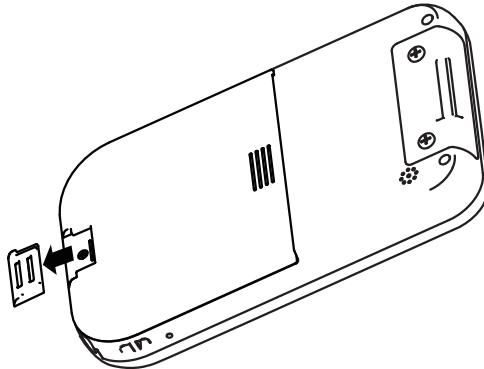

Slide the plastic bit down and away from the battery cover.

3. Remove the screw if the battery cover is locked.

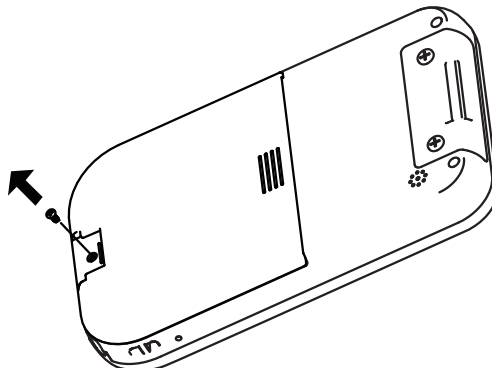

4. Remove the battery cover.

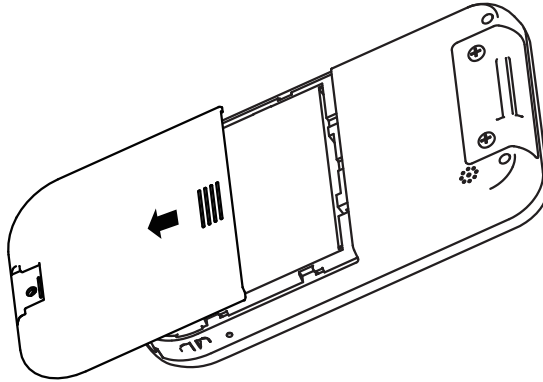

Slide the cover down and away from the OT-100.

5. Remove the battery.

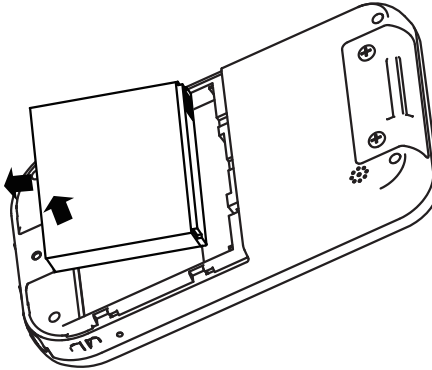

6. Insert the SD card into the slot with the label facing out.

- Push the SC card until it clicks into place.
- To remove the SD card, press it to eject it from the slot.

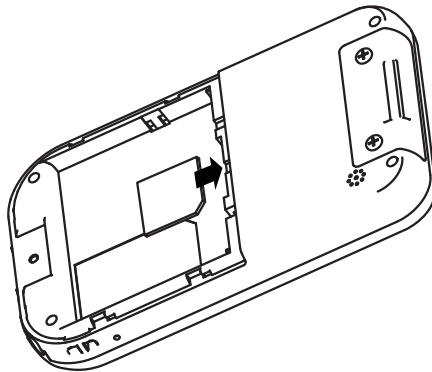

Viewing content of a SD card

Refer to view content of a SD card.

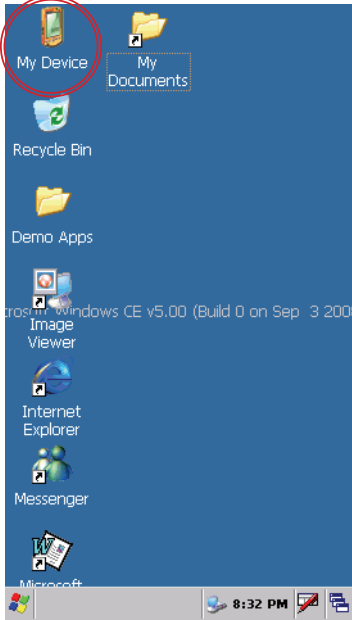
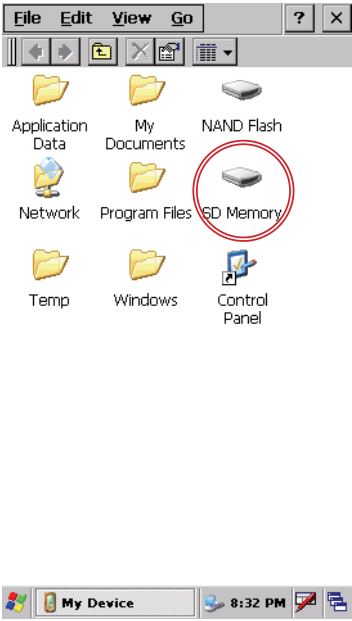
<p>1. Double tap My Device on desktop.</p>	 <p>A screenshot of a desktop environment with a blue background. The desktop contains several icons: 'My Device' (a mobile phone icon, circled in red), 'My Documents' (a folder icon), 'Recycle Bin' (a trash can icon), 'Demo Apps' (a folder icon), 'Image Viewer' (an application icon), 'Internet Explorer' (a globe icon), 'Messenger' (a people icon), and 'Microsoft' (a logo icon). The taskbar at the bottom shows the time as 8:32 PM.</p>
<p>2. Double tap SD Memory to see a list of files and folders.</p> <ul style="list-style-type: none">• If the OT-100 does not recognize your SD card, make sure you have firmly pushed the SD card into the slot.	 <p>A screenshot of a file explorer window titled 'File Edit View Go'. The window displays a list of folders and drives: 'Application Data', 'My Documents', 'NAND Flash', 'Network', 'Program Files', 'SD Memory' (circled in red), 'Temp', 'Windows', and 'Control Panel'. The taskbar at the bottom shows the time as 8:32 PM and the active window is labeled 'My Device'.</p>

CHAPTER 2

LEARNING THE BASICS

This chapter describes how to use basic features of the OT-100, to powering it on. The following topics are described.

- Entering text on page 17
- Shortcut menus on page 17
- Performing a reset on page 17
- Opening and closing programs on page 18
- Program switch on page 18
- Windows CE help on page 18
- Adjusting the volume on page 18
- Changing the device name on page 20
- Recalibrating the screen on page 23
- Setting the date and time on page 24
- Install and remove programs on page 32
- Upgrading OS Image or Bootloader on page 34

Entering text

You can use the on-screen keyboard. To use the on-screen, tap the  on the taskbar.

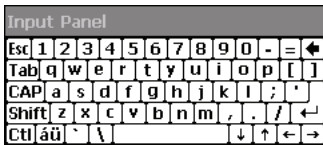

Tap keys on keyboard to enter text

Shortcut menus

A shortcut menu is displayed when you tap and hold an item. This menu displays the most common commands for the specific item. For example, you can delete an appointment by using commands on a shortcut menu. When the shortcut menu displays, tap the action you want to perform. To close a shortcut menu without performing an action, tap anywhere outside the menu.



Performing a reset

A reset stops all running applications, but does not erase any programs or saved data.



NOTE *Be sure to close all running applications before performing a reset.*

To perform a reset:

1. Locate the recessed Reset button on the device.
2. Use the stylus to lightly press the Reset button.

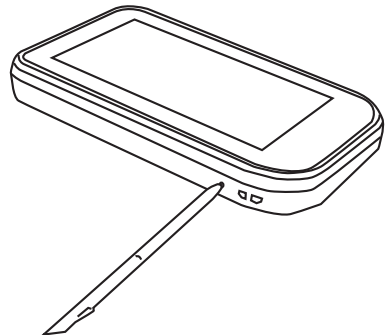

Opening and closing programs

You do not need to exit a program to open another or to conserve memory. The system manages memory automatically.

To open a program, tap , and then select the required program from the list. If you do not see the program you want to launch, tap  → Programs.

In most cases, selecting  or **OK** will close an application.

Program switch

You can use the program switch to quickly select the running program. To use the program switch, tap the  on the taskbar, then tap the program you want on the list.



Windows CE help

Read the help information when you want to learn more about the program by tap the  on the left top of the program window. The help window will pop-up.

Adjusting the volume

1. Tap  → Settings → Control Panel.

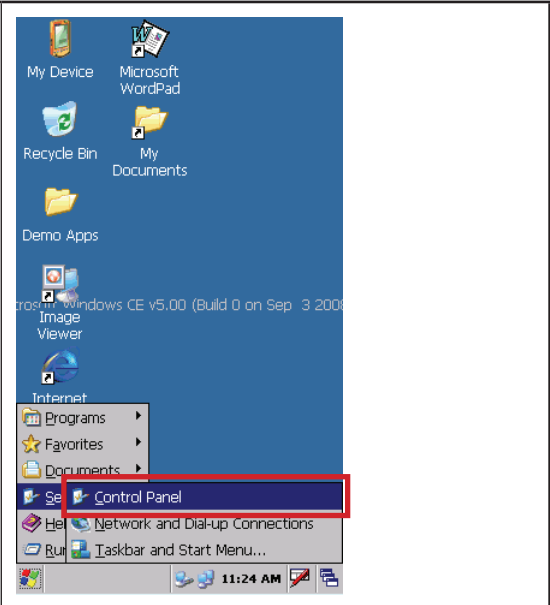

The screenshot shows the Windows CE desktop with a blue background. The Start menu is open, displaying a list of options: Programs, Favorites, Documents, Control Panel (highlighted with a red box), Network and Dial-up Connections, and Taskbar and Start Menu... The taskbar at the bottom shows the time as 11:24 AM.

2. Double tap the Volume & Sounds icon.

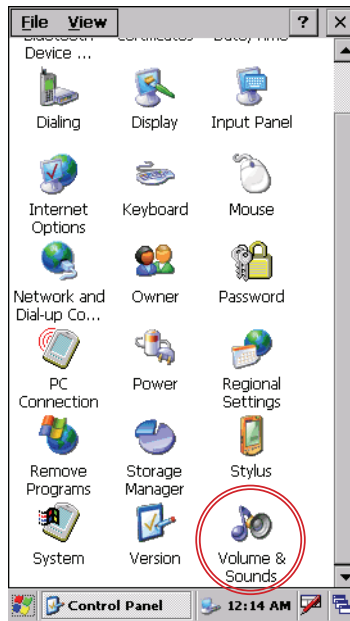

3. Select the Volume tab.
4. Move the system volume slider on the screen to the required volume level.
5. Tap the OK button.

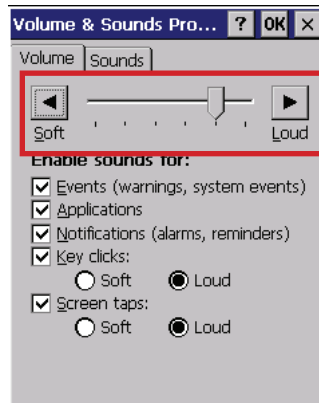

Changing the device name

The device name is used to identify the OT-100 in the following situations:

- Connecting with a computer
- Connecting to a network

Refer to the following to change the device name.

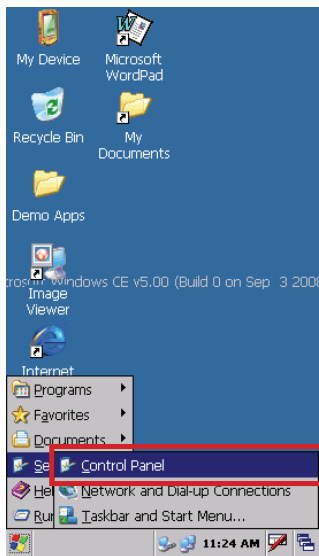
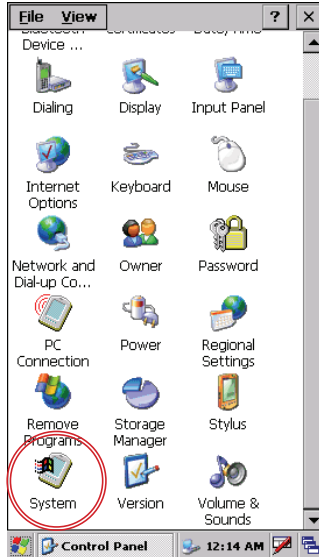
<p>1. Tap  → Settings → Control Panel.</p>	 <p>A screenshot of the Windows CE desktop environment. The desktop background is blue and contains several icons: My Device, Microsoft WordPad, Recycle Bin, My Documents, Demo Apps, Image Viewer, and Internet. The Start menu is open, showing options like Programs, Favorites, Documents, Control Panel (highlighted with a red box), Network and Dial-up Connections, and Taskbar and Start Menu... The taskbar at the bottom shows the time as 11:24 AM.</p>
<p>2. Double tap the System icon.</p>	 <p>A screenshot of the Control Panel window. The window title is 'File View' and it contains a grid of icons representing various system settings: Dialing, Display, Input Panel, Internet Options, Keyboard, Mouse, Network and Dial-up Co..., Owner, Password, PC Connection, Power, Regional Settings, Remove Programs, Storage Manager, Stylus, System (circled in red), Version, and Volume & Sounds. The taskbar at the bottom shows the time as 12:14 AM.</p>

3. Select the Device Name tab.
4. Enter a name. The device name must begin with a letter, consist of letters from A to Z and numbers from 0 to 9, and should not contain spaces.
5. Tap the OK button.

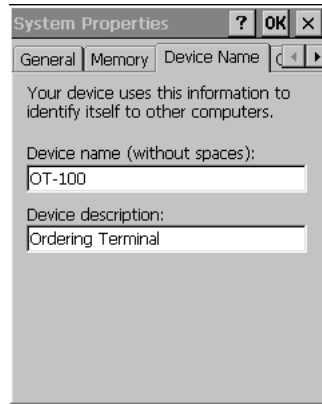

Entering owner information

Enter your personal information, such as your name and address, so that the OT-100 can be returned to you if it is lost. Refer to the following to enter the information.

6. Tap  → Settings → Control Panel.

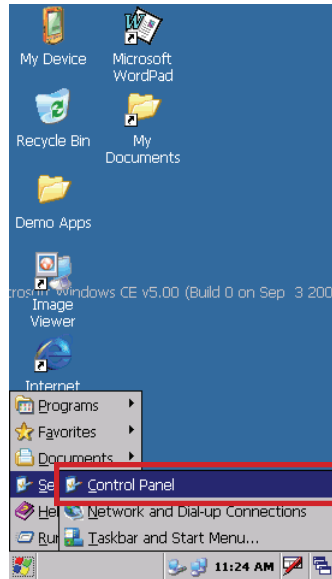

7. Double tap the Owner icon.

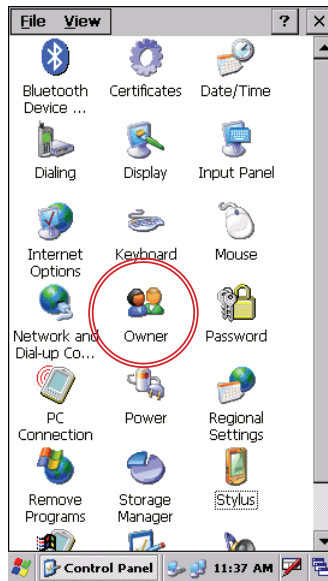

8. On the Identification tab, enter your personal information.

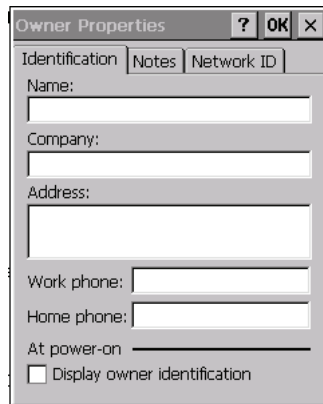

Recalibrating the screen

If your stylus seems to be out of sync with the screen, then recalibrate the screen using your stylus.

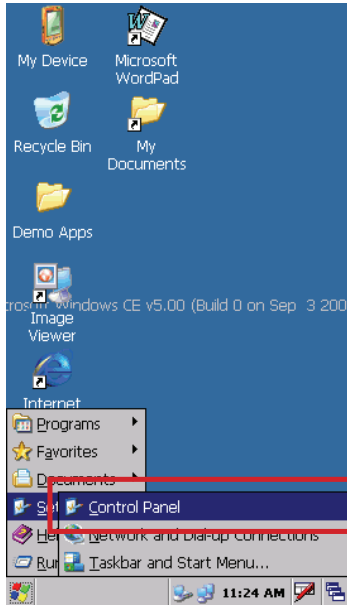
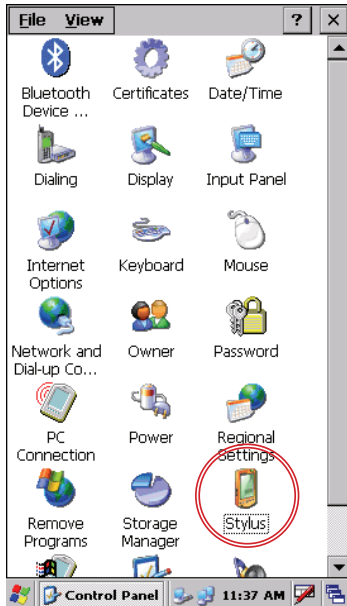
<p>9. Tap  → Settings → Control Panel.</p>	 <p>The screenshot shows a Windows CE desktop with a blue background. The Start menu is open, and the 'Control Panel' option is highlighted with a red rectangle. The desktop contains icons for 'My Device', 'Microsoft WordPad', 'Recycle Bin', 'My Documents', 'Demo Apps', 'Image Viewer', 'Internet', 'Programs', 'Favorites', 'Documents', 'Network and Dial-up Connections', and 'Taskbar and Start Menu...'. The taskbar at the bottom shows the time as 11:24 AM.</p>
<p>10. Double tap the Stylus icon.</p>	 <p>The screenshot shows the 'Control Panel' window with a grid of settings icons. The 'Stylus' icon, which depicts a stylus, is circled in red. Other icons include Bluetooth Device, Certificates, Date/Time, Dialing, Display, Input Panel, Internet Options, Keyboard, Mouse, Network and Dial-up Co..., Owner, Password, PC Connection, Power, Regional Settings, Remove Programs, and Storage Manager. The taskbar at the bottom shows the time as 11:37 AM.</p>

11. Select the Calibration tab then tap the Recalibrate button.
12. Follow the displayed instructions to recalibrate.



Setting the date and time

Refer to the following to install a SD card.

13. Tap  → Settings → Control Panel.

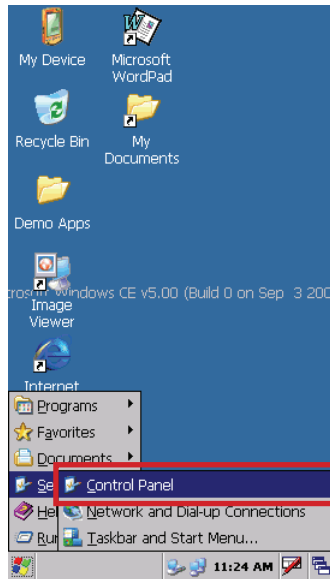

14. Double tap the Date/Time icon.

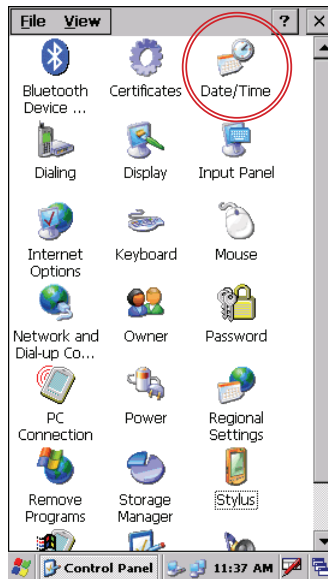

15. Change the date or time and select the correct time zone.

16. Tap the Apply button.

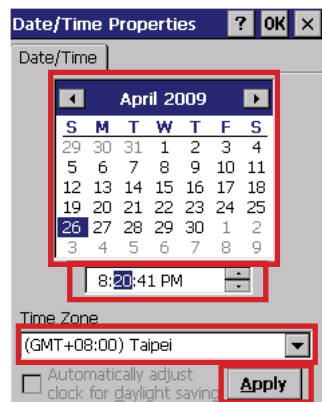

Turning on / off the WLAN

Refer to the following to turn the WLAN on / off.

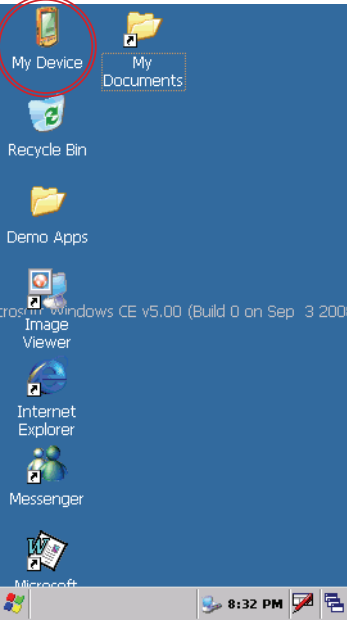
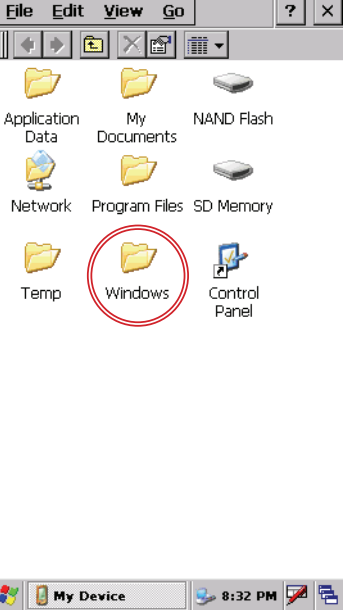
<p>1. Double tap My Device on desktop.</p>	 <p>A screenshot of the Windows CE desktop environment. The desktop background is blue. Several icons are visible: 'My Device' (a mobile phone icon), 'My Documents' (a folder icon), 'Recycle Bin' (a trash can icon), 'Demo Apps' (a folder icon), 'Image Viewer' (an image icon), 'Internet Explorer' (a globe icon), 'Messenger' (a person icon), and 'Microsoft' (a logo icon). The 'My Device' icon is circled in red. The taskbar at the bottom shows the time as 8:32 PM.</p>
<p>2. Double tap the Windows folder.</p>	 <p>A screenshot of the Windows folder view. The window title bar shows 'File Edit View Go'. The folder view displays several sub-folders: 'Application Data', 'My Documents', 'NAND Flash', 'Network', 'Program Files', 'SD Memory', 'Temp', 'Windows', and 'Control Panel'. The 'Windows' folder icon is circled in red. The taskbar at the bottom shows the time as 8:32 PM and the current location as 'My Device'.</p>

3. Double tap the SetWi-FiBind / SetWi-FiUnBind icon to turn on / off the WLAN.

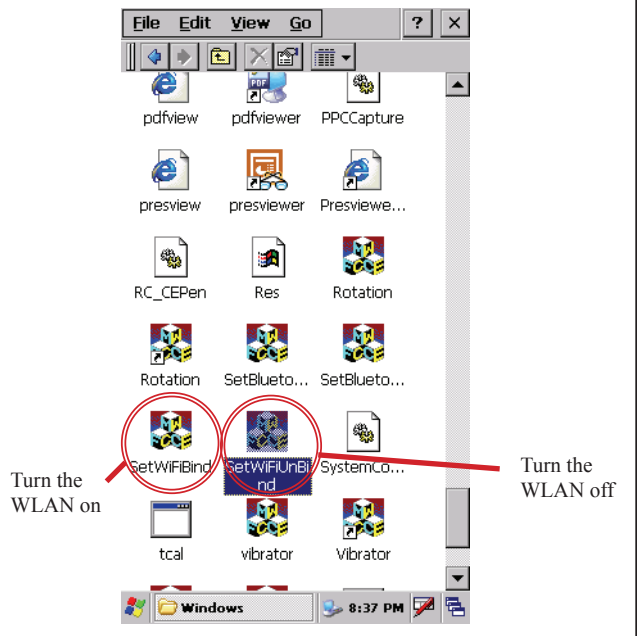

Turning on / off the Bluetooth

Refer to the following to turn Bluetooth on / off.

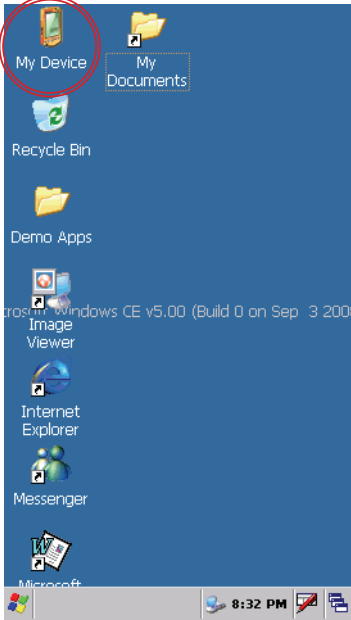
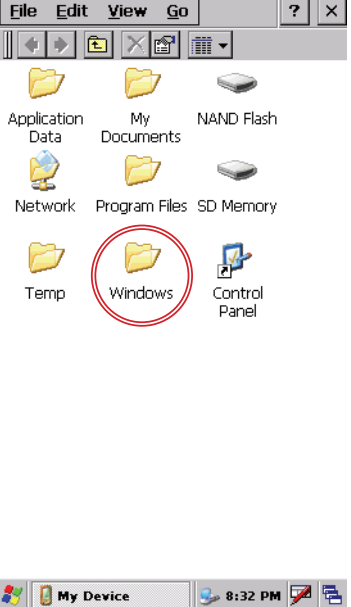
<p>1. Double tap My Device on desktop.</p>	 <p>A screenshot of the Windows CE desktop environment. The desktop background is blue. Several icons are visible: 'My Device' (a mobile phone icon), 'My Documents' (a folder icon), 'Recycle Bin', 'Demo Apps' (a folder icon), 'Image Viewer', 'Internet Explorer', 'Messenger', and 'Microsoft' (a folder icon). The 'My Device' icon is circled in red. The taskbar at the bottom shows the time as 8:32 PM.</p>
<p>2. Double tap the Windows folder.</p>	 <p>A screenshot of the Windows folder contents. The window title bar reads 'File Edit View Go'. The folder contains several sub-folders and drives: 'Application Data', 'My Documents', 'NAND Flash', 'Network', 'Program Files', 'SD Memory', 'Temp', 'Windows', and 'Control Panel'. The 'Windows' folder icon is circled in red. The taskbar at the bottom shows the time as 8:32 PM and the active window is titled 'My Device'.</p>

3. Double tap the SetWi-FiBind / SetWi-FiUnBind icon to turn on / off the WLAN.

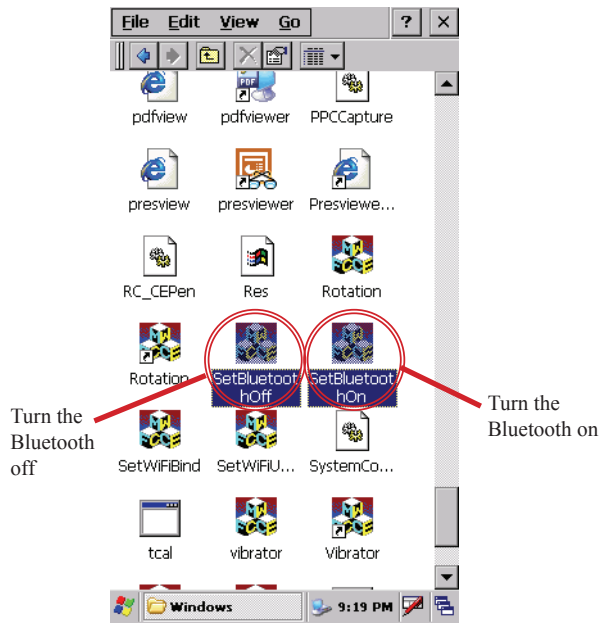

Setting the screen rotation

Refer to the following to set the screen rotation.

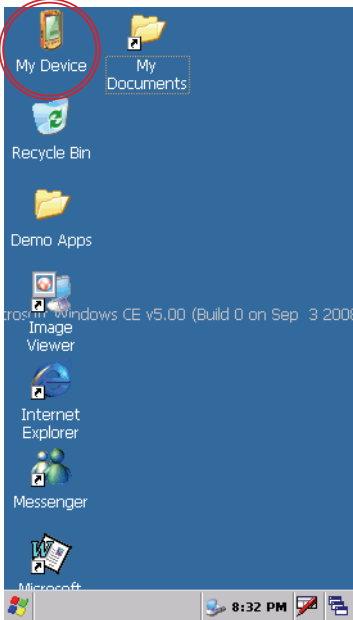
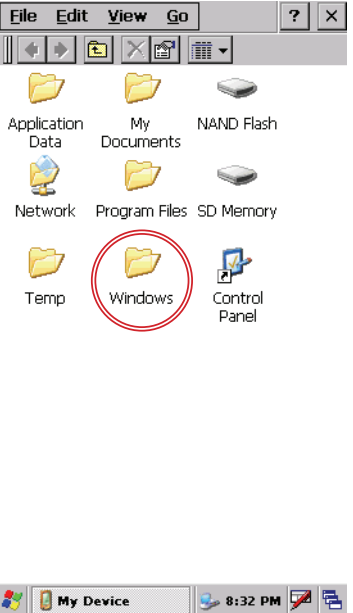
<p>1. Double tap My Device on desktop.</p>	 <p>A screenshot of a Windows CE desktop environment. The desktop background is blue. Several icons are visible: 'My Device' (a mobile phone icon), 'My Documents' (a folder icon), 'Recycle Bin', 'Demo Apps' (a folder icon), 'Image Viewer', 'Internet Explorer', 'Messenger', and a 'Microsoft' logo. The taskbar at the bottom shows the time as 8:32 PM. A red circle highlights the 'My Device' icon.</p>
<p>2. Double tap the Windows folder.</p>	 <p>A screenshot of a Windows Explorer window. The window title bar shows 'File Edit View Go'. The main area displays a tree view of folders: 'Application Data', 'My Documents', 'NAND Flash', 'Network', 'Program Files', 'SD Memory', 'Temp', 'Windows', and 'Control Panel'. The 'Windows' folder is circled in red. The taskbar at the bottom shows the time as 8:32 PM and the text 'My Device'.</p>

3. Double tap the Rotation icon.

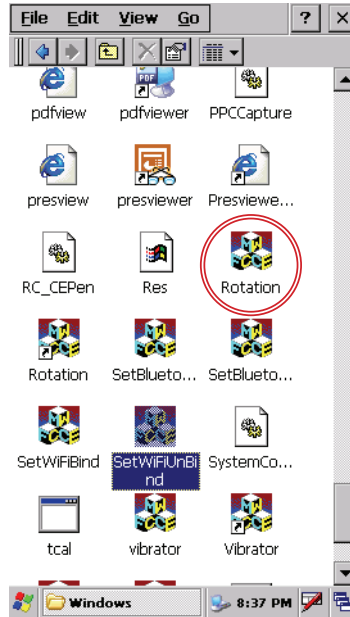

4. Select the degree button, then the device will rotate the screen, also you can select the Auto Rotation Screen checkbox to make the device automatically rotate the screen by turning the device sideways.

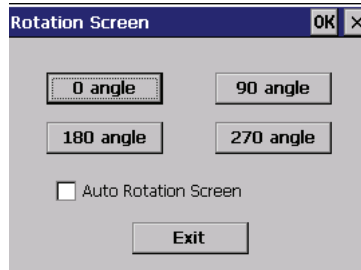

5. Tap the Exit button.

Install and remove programs

To install programs on the OT-100:

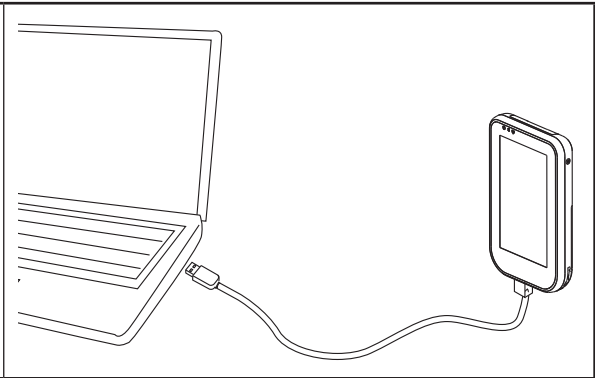
<ol style="list-style-type: none">1. Use a Mini-USB to USB cable to connect the OT-100 to the computer.2. Follow the instructions in the Installation Wizard provided with the program you want to install.3. Check the screen on the OT-100 to see if any further steps are necessary to complete the program installation.	
--	--

To remove programs from the OT-100:

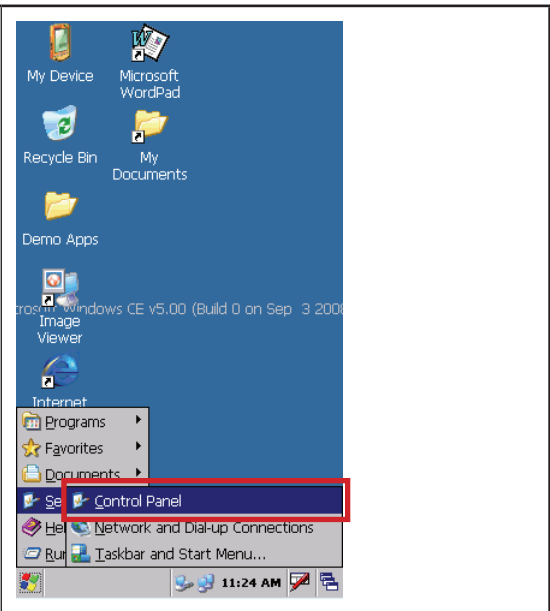
<ol style="list-style-type: none">1. Tap  → Settings → Control Panel.	
--	---

2. Double tap the Remove Programs icon.

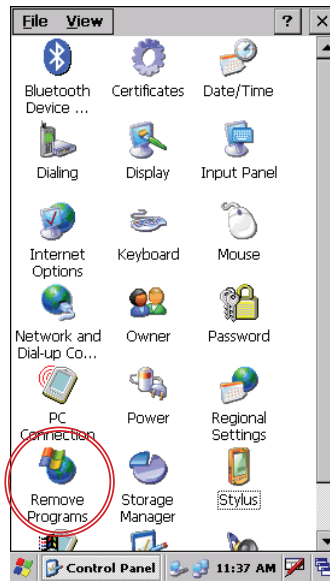

3. Select the programs you want to remove, and then tap the Remove button.



Upgrading OS Image or Bootloader

Unless you're familiar with the OS Image and Bootloader, do not do the following operation.

To upgrade OS Image or Bootloader:

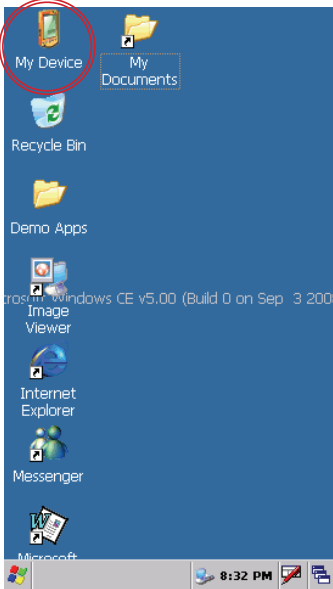
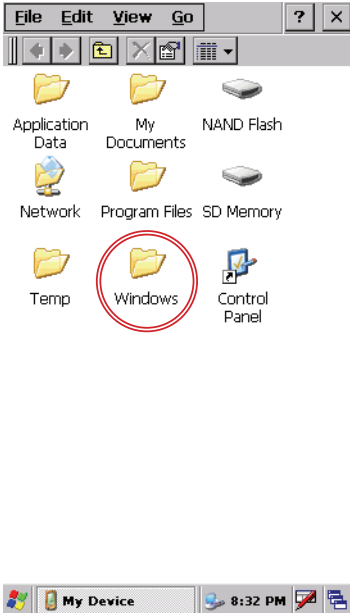
<ol style="list-style-type: none">1. Store the OS image or Bootloader files on the SD card.2. Install the SD card.3. Double tap My Device on desktop.	
<ol style="list-style-type: none">4. Double tap the Windows folder.	

5. Double tap the NandTools icon.

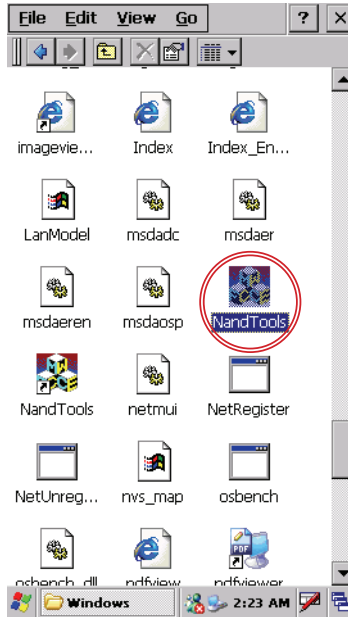

6. Tap the OS Image upgrade or Bootloader upgrade button.
7. Tap the Exit button.



CHAPTER 3 USING THE ACCESSORIES

This chapter describes how to protect the device.

- Using the leather pouch on page 37
- Attaching the stylus cord on page 38
- Attaching the hand strap on page 39
- Using the shoulder strap on page 40

Using the leather pouch

Attaching the stylus cord

Refer to the following to attach the stylus cord.

1. Thread the small loop of the stylus cord through the strap eyelet on the stylus and pull the other end of the cord through the small loop until the cord is firmly secured.

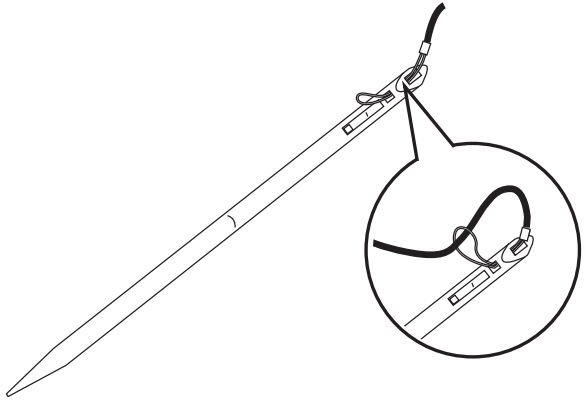

2. Thread the other small loop of the stylus cord through the top hand strap eyelet on the device and use stylus pull the cord through the small loop until the cord is firmly secured.

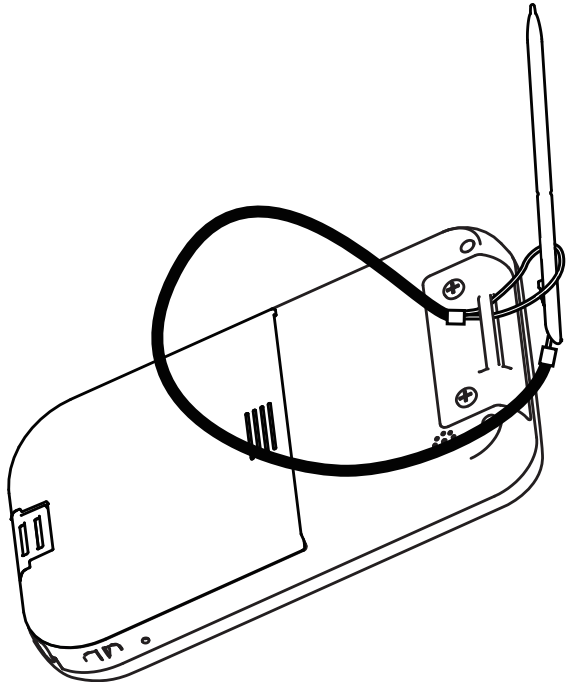

Attaching the hand strap

Refer to the following to attach the hand strap.

1. Slide the bit head up to the bottom on battery cover.

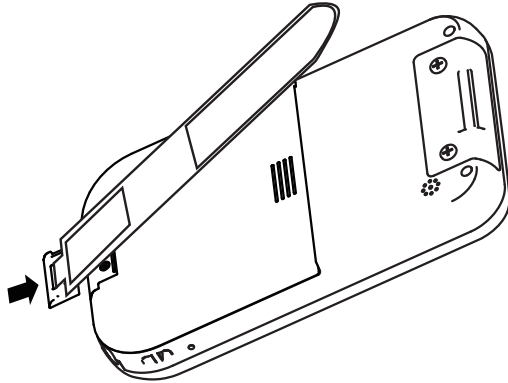

2. Thread the end of the hand strap through the top hand strap eyelet on the device then fold and stick together.

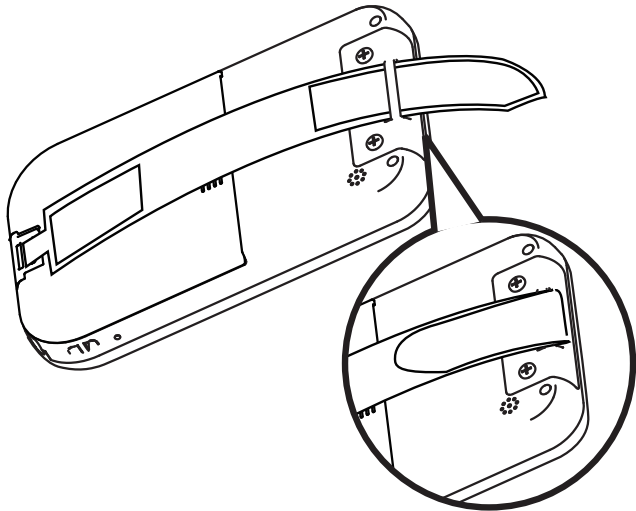

Using the shoulder strap

This appendix describes locating and solving problems that you may encounter while using the OT-100.

Troubleshooting

Often after time spent troubleshooting, the problem is traced to something as simple as a loose connection. Check the following before proceeding to the problem-specific solutions.

Tips for Troubleshooting

In each problem-specific section, try the steps in the order suggested. This may help you to solve the problem more quickly. Try to pin point the problem and thus avoid replacing non-defective parts. For example, if you replace batteries and the problem remains, put the original batteries back and go to the next step.

Keep a record of the steps you take when troubleshooting: The information may be useful when calling for technical support or for passing on to service personnel.

- Use some other electrical device to confirm that the electrical outlet is working.
- Ensure all connections are securely attached.

General Problems

Refer to the following general problems you may encounter.

PROBLEM	SOLUTION
You can not turn on the device	Is the battery charged? Is the battery properly installed?
You have trouble connecting to the Internet	Make sure you have subscribed for a data service from your service operator. Make sure you entered correct setting parameters, such as APN and IP addresses in data profile setup.
Why does the device operate slowly at times?	You should have enough free memory space on the device so that the device operates efficiently. Check the free memory space, delete or transfer old files on the device to free available memory space.
You have trouble charging the battery.	Is the battery charger correctly plugged into the battery charger socket on the device. Is the power cord of the charger damaged? Is the battery very old? If yes, replace with a new battery and try again.

Having the OT-100 Serviced

If you are unable to solve the problem, you should have the device serviced. Pack the device in the original box. (See “Unpacking the OT-100” on page 1.) Include a description of the problem and a checklist of the steps you took when trying to fix the problem. The information may be useful to the service personnel. Return the device to the place you purchased it.

Guidelines for care and maintenance

It is recommended that you follow certain guidelines to prevent possible damage to the device and to keep it in a good condition.

Using the device

- Avoid using the device in dusty and extremely high or low temperature environments.
- Do not spill water on the device or expose it to the rain.
- Avoid removing the battery without turning off the device.
- Do not apply strong force or shocks to the device.
- Keep the device and its accessories away from children.
- Do not insert metal objects into the charging/communications port of the device. This can short-circuit the battery and result in danger.
- Turn off the device or switch it to silent mode when you are asked to in public places.

Cleaning the device

- Use a soft, clean, and slightly moistened cloth to clean the device. Do not let water come into contact with the earpiece, microphone, or the metal surface.
- Do not wipe the device with any corrosive liquid or coarse objects. This can damage the outer surface of the device.

Carrying or storing the device

- Do not leave the device in extremely high or low temperature environments.
- Charge the battery unless every 3 months if it is not going to be used for a long period. We recommend you to remove the battery from the device and store the device and its battery in a cool, dark, and dry place.

Specifications

CPU	Freescale i.MX31/i.MX31L (Co-layout) CPU @ 532MHz/133MHz
RAM	Mobile DDR 128MB, NAND flash 128MB
LCD	4.3" widescreen (resolution 480*272)
WiFi	802.11b/g
Bluetooth	Class2
Audio	Line out, speaker, internal microphone, external mic jack
Storage	SD card
Connectors	Mini USB
Special features	Vibration Direction sensor
Battery	Li-ion 2200mAh
Ruggedness	IP54, 1.2 meter drop test
Accessories	Multi-charger, hand strap, leather pouch
Extension modules	MSR, IC card, RFID
OS	Windows CE 5.0
Weight	240g
Dimensions	133 * 82 * 19 mm (H x W x D)