



FCC TEST REPORT

according to

FCC Rules and Regulations Part 15 Subpart C

Applicant	: Partner Tech Corp.
Address	: 10F, No. 233-2, Pao Chiao Rd., Shin Tien, Taipei, Taiwan 231, R.O.C.
Equipment	: Handheld Terminal
Model No.	: OT-100
FCC ID	: NDPOT100
Trade Name	: Partner

Laboratory Accreditation



- The test result refers exclusively to the test presented test model / sample.,
- Without written approval of **Cerpass Technology Corp.** the test report shall not be reproduced except in full.
- The EUT is also considered as a kind of computer peripheral, because the connection to computer is necessary for typical use. It has been verified to comply with the requirements of FCC Part 15, Subpart B, Class B (DoC). The test report has been issued separately.



Contents

1. Report of Measurements and Examinations	5
1.1 List of Measurements and Examinations.....	5
2. Test Configuration of Equipment under Test	6
2.1 Feature of Equipment under Test.....	6
2.2 Test Mode & Test Software	6
2.3 Description of Test System.....	6
2.4 Connection Diagram of Test System.....	7
2.5 General Information of Test.....	8
2.6 Measurement Uncertainty	8
2.7 History of this test report	9
3. Antenna Requirements	10
3.1 Standard Applicable	10
3.2 Antenna Construction and Directional Gain.....	10
4. Test of Conducted Emission	11
4.1 Test Limit.....	11
4.2 Test Procedures.....	11
4.3 Typical Test Setup	12
4.4 Measurement equipment	12
4.5 Test Result and Data.....	13
4.6 Test Photographs	19
5. Test of Radiated Emission	20
5.1 Test Limit.....	20
5.2 Test Procedures.....	20
5.3 Typical Test Setup	21
5.4 Measurement equipment	21
5.5 Test Result and Data.....	22
5.6 Test Photographs	52
6. 20dB Bandwidth Measurement Data	53
6.1 Test Limit	53
6.2 Test Procedures	53
6.3 Test Setup Layout	53
6.4 Measurement equipment	53
6.5 Test Result and Data.....	54
7. Frequencies Separation	60
7.1 Test Limit	60
7.2 Test Procedures	60
7.3 Test Setup Layout	60
7.4 Measurement equipment	60
7.5 Test Result and Data.....	61
8. Dwell Time on each channel	67
8.1 Test Limit	67
8.2 Test Procedures	67
8.3 Test Setup Layout	67
8.4 Measurement equipment	67



8.5 Test Result and Data.....68

9. Number of Hopping Channels78

9.1 Test Limit78

9.2 Test Procedures78

9.3 Test Setup Layout78

9.4 Measurement equipment78

9.5 Test Result and Data.....78

10. Maximum Peak Output Power80

10.1 Test Limit80

10.2 Test Procedures80

10.3 Test Setup Layout80

10.4 Measurement equipment80

10.5 Test Result and Data.....81

11. Band Edges Measurement87

11.1 Test Limit87

11.2 Test Procedure :87

11.3 Test Setup Layout87

11.4 List of Measuring Equipment Used.....87

11.5 Test Result and Data.....88

11.6 Restrict band emission Measurement Data.....95

12. Restricted Bands of Operation97

12.1 Labeling Requirement.....97

Appendix A. Photographs of EUT.....A1 ~ A18



CERTIFICATE OF COMPLIANCE

according to

FCC Rules and Regulations Part 15 Subpart C

Applicant : Partner Tech Corp.
Address : 10F, No. 233-2, Pao Chiao Rd., Shin Tien, Taipei,
Taiwan 231, R.O.C.
Equipment : Handheld Terminal
Model No. : OT-100
FCC ID : NDPOT100

I **HEREBY** CERTIFY THAT :

The measurements shown in this test report were made in accordance with the procedures given in **ANSI C63.4** The equipment was **passed** the test performed according to

FCC Rules and Regulations Part 15 Subpart C (2007).

The test was carried out on Jul. 10, 2009 at **CerpPASS Technology Corp.**

Signature

Anson Chou
EMC/RF B.U. Vice General Manager



1. Report of Measurements and Examinations

1.1 List of Measurements and Examinations

FCC Rule	Description of Test	Result
15.203	. Antenna Requirement	Pass
15.207	. Conducted Emission	Pass
15.209	. Radiated Emission	Pass
15.247(a)(1)	. Channel Carrier Frequencies Separation	Pass
15.247(a)(1)	. 20dB Bandwidth Measurement	Pass
15.247(a)(1)	. Dwell Time	Pass
15.247(b)	. Number of Hopping Channels	Pass
15.247(b)	. Peak Output Power Measurement Data	Pass
15.247(d)	. Band Edges Measurement Data	Pass



2. Test Configuration of Equipment under Test

2.1 Feature of Equipment under Test

CPU	Freescale i.MX31/i.MX31L (Co-layout) CPU @ 532MHz/133MHz
RAM	Mobile DDR 128MB, NAND flash 128MB
LCD	4.3" widescreen (resolution 480*272)
WiFi	802.11b/g
Bluetooth	Class2
Audio	Line out, speaker, internal microphone, external mic jack
Storage	SD card
Connectors	Mini USB
Special features	Vibration Direction sensor
Battery	Li-ion 2200mAh
Ruggedness	IP54, 1.2 meter drop test
Accessories	Multi-charger, hand strap, leather pouch
Extension modules	MSR, IC card, RFID
OS	Windows CE 5.0
Weight	240g
Dimensions	133 * 82 * 19 mm(H x W x D)

2.2 Test Mode & Test Software

- a. During testing, the interface cables and equipment positions were varied according to ANSI C63.4
- b. The complete test system included EUT for EMI test.
- c. The EUT was executed to keep transmitting and receiving data via Bluetooth.
- d. The following test mode was performed for conduction and radiation test:
 - GFSK: CH 00: 2402MHz, CH 39: 2441MHz, CH 78: 2480MHz.
 - $\pi/4$ -DQPSK: CH 00: 2402MHz, CH 39: 2441MHz, CH 78: 2480MHz.
 - 8DPSK: CH 00: 2402MHz, CH 39: 2441MHz, CH 78: 2480MHz.

2.3 Description of Test System

The EUT was tested alone. No support devices is needed for testing.



2.4 Connection Diagram of Test System

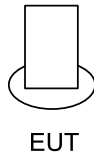

* The EUT keeps to transmit and receive data via Wireless.



2.5 General Information of Test

Test Site :	CerpPASS Technology Corp. 2F-11, No. 3, Yuan Qu St. (Nankang Software Park), Taipei, Taiwan 115, R.O.C.
Test Site Location (OATS1-SD):	No. 7-2, Moshihkeng, Fongtian Village, Shihding Township, Taipei County, Taiwan, R.O.C.
FCC Registration Number :	TW1049, 982971
IC Registration Number :	4934C-1
VCCI Registration Number :	T-338 for Telecommunication Test C-2188 for Conducted emission test R-1902 for Radiated emission test
Test Voltage:	AC 120V/ 60Hz
Test in Compliance with:	ANSI C63.4-2003 FCC Part 15 Subpart C
Frequency Range Investigated:	Conducted: from 150kHz to 30 MHz Radiation: from 30 MHz to 24620MHz
Test Distance:	The test distance of radiated emission from antenna to EUT is 3 M.

2.6 Measurement Uncertainty

Measurement Item	Measurement Frequency	Polarization	Uncertainty
Conducted Emission	9 kHz ~ 30 MHz	LINE/NEUTRAL	2.71 dB
Radiated Emission	30 MHz ~ 1GHz	Vertical	4.11 dB
		Horizontal	4.10 dB
6 dB Bandwidth	---	---	7500 Hz
Maximum Peak Output Power	---	---	1.4 dB
100kHz Bandwidth of Frequency Band Edges	---	---	2.2 dB
Power Spectral Density	---	---	2.2 dB



3. Antenna Requirements

3.1 Standard Applicable

For intentional device, according to FCC 47 CFR Section 15.203, an intentional radiator shall be designed to ensure that no antenna other than that furnished by the responsible party shall be used with the device.

And according to FCC 47 CFR Section 15.247 (b), if transmitting antennas of directional gain greater than 6dBi are used, the power shall be reduced by the amount in dB that the directional gain of the antenna exceeds 6dBi.

3.2 Antenna Construction and Directional Gain

Antenna type: PCB Antenna

Antenna Gain: 3.49 dBi



4. Test of Conducted Emission

4.1 Test Limit

Conducted Emissions were measured from 150 kHz to 30 MHz with a bandwidth of 9 KHz on the 120 VAC power and return leads of the EUT according to the methods defined in ANSI C63.4-2003 Section 3.1. The EUT was placed on a nonmetallic stand in a shielded room 0.8 meters above the ground plane as shown in section 2.2. The interface cables and equipment positioning were varied within limits of reasonable applications to determine the position produced maximum conducted emissions.

Frequency (MHz)	Quasi Peak (dB μ V)	Average (dB μ V)
0.15 – 0.5	66-56*	56-46*
0.5 – 5.0	56	46
5.0 – 30.0	60	50

*Decreases with the logarithm of the frequency.

4.2 Test Procedures

- a. The EUT was placed 0.4 meter from the conducting wall of the shielding room was kept at least 80 centimeters from any other grounded conducting surface.
- b. Connect EUT to the power mains through a line impedance stabilization network (LISN).
- c. All the support units are connecting to the other LISN.
- d. The LISN provides 50 ohm coupling impedance for the measuring instrument.
- e. The FCC states that a 50 ohm, 50 micro-Henry LISN should be used.
- f. Both sides of AC line were checked for maximum conducted interference.
- g. The frequency range from 150 kHz to 30 MHz was searched.
- h. Set the test-receiver system to Peak Detect Function and Specified Bandwidth with Maximum Hold Mode.



4.3 Typical Test Setup

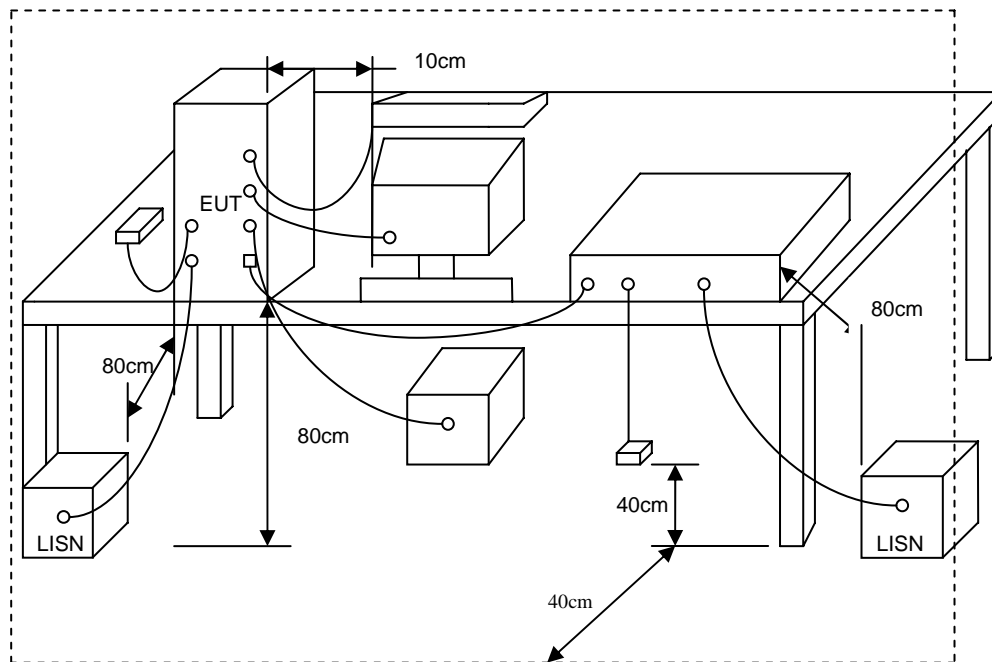

4.4 Measurement equipment

Instrument/Ancillary	Manufacturer	Model No.	Serial No.	Calibration Date	Valid Date.
EMI Receiver	R&S	ESCI	100443	2008/09/27	2009/09/26
LISN	NSLK 8127	Schwarzbeck	8127-516	2009/05/15	2010/05/14
LISN	ROLF HEINE	NNB-2/16Z	03/10058	2009/04/18	2010/04/17



4.5 Test Result and Data

Power	: AC 120V	Pol/Phase	: LINE
Test Mode	: GFSK CH0	Temperature	: 25 °C
Memo	:	Humidity	: 56 %

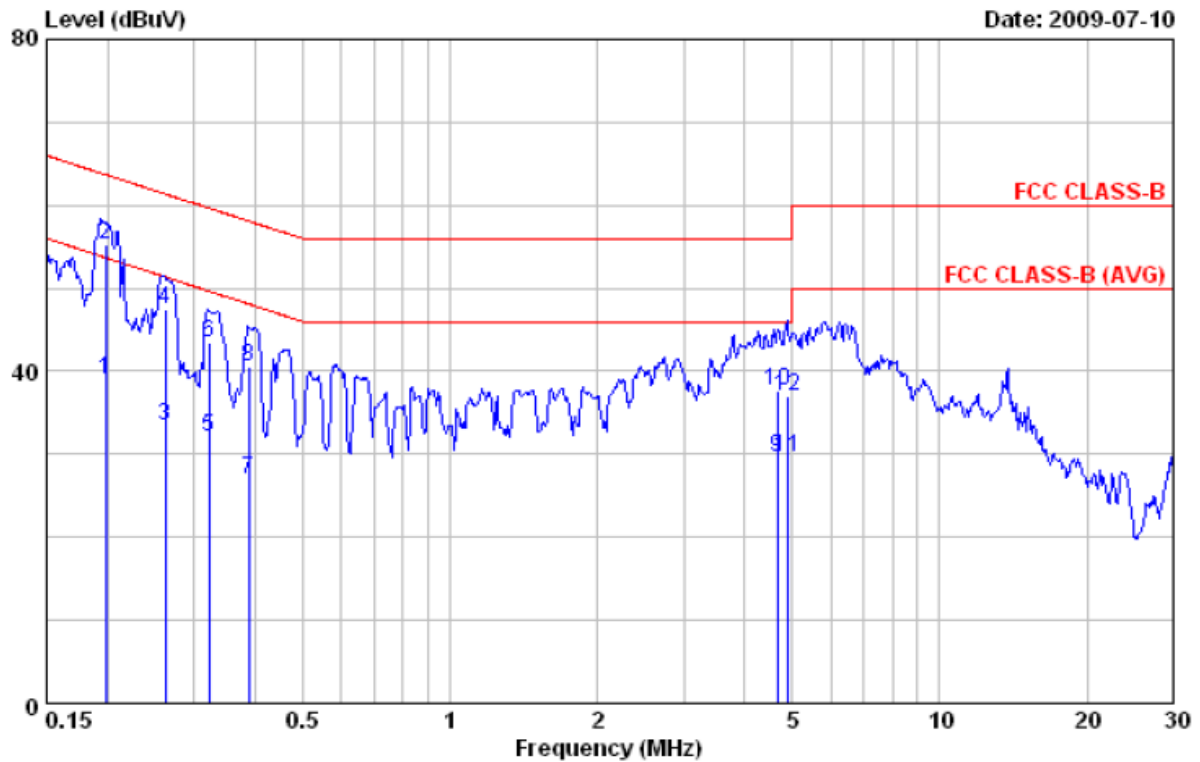

Item	Freq	Read Value	Factor	Result	Limit	Margin	Remark
	MHz	dBuV/m	dB	dBuV/m	dBuV/m	dB	
1	0.20	38.93	0.11	39.04	53.68	-14.64	Average
2	0.20	55.17	0.11	55.28	63.68	-8.40	QP
3	0.26	33.38	0.11	33.49	51.35	-17.86	Average
4	0.26	47.24	0.11	47.35	61.35	-14.00	QP
5	0.32	31.90	0.12	32.02	49.64	-17.62	Average
6	0.32	43.44	0.12	43.56	59.64	-16.08	QP
7	0.39	26.90	0.11	27.01	48.12	-21.11	Average
8	0.39	40.55	0.11	40.66	58.12	-17.46	QP
9	4.67	29.42	0.33	29.75	46.00	-16.25	Average
10	4.67	37.35	0.33	37.68	56.00	-18.32	QP
11	4.87	29.22	0.34	29.56	46.00	-16.44	Average
12	4.87	36.73	0.34	37.07	56.00	-18.93	QP

Notes:

1. Result = Read Value + Factor
2. Factor = Antenna Factor + Cable Loss - Amplifier
3. According to technical experiences, all spurious emission of GFSK mode at channel 0,39,78 are almost the same below 1GHz, so that the channel 0 was chosen as representative in final test.
4. The data is worst case.



Power	: AC 120V	Pol/Phase	: NEUTRAL
Test Mode	: GFSK CH0	Temperature	: 25 °C
Memo	:	Humidity	: 56 %

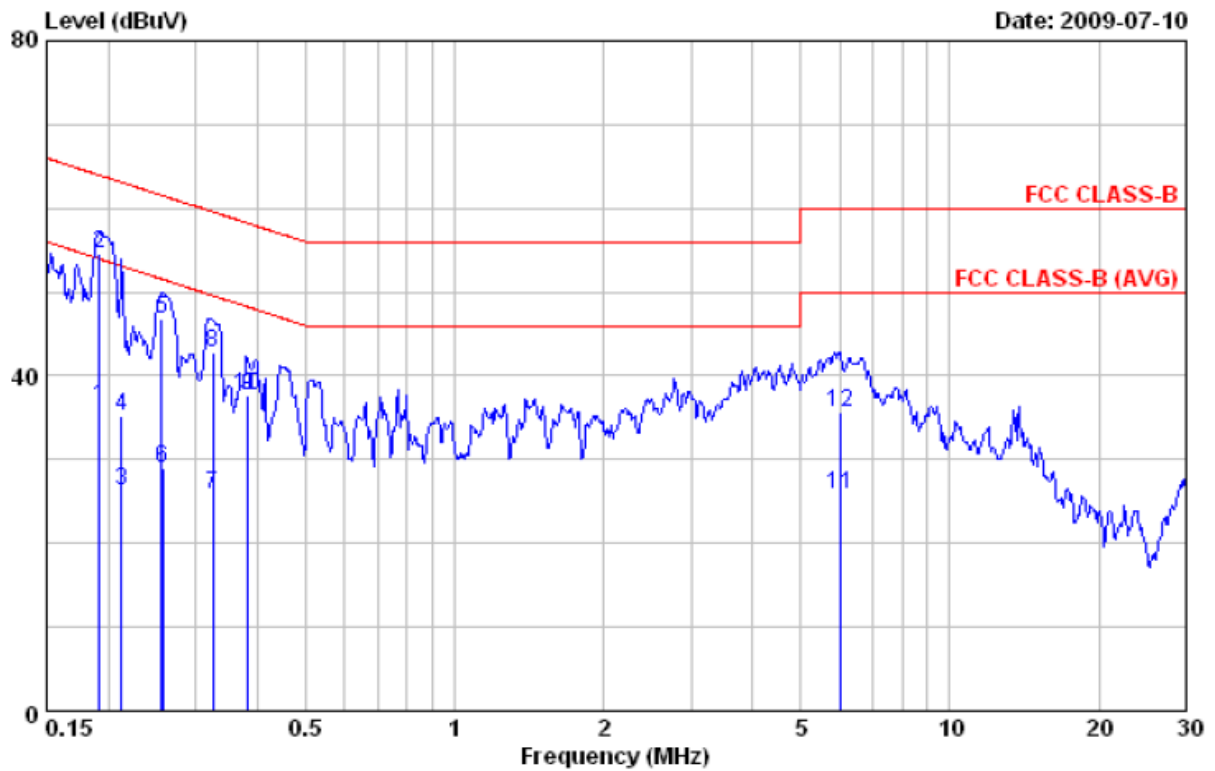

Item	Freq	Read Value	Factor	Result	Limit	Margin	Remark
	MHz	dBuV/m	dB	dBuV/m	dBuV/m	dB	
1	0.19	36.18	0.14	36.32	53.96	-17.64	Average
2	0.19	54.46	0.14	54.60	63.96	-9.36	QP
3	0.21	26.26	0.13	26.39	53.10	-26.71	Average
4	0.21	35.17	0.13	35.30	63.10	-27.80	QP
5	0.26	46.65	0.13	46.78	61.56	-14.78	QP
6	0.26	28.94	0.13	29.07	51.51	-22.44	Average
7	0.32	25.65	0.14	25.79	49.59	-23.80	Average
8	0.32	42.55	0.14	42.69	59.59	-16.90	QP
9	0.38	37.50	0.14	37.64	58.20	-20.56	QP
10	0.38	37.49	0.14	37.63	58.20	-20.57	QP
11	6.01	25.55	0.35	25.90	50.00	-24.10	Average
12	6.01	35.30	0.35	35.65	60.00	-24.35	QP

Notes:

1. Result = Read Value + Factor
2. Factor = Antenna Factor + Cable Loss - Amplifier
3. According to technical experiences, all spurious emission of GFSK mode at channel 0,39,78 are almost the same below 1GHz, so that the channel 0 was chosen as representative in final test.
4. The data is worst case.



Power	: AC 120V	Pol/Phase	: LINE
Test Mode	: $\pi/4$ -DQPSK CH0	Temperature	: 25 °C
Memo	:	Humidity	: 56 %

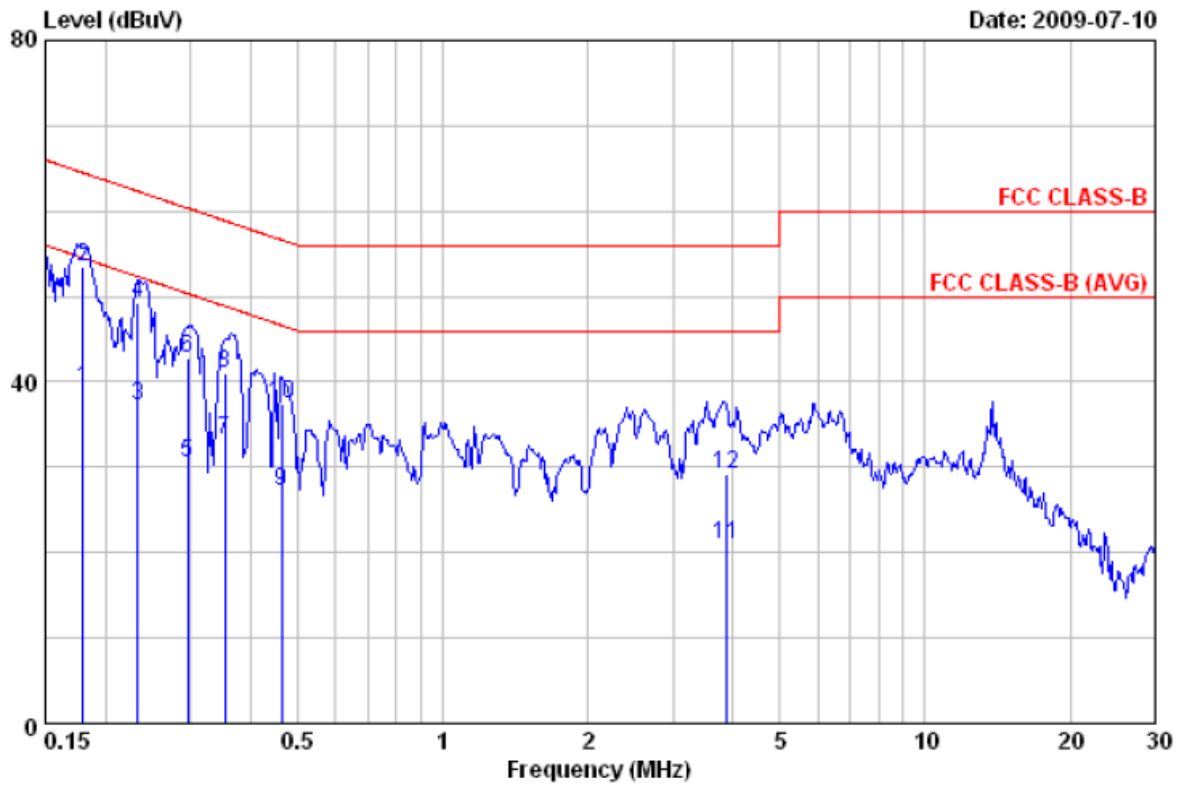

Item	Freq	Read Value	Factor	Result	Limit	Margin	Remark
	MHz	dBuV/m	dB	dBuV/m	dBuV/m	dB	
1	0.18	39.13	0.11	39.24	54.50	-15.26	Average
2	0.18	53.38	0.11	53.49	64.50	-11.01	QP
3	0.23	37.03	0.11	37.14	52.35	-15.21	Average
4	0.23	49.22	0.11	49.33	62.35	-13.02	QP
5	0.30	30.34	0.12	30.46	50.34	-19.88	Average
6	0.30	42.59	0.12	42.71	60.34	-17.63	QP
7	0.35	33.05	0.11	33.16	48.86	-15.70	Average
8	0.35	40.99	0.11	41.10	58.86	-17.76	QP
9	0.46	26.97	0.11	27.08	46.63	-19.55	Average
10	0.46	37.26	0.11	37.37	56.63	-19.26	QP
11	3.87	20.68	0.32	21.00	46.00	-25.00	Average
12	3.87	28.83	0.32	29.15	56.00	-26.85	QP

Notes:

1. Result = Read Value + Factor
2. Factor = Antenna Factor + Cable Loss - Amplifier
3. According to technical experiences, all spurious emission of $\pi/4$ -DQPSK mode at channel 0,39,78 are almost the same below 1GHz, so that the channel 0 was chosen as representative in final test.
4. The data is worst case.



Power	: AC 120V	Pol/Phase	: NEUTRAL
Test Mode	: $\pi/4$ -DQPSK CH0	Temperature	: 25 °C
Memo	:	Humidity	: 56 %

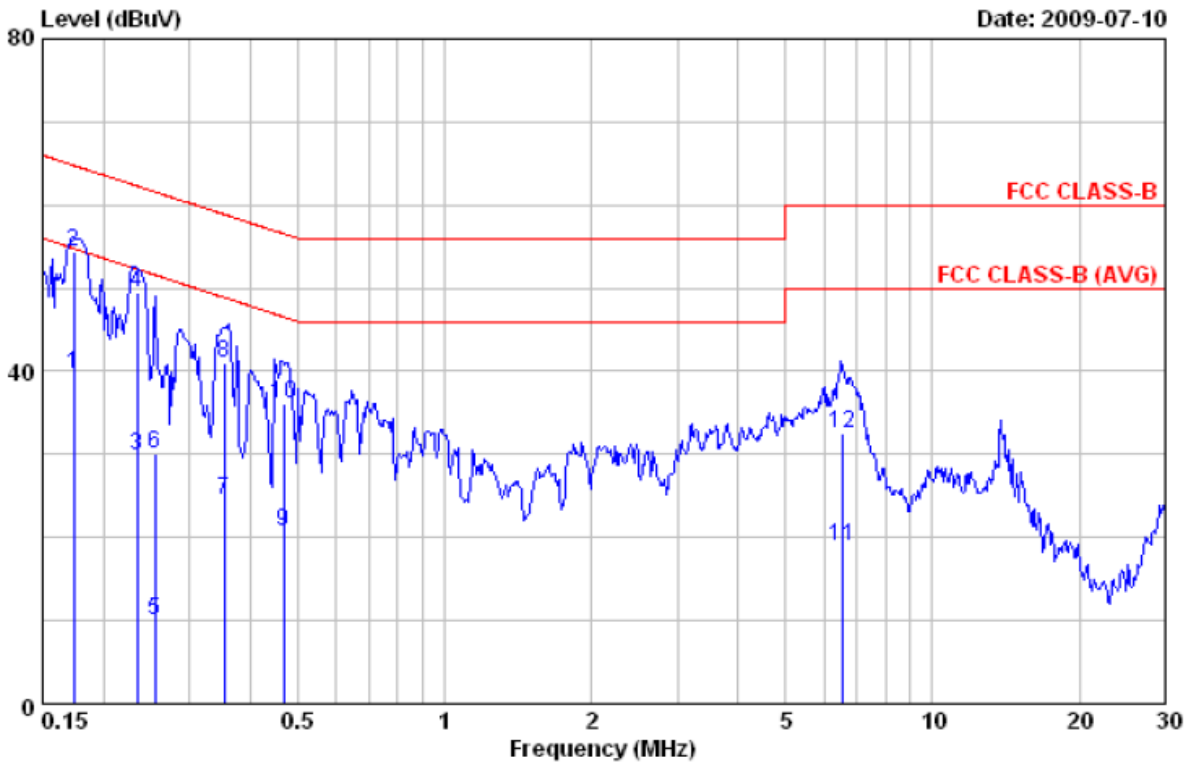

Item	Freq	Read Value	Factor	Result	Limit	Margin	Remark
	MHz	dBuV/m	dB	dBuV/m	dBuV/m	dB	
1	0.17	39.60	0.14	39.74	54.79	-15.05	Average
2	0.17	54.18	0.14	54.32	64.79	-10.47	QP
3	0.23	29.66	0.13	29.79	52.28	-22.49	Average
4	0.23	49.38	0.13	49.51	62.28	-12.77	QP
5	0.25	9.82	0.13	9.95	51.60	-41.65	Average
6	0.25	30.01	0.13	30.14	61.60	-31.46	QP
7	0.35	24.37	0.14	24.51	48.87	-24.36	Average
8	0.35	40.84	0.14	40.98	58.87	-17.89	QP
9	0.47	20.52	0.14	20.66	46.57	-25.91	Average
10	0.47	36.04	0.14	36.18	56.57	-20.39	QP
11	6.53	18.51	0.37	18.88	50.00	-31.12	Average
12	6.53	32.12	0.37	32.49	60.00	-27.51	QP

Notes:

1. Result = Read Value + Factor
2. Factor = Antenna Factor + Cable Loss - Amplifier
3. According to technical experiences, all spurious emission of $\pi/4$ -DQPSK mode at channel 0,39,78 are almost the same below 1GHz, so that the channel 0 was chosen as representative in final test.
4. The data is worst case.



Power	: AC 120V	Pol/Phase	: LINE
Test Mode	: 8DPSK CH0	Temperature	: 25 °C
Memo	:	Humidity	: 56 %

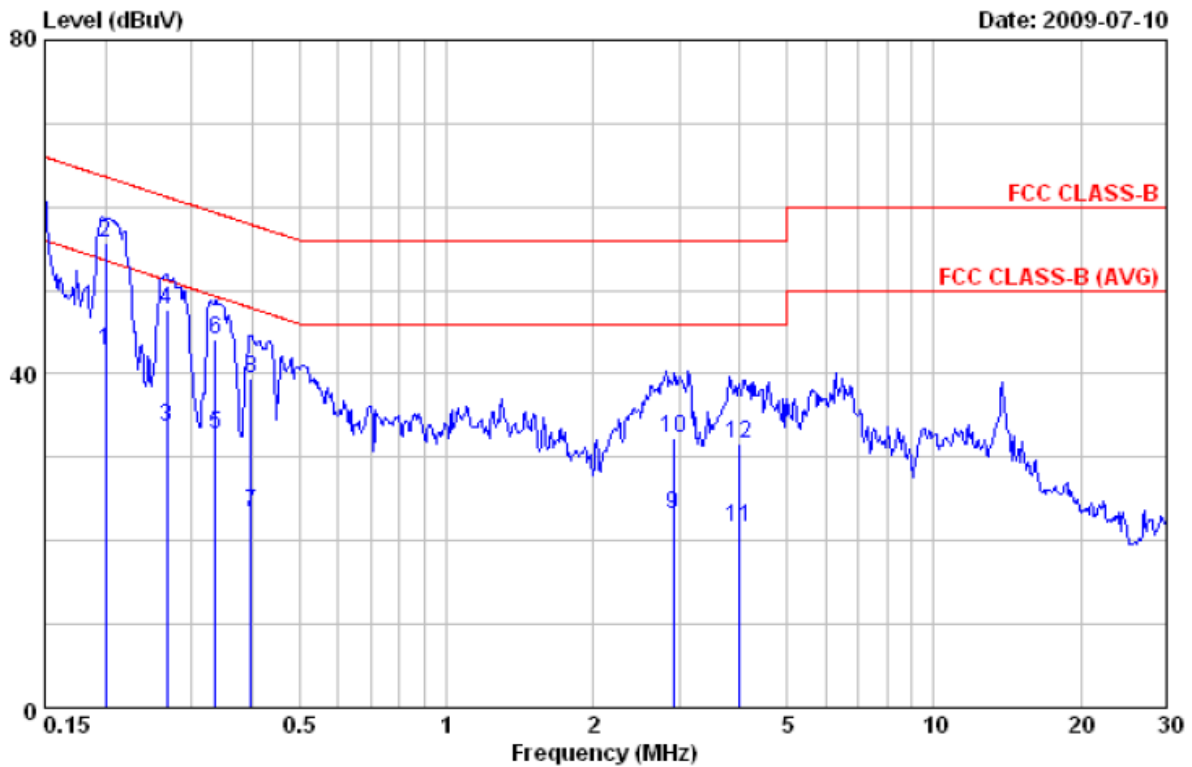

Item	Freq	Read Value	Factor	Result	Limit	Margin	Remark
	MHz	dBuV/m	dB	dBuV/m	dBuV/m	dB	
1	0.20	42.63	0.11	42.74	53.61	-10.87	Average
2	0.20	55.60	0.11	55.71	63.61	-7.90	QP
3	0.27	33.63	0.11	33.74	51.19	-17.45	Average
4	0.27	47.56	0.11	47.67	61.19	-13.52	QP
5	0.34	32.63	0.12	32.75	49.30	-16.55	Average
6	0.34	44.04	0.12	44.16	59.30	-15.14	QP
7	0.40	23.21	0.11	23.32	47.90	-24.58	Average
8	0.40	39.31	0.11	39.42	57.90	-18.48	QP
9	2.92	22.95	0.27	23.22	46.00	-22.78	Average
10	2.92	32.01	0.27	32.28	56.00	-23.72	QP
11	3.99	21.35	0.32	21.67	46.00	-24.33	Average
12	3.99	31.28	0.32	31.60	56.00	-24.40	QP

Notes:

1. Result = Read Value + Factor
2. Factor = Antenna Factor + Cable Loss - Amplifier
3. According to technical experiences, all spurious emission of 8DPSK mode at channel 0,39,78 are almost the same below 1GHz, so that the channel 0 was chosen as representative in final test.
4. The data is worst case.



Power	: AC 120V	Pol/Phase	: NEUTRAL
Test Mode	: 8DPSK CH0	Temperature	: 25 °C
Memo	:	Humidity	: 56 %

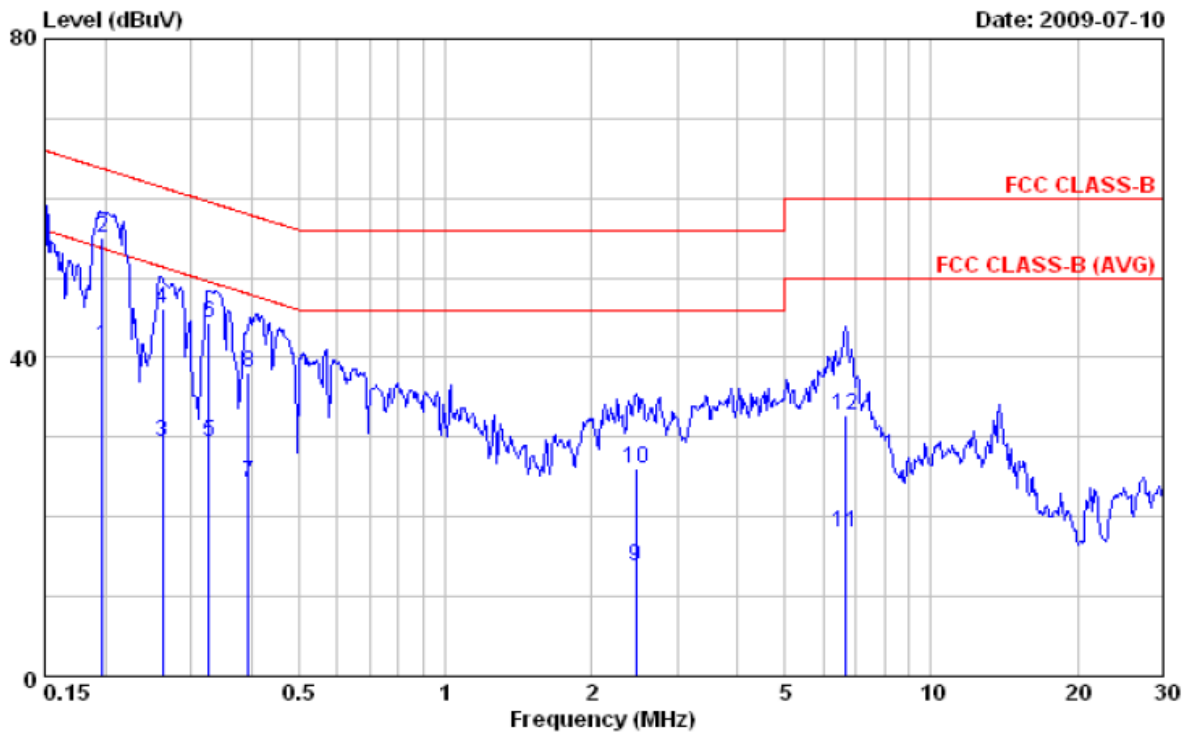

Item	Freq	Read Value	Factor	Result	Limit	Margin	Remark
	MHz	dBuV/m	dB	dBuV/m	dBuV/m	dB	
1	0.20	41.35	0.14	41.49	53.71	-12.22	Average
2	0.20	54.96	0.14	55.10	63.71	-8.61	QP
3	0.26	29.26	0.13	29.39	51.35	-21.96	Average
4	0.26	46.01	0.13	46.14	61.35	-15.21	QP
5	0.33	29.20	0.14	29.34	49.53	-20.19	Average
6	0.33	44.13	0.14	44.27	59.53	-15.26	QP
7	0.39	24.21	0.14	24.35	47.99	-23.64	Average
8	0.39	38.05	0.14	38.19	57.99	-19.80	QP
9	2.47	13.47	0.24	13.71	46.00	-32.29	Average
10	2.47	25.82	0.24	26.06	56.00	-29.94	QP
11	6.66	17.64	0.37	18.01	50.00	-31.99	Average
12	6.66	32.43	0.37	32.80	60.00	-27.20	QP

Notes:

1. Result = Read Value + Factor
2. Factor = Antenna Factor + Cable Loss - Amplifier
3. According to technical experiences, all spurious emission of 8DPSK mode at channel 0,39,78 are almost the same below 1GHz, so that the channel 0 was chosen as representative in final test.
4. The data is worst case.

Test engineer: Ben



5. Test of Radiated Emission

5.1 Test Limit

Radiated emissions from 30 MHz to 25 GHz were measured according to the methods defines in ANSI C63.4-2003. The EUT was placed, 0.8 meter above the ground plane, as shown in section 5.6.3. The interface cables and equipment positions were varied within limits of reasonable applications to determine the positions producing maximum radiated emissions For unintentional device, according to § 15.109(a), except for Class A digital devices, the field strength of radiated emissions from unintentional radiators at a distance of 3 meters shall not exceed the following values:

Frequency (MHz)	Distance Meters	Radiated (μ V / M)	Radiated (dB μ V / M)
30-88	3	100	40.0
88-216	3	150	43.5
216-960	3	200	46.0
Above 960	3	500	54.0

For unintentional device, according to CISPR PUB.22, for Class B digital devices, the general requirement of field strength of radiated emissions from intentional radiators at a distance of 10 meters shall not exceed the above table.

Frequency (MHz)	Distance Meters	Radiated (dB μ V / M)
30-230	10	30
230-1000	10	37

5.2 Test Procedures

- The EUT was placed on a rotatable table top 0.8 meter above ground.
- The EUT was set 3 meters from the interference receiving antenna which was mounted on the top of a variable height antenna tower.
- The table was rotated 360 degrees to determine the position of the highest radiation.
- The antenna is a broadband antenna and its height is varied between one meter and four meters above ground to find the maximum value of the field strength both horizontal polarization and vertical polarization of the antenna are set to make the measurement.
- For each suspected emission the EUT was arranged to its worst case and then tune the antenna tower (from 1 M to 4 M) and turn table (from 0 degree to 360 degrees) to find the maximum reading.
- Set the test-receiver system to Peak or CISPR quasi-peak Detect Function and specified bandwidth with Maximum Hold Mode.
- If the emission level of the EUT in peak mode was 3 dB lower than the limit specified, then testing will be stopped and peak values of EUT will be reported, otherwise, the emissions which do not have 3 dB margin will be repeated one by one using the quasi-peak method and reported.
- For testing above 1GHz, the emission level of the EUT in peak mode was 20dB lower than average limit (that means the emission level in peak mode also complies with the limit in average mode), then testing will be stopped and peak values of EUT will be reported, otherwise, the emissions will be measured in average mode again and reported.



5.3 Typical Test Setup

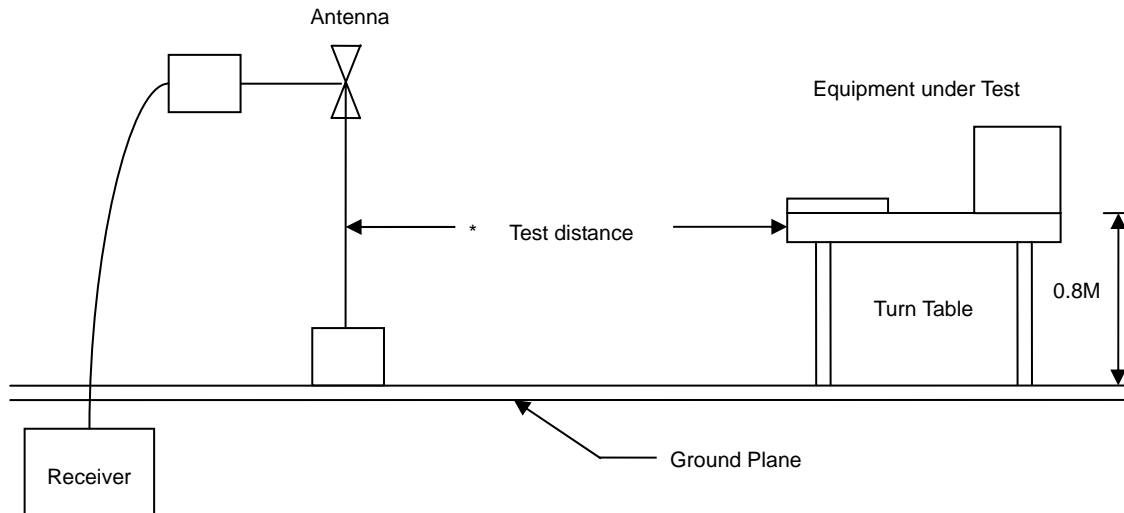

5.4 Measurement equipment

Instrument/Ancillary	Manufacturer	Model No.	Serial No.	Calibration Date	Valid Date
Bilog Antenna	Schaffner	CBL6112B	2840	2009/05/14	2010/05/13
Signal Generator	HP	8648B	3629U00612	2008/10/08	2009/10/07
Amplifier	Agilent	8447D	2944A10593	2009/05/21	2010/05/20
EMI Receiver	HP	8546A	3807A00454	2008/08/07	2009/08/06
RF Filter Section	HP	85460A	3704A00386	2008/08/07	2009/08/06
AC Power Converter	APC	AFC-11005	F103120008	N/A	N/A



5.5 Test Result and Data

Power	: AC 120V	Pol/Phase	: VERTICAL
Test Mode	: Transmit / Receive	Temperature	: 27 °C
Operation Channel	: 0	Humidity	: 55 %
Modulation Type	: GFSK	Atmospheric Pressure	: 1021 hPa
Memo	:	Rate	: 1 Mbps

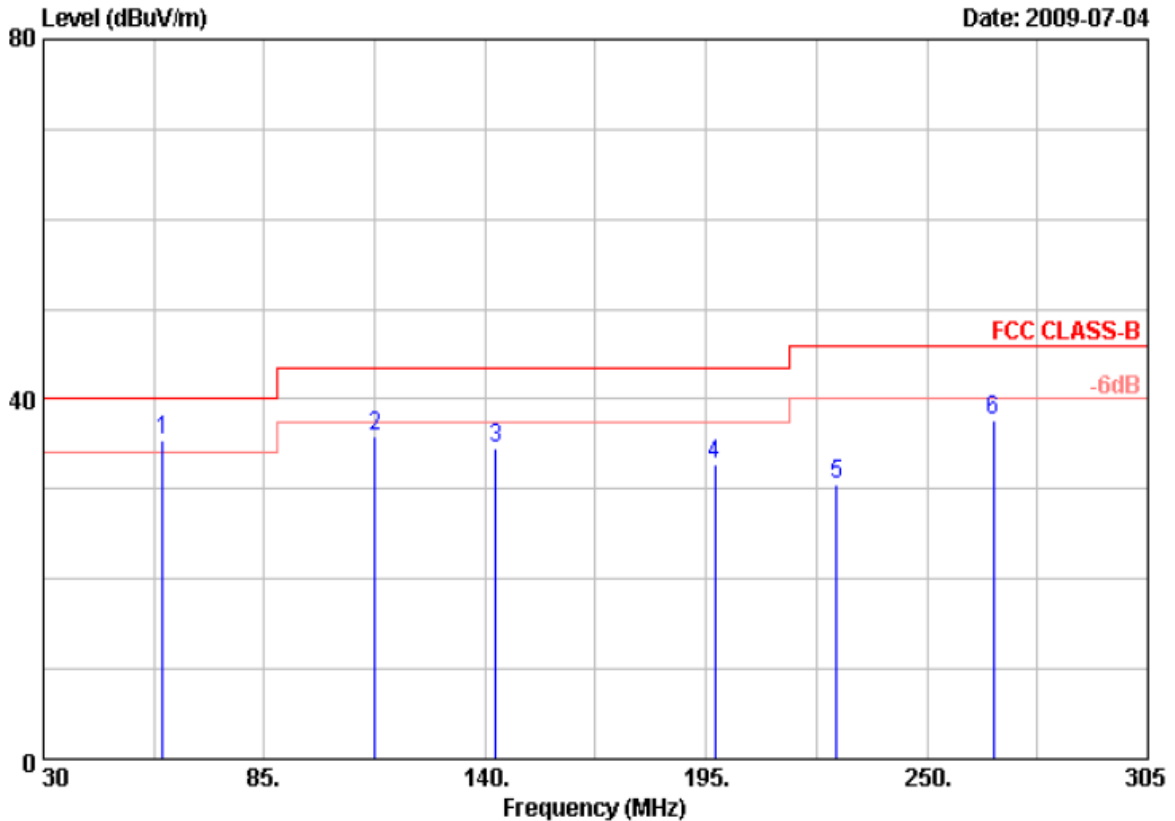

Item	Freq	Read Value	Factor	Result	Limit	Margin	Remark	Ant Pos	Tab Pos
	MHz	dBuV/m	dB	dBuV/m	dBuV/m	dB		cm	Deg
1	59.70	48.18	-12.75	35.43	40.00	-4.57	QP	105	360
2	112.50	46.52	-10.65	35.87	43.50	-7.63	Peak	105	360
3	142.75	45.81	-11.18	34.63	43.50	-8.87	Peak	105	360
4	197.20	42.70	-9.99	32.71	43.50	-10.79	Peak	105	360
5	227.45	41.38	-10.90	30.48	46.00	-15.52	Peak	105	360
6	266.50	50.26	-12.51	37.75	46.00	-8.25	Peak	105	360

Remarks: 1. Result = Read Value + Factor
 2. Factor = Antenna Factor + Cable Loss - Amplifier
 3. According to technical experiences, all spurious emission of FM mode at channel 0,39,78 are almost the same below 1GHz, so that the channel 0 was chosen as representative in final test.
 4. The data is worst case.



Power	: AC 120V	Pol/Phase	: VERTICAL
Test Mode	: Transmit / Receive	Temperature	: 27 °C
Operation Channel	: 0	Humidity	: 55 %
Modulation Type	: GFSK	Atmospheric Pressure	: 1021 hPa
Memo	:	Rate	: 1 Mbps

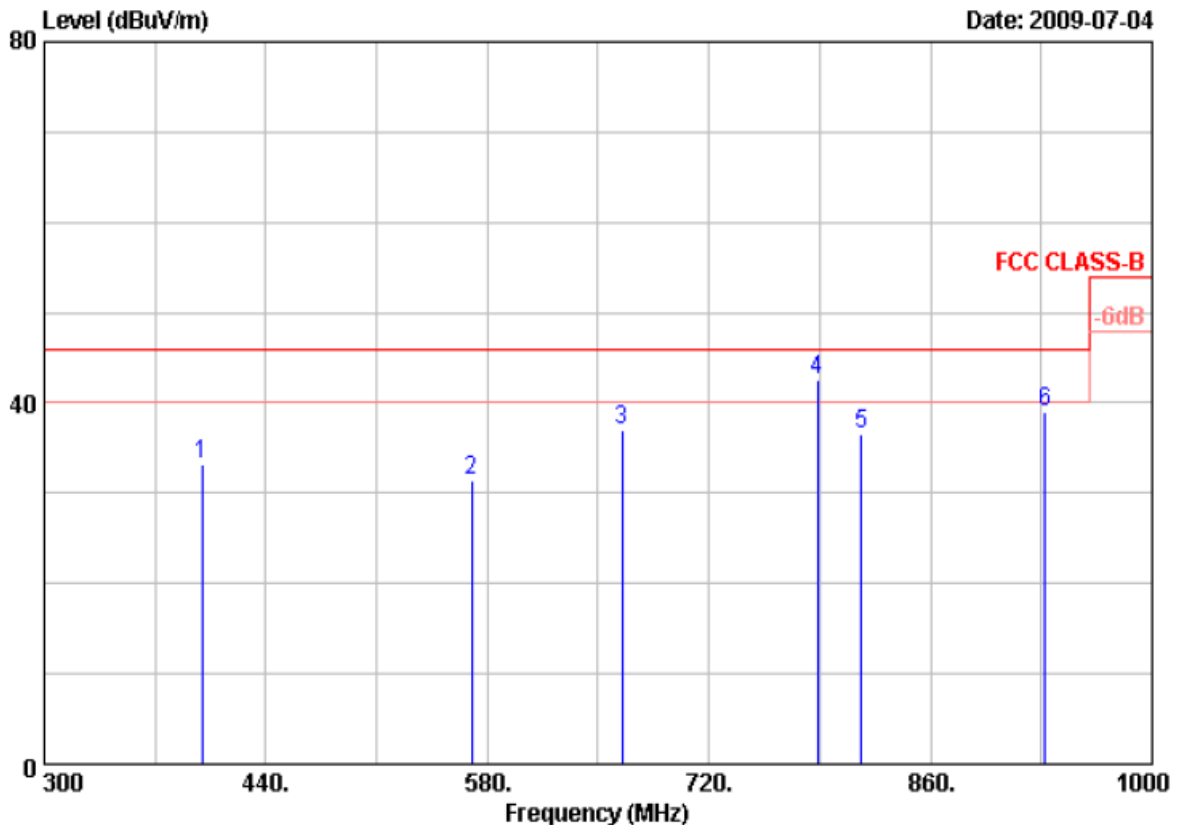

Item	Freq	Read Value	Factor	Result	Limit	Margin	Remark	Ant Pos	Tab Pos
	MHz	dBuV/m	dB	dBuV/m	dBuV/m	dB		cm	Deg
1	399.40	40.25	-6.97	33.28	46.00	-12.72	Peak	105	0
2	570.20	34.29	-2.92	31.37	46.00	-14.63	Peak	105	0
3	665.40	41.20	-4.22	36.98	46.00	-9.02	Peak	105	0
4	788.60	44.57	-1.97	42.60	46.00	-3.40	QP	105	0
5	816.60	36.94	-0.46	36.48	46.00	-9.52	Peak	105	0
6	932.10	34.38	4.62	39.00	46.00	-7.00	Peak	105	0

- Remarks:
1. Result = Read Value + Factor
 2. Factor = Antenna Factor + Cable Loss - Amplifier
 3. According to technical experiences, all spurious emission of FM mode at channel 0,39,78 are almost the same below 1GHz, so that the channel 0 was chosen as representative in final test.
 4. The data is worst case.



Power	: AC 120V	Pol/Phase	: HORIZONTAL
Test Mode	: Transmit / Receive	Temperature	: 27 °C
Operation Channel	: 0	Humidity	: 55 %
Modulation Type	: GFSK	Atmospheric Pressure	: 1021 hPa
Memo	:	Rate	: 1 Mbps

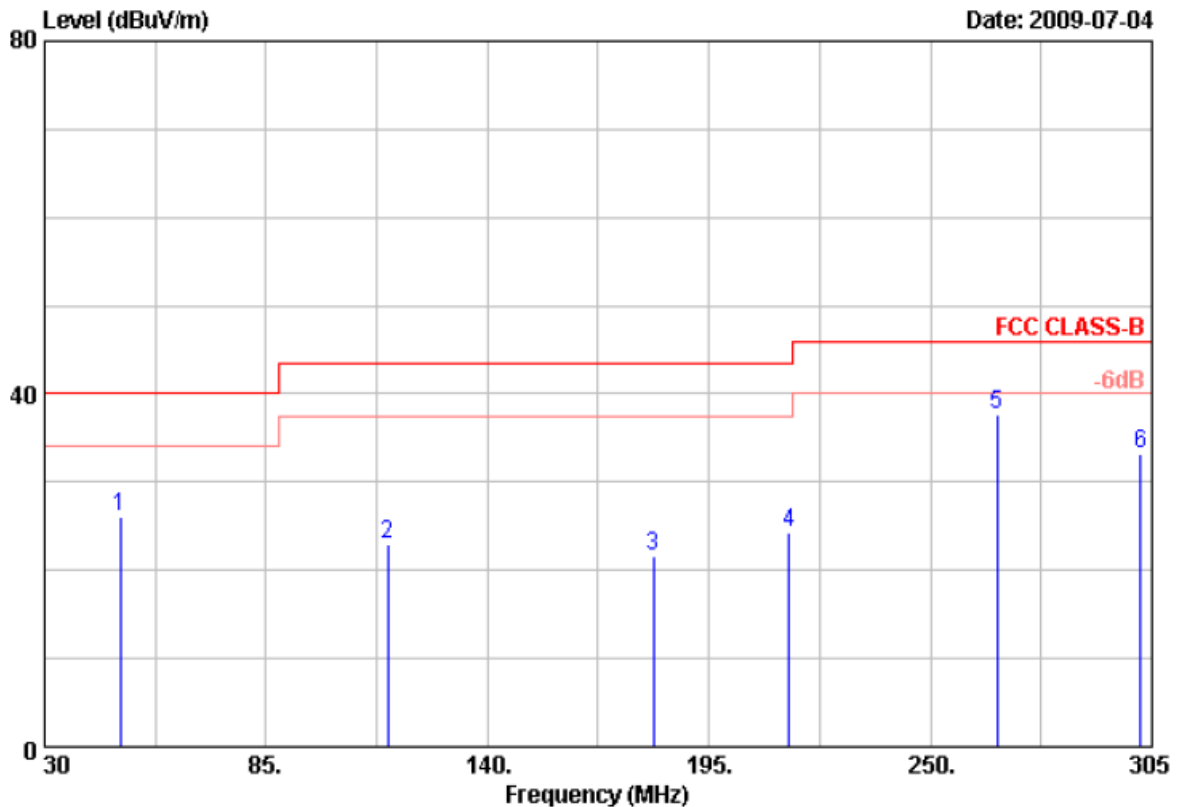

Item	Freq	Read Value	Factor	Result	Limit	Margin	Remark	Ant Pos	Tab Pos
	MHz	dBuV/m	dB	dBuV/m	dBuV/m	dB		cm	Deg
1	48.70	40.82	-14.64	26.18	40.00	-13.82	Peak	105	360
2	115.25	40.37	-17.46	22.91	43.50	-20.59	Peak	105	360
3	181.25	38.79	-17.27	21.52	43.50	-21.98	Peak	105	360
4	214.80	40.77	-16.59	24.18	43.50	-19.32	Peak	105	360
5	266.50	51.30	-13.58	37.72	46.00	-8.28	Peak	105	360
6	302.25	45.74	-12.60	33.14	46.00	-12.86	Peak	105	360

Remarks: 1. Result = Read Value + Factor
 2. Factor = Antenna Factor + Cable Loss - Amplifier
 3. According to technical experiences, all spurious emission of FM mode at channel 0,39,78 are almost the same below 1GHz, so that the channel 0 was chosen as representative in final test.
 4. The data is worst case.



Power	: AC 120V	Pol/Phase	: HORIZONTAL
Test Mode	: Transmit / Receive	Temperature	: 27 °C
Operation Channel	: 0	Humidity	: 55 %
Modulation Type	: GFSK	Atmospheric Pressure	: 1021 hPa
Memo	:	Rate	: 1 Mbps

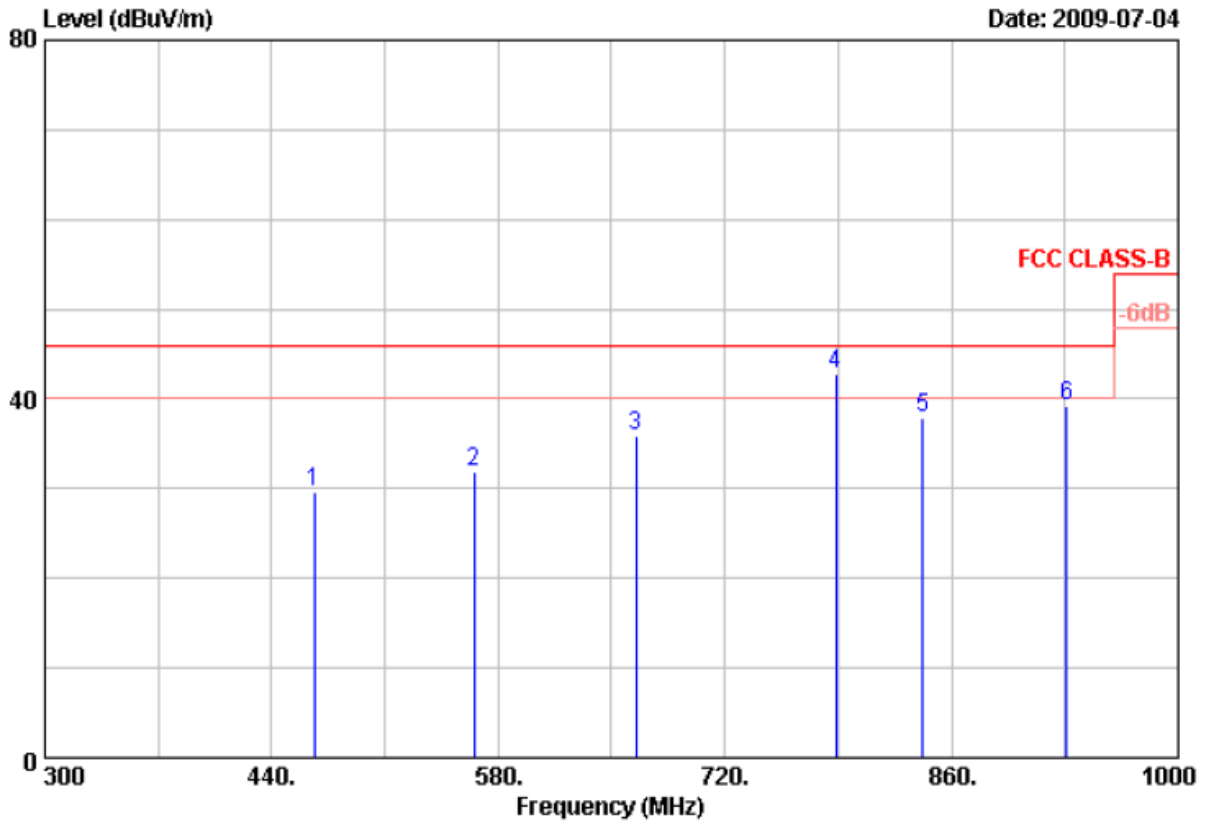

Item	Freq	Read Value	Factor	Result	Limit	Margin	Remark	Ant Pos	Tab Pos
	MHz	dBUV/m	dB	dBUV/m	dBUV/m	dB		cm	Deg
1	466.60	35.36	-5.77	29.59	46.00	-16.41	Peak	105	0
2	565.30	33.55	-1.65	31.90	46.00	-14.10	Peak	105	0
3	665.40	39.75	-3.89	35.86	46.00	-10.14	Peak	105	0
4	788.60	43.11	-0.29	42.82	46.00	-3.18	QP	105	0
5	842.50	36.69	1.24	37.93	46.00	-8.07	Peak	105	0
6	931.40	36.84	2.41	39.25	46.00	-6.75	Peak	105	0

Remarks: 1. Result = Read Value + Factor
 2. Factor = Antenna Factor + Cable Loss - Amplifier
 3. According to technical experiences, all spurious emission of FM mode at channel 0,39,78 are almost the same below 1GHz, so that the channel 0 was chosen as representative in final test.
 4. The data is worst case.



Power	: AC 120V	Pol/Phase	: VERTICAL
Test Mode	: Transmit / Receive	Temperature	: 26 °C
Operation Channel	: 0	Humidity	: 60 %
Modulation Type	: GFSK	Atmospheric Pressure	: 1007 hPa
Memo	:	Rate	: 1 Mbps

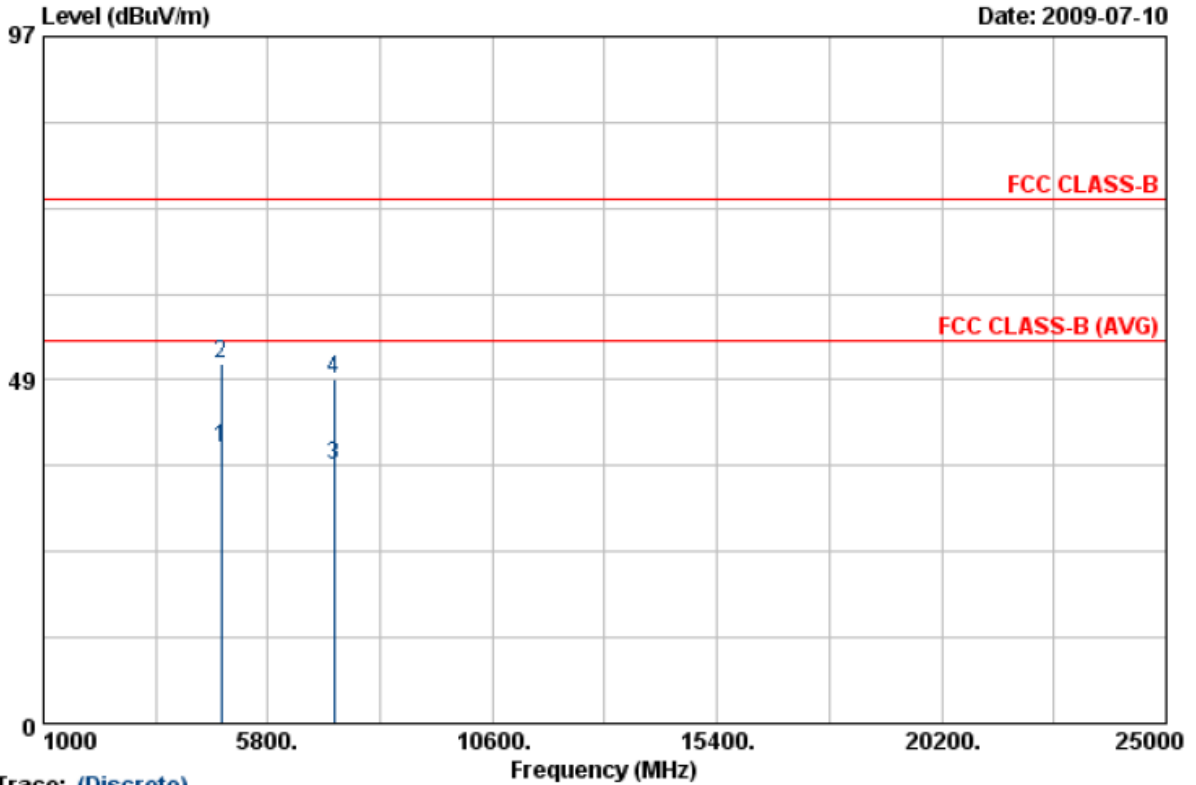

Trace: (Discrete)

Item	Freq	Read Value	Factor	Result	Limit	Margin	Remark	Ant Pos	Tab Pos
	MHz	dBuV/m	dB	dBuV/m	dBuV/m	dB		cm	Deg
1	4804.03	36.32	2.51	38.83	54.00	-15.17	Average	119	240
2	4804.03	48.39	2.51	50.90	74.00	-23.10	Peak	119	240
3	7205.43	29.67	6.87	36.54	54.00	-17.46	Average	119	240
4	7205.43	41.90	6.87	48.77	74.00	-25.23	Peak	119	240

Notes:

1. Result = Read Value + Factor
2. Factor = Antenna Factor + Cable Loss - Amplifier
3. The resolution bandwidth of test receiver/spectrum analyzer is 120KHz and video bandwidth is 300kHz for Peak detection and Quasi-peak detection at frequency below 1GHz.
4. The resolution bandwidth of test receiver/spectrum analyzer is 1MHz and video bandwidth is 3MHz for Peak detection at frequency above 1GHz.
5. The resolution bandwidth of test receiver/spectrum analyzer is 1MHz and video bandwidth is 10Hz for Average detection at frequency above 1GHz.
6. The other emissions is too low to be measured.



Power	: AC 120V	Pol/Phase	: HORIZONTAL
Test Mode	: Transmit / Receive	Temperature	: 26 °C
Operation Channel	: 0	Humidity	: 60 %
Modulation Type	: GFSK	Atmospheric Pressure	: 1007 hPa
Memo	:	Rate	: 1 Mbps

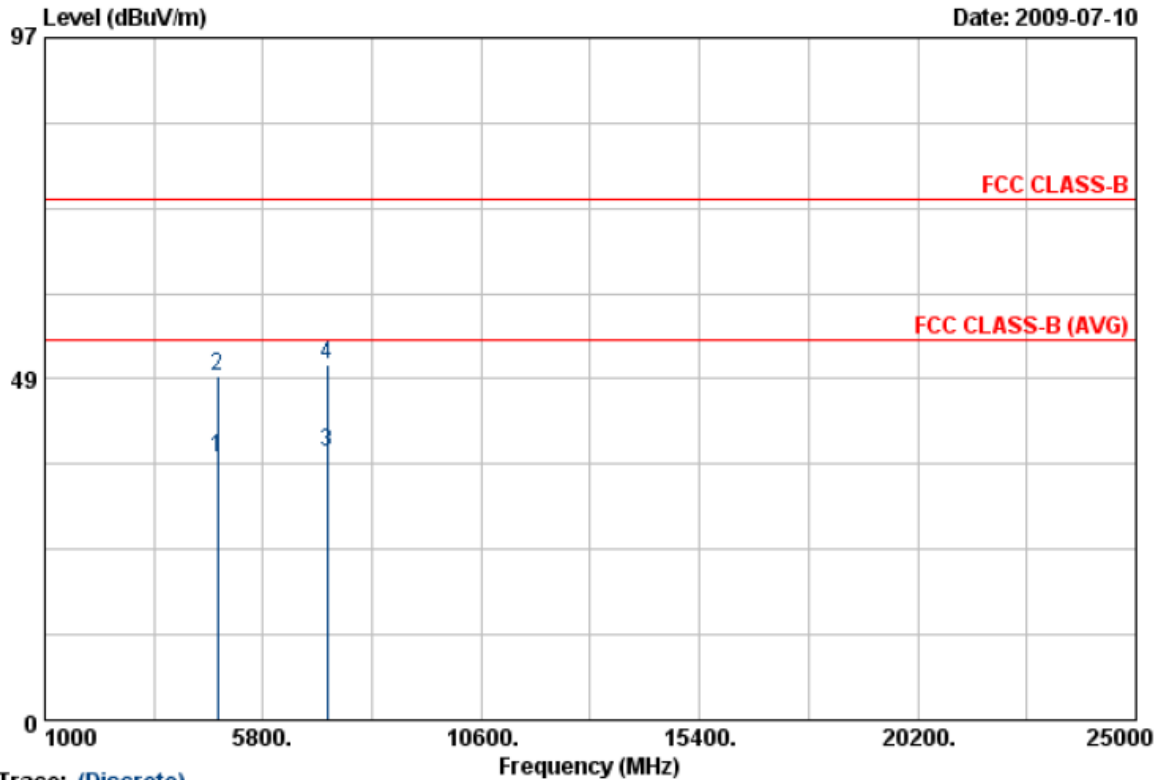

Trace: (Discrete)

Item	Freq	Read Value	Factor	Result	Limit	Margin	Remark	Ant Pos	Tab Pos
	MHz	dBuV/m	dB	dBuV/m	dBuV/m	dB		cm	Deg
1	4803.95	34.66	2.51	37.17	54.00	-16.83	Average	150	250
2	4803.95	46.27	2.51	48.78	74.00	-25.22	Peak	150	250
3	7205.65	31.29	6.87	38.16	54.00	-15.84	Average	150	250
4	7205.65	43.72	6.87	50.59	74.00	-23.41	Peak	150	250

Notes:

1. Result = Read Value + Factor
2. Factor = Antenna Factor + Cable Loss - Amplifier
3. The resolution bandwidth of test receiver/spectrum analyzer is 120KHz and video bandwidth is 300kHz for Peak detection and Quasi-peak detection at frequency below 1GHz.
4. The resolution bandwidth of test receiver/spectrum analyzer is 1MHz and video bandwidth is 3MHz for Peak detection at frequency above 1GHz.
5. The resolution bandwidth of test receiver/spectrum analyzer is 1MHz and video bandwidth is 10Hz for Average detection at frequency above 1GHz.
6. The other emissions is too low to be measured.



Power	: AC 120V	Pol/Phase	: VERTICAL
Test Mode	: Transmit / Receive	Temperature	: 26 °C
Operation Channel	: 39	Humidity	: 60 %
Modulation Type	: GFSK	Atmospheric Pressure	: 1007 hPa
Memo	:	Rate	: 1 Mbps

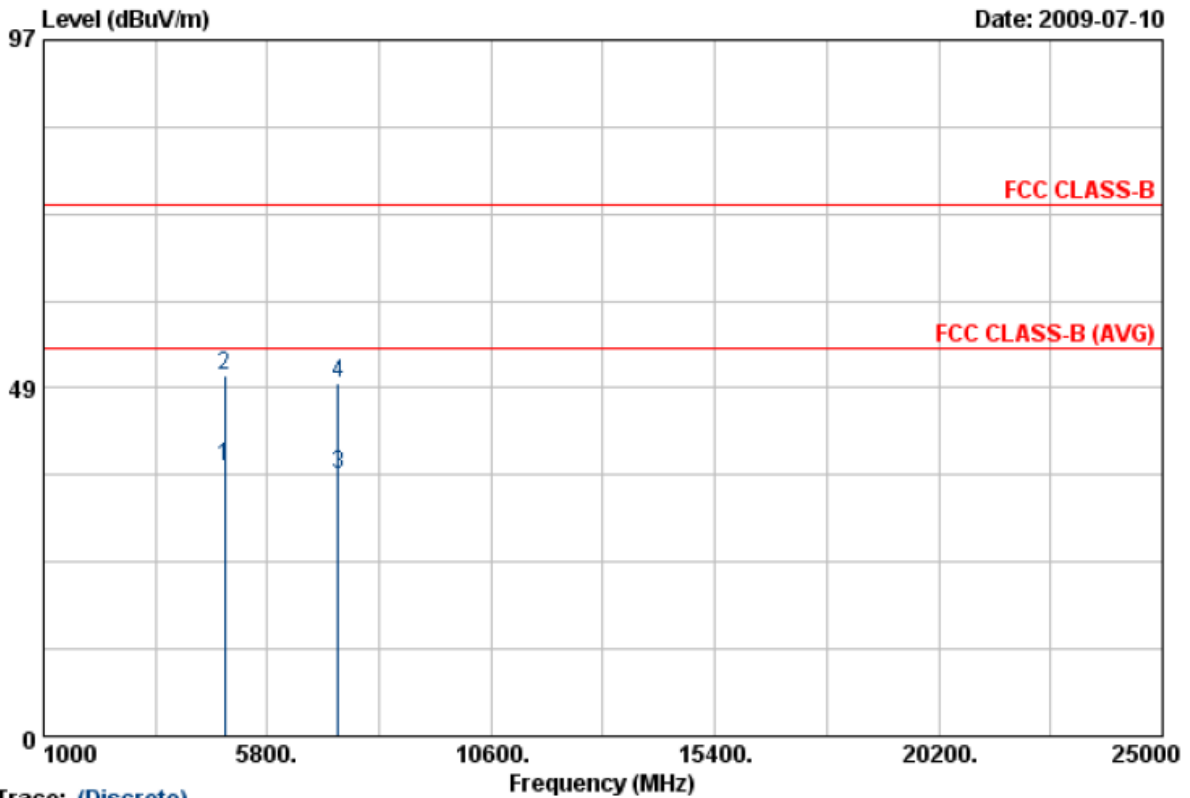

Trace: (Discrete)

Item	Freq	Read Value	Factor	Result	Limit	Margin	Remark	Ant Pos	Tab Pos
	MHz	dBuV/m	dB	dBuV/m	dBuV/m	dB		cm	Deg
1	4882.03	34.85	2.72	37.57	54.00	-16.43	Average	119	240
2	4882.03	47.47	2.72	50.19	74.00	-23.81	Peak	119	240
3	7322.88	29.21	7.23	36.44	54.00	-17.56	Average	119	240
4	7322.88	41.84	7.23	49.07	74.00	-24.93	Peak	119	240

Notes:

1. Result = Read Value + Factor
2. Factor = Antenna Factor + Cable Loss - Amplifier
3. The resolution bandwidth of test receiver/spectrum analyzer is 120KHz and video bandwidth is 300kHz for Peak detection and Quasi-peak detection at frequency below 1GHz.
4. The resolution bandwidth of test receiver/spectrum analyzer is 1MHz and video bandwidth is 3MHz for Peak detection at frequency above 1GHz.
5. The resolution bandwidth of test receiver/spectrum analyzer is 1MHz and video bandwidth is 10Hz for Average detection at frequency above 1GHz.
6. The other emissions is too low to be measured.



Power	: AC 120V	Pol/Phase	: HORIZONTAL
Test Mode	: Transmit / Receive	Temperature	: 26 °C
Operation Channel	: 39	Humidity	: 60 %
Modulation Type	: GFSK	Atmospheric Pressure	: 1007 hPa
Memo	:	Rate	: 1 Mbps

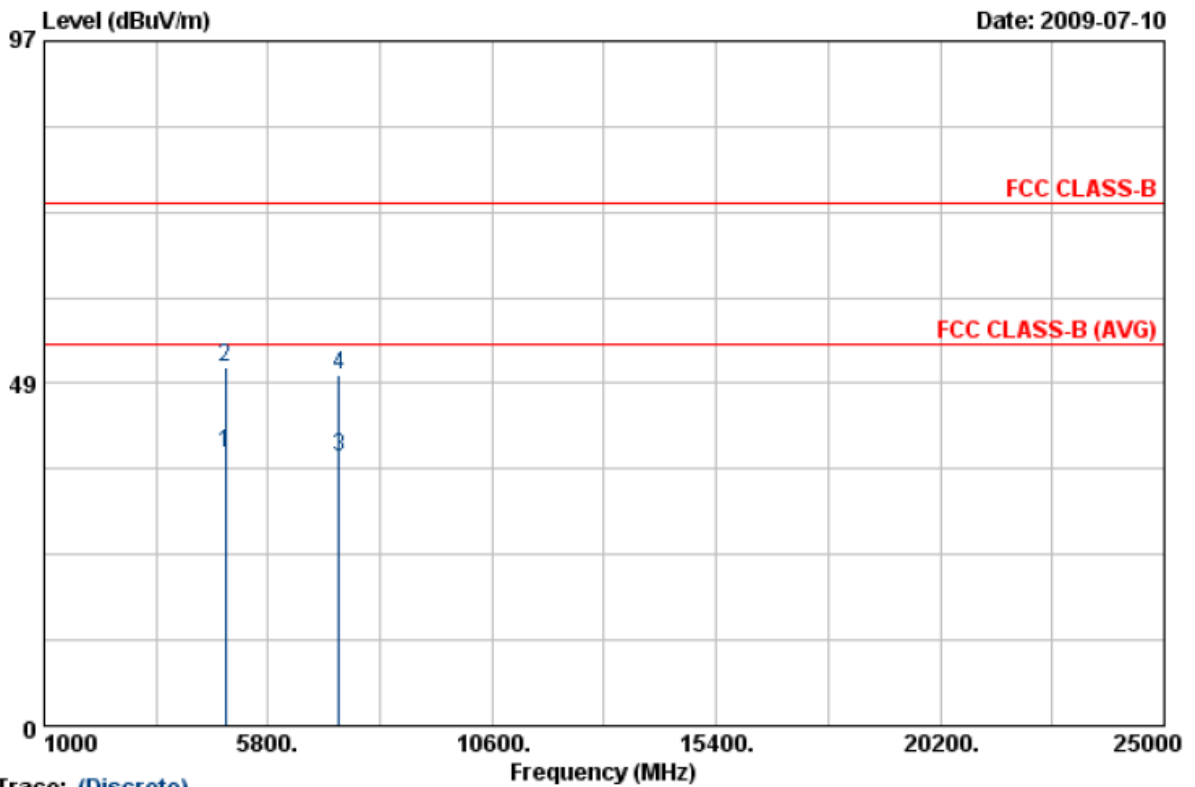

Trace: (Discrete)

Item	Read Freq	Read Value	Factor	Result	Limit	Margin	Remark	Ant Pos	Tab Pos
	MHz	dBuV/m	dB	dBuV/m	dBuV/m	dB		cm	Deg
1	4882.08	35.84	2.72	38.56	54.00	-15.44	Average	150	250
2	4882.08	48.17	2.72	50.89	74.00	-23.11	Peak	150	250
3	7322.05	30.80	7.23	38.03	54.00	-15.97	Average	150	250
4	7322.05	42.57	7.23	49.80	74.00	-24.20	Peak	150	250

Notes:

1. Result = Read Value + Factor
2. Factor = Antenna Factor + Cable Loss - Amplifier
3. The resolution bandwidth of test receiver/spectrum analyzer is 120KHz and video bandwidth is 300kHz for Peak detection and Quasi-peak detection at frequency below 1GHz.
4. The resolution bandwidth of test receiver/spectrum analyzer is 1MHz and video bandwidth is 3MHz for Peak detection at frequency above 1GHz.
5. The resolution bandwidth of test receiver/spectrum analyzer is 1MHz and video bandwidth is 10Hz for Average detection at frequency above 1GHz.
6. The other emissions is too low to be measured.



Power	: AC 120V	Pol/Phase	: VERTICAL
Test Mode	: Transmit / Receive	Temperature	: 26 °C
Operation Channel	: 78	Humidity	: 60 %
Modulation Type	: GFSK	Atmospheric Pressure	: 1007 hPa
Memo	:	Rate	: 1 Mbps

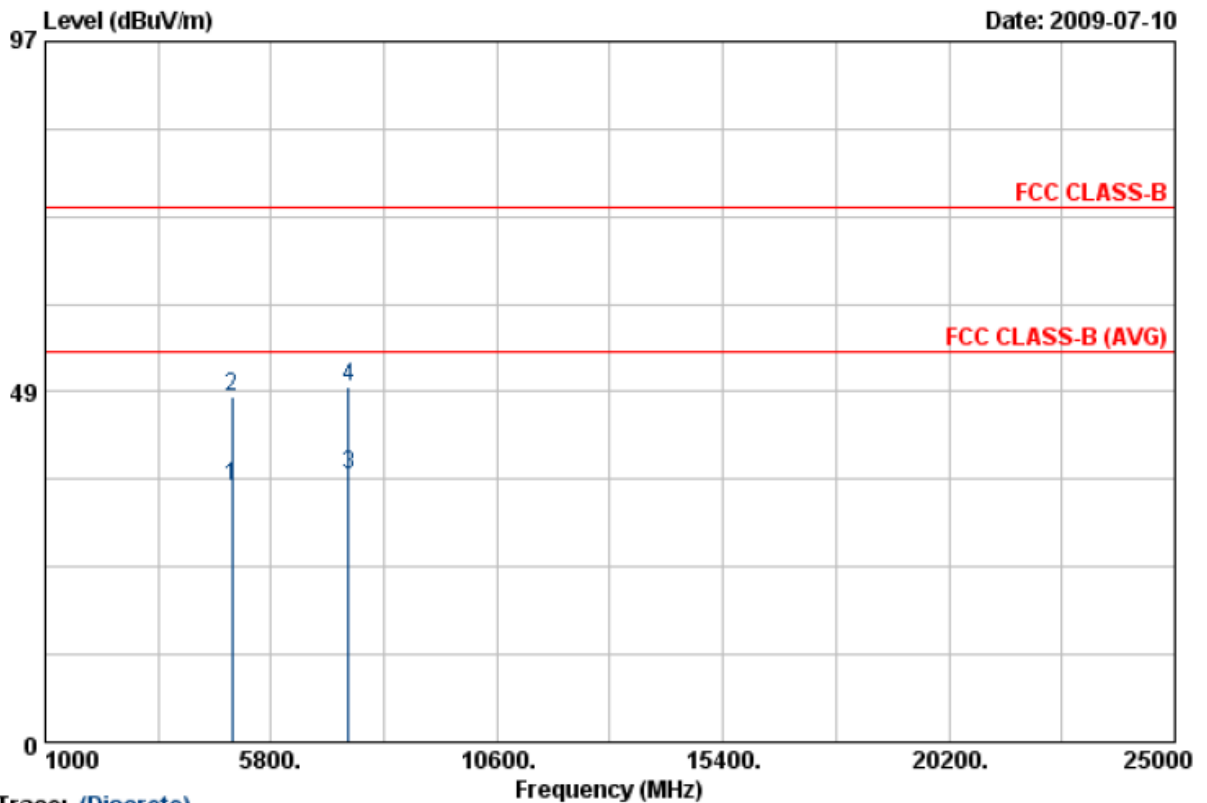

Trace: (Discrete)

Item	Freq	Read Value	Factor	Result	Limit	Margin	Remark	Ant Pos	Tab Pos
	MHz	dBuV/m	dB	dBuV/m	dBuV/m	dB		cm	Deg
1	4959.93	32.36	2.92	35.28	54.00	-18.72	Average	119	240
2	4959.93	44.93	2.92	47.85	74.00	-26.15	Peak	119	240
3	7439.93	29.40	7.59	36.99	54.00	-17.01	Average	119	240
4	7439.93	41.57	7.59	49.16	74.00	-24.84	Peak	119	240

Notes:

1. Result = Read Value + Factor
2. Factor = Antenna Factor + Cable Loss - Amplifier
3. The resolution bandwidth of test receiver/spectrum analyzer is 120KHz and video bandwidth is 300kHz for Peak detection and Quasi-peak detection at frequency below 1GHz.
4. The resolution bandwidth of test receiver/spectrum analyzer is 1MHz and video bandwidth is 3MHz for Peak detection at frequency above 1GHz.
5. The resolution bandwidth of test receiver/spectrum analyzer is 1MHz and video bandwidth is 10Hz for Average detection at frequency above 1GHz.
6. The other emissions is too low to be measured.



Power	: AC 120V	Pol/Phase	: HORIZONTAL
Test Mode	: Transmit / Receive	Temperature	: 26 °C
Operation Channel	: 78	Humidity	: 60 %
Modulation Type	: GFSK	Atmospheric Pressure	: 1007 hPa
Memo	:	Rate	: 1 Mbps

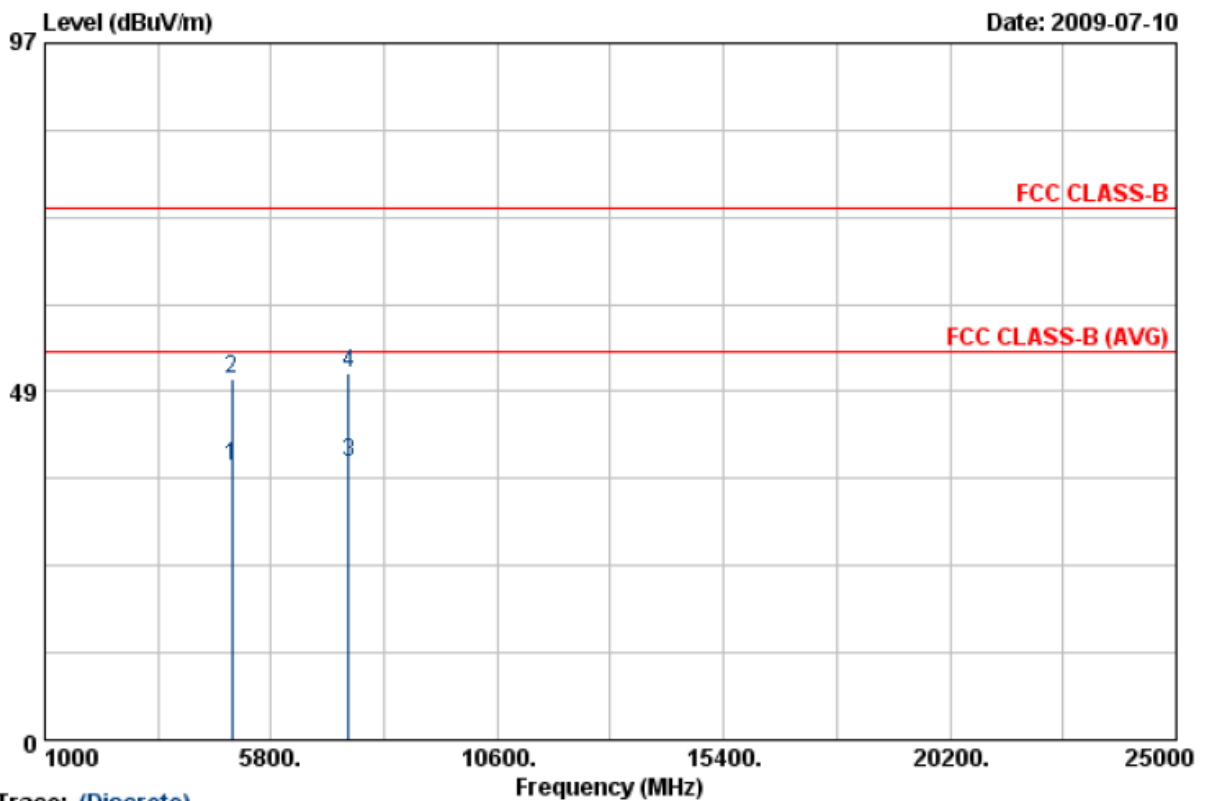

Trace: (Discrete)

Item	Freq	Read Value	Factor	Result	Limit	Margin	Remark	Ant Pos	Tab Pos
	MHz	dBuV/m	dB	dBuV/m	dBuV/m	dB		cm	Deg
1	4960.05	35.23	2.92	38.15	54.00	-15.85	Average	150	250
2	4960.05	47.39	2.92	50.31	74.00	-23.69	Peak	150	250
3	7444.78	31.02	7.61	38.63	54.00	-15.37	Average	150	250
4	7444.78	43.59	7.61	51.20	74.00	-22.80	Peak	150	250

Notes:

1. Result = Read Value + Factor
2. Factor = Antenna Factor + Cable Loss - Amplifier
3. The resolution bandwidth of test receiver/spectrum analyzer is 120KHz and video bandwidth is 300kHz for Peak detection and Quasi-peak detection at frequency below 1GHz.
4. The resolution bandwidth of test receiver/spectrum analyzer is 1MHz and video bandwidth is 3MHz for Peak detection at frequency above 1GHz.
5. The resolution bandwidth of test receiver/spectrum analyzer is 1MHz and video bandwidth is 10Hz for Average detection at frequency above 1GHz.
6. The other emissions is too low to be measured.



Power	: AC 120V	Pol/Phase	: VERTICAL
Test Mode	: Transmit / Receive	Temperature	: 27 °C
Operation Channel	: 0	Humidity	: 55 %
Modulation Type	: $\pi/4$ -DQPSK	Atmospheric Pressure	: 1021 hPa
Memo	:	Rate	: 2 Mbps

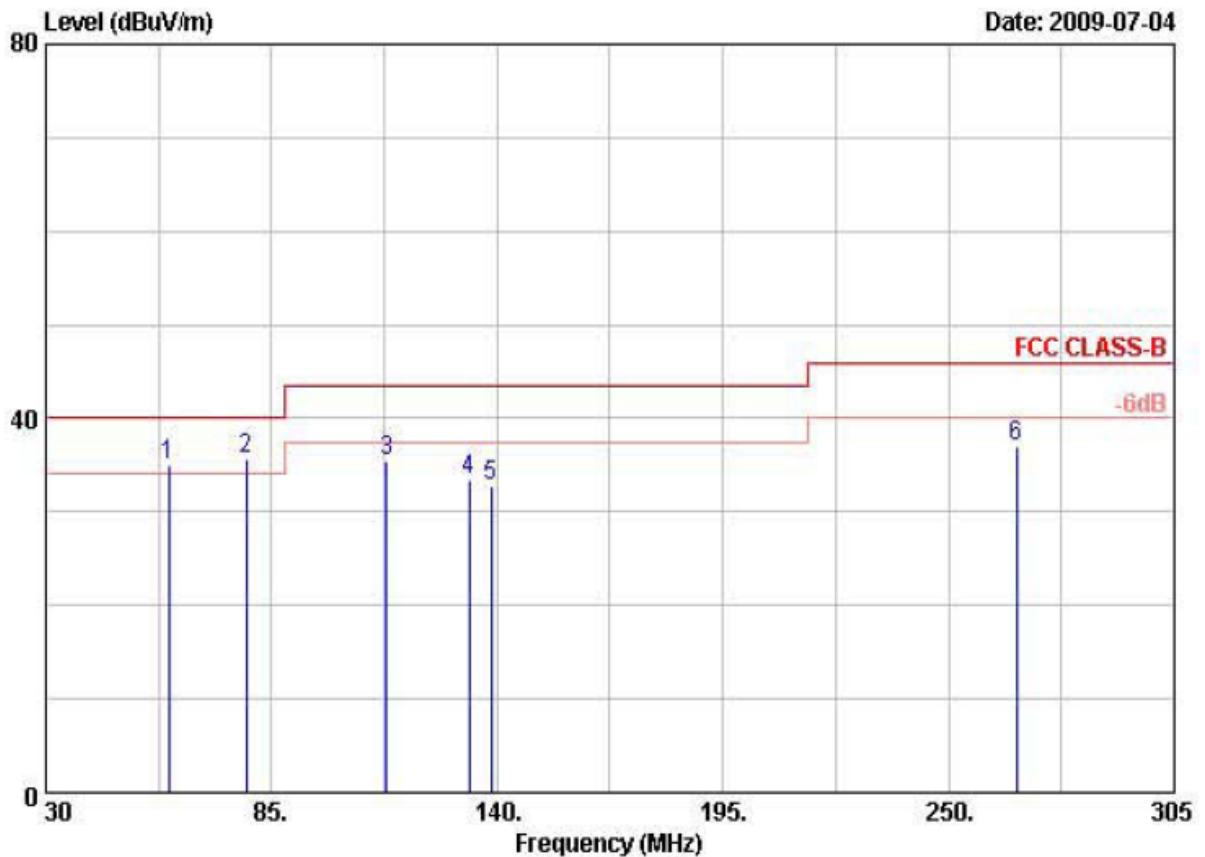

Item	Freq MHz	Read Value dBuV/m	Factor dB	Result dBuV/m	Limit dBuV/m	Margin dB	Remark	Ant Pos cm	Tab Pos Deg
1	59.98	47.82	-12.76	35.06	40.00	-4.94	QP	105	360
2	78.95	50.20	-14.51	35.69	40.00	-4.31	QP	105	360
3	113.05	46.03	-10.61	35.42	43.50	-8.08	Peak	105	360
4	133.13	42.82	-9.47	33.35	43.50	-10.15	Peak	105	360
5	138.63	43.57	-10.82	32.75	43.50	-10.75	Peak	105	360
6	266.50	49.55	-12.51	37.04	46.00	-8.96	Peak	105	360

- Remarks:
1. Result = Read Value + Factor
 2. Factor = Antenna Factor + Cable Loss - Amplifier
 3. According to technical experiences, all spurious emission of FM mode at channel 0,39,78 are almost the same below 1GHz, so that the channel 0 was chosen as representative in final test.
 4. The data is worst case.



Power	: AC 120V	Pol/Phase	: VERTICAL
Test Mode	: Transmit / Receive	Temperature	: 27 °C
Operation Channel	: 0	Humidity	: 55 %
Modulation Type	: $\pi/4$ -DQPSK	Atmospheric Pressure	: 1021 hPa
Memo	:	Rate	: 2 Mbps

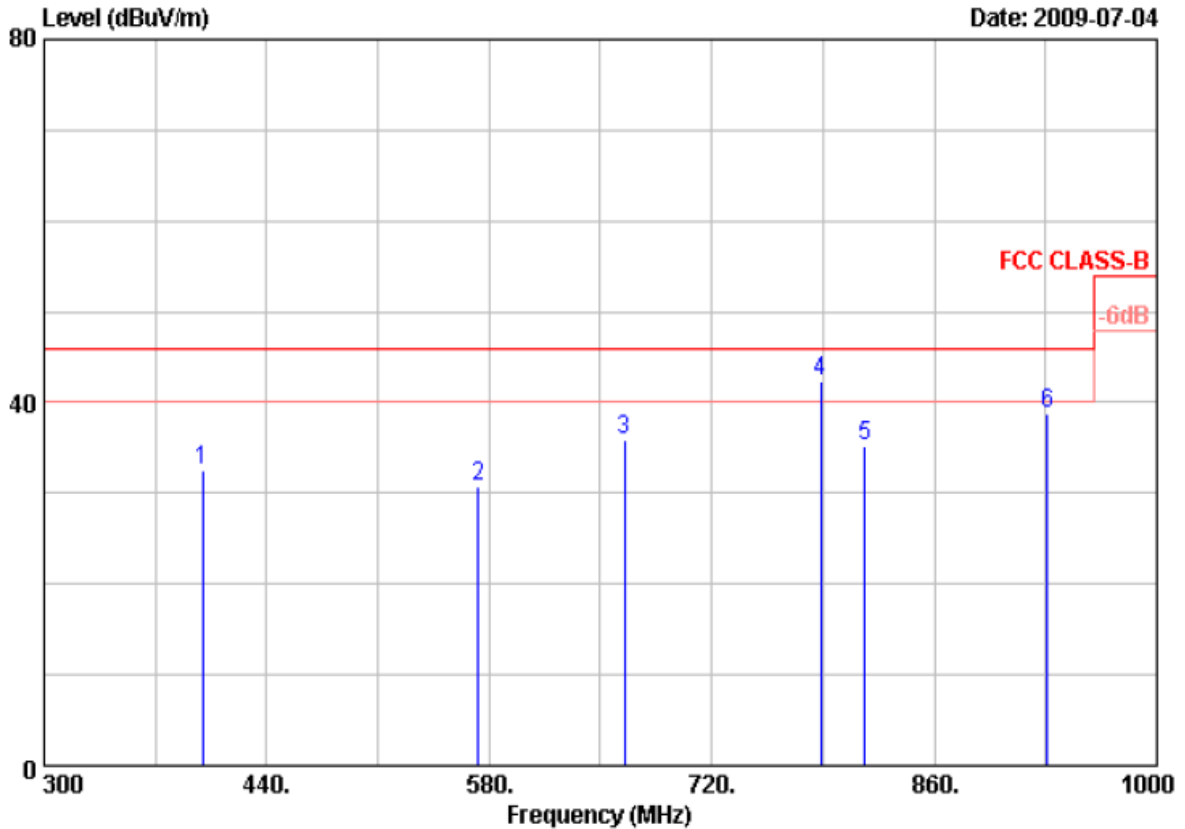

Item	Freq	Read Value	Factor	Result	Limit	Margin	Remark	Ant Pos	Tab Pos
	MHz	dBuV/m	dB	dBuV/m	dBuV/m	dB		cm	Deg
1	399.40	39.54	-6.97	32.57	46.00	-13.43	Peak	105	0
2	573.00	34.00	-3.27	30.73	46.00	-15.27	Peak	105	0
3	665.40	40.08	-4.22	35.86	46.00	-10.14	Peak	105	0
4	788.60	44.28	-1.97	42.31	46.00	-3.69	QP	105	0
5	816.60	35.59	-0.46	35.13	46.00	-10.87	Peak	105	0
6	931.40	34.05	4.75	38.80	46.00	-7.20	Peak	105	0

Remarks: 1. Result = Read Value + Factor
 2. Factor = Antenna Factor + Cable Loss - Amplifier
 3. According to technical experiences, all spurious emission of FM mode at channel 0,39,78 are almost the same below 1GHz, so that the channel 0 was chosen as representative in final test.
 4. The data is worst case.



Power	: AC 120V	Pol/Phase	: HORIZONTAL
Test Mode	: Transmit / Receive	Temperature	: 27 °C
Operation Channel	: 0	Humidity	: 55 %
Modulation Type	: $\pi/4$ -DQPSK	Atmospheric Pressure	: 1021 hPa
Memo	:	Rate	: 2 Mbps

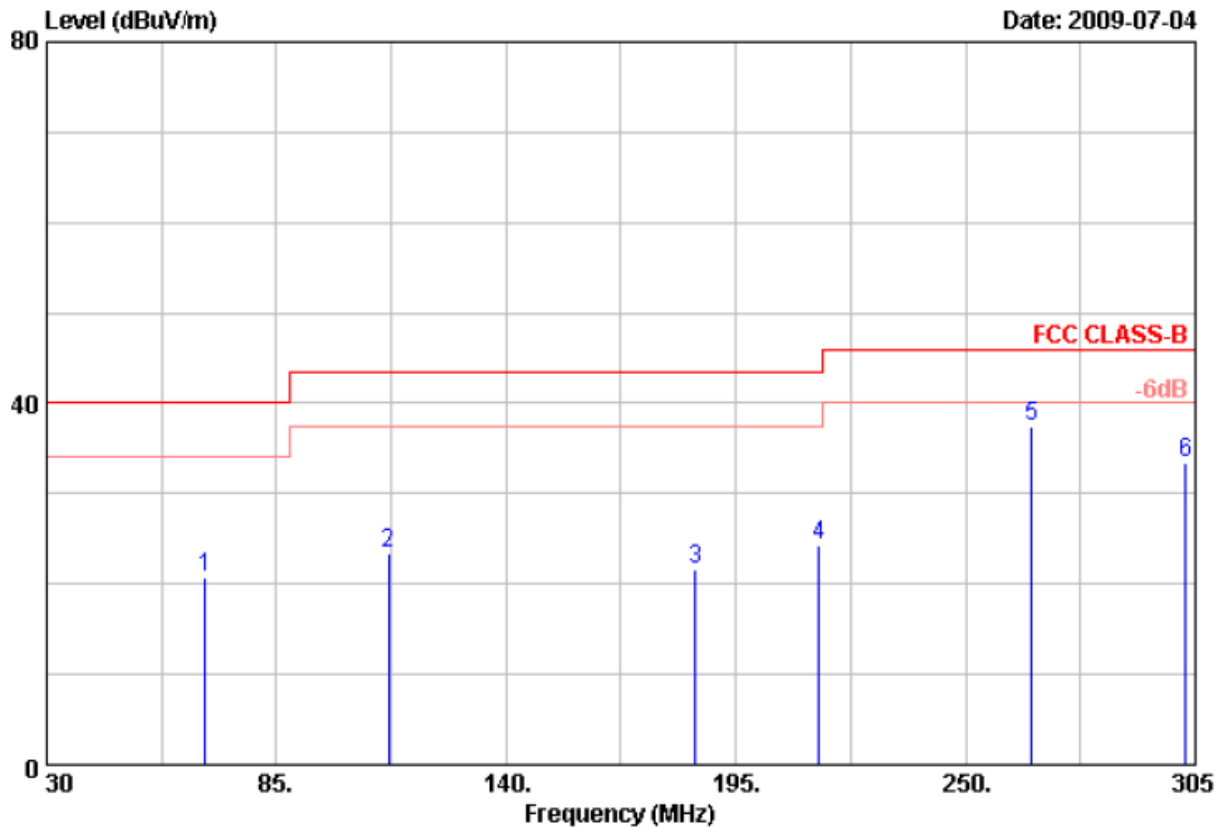

Item	Freq	Read Value	Factor	Result	Limit	Margin	Remark	Ant Pos	Tab Pos
	MHz	dBuV/m	dB	dBuV/m	dBuV/m	dB		cm	Deg
1	67.95	42.01	-21.22	20.79	40.00	-19.21	Peak	105	360
2	111.95	41.05	-17.72	23.33	43.50	-20.17	Peak	105	360
3	185.38	39.13	-17.42	21.71	43.50	-21.79	Peak	105	360
4	214.80	40.77	-16.59	24.18	43.50	-19.32	Peak	105	360
5	265.95	51.10	-13.64	37.46	46.00	-8.54	Peak	105	360
6	302.80	46.05	-12.52	33.53	46.00	-12.47	Peak	105	360

Remarks: 1. Result = Read Value + Factor
 2. Factor = Antenna Factor + Cable Loss - Amplifier
 3. According to technical experiences, all spurious emission of FM mode at channel 0,39,78 are almost the same below 1GHz, so that the channel 0 was chosen as representative in final test.
 4. The data is worst case.



Power	: AC 120V	Pol/Phase	: HORIZONTAL
Test Mode	: Transmit / Receive	Temperature	: 27 °C
Operation Channel	: 0	Humidity	: 55 %
Modulation Type	: $\pi/4$ -DQPSK	Atmospheric Pressure	: 1021 hPa
Memo	:	Rate	: 2 Mbps

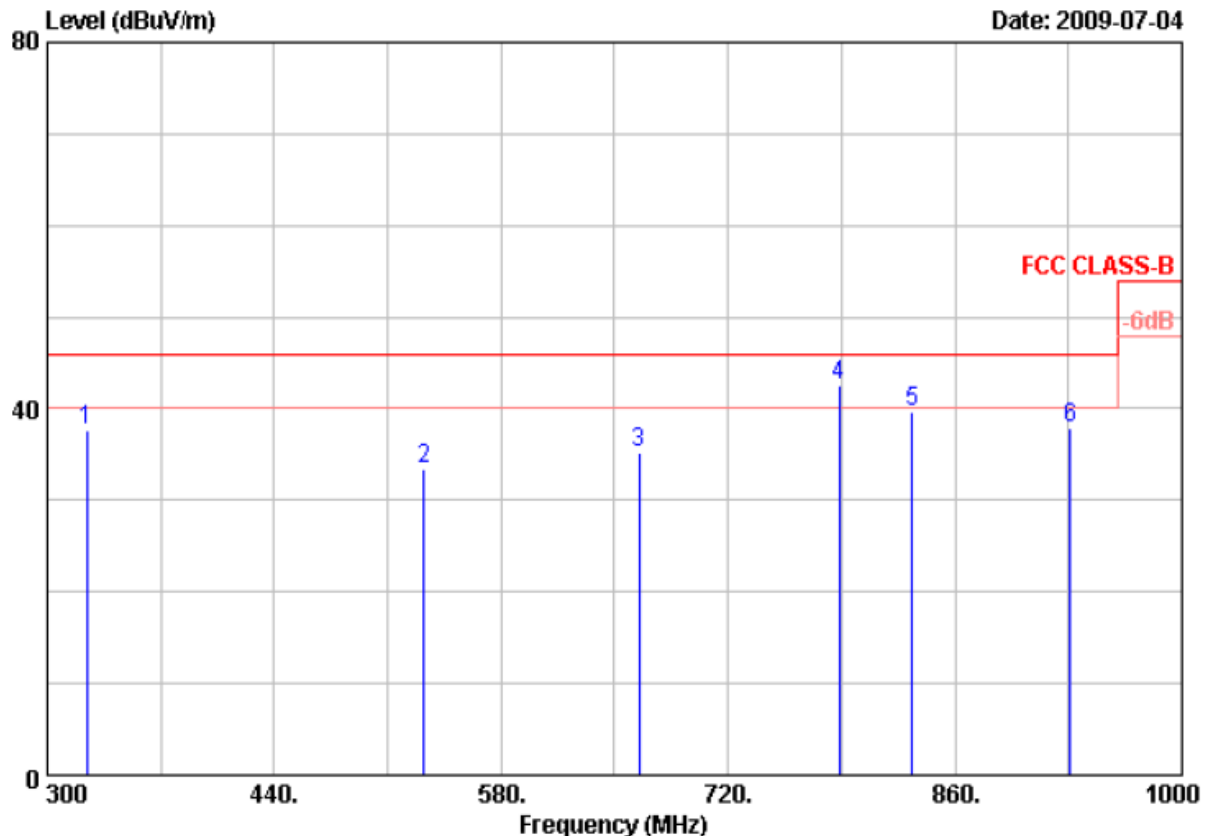

Item	Freq	Read Value	Factor	Result	Limit	Margin	Remark	Ant Pos	Tab Pos
	MHz	dBuV/m	dB	dBuV/m	dBuV/m	dB		cm	Deg
1	324.50	49.72	-11.95	37.77	46.00	-8.23	Peak	105	0
2	532.40	39.08	-5.57	33.51	46.00	-12.49	Peak	105	0
3	665.40	39.01	-3.89	35.12	46.00	-10.88	Peak	105	0
4	788.60	42.90	-0.29	42.61	46.00	-3.39	QP	105	0
5	833.40	37.95	1.78	39.73	46.00	-6.27	Peak	105	0
6	931.40	35.57	2.41	37.98	46.00	-8.02	Peak	105	0

Remarks: 1. Result = Read Value + Factor
 2. Factor = Antenna Factor + Cable Loss - Amplifier
 3. According to technical experiences, all spurious emission of FM mode at channel 0,39,78 are almost the same below 1GHz, so that the channel 0 was chosen as representative in final test.
 4. The data is worst case.



Power	: AC 120V	Pol/Phase	: VERTICAL
Test Mode	: Transmit / Receive	Temperature	: 26 °C
Operation Channel	: 0	Humidity	: 60 %
Modulation Type	: $\pi/4$ -DQPSK	Atmospheric Pressure	: 1007 hPa
Memo	:	Rate	: 2 Mbps

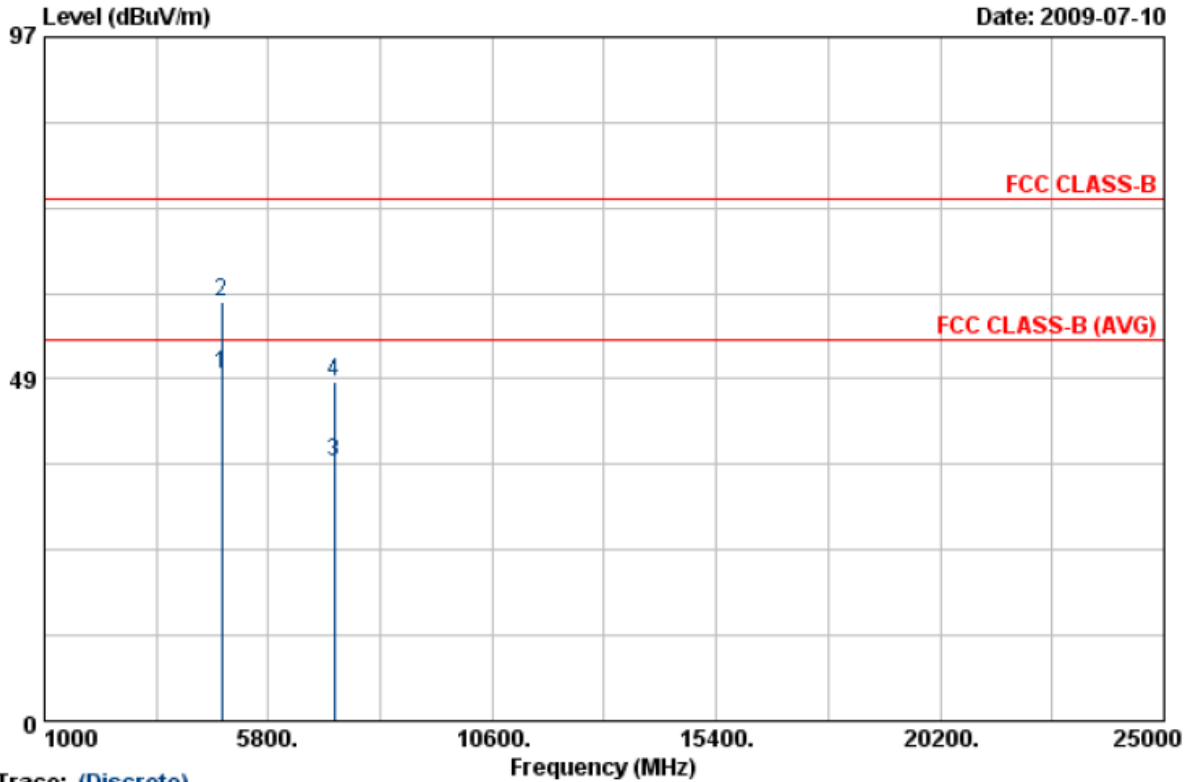

Trace: (Discrete)

Item	Freq	Read Value	Factor	Result	Limit	Margin	Remark	Ant Pos	Tab Pos
	MHz	dBuV/m	dB	dBuV/m	dBuV/m	dB		cm	Deg
1	4803.98	46.71	2.51	49.22	54.00	-4.78	Average	119	240
2	4803.98	56.95	2.51	59.46	74.00	-14.54	Peak	119	240
3	7205.98	29.75	6.87	36.62	54.00	-17.38	Average	119	240
4	7205.98	41.19	6.87	48.06	74.00	-25.94	Peak	119	240

Notes:

1. Result = Read Value + Factor
2. Factor = Antenna Factor + Cable Loss - Amplifier
3. The resolution bandwidth of test receiver/spectrum analyzer is 120KHz and video bandwidth is 300kHz for Peak detection and Quasi-peak detection at frequency below 1GHz.
4. The resolution bandwidth of test receiver/spectrum analyzer is 1MHz and video bandwidth is 3MHz for Peak detection at frequency above 1GHz.
5. The resolution bandwidth of test receiver/spectrum analyzer is 1MHz and video bandwidth is 10Hz for Average detection at frequency above 1GHz.
6. The other emissions is too low to be measured.



Power	: AC 120V	Pol/Phase	: VERTICAL
Test Mode	: Transmit / Receive	Temperature	: 26 °C
Operation Channel	: 0	Humidity	: 60 %
Modulation Type	: $\pi/4$ -DQPSK	Atmospheric Pressure	: 1007 hPa
Memo	:	Rate	: 2 Mbps

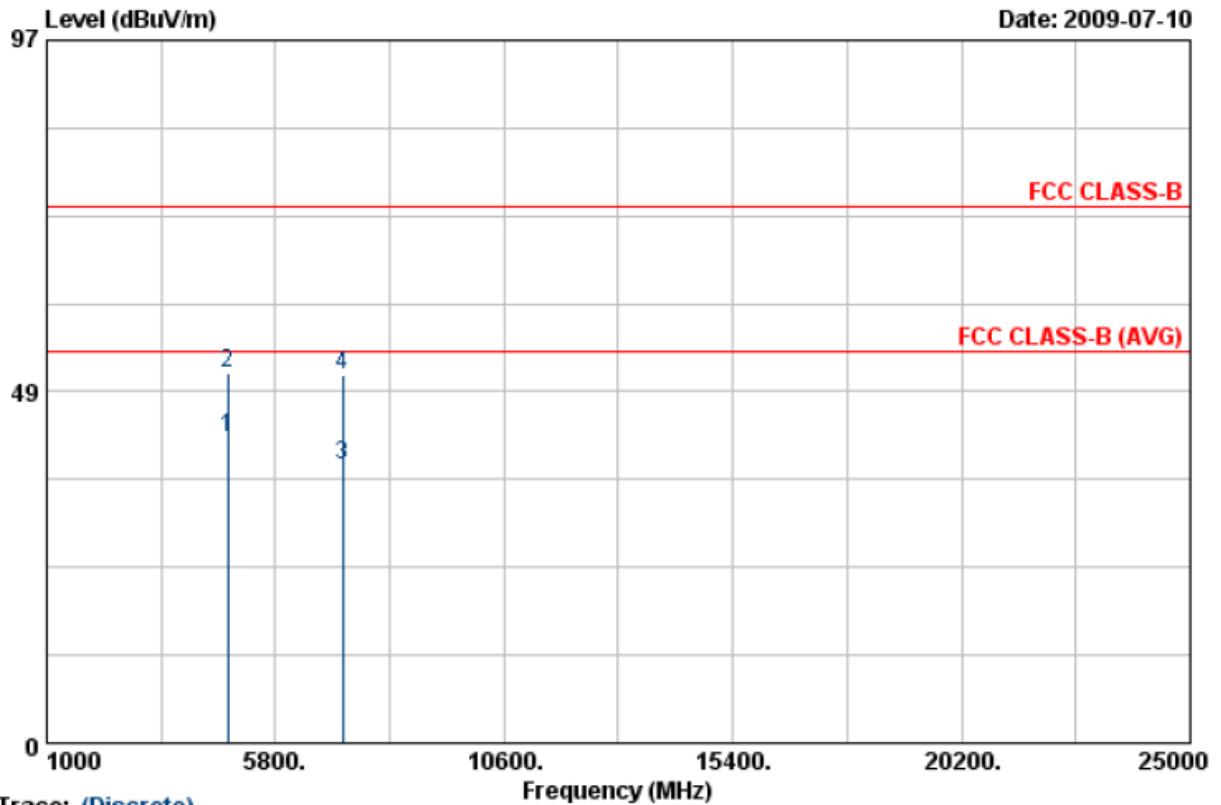

Trace: (Discrete)

Item	Freq	Read Value	Factor	Result	Limit	Margin	Remark	Ant Pos	Tab Pos
	MHz	dBuV/m	dB	dBuV/m	dBuV/m	dB		cm	Deg
1	4804.00	39.73	2.51	42.24	54.00	-11.76	Average	150	250
2	4804.00	48.60	2.51	51.11	74.00	-22.89	Peak	150	250
3	7206.03	31.48	6.87	38.35	54.00	-15.65	Average	150	250
4	7206.03	43.81	6.87	50.68	74.00	-23.32	Peak	150	250

Notes:

1. Result = Read Value + Factor
2. Factor = Antenna Factor + Cable Loss - Amplifier
3. The resolution bandwidth of test receiver/spectrum analyzer is 120KHz and video bandwidth is 300kHz for Peak detection and Quasi-peak detection at frequency below 1GHz.
4. The resolution bandwidth of test receiver/spectrum analyzer is 1MHz and video bandwidth is 3MHz for Peak detection at frequency above 1GHz.
5. The resolution bandwidth of test receiver/spectrum analyzer is 1MHz and video bandwidth is 10Hz for Average detection at frequency above 1GHz.
6. The other emissions is too low to be measured.



Power	: AC 120V	Pol/Phase	: VERTICAL
Test Mode	: Transmit / Receive	Temperature	: 26 °C
Operation Channel	: 39	Humidity	: 60 %
Modulation Type	: $\pi/4$ -DQPSK	Atmospheric Pressure	: 1007 hPa
Memo	:	Rate	: 2 Mbps

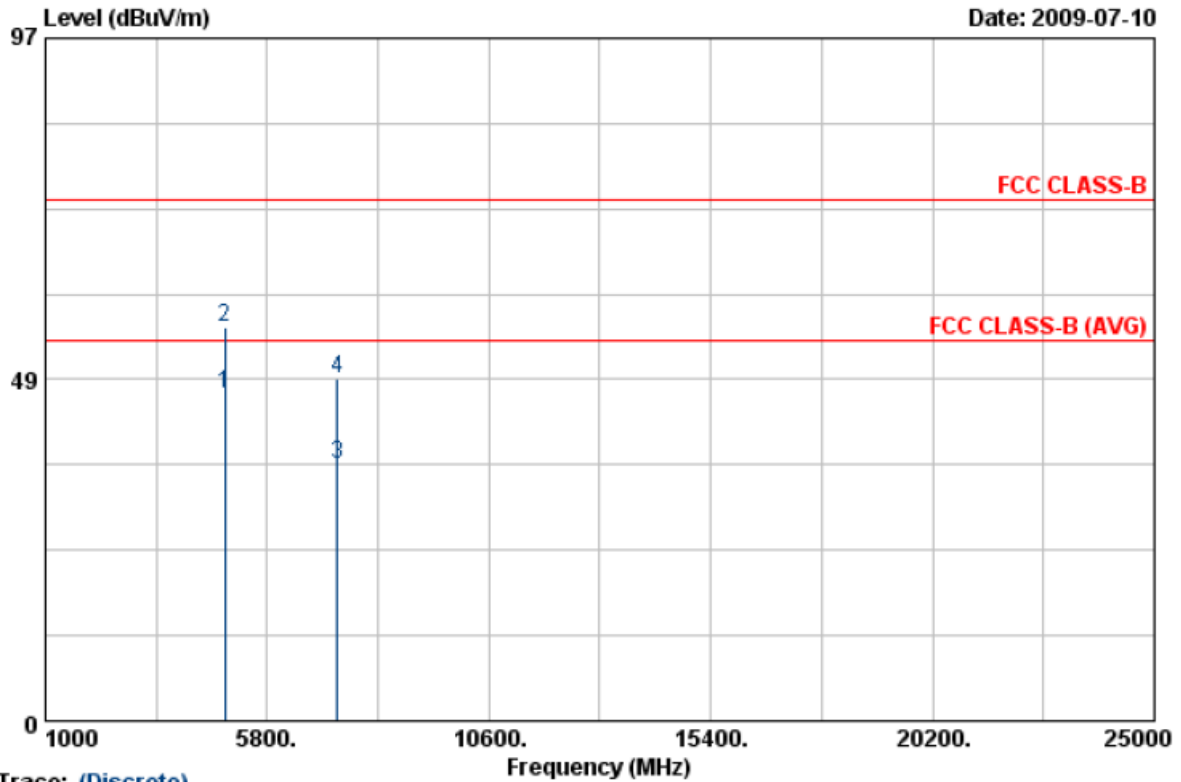

Trace: (Discrete)

Item	Freq	Read Value	Factor	Result	Limit	Margin	Remark	Ant Pos	Tab Pos
	MHz	dBuV/m	dB	dBuV/m	dBuV/m	dB		cm	Deg
1	4882.00	43.76	2.72	46.48	54.00	-7.52	Average	119	240
2	4882.00	53.30	2.72	56.02	74.00	-17.98	Peak	119	240
3	7323.03	29.28	7.23	36.51	54.00	-17.49	Average	119	240
4	7323.03	41.43	7.23	48.66	74.00	-25.34	Peak	119	240

Notes:

1. Result = Read Value + Factor
2. Factor = Antenna Factor + Cable Loss - Amplifier
3. The resolution bandwidth of test receiver/spectrum analyzer is 120KHz and video bandwidth is 300kHz for Peak detection and Quasi-peak detection at frequency below 1GHz.
4. The resolution bandwidth of test receiver/spectrum analyzer is 1MHz and video bandwidth is 3MHz for Peak detection at frequency above 1GHz.
5. The resolution bandwidth of test receiver/spectrum analyzer is 1MHz and video bandwidth is 10Hz for Average detection at frequency above 1GHz.
6. The other emissions is too low to be measured.



Power	: AC 120V	Pol/Phase	: HORIZONTAL
Test Mode	: Transmit / Receive	Temperature	: 26 °C
Operation Channel	: 39	Humidity	: 60 %
Modulation Type	: $\pi/4$ -DQPSK	Atmospheric Pressure	: 1007 hPa
Memo	:	Rate	: 2 Mbps

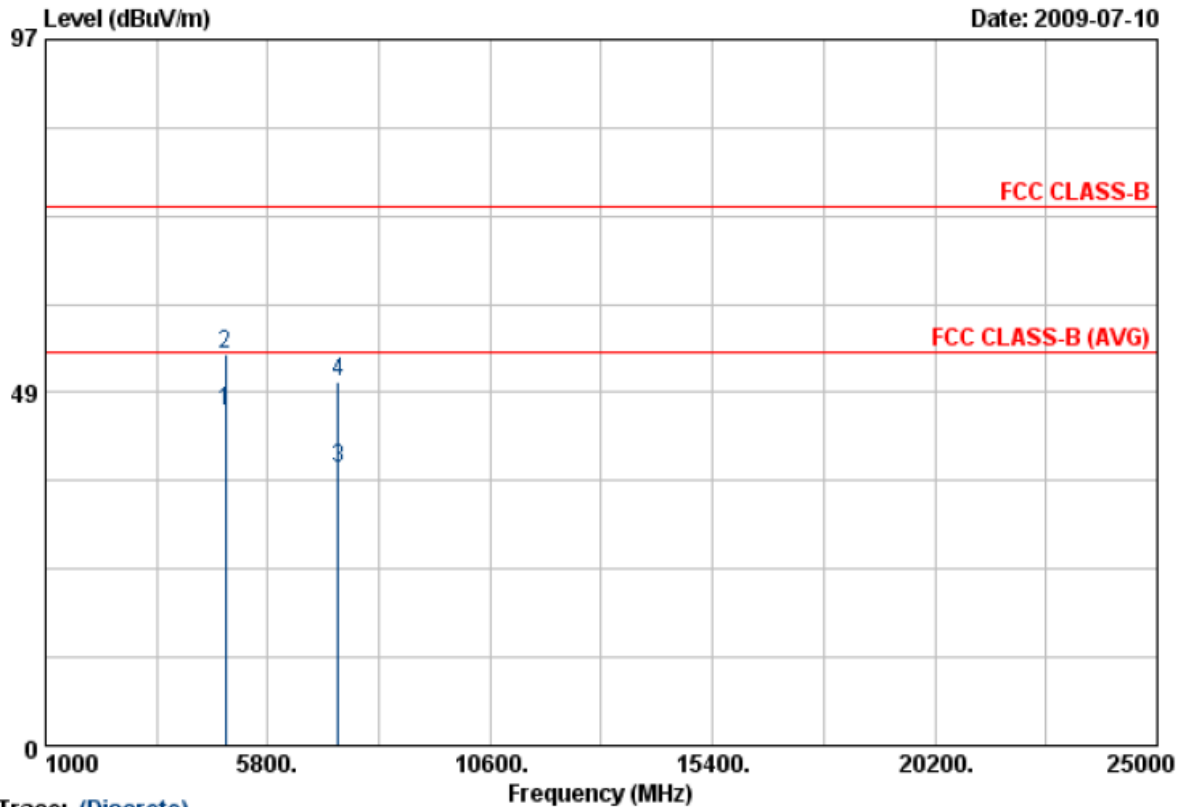

Trace: (Discrete)

Item	Freq	Read Value	Factor	Result	Limit	Margin	Remark	Ant Pos	Tab Pos
	MHz	dBuV/m	dB	dBuV/m	dBuV/m	dB		cm	Deg
1	4882.03	43.26	2.72	45.98	54.00	-8.02	Average	150	250
2	4882.03	51.18	2.72	53.90	74.00	-20.10	Peak	150	250
3	7323.15	30.83	7.23	38.06	54.00	-15.94	Average	150	250
4	7323.15	42.85	7.23	50.08	74.00	-23.92	Peak	150	250

Notes:

1. Result = Read Value + Factor
2. Factor = Antenna Factor + Cable Loss - Amplifier
3. The resolution bandwidth of test receiver/spectrum analyzer is 120KHz and video bandwidth is 300kHz for Peak detection and Quasi-peak detection at frequency below 1GHz.
4. The resolution bandwidth of test receiver/spectrum analyzer is 1MHz and video bandwidth is 3MHz for Peak detection at frequency above 1GHz.
5. The resolution bandwidth of test receiver/spectrum analyzer is 1MHz and video bandwidth is 10Hz for Average detection at frequency above 1GHz.
6. The other emissions is too low to be measured.



Power	: AC 120V	Pol/Phase	: VERTICAL
Test Mode	: Transmit / Receive	Temperature	: 26 °C
Operation Channel	: 78	Humidity	: 60 %
Modulation Type	: $\pi/4$ -DQPSK	Atmospheric Pressure	: 1007 hPa
Memo	:	Rate	: 2 Mbps

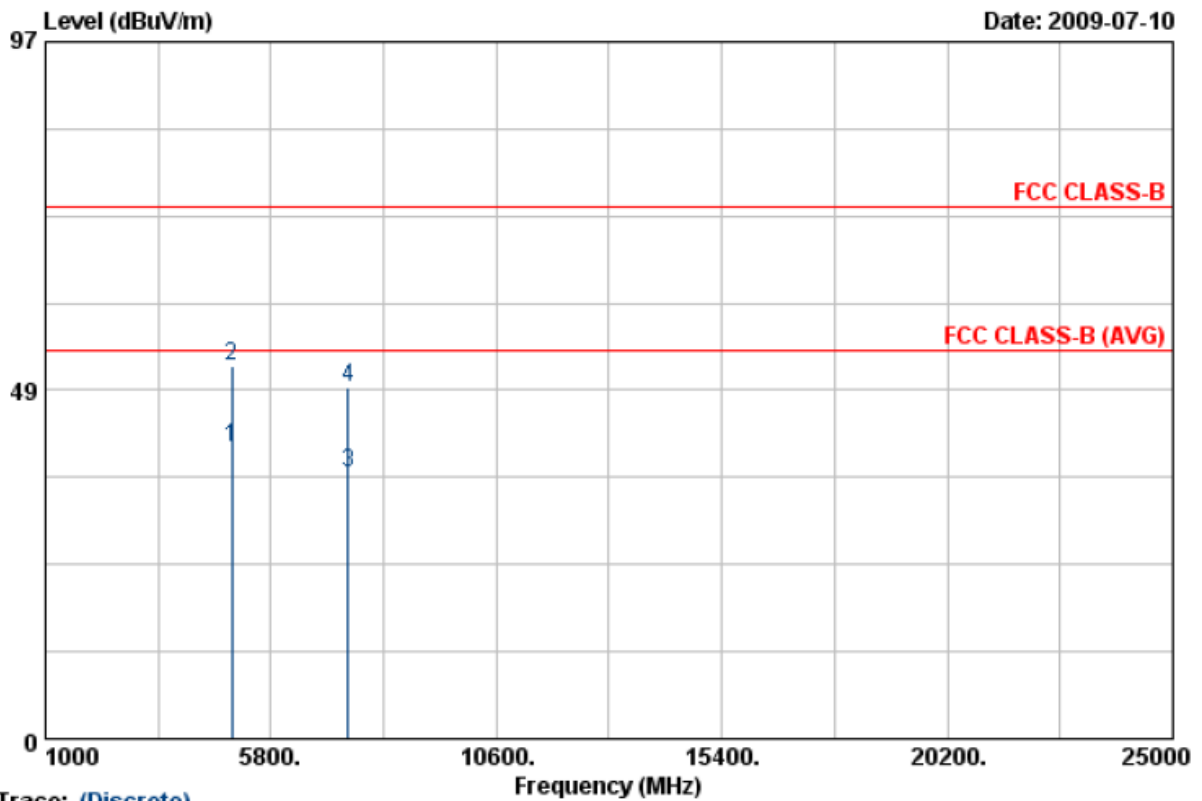

Item	Freq	Read Value	Factor	Result	Limit	Margin	Remark	Ant Pos	Tab Pos
	MHz	dBuV/m	dB	dBuV/m	dBuV/m	dB		cm	Deg
1	4960.00	37.52	2.92	40.44	54.00	-13.56	Average	119	240
2	4960.00	49.07	2.92	51.99	74.00	-22.01	Peak	119	240
3	7442.50	29.45	7.60	37.05	54.00	-16.95	Average	119	240
4	7442.50	41.26	7.60	48.86	74.00	-25.14	Peak	119	240

Notes:

1. Result = Read Value + Factor
2. Factor = Antenna Factor + Cable Loss - Amplifier
3. The resolution bandwidth of test receiver/spectrum analyzer is 120KHz and video bandwidth is 300kHz for Peak detection and Quasi-peak detection at frequency below 1GHz.
4. The resolution bandwidth of test receiver/spectrum analyzer is 1MHz and video bandwidth is 3MHz for Peak detection at frequency above 1GHz.
5. The resolution bandwidth of test receiver/spectrum analyzer is 1MHz and video bandwidth is 10Hz for Average detection at frequency above 1GHz.
6. The other emissions is too low to be measured.



Power	: AC 120V	Pol/Phase	: HORIZONTAL
Test Mode	: Transmit / Receive	Temperature	: 26 °C
Operation Channel	: 78	Humidity	: 60 %
Modulation Type	: $\pi/4$ -DQPSK	Atmospheric Pressure	: 1007 hPa
Memo	:	Rate	: 2 Mbps

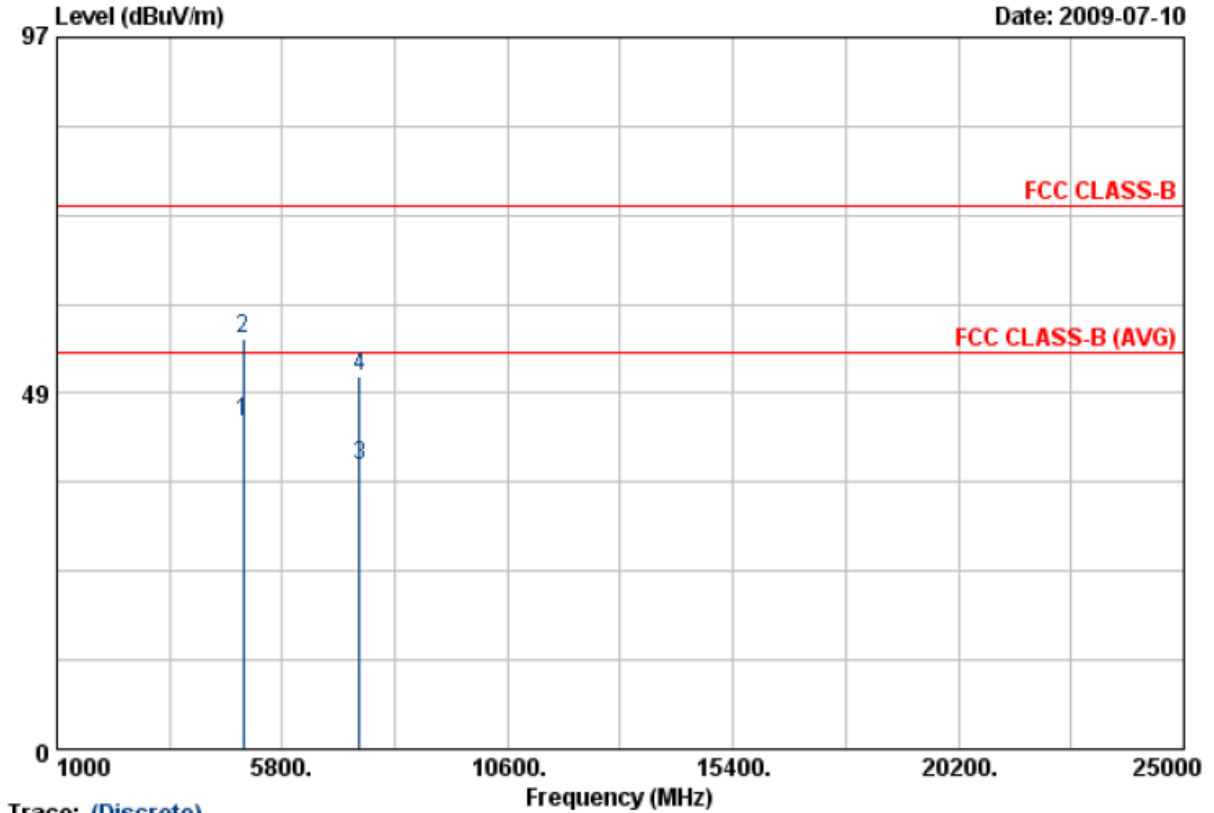

Trace: (Discrete)

Item	Freq	Read Value	Factor	Result	Limit	Margin	Remark	Ant Pos	Tab Pos
	MHz	dBuV/m	dB	dBuV/m	dBuV/m	dB		cm	Deg
1	4959.98	41.77	2.92	44.69	54.00	-9.31	Average	150	250
2	4959.98	53.05	2.92	55.97	74.00	-18.03	Peak	150	250
3	7442.50	31.03	7.60	38.63	54.00	-15.37	Average	150	250
4	7442.50	43.19	7.60	50.79	74.00	-23.21	Peak	150	250

Notes:

1. Result = Read Value + Factor
2. Factor = Antenna Factor + Cable Loss - Amplifier
3. The resolution bandwidth of test receiver/spectrum analyzer is 120KHz and video bandwidth is 300kHz for Peak detection and Quasi-peak detection at frequency below 1GHz.
4. The resolution bandwidth of test receiver/spectrum analyzer is 1MHz and video bandwidth is 3MHz for Peak detection at frequency above 1GHz.
5. The resolution bandwidth of test receiver/spectrum analyzer is 1MHz and video bandwidth is 10Hz for Average detection at frequency above 1GHz.
6. The other emissions is too low to be measured.



Power	: AC 120V	Pol/Phase	: VERTICAL
Test Mode	: Transmit / Receive	Temperature	: 27 °C
Operation Channel	: 0	Humidity	: 55 %
Modulation Type	: 8DPSK	Atmospheric Pressure	: 1021 hPa
Memo	:	Rate	: 3 Mbps

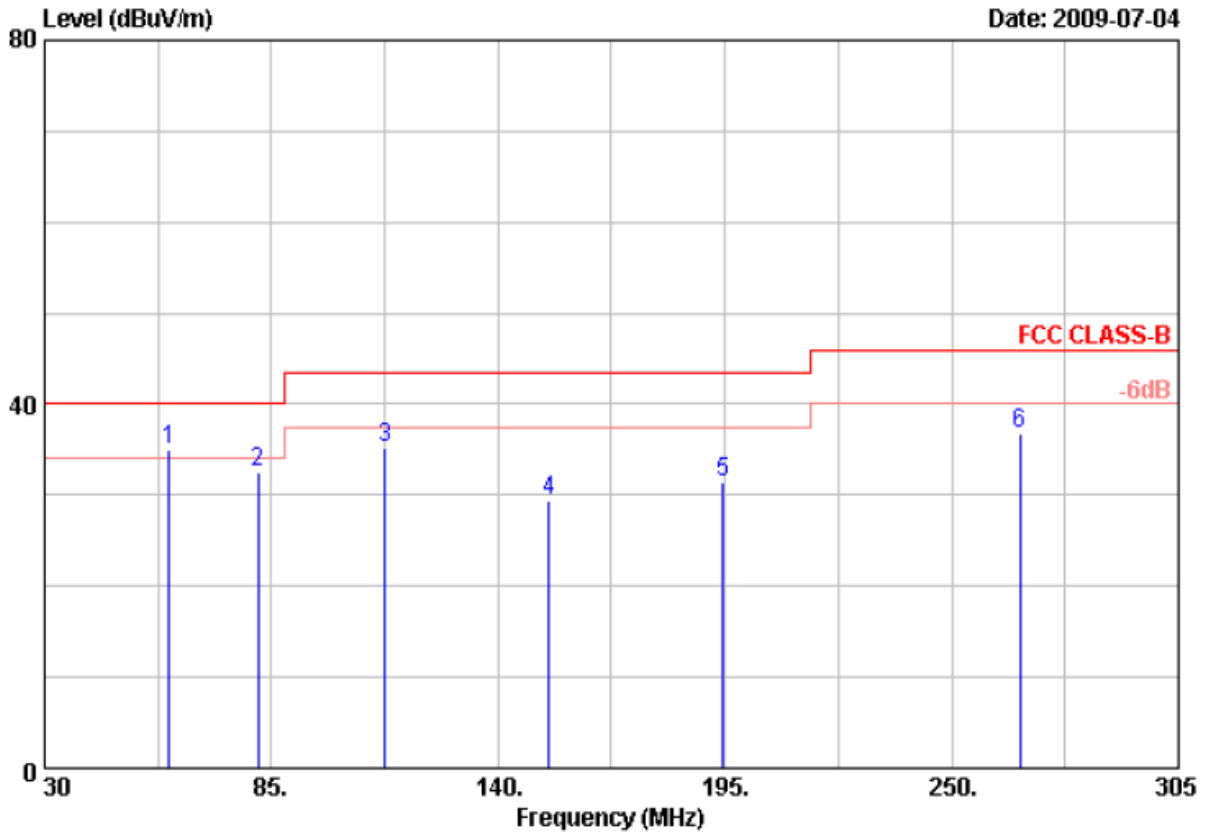

Item	Freq	Read Value	Factor	Result	Limit	Margin	Remark	Ant Pos	Tab Pos
	MHz	dBuV/m	dB	dBuV/m	dBuV/m	dB		cm	Deg
1	60.25	47.87	-12.85	35.02	40.00	-4.98	QP	105	360
2	81.70	46.61	-14.08	32.53	40.00	-7.47	Peak	105	360
3	112.50	45.80	-10.65	35.15	43.50	-8.35	Peak	105	360
4	152.38	40.90	-11.39	29.51	43.50	-13.99	Peak	105	360
5	194.45	41.82	-10.36	31.46	43.50	-12.04	Peak	105	360
6	266.50	49.39	-12.51	36.88	46.00	-9.12	Peak	105	360

Remarks: 1. Result = Read Value + Factor
 2. Factor = Antenna Factor + Cable Loss - Amplifier
 3. According to technical experiences, all spurious emission of FM mode at channel 0,39,78 are almost the same below 1GHz, so that the channel 0 was chosen as representative in final test.
 4. The data is worst case.



Power	: AC 120V	Pol/Phase	: VERTICAL
Test Mode	: Transmit / Receive	Temperature	: 27 °C
Operation Channel	: 0	Humidity	: 55 %
Modulation Type	: 8DPSK	Atmospheric Pressure	: 1021 hPa
Memo	:	Rate	: 3 Mbps

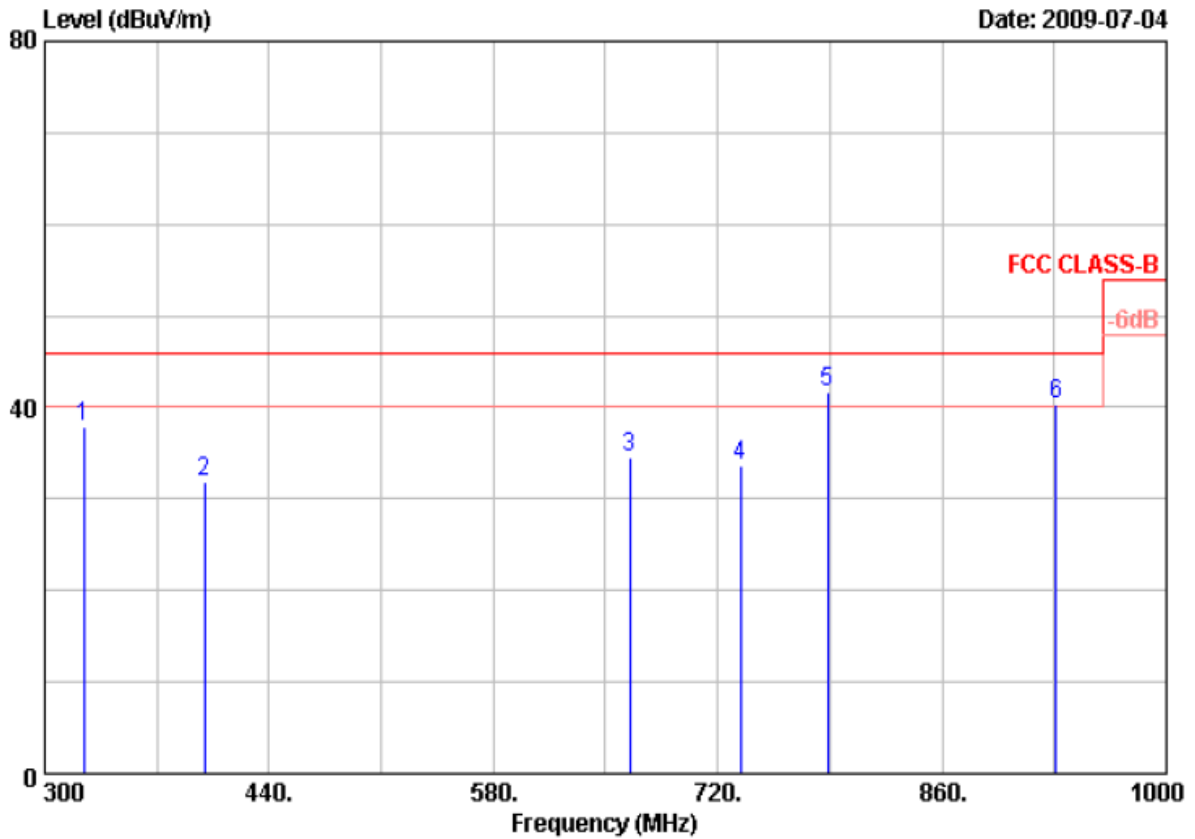

Item	Freq	Read Value	Factor	Result	Limit	Margin	Remark	Ant Pos	Tab Pos
	MHz	dBuV/m	dB	dBuV/m	dBuV/m	dB		cm	Deg
1	324.50	47.59	-9.78	37.81	46.00	-8.19	Peak	105	0
2	399.40	38.83	-6.97	31.86	46.00	-14.14	Peak	105	0
3	665.40	38.72	-4.22	34.50	46.00	-11.50	Peak	105	0
4	734.00	34.42	-0.84	33.58	46.00	-12.42	Peak	105	0
5	788.60	43.65	-1.97	41.68	46.00	-4.32	QP	105	0
6	931.40	35.57	4.75	40.32	46.00	-5.68	QP	105	0

- Remarks:
1. Result = Read Value + Factor
 2. Factor = Antenna Factor + Cable Loss - Amplifier
 3. According to technical experiences, all spurious emission of FM mode at channel 0,39,78 are almost the same below 1GHz, so that the channel 0 was chosen as representative in final test.
 4. The data is worst case.



Power	: AC 120V	Pol/Phase	: HORIZONTAL
Test Mode	: Transmit / Receive	Temperature	: 27 °C
Operation Channel	: 0	Humidity	: 55 %
Modulation Type	: 8DPSK	Atmospheric Pressure	: 1021 hPa
Memo	:	Rate	: 3 Mbps

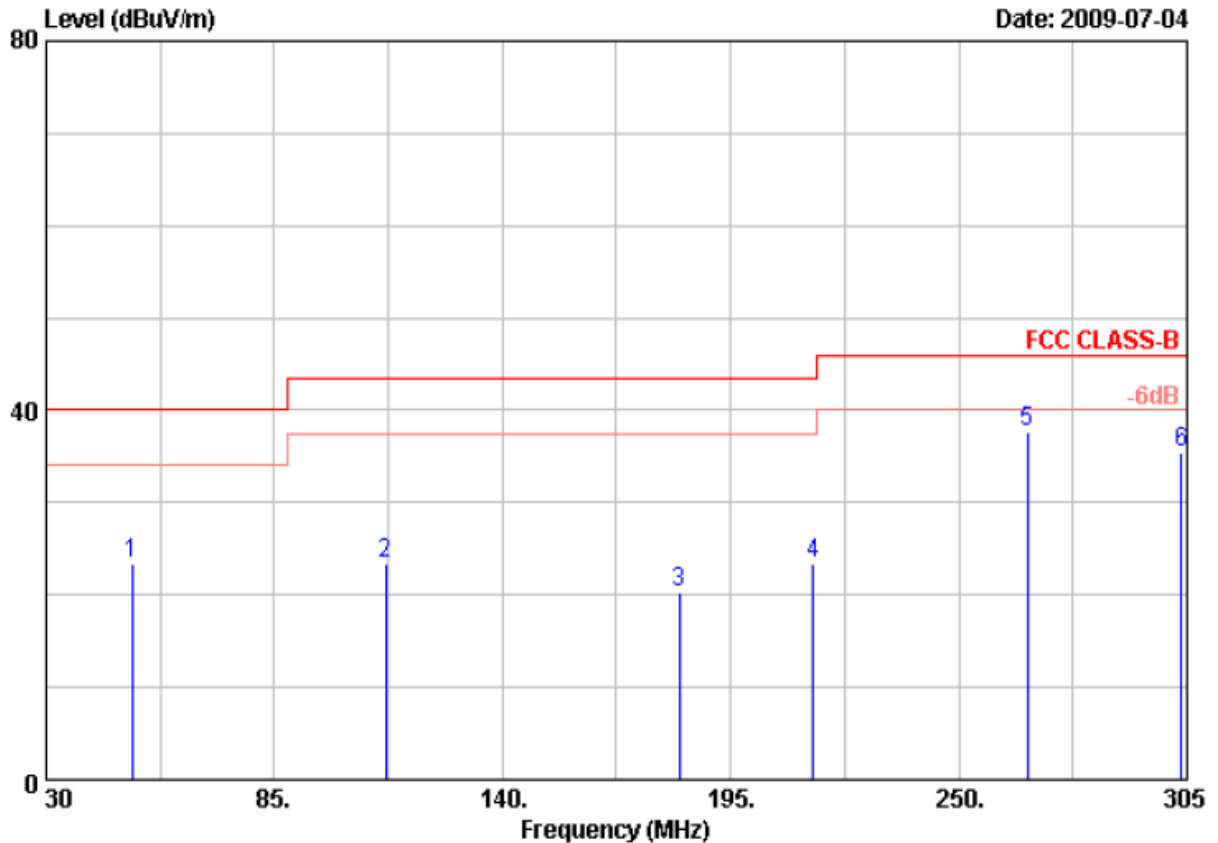

Item	Freq	Read Value	Factor	Result	Limit	Margin	Remark	Ant Pos	Tab Pos
	MHz	dBuV/m	dB	dBuV/m	dBuV/m	dB		cm	Deg
1	50.63	38.00	-14.64	23.36	40.00	-16.64	Peak	105	360
2	111.95	41.02	-17.72	23.30	43.50	-20.20	Peak	105	360
3	182.63	37.52	-17.30	20.22	43.50	-23.28	Peak	105	360
4	214.80	40.06	-16.59	23.47	43.50	-20.03	Peak	105	360
5	266.50	51.16	-13.58	37.58	46.00	-8.42	Peak	105	360
6	303.63	47.89	-12.37	35.52	46.00	-10.48	Peak	105	360

Remarks: 1. Result = Read Value + Factor
 2. Factor = Antenna Factor + Cable Loss - Amplifier
 3. According to technical experiences, all spurious emission of FM mode at channel 0,39,78 are almost the same below 1GHz, so that the channel 0 was chosen as representative in final test.
 4. The data is worst case.



Power	: AC 120V	Pol/Phase	: HORIZONTAL
Test Mode	: Transmit / Receive	Temperature	: 27 °C
Operation Channel	: 0	Humidity	: 55 %
Modulation Type	: 8DPSK	Atmospheric Pressure	: 1021 hPa
Memo	:	Rate	: 3 Mbps

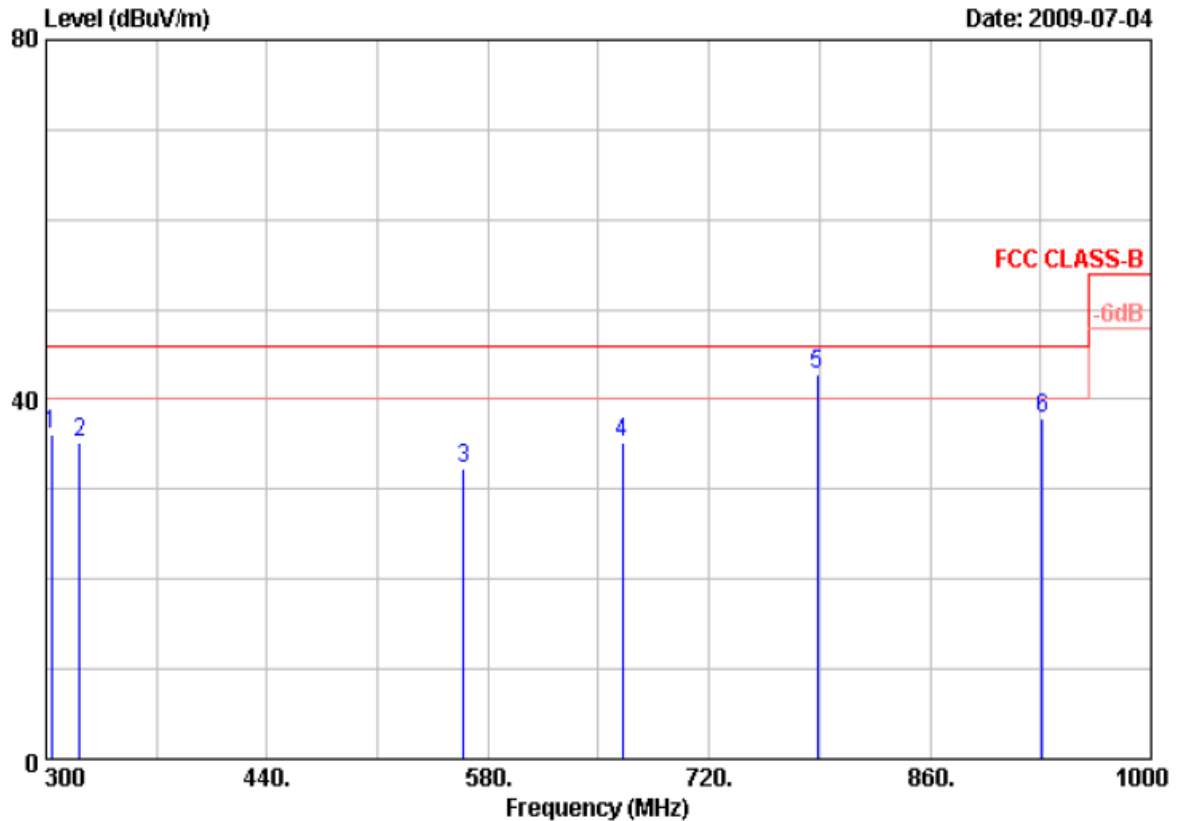

Item	Freq	Read Value	Factor	Result	Limit	Margin	Remark	Ant Pos	Tab Pos
	MHz	dBuV/m	dB	dBuV/m	dBuV/m	dB		cm	Deg
1	303.50	48.48	-12.39	36.09	46.00	-9.91	Peak	105	0
2	321.00	46.95	-11.82	35.13	46.00	-10.87	Peak	105	0
3	564.60	33.94	-1.64	32.30	46.00	-13.70	Peak	105	0
4	665.40	39.08	-3.89	35.19	46.00	-10.81	Peak	105	0
5	788.60	42.99	-0.29	42.70	46.00	-3.30	QP	105	0
6	931.40	35.58	2.41	37.99	46.00	-8.01	Peak	105	0

- Remarks:
1. Result = Read Value + Factor
 2. Factor = Antenna Factor + Cable Loss - Amplifier
 3. According to technical experiences, all spurious emission of FM mode at channel 0,39,78 are almost the same below 1GHz, so that the channel 0 was chosen as representative in final test.
 4. The data is worst case.



Power	: AC 120V	Pol/Phase	: VERTICAL
Test Mode	: Transmit / Receive	Temperature	: 26 °C
Operation Channel	: 0	Humidity	: 60 %
Modulation Type	: 8DPSK	Atmospheric Pressure	: 1007 hPa
Memo	:	Rate	: 3 Mbps

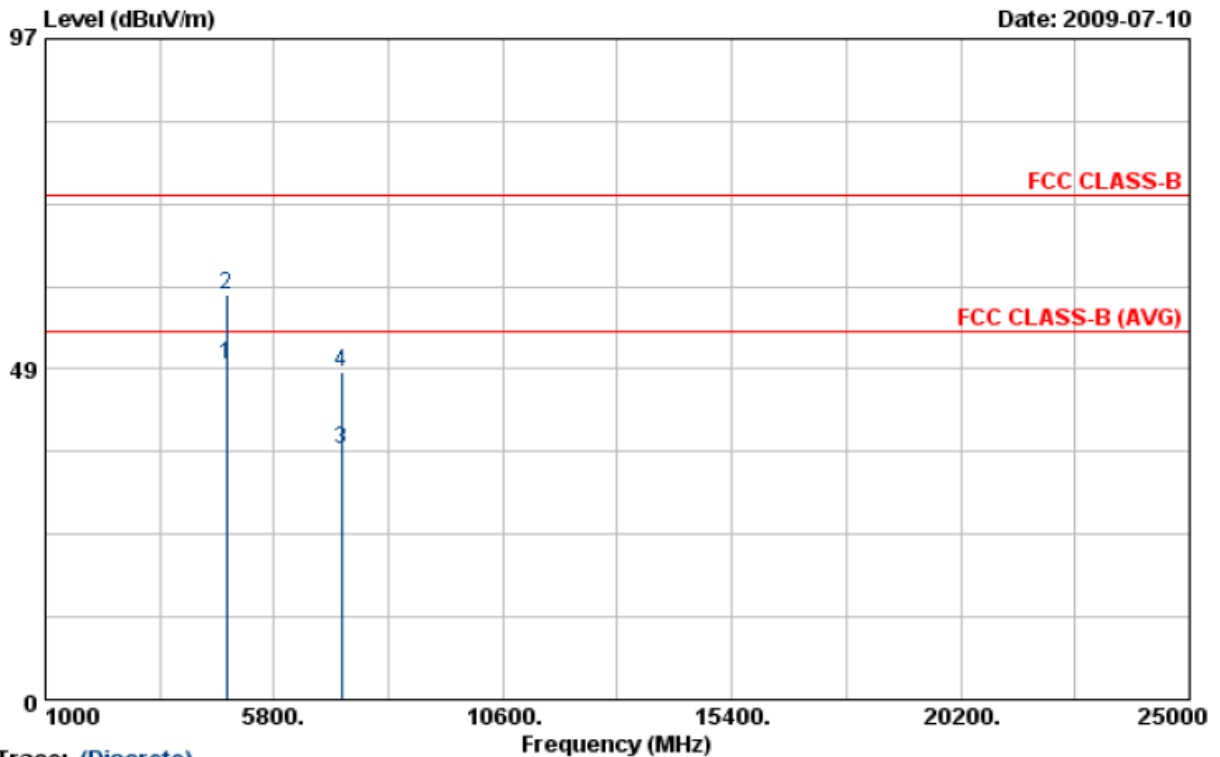

Trace: (Discrete)

Item	Freq	Read Value	Factor	Result	Limit	Margin	Remark	Ant Pos	Tab Pos
	MHz	dBuV/m	dB	dBuV/m	dBuV/m	dB		cm	Deg
1	4804.00	46.79	2.51	49.30	54.00	-4.70	Average	119	240
2	4804.00	56.86	2.51	59.37	74.00	-14.63	Peak	119	240
3	7206.15	29.76	6.87	36.63	54.00	-17.37	Average	119	240
4	7206.15	41.14	6.87	48.01	74.00	-25.99	Peak	119	240

Notes:

1. Result = Read Value + Factor
2. Factor = Antenna Factor + Cable Loss - Amplifier
3. The resolution bandwidth of test receiver/spectrum analyzer is 120KHz and video bandwidth is 300kHz for Peak detection and Quasi-peak detection at frequency below 1GHz.
4. The resolution bandwidth of test receiver/spectrum analyzer is 1MHz and video bandwidth is 3MHz for Peak detection at frequency above 1GHz.
5. The resolution bandwidth of test receiver/spectrum analyzer is 1MHz and video bandwidth is 10Hz for Average detection at frequency above 1GHz.
6. The other emissions is too low to be measured.



Power	: AC 120V	Pol/Phase	: HORIZONTAL
Test Mode	: Transmit / Receive	Temperature	: 26 °C
Operation Channel	: 0	Humidity	: 60 %
Modulation Type	: 8DPSK	Atmospheric Pressure	: 1007 hPa
Memo	:	Rate	: 3 Mbps

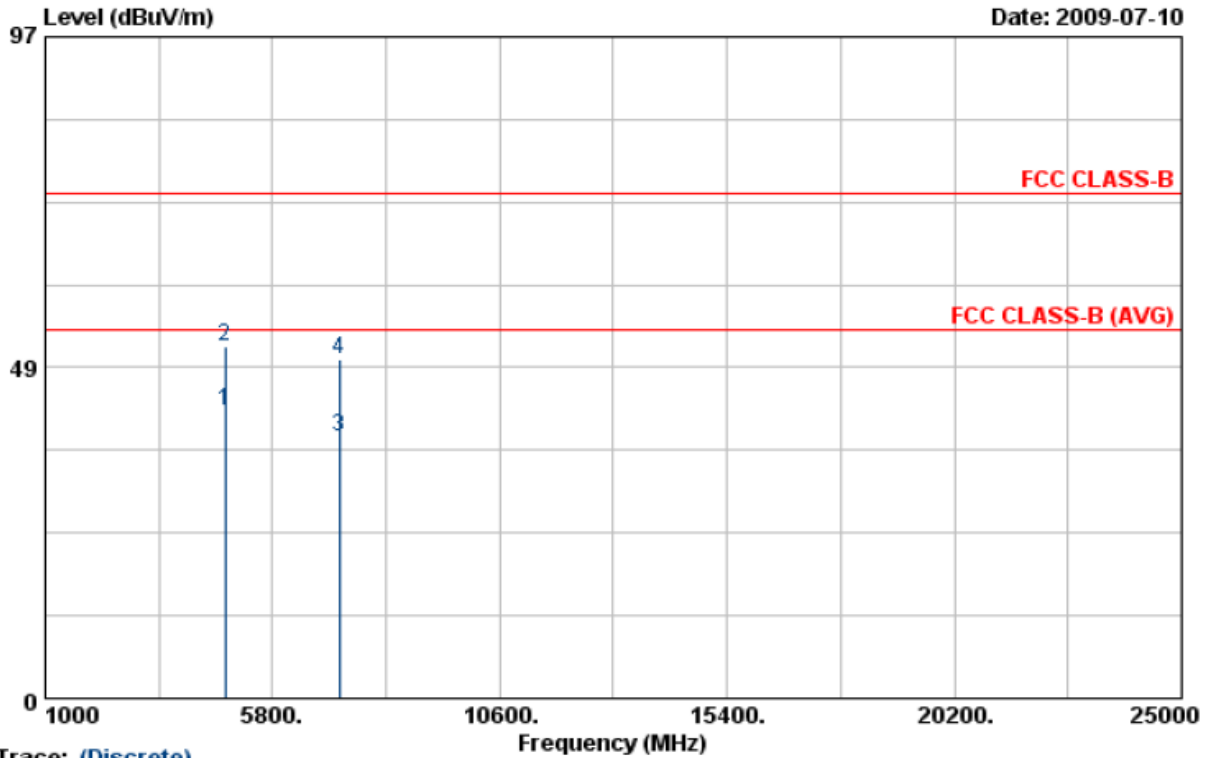

Trace: (Discrete)

Item	Freq	Read Value	Factor	Result	Limit	Margin	Remark	Ant Pos	Tab Pos
	MHz	dBUV/m	dB	dBUV/m	dBUV/m	dB		cm	Deg
1	4804.00	39.63	2.51	42.14	54.00	-11.86	Average	150	250
2	4804.00	49.04	2.51	51.55	74.00	-22.45	Peak	150	250
3	7205.83	31.43	6.87	38.30	54.00	-15.70	Average	150	250
4	7205.83	42.97	6.87	49.84	74.00	-24.16	Peak	150	250

Notes:

1. Result = Read Value + Factor
2. Factor = Antenna Factor + Cable Loss - Amplifier
3. The resolution bandwidth of test receiver/spectrum analyzer is 120KHz and video bandwidth is 300kHz for Peak detection and Quasi-peak detection at frequency below 1GHz.
4. The resolution bandwidth of test receiver/spectrum analyzer is 1MHz and video bandwidth is 3MHz for Peak detection at frequency above 1GHz.
5. The resolution bandwidth of test receiver/spectrum analyzer is 1MHz and video bandwidth is 10Hz for Average detection at frequency above 1GHz.
6. The other emissions is too low to be measured.



Power	: AC 120V	Pol/Phase	: VERTICAL
Test Mode	: Transmit / Receive	Temperature	: 26 °C
Operation Channel	: 39	Humidity	: 60 %
Modulation Type	: 8DPSK	Atmospheric Pressure	: 1007 hPa
Memo	:	Rate	: 3 Mbps

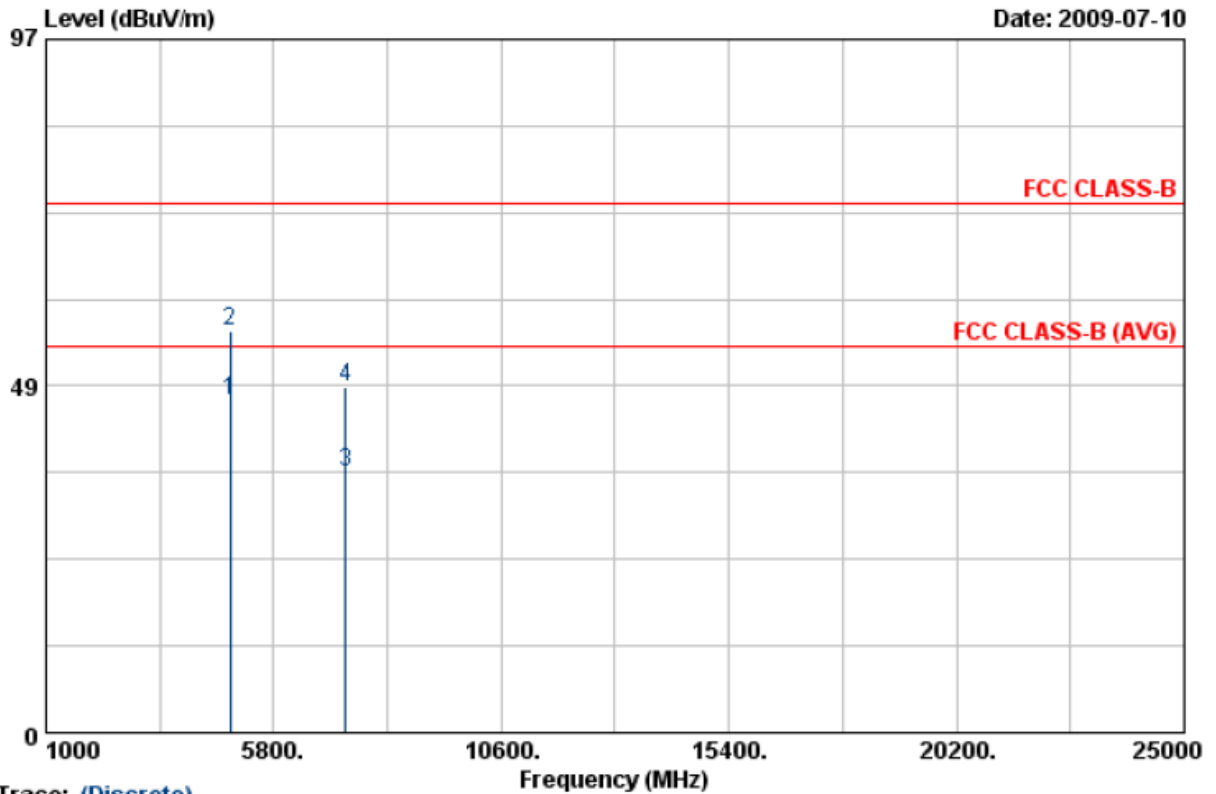

Trace: (Discrete)

Item	Freq	Read Value	Factor	Result	Limit	Margin	Remark	Ant Pos	Tab Pos
	MHz	dBuV/m	dB	dBuV/m	dBuV/m	dB		cm	Deg
1	4881.98	43.80	2.72	46.52	54.00	-7.48	Average	119	240
2	4881.98	53.60	2.72	56.32	74.00	-17.68	Peak	119	240
3	7322.98	29.23	7.23	36.46	54.00	-17.54	Average	119	240
4	7322.98	41.09	7.23	48.32	74.00	-25.68	Peak	119	240

Notes:

1. Result = Read Value + Factor
2. Factor = Antenna Factor + Cable Loss - Amplifier
3. The resolution bandwidth of test receiver/spectrum analyzer is 120KHz and video bandwidth is 300kHz for Peak detection and Quasi-peak detection at frequency below 1GHz.
4. The resolution bandwidth of test receiver/spectrum analyzer is 1MHz and video bandwidth is 3MHz for Peak detection at frequency above 1GHz.
5. The resolution bandwidth of test receiver/spectrum analyzer is 1MHz and video bandwidth is 10Hz for Average detection at frequency above 1GHz.
6. The other emissions is too low to be measured.



Power	: AC 120V	Pol/Phase	: HORIZONTAL
Test Mode	: Transmit / Receive	Temperature	: 26 °C
Operation Channel	: 39	Humidity	: 60 %
Modulation Type	: 8DPSK	Atmospheric Pressure	: 1007 hPa
Memo	:	Rate	: 3 Mbps

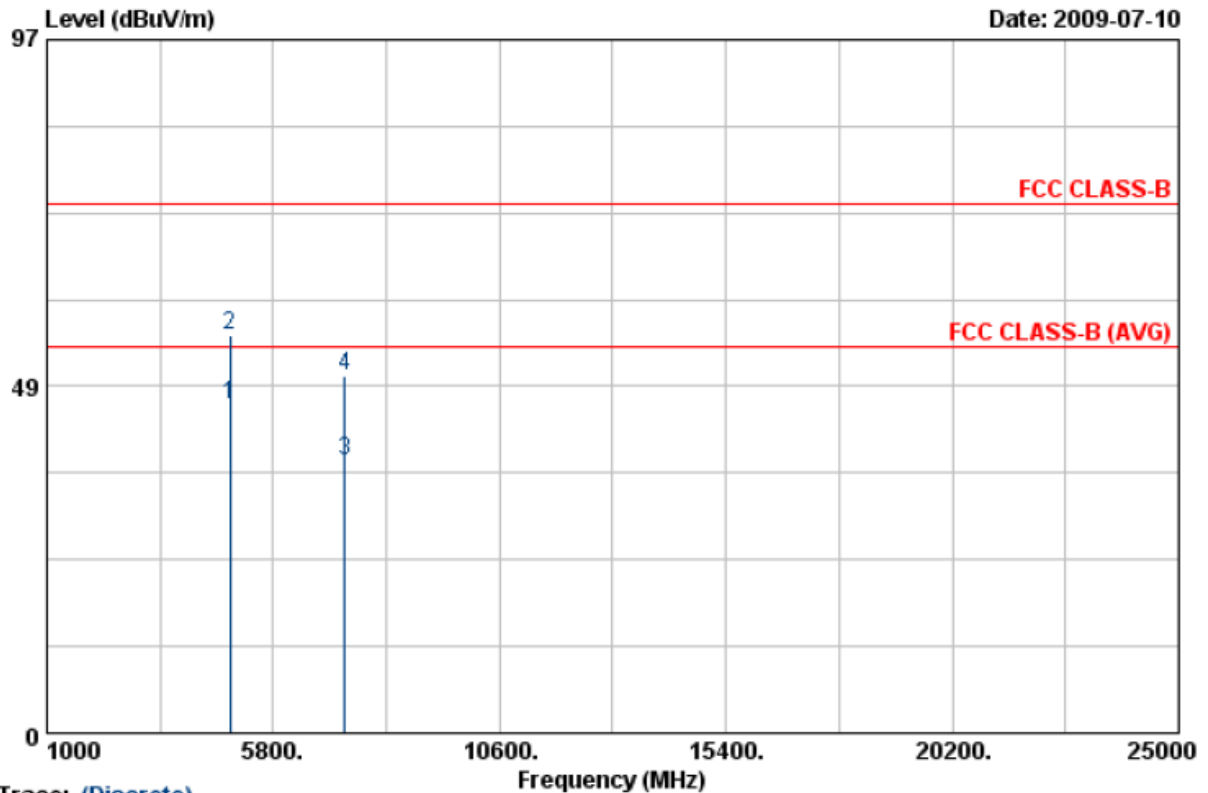

Trace: (Discrete)

Item	Freq	Read Value	Factor	Result	Limit	Margin	Remark	Ant Pos	Tab Pos
	MHz	dBUV/m	dB	dBUV/m	dBUV/m	dB		cm	Deg
1	4882.00	43.11	2.72	45.83	54.00	-8.17	Average	150	250
2	4882.00	53.07	2.72	55.79	74.00	-18.21	Peak	150	250
3	7322.95	30.84	7.23	38.07	54.00	-15.93	Average	150	250
4	7322.95	42.81	7.23	50.04	74.00	-23.96	Peak	150	250

Notes:

1. Result = Read Value + Factor
2. Factor = Antenna Factor + Cable Loss - Amplifier
3. The resolution bandwidth of test receiver/spectrum analyzer is 120KHz and video bandwidth is 300kHz for Peak detection and Quasi-peak detection at frequency below 1GHz.
4. The resolution bandwidth of test receiver/spectrum analyzer is 1MHz and video bandwidth is 3MHz for Peak detection at frequency above 1GHz.
5. The resolution bandwidth of test receiver/spectrum analyzer is 1MHz and video bandwidth is 10Hz for Average detection at frequency above 1GHz.
6. The other emissions is too low to be measured.



Power	: AC 120V	Pol/Phase	: VERTICAL
Test Mode	: Transmit / Receive	Temperature	: 26 °C
Operation Channel	: 78	Humidity	: 60 %
Modulation Type	: 8DPSK	Atmospheric Pressure	: 1007 hPa
Memo	:	Rate	: 3 Mbps

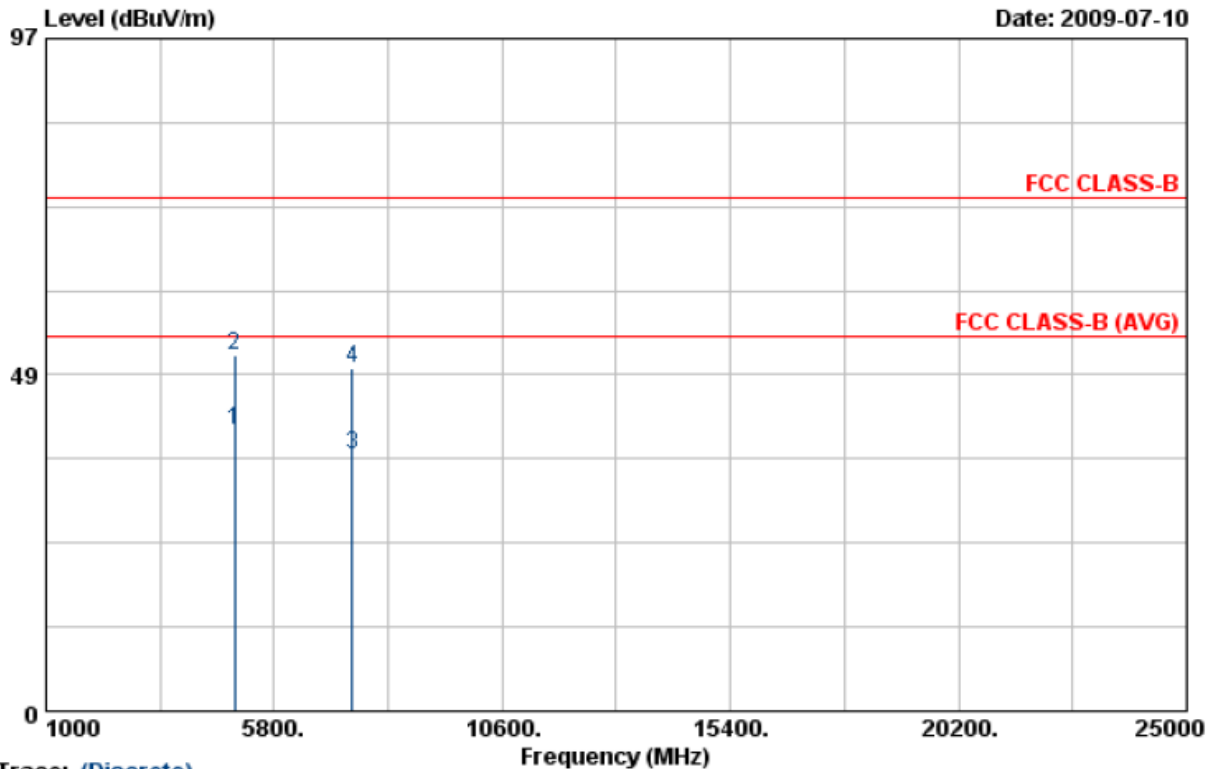

Trace: (Discrete)

Item	Freq	Read Value	Factor	Result	Limit	Margin	Remark	Ant Pos	Tab Pos
	MHz	dBuV/m	dB	dBuV/m	dBuV/m	dB		cm	Deg
1	4960.00	37.52	2.92	40.44	54.00	-13.56	Average	119	240
2	4960.00	48.55	2.92	51.47	74.00	-22.53	Peak	119	240
3	7436.40	29.44	7.57	37.01	54.00	-16.99	Average	119	240
4	7436.40	41.80	7.57	49.37	74.00	-24.63	Peak	119	240

Notes:

1. Result = Read Value + Factor
2. Factor = Antenna Factor + Cable Loss - Amplifier
3. The resolution bandwidth of test receiver/spectrum analyzer is 120KHz and video bandwidth is 300kHz for Peak detection and Quasi-peak detection at frequency below 1GHz.
4. The resolution bandwidth of test receiver/spectrum analyzer is 1MHz and video bandwidth is 3MHz for Peak detection at frequency above 1GHz.
5. The resolution bandwidth of test receiver/spectrum analyzer is 1MHz and video bandwidth is 10Hz for Average detection at frequency above 1GHz.
6. The other emissions is too low to be measured.



Power	: AC 120V	Pol/Phase	: HORIZONTAL
Test Mode	: Transmit / Receive	Temperature	: 26 °C
Operation Channel	: 78	Humidity	: 60 %
Modulation Type	: 8DPSK	Atmospheric Pressure	: 1007 hPa
Memo	:	Rate	: 3 Mbps

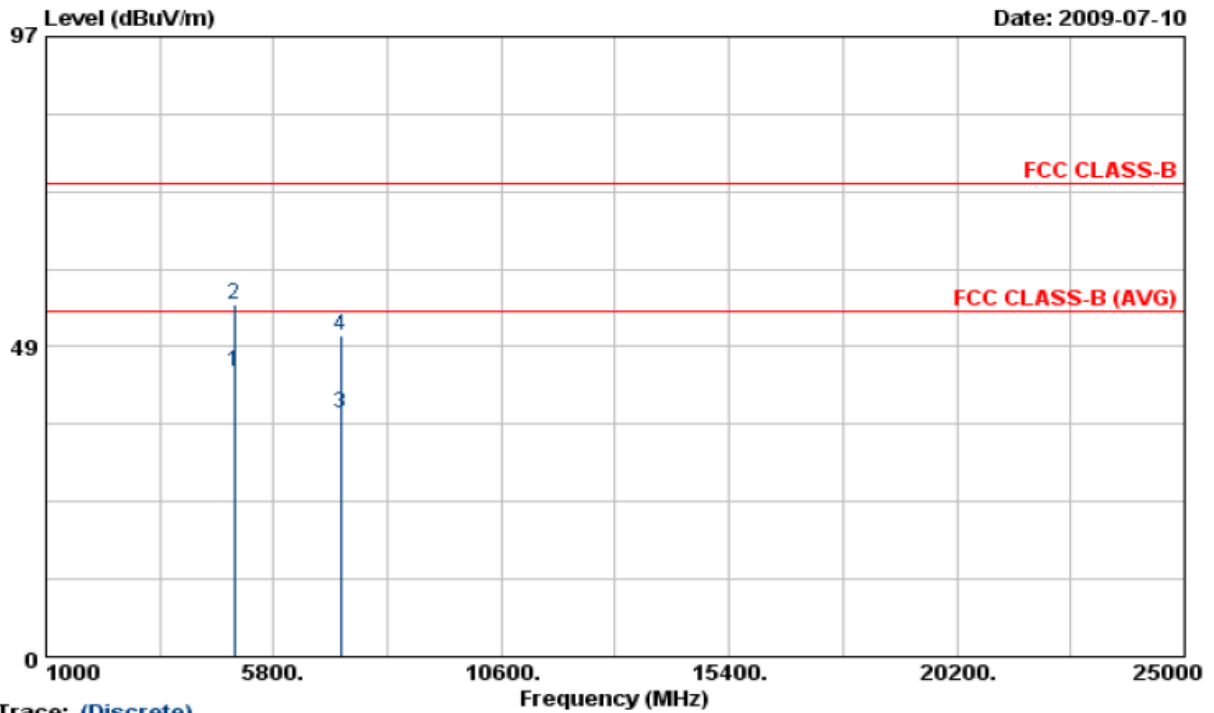

Trace: (Discrete)

Item	Freq	Read Value	Factor	Result	Limit	Margin	Remark	Ant Pos	Tab Pos
	MHz	dBuV/m	dB	dBuV/m	dBuV/m	dB		cm	Deg
1	4960.03	41.56	2.92	44.48	54.00	-9.52	Average	150	250
2	4960.03	52.10	2.92	55.02	74.00	-18.98	Peak	150	250
3	7201.28	31.22	6.85	38.07	54.00	-15.93	Average	150	250
4	7201.28	43.48	6.85	50.33	74.00	-23.67	Peak	150	250

Notes:

1. Result = Read Value + Factor
2. Factor = Antenna Factor + Cable Loss - Amplifier
3. The resolution bandwidth of test receiver/spectrum analyzer is 120kHz and video bandwidth is 300kHz for Peak detection and Quasi-peak detection at frequency below 1GHz.
4. The resolution bandwidth of test receiver/spectrum analyzer is 1MHz and video bandwidth is 3MHz for Peak detection at frequency above 1GHz.
5. The resolution bandwidth of test receiver/spectrum analyzer is 1MHz and video bandwidth is 10Hz for Average detection at frequency above 1GHz.
6. The other emissions is too low to be measured.

Test engineer: Ben



6. 20dB Bandwidth Measurement Data

6.1 Test Limit

Frequency hopping systems shall have hopping channel carrier frequencies separated by a minimum of 25 kHz or the 20 dB bandwidth of the hopping channel, whichever is greater. Alternatively, frequency hopping systems operating in the 2400–2483.5 MHz band may have hopping channel carrier frequencies that are separated by 25 kHz or two-thirds of the 20 dB bandwidth of the hopping channel, whichever is greater, provided the systems operate with an output power no greater than 125 mW.

6.2 Test Procedures

- a. The transmitter output was connected to the spectrum analyzer.
- b. Set RBW of spectrum analyzer to 30 KHz and VBW to 100 KHz.
- c. The 20 dB bandwidth is defined as the total spectrum the power of which is higher than peak power minus 20 dB.

6.3 Test Setup Layout

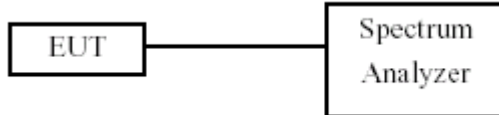

6.4 Measurement equipment

Instrument/Ancillary	Model No.	Manufacturer	Serial No.	Calibration Date	Valid Date
Spectrum Analyzer	FSP40	R&S	10047	2009/03/26	2010/03/25



6.5 Test Result and Data

Modulation Standard: GFSK (1Mbps)

Test Date: Jul. 02, 2009

Temperature: 24°C

Atmospheric pressure: 1012 hPa

Humidity: 57%

Channel	Frequency (MHz)	20dB Bandwidth (KHz)
00	2402	724.00
39	2441	732.00
78	2480	736.00

Modulation Standard: $\pi/4$ -DQPSK (2Mbps)

Test Date: Jul. 02, 2009

Temperature: 24°C

Atmospheric pressure: 1014 hPa

Humidity: 64%

Channel	Frequency (MHz)	20dB Bandwidth (KHz)
00	2402	672.00
39	2441	672.00
78	2480	672.00

Modulation Standard: 8DPSK (3Mbps)

Test Date: Jul. 02, 2009

Temperature: 24°C

Atmospheric pressure: 1014 hPa

Humidity: 64%

Channel	Frequency (MHz)	20dB Bandwidth (KHz)
00	2402	628.00
39	2441	628.00
78	2480	628.00



Modulation Standard: GFSK (1Mbps)
Channel: 00



*RBW 30 kHz Marker 1 [T1]
*VBW 100 kHz -4.58 dBm
*SWT 50 ms 2.401980000 GHz

Ref 30 dBm

*Att 40 dB

1 PK
VIEW

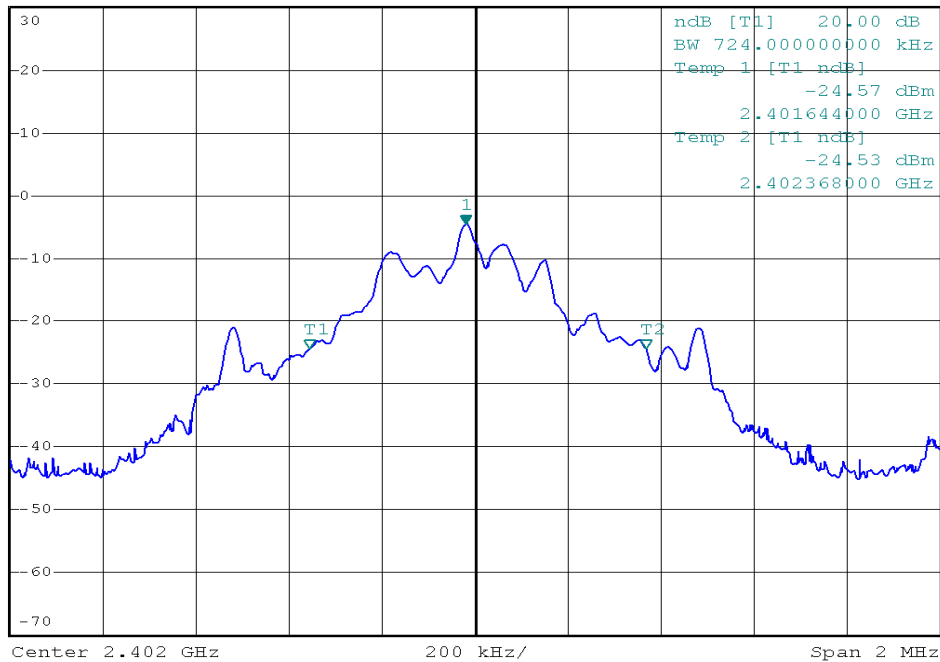

Modulation Standard: GFSK (1Mbps)
Channel: 39



*RBW 30 kHz Marker 1 [T1]
*VBW 100 kHz -3.54 dBm
*SWT 50 ms 2.440984000 GHz

Ref 30 dBm

*Att 40 dB

1 PK
VIEW

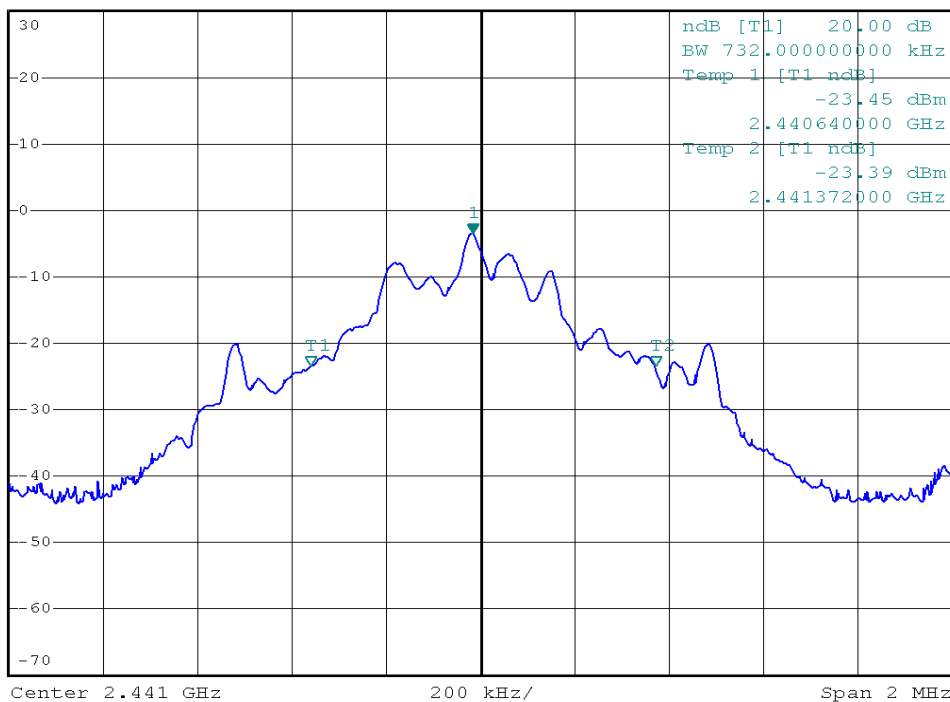



Modulation Standard: GFSK (1Mbps)
Channel: 78

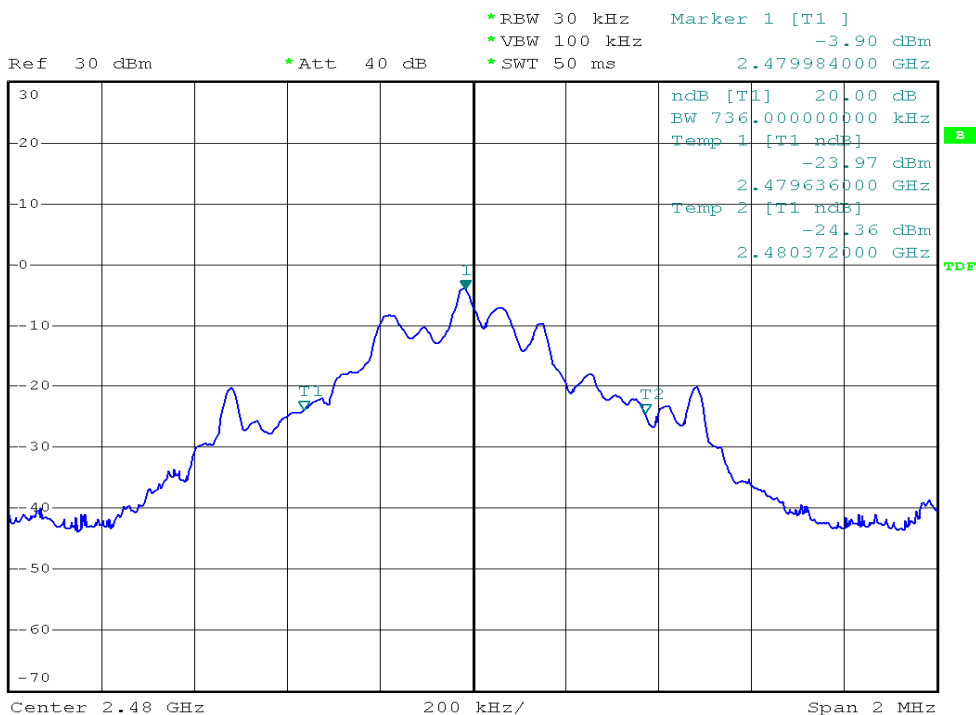

Modulation Standard: $\pi/4$ -DQPSK (2Mbps)
Channel: 00

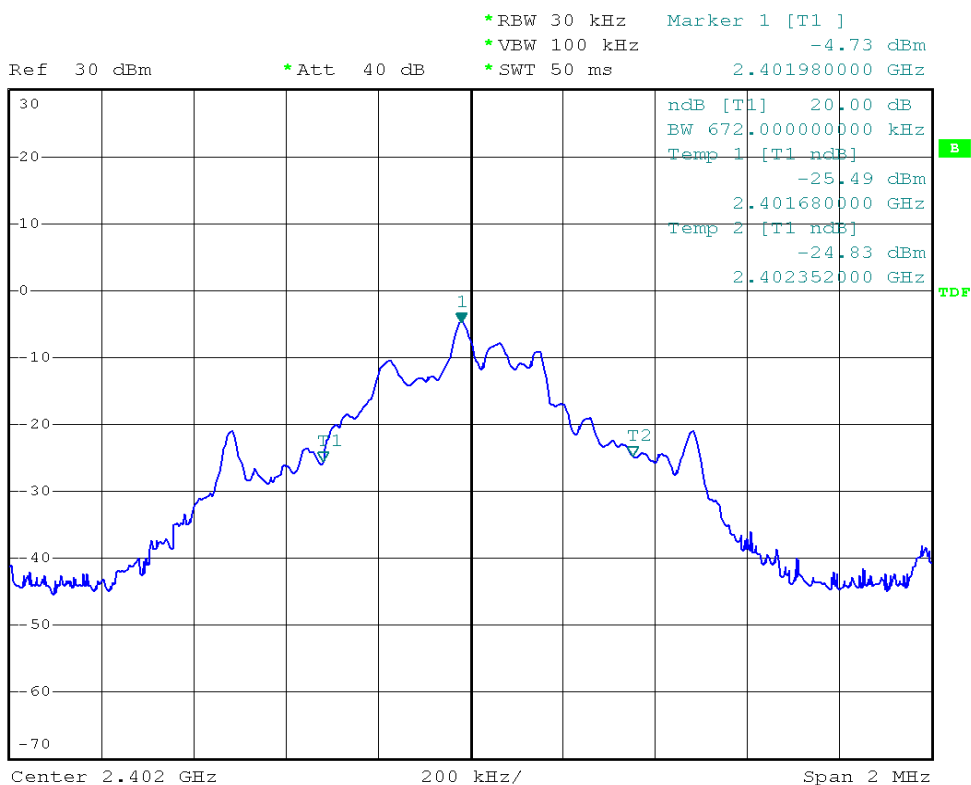



Modulation Standard: $\pi/4$ -DQPSK (2Mbps)
Channel: 39

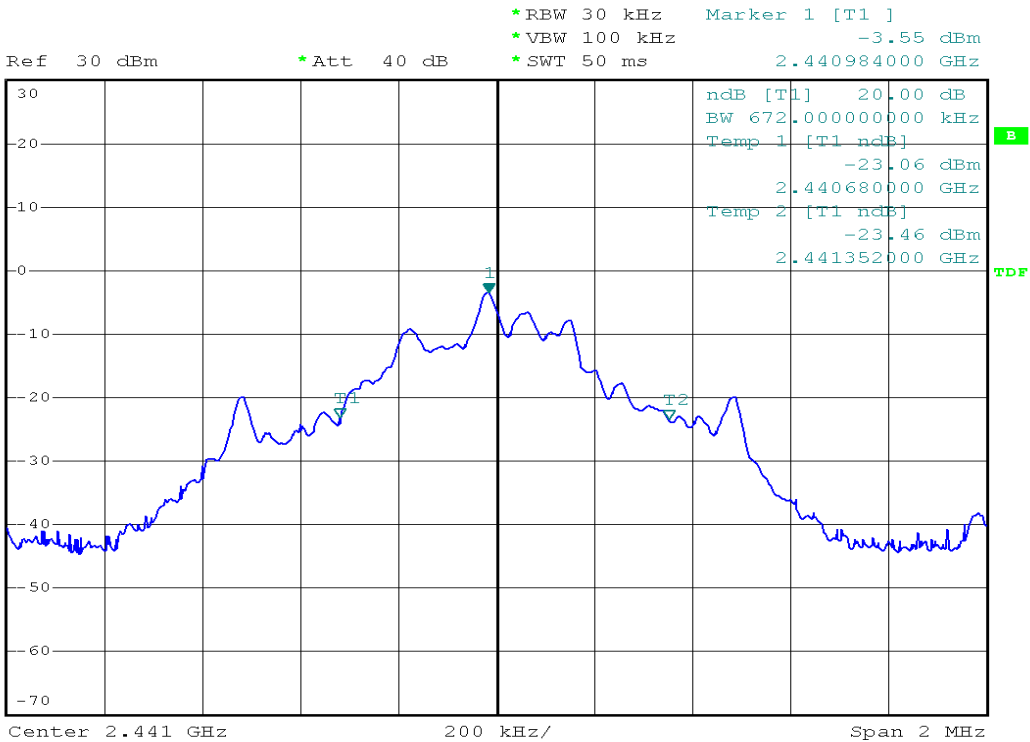

Modulation Standard: $\pi/4$ -DQPSK (2Mbps)
Channel: 78

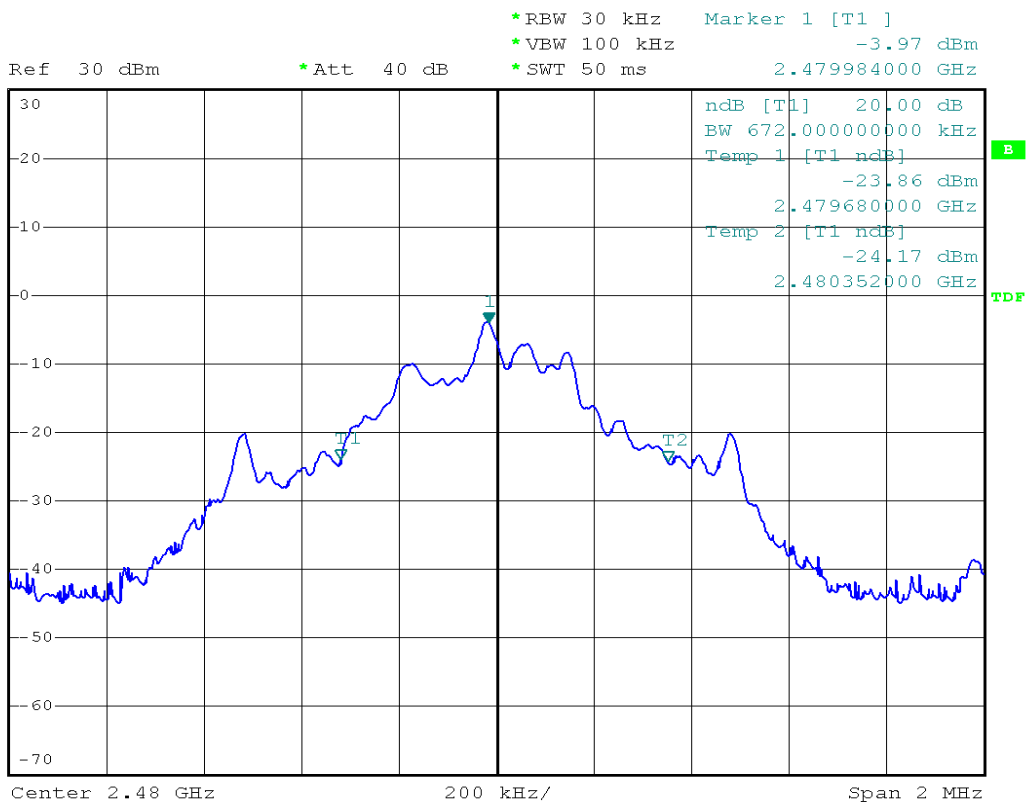



Modulation Standard: 8DPSK (3Mbps)
Channel: 00

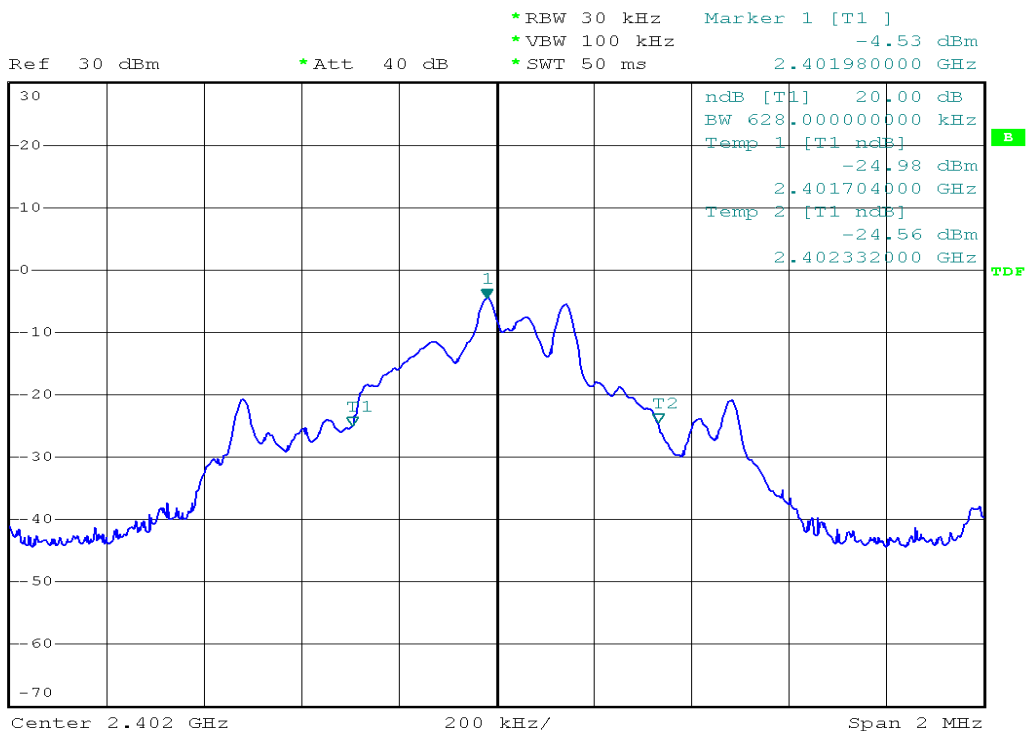

Modulation Standard: 8DPSK (3Mbps)
Channel: 39

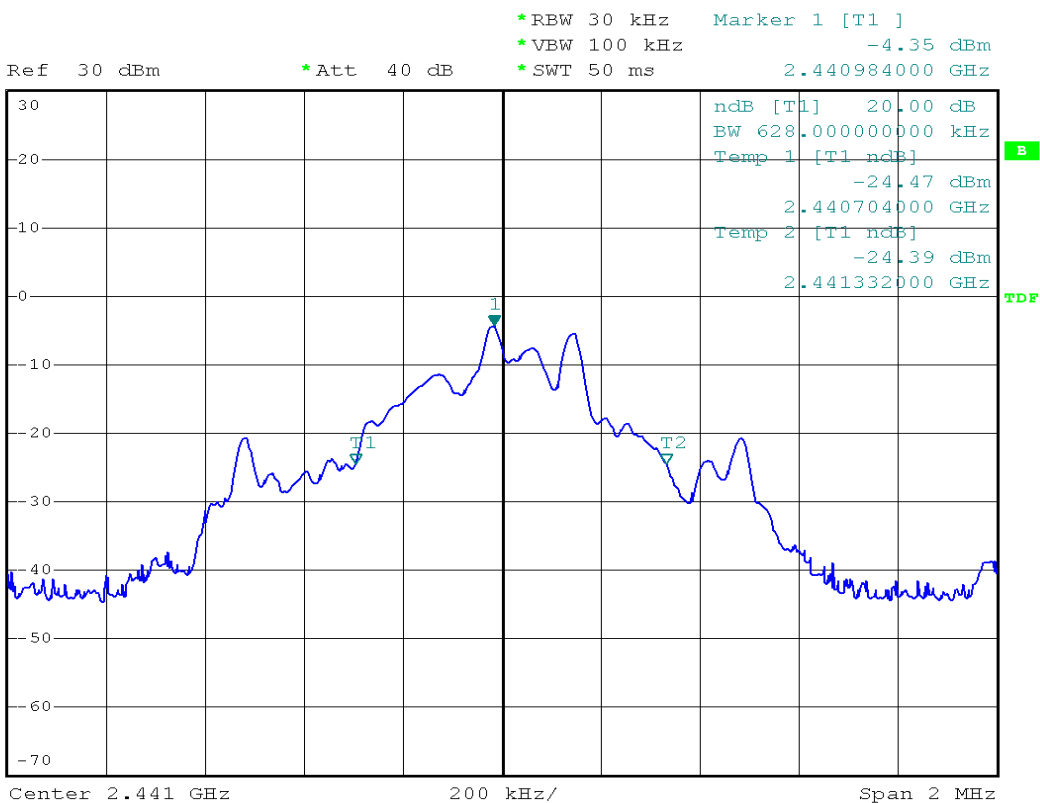



Modulation Standard: 8DPSK (3Mbps)
Channel: 78



Ref 30 dBm *Att 40 dB *RBW 30 kHz Marker 1 [T1] -4.07 dBm
*VBW 100 kHz *SWT 50 ms 2.479984000 GHz

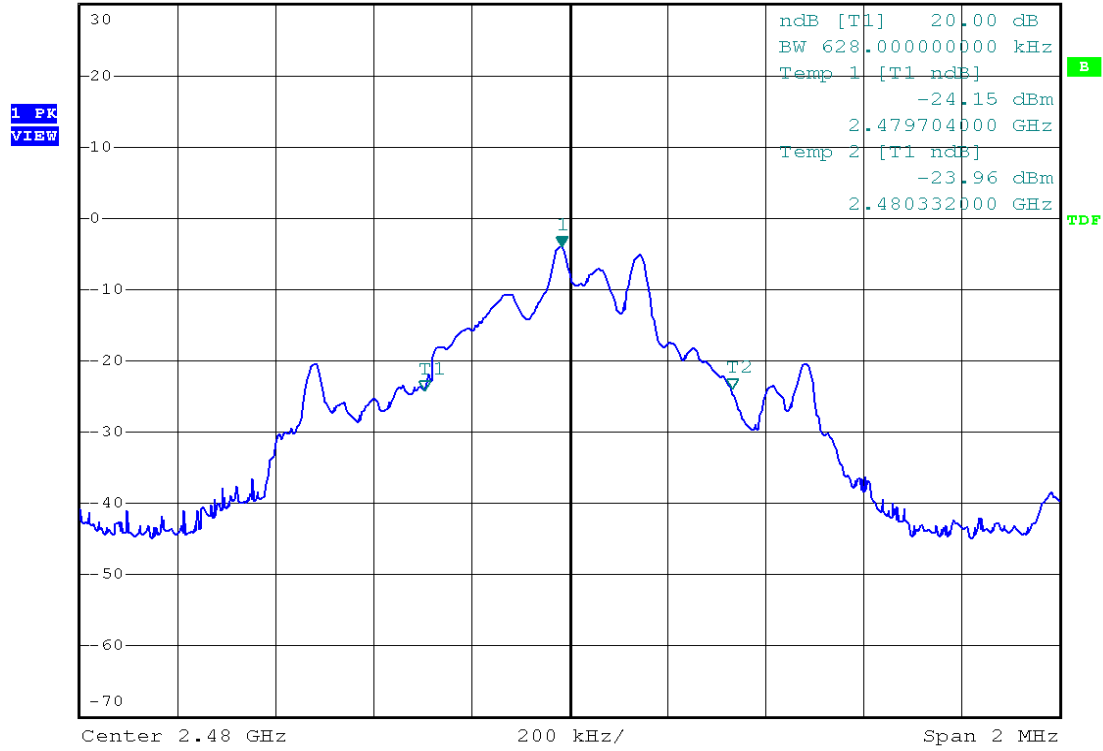



7. Frequencies Separation

7.1 Test Limit

Frequency hopping systems shall have hopping channel carrier frequencies separated by a minimum of 25 kHz or the 20 dB bandwidth of the hopping channel, whichever is greater.

7.2 Test Procedures

- a. The transmitter output was connected to the spectrum analyzer.
- b. Set RBW of spectrum analyzer to 100 KHz and VBW to 100 KHz.
- c. By using the MaxHold function record the separation of two adjacent channels.
- d. Measure the frequency difference of these two adjacent channels.

7.3 Test Setup Layout

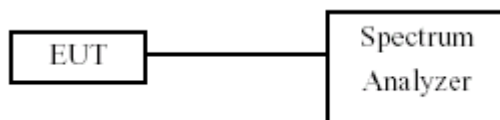

7.4 Measurement equipment

Instrument/Ancillary	Model No.	Manufacturer	Serial No.	Calibration Date	Valid Date
Spectrum Analyzer	FSP40	R&S	10047	2009/03/26	2010/03/25



7.5 Test Result and Data

Modulation Standard: GFSK (1Mbps)

Test Date: Jul. 02, 2009

Temperature: 24°C

Atmospheric pressure: 1012 hPa

Humidity: 57%

Channel	Frequency (MHz)	Channel Separation (MHz)
00	2402	1.004
39	2441	1.000
78	2480	1.004

Modulation Standard: $\pi/4$ -DQPSK (2Mbps)

Test Date: Jul. 02, 2009

Temperature: 24°C

Atmospheric pressure: 1014 hPa

Humidity: 64%

Channel	Frequency (MHz)	Channel Separation (MHz)
00	2402	1.004
39	2441	1.000
78	2480	1.000

Modulation Standard: 8DPSK (3Mbps)

Test Date: Jul. 02, 2009

Temperature: 24°C

Atmospheric pressure: 1014 hPa

Humidity: 64%

Channel	Frequency (MHz)	Channel Separation (MHz)
00	2402	1.000
39	2441	1.004
78	2480	1.004



Modulation Standard: GFSK (1Mbps)
Channel: 00

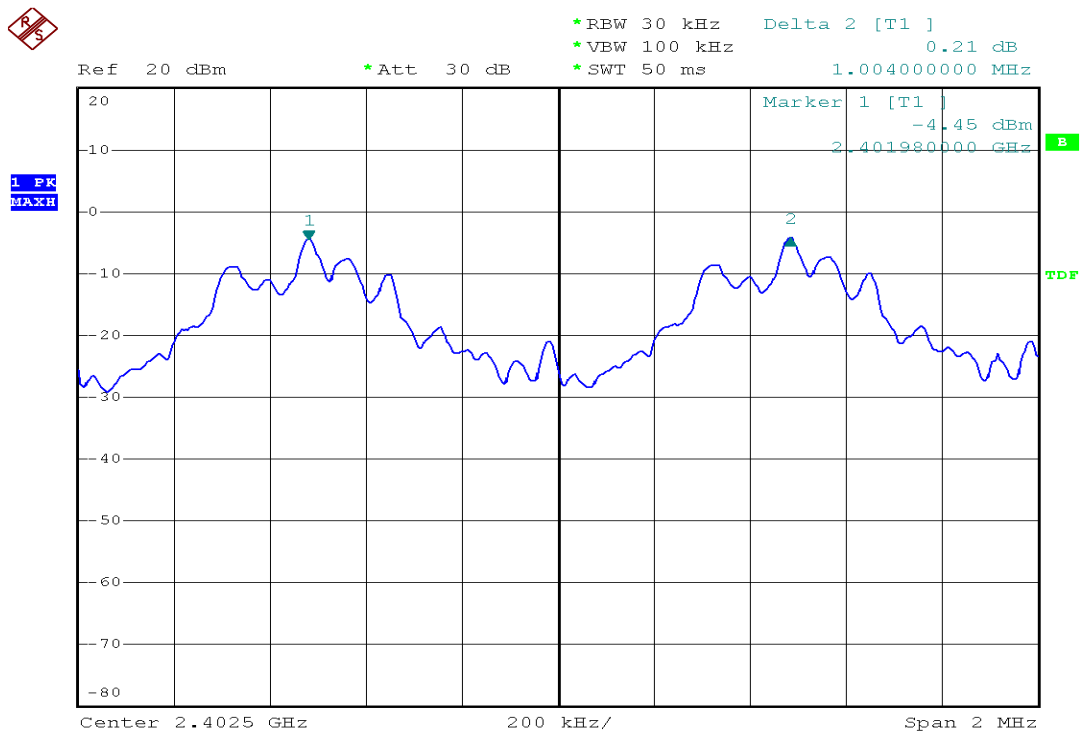

Modulation Standard: GFSK (1Mbps)
Channel: 39

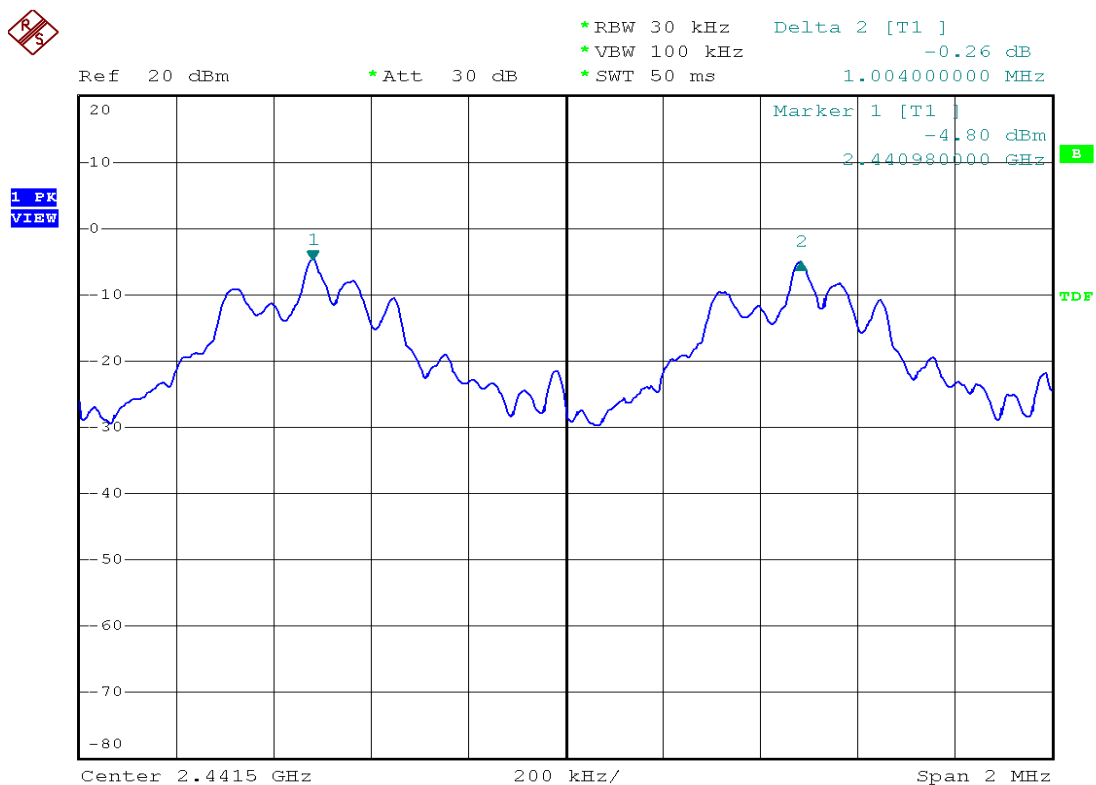



Modulation Standard: GFSK (1Mbps)
Channel: 78

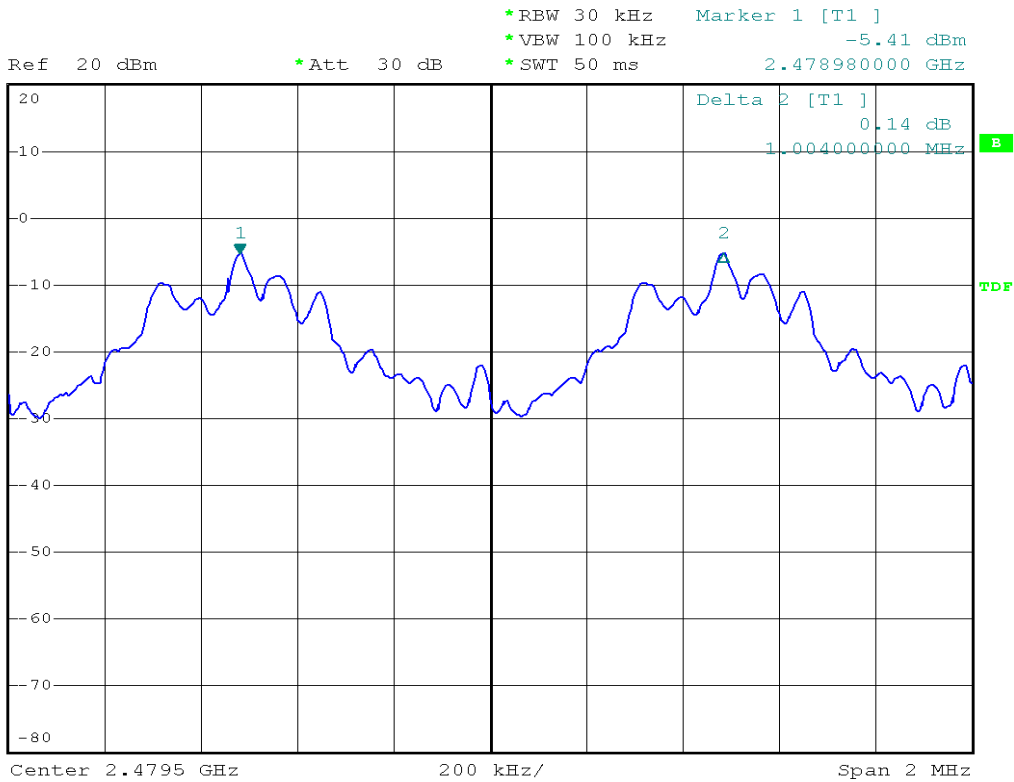

Modulation Standard: $\pi/4$ -DQPSK (2Mbps)
Channel: 00

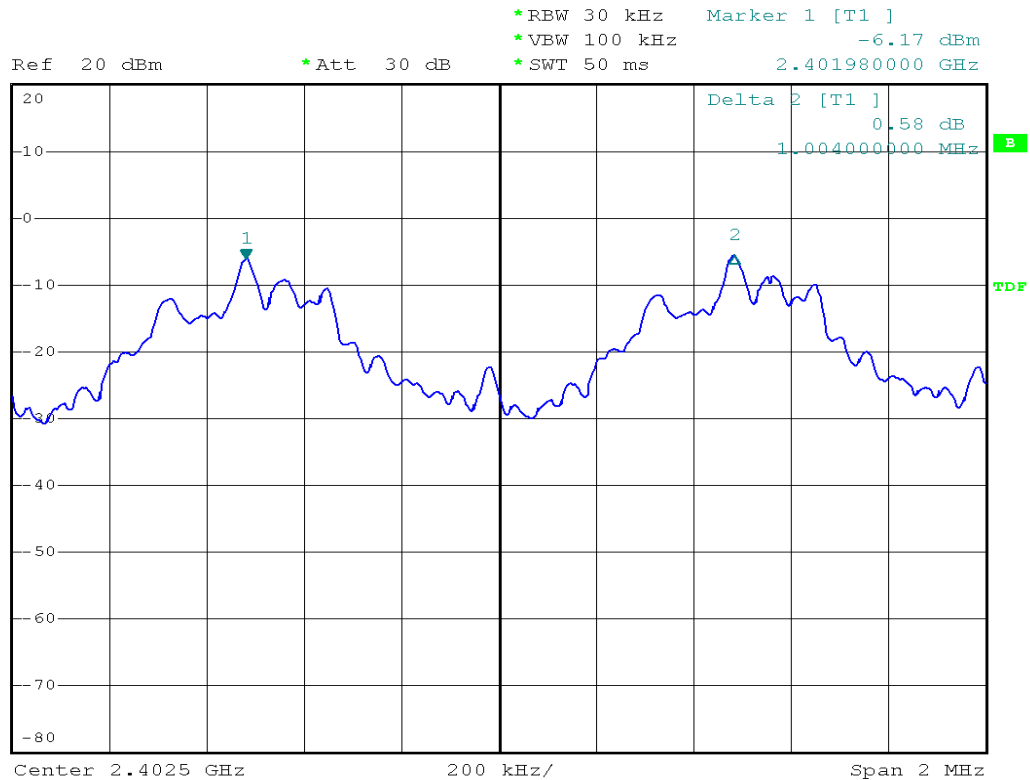



Modulation Standard: $\pi/4$ -DQPSK (2Mbps)
Channel: 39



Ref 20 dBm *Att 30 dB
*RBW 30 kHz Delta 2 [T1] -0.31 dB
*VBW 100 kHz
*SWT 50 ms 1.000000000 MHz

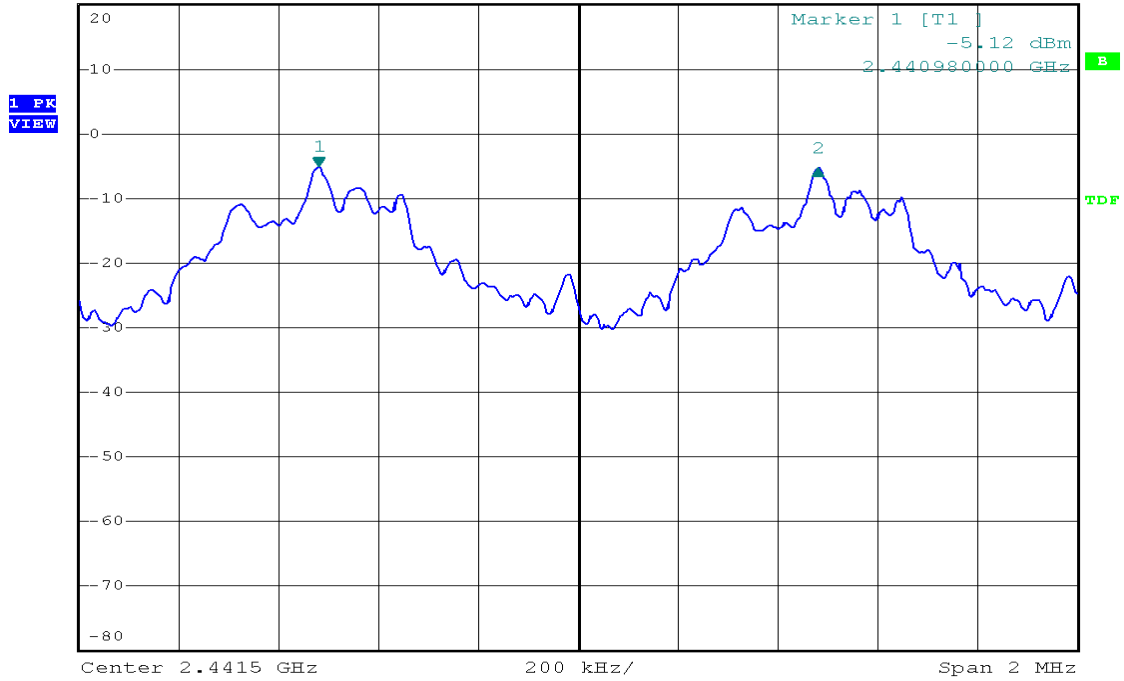

Modulation Standard: $\pi/4$ -DQPSK (2Mbps)
Channel: 78



Ref 20 dBm *Att 30 dB
*RBW 30 kHz Marker 1 [T1] -5.43 dBm
*VBW 100 kHz
*SWT 50 ms 2.478980000 GHz

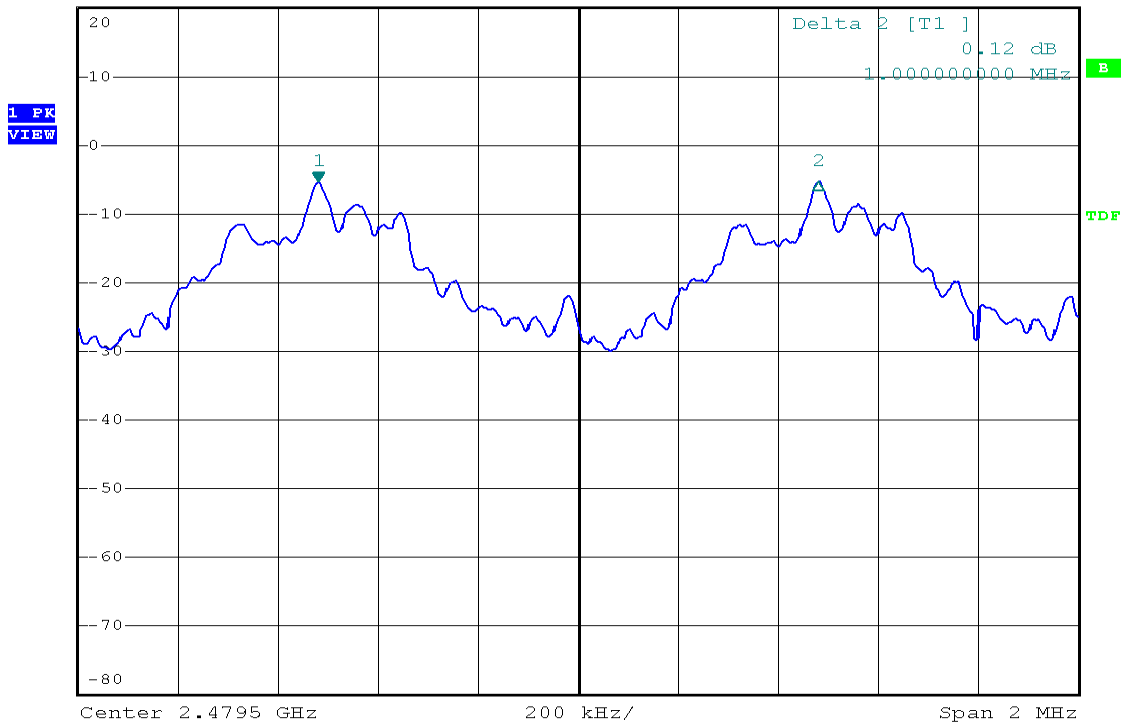



Modulation Standard: 8DQPSK (3Mbps)
Channel: 00



Modulation Standard: 8DQPSK (3Mbps)
Channel: 39

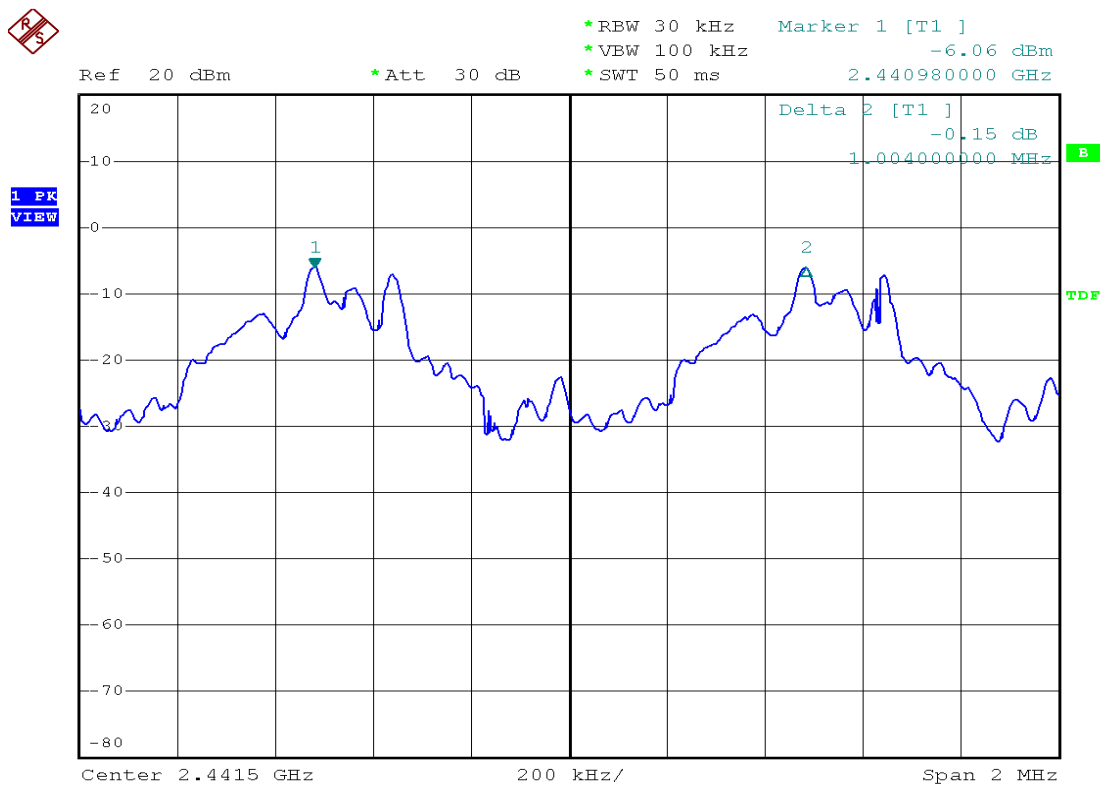



Modulation Standard: 8DQPSK (3Mbps)
Channel: 78



Ref 20 dBm *Att 30 dB *RBW 30 kHz Delta 2 [T1]
*VBW 100 kHz 1.49 dB
*SWT 50 ms 1.004000000 MHz

1 PK
VIEW

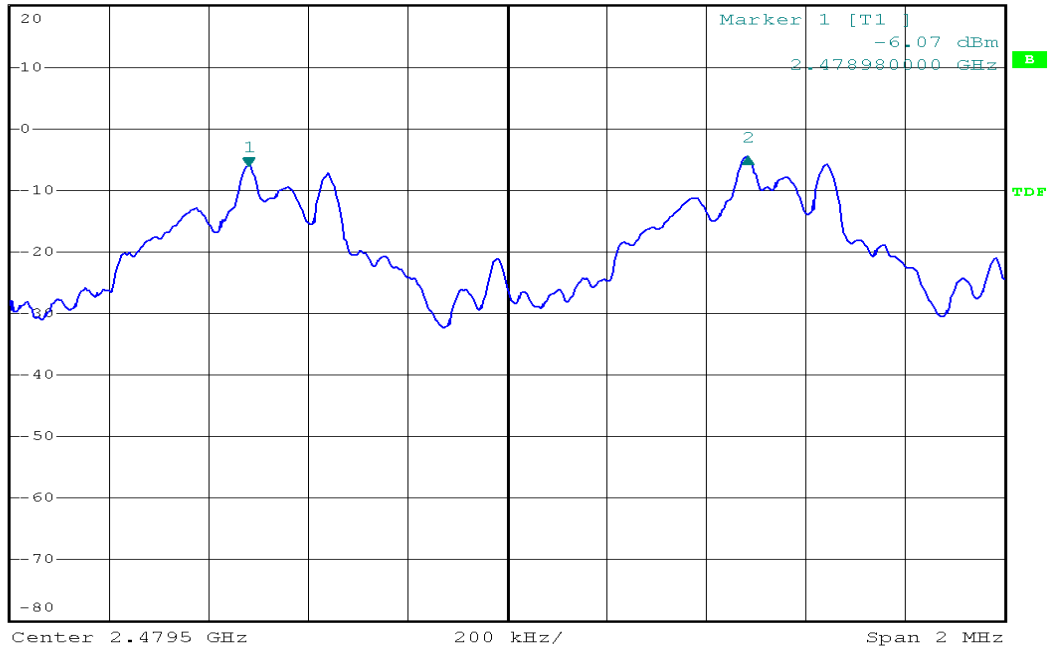



8. Dwell Time on each channel

8.1 Test Limit

The average time of occupancy on any channel shall not be greater than 0.4 seconds within a period of 0.4 seconds multiplied by the number of hopping channels employed.

8.2 Test Procedures

1. The transmitter output was connected to the spectrum analyzer.
2. Adjust the center frequency to measure frequency, then set zero span mode.
2. Set RBW of spectrum analyzer to 100 KHz and VBW to 100 KHz.
4. Measure the time duration of one transmission on the measured frequency.

8.3 Test Setup Layout

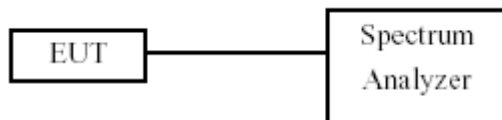

8.4 Measurement equipment

Instrument/Ancillary	Model No.	Manufacturer	Serial No.	Calibration Date	Valid Date
Spectrum Analyzer	FSP40	R&S	10047	2009/03/26	2010/03/25



8.5 Test Result and Data

Modulation Standard: GFSK (1Mbps)

Test Date: Jul. 02, 2009

Temperature: 24°C

Atmospheric pressure: 1012 hPa

Humidity: 57%

a) 2402 MHz Dwell Time is	=	136.96 ms
b) 2441 MHz Dwell Time is	=	135.84 ms
c) 2480 MHz Dwell Time is	=	137.60 ms

Modulation Standard: $\pi/4$ -DQPSK (2Mbps)

Test Date: Jul. 02, 2009

Temperature: 24°C

Atmospheric pressure: 1014 hPa

Humidity: 64%

a) 2402 MHz Dwell Time is	=	237.44 ms
b) 2441 MHz Dwell Time is	=	271.36 ms
c) 2480 MHz Dwell Time is	=	237.72 ms

Modulation Standard: 8DPSK (3Mbps)

Test Date: Jul. 02, 2009

Temperature: 24°C

Atmospheric pressure: 1014 hPa

Humidity: 64%

a) 2402 MHz Dwell Time is	=	382.20 ms
b) 2441 MHz Dwell Time is	=	354.24 ms
c) 2480 MHz Dwell Time is	=	324.72 ms



Modulation Standard: GFSK (1Mbps)
Channel: 00

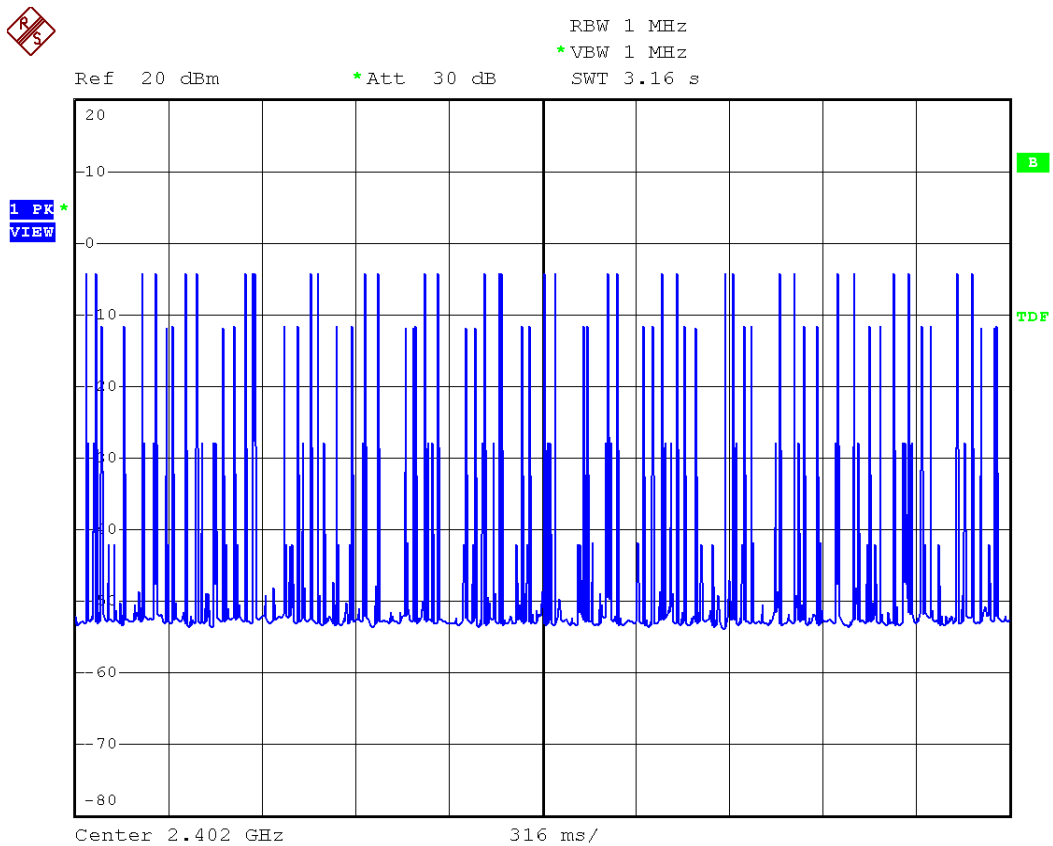
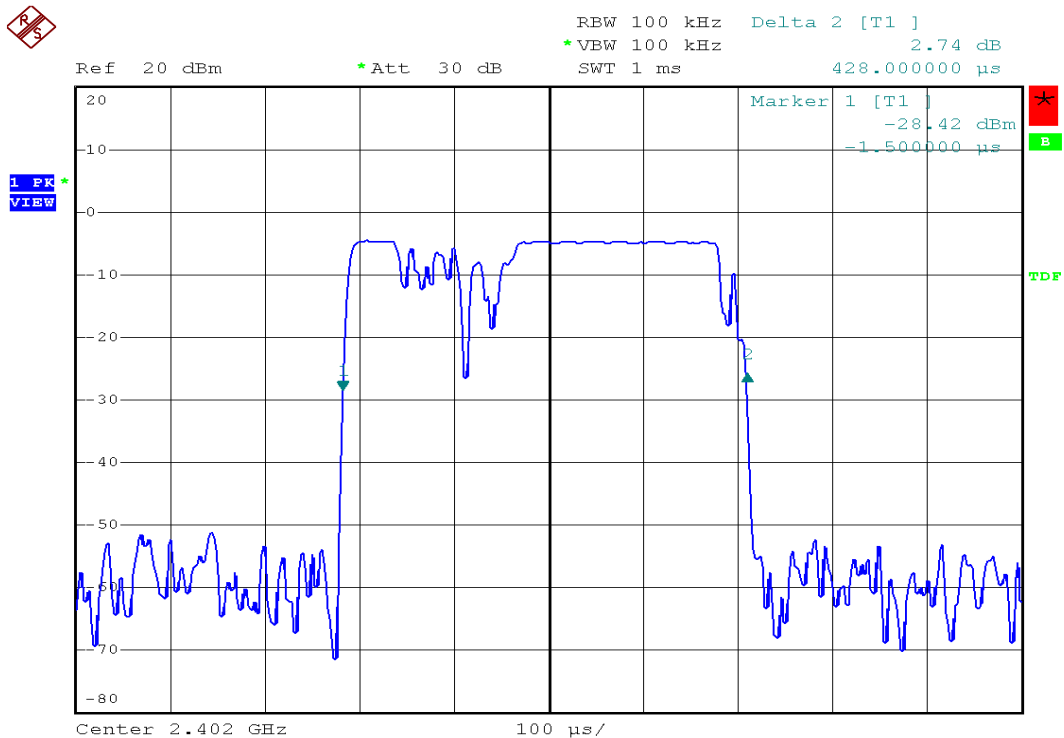



Modulation Standard: GFSK (1Mbps)
Channel: 39

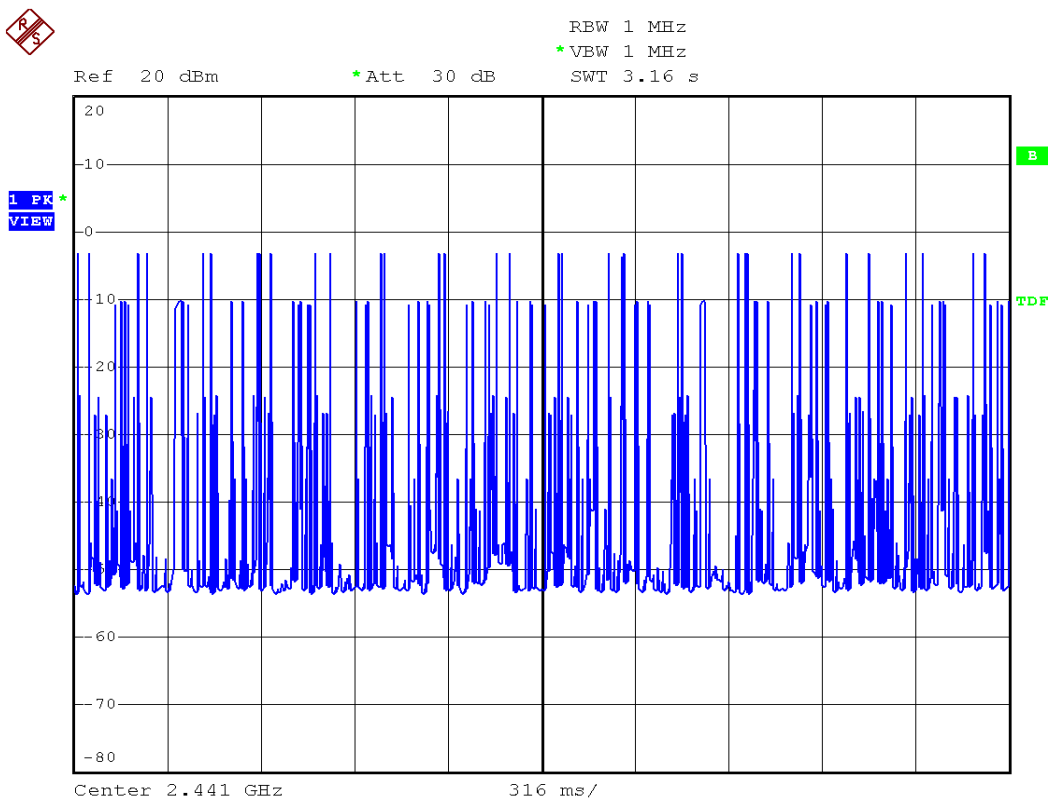
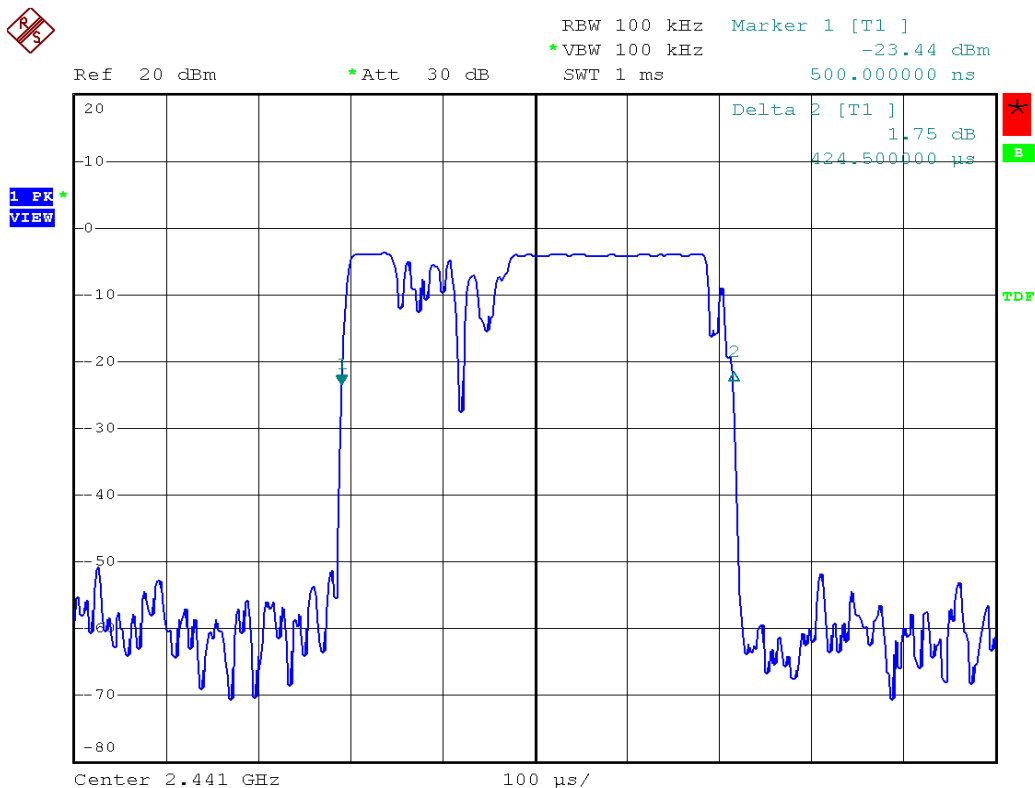



Modulation Standard: GFSK (1Mbps)
Channel: 78

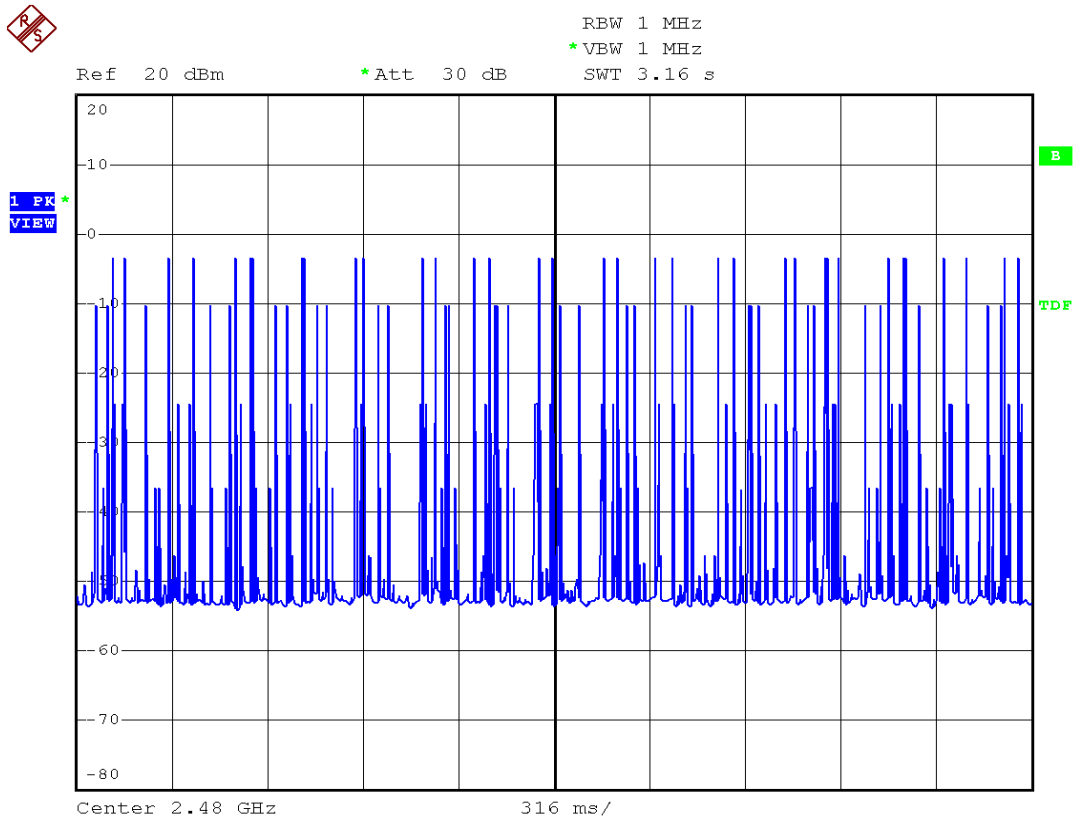
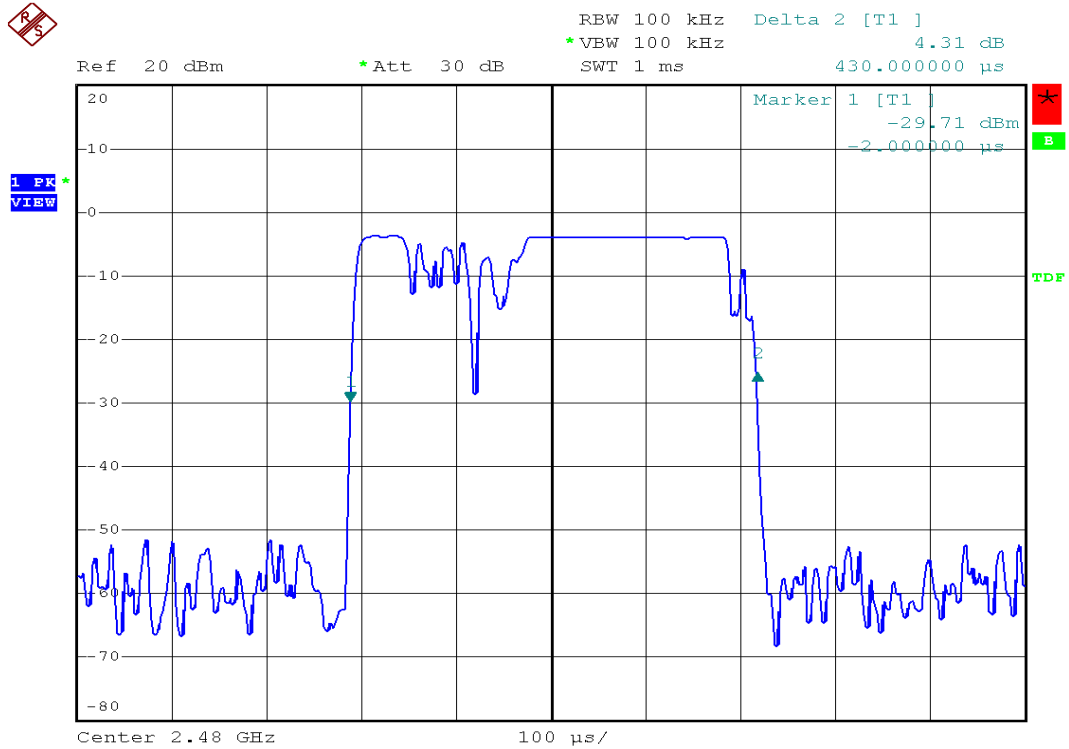



Modulation Standard: $\pi/4$ -DQPSK (2Mbps)
Channel: 00

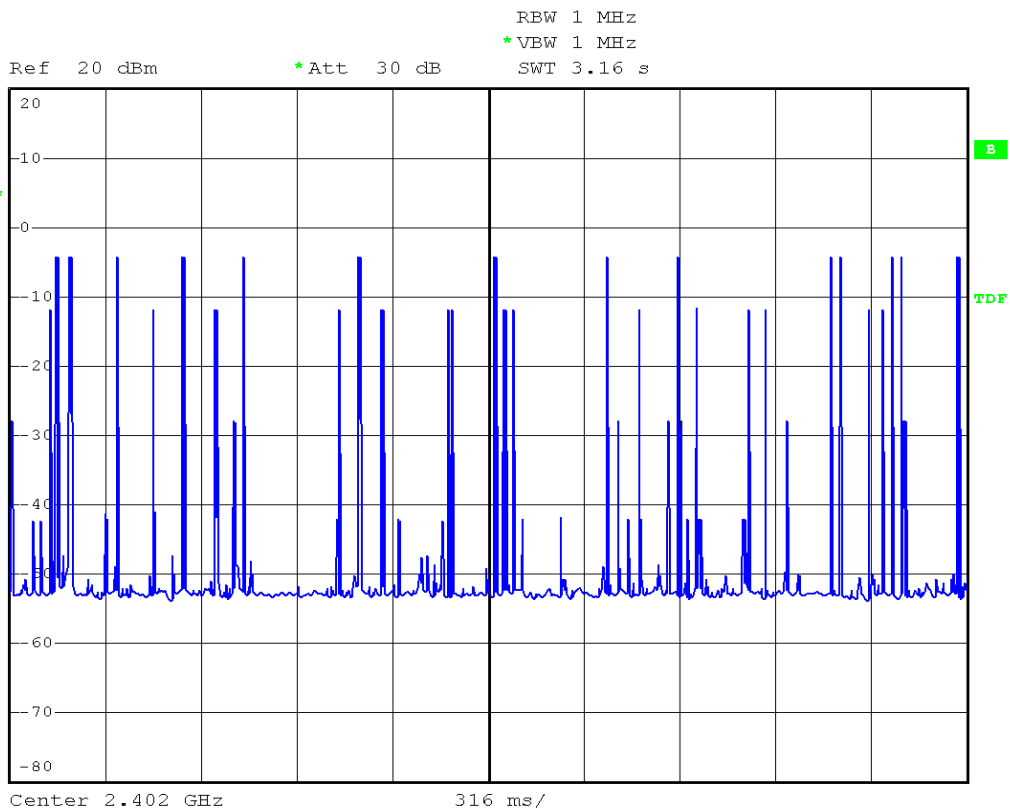
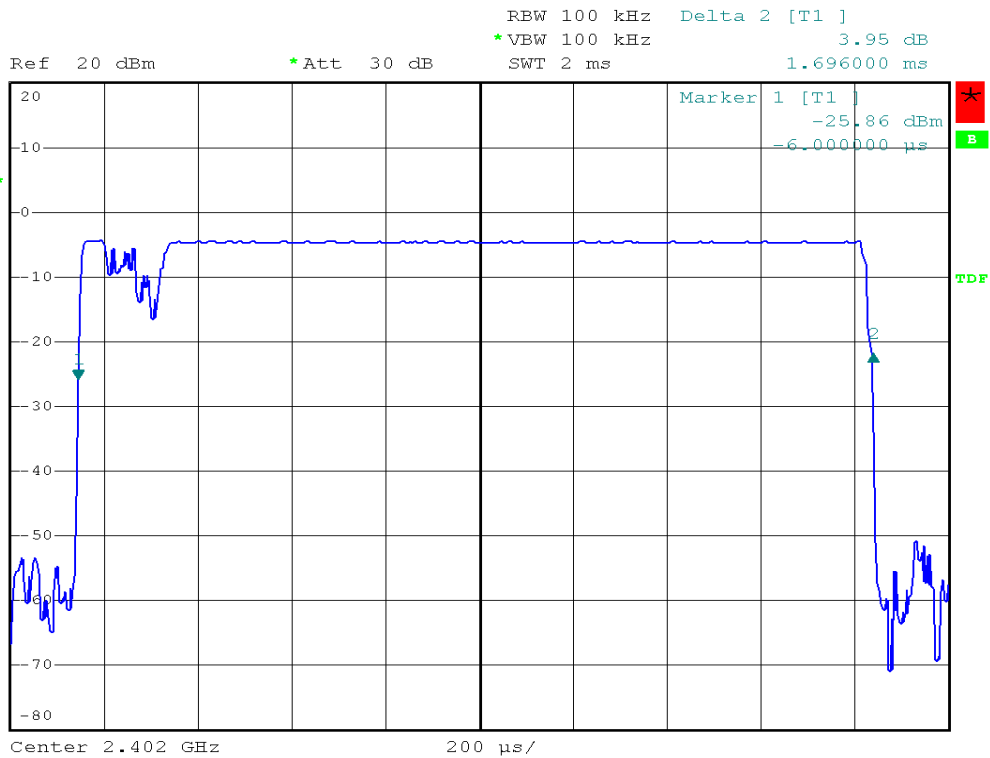



Modulation Standard: $\pi/4$ -DQPSK (2Mbps)
Channel: 39



Ref 20 dBm *Att 30 dB
RBW 100 kHz Marker 1 [T1] -24.60 dBm
*VBW 100 kHz SWT 2 ms -1.500000 μ s

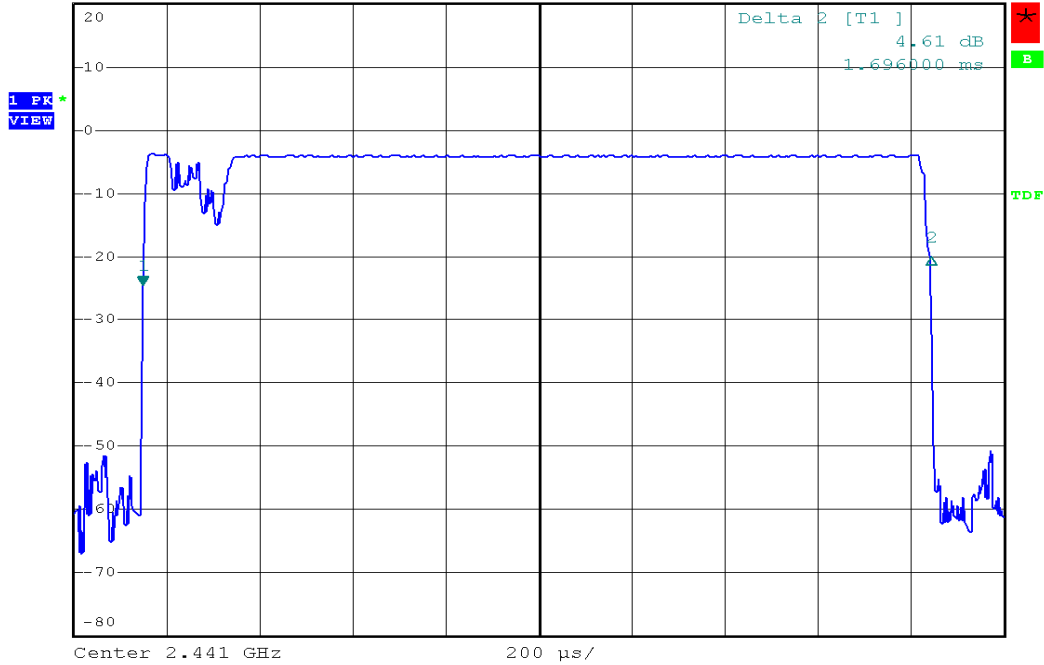

Ref 20 dBm *Att 30 dB
RBW 1 MHz *VBW 1 MHz
SWT 3.16 s

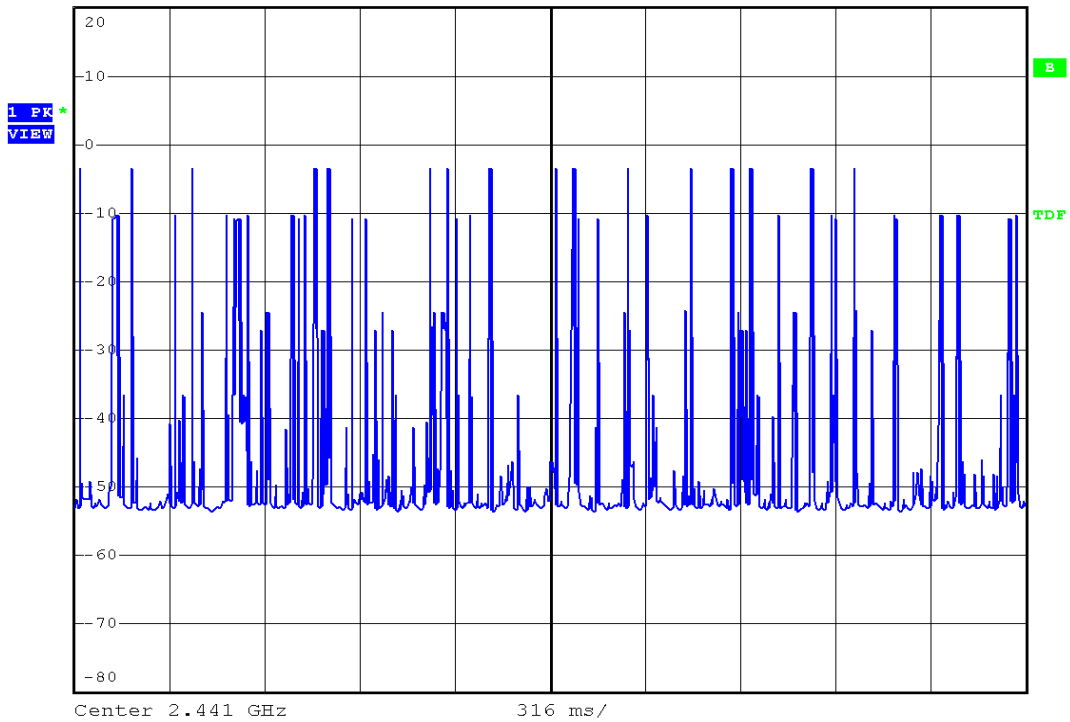



Modulation Standard: $\pi/4$ -DQPSK (2Mbps)
Channel: 78

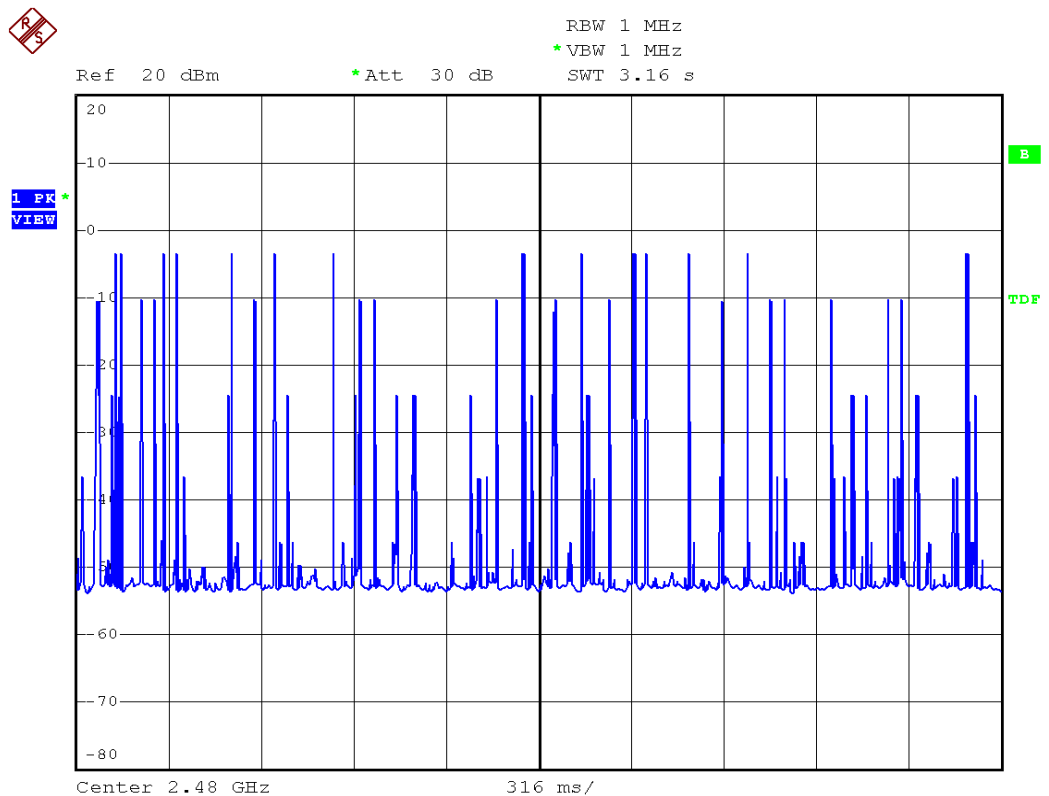



Modulation Standard: 8DPSK (3Mbps)
Channel: 00

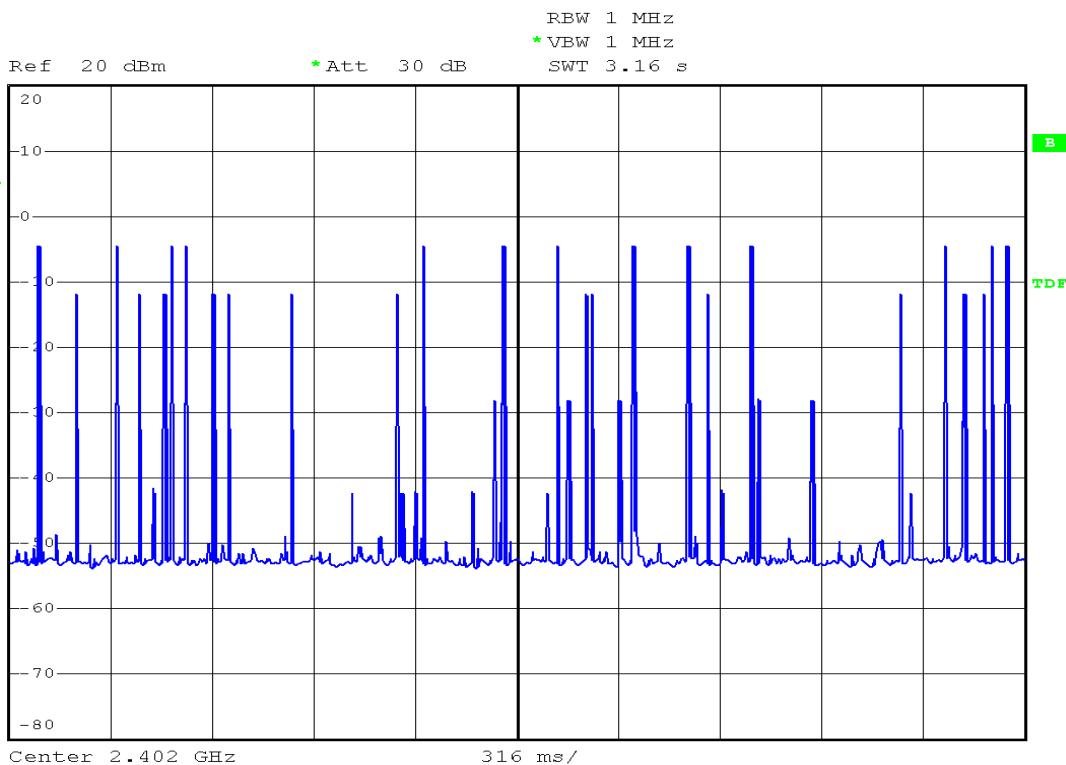
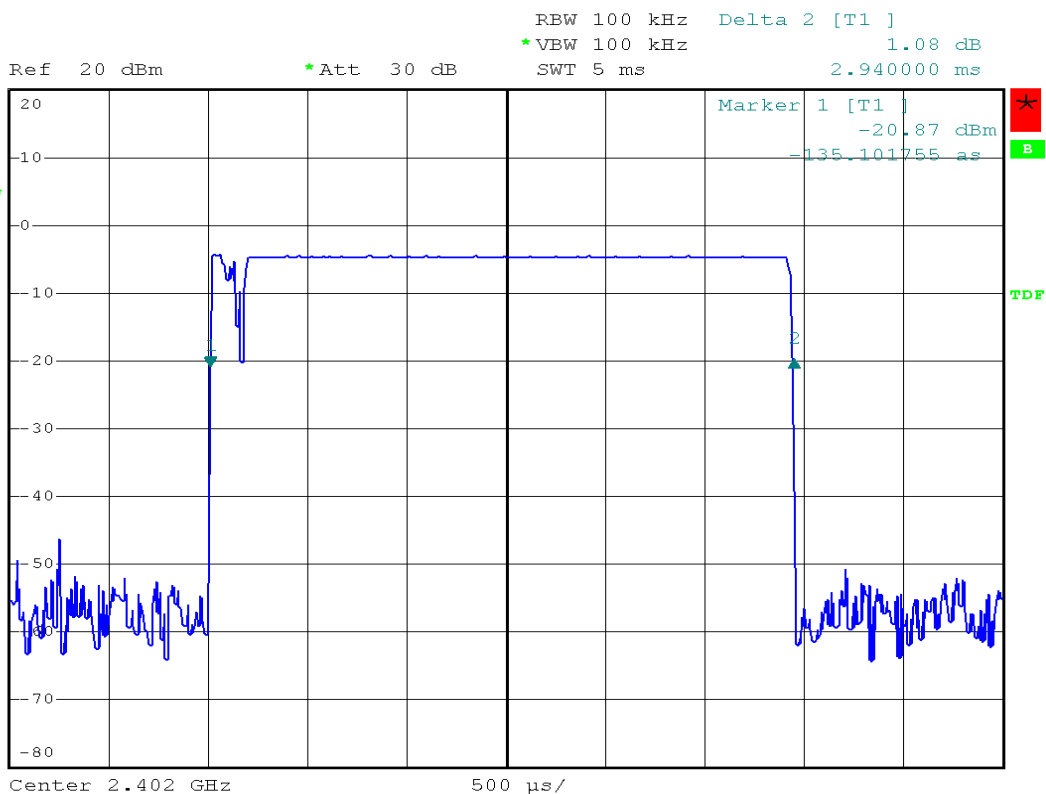



Modulation Standard: 8DPSK (3Mbps)
Channel: 39

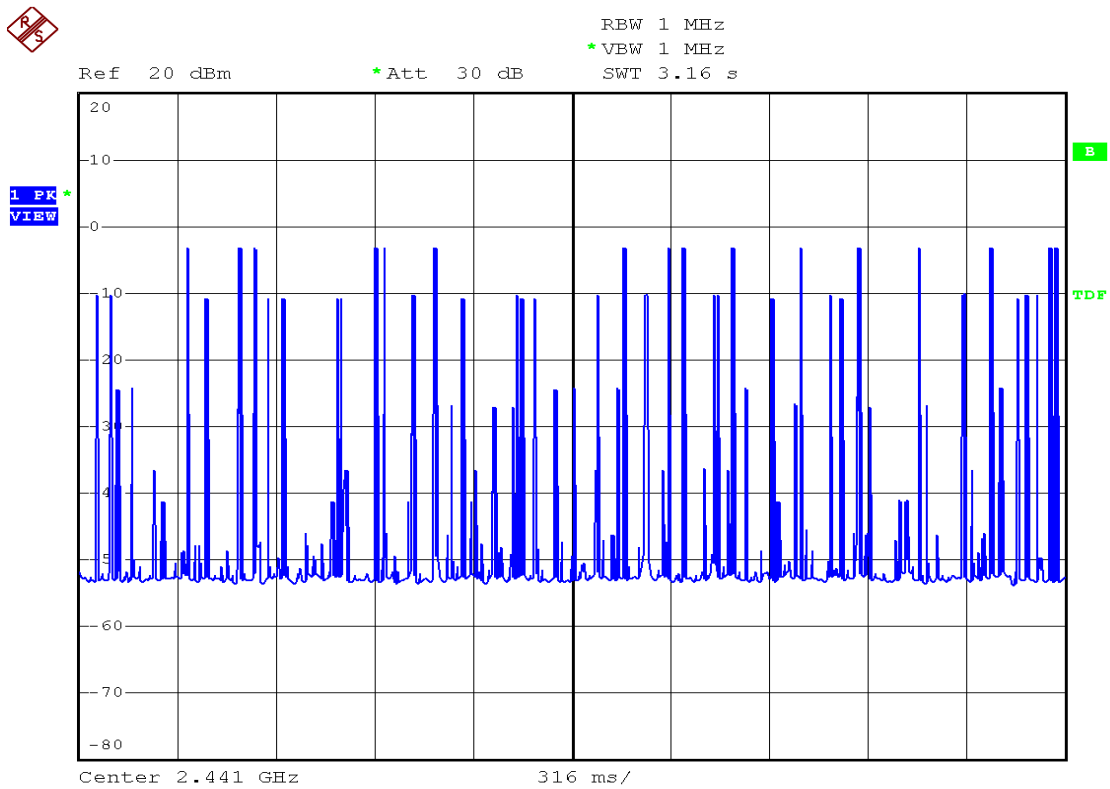
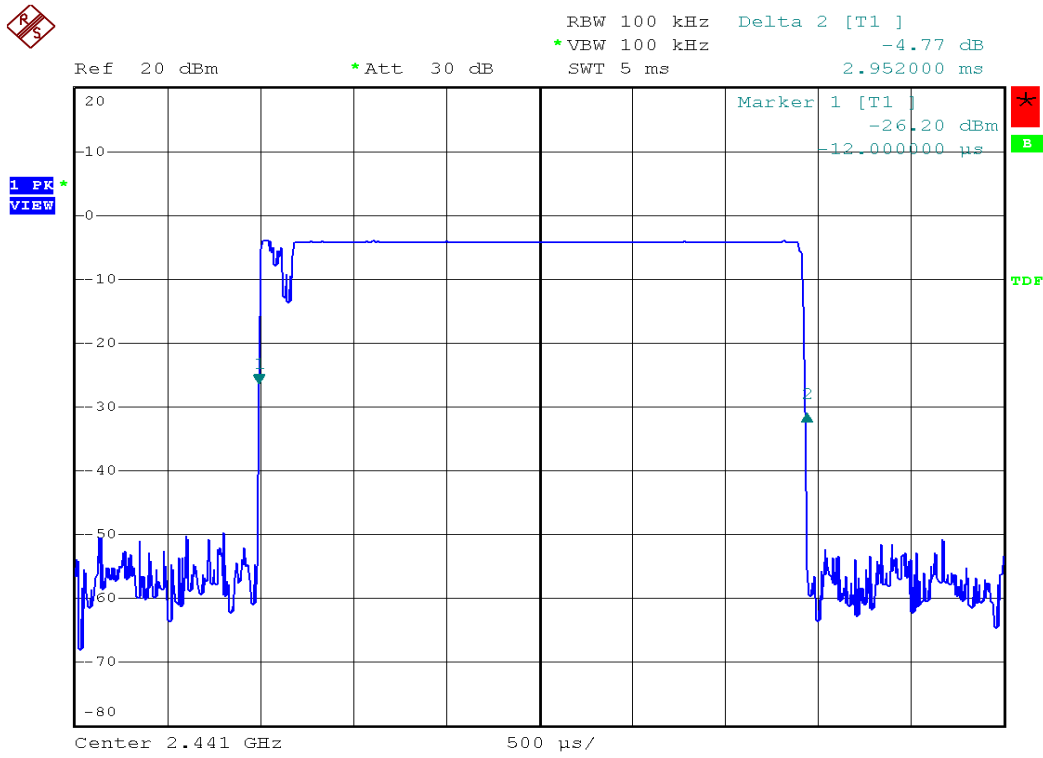



Modulation Standard: 8DPSK (3Mbps)
Channel: 78



Ref 20 dBm *Att 30 dB RBW 100 kHz Marker 1 [T1] -32.18 dBm
*VBW 100 kHz SWT 5 ms -12.000000 μ s

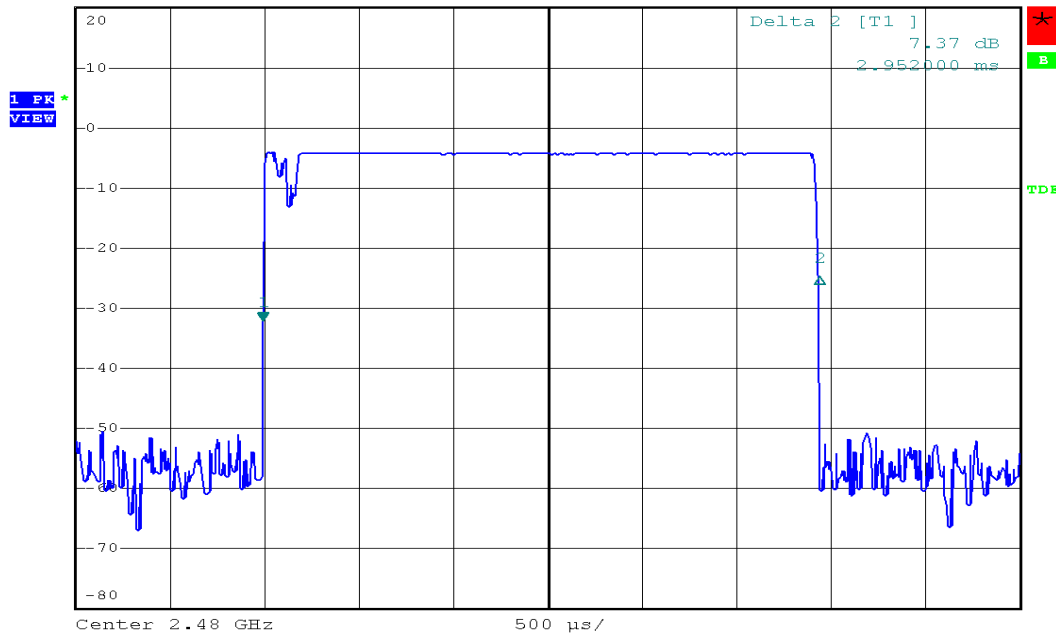

Ref 20 dBm *Att 30 dB RBW 1 MHz
*VBW 1 MHz SWT 3.16 s

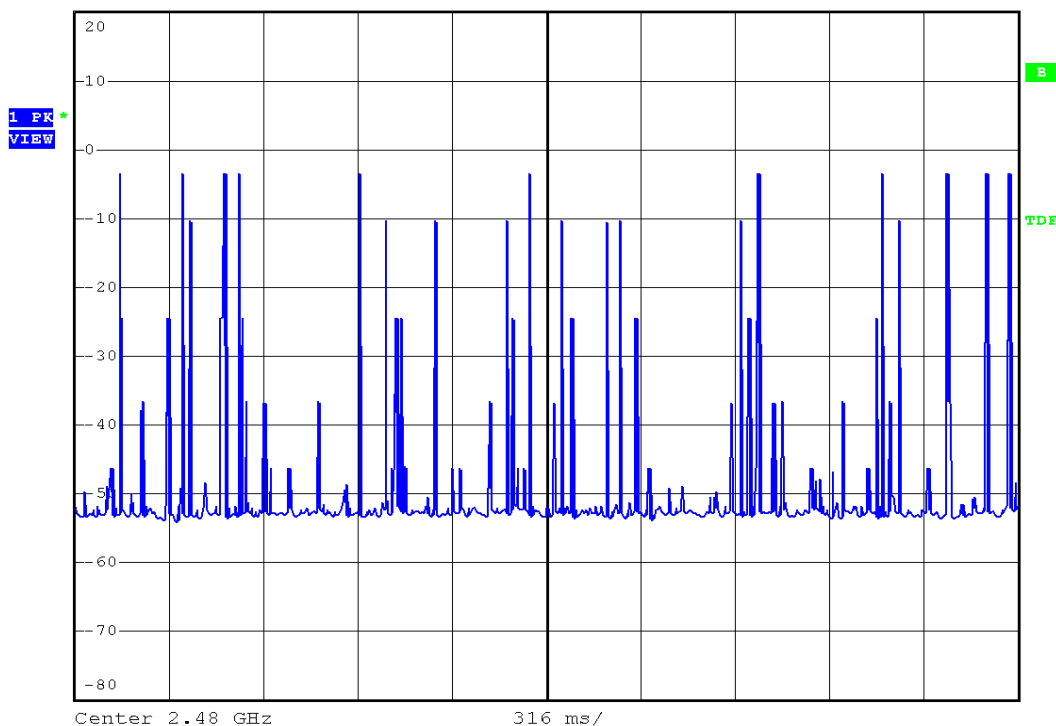



9. Number of Hopping Channels

9.1 Test Limit

Frequency hopping systems in the 2400 ~ 2483.5 MHz band shall use at least 15 channels.

9.2 Test Procedures

- a. The transmitter output was connected to the spectrum analyzer.
- b. 2. Set RBW of spectrum analyzer to 100 KHz and VBW to 100 KHz.
- c. 3. Set the MaxHold function, and then keep the EUT in hopping mode. Record all the signals from each channel until each one has been record.

9.3 Test Setup Layout

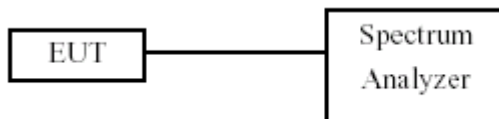

9.4 Measurement equipment

Instrument/Ancillary	Model No.	Manufacturer	Serial No.	Calibration Date	Valid Date
Spectrum Analyzer	FSP40	R&S	10047	2009/03/26	2010/03/25

9.5 Test Result and Data

Modulation Standard: GFSK (1Mbps)

Test Date: Jul. 02, 2009

Temperature: 24°C

Atmospheric pressure: 1012 hPa

Humidity: 57%

Number of hopping channels:	79	Channels
-----------------------------	----	----------

Modulation Standard: $\pi/4$ -DQPSK (2Mbps)

Test Date: Jul. 02, 2009

Temperature: 24°C

Atmospheric pressure: 1014 hPa

Humidity: 64%

Number of hopping channels:	79	Channels
-----------------------------	----	----------

Modulation Standard: 8DPSK (3Mbps)

Test Date: Jul. 02, 2009

Temperature: 24°C

Atmospheric pressure: 1014 hPa

Humidity: 64%

Number of hopping channels:	79	Channels
-----------------------------	----	----------



Modulation Standard: GFSK (1Mbps), $\pi/4$ -DQPSK (2Mbps), 8DPSK (3Mbps)

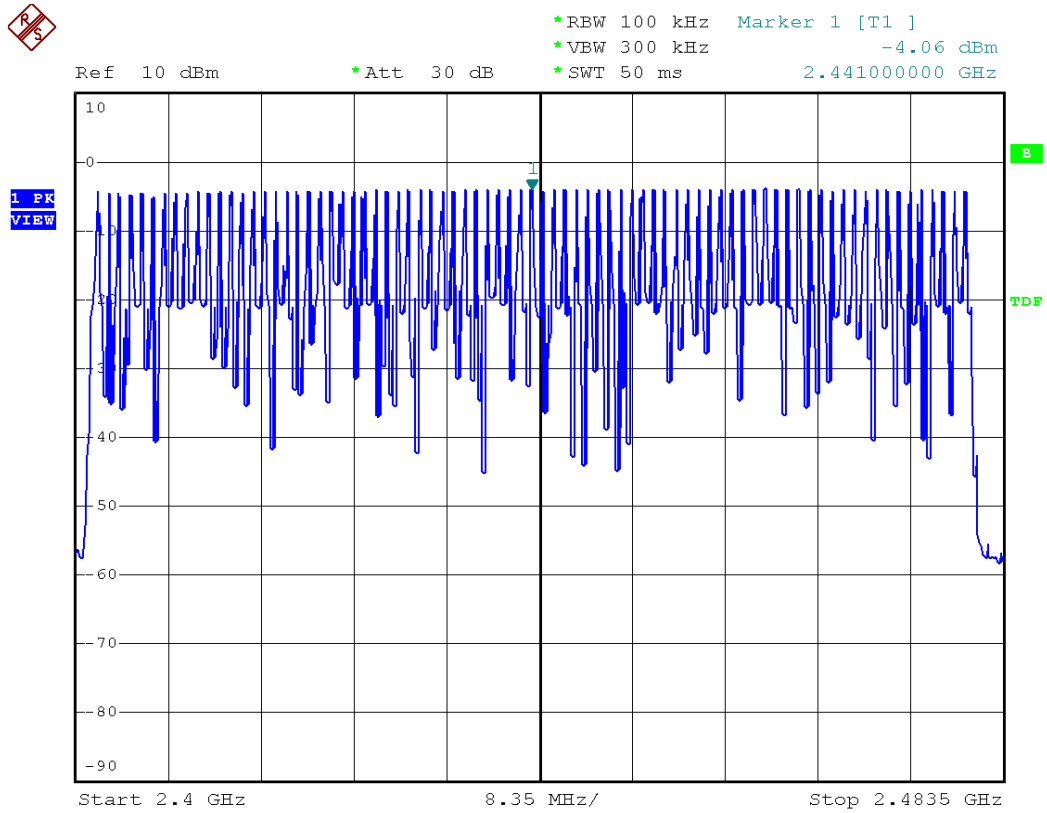



10. Maximum Peak Output Power

10.1 Test Limit

The Maximum Peak Output Power Measurement is 30dBm.

10.2 Test Procedures

The antenna port(RF output)of the EUT was connected to the input(RF input)of a power meter. Power was read directly from the meter and cable loss connection was added to the reading to obtain power at the EUT antenna terminal. The EUT Output Power was set to maximum to produce the worse case test result.

10.3 Test Setup Layout

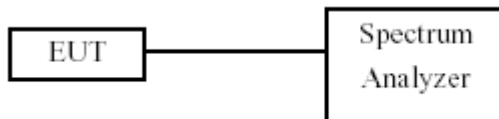

10.4 Measurement equipment

Instrument/Ancillary	Model No.	Manufacturer	Serial No.	Calibration Date	Valid Date
Spectrum Analyzer	FSP40	R&S	10047	2009/03/26	2010/03/25



10.5 Test Result and Data

Modulation Standard: GFSK (1Mbps)

Test Date: Jul. 02, 2009

Temperature: 24°C

Atmospheric pressure: 1012 hPa

Humidity: 57%

Channel	Frequency (MHz)	Peak Power Output (dBm)	Peak Power Output (mW)
00	2402	-5.36	0.3
39	2441	-4.13	0.4
78	2478	-4.27	0.4

Modulation Standard: $\pi/4$ -DQPSK (2Mbps)

Test Date: Jul. 02, 2009

Temperature: 24°C

Atmospheric pressure: 1014 hPa

Humidity: 64%

Channel	Frequency (MHz)	Peak Power Output (dBm)	Peak Power Output (mW)
00	2402	-5.87	0.3
39	2441	-4.19	0.4
78	2478	-4.40	0.4

Modulation Standard: 8DPSK (3Mbps)

Test Date: Jul. 02, 2009

Temperature: 24°C

Atmospheric pressure: 1014 hPa

Humidity: 64%

Channel	Frequency (MHz)	Peak Power Output (dBm)	Peak Power Output (mW)
00	2402	-5.64	0.3
39	2441	-4.03	0.4
78	2478	-4.45	0.4



Modulation Standard: GFSK (1Mbps)
Channel: 00

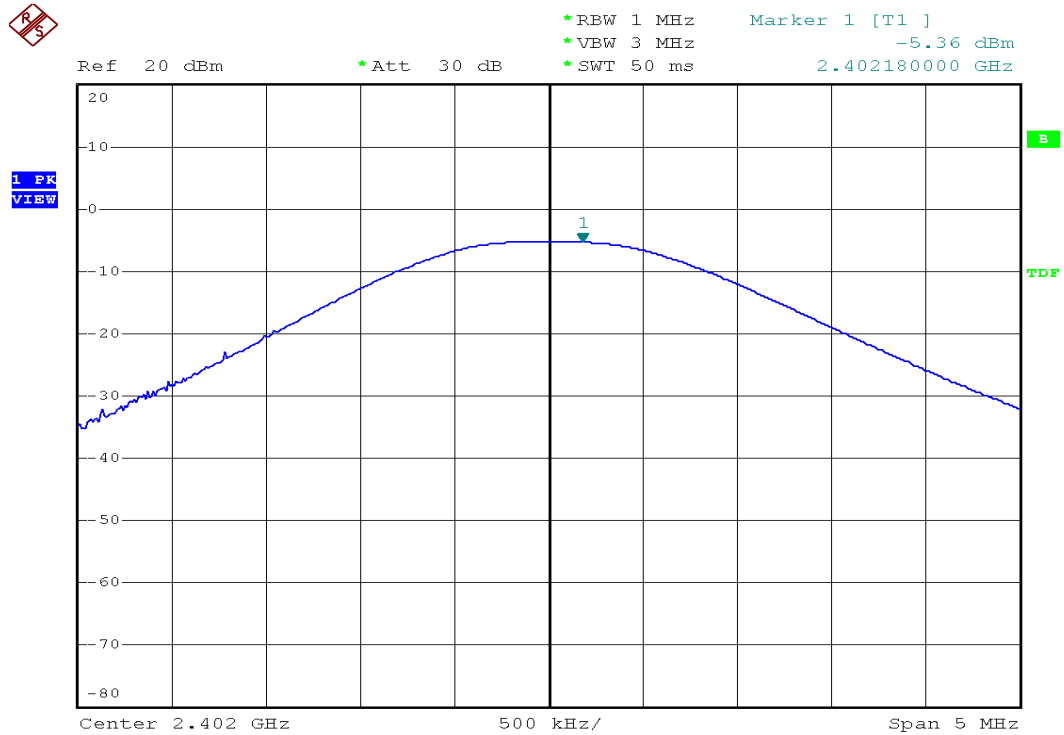

Modulation Standard: GFSK (1Mbps)
Channel: 39

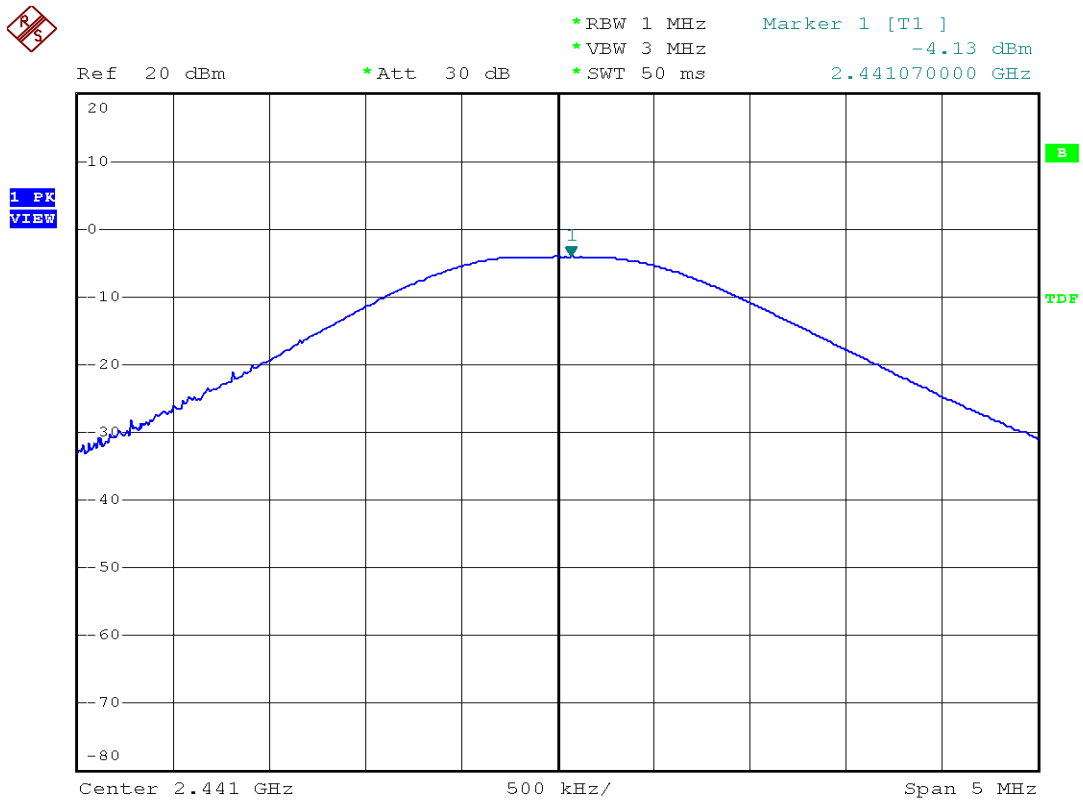



Modulation Standard: GFSK (1Mbps)
Channel: 78

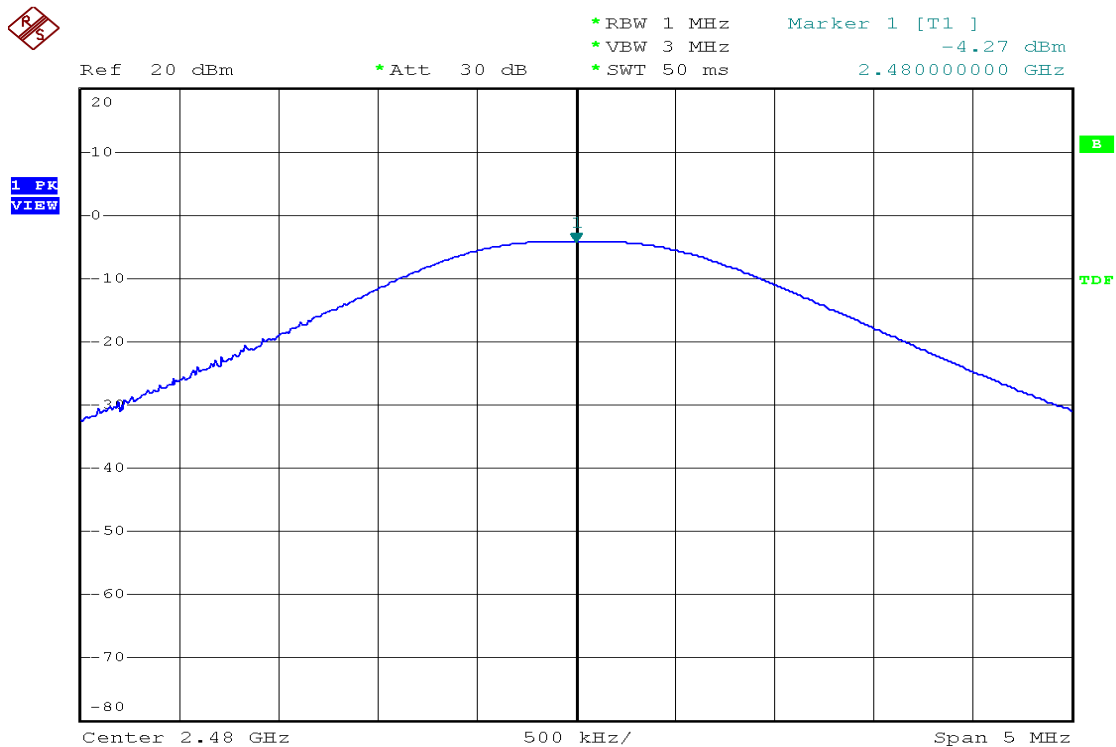

Modulation Standard: $\pi/4$ -DQPSK (2Mbps)
Channel: 00

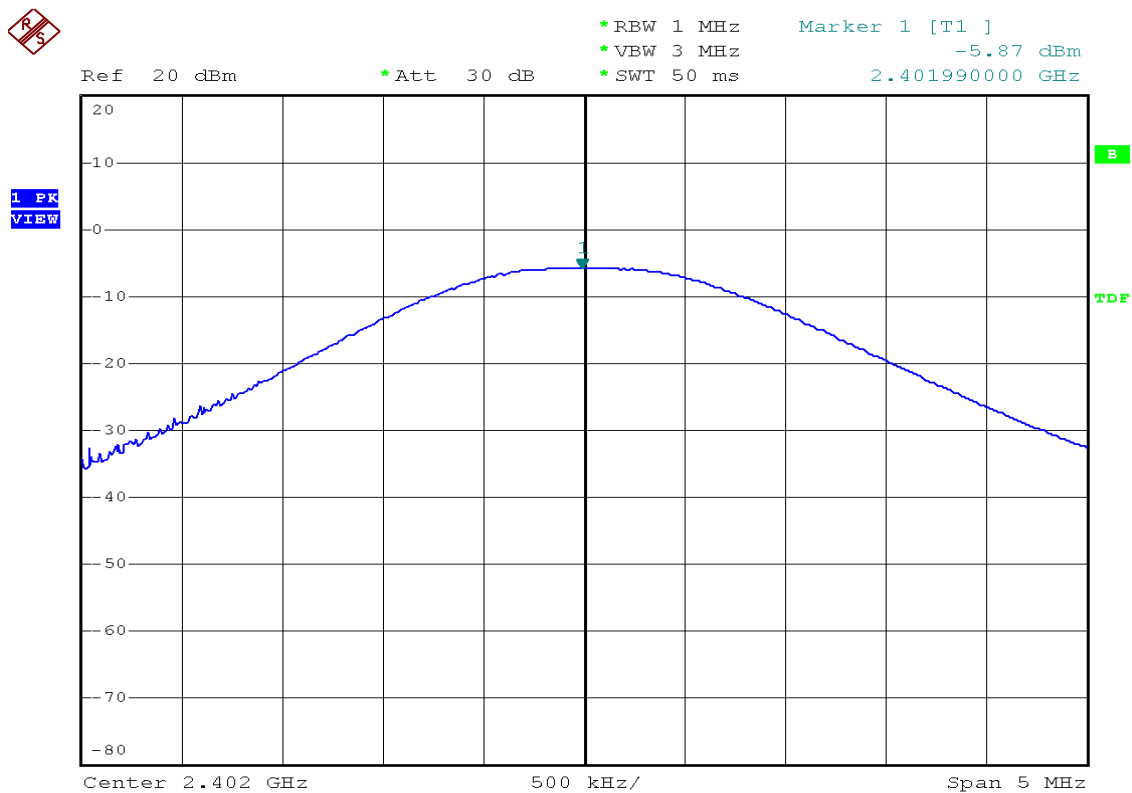



Modulation Standard: $\pi/4$ -DQPSK (2Mbps)
Channel: 39

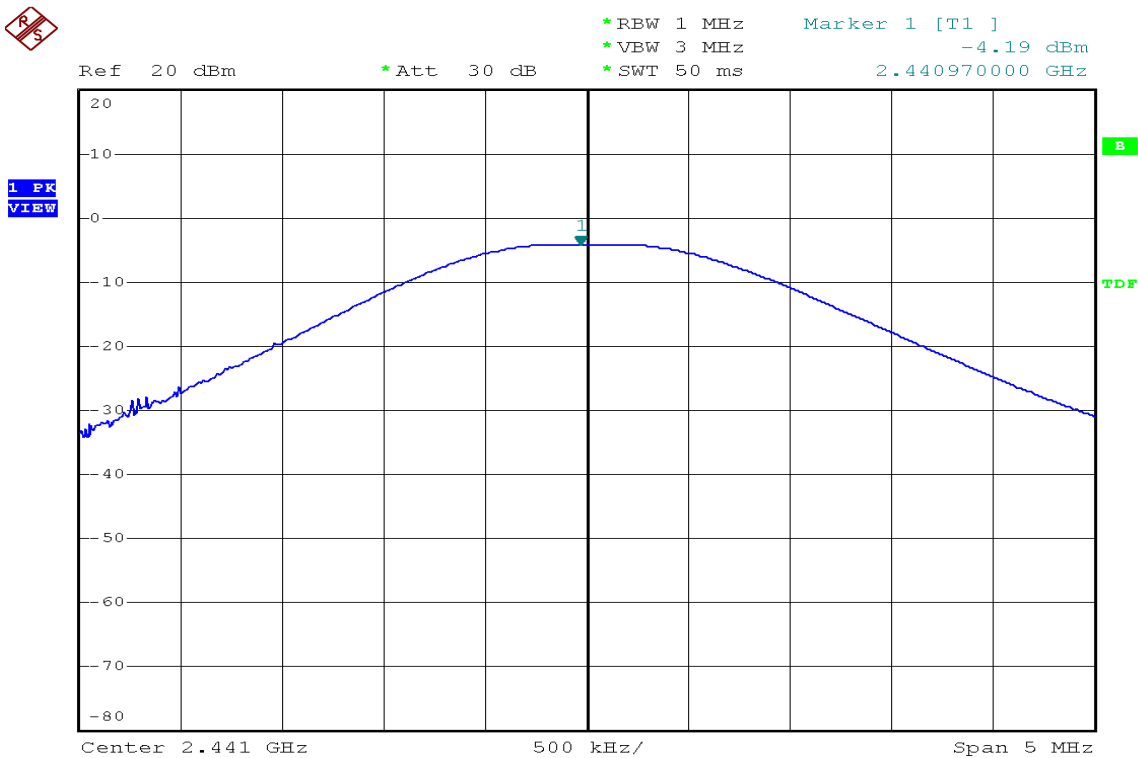

Modulation Standard: $\pi/4$ -DQPSK (2Mbps)
Channel: 78

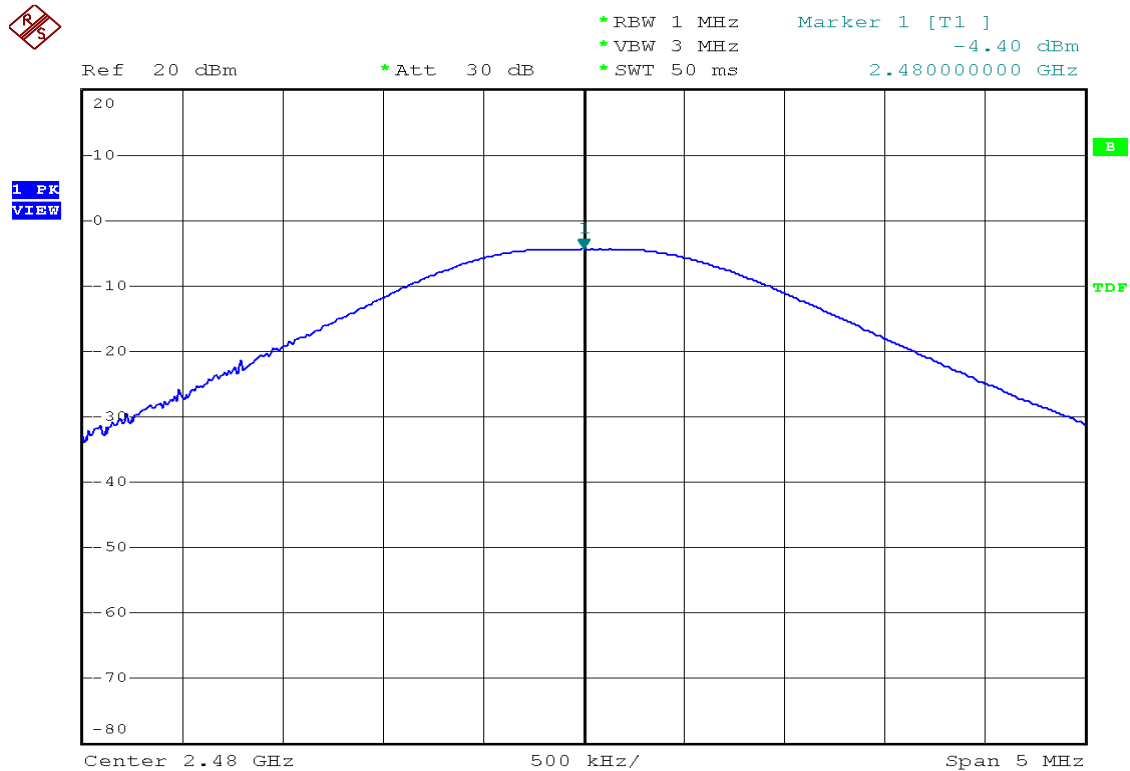



Modulation Standard: 8DPSK (3Mbps)
Channel: 00



Ref 20 dBm *Att 30 dB *RBW 1 MHz Marker 1 [T1] -5.64 dBm
*VBW 3 MHz *SWT 50 ms 2.402150000 GHz

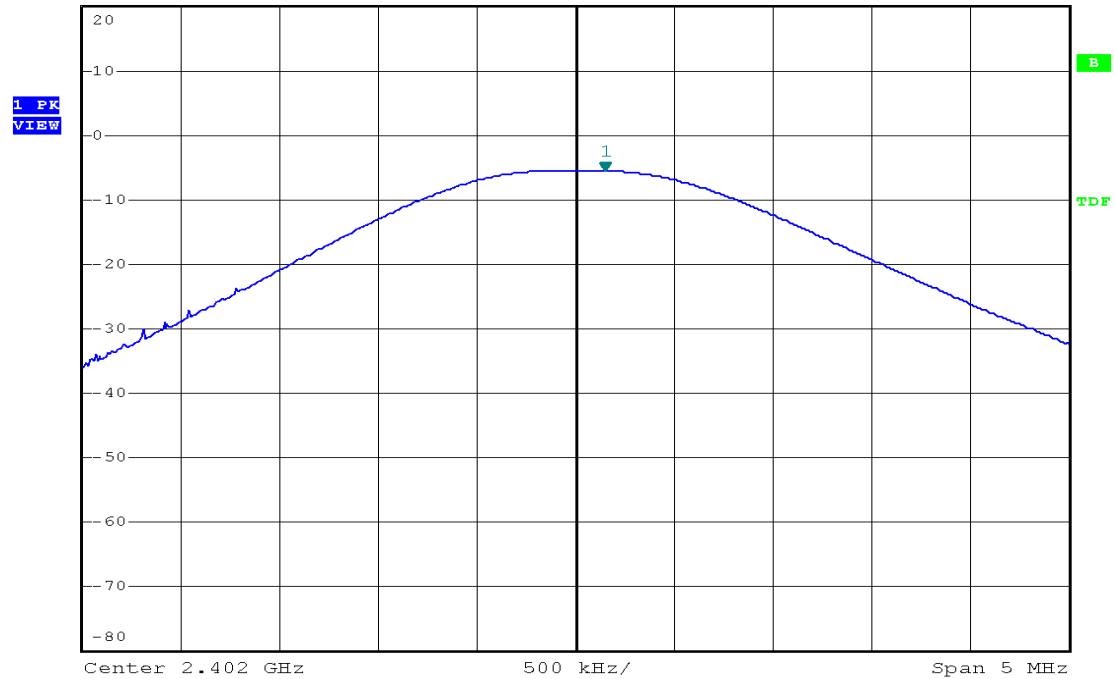

Modulation Standard: 8DPSK (3Mbps)
Channel: 39



Ref 20 dBm *Att 30 dB *RBW 1 MHz Marker 1 [T1] -4.03 dBm
*VBW 3 MHz *SWT 50 ms 2.441020000 GHz

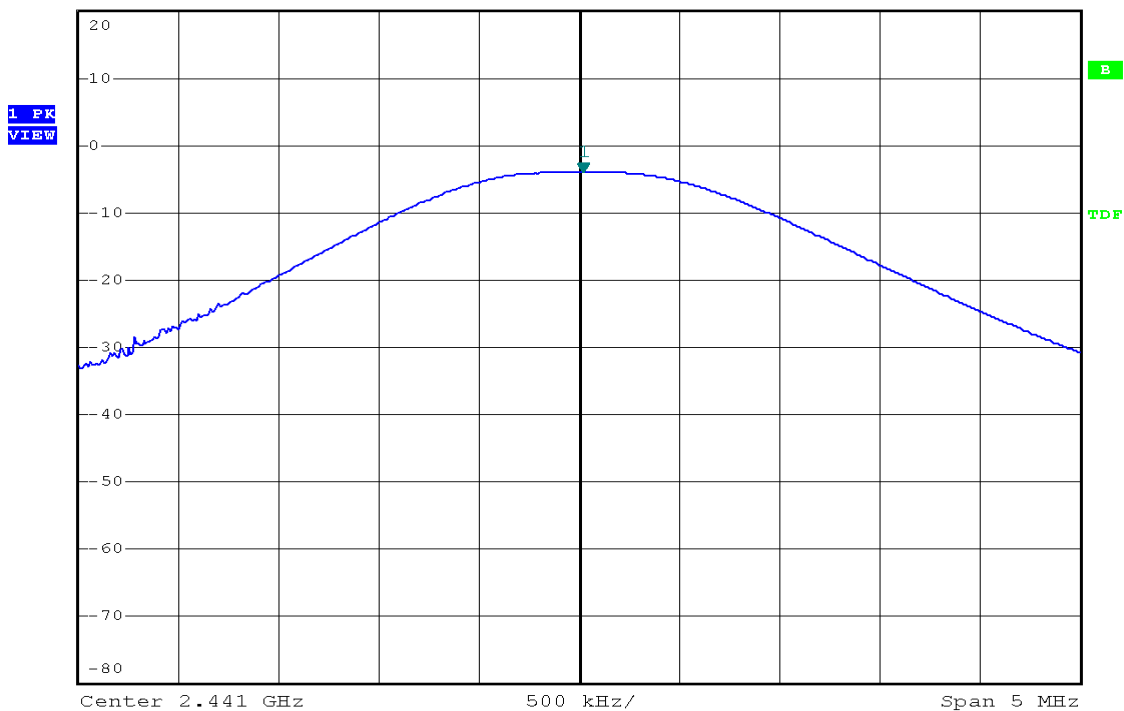



Modulation Standard: 8DPSK (3Mbps)
Channel: 78



*RBW 1 MHz Marker 1 [T1]
*VBW 3 MHz -4.45 dBm
*SWT 50 ms 2.479910000 GHz

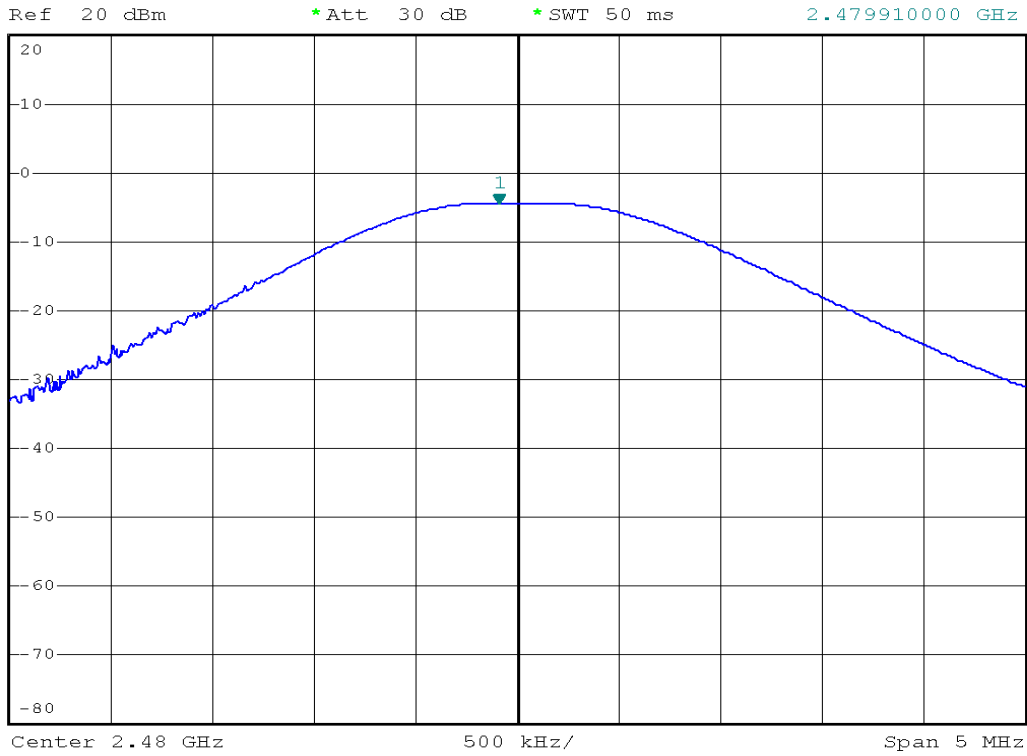



11. Band Edges Measurement

11.1 Test Limit

Below -20dB of the highest emission level of operating band (in 100kHz Resolution Bandwidth).

11.2 Test Procedure :

- a. The transmitter output was connected to the spectrum analyzer via a low lose cable.
- b. Set both RBW and VBW of spectrum analyzer to 100 KHz with convenient frequency span including 100 KHz bandwidth from band edge.
- c. The band edges was measured and recorded.

11.3 Test Setup Layout

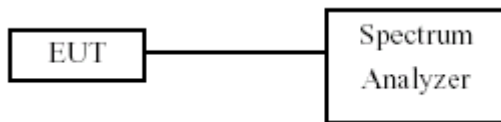

11.4 List of Measuring Equipment Used

Instrument/Ancillary	Model No.	Manufacturer	Serial No.	Calibration Date	Valid Date
Spectrum Analyzer	FSP40	R&S	10047	2009/03/26	2010/03/25



11.5 Test Result and Data

Modulation Standard: GFSK (1Mbps)

Test Date: Jul. 02, 2009

Temperature: 24°C

Atmospheric pressure: 1012 hPa

Humidity: 57%

Channel	Frequency	maximum value in frequency (MHz)	maximum value is (dBm)
00	2402	2395.68	-51.47
78	2480	2486.32	-51.88

Modulation Standard: $\pi/4$ -DQPSK (2Mbps)

Test Date: Jul. 02, 2009

Temperature: 24°C

Atmospheric pressure: 1014 hPa

Humidity: 64%

Channel	Frequency	maximum value in frequency (MHz)	maximum value is (dBm)
00	2402	2395.60	-51.36
78	2480	2486.48	-50.82

Modulation Standard: 8DPSK (3Mbps)

Test Date: Jul. 02, 2009

Temperature: 24°C

Atmospheric pressure: 1014 hPa

Humidity: 64%

Channel	Frequency	maximum value in frequency (MHz)	maximum value is (dBm)
00	2402	2395.76	-53.17
78	2480	2486.40	-52.87



Modulation Standard: GFSK (1Mbps)
Channel: 00



Ref 10 dBm *Att 20 dB *RBW 100 kHz Marker 1 [T1]
*VBW 300 kHz -51.47 dBm
*SWT 115 ms 2.395680000 GHz

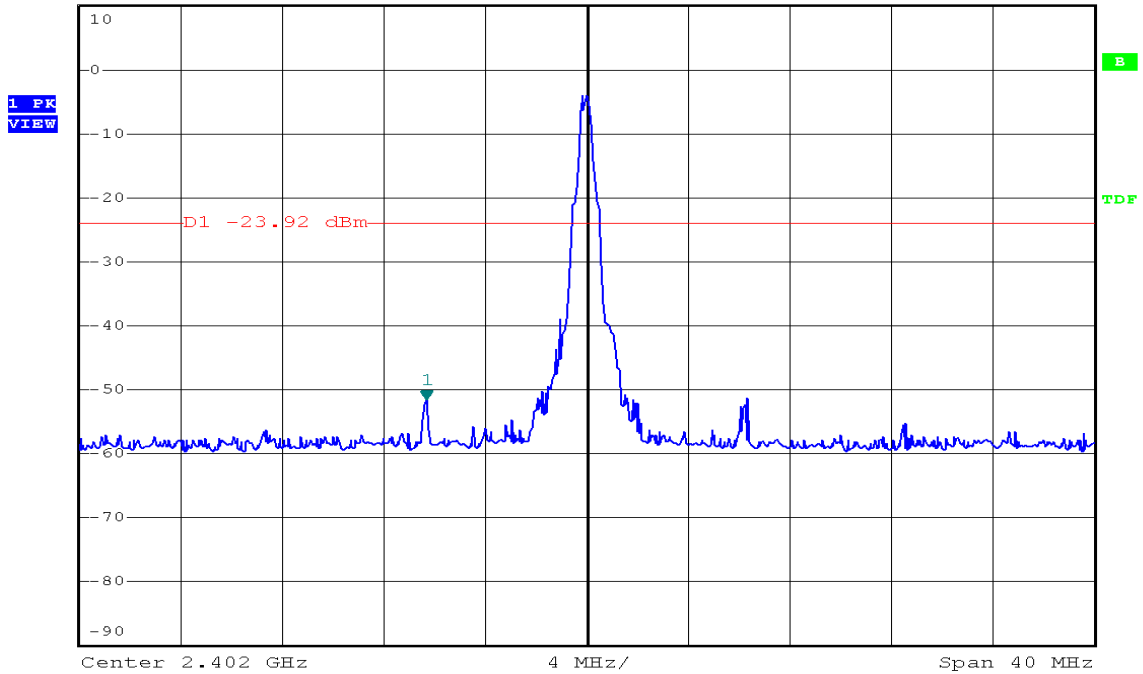

Ref 0 dBm *Att 10 dB *RBW 100 kHz Marker 1 [T1]
*VBW 300 kHz -62.67 dBm
*SWT 2.5 s 20.225760000 GHz

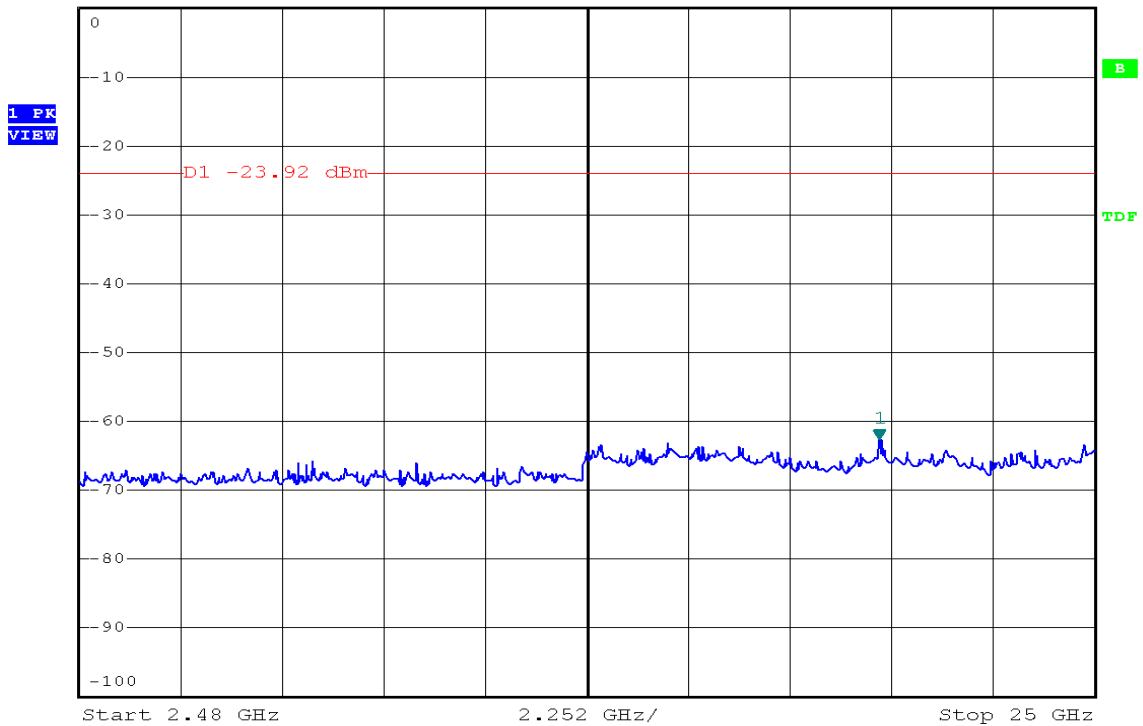



Modulation Standard: GFSK (1Mbps)
Channel: 78

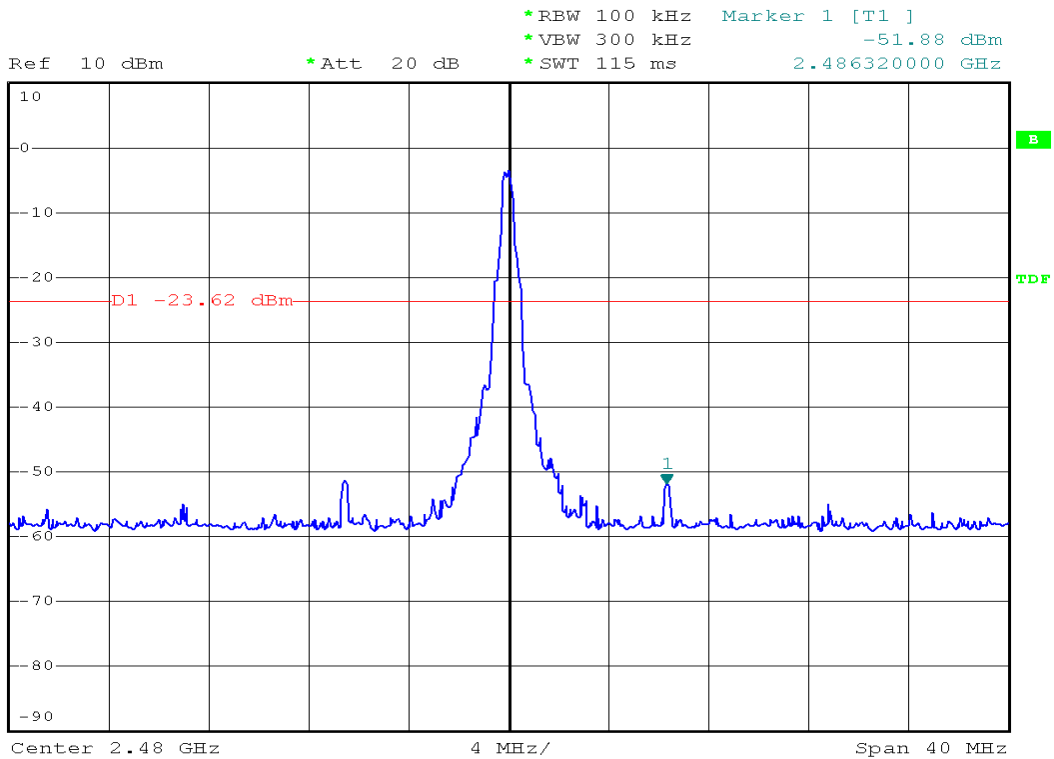



Modulation Standard: $\pi/4$ -DQPSK (2Mbps)
Channel: 00



Ref 10 dBm *Att 20 dB *RBW 100 kHz Marker 1 [T1]
*VBW 300 kHz -51.36 dBm
*SWT 115 ms 2.395600000 GHz

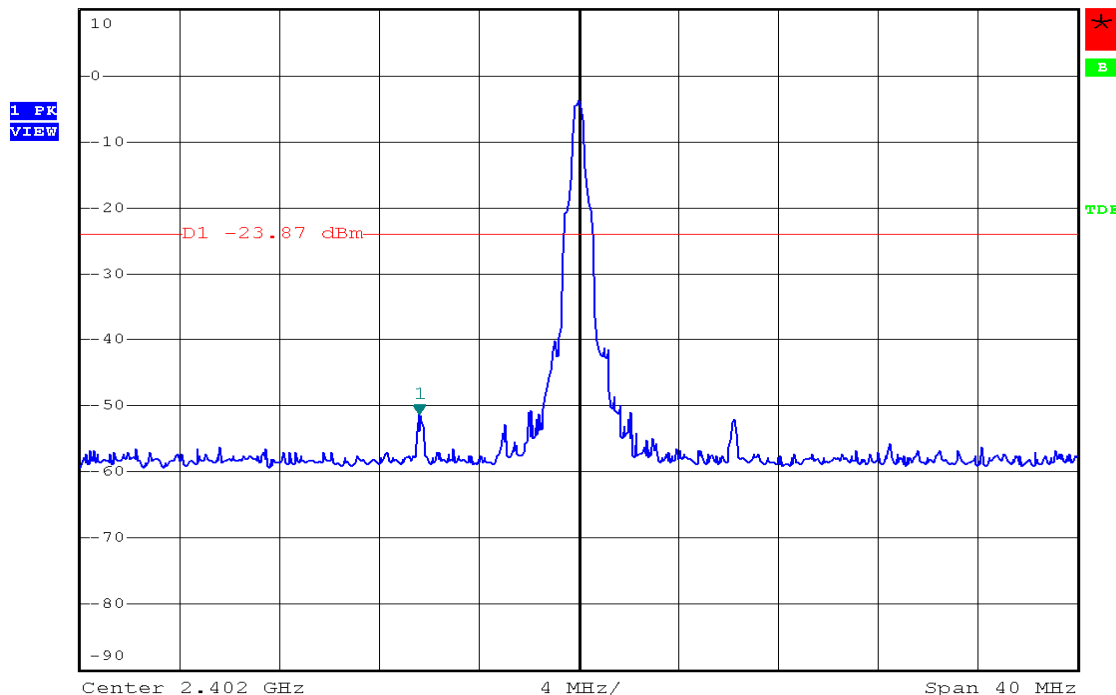

Ref 0 dBm *Att 10 dB *RBW 100 kHz Marker 1 [T1]
*VBW 300 kHz -63.04 dBm
*SWT 2.5 s 15.631680000 GHz

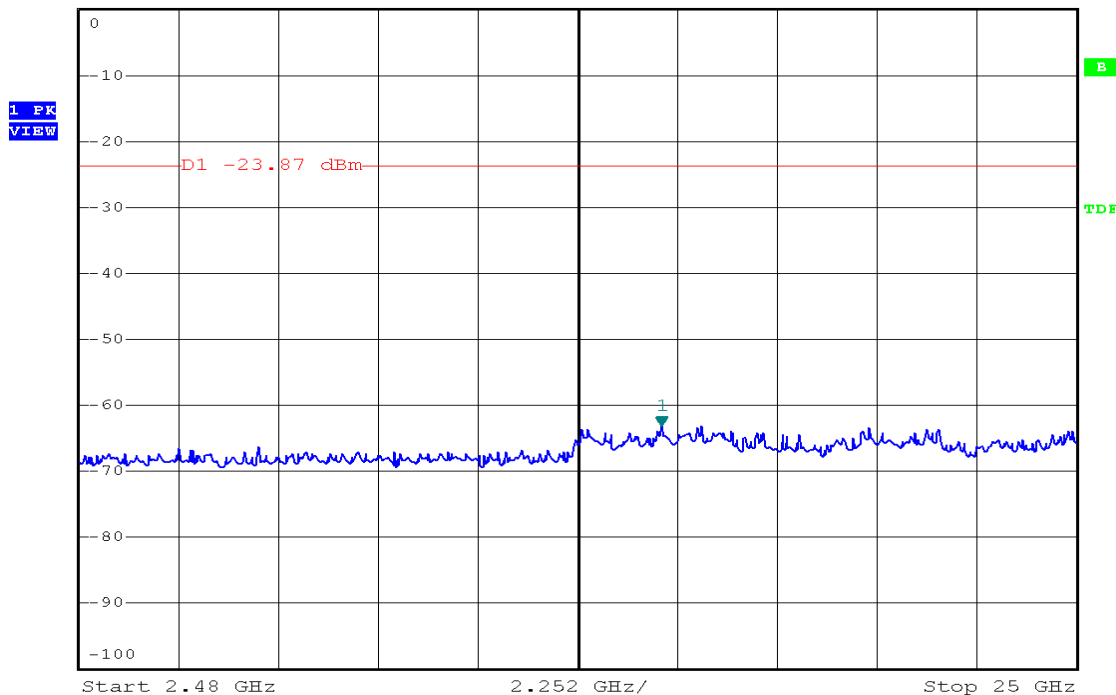



Modulation Standard: $\pi/4$ -DQPSK (2Mbps)
Channel: 78

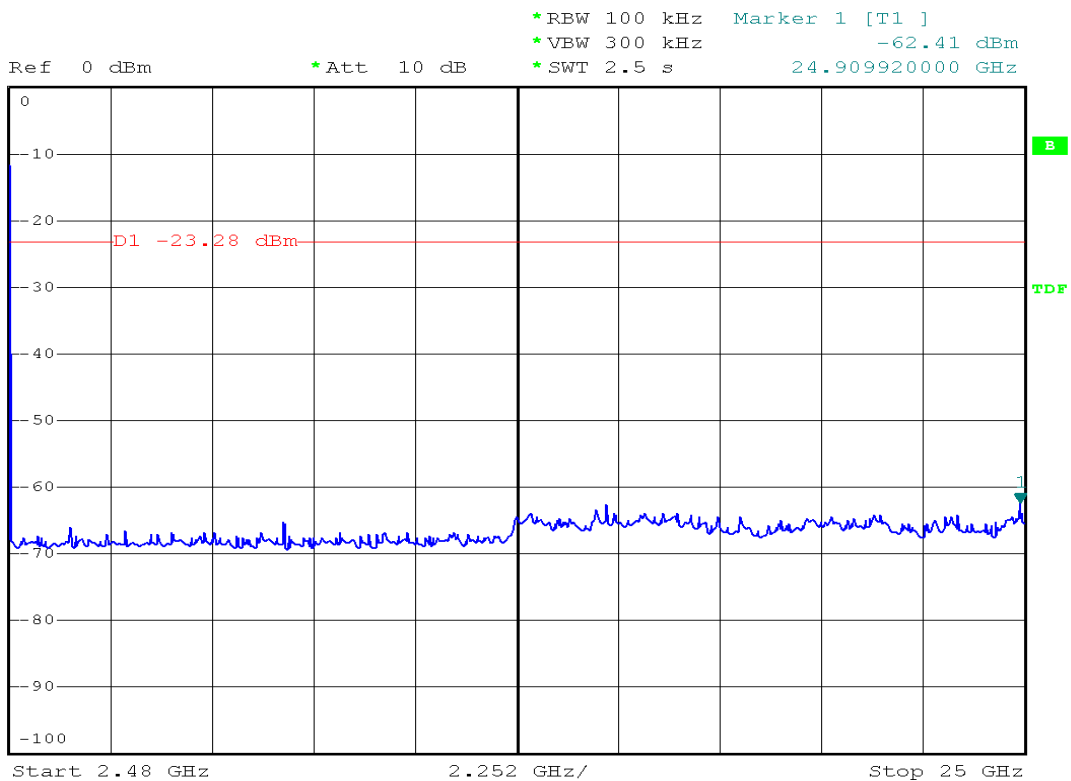
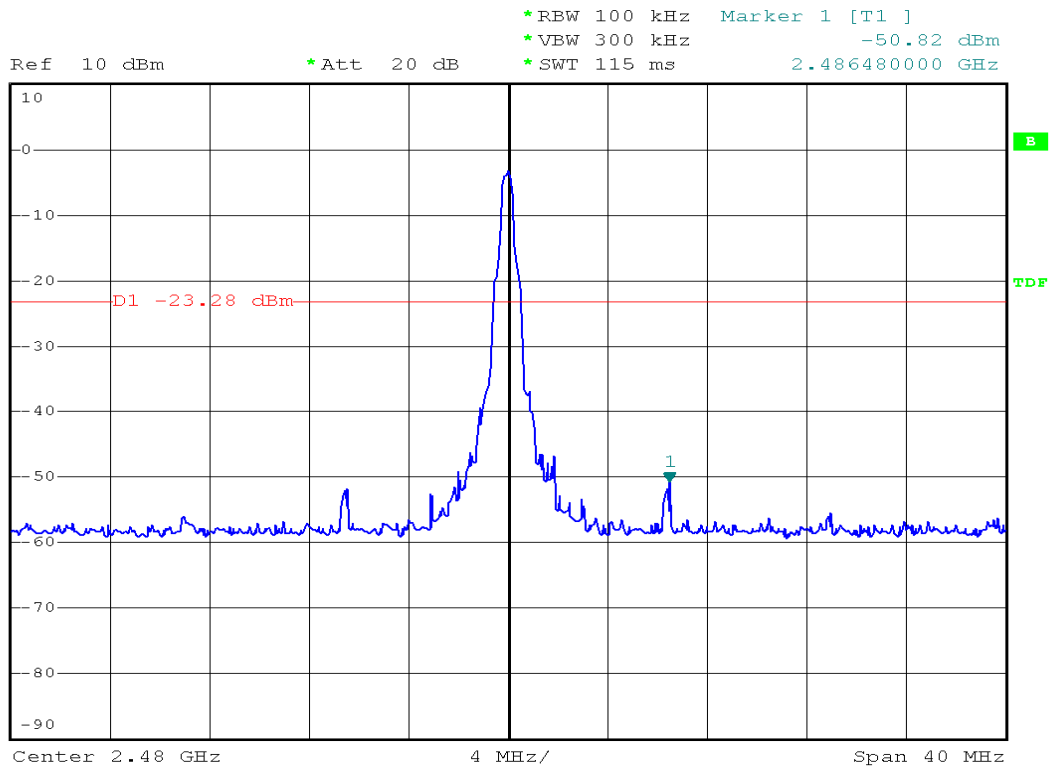



Modulation Standard: 8DPSK (3Mbps)
Channel: 00

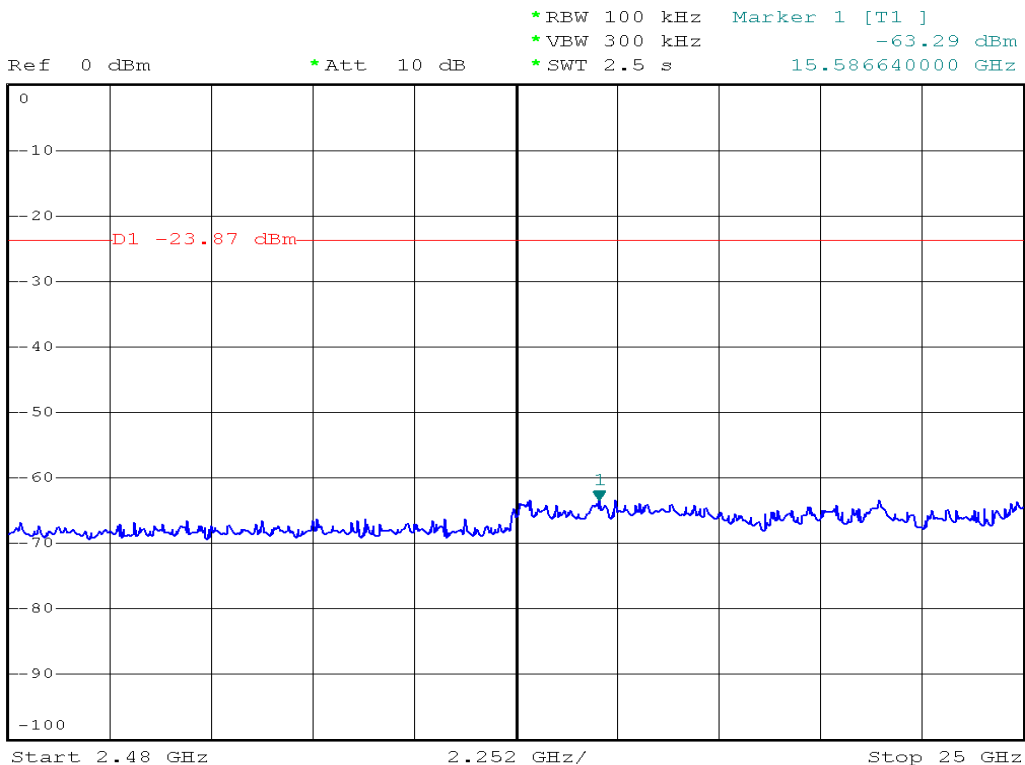
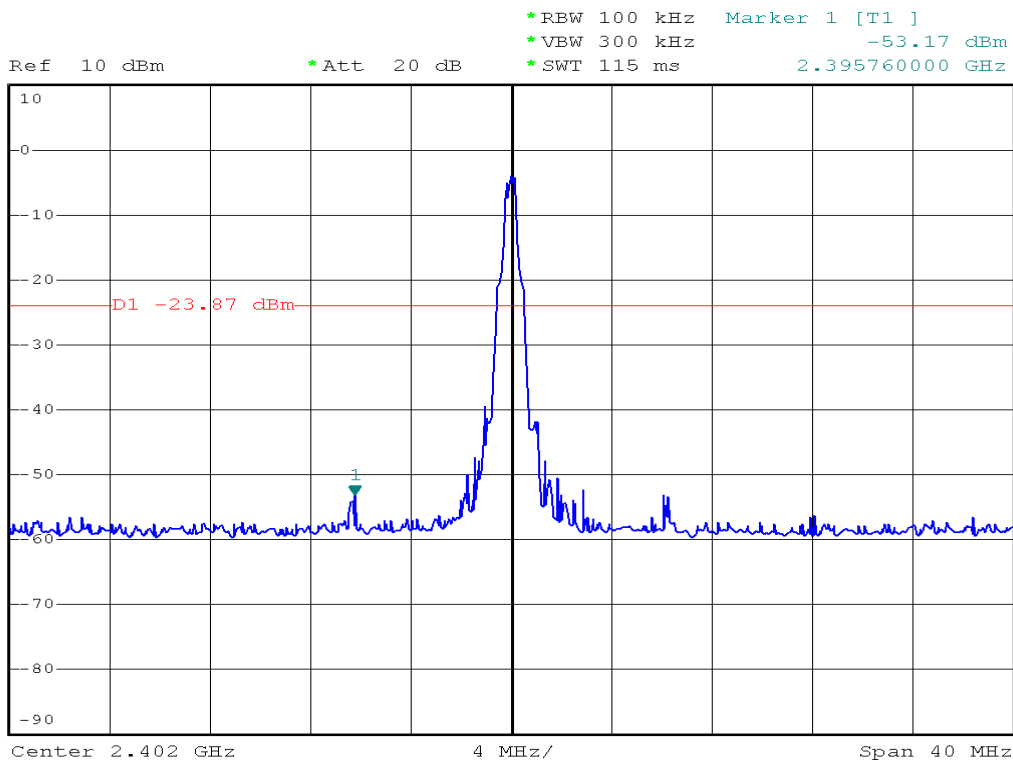



Modulation Standard: 8DPSK (3Mbps)
Channel: 78

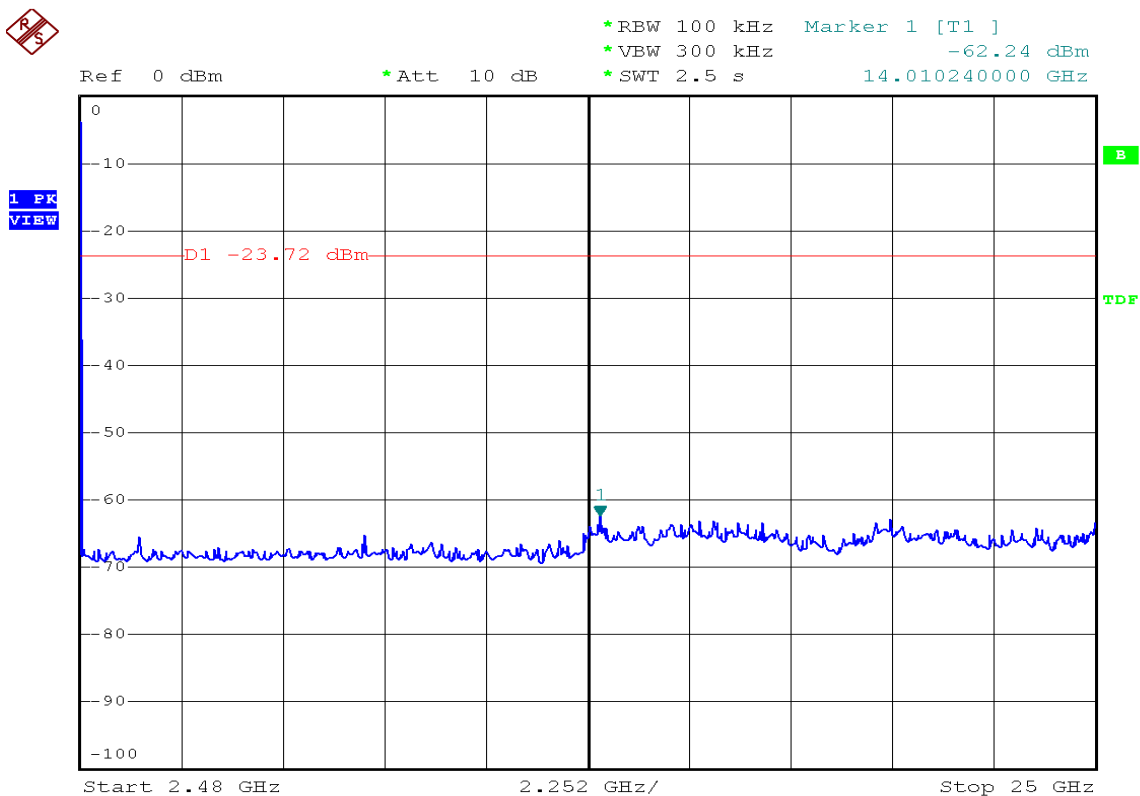
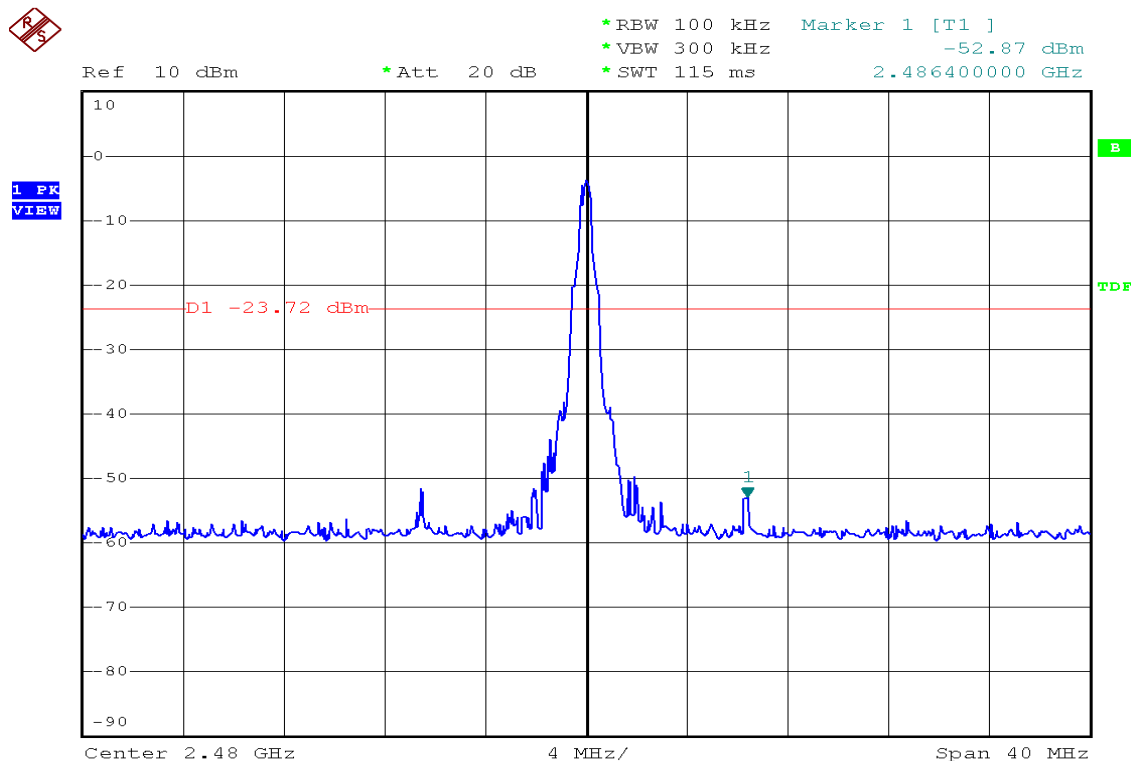

**11.6 Restrict band emission Measurement Data**

Test Date : Jul. 10, 2009
 Temperature : 26°C
 Humidity : 60%
 Atmospheric Pressure : 1007 hPa
 Modulation Standard : GFSK (1Mbps)

Channel 0						Fundamental Frequency: 2402 MHz				
Frequency (MHz)	Ant-Pol H/V	Meter Reading	Corrected Factor	Result (dBuV/m)	Remark	Limit@3m (dBuV/m)		Margin (dB)	Table (Deg.)	Ant High (m)
						Peak	Ave.			
2385.89	H	53.30	-4.93	48.37	Peak	74	54	-25.63	176	1.0
2385.89	H	40.57	-4.93	35.64	Ave	74	54	-18.36	176	1.0
2385.89	V	51.61	-4.93	46.68	Peak	74	54	-27.32	206	1.5
2385.89	V	39.87	-4.93	34.94	Ave	74	54	-19.06	206	1.5
Channel 78						Fundamental Frequency: 2480 MHz				
2483.51	H	55.90	-4.59	51.31	Peak	74	54	-22.69	170	1.21
2483.51	H	40.63	-4.59	36.04	Ave	74	54	-17.96	170	1.21
2483.51	V	53.23	-4.59	48.64	Peak	74	54	-25.36	176	1.5
2483.51	V	39.65	-4.59	35.06	Ave	74	54	-18.94	176	1.5

Test Date : Jul. 10, 2009
 Temperature : 26°C
 Humidity : 60%
 Atmospheric Pressure : 1007 hPa
 Modulation Standard : $\pi/4$ -DQPSK (2Mbps)

Channel 0						Fundamental Frequency: 2402 MHz				
Frequency (MHz)	Ant-Pol H/V	Meter Reading	Corrected Factor	Result (dBuV/m)	Remark	Limit@3m (dBuV/m)		Margin (dB)	Table (Deg.)	Ant High (m)
						Peak	Ave.			
2385.89	H	52.57	-4.93	47.64	Peak	74	54	-26.36	176	1.0
2385.89	H	45.70	-4.93	40.77	Ave	74	54	-13.23	176	1.0
2385.89	V	51.04	-4.93	46.11	Peak	74	54	-27.89	208	1.5
2385.89	V	43.29	-4.93	38.36	Ave	74	54	-15.64	208	1.5
Channel 78						Fundamental Frequency: 2480 MHz				
2483.51	H	55.05	-4.59	50.46	Peak	74	54	-23.54	170	1.21
2483.93	H	46.08	-4.58	41.50	Ave	74	54	-12.50	170	1.21
2483.93	V	52.64	-4.58	48.06	Peak	74	54	-25.94	176	1.5
2483.93	V	43.30	-4.58	38.72	Ave	74	54	-15.28	176	1.5



Test Date : Jul. 10, 2009
 Temperature : 26°C
 Humidity : 60%
 Atmospheric Pressure : 1007 hPa
 Modulation Standard : 8DPSK (3Mbps)

Channel 0						Fundamental Frequency: 2402 MHz				
Frequency (MHz)	Ant-Pol H/V	Meter Reading	Corrected Factor	Result (dBuV/m)	Remark	Limit@3m (dBuV/m)		Margin (dB)	Table (Deg.)	Ant High (m)
						Peak	Ave.			
2385.89	H	52.31	-4.93	47.38	Peak	74	54	-26.62	176	1.0
2385.89	H	45.64	-4.93	40.71	Ave	74	54	-13.29	176	1.0
2385.89	V	51.92	-4.93	46.99	Peak	74	54	-27.01	207	1.5
2485.89	V	43.79	-4.93	38.86	Ave	74	54	-15.14	207	1.5
Channel 78						Fundamental Frequency: 2480 MHz				
2483.81	H	55.89	-4.58	51.31	Peak	74	54	-22.69	170	1.21
2483.93	H	48.30	-4.58	43.72	Ave	74	54	-19.28	170	1.21
2484.00	V	53.84	-4.58	49.26	Peak	74	54	-24.74	176	1.5
2483.93	V	45.73	-4.58	41.15	Ave	74	54	-12.85	176	1.5

Notes:

1. Result = Meter Reading + Factor
2. Factor = Antenna Factor + Cable Loss – Amplifier
3. The resolution bandwidth of test receiver/spectrum analyzer is 1 MHz and video bandwidth is 3 MHz for Peak detection at frequency above 1GHz.
4. The resolution bandwidth of test receiver/spectrum analyzer is 1MHz and video bandwidth is 10Hz for Average detection at frequency above 1GHz



12. Restricted Bands of Operation

Only spurious emissions are permitted in any of the frequency bands listed below:

MHz	MHz	MHz	GHz
0.09000 – 0.11000	16.42000 – 16.42300	399.9 – 410.0	4.500 – 5.250
0.49500 – 0.505**	16.69475 – 16.69525	608.0 – 614.0	5.350 – 5.460
2.17350 – 2.19050	16.80425 – 16.80475	960.0 – 1240.0	7.250 – 7.750
4.12500 – 4.12800	25.50000 – 25.67000	1300.0 – 1427.0	8.025 – 8.500
4.17725 – 4.17775	37.50000 – 38.25000	1435.0 – 1626.5	9.000 – 9.200
4.20725 – 4.20775	73.00000 – 74.60000	1645.5 – 1646.5	9.300 – 9.500
6.21500 – 6.21800	74.80000 – 75.20000	1660.0 – 1710.0	10.600 – 12.700
6.26775 – 6.26825	108.00000 – 121.94000	1718.8 – 1722.2	13.250 – 13.400
6.31175 – 6.31225	123.00000 – 138.00000	2200.0 – 2300.0	14.470 – 14.500
8.29100 – 8.29400	149.90000 – 150.05000	2310.0 – 2390.0	15.350 – 16.200
8.36200 – 8.36600	156.52475 – 156.52525	2483.5 – 2500.0	17.700 – 21.400
8.37625 – 8.38675	156.70000 – 156.90000	2655.0 – 2900.0	22.010 – 23.120
8.41425 – 8.41475	162.01250 – 167.17000	3260.0 – 3267.0	23.600 – 24.000
12.29000 – 12.29300	167.72000 – 173.20000	3332.0 – 3339.0	31.200 – 31.800
12.51975 – 12.52025	240.00000 – 285.00000	3345.8 – 3358.0	36.430 – 36.500
12.57675 – 12.57725	322.00000 – 335.40000	3600.0 – 4400.0	Above 38.6
13.36000 – 13.41000			

** : Until February 1, 1999, this restricted band shall be 0.490-0.510 MHz

12.1 Labeling Requirement

The device shall bear the following statement in a conspicuous location on the device:

This device complies with part 15 of the FCC Rules. Operation is subject to the following two conditions: (1) This device may not cause harmful interference, and (2) this device must accept any interference received, including interference that may cause undesired operation.