

PARTNER



OT-310

Handheld POS Terminal

User's Manual

Table of Contents

Introduction	1
Features	1
Package Contents	1
Product Overview	2
Front and Back	2
Left and Right	3
Top and Bottom	3
LED Indicators	4
Getting Started	5
Installing the Battery	5
Charging the Battery	6
Installing the Memory Card	7
Installing the SIM Card	7
Powering the Device On/Off	8
Sleep Mode	8
Unlocking the Screen	9
Using the Handheld POS Terminal	10
Understanding the Interface	10
Home Screen Overview	10
Status and Notifications	11
Using the Touch Screen	12
Managing the Home Screen	13
Opening Applications	14
Changing Basic Settings	15
Setting the Date and Time	15
Configuring Display Settings	16
Configuring Sound Settings	17
Managing Wireless and Network Settings	18
Connecting to Wireless Networks	18
Connecting to Bluetooth Devices	18
Configuring Language and Keyboard Settings	19
Changing the System Language	19
Changing the Input Settings	19
Using the User Dictionary	20
Advanced Settings	21
Configuring Location Services	21
Configuring Security Settings	21
Managing Accounts	22
Managing Storage Space	25

Application and Operation	26
Browser	26
Launching a Web Page	26
Viewing the Current Web Page	26
Managing Web Pages	27
Camera	28
Capturing Photos	28
Reviewing Photos	28
Configuring Camera Settings	29
Recording Videos	30
Reviewing Videos	30
Configuring Video Settings	31
Capturing Panorama Shots	32
Email	33
Setting up an Email Account	33
Viewing Emails	34
Composing and Sending an Email	35
Reading and Replying an Email	35
Deleting Emails	36
Adding Other Email Accounts	37
Customizing Email Settings	37
File Manager	38
Browsing Files	38
Managing Files and Folders	38
Gallery	39
Viewing Photos	39
Playing Videos	40
Playing Slideshow	40
Messaging	41
Creating and Sending a Text Message	41
Adding an Attachment to a Message	41
Configuring Messaging Settings	42
Music	43
Playing a Song	43
Creating a Playlist	44
Assigning a Song as Ringtone	44
Deleting a Song	45
Configuring the Sound Effect	45
People	46
Adding a New Contact	46
Importing Contacts	47
Backing Up Contacts	48
Managing Contacts	49
Phone	51
Making a Call	51
Answering a Call	52



Viewing Call Log	52
Barcode Scanner Module	53
Configuring Barcode Reader Settings	53
Reading a Barcode	54
MSR Module	55
Configuring MSR Settings	55
Testing the MSR Module	56
Appendix	57
Specifications	57
Troubleshooting	59

Introduction

Meet the industry's first revolutionary handheld POS terminal. OT-310 is one of a kind mobile computer powered by Qualcomm's dual core processor. The design is sleek and light weight. It also passed IP54 sealing protection and is 1.5m drop resistant. Optional features for OT-310 are 1D or 2D barcode scanner and MSR or IC card. These modular features are combined in various ways to satisfy transportation and logistics, public sector and hospitality related application settings.

Features

Standard features:

- Dual core 1.5GHz CPU
- Android™ 4.2 OS
- WLAN 802.11 a/b/g/n
- WWAN GPRS/Edge/UMTS/HSDPA+
- Built-in GPS (accelerometer/ e-compass/gyroscope/ambient light/ vibrator)
- 5.0 Megapixels camera AF with LED flash
- Replaceable battery
- Support sunlight readable
- Gorilla class II touch screen
- 1.5m drop resistance and IP54

Optional features:

- 1D barcode scanner (laser) or 2D barcode scanner (image)
- RFID device 13.56MHz, built-in standard, ISO 14443 A/B, FeliCa R/W
- IC card reader ISO7816 or MSR ISO7811-Track 1, 2, 3

Package Contents

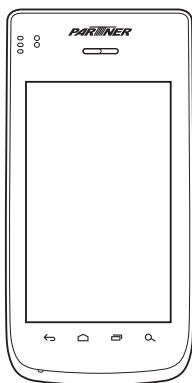

Handheld POS Terminal

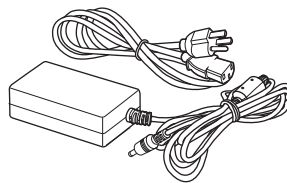

Power adaptor & cord

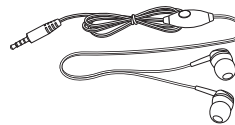

Headset



USB cable

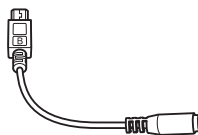

USB to DC cable



Quick Start Guide

Product Overview

Front and Back

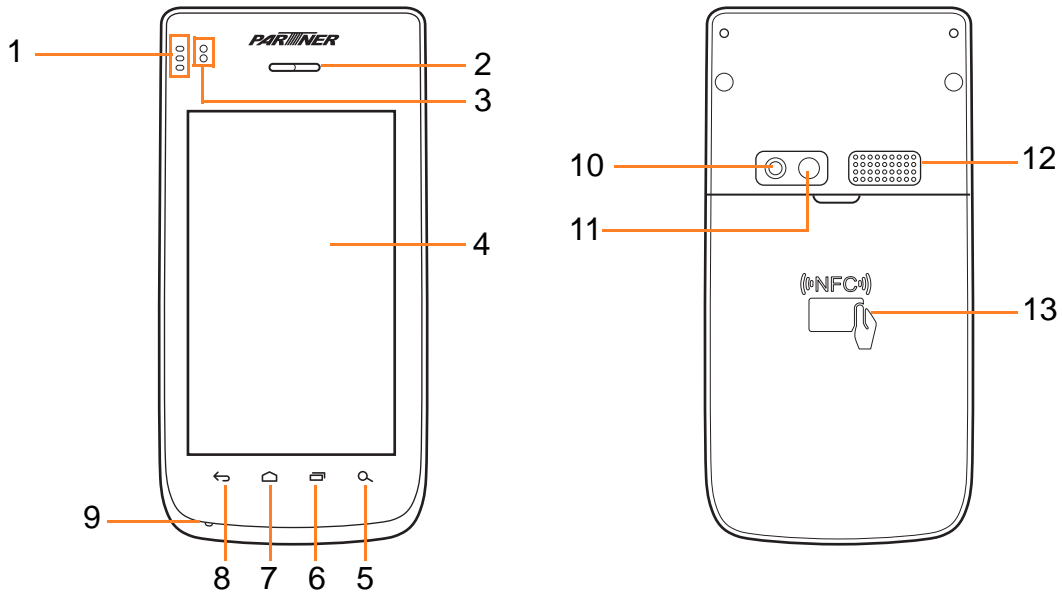

No.	Item	Description
1	3 LEDs	Used for power system and application notifications.
2	Receiver	Speaker for handheld phone calls.
3	Proximity and light sensor	Proximity sensor for detection of near objects (e.g., used for turning off touch display during voice calls). Light sensor for automatically adjusting display backlight to the environmental light.
4	Display with touch panel	<ul style="list-style-type: none"> Display the screen output. Touch and drag items on the screen to provide user input.
5	Search	Search action. Action depends on active application/view.
6	Recent App	Select a previously started activity.
7	Home	Touch to return to the Home screen.
8	Back	Return to previous activity.
9	Microphone	Audio input for voice calls and applications.
10	Flash LED	Flash LED for camera and applications.
11	Camera	For taking pictures or recording videos.
12	Speaker	Loudspeaker for ringtones, notifications, etc.
13	NFC	Read NFC tags and wireless smartcards.

Left and Right

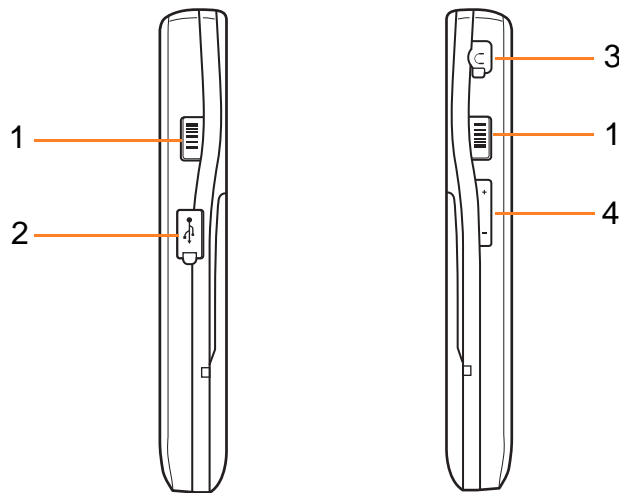

No.	Item	Description
1	Barcode scan trigger keys	Press to scan barcodes.
2	Micro USB OTG port	Connect to a USB cable for data transfer or battery charging purposes.
3	Earphone jack	3.5mm audio jack with same pin configuration as iPhone.
4	Volume keys	Press to adjust the volume.

Top and Bottom

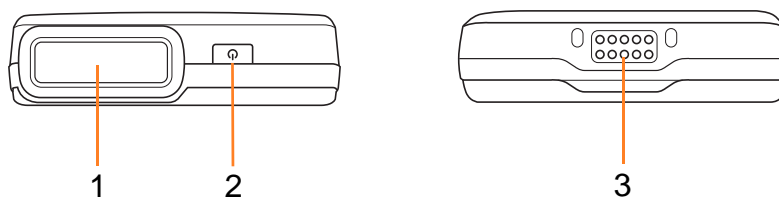

No.	Item	Description
1	Barcode scan window	Point this scan window to scan barcodes.
2	Power button	<ul style="list-style-type: none"> • Turn on/off the device. • Press once to put the device into Sleep mode. • Long press (~10s) for device hard reset.
3	Cradle connector	Connect to the cradle unit.

LED Indicators

The OT-310 handheld POS terminal has three LED indicators.

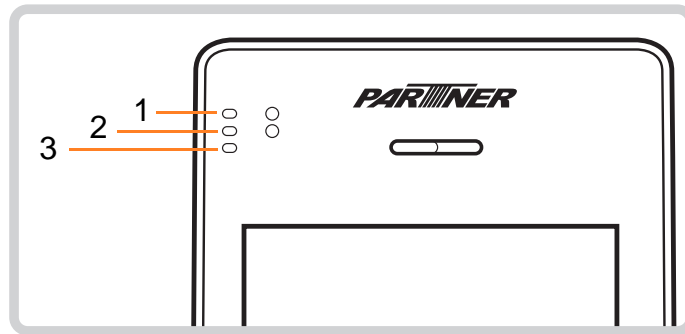

No.	Item	Description
1	Module indicator	Lit Green when 1D or 2D barcode scanner is activated.
2	Wireless indicator	Lit Green when wireless connection (3G, Wi-Fi, or Bluetooth) is activated.
3	Power indicator	<ul style="list-style-type: none"> • Lit Red when the battery is charging. • Lit Green when the battery is full.

Getting Started

Installing the Battery

1. Place the two thumbs on the back cover. One on the left and one on the right side of the NFC logo. Press firmly and slide down to open the battery cover. Lift up to remove the battery cover.

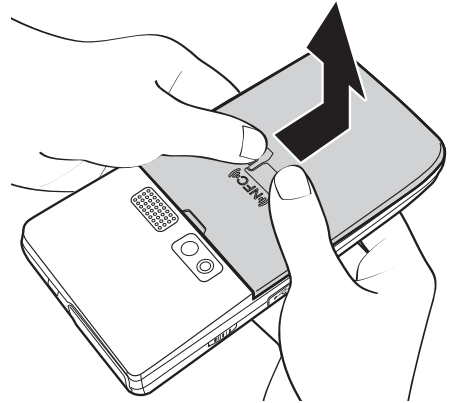

2. Align the battery connectors on the battery with the pins in the battery compartment. Then insert the battery.

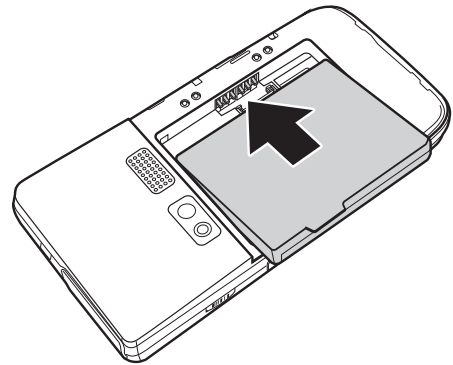

3. Replace the battery cover.

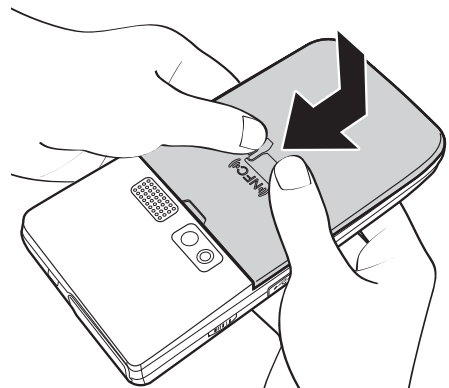

Charging the Battery

1. Open the protective cap.
2. Connect the device using the DC to USB cable and power adaptor.
3. Plug the other end of the power adaptor to the wall outlet to start charging.

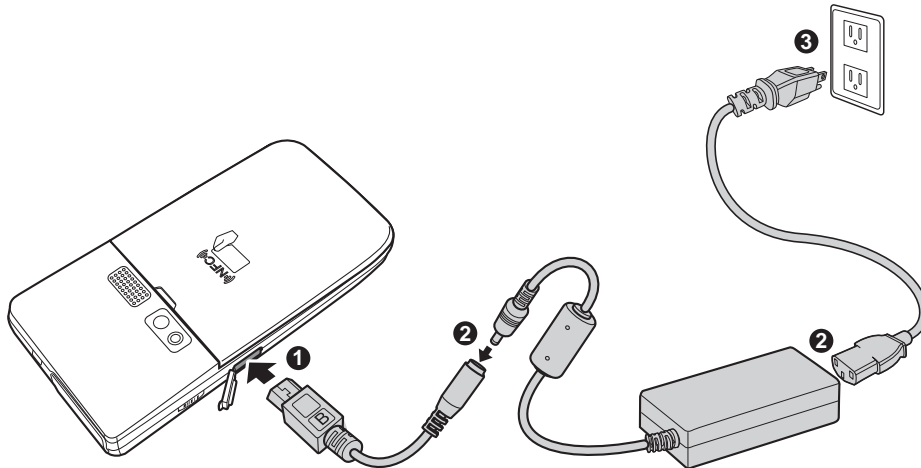

NOTE: Charging shall also be possible from PC via USB and via OT-310 cradle. Furthermore, any microUSB charger which is compliant with USB battery charging 1.2 (http://www.usb.org/developers/devclass_docs/USB_Battery_Charging_1.2.pdf) shall be acceptable.

When the battery is charging:

- The status LED lights red.
- When the device is turned on, the  icon is displayed on the top-right corner of the screen.

Installing the Memory Card

1. Remove the battery compartment cover and remove the battery and SIM card.
2. Unlock the memory card slot by sliding it toward the bottom of OT-310.

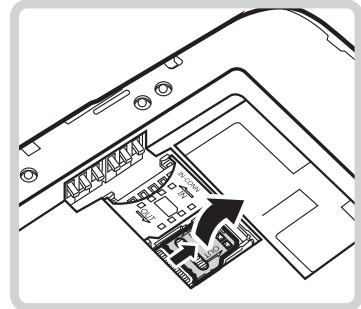

3. Insert a micro SD card into the memory card slot.

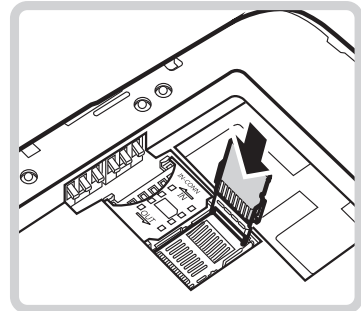

4. Gently place down the memory card slot. Lock the memory card slot by sliding it toward the top of OT-310.
5. Replace the SIM card and the battery.
6. Replace the battery cover.

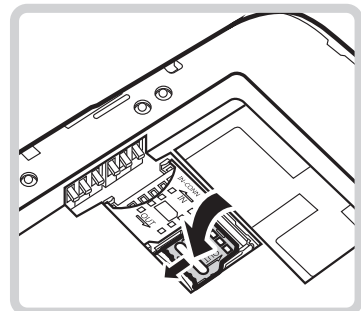

Installing the SIM Card

1. Remove the battery compartment cover and battery.
2. Insert the SIM card into the SIM card slot as shown in the illustration.
3. Replace the battery and the battery cover.

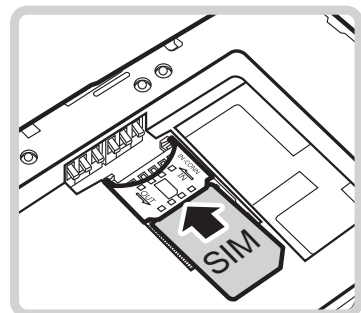

Powering the Device On/Off

To turn on the device:

Press and hold the **Power** button for 3 seconds to turn on the device.

To turn off the device:

1. Press and hold the **Power** button for at least 3 seconds.
2. Touch **Power off**.
3. A confirmation message appears on the screen. Touch **OK** to turn the device off.

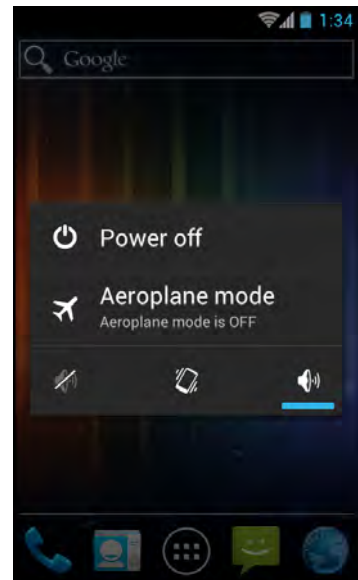

Sleep Mode

To save power, put the device to **Sleep** mode when not in use. In **Sleep** mode, the device is in **Power On** mode but the screen backlight is turned off.

- To put the device to **Sleep** mode, press the **Power** button once. The screen backlight turns off.
- To turn the backlight on, press the **Power** button again.

Unlocking the Screen

By default, the screen is locked after turning the device on, when leaving sleep mode or after a period of inactivity. The screen lock time can be set in Settings menu (see “Configuring Display Settings” on page 16).

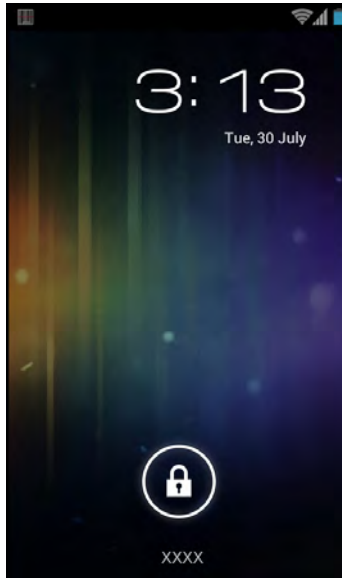

To unlock the screen, drag  towards . Or, drag  towards  to directly enter the **Camera** application.

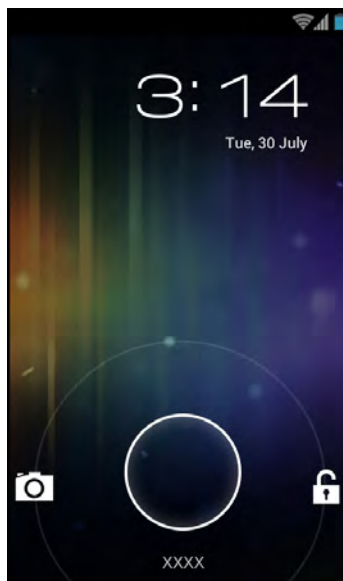

NOTE: When the  icon is touched, it automatically changes to .

Using the Handheld POS Terminal

Understanding the Interface

Home Screen Overview



No.	Item	Description
1	Status Bar	Display status icons and notifications. See “Status and Notifications” on page 11 for more information.
2	Home screen	Main screen display. <ul style="list-style-type: none"> • Touch items on the screen to select an application. • Swipe the finger left or right to change panels.
3	Search Bar	Touch to do a search on the internet, application, and contacts.
4	Shortcut application icon (Phone/People/Messaging/Browser)	Touch to open the Phone/People/Messaging/Browser application.
5	Application icon	Touch to display all applications installed on the device. See “Opening Applications” on page 14 for more information.

Status and Notifications

The Status Bar always appears on top of the screen and indicates different types of information.



No.	Item	Description
1	Barcode reader	Indicate the barcode reader is enabled.
2	Bluetooth icon	Indicate Bluetooth is enabled. To enable this function, see “Connecting to Bluetooth Devices” on page 18.
3	Wi-Fi icon	Indicate the Wi-Fi signal strength. To enable this function, see “Connecting to Wireless Networks” on page 18.
4	Cellular network icon	Indicate the cellular network signal strength.
5	Battery icon	Indicate the battery status.
6	Time	Display the system time. To correct the time, see “Setting the Date and Time” on page 15.

Drag the status bar downwards to display more information.

NOTE: Depending on the current application and available features for the device, the icons displayed on the status bar may vary.

Using the Touch Screen

The device is equipped with a 4.3-inch touch screen.

The following describes some tips on how to use the touch screen.

Touching

- Touch an icon displayed on the screen to select it.
- A pop-out menu may appear (depending on the function in use) by touching and holding on the screen.

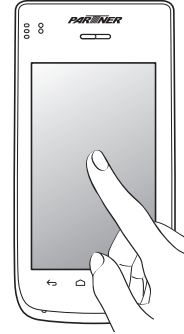

Scrolling

- **Scroll up/down:** slide the finger up/down on the screen.
- **Scroll right/left:** slide the finger right/left on the screen.

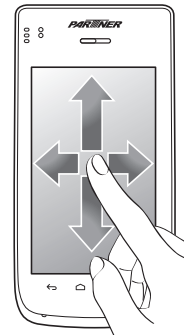

Dragging

Touch and hold an icon to move its position.



Pinching

- **Zoom in:** move the two fingers apart from each other at the specific area on the screen to zoom in.
- **Zoom out:** move the two fingers closer together at the specific area on the screen to zoom out.

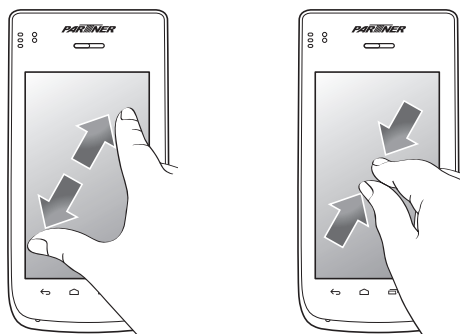

Managing the Home Screen

Add shortcut icons, widgets, and folders on the **Home** screen and change the wallpaper.

To change the wallpaper:

1. Touch and hold a blank space on the **Home** screen.
2. A pop up window appears. Touch one of the following:
 - **Gallery:** To use pictures saved on the device.
 - **Live Wallpapers:** To use pre-installed interactive wallpapers that came with the device.
 - **Wallpapers:** To use preset wallpapers that came with the device.

NOTE: Live wallpapers increase the power consumption and might reduce the user time.

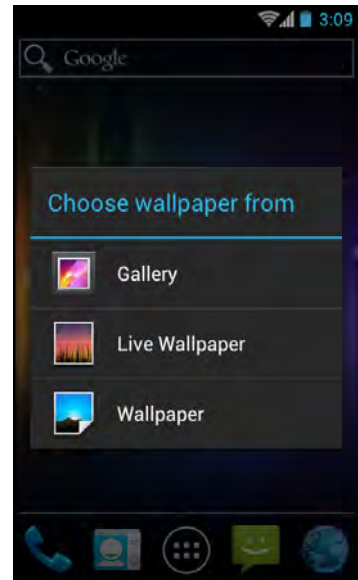

To add shortcut icons or widgets:

1. On the **Home** screen, touch  > **APPS** or **WIDGETS** tab to display the applications/widgets.
2. To add an item, touch and hold the application icon, then drag it to the specific **Home** screen.

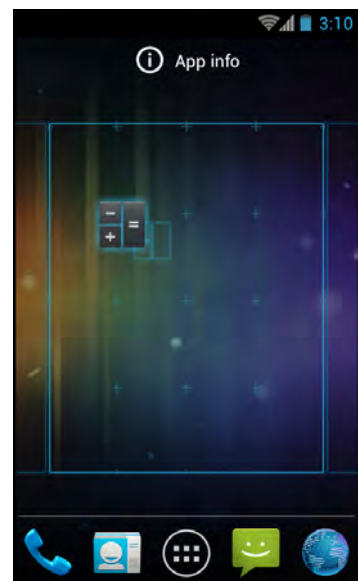

To move items:

Move items from one screen panel to another or rearrange the icons.

1. Touch and hold the desired item until the item is enlarged.
2. Drag and drop the item to the desired location.

To remove items:

1. Touch and hold the desired item to remove.
2. Drag and drop the item to the *Remove* icon until the item turns red.

The application icon is removed from the **Home** screen.

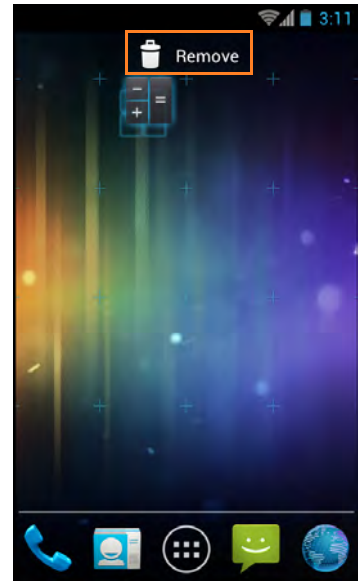

Opening Applications

Touch  > **APPS** tab to access the pre-installed applications and device settings.

- Touch an icon to open the application.
- Swipe the finger left or right to view more applications.

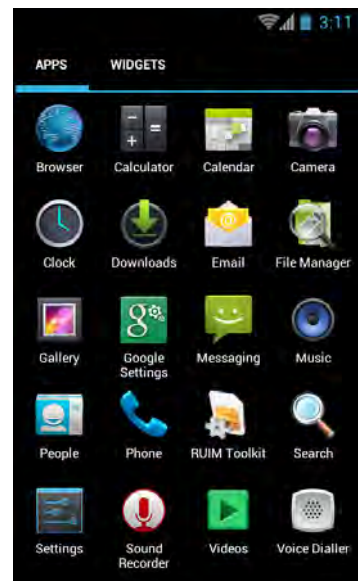

Changing Basic Settings

Setting the Date and Time

Adjust the date and time of the device to provide accurate operation. The time zone can also be set accordingly.

To automatically adjust date and time, perform the following:

1. On the **Home** screen, touch  > **Settings**.
2. In **SYSTEM**, touch **Date & time**.
3. Touch **Automatic date & time** checkbox to automatically set the date and time according to the network.

To manually adjust date and time, perform the following:

1. On the **Home** screen, touch  > **Settings**.
2. In **SYSTEM**, touch **Date & time**.
3. Uncheck **Automatic date & time** checkbox.
4. Touch **Set date** to set the date.
 - Touch ▲ or ▼ on the related field item to adjust the value. Touch **Set** to apply the values.
 - To change the date time format, touch **Select date format**, and select the date format from the list
5. Touch **Select time zone** to select the time zone from the list.
6. Touch **Set time** to set the time.
 - Touch ▲ or ▼ on the related field item to adjust the time and touch **Set** to apply the values.
 - To use a 24-hour format, touch **Use 24-hour format** checkbox.

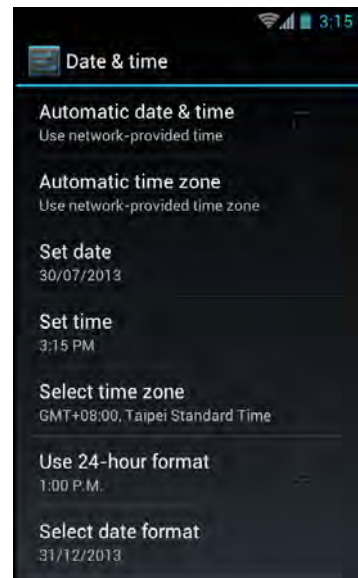

Configuring Display Settings

This device display can be configured in many ways to better suit the working environment.

To adjust the brightness, perform the following:

1. On the **Home** screen, touch  > **Settings**.
2. In **DEVICE**, touch **Display** > **Brightness**.
3. Drag the slider to adjust the brightness setting.
4. Touch **OK** to confirm.

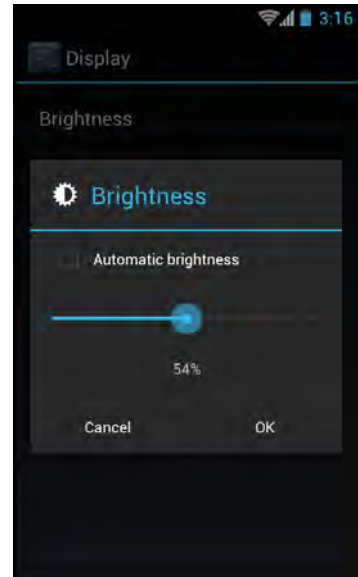

NOTE: To enable the device to automatically adjust the brightness of the screen depending on the surrounding light, touch **Automatic brightness** checkbox. Touch **OK** to confirm.

To specify the idle time before the device automatically enters **Sleep** mode, perform the following:

1. On the **Home** screen, touch  > **Settings**.
2. In **DEVICE**, touch **Display** > **Sleep**.
3. Select the desired setting.

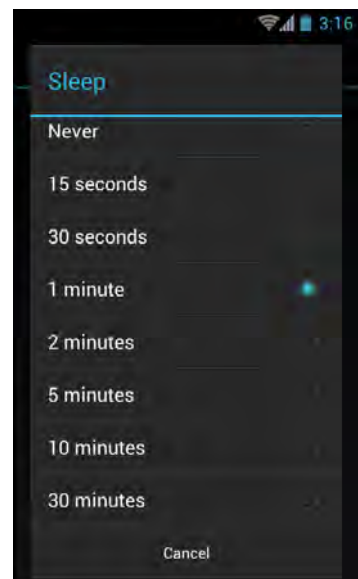

Configuring Sound Settings

This device has several sound settings such as general sound, ringtones, notifications, and alarms.

To adjust the volume, perform the following:

1. On the **Home** screen, touch  > **Settings**.
2. In **SOUND**, touch **Volumes**.
3. Drag the respective volume slide to adjust the volume.
4. Touch **OK** to confirm the settings.

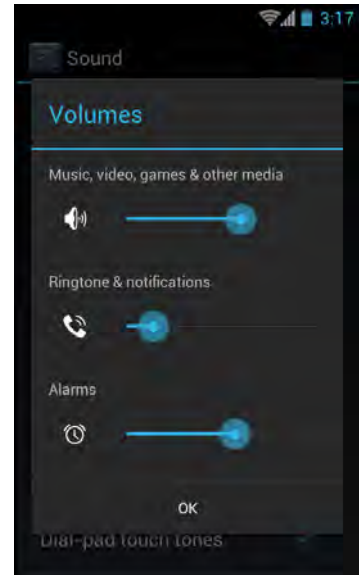

To customize the device ringtones and notifications, perform the following:

1. On the **Home** screen, touch  > **Settings**.
2. In **SOUND**, touch **Phone ringtone** or **Default notification**.
3. Select the desired setting from the available ringtone options.
4. Touch **OK** to confirm the settings.

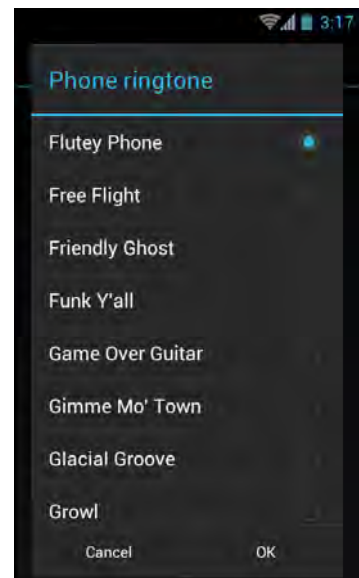

NOTE: To enable the device to vibrate for incoming call or notifications, touch **Vibrate and ring** checkbox.

Managing Wireless and Network Settings

Connecting to Wireless Networks

To connect to an available wireless network, perform the following:

1. On the **Home** screen, touch  > **Settings**.
2. In **WIRELESS & NETWORK**, touch **Wi-Fi** and set it to **ON** to enable the Wi-Fi function.
The device searches for available networks within range.
3. Touch an available network connection.
4. If prompted, enter the password to connect to the Wi-Fi network, then touch **Connect**.



NOTE: Password entry is required only for first time connection. Once the device is connected to a network and Wi-Fi is enabled on the device, the device will automatically connect to that network.

Connecting to Bluetooth Devices

To connect to a Bluetooth-enabled device, perform the following:

1. On the **Home** screen, touch  > **Settings**.
2. In **WIRELESS & NETWORK**, touch **Bluetooth** and set it to **ON** to enable the Bluetooth function.
3. Touch **SEARCH FOR DEVICES** for device to search for compatible Bluetooth devices in range.
4. To connect to a device, touch the device name.
5. Enter the passkey to connect. The passkey must be the same passkey on the other device.

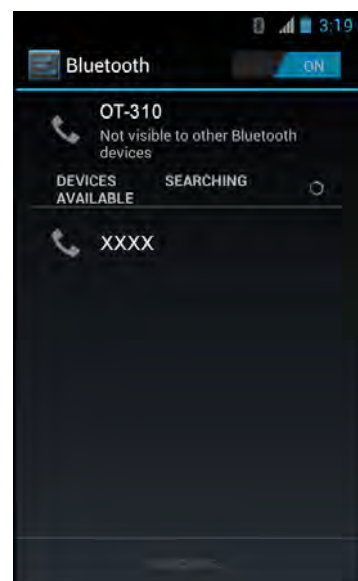



NOTE: Touch “**OT-310**” to make the device visible to other devices.

Configuring Language and Keyboard Settings

Changing the System Language



To change the system language, perform the following:

1. On the **Home** screen, touch  > **Settings**.
2. In PERSONAL, touch **Language & input**.
3. Touch **Language**.
4. Touch the desired language.
5. Touch  to return to the **Home** screen.



Changing the Input Settings

By default, the device uses the Android keyboard. To manage the keyboard settings, perform the following:

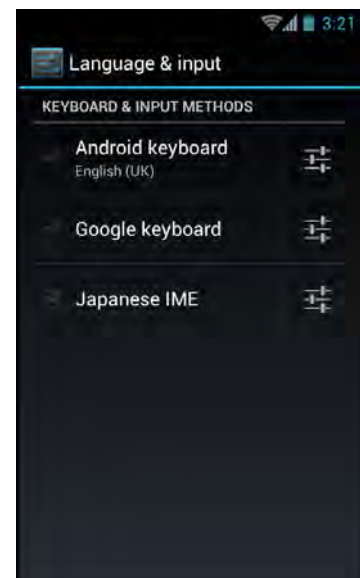

1. On the **Home** screen, touch  > **Settings** > **Language & input**.
2. In KEYBOARD & INPUT METHODS, touch **Default** > **Configure input methods**.
3. To configure the input method, touch  on the desired keyboard option and change the necessary settings.
4. Touch  to return to the **Home** screen.



Using the User Dictionary



The device has a built-in user dictionary, allowing users to add words to it.

To add words to the dictionary, perform the following:

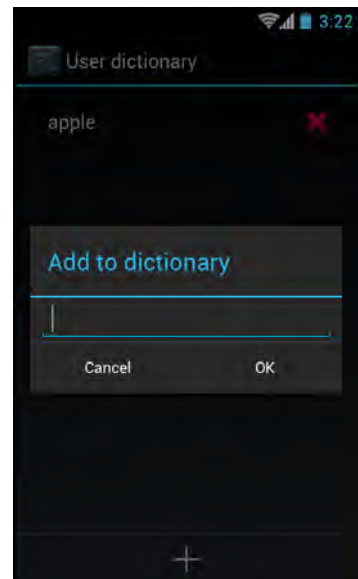

1. On the **Home** screen, touch  > **Settings** > **Language & input**.
2. Touch **Personal dictionary**.
3. To add words to the dictionary, touch .
4. Type the word to add to the dictionary.
5. Touch **OK**.
6. Repeat steps 3 to 5 to add more words.
7. Touch  to return to the **Home** screen.



To modify a word in the dictionary, perform the following:

1. On the **Home** screen, touch  > **Settings** > **Language & input**.
2. Touch **Personal dictionary**.
3. Touch the word to edit.
4. Modify the word, then touch **OK**.
5. Repeat steps 3 to 4 to modify more words.
6. Touch  to return to the **Home** screen.

To delete a word from the dictionary, perform the following:

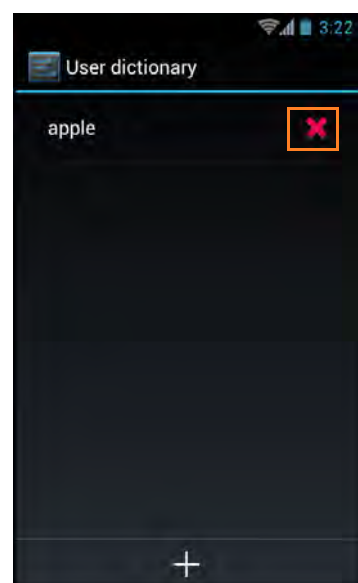

1. On the **Home** screen, touch  > **Settings** > **Language & input**.
2. Touch **Personal dictionary**.
3. Touch  next to the word to delete.
The word is removed from the dictionary.
4. Repeat steps 3 to delete more words.
5. Touch  to return to the **Home** screen.



Advanced Settings

Configuring Location Services

Based on the location, the Location Services settings menu allows interactive options with Google.

1. On the **Home** screen, touch  > **Settings** > **Location access**.
2. Touch one of the following options:
 - **Google's location service:** Check the box to allow application to use data from sources such as Wi-Fi and mobile network to determine the approximate location.
 - **GPS satellites:** Check the box to enable GPS satellites to pinpoint the location.
 - **Location & Google search:** Check the box to let Google use the location to improve search results and other services.
3. Touch  to return to the **Home** screen.

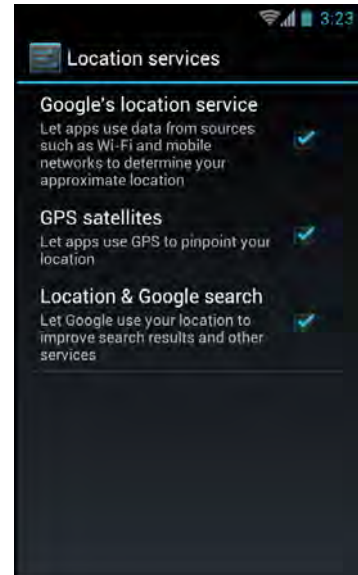

Configuring Security Settings

Use the Security settings menu to configure the device security options.

1. On the **Home** screen, touch  > **Settings** > **Security**.
2. Touch one of the following options:
 - **Screen lock:** Use slide or set up a pattern, PIN, or password to lock or unlock the screen.
 - **Encrypt phone:** Set a PIN or password to decrypt each time the device turns on.
 - **Set up SIM card lock:** Set up SIM card to lock or change the SIM pin codes.
 - **Make password visible:** Check the box to show the password when the data is entered.
 - **Device administrators:** View or deactivate device administrators.

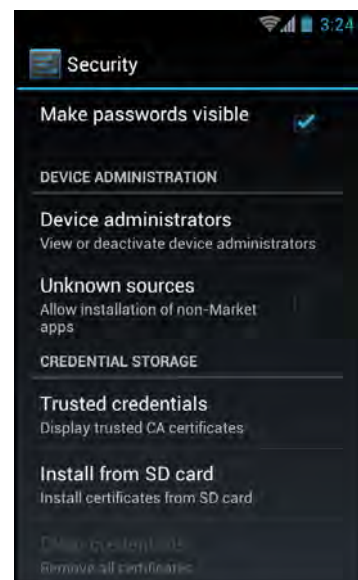

- **Unknown sources:** Check the box to allow installation of applications from unknown sources.
- **Trusted credentials:** Allow applications to display trusted CA certificates.
- **Install from storage:** Install encrypted certificates from memory card.
- **Clear credentials:** Clear credential storage of all contents and reset its password.

3. Touch  to return to the **Home** screen.

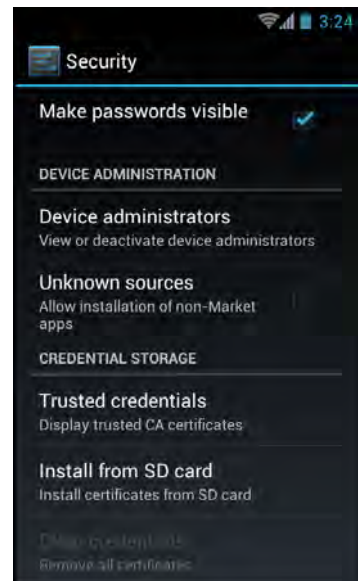

Managing Accounts

Synchronize the data, email, calendar and other information of an account with the device.

To add an Exchange account, perform the following:

1. On the **Home** screen, touch  > **Settings** > **Accounts & sync**.
2. Touch **ADD ACCOUNT**.

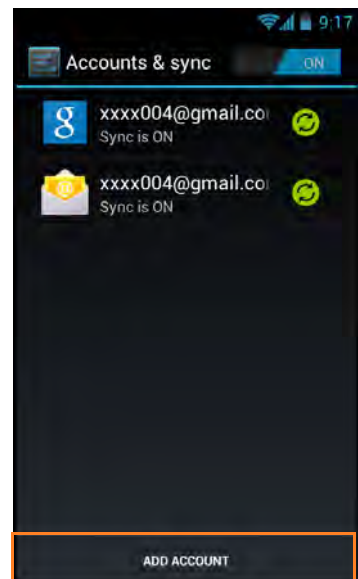



3. Touch **Corporate**.
4. Enter the **Email address** and **Password**.

NOTE: If there are more than one accounts, check the **Send email from this account by default** box to set the current account as the default account.
5. Touch **Next** to continue.
6. Enter the required information such as **Domain** or **Username**, **Password**, **Server** (for Exchange account), etc.

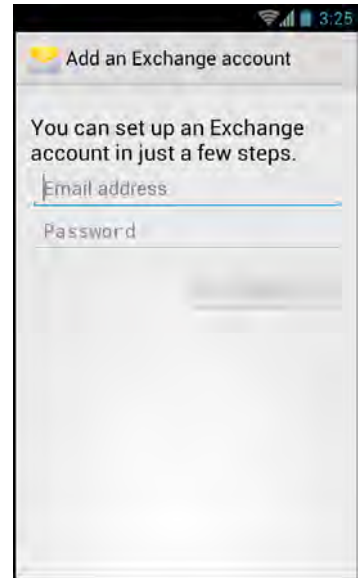
NOTE: Obtain these information from the network administrator or service provider.
7. Touch **Next** to continue and complete the wizard.
8. Touch  to return to the **Home** screen.



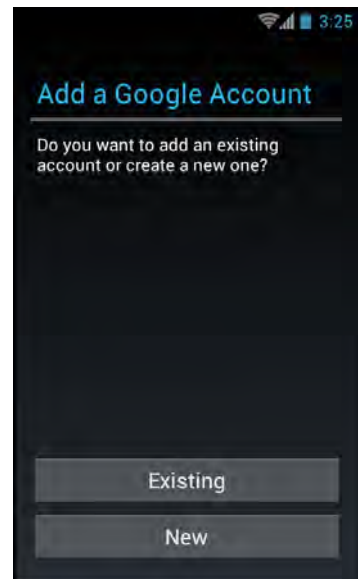

To add a Google account, perform the following:

1. On the **Home** screen, touch  > **Settings** > **Accounts & sync**.
2. Touch **ADD ACCOUNT**.
3. Touch **Google**.
4. Touch **Existing** to use the existing Google account or touch **New** to create new account.
5. Follow the on-screen instructions to complete setup.
6. Touch  to return to the **Home** screen.



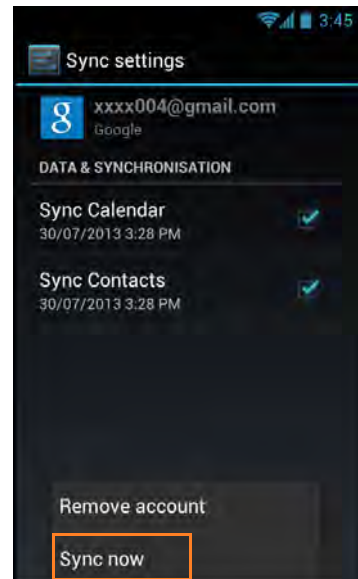

To synchronize other accounts, perform the following:

1. On the **Home** screen, touch  > **Settings** > **Accounts & sync**.
2. Touch the desired account to sync.
3. Check the boxes of the desired data to sync, such as **Contacts, Calendar**.
4. Touch  > **Sync now**.
5. Touch  to return to the **Home** screen.



To remove an account, perform the following:

1. On the **Home** screen, touch  > **Settings** > **Accounts & sync**.
2. Touch the desired account to remove.
3. Touch  > **Remove account**.
4. A confirmation message appears. Touch **Remove account** to confirm.
5. Touch  to return to the **Home** screen.



Managing Storage Space

Use the Storage settings menu to view the total and available space on the device. The device has two storage sources:

- **USB STORAGE:** The internal storage
- **SD CARD:** The micro SD card

To view the total and available storage space, touch  from the **Home** screen, then touch **Settings** > **Storage**.

To unmount the memory card for safe removal, perform the following:

1. On the **Home** screen, touch  > **Settings** > **Storage**.
2. Touch **Unmount SD card**.
3. A confirmation message appears on the status bar. Touch **OK** to confirm.
4. Touch  to return to the **Home** screen.
5. Turn off the device and remove the memory card.

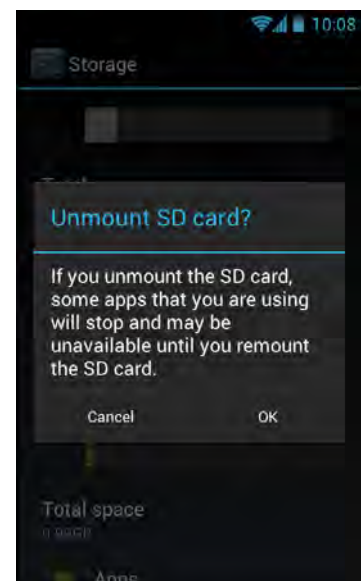

Application and Operation

This chapter covers information on how to use pre-installed applications and customize related settings.

Browser

Use **Browser** to view web pages.

Launching a Web Page

1. On the **Home** screen, touch  > **Browser**.
2. Touch the address bar.
3. Enter the URL on the address bar
4. Touch **Go** on the on-screen keyboard.

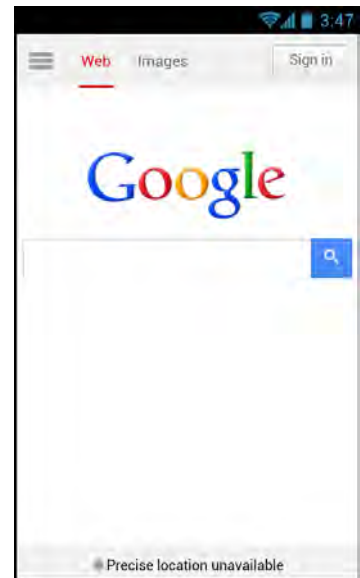

NOTE: Be sure that the device is properly connected to Internet either via Wi-Fi connection or mobile data network.

Viewing the Current Web Page

To zoom in on the current page, move the two fingers apart from each other at the location of the screen to zoom in.

In **zoom** mode, swipe the finger up/down and left/right to scroll on the page.

To zoom out on the current page, move the two fingers closer together at the location of the screen to zoom out.

Managing Web Pages

Touch  to change the view current setting or configure other functions.

- **Refresh:** Select to reload current web page.
- **Forward:** Select to go to the next page.
- **Bookmarks:** Select to view bookmarks, history, or saved pages.
- **Save to bookmarks:** Select to save favorite web pages as bookmarks.
- **Share page:** Select to share the current page via Bluetooth, Email, or Messaging.
- **Find on page:** Select to find texts on the current web page.
- **Request desktop site:** Select to open the current web page in desktop display mode.
- **Save for offline reading:** Select to save the current web page to be available even when the internet service is not available.
- **Settings:** Select to configure other advanced settings.

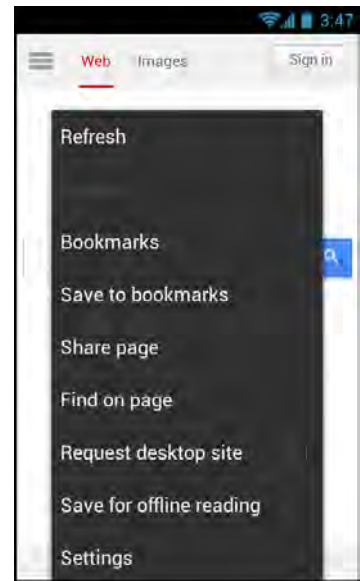

NOTE: The availability of options varies depending on the current web page.

Camera

Use **Camera** to capture photos and panorama shots and record videos.

Capturing Photos

1. On the **Home** screen, touch  > **Camera**.

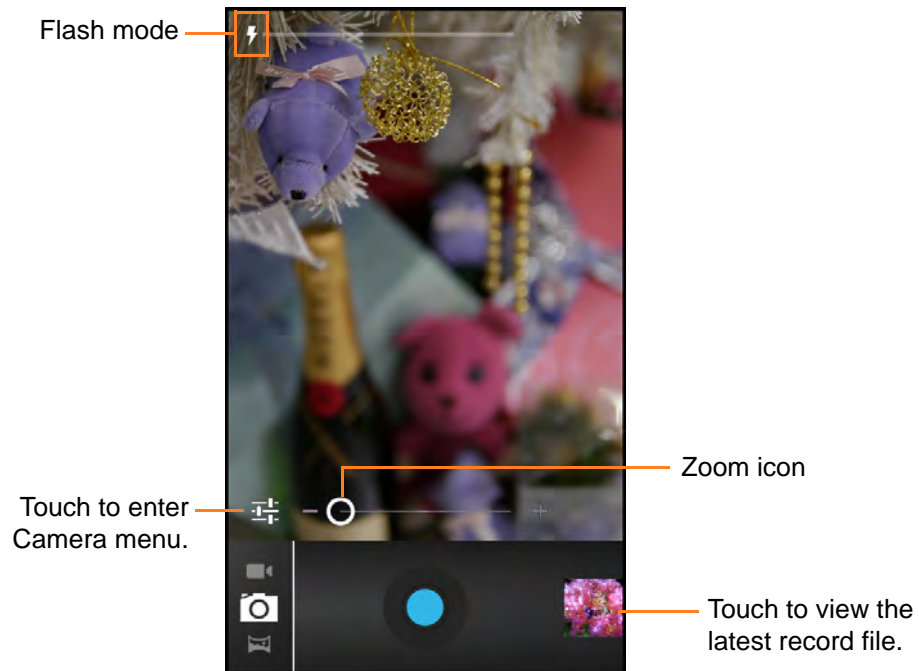

2. Aim the device at the subject.

NOTE: Drag the  icon to zoom in/out on the subject.

3. Touch  to capture the shot.

Reviewing Photos

Touch the thumbnail frame to preview the latest captured photo.



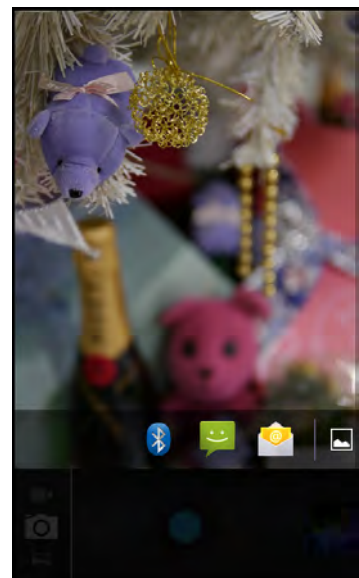



- Touch  to view other recorded photos or videos in Gallery.
- Touch a sharing application (i.e. Bluetooth, Messaging, Email) to share the current photo.



Configuring Camera Settings



Touch  to enter the camera menu.

Perform the following:

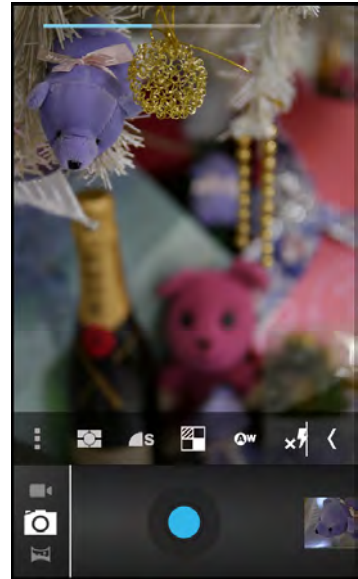

- Touch  to configure the basic camera settings.
Available options: Store location (OFF/ON), Picture size (5M Pixels/3M Pixels/2M Pixels/WXGA/HD720/1M Pixel/SVGA/WVGA/VGA/CIF/QVGA/QCIF), Focus mode (Normal/Macro), Anti Banding (Auto/60 Hz/50 Hz/Off), Restore defaults (Cancel/OK).
- Touch  to change the auto exposure settings.
Available options: Frame Average, Center Weighted, Sport Metering.
- Touch  to specify the image quality settings.
Available options: Super fine, Fine, Normal.
- Touch  to change the color effect settings.
Available options: None, Mono, Sepia, Negative, Solarize.
- Touch  to change the white balance settings.
Available options: Auto, Incandescent, Daylight, Fluorescent, Cloudy.
- Touch  to change the flash mode settings.
Available options: On, Off.
- Touch  to close the menu screen.



Recording Videos

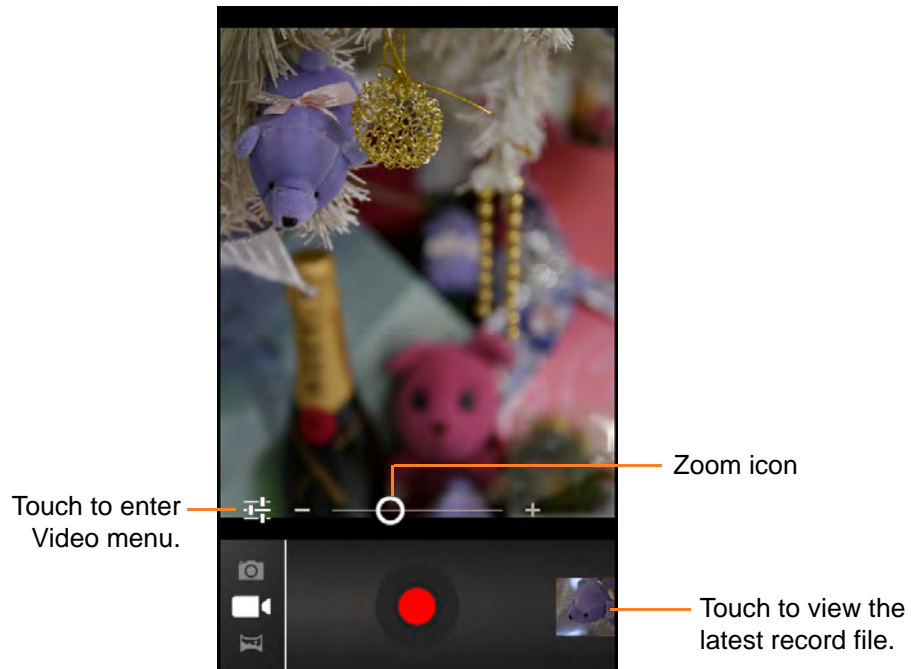

1. On the **Home** screen, touch  > **Camera**.
2. Touch  and select  to switch to **Video** mode.



3. Aim the device at the subject.
 4. Touch  to start recording the video.
- NOTE:** Drag the  icon to zoom in/out on the subject.
5. Touch  to stop recording.

Reviewing Videos

Touch the thumbnail frame to preview the latest recorded video.



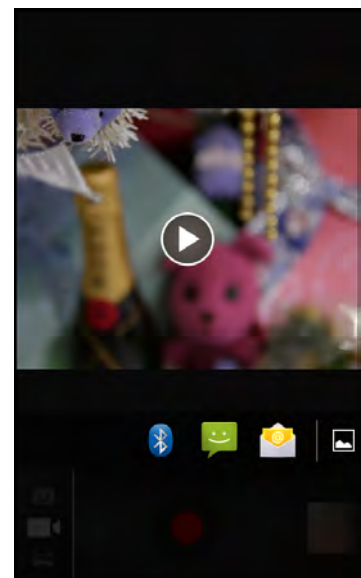



- Touch  to play the video.
- Touch  to view other recorded photos or videos in Gallery.
- Touch a sharing application (i.e. Bluetooth, Messaging, Email) to share the current video.



Configuring Video Settings



Touch  to enter the video menu.

Perform the following:

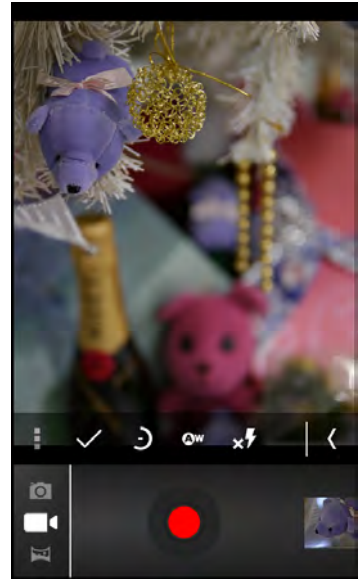
- Touch  to configure the basic video settings.
Available options: Store location (OFF/ON), Video Encoder (H264/H263/MPEG4), Audio Encoder (AAC/AMRNB), Video duration (30 minutes/15 minutes/10 minutes/30 seconds), Color effect (None/Mono/Sepia/Negative/Solarize), Power Mode (Normal_Power/Low_Power), Restore defaults (Cancel/OK).
- Touch  to specify the video quality settings.
Available options: CIF, QCIF.
- Touch  to select the time lapse interval.
Available options: Off, 1s, 1.5s, 2s, 2.5s, 3s, 5s, 10s.
- Touch  to change the white balance settings.
Available options: Auto, Incandescent, Daylight, Fluorescent, Cloudy.
- Touch  to change the **flash** mode settings.
Available options: On, Off.
- Touch  to close the menu screen.



Capturing Panorama Shots

1. On the **Home** screen, touch  > **Camera**.
2. Touch  and select  to switch to **Panorama** mode.



Touch to view the latest record file.

3. Aim the device at the subject.
4. Touch  to start capturing the shot.
5. Pan the device horizontally and follow the shooting guideline as shown on the screen.

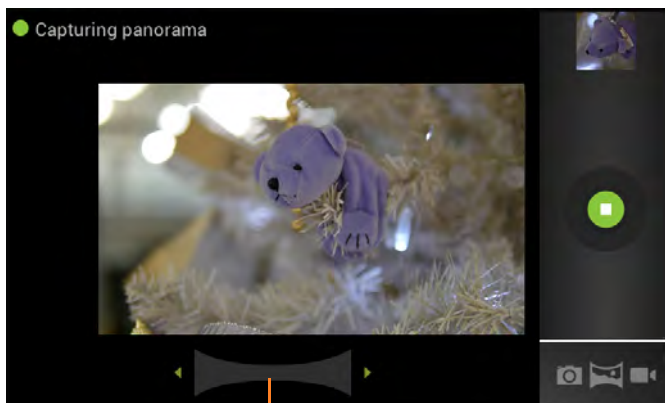

Shooting guideline

6. Touch  to stop shooting.

Email

Use the device to send and receive emails using Internet email accounts.

Setting up an Email Account

1. On the **Home** screen, touch  > **Email**.
2. Enter the email address and password.
3. Touch **Next**.

NOTE: Touch **Manual setup** to manually configure the email.

NOTE: To setup an Exchange email account, refer to “Managing Accounts” on page 22.

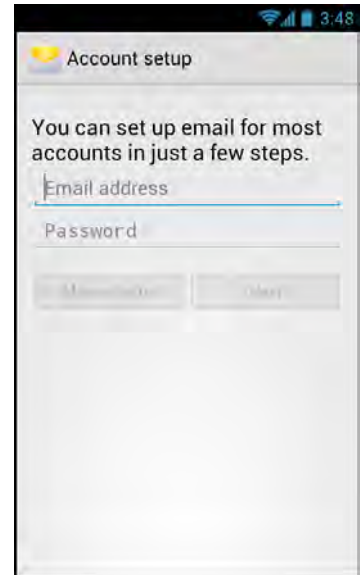

4. Set the *Inbox checking frequency* setting and touch other options box to enable the necessary settings.
5. Touch **Next** to continue.

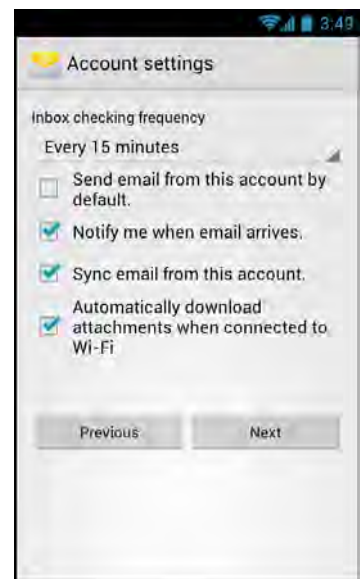

6. Enter the account and display names and touch **Next**.



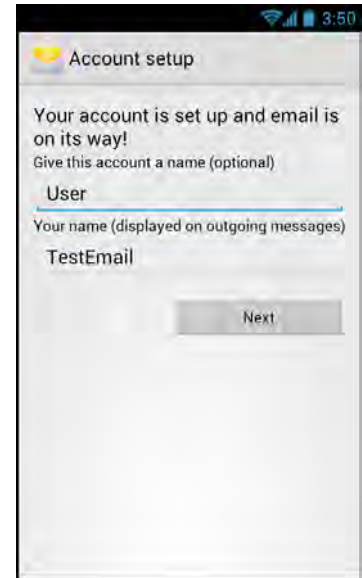

Once the account setup is complete, the device will automatically retrieve the emails.



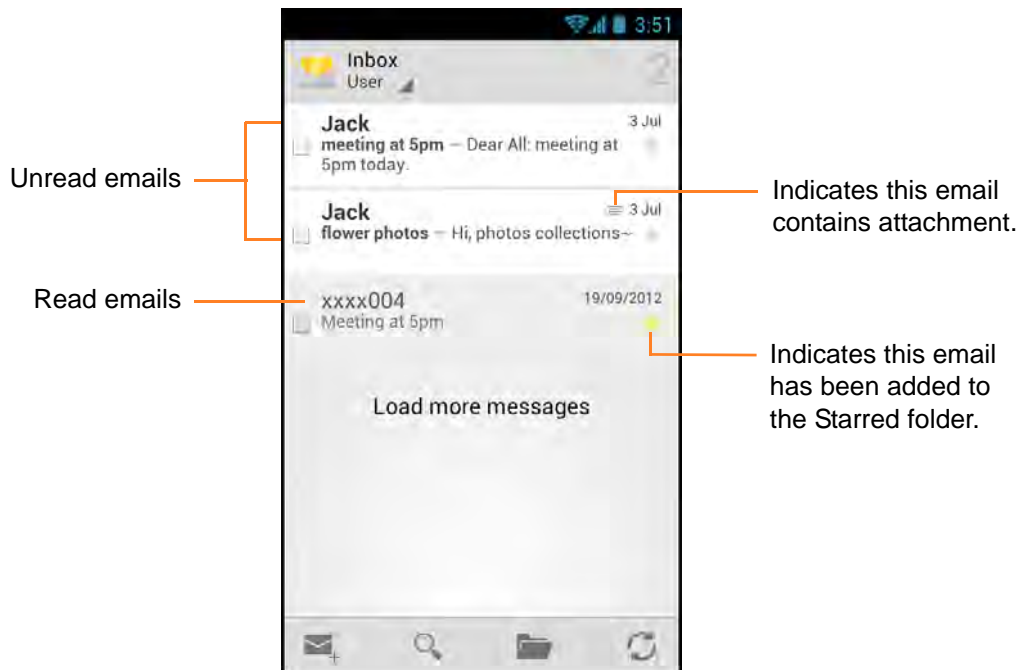

Viewing Emails



By default, emails are automatically saved in the *Inbox* folder.



- Touch  to manually receive emails.
- Touch  to view other folders.
- Touch  to search email that contains specific text in the current folder.
- Touch  to compose a new email.



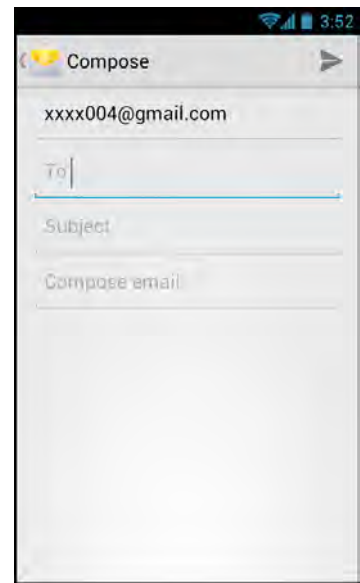

Composing and Sending an Email

1. On the **Home** screen, touch  > **Email**.
2. Touch .
3. Enter the recipient's email address in the *To* field.
4. Enter a subject in the *Subject* field (if necessary).
5. Compose the email.

NOTE: To add attachments to emails, touch  > **Attach file**. Then select the file to attach.
6. Touch  to send the email.



Reading and Replying an Email

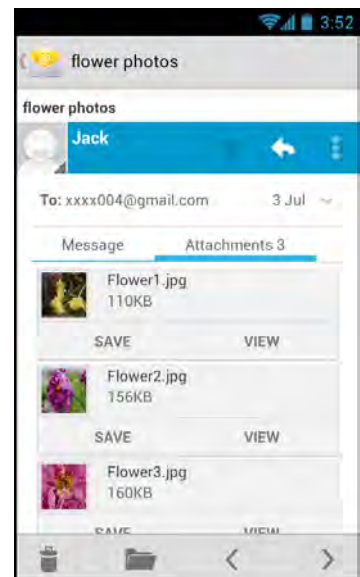

1. On the **Home** screen, touch  > **Email**.
2. Touch an email to open it.
3. Perform any of the following:
 - To reply the email, touch  or touch  > **Reply all**.
 - To forward the email, touch  > **Forward**. Then enter the recipient email in the *To* field.
 - To view the attachment, touch the **Attachments** tab. To save the file into the device, touch **SAVE**.

NOTE: To view the attached photo in full screen, touch **VIEW**.
4. Compose the email.
5. Touch  to send the email.





Deleting Emails

To delete an email at a time, perform the following:

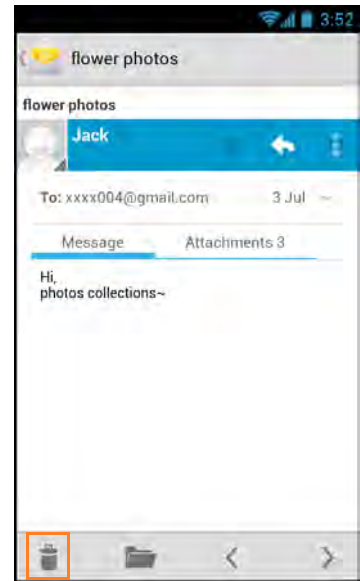
1. On the **Home** screen, touch  > **Email**.
2. Touch an email to open it.
3. Touch  to delete the current email.



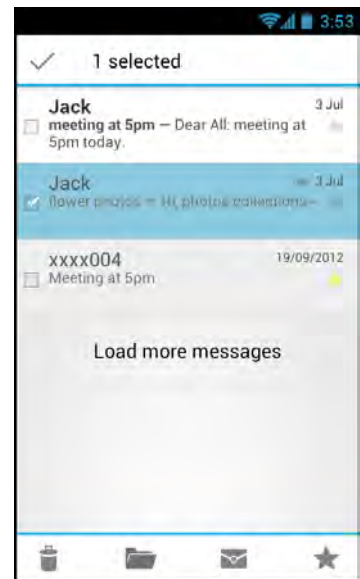

To delete selected emails in the same folder, perform the following:

1. On the **Home** screen, touch  > **Email**.
2. Touch and hold the desired email to delete. Select other email(s) if necessary.
3. Touch  to delete the selected email(s).





Adding Other Email Accounts

1. On the **Home** screen, touch  > **Email**.
2. Touch  > **Settings**.
3. Touch **ADD ACCOUNT**.
4. Repeat Steps 2~6 in “Setting up an Email Account” on page 33.

NOTE: Check the **Send email from this account by default** box to set this new account as the default email account.



Customizing Email Settings

1. On the **Home** screen, touch  > **Email**.
2. Touch  > **Settings**.
3. Touch **General** or an **email account**.
4. Touch an option and change the necessary settings.

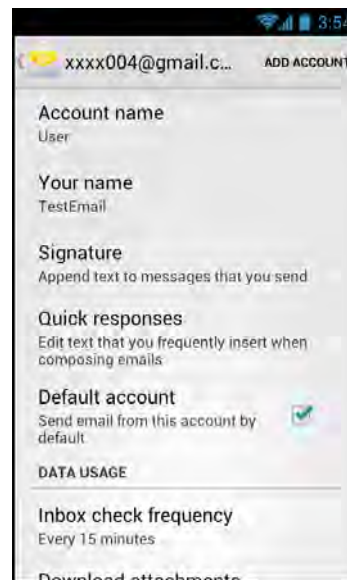
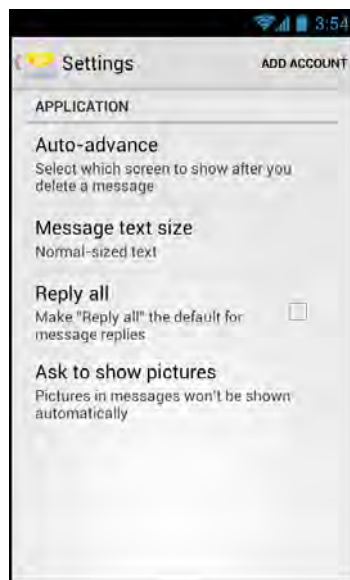

File Manager

Use **File Manager** to browse and manage files/folders stored in the internal memory (the device) or the memory card installed in the device.



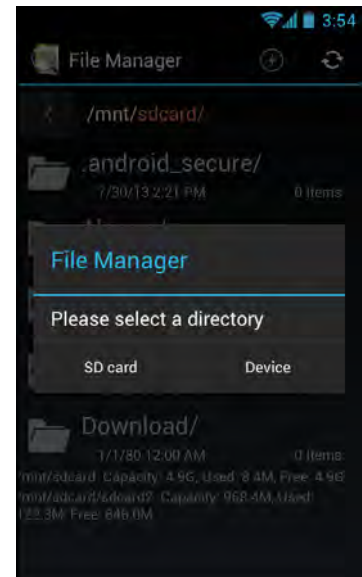

Browsing Files

1. On the **Home** screen, touch  > **File Manager**.
2. Select the directory by touching **SD card** or **Device**.
3. Browse the folder list and touch the folder to explore.



Managing Files and Folders

Perform one of the following:

- To create a new folder, touch . Enter the folder name and touch **OK**.
- To rename the folder or file, touch and hold the item and touch **Rename**. Enter the new name and touch **OK**.
- To sort item by size, touch  > **Sorting by Size**.
- To switch to memory card while browsing the content of the memory device, touch  > **SD card**.
- To copy file or folder, touch and hold the item to copy and touch **Copy**. To paste the file or folder, select the destination path and touch  > **Paste**.
- To delete a file or folder, touch and hold the item to delete and touch **Delete**. Touch **OK** to confirm the deletion.
- To move a file or folder, touch and hold the item to move and touch **Cut**. To paste the file or folder, select the destination path and touch  > **Paste**.

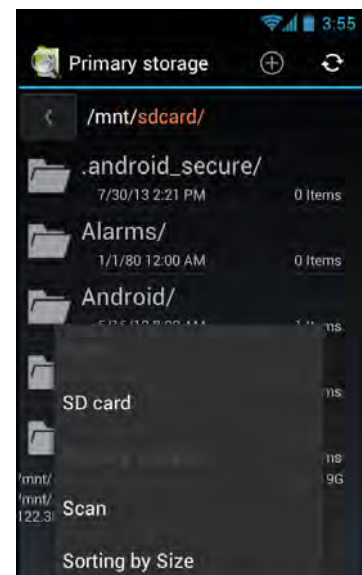



Gallery

Use **Gallery** to view captured photos, recorded videos, or downloaded photos stored in the internal memory (the device) or the memory card installed in the device.

Viewing Photos

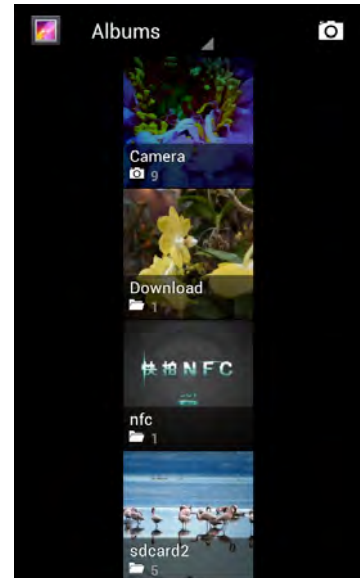



1. On the **Home** screen, touch  > **Gallery**.
2. Touch the desired album/folder.
The recorded files are displayed in thumbnails.

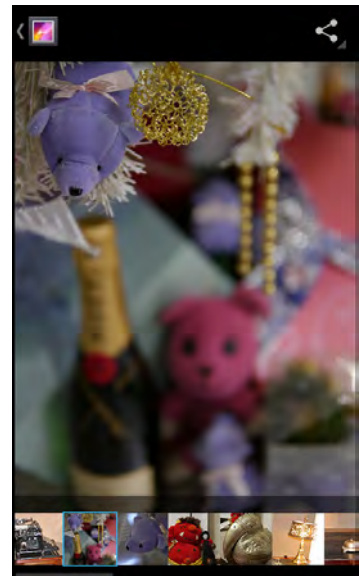

3. Touch the desired image to view it in full screen.
4. Perform the following:
 - To view other files, swipe the finger to the left or right.
 - To share this photo, touch  and select the desired sharing application.
 - To delete or edit this photo, play the slideshow, or show more options, touch .



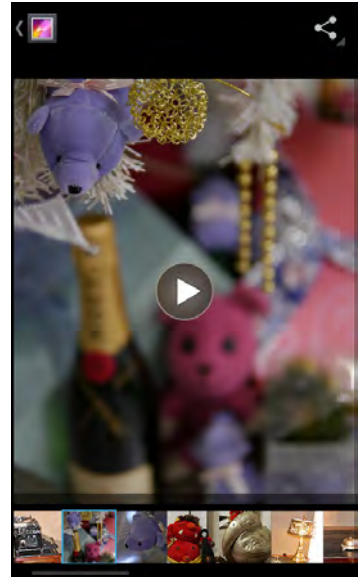

Playing Videos

1. On the **Home** screen, touch  > **Gallery**.
2. Touch the desired album/folder.
The recorded files are displayed in thumbnails.
3. Touch the desired video to playback.
4. Perform one of the following:
 - To play the video, touch .
 - To view other files, swipe the finger to the left or right.
 - To share this video, touch  and select the desired sharing application.
 - To delete this video or show more options, touch .



Playing Slideshow

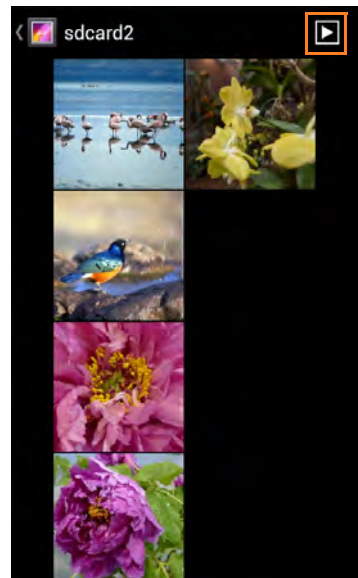

1. On the **Home** screen, touch  > **Gallery**.
2. Touch the desired album/folder.
The recorded files are displayed in thumbnails.
3. Touch  to start the slideshow.
4. To stop the slideshow at anytime, touch the screen.



Messaging

Use **Messaging** to send and receive text and MMS messages.



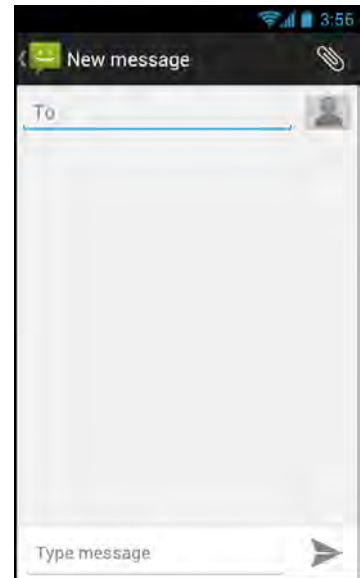

Creating and Sending a Text Message

1. On the **Home** screen, touch  > **Messaging**.
2. Touch .
3. Enter the recipient's phone number in the *To* field.
4. Compose the message.
5. Touch  to send the message.

NOTE: By exiting *Messaging* before sending the message, the unsent message will be automatically saved as a draft.



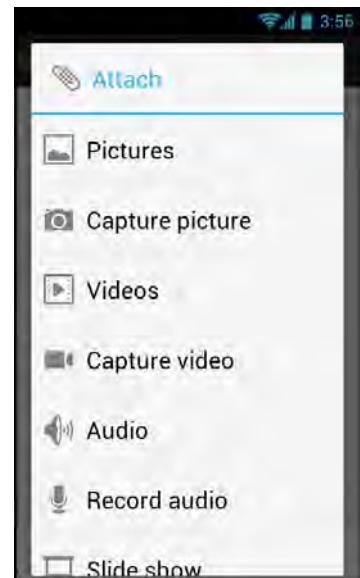

Adding an Attachment to a Message

1. On the **Home** screen, touch  > **Messaging**.
2. Touch .
3. Enter the recipient's phone number in the *To* field.
4. Compose the message.
5. Touch  to add an attachment and select one of the following options:
 - **Pictures:** Select to attach a photo from Gallery.
 - **Capture picture:** Select to take a picture to attach.
 - **Videos:** Select to attach a video clip.
 - **Capture video:** Select to record a video to attach.
 - **Audio:** Select to attach an audio file.
 - **Record audio:** Select to record the voice to attach.
 - **Slide show:** Select to attach a slideshow.
6. Touch  to send the message.



Configuring Messaging Settings

1. On the **Home** screen, touch  > **Messaging**.
2. Touch  > **Settings**.
3. Touch an option and change the necessary settings:
 - **Delete old messages:** Select this option to delete old messages as limits are reached.
 - **Text message limit:** Select to specify the maximum limit of text message per conversation.
 - **Multimedia message limit:** Select to specify the maximum limit of multimedia message per conversation.
 - **Delivery reports:** Select to request a delivery report for each sent text message.
 - **Manage RUIIM card messages:** Select to manage messages stored on the SIM card.
 - **Delivery reports (MMS):** Select to request a delivery report for each sent multimedia message.
 - **Read reports:** Select to request a read report for each sent multimedia message.
 - **Auto-retrieve:** Select to automatically retrieve new messages.
 - **Roaming auto-retrieve:** Select to automatically retrieve new messages while roaming.
 - **Notifications:** Select to display message notifications in status bar.
 - **Choose ringtone:** Select to choose a ringtone of new messages.
 - **Vibrate:** Select to disable/enable vibration when new message is received.

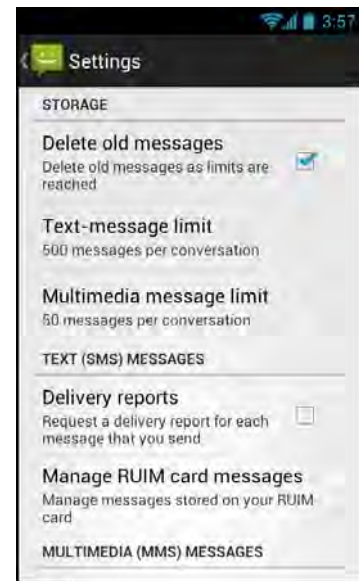

Music

Use **Music** to listen to the favorite songs using the device.

Playing a Song

1. On the **Home** screen, touch  > **Music**.
2. Touch the **Song** tab.
All songs are displayed on the screen.

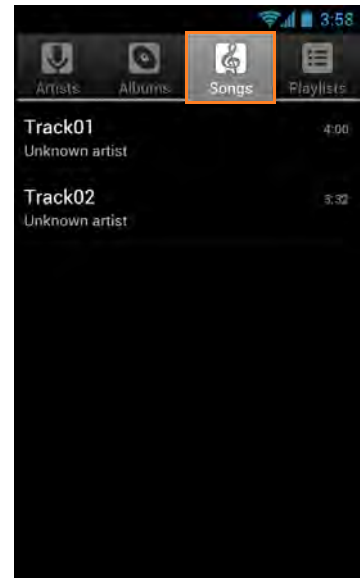

3. Touch a song to play.

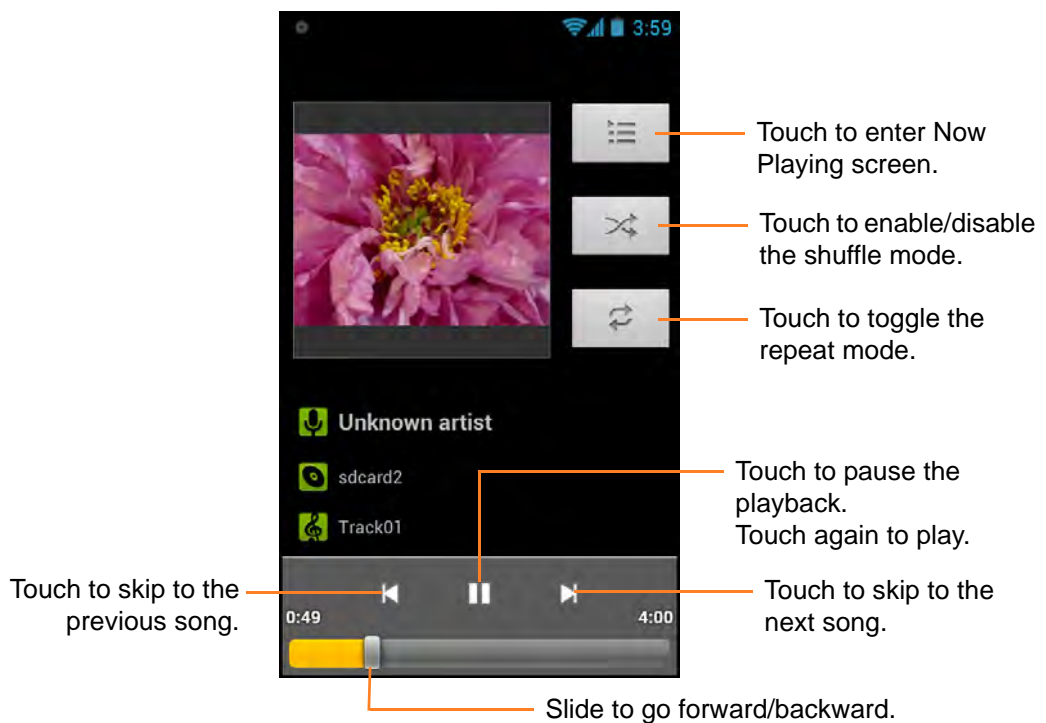

NOTE: Touch  to view more options.

Creating a Playlist

1. On the **Home** screen, touch  > **Music**.
2. Touch and hold the desired song to add.
3. Touch **Add to playlist**.
4. Select a playlist.
To create a new playlist, touch **New**. Enter the new playlist name and touch **Save**.

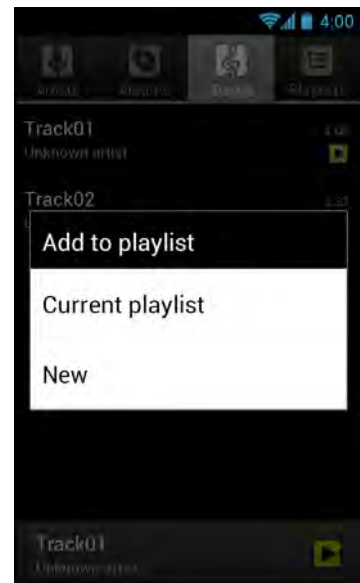

Assigning a Song as Ringtone

1. On the **Home** screen, touch  > **Music**.
2. Touch and hold the desired song to be the device ringtone.
3. Touch **Use as phone ringtone**.

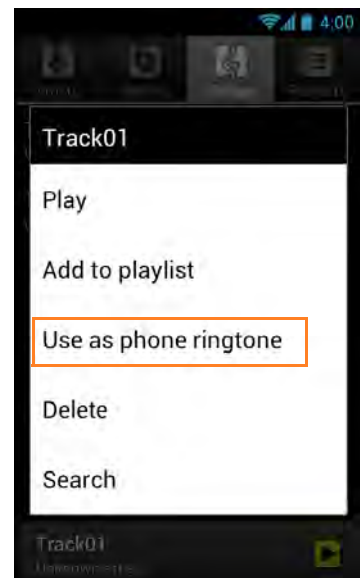

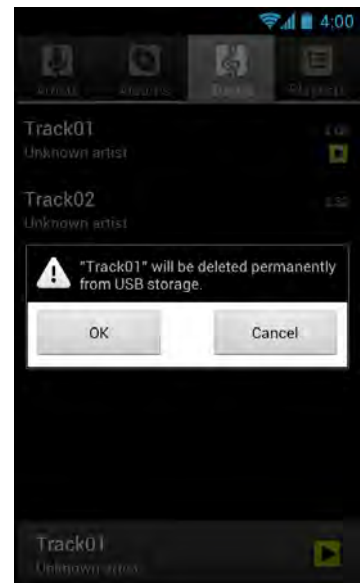

Deleting a Song

1. On the **Home** screen, touch  > **Music**.
2. Touch and hold the desired song to delete.
3. Touch **Delete**.
4. Touch **OK** to delete the selected song.



Configuring the Sound Effect

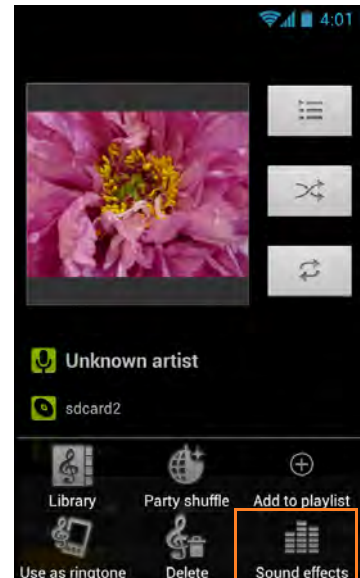

1. On the **Home** screen, touch  > **Music**.
2. Touch a song to play.
3. Touch  > **Sound effects**.
4. Touch **Equaliser** and set it to **ON**.
5. Touch an option and change the necessary settings.



People

Use **People** to view and manage the contact list.

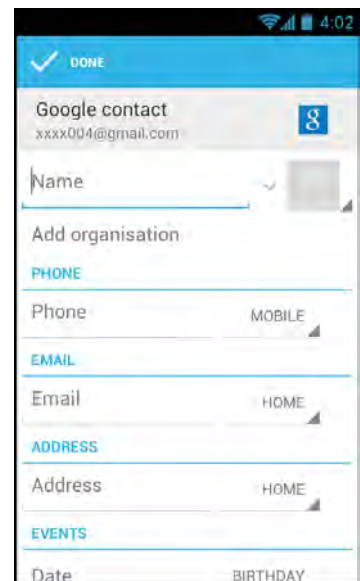
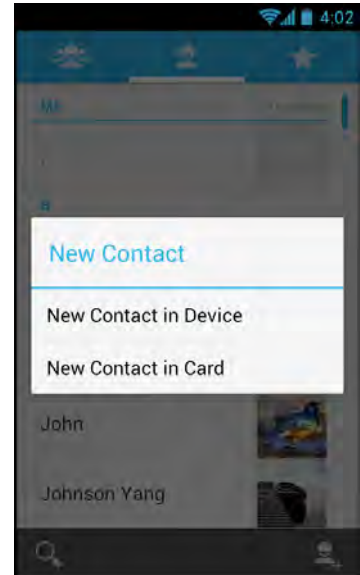

Adding a New Contact

1. On the **Home** screen, touch  > **People**.
2. Touch .
3. Touch one of the following:
 - **New Contact in Device:** To save the new contact to the phone memory.
 - **New Contact in Card:** To save the new contact to the memory card.
4. Enter the contact information such as name, phone number, email address, home address, and other related data.
5. Touch **DONE** to save the contact.





Importing Contacts

To import contacts from the SIM card, perform the following:

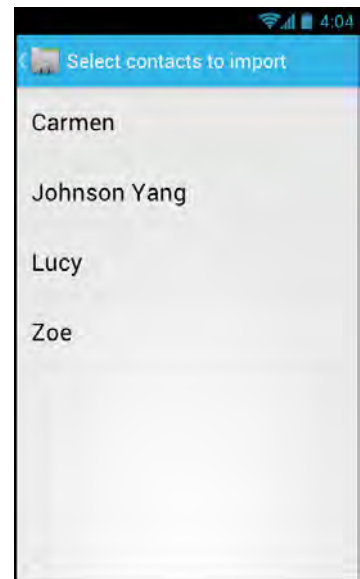
1. On the **Home** screen, touch  > **People**.
2. Touch  > **Import/export** > **Import from SIM card**.
3. Touch the desired contact to import.



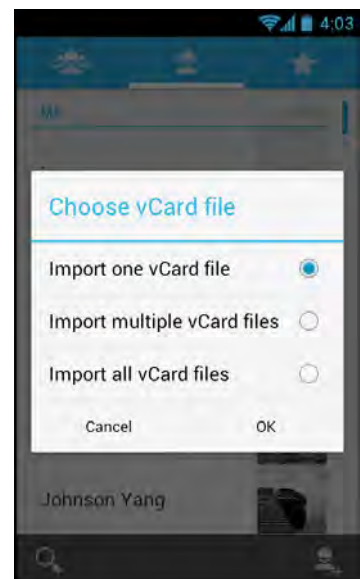

To import contacts from the memory card, perform the following:

1. On the **Home** screen, touch  > **People**.
2. Touch  > **Import/export** > **Import from storage**.
3. Select the vCard file(s) to import.
4. Touch **OK** to import contacts.





Backing Up Contacts

To copy contacts to the SIM card, perform the following:

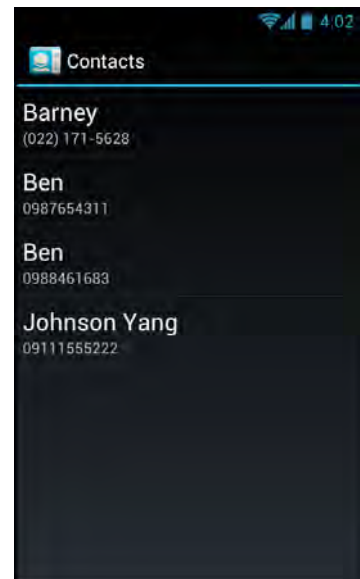
1. On the **Home** screen, touch  > **People**.
2. Touch  > **Import/export** > **Export to SIM/RUIM card**.
3. Touch the desired contact to export.



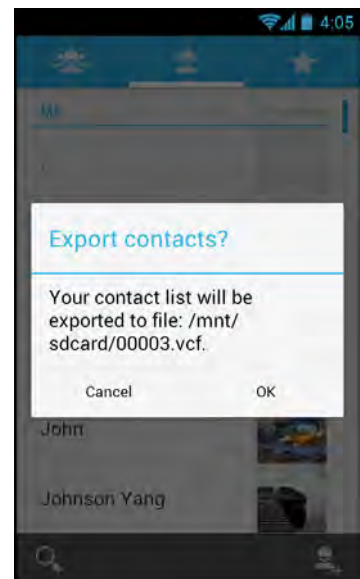

To copy contacts to the memory card, perform the following:

1. On the **Home** screen, touch  > **People**.
2. Touch  > **Import/export** > **Export to storage**.
3. Touch **OK** to copy contacts to the memory card.





Managing Contacts

To edit a contact information, perform the following:

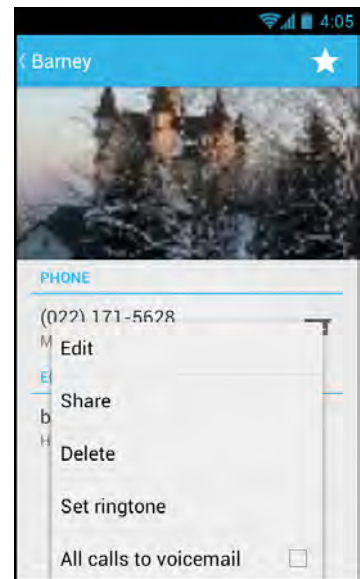

1. On the **Home** screen, touch  > **People**.
2. Touch the desired contact to modify.
3. Touch  > **Edit**.
4. Modify the necessary information.
5. Touch **DONE** to save the changes.





To share a contact information, perform the following:

1. On the **Home** screen, touch  > **People**.
2. Touch the desired contact to share.
3. Touch  > **Share**.
4. Select the desired sharing application to send the contact information.



To assign a contact ringtone, perform the following:

1. On the **Home** screen, touch  > **People**.
2. Touch the desired contact to assign a ringtone to.
3. Touch  > **Set ringtone**.
4. Select the desired ringtone and touch **OK** to confirm.





To delete a contact, perform the following:

1. On the **Home** screen, touch  > **People**.
2. Touch the desired contact to delete.
3. Touch  > **Delete**.
4. Touch **OK** to confirm the deletion.

To send all calls from specific contact to voicemail, perform the following:



1. On the **Home** screen, touch  > **People**.
2. Touch the desired contact to revert all calls directly to voicemail.
3. Touch  > **All calls to voicemail**.

To add a contact to Favorite list, perform the following:

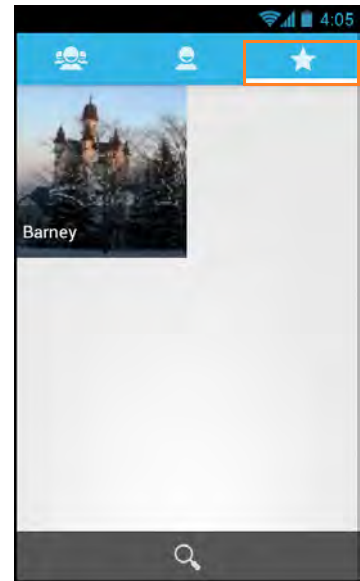
1. On the **Home** screen, touch  > **People**.
2. Touch the desired contact to add to the Favorite list.
3. Touch  and it turns , indicating the current contact has been added to the Favorite list.
4. Touch Favorite tab () to view the favorite contact(s).



To remove a specific contact from Favorite list, perform the following:



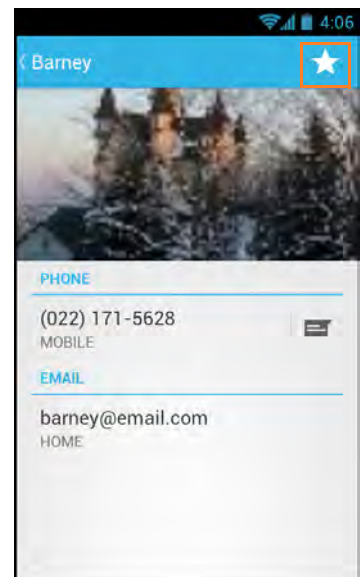

1. On the **Home** screen, touch  > **People**.
2. Touch the desired contact to remove from the Favorite list.
3. Touch  and it turns , indicating the current contact has been removed from the Favorite list.





Phone

Use **Phone** to make or receive a phone call using the device.

Making a Call

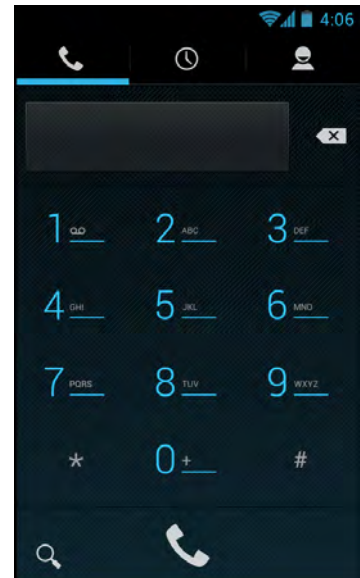



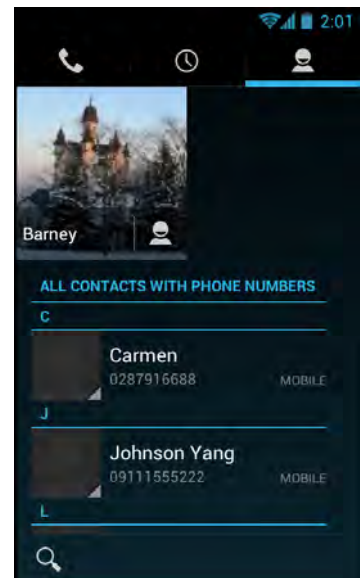

1. On the **Home** screen, touch  > **Phone**.
2. Enter the phone number using the on-screen keypad.
 - To delete a wrong number, touch .
 - To delete the entire number, touch and hold .
3. Touch  to make a call after the user finishes entering the phone number.
4. To end the call after dialing, touch .





NOTE: As an alternative, calls can be made directly from the contact lists. Touch **People** () tab and touch the desired contact's phone number.



Answering a Call

- To answer a call, touch  and drag it to the  icon.
- To reject the call, touch  and drag it to the  icon.
- To reject and send a message directly to the caller, touch  and drag it to the  icon.

NOTE: When the  icon is touched, it automatically changes to .

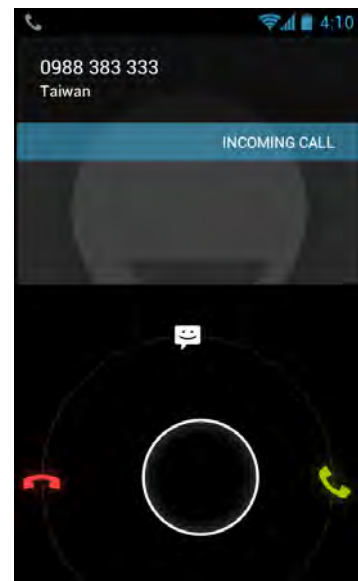



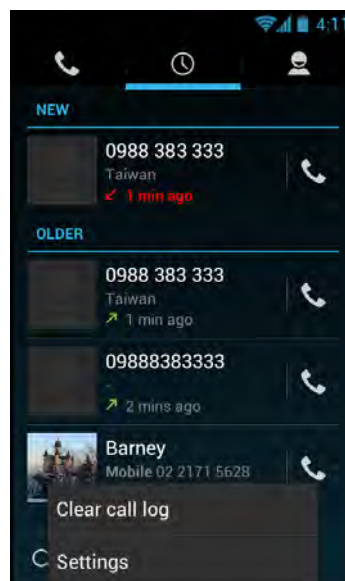

Viewing Call Log

The Call Log screen displays the recent outgoing, received, or missed calls.

To view the Call Log screen, touch the Call Log () tab.



- To remove an entry from the list, select the desired entry and touch  > **Remove from call log**.
- To edit the phone number before making a call, touch  > **Edit number before call**. Edit the phone number and touch  to make a call.
- To clear all call log, touch  > **Clear call log**. Touch **OK** to confirm.
- To configure the call settings, touch  > **Settings**. Tap the desired option and change the necessary settings.

Barcode Scanner Module

This device is equipped with a barcode scanner module which supports many of the popular barcode formats currently used worldwide.

NOTE: During the system initialization (after powering on the device for the first time or resetting the device to factory default), the scanner will take approximately 30 seconds to be activated. It is highly recommended not to press the barcode scan trigger key within 30 seconds.

Configuring Barcode Reader Settings

Use the Barcode Reader settings menu to configure the barcode reader related settings.

1. On the **Home** screen, touch  > **Settings** > **Barcode Reader**.
2. Touch one of the following options:
 - **Barcode reader:** Check the box to enable barcode module function.
 - **Good read notification:** Check the box to enable sound after scanning barcodes.
 - **Prefix Suffix settings:** Configure the prefix and suffix characters.
 - **Code readable settings:** Configure the code readable settings.
 - **Code options:** Configure the code options.
 - **Read options:** Configure the read options including read mode, read time, margin, redundancy, positive and negative, and scan angle settings.
 - **Output mode:** Select the output mode.
 - **Trigger Key:** Specify which button(s) to be used as trigger key(s).
 - **Restore factory default settings:** Return all barcode reader settings to the factory default settings.
 - **Backup current settings:** Back up the current barcode reader settings.
 - **Restore current settings:** Restore the current barcode reader settings.

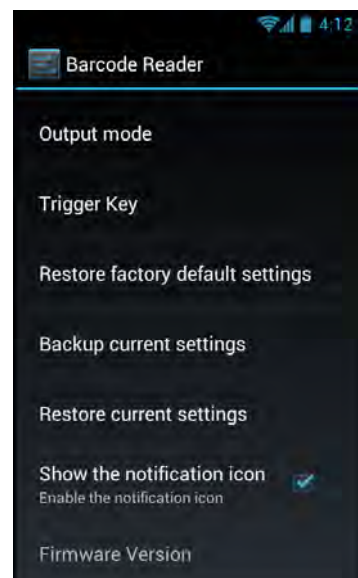
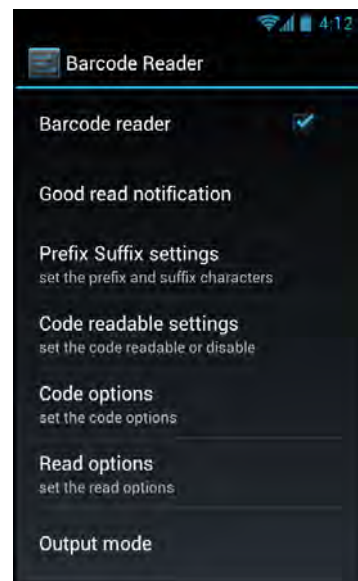

- **Show the notification icon:** Check the box to enable notification icon to be displayed on the status bar.
- **Firmware Version:** View the module firmware version.

3. Touch  to return to the **Home** screen.

Reading a Barcode

To read a 1D barcode, perform the following:

1. Press and release the barcode scan trigger key.
2. Aim the scanning beam at the barcode.
3. The scanned data appears on the screen.

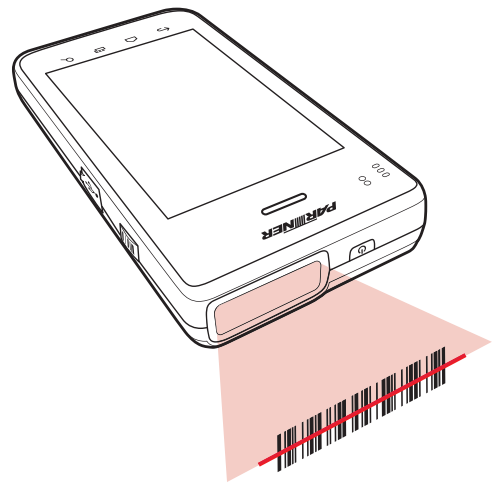

To read a 2D barcode, perform the following:

1. Press and hold the barcode scan trigger key.
2. Aim the scanning beam at the barcode.
3. The scanned data appears on the screen.
4. Release the trigger key.

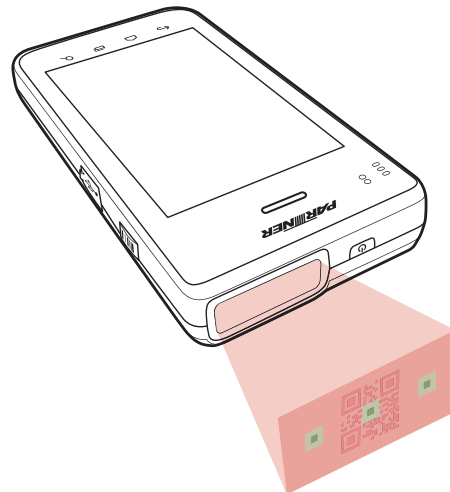



MSR Module

The Magnetic Stripe Reader module supports tracks 1, 2, and 3 covering possible reading methods currently in use.

Configuring MSR Settings

Use the MSR settings menu to configure the MSR module related settings.

1. On the **Home** screen, touch  > **Settings** > **MSR Settings**.
2. Touch one of the following options:
 - **Track setting:** Configure tracks order, start sentinels, and end sentinels settings.
By default, the start sentinel of a magnetic stripe card is already set based on the ISO standard:
 - Track 1: %
 - Track 2: ;
 - Track 3: +
 - **Prefix and suffix setting:** Configure the prefix and suffix characters for package/track settings.
 - **Output setting:** Configure the output mode, reader and buzzer settings.
 - **Restore factory default settings:** Return all MSR settings to the factory default settings.
 - **MSR Demo:** Select to test the MSR module.
 - **Firmware Version:** The module firmware version will display on screen within 10 seconds.
3. Touch  to return to the **Home** screen.

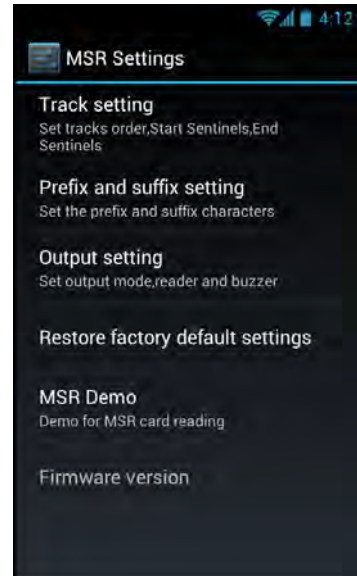

Testing the MSR Module

1. On the **Home** screen, touch  > **Settings** > **MSR Settings**.
2. Touch **MSR Demo** to open the swipe test screen.

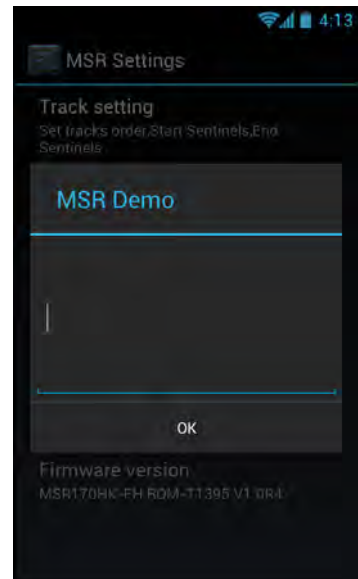

3. Swipe a magnetic stripe card through the MSR module. Make sure the magnetic stripe is facing upward.

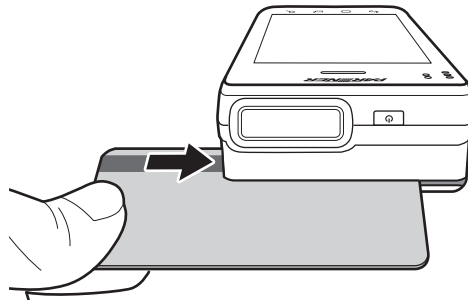

4. Data appears on the screen if the test is successful.

Appendix

Specifications

OT-310 Specifications	
Processor	Qualcomm MSM8960 Dual Core Krait- 1.5GHz
OS	Android 4.2
Memory	Standard: 1GB
Storage	Standard: 8GB
Display	<ul style="list-style-type: none"> • 4.3" TFT, 800*480 • Brightness 350nits
Capacitive Touch	<ul style="list-style-type: none"> • 2 finger touch • Gorilla glass+ AR solution
WWAN	<ol style="list-style-type: none"> 1. (RF WCDMA+GSM)GWTR-1605 support <ul style="list-style-type: none"> • GSM850/900/1800/1900 • EDGE850/900/1800/1900 • GPRS850/900/1800/1900 • WCDMA850/1700(AWS)/1900/2100 2. Voice 3. HSPA+ Modem
Bluetooth	V4.0 + LE
WiFi	802.11a/b/g/n ; 13 channels; need roaming function WCN3660
GPS	<ul style="list-style-type: none"> • Gen 8 GPSONe with GPS and GLONASS. • Strong Signal/Open Sky (-130 dBm) Cold start 32s • Weak signal/Mild indoor (-161 dBm) 60s
NFC (Optional)	NFC standards according to Android 4.2 CDD + ISO15693 and MIFARE
Back Camera (Internal)	CMOS, 5.0 Mega Pixels, auto focus, Flash Light, mipi interface
Battery pack	3.7V, capacity 2860mAh
Charging time	2.5~3 hours
Backup Battery	<ul style="list-style-type: none"> • Li-ion Polymer 3.7V,80-100mA • hot swap time of 3-5 min. • battery cover detection
Hotswap functionality	Battery cover sensor and backup battery voltage detection for securing hotswap functionality
Working time	Video timeGaround 8 hours@film with speaker, 50%, Brightness 50%,WIFI Turn ON
Standby time	150 hours @ WIFI of & 3G Power on, 20mA

OT-310 Specifications

Speaker	Internal, 1 (0.5W) more than 80 dB SPL at 1m
Receiver	Internal, 1, add HAC compliant receiver
Microphone	Internal, 1
I/O	<ul style="list-style-type: none"> • 1 x SIM • 1 x Micro SD • 1 x Micro USB Female type, OTG & Charging function • 1 x Earphone Jack (pin defined as Apple) • 6 x Function Key (2 function key) • 1 x Power button, 2 x Volume button (Power button for 7-10 seconds for reset function) • 1 x POGO Pins (for Cradle), include charging function, OTG USB function • 1 x Internal Host usb for MSR or IC Card reader
Power Adaptor	<ul style="list-style-type: none"> • Input: 100V to 240V AC 50/60Hz 0.8A • Output: 5V DC 3A(DC-plug) (Micro USB male Type only support 1.5A) • AC Cable • Certification: UL, FCC, CE, PSE & BSMI, +/-2KV surge test
Dimension	77mm(W) x 147mm(L) x 19.9 mm(T)
Operating temperature	-10°C to +50°C
Storage temperature	-20°C to +70°C (without battery)
Charging temperature	0°C to +40°C
Humidity	5% to 95% RH (no condensation)
Sealing	IP54 per applicable IEC sealing specifications
Drop specification	Multiple 1.5 meters(4 feet) drop to concrete, 6 faces, 6 times per face, at 25 degree C operating temperature
Electrostatic Discharge (ESD)	<ul style="list-style-type: none"> • +/- 15kVdc air discharge @ could be reboot • +/- 8kVdc direct discharge @ could be re boot

*Design and specifications are subject to change without prior notice.

Troubleshooting

1. The device powers off automatically.

- The battery power is depleted. Charge the battery.

2. No sound comes out from the device.

- Check whether the volume is set to mute. Press the volume keys to adjust volume.
- Check whether the music file is damaged, try other files to test.

3. Cannot copy a file to the micro SD card.

- Check whether the micro SD card capacity is full.
- Try to delete or move some files to free space.

4. Cannot connect to the Internet.

- Check whether the device is connected to a wireless network.
- If no wireless network is available, try to use the SIM card's data network connection.
- The battery may be too low. Network connectivity uses more power. Be sure to charge the battery.

5. Captured photos are too dark.

- Check whether the **flash** mode setting is set to **Off**. To enable the flash usage during photography, set the flash mode setting to **On**.
- Turn on the room light or go outdoor to take pictures.

Preface

Copyright

Copyright © 2014. All rights reserved.

No part of this user manual may be reproduced, transmitted, stored in a retrieval system, or translated into any language, in any form or by any means, without permission from the manufacturer.

Google, the Google logo, Android, the Android logo and Tags are trademarks of Google Inc.

Wi-Fi is a registered trademark of the Wireless Fidelity Alliance.

microSD is a trademark of SD Card Association.

Bluetooth and the Bluetooth logo are trademarks owned by Bluetooth SIG, Inc.

Java, JME and all other Java-based marks are trademarks or registered trademarks of Sun Microsystems, Inc. in the United States and other countries.

All other products use in this device and trademarks mentioned herein are trademarks or registered trademarks of their respective owners.

Safety Information

Read the following safety information before using the device.

- Use only the power adaptor provided by the manufacturer. Use of unauthorized accessories may void the warranty.
- Avoid using the device near electromagnetic sources such as TVs, radios, and microwave ovens.
- Unplug the power adaptor from the wall outlet during lightning storms to avoid electric shock or fire.
- Do not expose the device to direct sunlight over a long period of time.
- Do not use harsh chemicals or detergents to clean the device.
- Do not handle the device with wet hands while it is being charged. This may cause an electric shock or serious damage to the device.
- Do not operate the device while it is being charged. This may cause unforeseen damage.
- Do not store the device in temperatures lower than -20°C or higher than 60°C.
- The operating temperature for this device is from -5°C to 50°C.
- Do not use the device on board an aircraft.

Regulatory Statement

RF Exposure Information (SAR)

This phone is designed and manufactured not to exceed the emission limits for exposure to radio frequency (RF) energy set by the Federal Communications Commission of the United States.

During SAR testing, this device was set to transmit at its highest certified power level in all tested frequency bands, and placed in positions that simulate RF exposure in usage against the head with no separation, and near the body with the separation of 10 mm. Although the SAR is determined at the highest certified power level, the actual SAR level of the device while operating can be well below the maximum value. This is because the phone is designed to operate at multiple power levels so as to use only the power required to reach the network. In general, the closer you are to a wireless base station antenna, the lower the power output.

The exposure standard for wireless devices employing a unit of measurement is known as the Specific Absorption Rate, or SAR.

The SAR limit set by the FCC is 1.6W/kg.

This device is complied with SAR for general population /uncontrolled exposure limits in ANSI/IEEE C95.1-1992 and had been tested in accordance with the measurement methods and procedures specified in IEEE1528. This device has been tested and meets the FCC RF exposure guidelines when tested with the device directly contacted to the body.

The FCC has granted an Equipment Authorization for this model phone with all reported SAR levels evaluated as in compliance with the FCC RF exposure guidelines. SAR information on this model phone is on file with the FCC and can be found under the Display Grant section of www.fcc.gov/oet/ea/fccid after searching on FCC ID: NDPOT-310.

While there may be differences between the SAR levels of various phones and at various positions, they all meet the government requirements.

SAR compliance for body-worn operation is based on a separation distance of 10 mm between the unit and the human body. Carry this device at least 10 mm away from your body to ensure RF exposure level compliant or lower to the reported level. To support body-worn operation, choose the belt clips or holsters, which do not contain metallic components, to maintain a separation of 10 mm between this device and your body.

RF exposure compliance with any body-worn accessory, which contains metal, was not tested and certified, and use such body-worn accessory should be avoided.

WEEE Notice

The WEEE logo on the product or on its box indicates that this product must not be disposed of or dumped with your other household waste. You are liable to dispose of all your electronic or electrical waste equipment by relocating over to the specified collection point for recycling of such hazardous waste. Isolated collection and proper recovery of your electronic and electrical waste equipment at the time of disposal will allow us to help conserve natural resources. Moreover, proper recycling of the electronic and electrical waste equipment will ensure safety of human health and environment. For more information about electronic and electrical waste equipment disposal, recovery, and collection points, please contact your local city center, household waste disposal service, shop from where you purchased the equipment, or manufacturer of the equipment.



FCC Regulations

15.19(a)(3):

This device complies with part 15 of the FCC Rules. Operation is subject to the following two conditions: (1) This device may not cause harmful interference, and (2) this device must accept any interference received, including interference that may cause undesired operation.

15.105(b):

NOTE: This equipment has been tested and found to comply with the limits for a Class B digital device, pursuant to part 15 of the FCC Rules. These limits are designed to provide reasonable protection against harmful interference in a residential installation.

This equipment generates, uses and can radiate radio frequency energy and, if not installed and used in accordance with the instructions, may cause harmful interference to radio communications. However, there is no guarantee that interference will not occur in a particular installation. If this equipment does cause harmful interference to radio or television reception, which can be determined by turning the equipment off and on, the user is encouraged to try to correct the interference by one or more of the following measures:

- Reorient or relocate the receiving antenna.
- Increase the separation between the equipment and receiver.
- Connect the equipment into an outlet on a circuit different from that to which the receiver is connected.
- Consult the dealer or an experienced radio/ TV technician for help

Changes or modifications not expressly approved by the party responsible for compliance could void the user's authority to operate the equipment.

About this Manual

The content in this manual is as accurate as possible. However, due to continuous product improvements, some contents and specifications may have been changed since this manual was written. In this case, take the actual device as basis.

No part of this user manual may be reproduced, transmitted, stored in a retrieval system, or translated into any language, in any form or by any means, without a written permission from the manufacturer.

Information is subject to change without prior notice.

PARTNER