

維克摩爾產品承認書

Specification For Approval

日期：2018/9/3

Date

編號：R-20180903012

File No.

承認廠商：拍檔科技股份有限公司

Customer

製造廠商：維克摩爾科技有限公司

Manufacturer



型號品名 WIFI ANTENNA-MAIN

Part Number

Description VM501-00300-00-0

廠商審核：

Approved By

Content

1. Product Configuration
2. Specification
3. SWR Test Data
4. Gain / Efficiency Test Data
5. Drawing Layout

2. Specification

- . Product Number : VM501-00300-00-0
- . Version : 1.0

Electrical Characteristics

- . Frequency (MHz) : 2400-5850 MHz
- . S.W.R. : ≤ 2.5
- . Efficiency : 61.9 % @ 2.4GHz
62.5 % @ 5GHz
- . Peak Gain : 6.7dBi @ 2.4GHz
5.1dBi @ 5GHz
- . Impedance : 50 ohm
- . Polarization : Linear

Mechanical Characteristics

- . Cable / Connector : O.D. 1.13mm / IPEX
- . Cover Material : PCB
- . Material : RoHS Compatible /
RoHS 2011/65/EU with IEC 62321:2008 Method

Environmental Condition

- . Operation Temperature : -30 ~ +65 °C
- . Storage Temperature : -30 ~ +75 °C

3. SWR Test Data

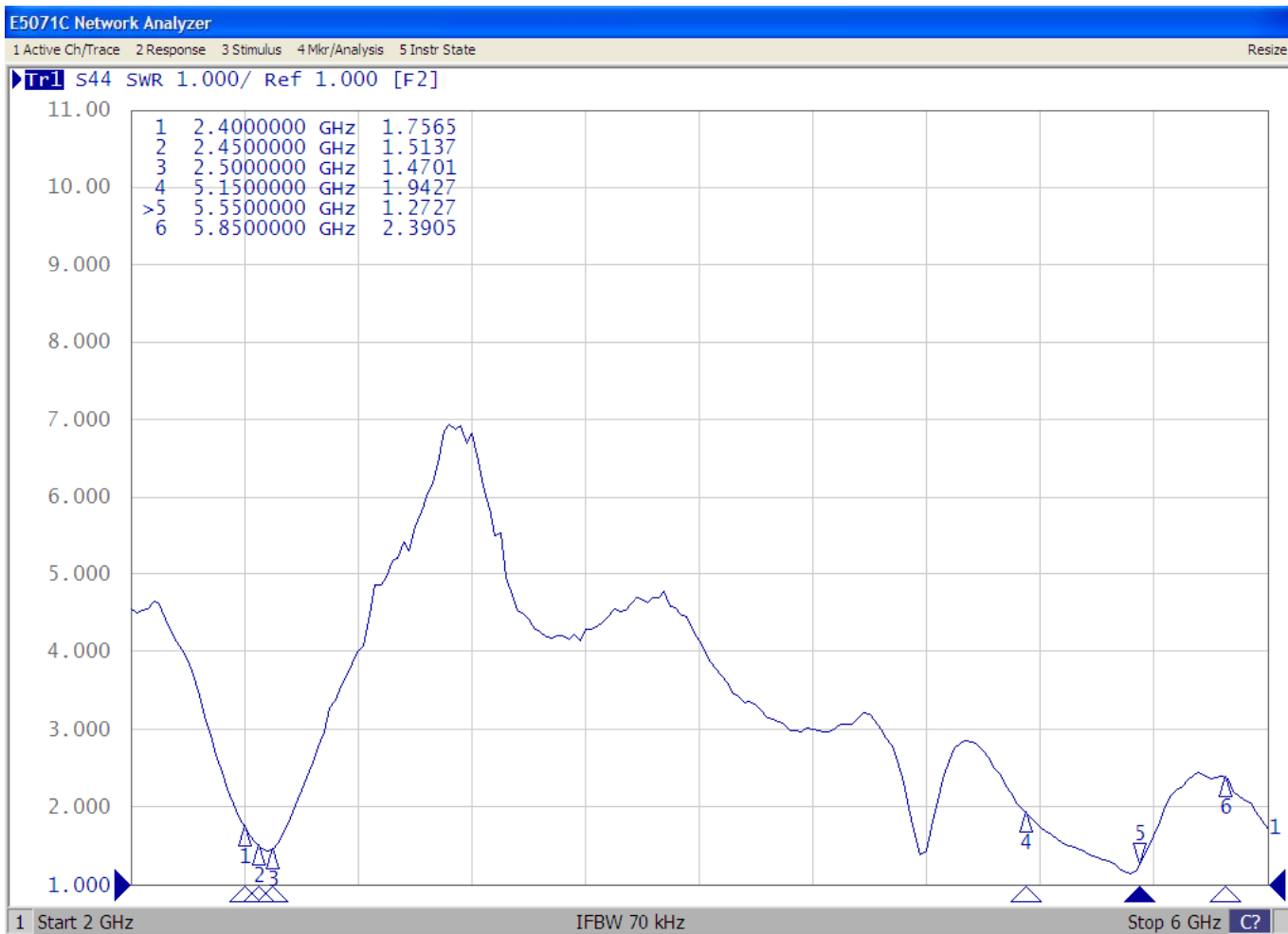

4. Gain / Efficiency Test Data

Frequency (MHz)	2400	2437	2450	2484	2500	5150	5250	5350	5470	5600	5725	5850
Peak Gain (dBi)	6.19	6.79	6.91	6.92	6.80	3.44	4.12	5.07	5.65	6.71	5.29	5.55
Directivity (dBi)	8.47	8.79	8.84	8.95	8.97	5.72	6.14	6.61	7.30	8.39	8.18	7.91
Efficiency (dB)	-2.28	-2.00	-1.93	-2.03	-2.17	-2.29	-2.02	-1.55	-1.65	-1.68	-2.89	-2.36
Efficiency (%)	59.15	63.05	64.09	62.72	60.70	59.06	62.74	70.02	68.32	67.90	51.42	58.04

Radiation Pattern

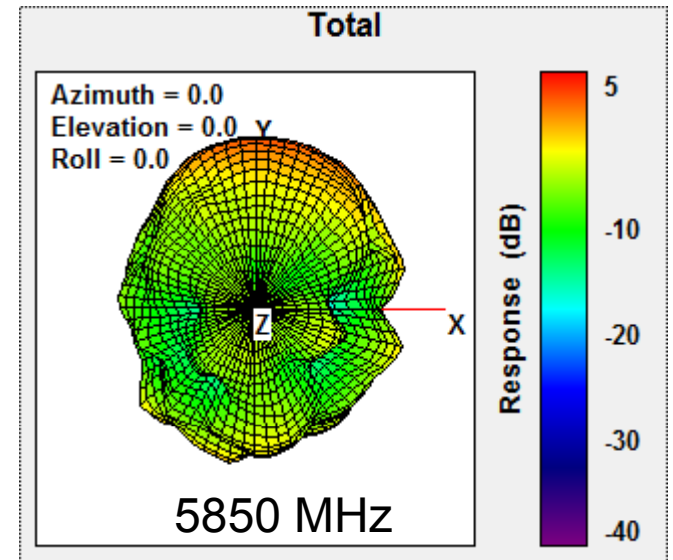
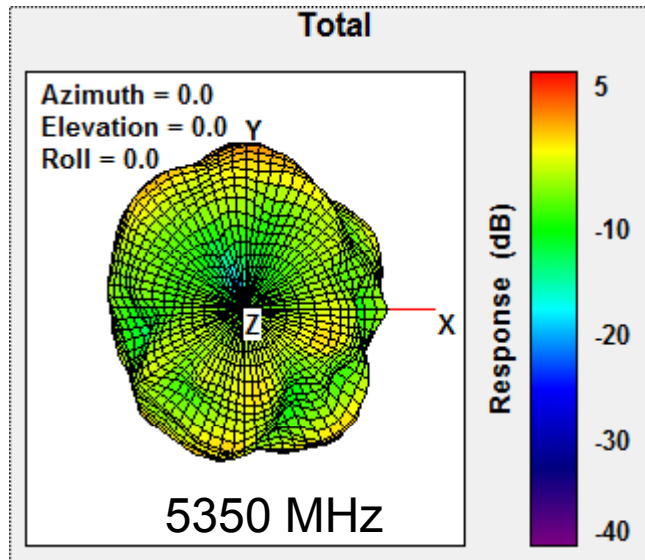
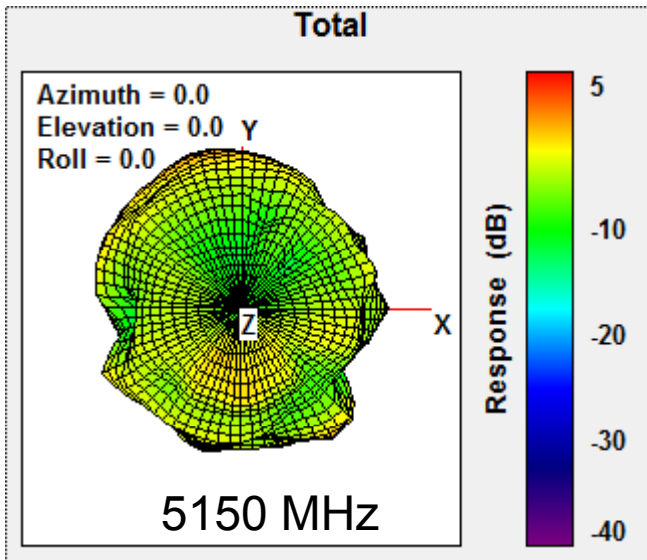
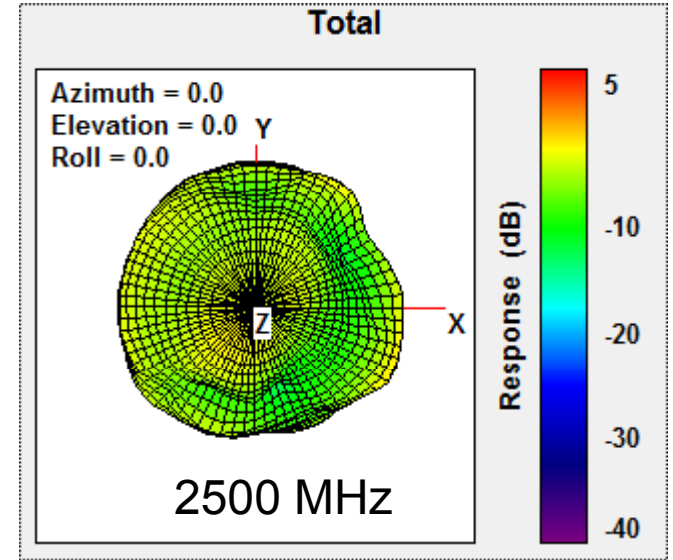
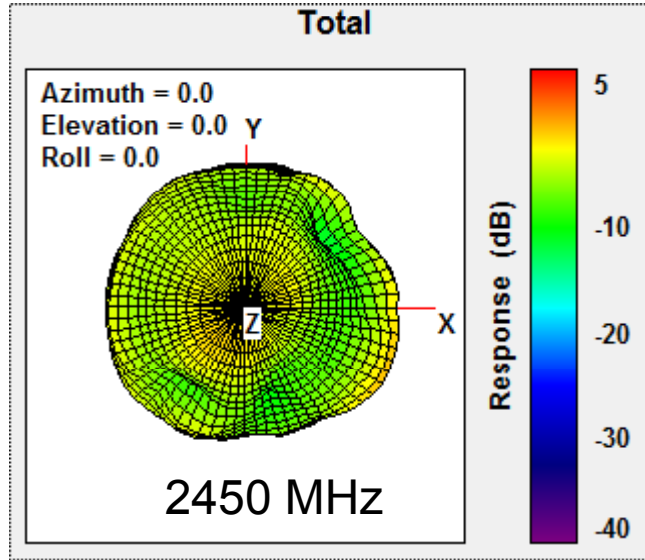
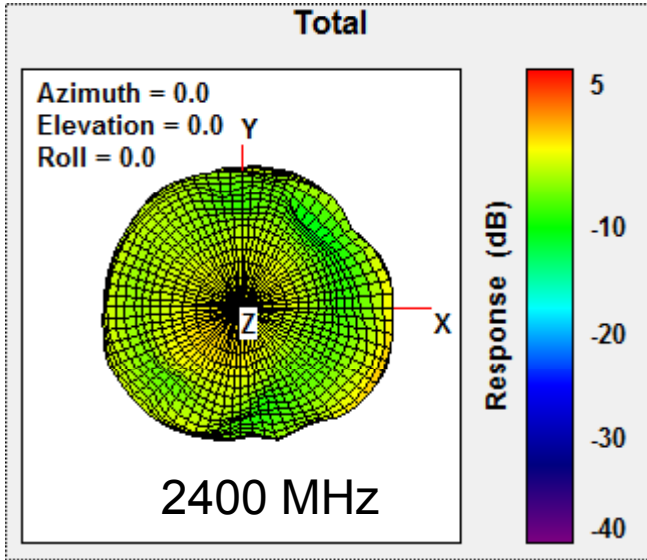

△ 65.0±5.0 O.D1.13
IPEX IV (Black)

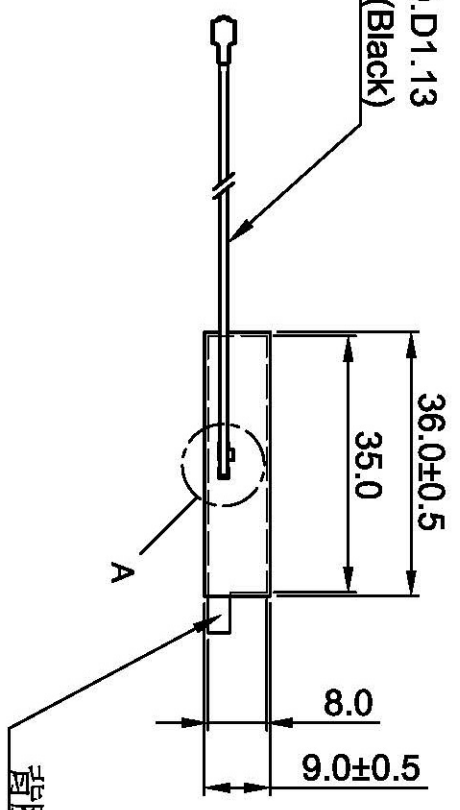

背膠離型紙易撕角

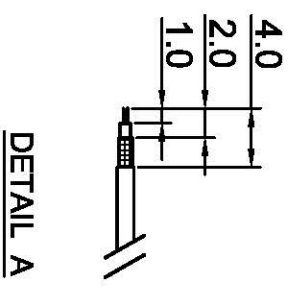
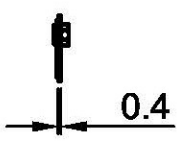
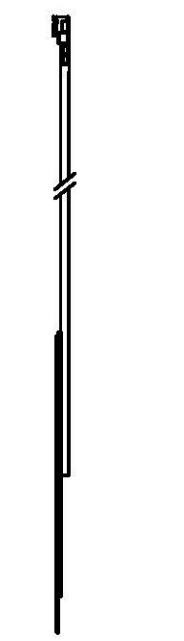
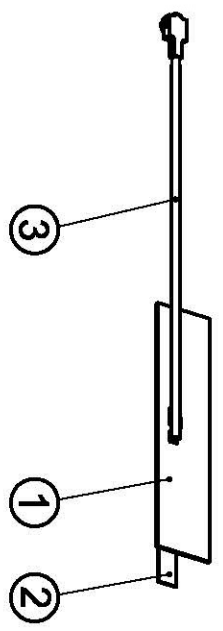

DETAIL A

ITEM	Description	QTY
3	CABLE ASSEMBLY AUDP1J-B0049	1
2	SONY G4000 35*8	1
1	PCB 36*9*0.4	1

THE DRAWING IS A CONTROLLED DOCUMENT

REVISIONS
 X 1 30.05 13.07
 XX 30.05 13.07
 XXX 30.05 13.07
 XXXX 30.05 13.07
 XXXXX 30.05 13.07

APPROVED BY:
 CHECKED BY:
 DRAWN BY:

THIRD ANGLE PROJECTION

MATERIAL:

FINISH:

SCALE: 2/1 UNIT:mm

DATE:

TITLE : WIFI ANTENNA-MAIN

DRAW No:

PART No: VM501-00300-00-0

維克摩爾科技有限公司