

TEST REPORT

of

FCC SAR

New Application; Class I PC; Class II PC

Product Name: Enterprise Tablet
Brand Name: Partner
Model Name: EM-100
Model Difference: N/A
FCC ID: NDPEM-100
FCC 47 CFR Part2(2.1093)
Standard: IEEE C95.1-1999; IEEE 1528
FCC OET 65 Supplement C(Edition 01-10)
Applicant: Partner Tech Corp.
Address: 10FL, 233-2, Baoqiao Road, Xindian,
New Taipei City, Taiwan

Test Performed by:
International Standards Laboratory

<Lung-Tan LAB>

*Site Registration No.: TAF: 0997

*Address:

No. 120, Lane 180, San Ho Tsuen, Hsin Ho Rd.

Lung-Tan Hsiang, Tao Yuan County 325, Taiwan

*Tel : 886-3-407-1718; Fax: 886-3-407-1738

Report No.: **ISL-14LR223FSAR**

Issue Date : **2014/10/03**



Test results given in this report apply only to the specific sample(s) tested and are traceable to national or international standard through calibration of the equipment and evaluating measurement uncertainty herein.

This report MUST not be used to claim product endorsement by TAF or any agency of the Government.

This test report shall not be reproduced except in full, without the written approval of International Standards Laboratory.

VERIFICATION OF COMPLIANCE

Applicant: Partner Tech Corp.
Product Description: Tablet
Brand Name: Partner
Model No.: EM-100
Model Difference: N/A
FCC ID: NDPEM-100
Date of Receipt: 2013/09/26
Date of Test: 2014/09/26 ~ 2014/09/29
Standard: FCC 47 CFR Part2(2.1093)
IEEE C95.1-1999; IEEE 1528
FCC OET 65 Supplement C(Edition 01-10)

We hereby certify that:

All the tests in this report have been performed and recorded in accordance with the standards described above and performed by an independent electromagnetic compatibility consultant, International Standards Laboratory.

The test results contained in this report accurately represent the measurements of the characteristics and the energy generated by sample equipment under test at the time of the test. The sample equipment tested as described in this report is in compliance with the limits of above standards.

Test By:

Dino Chen

Date:

2014/10/03

Dino Chen / Engineer

Prepared By:

Arno Hsieh

Date:

2014/10/03

Arno Hsieh / Supervisor

Approved By:

Vincent Su

Date:

2014/10/03

Vincent Su / Technical Manager

Version

Version No.	Date	Description
00	2014/10/03	Initial creation of document

Table of Contents

1	STATEMENT OF COMPLIANCE.....	5
2	GENERAL INFORMATION.....	6
2.1	DESCRIPTION OF DEVICE UNDER TEST (DUT).....	6
2.2	DUT PHOTOS.....	8
2.3	APPLIED STANDARDS.....	8
2.4	DEVICE CATEGORY AND SAR LIMITS.....	8
2.5	TEST ENVIRONMENT.....	8
2.6	TEST CONFIGURATION.....	9
3	SPECIFIC ABSORPTION RATE (SAR)	9
3.1	INTRODUCTION.....	9
3.2	SAR DEFINITION.....	9
4	SAR MEASUREMENT SYSTEM.....	10
4.1	ALSAS-10U SYSTEM DESCRIPTION.....	10
4.2	E-FIELD PROBE ALS-E-020S.....	11
4.3	DAQ-PAQ (ANALOG TO DIGITAL ELECTRONICS) ALS-DAQ-PAQ-3 BOUNDARY DETECTION UNIT ALS-PMDPS-3.....	13
4.4	AXIS ARTICULATED ROBOT ALS-F3.....	15
4.5	ALSAS UNIVERSAL WORKSTATION ALS-UWS.....	15
4.6	SAM PHANTOMS ALS-P-SAM-L / ALS-P-SAM-R.....	16
4.7	UNIVERSAL DEVICE POSITIONER.....	18
4.8	TEST EQUIPMENT LIST.....	19
5	TISSUE SIMULATING LIQUIDS.....	20
6	SAR MEASUREMENT EVALUATION.....	23
7	DUT TESTING POSITION.....	26
8	SAR MEASUREMENT PROCEDURES.....	29
9	SAR TEST RESULTS.....	31
9.1	CONDUCTED POWER TABLE:.....	31
9.2	TEST RECORDS FOR BODY SAR TEST.....	33
10	EXPOSURE ASSESSMENT MEASUREMENT UNCERTAINTY.....	36
APPENDIX A	TEST SETUP PHOTOS.....	38
APPENDIX B	DUT PHOTOS.....	41
APPENDIX C:	SYSTEM PERFORMANCE CHECK.....	41
APPENDIX D:	SAR MEASUREMENT DATA.....	41
APPENDIX E:	PROBE CALIBRATION CERTIFICATE.....	41
APPENDIX F:	DIPOLE CALIBRATION CERTIFICATE.....	41

1 Statement of Compliance

The maximum results of Specific Absorption Rate (SAR) were found during testing for EUT, which are as follows (with expanded uncertainty 21.4 % for 300 MHz to 3 GHz).

Wifi mode:

Type	FCC Equipment Class	Position	SAR 1g(W/kg)
802.11b	DTS	Body, 0cm distance	1.408
802.11 g	DTS	Body, 0cm distance	1.386
802.11 20n	DTS	Body, 0cm distance	1.385
802.11a Band 1	NII	Body, 0cm distance	1.284
802.11a Band 4	NII	Body, 0cm distance	1.389
802.11an 20n Band 1	NII	Body, 0cm distance	1.133
802.11an 20n Band 4	NII	Body, 0cm distance	1.302

BT mode(Worst Case):

Type	FCC Equipment Class	Position	SAR 1g(W/kg)
BT (EDR2)	DSS	Body, 0cm distance	0.002

Simultaneous transmission mode:

Type	FCC Equipment Class	Position	SAR 1g(W/kg)
N/A	N/A	N/A	N/A

Note 1: Simultaneous transmission mode: The BT share same antenna with Wifi, BT was not Simultaneous transmission with Wifi.

FCC SAR test exclusion for BT mode:

The Max average output power of BT(BDR, DER1, DER2 and BLE) is **-1.42dBm (0.0007211 W)**, According to FCC SAR test exclusion, BT SAR measurement is not necessary.

According to KDB 447498 D01 V5, Appendix A: SAR Test Exclusion Thresholds for 100 MHz – 6 GHz and ≤ 50 mm, the thresholds power level is 10mW (10dBm) at 5 mm.

The 1-g and 10-g SAR test exclusion thresholds for 100MHz to 6GHz at test separation distance ≤ 50mm are determined by

$$\frac{\text{max. power of channel [mW]}}{\text{min. test separation distance [mm]}} \cdot \sqrt{f[\text{GHz}]} \leq \begin{cases} 3.0 & 1g \text{ SAR} \\ 7.5 & 10g \text{ SAR} \end{cases}$$

- f [GHz] is the RF channel transmit frequency in GHz
- Power and distance are rounded to the nearest mW and mm before calculation
- The result is rounded to one decimal place for comparison

2 General Information

2.1 Description of Device Under Test (DUT)

General:

Product Name	Enterprise Tablet
Brand Name	Partner
Model Name	EM-100
Model Difference	N/A
Power Supply	3.7Vdc from Li-ion Battery or 5Vdc AC/DC Adapter

Bluetooth:

Bluetooth Version	V2.1 + EDR (GFSK + $\pi/4$ DQPSK + 8DPSK)	V4.0(GFSK)
Frequency Range:	2402 – 2480MHz	2402 – 2480MHz
Channel number:	79 channels	40 channels
Modulation type:	Frequency Hopping Spread Spectrum	Digital Modulation (Direct Sequence Spread Spectrum)
Rated Transmit Power:	0 dBm +/- 2 dB(Peak)	0 dBm +/- 2 dB (Peak)
Dwell Time:	$\leq 0.4s$	N/A
Antenna Designation:	Printed Antenna 2.59dBi	

The EUT is compliance with Bluetooth EDR V2.1 +V4.0 Standard.

WLAN: 1TX, 1RX

Wi-Fi	Frequency Range (MHz)	Channels	Rated Power at each Chain(Average)	Modulation Technology
802.11b	2412 – 2462(DTS)	11	12.0 +/- 1dBm	DSSS
802.11g	2412 – 2462(DTS)	11	12.0 +/- 1dBm	DSSS, OFDM
802.11n	HT20 2412 – 2462(DTS)	11	12.0 +/- 1dBm	OFDM
	HT20 5180 – 5240(NII)	4	9.0 +/- 1dBm	
	HT20 5745 – 5850(NII)	5	11.0 +/- 1dBm	
802.11a	5180 – 5240(NII)	4	9.0 +/- 1dBm	OFDM
	5745 – 5850(NII)	5	11.0 +/- 1dBm	
Modulation type		CCK, DQPSK, DBPSK for DSSS 64QAM, 16QAM, QPSK, BPSK for OFDM		
Antenna Designation:		Printed Antenna 2.59dBi for 2.4GHz 0.86dBi for 5GHz		

The EUT is compliance with IEEE 802.11 a/b/g/n Standard.

Remark: The above DUT's information was declared by manufacturer. Please refer to the specifications or user's manual for more detailed description.

2.2 DUT Photos

Please refer to Appendix B. see rf report.

2.3 Applied Standards

The Specific Absorption Rate (SAR) testing specification, method and procedure for this Tablet is in accordance with the following standards:

FCC 47 CFR Part 2 (2.1093)

IEEE C95.1-1999

IEEE 1528-2003

FCC OET Bulletin 65 Supplement C (Edition 01-01)

FCC KDB 447498 D01 General RF Exposure Guidance v05r02: Feb/07/2014

FCC KDB 616217 D04 SAR for laptop and tablets v01r01: 5/28/2013

FCC KDB 789033 D02 General UNII Test Procedures New Rules v01: Jun/06/2014

FCC KDB 248227 D01 SAR meas for 802 11 a b g v01r02 : 05/2007

FCC KDB 558074 D01 DTS Meas Guidance v03r02: June 5, 2014

FCC KDB 865664 D01 SAR Measurement 100 MHz to 6 GHz v01r03: February 7, 2014

FCC KDB 865664 D02 RF Exposure Reporting v01r01: May 28, 2013

2.4 Device Category and SAR Limits

This device belongs to **portable** device category because its radiating structure is allowed to be used within 20 centimeters of the body of the user. Limit for **General Population/Uncontrolled** exposure should be applied for this device, it is **1.6 W/kg** as averaged over any 1 gram of tissue.

Limits for General Population/Uncontrolled Exposure (W/kg)

Type Exposure	Uncontrolled Environment Limit
Spatial Peak SAR (1g cube tissue for brain or body)	1.60 W/kg
Spatial Average SAR (whole body)	0.08 W/kg
Spatial Peak SAR (10g for hands, feet, ankles and wrist)	4.00 W/kg

2.5 Test Environment

Item	Required	Actual
Temperature (°C)	18-25°C	20 to 24 °C
Humidity (%RH)	30-70 %	< 60 %

2.6 Test Configuration

The device was controlled by using a test software to transmit TX power level at max continuously. Modulation type and Channel number are selected by software also.

3 Specific Absorption Rate (SAR)

3.1 Introduction

SAR is related to the rate at which energy is absorbed per unit mass in an object exposed to a radio field. The SAR distribution in a biological body is complicated and is usually carried out by experimental techniques or numerical modeling. The standard recommends limits for two tiers of groups, occupational/controlled and general population/uncontrolled, based on a person's awareness and ability to exercise control over his or her exposure. In general, occupational/controlled exposure limits are higher than the limits for general population/uncontrolled.

3.2 SAR Definition

The SAR definition is the time derivative (rate) of the incremental energy (dW) absorbed by (dissipated in) an incremental mass (dm) contained in a volume element (dv) of a given density (ρ). The equation description is as below:

$$SAR = \frac{d}{dt} \left(\frac{dW}{dm} \right) = \frac{d}{dt} \left(\frac{dW}{\rho dV} \right)$$

SAR is expressed in units of Watts per kilogram (W/kg)

SAR measurement can be either related to the temperature elevation in tissue by

$$SAR = C \left(\frac{\delta T}{\delta t} \right)$$

Where: C is the specific heat capacity, δT is the temperature rise and δt is the exposure duration, or related to the electrical field in the tissue by

$$SAR = \frac{\sigma |E|^2}{\rho}$$

Where: σ is the conductivity of the tissue, ρ is the mass density of the tissue and E is the RMS electrical field strength.

However for evaluating SAR of low power transmitter, electrical field measurement is typically applied.

4 SAR Measurement System

4.1 ALSAS-10U System Description

APREL Laboratories ALSAS-10U is fully optimized for the dosimetric evaluation of a broad range of wireless transceivers and antennas. Developed in line with the latest methodologies it is fully compliant with the technical and scientific requirements of IEEE 1528, IEC 62209 Part 1 & 2 (draft), CENELEC, ARIB, ACA, and the Federal Communications Commission. The system comprises of a six axes articulated robot which utilizes a dedicated controller.

ALSAS-10U uses the latest methodologies and FDTD modeling to provide a platform which is repeatable with minimum uncertainty.

Applications

ALSAS-10U is designed to cover the frequency range from 30MHz to 6GHz as per the IEC 62209 Part II (draft) standard. There is no limiting factor to the operating RF carrier frequency range for the ALSAS-10U system other than the phantoms chosen for testing. The ALSAS-10U has been designed to be modular and phantoms are integrated onto the Universal Workstation™ so as to allow for complete flexibility of the measurement process. This unique design allows for a fully flexible system which can be built around the exact needs of the user.

Area Scans

Area scans are defined prior to the measurement process being executed with a user defined variable spacing between each measurement point (integral) allowing low uncertainty measurements to be conducted. Scans defined for FCC applications utilize a 10mm² step integral, with 1mm interpolation used to locate the peak SAR area used for zoom scan assessments.

Where the system identifies multiple SAR peaks (which are within 25% of peak value) the system will provide the user with the option of assessing each peak location individually for zoom scan averaging.



Zoom Scan (Cube Scan Averaging)

The averaging zoom scan volume utilized in the ALSAS-10U software is in the shape of a cube and the side dimension of a 1 g or 10 g mass is dependent on the density of the liquid representing the simulated tissue. A density of 1000 kg/m³ is used to represent the head and body tissue density and not the phantom liquid density, in order to be consistent with the definition of the liquid dielectric properties, i.e. the side length of the 1 g cube is 10mm, with the side length of the 10 g cube 21,5mm.

When the cube intersects with the surface of the phantom, it is oriented so that 3 vertices touch the surface of the shell or the center of a face is tangent to the surface. The face of the cube closest to the surface is modified in order to conform to the tangent surface.

The zoom scan integer steps can be user defined so as to reduce uncertainty, but normal practice for typical test applications (including FCC) utilize a physical step of 5x5x8 (8mmx8mmx5mm) providing a volume of 32mm in the X & Y axis, and 35mm in the Z axis.

ALSAS-10U Interpolation and Extrapolation Uncertainty

The overall uncertainty for the methodology and algorithms the used during the SAR calculation was evaluated using the data from IEEE 1528 based on the example f3 algorithm:

$$f_3(x, y, z) = A \frac{a^2}{\frac{a^2}{4} + x'^2 + y'^2} \cdot \left(e^{-\frac{2z}{a}} + \frac{a^2}{2(a + 2z)^2} \right)$$

Refer to raw data for measurement uncertainty

4.2 E-Field Probe ALS-E-020S

The isotropic E-Field probe has been fully calibrated and assessed for isotropicity, and boundary effect within a controlled environment. Depending on the frequency for which the probe is calibrated the method utilized for calibration will change. A number of methods is used for calibrating probes, and these are outlined in the table below:

The E-Field probe utilizes a triangular sensor arrangement as detailed in the diagram below:

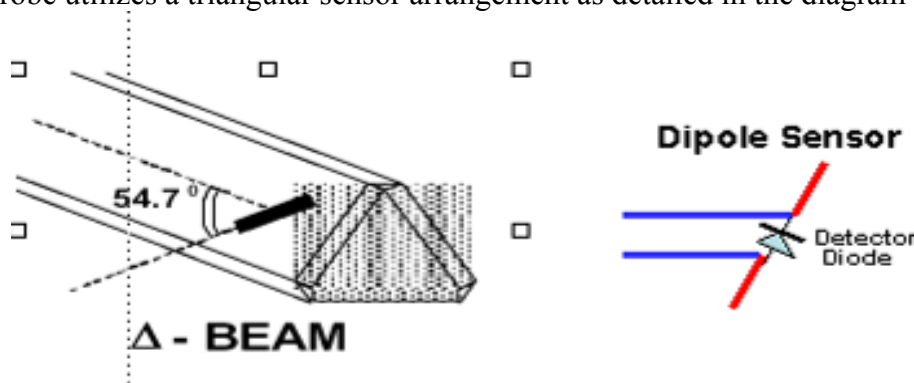

SAR is assessed with a calibrated probe which moves at a default height of 5mm from the center of the diode, which is mounted to the sensor, to the phantom surface (in the Z Axis). The 5mm offset height has been selected so as to minimize any resultant boundary effect due to the probe being in close proximity to the phantom surface.

The following algorithm is an example of the function used by the system for linearization of the output from the probe when measuring complex modulation schemes.

$$V_i = U_i + U_i^2 \cdot \frac{cf}{dcp_i}$$

4.2.1 E-Field Probe Specification

Model: ALS-E-020S

Compliant Standards	IEEE 1528, IEC 62209 Part 1 & 2 (draft)
Frequency Range	30 MHz ~ 6 GHz
Sensitivity	Better than 0.8 μ V/(V/m) ²
Dynamic Range SAR	0.001 W/kg to 100 W/kg
Isotropic Response Axial	Typically \pm 0.1dB
Hemispherical isotropy	\pm 0.3 dB or better
Linearity	\pm 0.2 dB or better
Probe Tip Radius	User selectable all <5 mm
Sensor Offset	1.56 (\pm 0.02 mm)
Probe Length	290 mm
Video Bandwidth	@ 500 Hz: 1 dB @ 1K Hz: 3 dB
Boundary Effect	Less than 2% for distances greater than 2.4 mm
Material	Ertalyte™
Connector	6 Pin Bayonet

E-Field Probe Calibration

Each probe needs to be calibrated according to a dosimetric assessment procedure with accuracy better than \pm 10%. The spherical isotropy shall be evaluated and within \pm 0.25 dB. The sensitivity parameters (NormX, NormY, and NormZ), the diode compression parameter (DCP) and the conversion factor (ConvF) of the probe are tested. The calibration data can be referred to appendix C of this report.

Boundary Detection Unit and Probe Mounting Device

ALSAS-10U incorporates a boundary detection unit with a sensitivity of 0.05mm for detecting all types of surfaces. The robust design allows for detection during probe tilt (probe normalize) exercises, and utilizes a second stage emergency stop. The signal electronics are fed directly into the robot controller for high accuracy surface detection in lateral and axial detection modes (X, Y, & Z).

The probe is mounted directly onto the Boundary Detection unit for accurate tooling and displacement calculations controlled by the robot kinematics. The probe is connect to an isolated probe interconnect where the output stage of the probe is fed directly into the amplifier stage of the Daq-Paq.

4.3 DAQ-PAQ (Analog to Digital Electronics) ALS-DAQ-PAQ-3 Boundary Detection Unit ALS-PMDPS-3

ALSAS-10U incorporates a fully calibrated Daq-Paq (analog to digital conversion system) which has a 4 channel input stage, sent via a 2 stage auto-set amplifier module. The input signal is amplified accordingly so as to offer a dynamic range from 4 μ V to 330 mV. Integration of the fields measured is carried out at board level utilizing a Co-Processor which then sends the measured fields down into the main computational module in digitized form via an RS232 communications port. Probe linearity and duty cycle compensation is carried out within the main Daq-Paq module.

PMDPS is used to hold a probe and to detect complex boundary locations (curved and flat surfaces) during a SAR or HAC assessment process. It utilizes relative movements of internal components to trigger integrated micro-sensor mechanisms in order to detect boundary(s) and consequently position the probe at the specified distance relative to a boundary in order to achieve accurate and repeatable measurements.

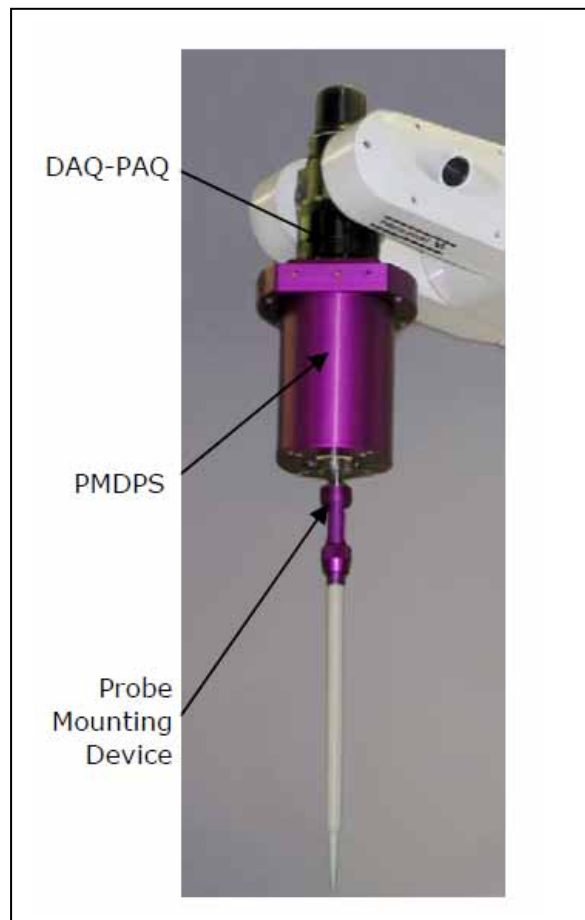

Amplifier Range	4 μ V to 330 mV
ADC	16 Bit optically isolated
Built-in E-Stop Feature	Emergency Stop feature to prevent damage of equipment and for user safety purposes
Field Integration	Local Co-Processor utilizing proprietary integration algorithms
SAR Dynamic Range	0.001 W/kg -100 W/kg.
Ambient Noise	Below 0.001 W/kg measured with probe in tissue
LED Indication	Boundary detection and DAQ-PAQ State
Number of Input Channels	4 in total 3 dedicated and 1 spare for future upgrades (when and if needed)
Communication	Optically isolated packet data via RS232
Robot Arm Integration	DAQ-PAQ and Boundary Detection Unit are mounted directly onto joint 6 of the F3 arm utilizing joint 6 tool (ISO Standard M8 Mounting Plate) to allow easy integration and removal (no angular interface)
Supply	DC supply powered by an isolated external supply unit (no battery required)
LED Indicators	Probe status (amplifier on) and boundary detection

PMDPS Specification details

Accuracy of Positioning	Better than 10 μ m at 6GHz
SAR Uncertainty	Better than 0.01 W/kg SAR at 6Gz
Detection Mechanism	2 x 360° Stage Axial and Lateral Detection at 6GHz
Emergency Stop	4 Stage 360° Axial and Lateral Detection at 6GHz
Probe Mounting	6 Pin Bayonet for Fast Probe Change
Calibration	Every PMDPS is Calibrated to 0.01 W/kg SAR at 6GHz
Reliability Expectations	Better Than 10,000,000 Cycles

4.4 Axis Articulated Robot ALS-F3



ALSAS-10U utilizes a six axis articulated robot, which is controlled using a Pentium based real-time movement controller. The movement kinematics engine utilizes proprietary (Thermo CRS) interpolation and extrapolation algorithms, which allow full freedom of movement for each of the six joints within the working envelope. Utilization of joint 6 allows for full probe rotation with a tolerance better than 0.05mm around the central axis.

Robot/Controller Manufacturer	Thermo CRS
Number of Axis	Six independently controlled axis
Positioning Resolution	0.05mm
Controller Type	Single phase Pentium based C500C
Robot Reach	710mm
Repeatability	0.05mm or better
Communication	RS232 and LAN compatible

4.5 ALSAS Universal Workstation ALS-UWS

ALSAS Universal workstation allows for repeatability and fast adaptability. It allows users to do calibration, testing and measurements using different types of phantoms with one set up, which significantly speeds up the measurement process.

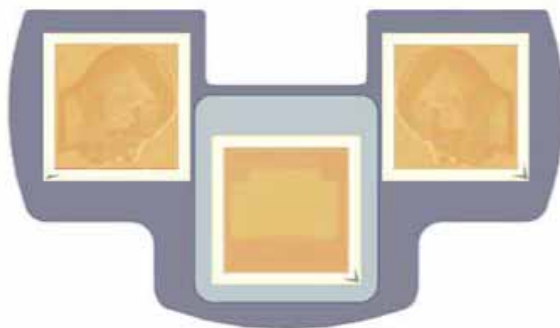

Workstation.
Top view (rendering)

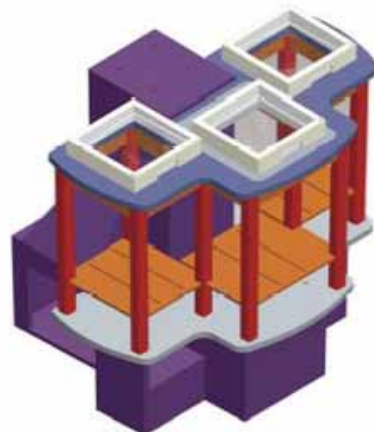

Workstation
without robot (rendering)

4.6 SAM Phantoms ALS-P-SAM-L / ALS-P-SAM-R

The ALSAS-10U allows the integration of multiple phantom types. SAM Phantoms fully compliant with IEEE 1528, Universal Phantom, and Universal Flat.

APREL SAM Phantoms

The SAM phantoms developed using the IEEE SAM CAD file. They are fully compliant with the requirements for both IEEE 1528 and FCC Supplement C. Both the left and right SAM phantoms are interchangeable, transparent and include the IEEE 1528 grid with visible NF and MB lines.

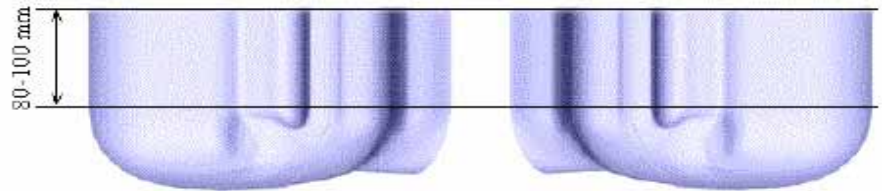

Compliant Standards	IEEE-1528, IEC 62209 Part 1 & 2 (draft)
SAM	In accordance with the IEEE 1528 standard
Material	Composite urethane which allows for the device to be viewed through the phantom, resistant to DGBE
Phantom Shell Shape Tolerance	Fully calibrated to be better than ± 0.2 mm
Frame Material	Corian®
Tissue Simulation Volume	7 liter with 15.0 ± 0.5 cm tissue
Thickness	$2 \text{ mm} \pm 0.2 \text{ mm}$ $6 \text{ mm} \pm 0.2 \text{ mm}$ at NF/MB intersection
Loss Tangent	<0.05
Relative Permittivity	<5
Resistant to Solvents	Resistant to all solvents used for tissue manufacturing detailed in IEEE 1528
Load Deflection	<1mm with sugar water compositions
Manufacturing Process	Injection Molded
Phantom Weight	Less than 10kg when filled with 15cm of simulation tissue

Universal Phantom ALS-P-UP-1

The Universal Phantom is used on the ALSAS-10U as a system validation phantom. The Universal Phantom has been fully validated both experimentally from 800MHz to 6GHz and numerically using XFDTD numerical software. The shell thickness is 2mm overall, with a 4mm spacer located at the NF/MB intersection providing an overall thickness of 6mm in line with the requirements of IEEE-1528.



The design allows for fast and accurate measurements, of handsets, by allowing the conservative SAR to be evaluated at on frequency for both left and right head experiments in one measurement.

Compliant Standards	IEEE-1528, IEC 62209 Part 1 & 2 (draft), CENELEC, and others
Manufacturing Process	Injection molded
Material	Vivac
Phantom Shell Shape Tolerance	Less than ± 0.2 mm
Frame Material	Corian®
Tissue Simulation Volume	8 liter with 15.0 ± 0.5 cm tissue
Thickness	2mm ± 0.2 mm 6mm at NF/MB intersection
Loss Tangent	<0.05
Relative Permittivity	<5
Resistant to Solvents	Resistant to all solvents detailed in IEEE 1528
Load Deflection	<1mm with heaviest tissue (sugar water compositions)
Dimensions	Length 220mm x breadth 170mm
Phantom Weight	Less than 10kg when filled with 15cm of simulation tissue

4.7 Universal Device Positioner

ALS-H-E-SET-2

The universal device positioner allows complete freedom of movement of the EUT. Developed to hold a EUT in a free-space scenario any additional loading attributable to the material used in the construction of the positioner has been eliminated. Repeatability has been enhanced through the linear scales which form the design used to indicate positioning for any given test scenario in all major axes. A 15° tilt indicator is included for the of aid cheek to tilt movements for head SAR analysis. Overall uncertainty for measurements has been reduced due to the design of the Universal device positioner, which allows positioning of a device in as near to a free-space scenario as possible, and by providing the means for complete repeatability.

Compliant Standards	IEEE 1528, IEC 62209 Part 1 & 2 (draft)
Dielectric constant	Less than 5.0
Loss Tangent	Less than 0.05
Number of Axis	6 axis freedom of movement (8 when utilized with ALSAS-10U Workstation)
Translation Along MB Line	± 76.2 mm
Translation Along NF Line	± 38.1 mm
Translation Along Z Axis	± 25.4 mm (expandable up to 500 mm)
Rotation Around MB Line (yaw)	±10°
Rotation Around NF (pitch)	± 30°
Line Rotation (roll)	360° full circle
Maximum Grip Range	0 mm to 150 mm
Material	Resistant to DGBE and all other tissue stimulant materials as listed in IEEE 1528 Annex C.1.
Tilt Movement	Full movement with built-in 15° gauge

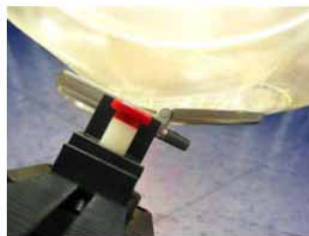

4.8 Test Equipment List

Equipment Type	MFR	Model No.	Serial No.	Last Cal.	Cal. Due Date
Vector Network Analyzer	Agilent	E5071B	MY42402726	11/23/2013	11/22/2014
Dielectric Probe Kit	Aglient	85070E	MY44300124	N/A	N/A
Vector Signal Generator	R&S	SMU200A	102330	02/19/2014	02/18/2015
Power Meter	Anritsu	ML2495A	1116010	05/08/2014	05/07/2015
Power Sensor	Anritsu	MA2411B	34NKF50	05/08/2014	05/07/2015
Data Acquisition Package	Aprel	ALS-DAQ-PAQ-3	110-00220	NA	NA
Aprel Laboratories Probe	Aprel	ALS-E020	500-00283	10/08/2013	10/07/2014
Aprel Reference Dipole 2450MHz	Aprel	ALS-D-2450-S-2	2450-220-00753	01/25/2012	01/24/2015
Aprel Reference Dipole 5200MHz	Aprel	ALS-D-5200-S-2	5200-230-00802	01/25/2012	01/24/2015
Aprel Reference Dipole 5800MHz	Aprel	ALS-D-5800-S-2	5800-240-00852	01/25/2012	01/24/2015
Boundary Detection Sensor System	Aprel	ALS-PMDPS-3	120-00266	N/A	N/A
Universal Work Station	Aprel	ALS-UWS	100-00153	N/A	N/A
Device Holder 2.0	Aprel	ALS-H-E-SET-2	170-00503	N/A	N/A
Left Ear SAM Phantom	Aprel	ALS-P-SAM-L	130-00305	N/A	N/A
Right Ear SAM Phantom	Aprel	ALS-P-SAM-R	140-00359	N/A	N/A
Universal Phantom	Aprel	ALS-P-UP-1	150-00405	N/A	N/A
Aprel Dipole Spacer	Aprel	ALS-DS-U	250-00903	N/A	N/A
SAR Software	Aprel	ALSAS-10U Ver.2.5.0.261	B0D5F-112FE	N/A	N/A
CRS C500C Controller	Thermo	ALS-C500	RCF0440278	N/A	N/A
CRF F3 Robot	Thermo	ALS-F3	RAF0440252	N/A	N/A
Power Amplifier	Mini-Circuit	ZVE-8G	D030305	N/A	N/A

Note: All equipment upon which need to be calibrated are with calibration period of 1 year.

5 Tissue Simulating Liquids

Tissue Dielectric Parameters for Head and Body Phantoms

The head tissue dielectric parameters recommended by the IEEE SCC-34/SC-2 in P1528 have been incorporated in the following table. These head parameters are derived from planar layer models simulating the highest expected SAR for the dielectric properties and tissue thickness variations in a human head. Other head and body tissue parameters that have not been specified in P1528 are derived from the tissue dielectric parameters computed from the 4-Cole-Cole equations described in Reference [12] and extrapolated according to the head parameters specified in P1528.

Target Frequency (MHz)	Parameters(Body) IEEE1528 OTE 65		Parameters(Head) 62209-1/-2 IEEE1528 OET65	
	ϵ_r	σ (S/m)	ϵ_r	σ (S/m)
835	55.2	0.97	41.5	0.90
900	55.0	1.05	41.5	0.97
1800 – 2000	53.3	1.52	40.0	1.4
2450	52.7	1.95	39.2	1.8
5800	48.2	6.00	35.3	5.27

(ϵ_r = relative permittivity, σ = conductivity and $\rho = 1000 \text{ kg/m}^3$)

Ingredients (% by weight)	Frequency (MHz)									
	450		835		915		1900		2450	
Tissue Type	Head	Body	Head	Body	Head	Body	Head	Body	Head	Body
Water	38.56	51.16	41.45	52.4	41.05	56.0	54.9	40.4	62.7	73.2
Salt (NaCl)	3.95	1.49	1.45	1.4	1.35	0.76	0.18	0.5	0.5	0.04
Sugar	56.32	46.78	56.0	45.0	56.5	41.76	0.0	58.0	0.0	0.0
HEC	0.98	0.52	1.0	1.0	1.0	1.21	0.0	1.0	0.0	0.0
Bactericide	0.19	0.05	0.1	0.1	0.1	0.27	0.0	0.1	0.0	0.0
Triton X-100	0.0	0.0	0.0	0.0	0.0	0.0	0.0	0.0	36.8	0.0
DGBE	0.0	0.0	0.0	0.0	0.0	0.0	44.92	0.0	0.0	26.7
Dielectric Constant	43.42	58.0	42.54	56.1	42.0	56.8	39.9	54.0	39.8	52.5
Conductivity (S/m)	0.85	0.83	0.91	0.95	1.0	1.07	1.42	1.45	1.88	1.78

Tissue Calibration Result

The dielectric parameters of the liquids were verified prior to the SAR evaluation using Agilent Dielectric Probe Kit 85070E and Agilent E5071B Vector Network Analyzer

Body Tissue Simulant Measurement				
Frequency [MHz]	Description	Dielectric Parameters		Tissue Temp. [°C]
		ϵ_r	σ [s/m]	
	Reference result ± 5% window	52.7 50.065 to 55.335	1.95 1.852 to 2.047	N/A
2412	Sep 26, 2014	53.236	1.912	21.5
2437	Sep 26, 2014	53.358	1.914	21.5
2462	Sep 26, 2014	53.512	1.916	21.5
2412	Sep 29, 2014	53.239	1.912	21.5
2437	Sep 29, 2014	53.366	1.914	21.5
2462	Sep 29, 2014	53.523	1.916	21.5

Body Tissue Simulant Measurement				
Frequency [MHz]	Description	Dielectric Parameters		Tissue Temp. [°C]
		ϵ_r	σ [s/m]	
	Reference result ± 10% window	48.2 43.38 to 53.02	6.0 5.400 to 6.600	N/A
5180	Sep 26, 2014	44.133	5.53	21.5
5240	Sep 26, 2014	44.227	5.56	21.5
5745	Sep 26, 2014	44.169	6.21	21.6
5785	Sep 26, 2014	44.175	6.23	21.6
5825	Sep 26, 2014	44.196	6.25	21.6
5180	Sep 29, 2014	44.135	5.53	21.5
5240	Sep 29, 2014	44.240	5.54	21.5
5745	Sep 29, 2014	44.166	6.22	21.6
5785	Sep 29, 2014	44.173	6.24	21.6
5825	Sep 29, 2014	44.195	6.25	21.6

6 SAR Measurement Evaluation

Each system is equipped with one or more system validation kits. These units, together with the predefined measurement procedures within the APREL SAR software, enable the user to conduct the system performance check and system validation. System validation kit includes a dipole, tripod holder to fix it underneath the flat phantom and a corresponding distance holder.

System Setup

In the simplified setup for system evaluation, the DUT is replaced by a calibrated dipole and the power source is replaced by a continuous wave that comes from a signal generator. The calibrated dipole must be placed beneath the flat phantom section of the SAM twin phantom with the correct distance holder. The distance holder should touch the phantom surface with a light pressure at the reference marking and be oriented parallel to the long side of the phantom. The equipment setup is shown below:

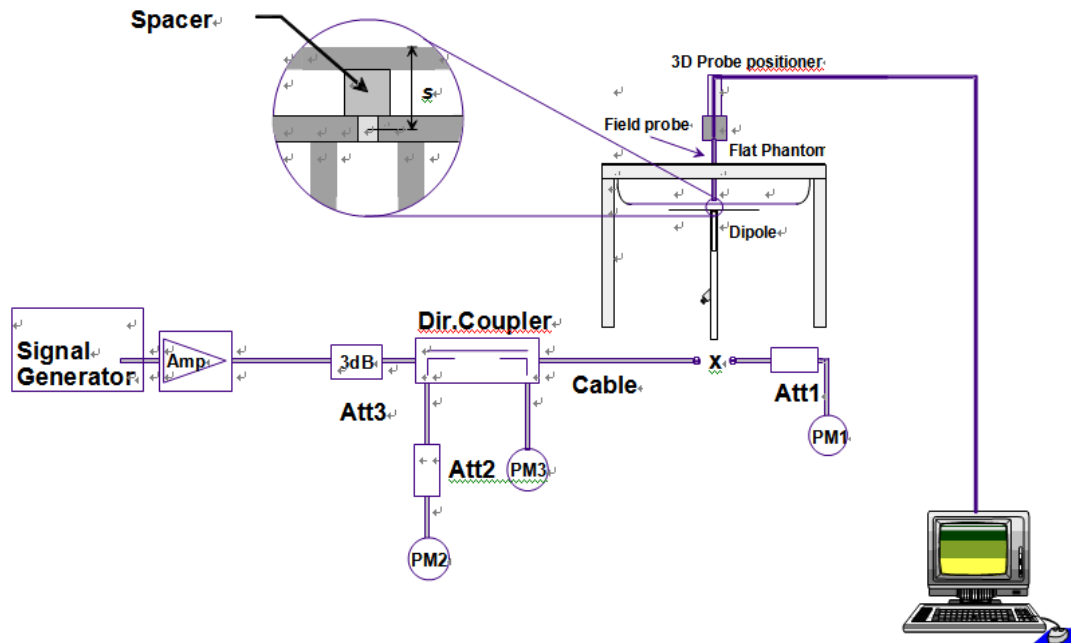

1. Signal Generator
2. Amplifier
3. Directional Coupler
4. Power Meter
5. Calibrated Dipole

Validation Dipoles

The dipoles used is based on the IEEE-1528 standard, and is complied with mechanical and electrical specifications in line with the requirements of both IEEE and FCC Supplement C. the table below provides details for the mechanical and electrical specifications for the dipoles.

*	Frequency	L (mm)	h (mm)	d (mm)
	835MHz	161.0	89.8	3.6
	900MHz	149.0	83.3	3.6
	1800MHz	72.0	41.7	3.6
	1900MHz	68.0	39.5	3.6
v	2450MHz	51.5	30.4	3.6
v	5200MHz	23.6	14.0	3.6
	5600MHz	21.61	18.22	3.6
v	5800MHz	21.6	12.6	3.6

*Note: “V” indicates Frequency used of EUT

The output power on dipole port must be calibrated to 30 dBm (1W) before dipole is connected.

Validation Result



Comparing to the Yearly Calibration SAR value provided by APREL, the validation data should be within its specification of 5 %. Table shows the target SAR and measured SAR after normalized to 1W input power. The table below indicates the system performance check can meet the variation criterion and the plots can be referred to Appendix E of this report.

Frequency [MHz]	Description	SAR [w/kg] 1g	SAR [w/kg] 10g	Tissue Temp. [°C]
2450 MHz	Reference result ± 5% window	55.57 52.79 to 58.38	25.80 24.51 to 27.09	N/A
	26-Sep-2014	53.127	25.066	21.5
	29-Sep-2014	53.122	25.061	21.5

Frequency [MHz]	Description	SAR [w/kg] 1g	SAR [w/kg] 10g	Tissue Temp. [°C]
5200 MHz	Reference result ± 5% window	67.35 63.98 to 70.72	22.23 21.12 to 23.34	N/A
	26-Sep-2014	69.388	22.041	21.5
	29-Sep-2014	69.393	22.058	21.5

Frequency [MHz]	Description	SAR [w/kg] 1g	SAR [w/kg] 10g	Tissue Temp. [°C]
5800 MHz	Reference result ± 5% window	59.32 56.354 to 62.286	20.12 19.114 to 21.126	N/A
	26-Sep-2014	58.436	20.118	21.6
	29-Sep-2014	58.441	20.122	21.6

Note: All SAR values are normalized 1W.

7 DUT Testing Position

Test Positions of Device Relative to Head

This specifies exactly two test positions for the handset against the head phantom, the “cheek” position and the “tilted” position. The handset should be tested in both positions on the left and right sides of the SAM phantom. If the handset construction is such that it cannot be positioned using the handset positioning procedures described in 4.2.2.1 and 4.2.2.2 to represent normal use conditions (e.g., asymmetric handset), alternative alignment procedures should be considered with details provided in the test report.

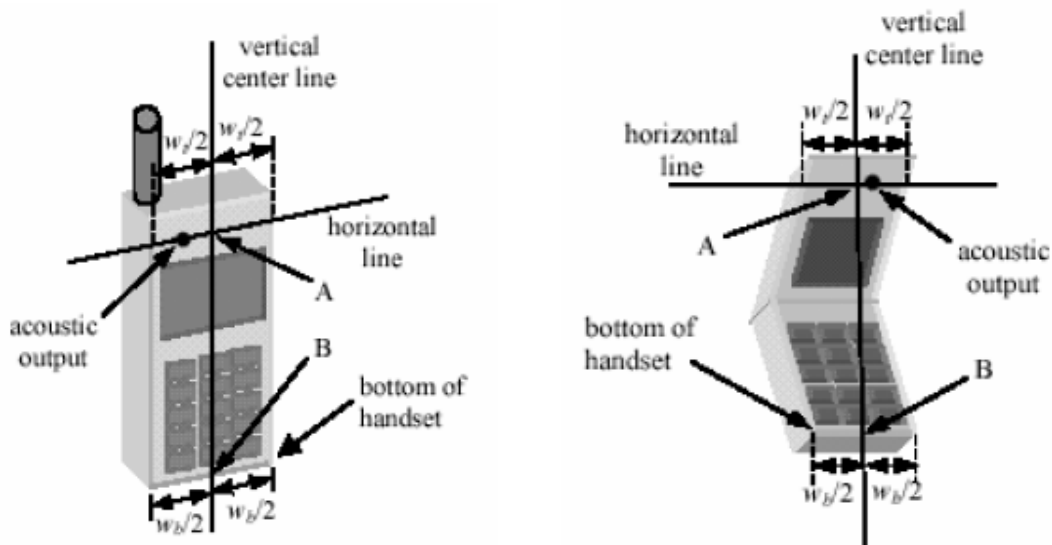

Definition of the “Cheek” Position

The “cheek” position is defined as follows:

- a. Ready the handset for talk operation, if necessary. For example, for handsets with a cover piece, open the cover. (If the handset can also be used with the cover closed both configurations must be tested.)
- b. Define two imaginary lines on the handset: the vertical centerline and the horizontal line. The vertical centerline passes through two points on the front side of the handset: the midpoint of the width w_t of the handset at the level of the acoustic output (point A on Figures 4.1a and 4.1b), and the midpoint of the width w_b of the bottom of the handset (point B). The horizontal line is perpendicular to the vertical centerline and passes through the center of the acoustic output (see Figure 4.1a). The two lines intersect at point A. Note that for many handsets, point A coincides with the center of the acoustic output. However, the acoustic output may be located elsewhere on the horizontal line. Also note that the vertical centerline is not necessarily parallel to the front face of the handset (see Figure 4.1b), especially for clamshell handsets, handsets with flip pieces, and other irregularly-shaped handsets.
- c. Position the handset close to the surface of the phantom such that point A is on the (virtual) extension of the line passing through points RE and LE on the phantom (see Figure 4.2), such that the plane defined by the vertical center line and the horizontal line of the handset is approximately parallel to the sagittal plane of the phantom.

- d. Translate the handset towards the phantom along the line passing through RE and LE until the handset touches the pinna.
- e. While maintaining the handset in this plane, rotate it around the LE-RE line until the vertical centerline is in the plane normal to MB-NF including the line MB (called the reference plane).
- f. Rotate the handset around the vertical centerline until the handset (horizontal line) is symmetrical with respect to the line NF.
- g. While maintaining the vertical centerline in the reference plane, keeping point A on the line passing through RE and LE and maintaining the handset contact with the pinna, rotate the handset about the line NF until any point on the handset is in contact with a phantom point below the pinna (cheek). See Figure 4.2 the physical angles of rotation should be noted.

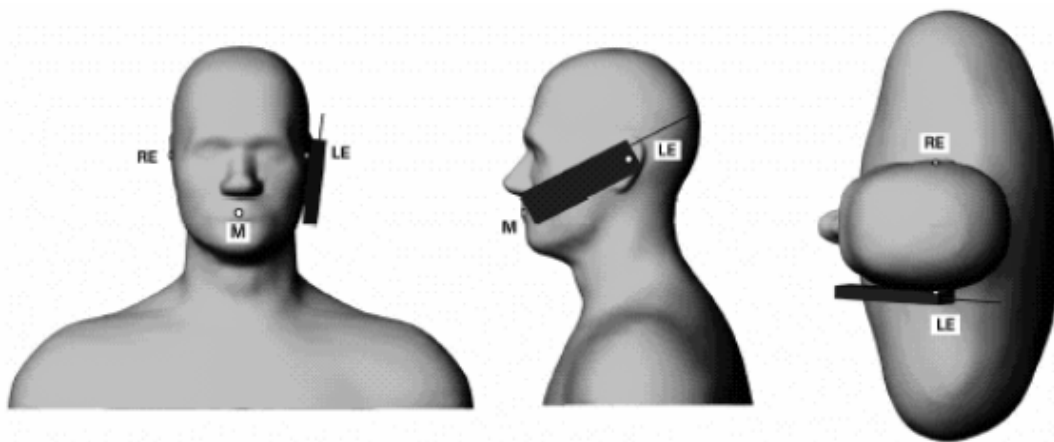

Definition of the “Tilted” Position

The “tilted” position is defined as follows:

- a. Repeat steps (a) – (g) of 4.2.1.1 to place the device in the “cheek position.”
- b. While maintaining the orientation of the handset move the handset away from the pinna along the line passing through RE and LE in order to enable a rotation of the handset by 15 degrees.
- c. Rotate the handset around the horizontal line by 15 degrees.
- d. While maintaining the orientation of the handset, move the handset towards the phantom on a line passing through RE and LE until any part of the handset touches the ear. The tilted position is obtained when the contact is on the pinna. If the contact is at any location other than the pinna (e.g., the antenna with the back of the phantom head), the angle of the handset should be reduced. In this case, the tilted position is obtained if any part of the handset is in contact with the pinna as well as a second part of the handset is contact with the phantom (e.g., the antenna with the back of the head).

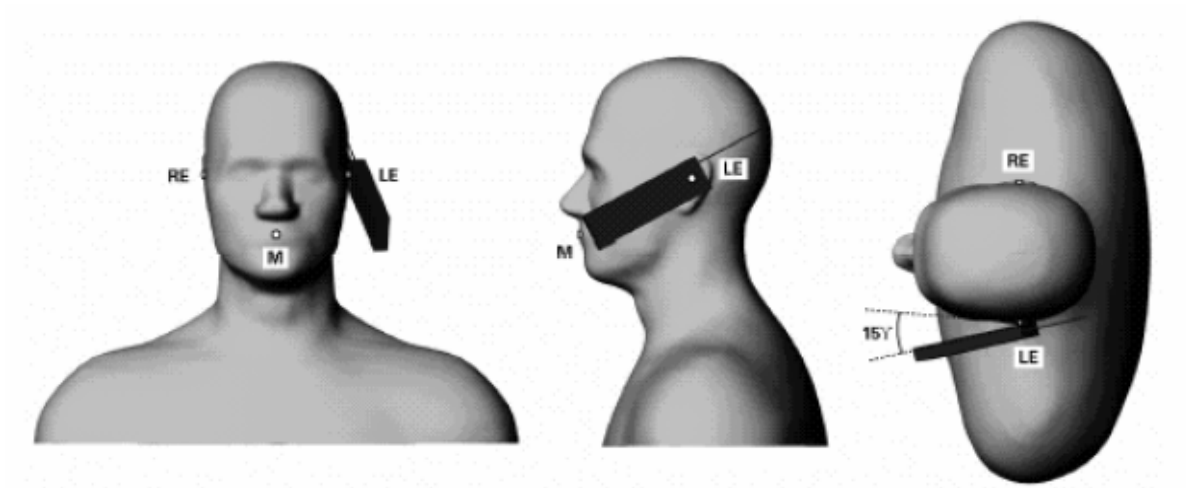

Test Positions for body-worn

Body-worn operating configurations should be tested without the belt-clips and holsters attached to the device and positioned against a flat phantom in normal use configurations. A separation distance of **0** cm between the back of the device and a flat phantom is recommended for testing body-worn SAR compliance under such circumstances. Other separation distance may be use, but not exceed 2.5 cm.

The DUT has only body mode test positions and test mode refer to section 8.2

8 SAR Measurement Procedures

The measurement procedures are as follows:

- (a) through software control to continuous transmit
- (b) Set software to maximum output power and data rate
- (c) Measure output power through RF cable and power meter
- (d) Place the DUT in the positions described in the last section
- (e) Set scan area, grid size and other setting on the APREL software
- (f) Taking data for the maximum power on each testing position
- (g) Find out the largest SAR result on these testing positions of each band
- (h) Measure SAR results for the other channels in worst SAR testing position

According to the test standard, the recommended procedure for assessing the peak spatial-average SAR value consists of the following steps:

- (a) Power reference measurement
- (b) Area scan
- (c) Zoom scan
- (d) Power drift measurement

Spatial Peak SAR Evaluation

The procedure for spatial peak SAR evaluation has been implemented according to the test standard. It can be conducted for 1g and 10g, as well as for user-specific masses. The APREL SAR software includes all numerical procedures necessary to evaluate the spatial peak SAR value.

The base for the evaluation is a "cube" measurement. The measured volume must include the 1g and 10g cubes with the highest averaged SAR values. For that purpose, the center of the measured volume is aligned to the interpolated peak SAR value of a previously performed area scan.

The entire evaluation of the spatial peak values is performed within the post-processing engine (SEMCAD). The system always gives the maximum values for the 1g and 10g cubes. The algorithm to find the cube with highest averaged SAR is divided into the following stages:

- (a) Extraction of the measured data (grid and values) from the Zoom Scan
- (b) Calculation of the SAR value at every measurement point based on all stored data (A/D values and measurement parameters)
- (c) Generation of a high-resolution mesh within the measured volume
- (d) Interpolation of all measured values from the measurement grid to the high-resolution grid
- (e) Extrapolation of the entire 3-D field distribution to the phantom surface over the distance from sensor to surface
- (f) Calculation of the averaged SAR within masses of 1g and 10g

Scan Procedures

First Area Scan is used to locate the approximate location(s) of the local peak SAR value(s). The measurement grid within an Area Scan is defined by the grid extent, grid step size and grid offset. Next, in order to determine the EM field distribution in a three-dimensional spatial extension, Zoom Scan is required. The Zoom Scan measures 5x5x7 points with step size 8, 8 and 5 mm for 300 MHz to 3 GHz. The Zoom Scan is performed around the highest E-field value to determine the averaged SAR-distribution over 10 g.

SAR Averaged Methods

In APREL, the interpolation and extrapolation are both based on the modified Quadratic Shepard's method. The interpolation scheme combines a least-square fitted function method and a weighted average method which are the two basic types of computational interpolation and approximation.

Extrapolation routines are used to obtain SAR values between the lowest measurement points and the inner phantom surface. The extrapolation distance is determined by the surface detection distance and the probe sensor offset. The uncertainty increases with the extrapolation distance. To keep the uncertainty within 1% for the 1 g and 10 g cubes, the extrapolation distance should not be larger than 5 mm.

9 SAR Test Results

9.1 Conducted power table:

BT power measurement

Average Power (unit: dBm)		
	Channel	DH5 power
GFSK	2402	-2.31
	2441	-1.43
	2480	-1.84
Pi/4DQPSK	2402	-2.15
	2441	-1.42
	2480	-1.74
8DPSK	2402	-2.23
	2441	-1.49
	2480	-1.91

Peak Power (unit: dBm)		
	Channel	DH5 power
GFSK	2402	0.62
	2441	2.53
	2480	1.41
Pi/4DQPSK	2402	0.47
	2441	2.25
	2480	1.22
8DPSK	2402	0.65
	2441	2.58
	2480	1.51

BLE

Average Power (unit: dBm)		
	Channel	DH5 power
BT-LE	2402	-4.22
	2440	-2.69
	2480	-4.16

Peak Power (unit: dBm)		
	Channel	DH5 power
BT-LE	2402	-1.71
	2440	-0.44
	2480	-1.72

WIFI 2.4G Band

Average Power (unit: dBm)		
802.11b		1M (dBm)
	1	12.96
	6	12.98
	11	12.97
802.11g		6M (dBm)
	1	12.92
	6	12.94
	11	12.91
802.11n HT20		6.5M (mcs0) (dBm)
	1	12.88
	6	12.91
	11	12.87

Peak Power (unit: dBm)		
802.11b		1M (dBm)
	1	15.59
	6	15.66
	11	15.63
802.11g		6M (dBm)
	1	21.88
	6	21.96
	11	21.84
802.11n HT20		6.5M (mcs0) (dBm)
	1	21.24
	6	21.41
	11	21.36

WIFI 5G Band

Average Power (unit: dBm)		
802.11a		6M
	36	9.96
	40	9.94
	44	9.95
	48	9.98
	149	11.99
	153	11.94
	157	11.93
	161	11.92
	165	11.92
802.11a HT20		mcs0
	36	9.95
	40	9.94
	44	9.94
	48	9.96
	149	11.94
	153	11.92
	157	11.93
	161	11.92
	165	11.94

Peak Power (unit: dBm)		
802.11a		6M
	36	19.47
	40	19.37
	44	19.38
	48	19.54
	149	21.42
	153	21.37
	157	21.19
	161	21.18
	165	21.23
802.11a HT20		mcs0
	36	19.02
	40	18.99
	44	18.91
	48	19.38
	149	20.81
	153	20.61
	157	20.56
	161	20.48
	165	20.43

9.2 Test Records for Body SAR Test

Data No:	Test Mode	Test Position	Separation Distance (cm)	Ch.	Measured Avg Power(dBm)	Tune-up maximum limit(dBm)	Scaling factor	Measured SAR 1g (W/kg)	Scaled SAR 1g (W/kg)
1	802.11b	Bottom	0	6	12.98	13.00	1.00	0.847	0.851
2	802.11a	Bottom	0	149	11.99	12.00	1.00	0.620	0.621
3	802.11b	Edge of Right	0	6	12.98	13.00	1.00	0.057	0.057
4	802.11a	Edge of Right	0	149	11.99	12.00	1.00	0.003	0.003
5	802.11b	Edge of Bottom	0	6	12.98	13.00	1.00	1.401	1.407
6	802.11a	Edge of Bottom	0	149	11.99	12.00	1.00	1.378	1.381
7	802.11b	Edge of Bottom	0	1	12.96	13.00	1.01	1.362	1.375
8	802.11b	Edge of Bottom	0	11	12.97	13.00	1.01	1.398	1.408
9	802.11g	Edge of Bottom	0	6	12.94	13.00	1.01	1.367	1.386
10	802.11n 20	Edge of Bottom	0	6	12.91	13.00	1.02	1.357	1.385
11	EDR2	Edge of Bottom	0	39	-1.41	2.00	2.19	0.001	0.002
12	802.11a	Edge of Bottom	0	36	9.96	10.00	1.01	1.019	1.028
13	802.11a	Edge of Bottom	0	48	9.98	10.00	1.00	1.278	1.284
14	802.11a	Edge of Bottom	0	157	11.93	12.00	1.02	1.295	1.316
15	802.11a	Edge of Bottom	0	165	11.92	12.00	1.02	1.364	1.389
16	802.11an 20	Edge of Bottom	0	36	9.95	10.00	1.01	0.988	0.999
17	802.11an 20	Edge of Bottom	0	48	9.96	10.00	1.01	1.123	1.133

18	802.11an 20	Edge of Bottom	0	149	11.94	12.00	1.01	1.284	1.302
19	802.11an 20	Edge of Bottom	0	157	11.93	12.00	1.02	1.275	1.296
20	802.11an 20	Edge of Bottom	0	165	11.94	12.00	1.01	1.146	1.162

Note:

Scaling factor= Tune-up maximum limit(mW)/ Conducted Power(mW)

Scaled SAR=Measure SAR*Scaling factor

e.g. Data No. 01:

Measured Avg Power(dBm) = 12.98 dBm =19.86mW

Tune-up maximum limit(dBm) =13.0 dBm =19.95 mW

Scaling factor =19.95.1mW/19.86mW = 1.004616

Measured SAR 1g(W/kg)= 0.847

Scaled SAR 1g(W/kg) = 0.847 *1.004616 = 0.851

Remark:

1. According KDB248227 page 4, it's not required for 802.11g less than 1/4dB higher than 802.11b Refer to section 8.1 for power measurement data.

Result: 802.11 g mode is not required.

2. According KDB248227 page 6, When the extrapolated maximum peak SAR for the maximum output channel is <1.6 W/kg and the 1-g averaged SAR is <0.8 W/kg testing of other channels in the "default test channels" or "required test channels" configuration is optional. and according KDB447498 D01 4.3.3 Testing of other required channels within the operating mode of a frequency band is not required when the reported 1-g or 10-g SAR for the mid-band or highest output power channel is ≤ 0.8 W/kg or 2.0 W/kg, for 1-g or 10-g respectively, when the transmission band is ≤ 100 MHz.

Result: 1g-SAR value of 802.11a/an is <0.8W/kg , testing only performed at maximum power channel for 5GHz band.

3 According KDB248227 page 5/6 When multiple channel BW configurations are applicable, the highest channel BW configuration with the highest output power limit should be tested. Testing of lower BW configurations is not required. for 802.11n 20MHz and 40MHz.

Result: 20MHz bandwidth is not required.

4. According KDB447498 D01 Appendix A, SAR evaluation is not required, the max output power VS separation distance of human body to antenna:

Result: Some positions are not required for SAR testing as below table.

Main antenna evaluation					
Position	Bottom	edge of top	edge of left	edge of right	edge of bottom
Main antenna distance	5mm	194mm	220mm	14mm	5mm
threshold power level for 2.4GHz	10mW	1496mW	1496mW	19mW	10mW
test maximum power for 2.4GHz	19.86mW				
Max. power (EIRP)for 2.4GHz	36.06mW				
threshold power level for 5GHz	6mW	1462mW	1462mW	12mW	6mW
test maximum power 5GHz	15.81mW				
Max. power (EIRP)for 5GHz	19.28mW				
SAR measured requirement	TEST	NA	NA	TEST	TEST

	Antenna Gain (dBi)	max Power (dBm)	EIRP Power (dBm)	EIRP Power (mW)		Antenna Gain (dBi)	max Power (dBm)	EIRP Power (dBm)	EIRP Power (mW)
2.4G(Main)	2.59	12.98	15.57	36.06	5G(Main)	0.86	11.99	12.85	19.28

Antenna Location

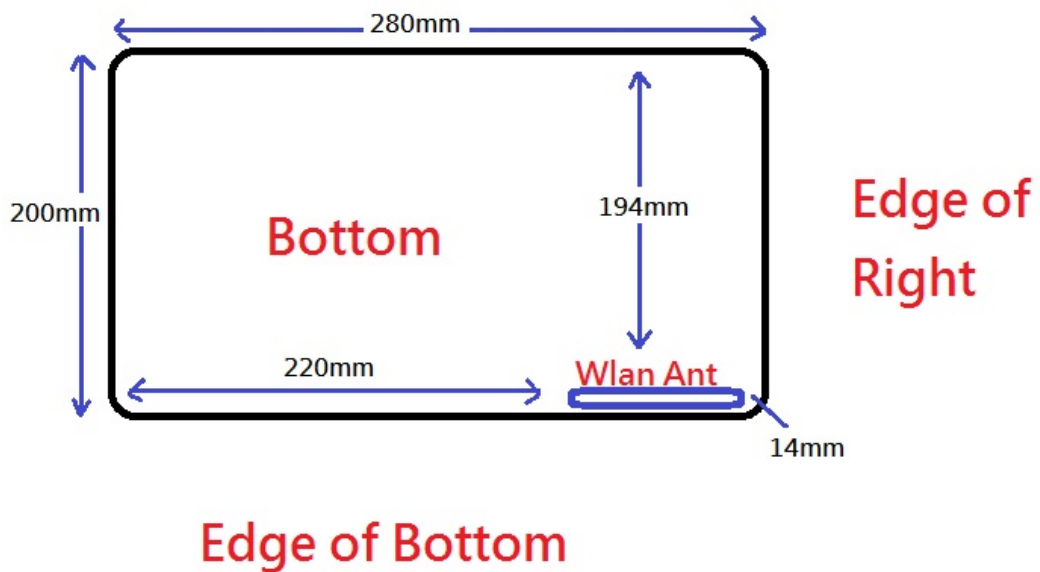

10 Exposure Assessment Measurement Uncertainty

2.4GHz

Source of Uncertainty	Tolerance Value	Probability Distribution	Divisor	c_i^{-1} (1-g)	c_i^{-1} (10-g)	Standard Uncertainty (1-g) %	Standard Uncertainty (10-g) %
Measurement System							
Probe Calibration	3.5	normal	1	1	1	3.5	3.5
Axial Isotropy	3.7	rectangular	$\sqrt{3}$	$(1-cp)^{1/2}$	$(1-cp)^{1/2}$	1.5	1.5
Hemispherical Isotropy	10.9	rectangular	$\sqrt{3}$	\sqrt{cp}	\sqrt{cp}	4.4	4.4
Boundary Effect	1.0	rectangular	$\sqrt{3}$	1	1	0.6	0.6
Linearity	4.7	rectangular	$\sqrt{3}$	1	1	2.7	2.7
Detection Limit	1.0	rectangular	$\sqrt{3}$	1	1	0.6	0.6
Readout Electronics	1.0	normal	1	1	1	1.0	1.0
Response Time	0.8	rectangular	$\sqrt{3}$	1	1	0.5	0.5
Integration Time	1.7	rectangular	$\sqrt{3}$	1	1	1.0	1.0
RF Ambient Condition	3.0	rectangular	$\sqrt{3}$	1	1	1.7	1.7
Probe Positioner Mech.	0.4	rectangular	$\sqrt{3}$	1	1	0.2	0.2
Probe Positioning with respect to Phantom Shell	2.9	rectangular	$\sqrt{3}$	1	1	1.7	1.7
Extrapolation and Integration	3.7	rectangular	$\sqrt{3}$	1	1	2.1	2.1
Test Sample Positioning	4.0	normal	1	1	1	4.0	4.0
Device Holder Uncertainty	2.0	normal	1	1	1	2.0	2.0
Drift of Output Power	1.2	rectangular	$\sqrt{3}$	1	1	0.7	0.7
Phantom Uncertainty(shape & thickness tolerance)	3.4	rectangular	$\sqrt{3}$	1	1	2.0	2.0
Liquid Conductivity(target)	5.0	rectangular	$\sqrt{3}$	0.7	0.5	2.0	1.4
Liquid Conductivity(meas.)	2.9	normal	1	0.7	0.5	2.0	1.4
Liquid Permittivity(target)	5.0	rectangular	$\sqrt{3}$	0.6	0.5	1.7	1.4
Liquid Permittivity(meas.)	3.3	normal	1	0.6	0.5	2.0	1.6
Combined Uncertainty		RSS				9.7	9.3
Combined Uncertainty (coverage factor=2)		Normal(k=2)				19.4	18.7

5GHz

Source of Uncertainty	Tolerance Value	Probability Distribution	Divisor	ci1 (1-g)	ci1 (10-g)	Standard Uncertainty (1-g) %	Standard Uncertainty (10-g) %
Measurement System							
Probe Calibration	3.5	normal	1	1	1	3.5	3.5
Axial Isotropy	3.7	rectangular	$\sqrt{3}$	$(1-cp)1/2$	$(1-cp)1/2$	1.5	1.5
Hemispherical Isotropy	10.9	rectangular	$\sqrt{3}$	\sqrt{cp}	\sqrt{cp}	4.4	4.4
Boundary Effect	1.0	rectangular	$\sqrt{3}$	1	1	0.6	0.6
Linearity	4.7	rectangular	$\sqrt{3}$	1	1	2.7	2.7
Detection Limit	1.0	rectangular	$\sqrt{3}$	1	1	0.6	0.6
Readout Electronics	1.0	normal	1	1	1	1.0	1.0
Response Time	0.8	rectangular	$\sqrt{3}$	1	1	0.5	0.5
Integration Time	1.7	rectangular	$\sqrt{3}$	1	1	1.0	1.0
RF Ambient Condition	3.0	rectangular	$\sqrt{3}$	1	1	1.7	1.7
Probe Positioner Mech.	0.4	rectangular	$\sqrt{3}$	1	1	0.2	0.2
Probe Positioning with respect to Phantom Shell	2.9	rectangular	$\sqrt{3}$	1	1	1.7	1.7
Extrapolation and Integration	3.7	rectangular	$\sqrt{3}$	1	1	2.1	2.1
Test Sample Positioning	4.0	normal	1	1	1	4.0	4.0
Device Holder Uncertainty	2.0	normal	1	1	1	2.0	2.0
Drift of Output Power	0.6	rectangular	$\sqrt{3}$	1	1	0.3	0.3
Phantom Uncertainty(shape & thickness tolerance)	3.4	rectangular	$\sqrt{3}$	1	1	2.0	2.0
Liquid Conductivity(target)	5.0	rectangular	$\sqrt{3}$	0.7	0.5	2.0	1.4
Liquid Conductivity(meas.)	2.6	normal	1	0.7	0.5	1.8	1.3
Liquid Permittivity(target)	5.0	rectangular	$\sqrt{3}$	0.6	0.5	1.7	1.4
Liquid Permittivity(meas.)	9.8	normal	1	0.6	0.5	5.9	4.9
Combined Uncertainty		RSS				11.1	10.4
Combined Uncertainty (coverage factor=2)		Normal(k=2)				22.2	20.8

Appendix A Test Setup Photos

Tissue altitude

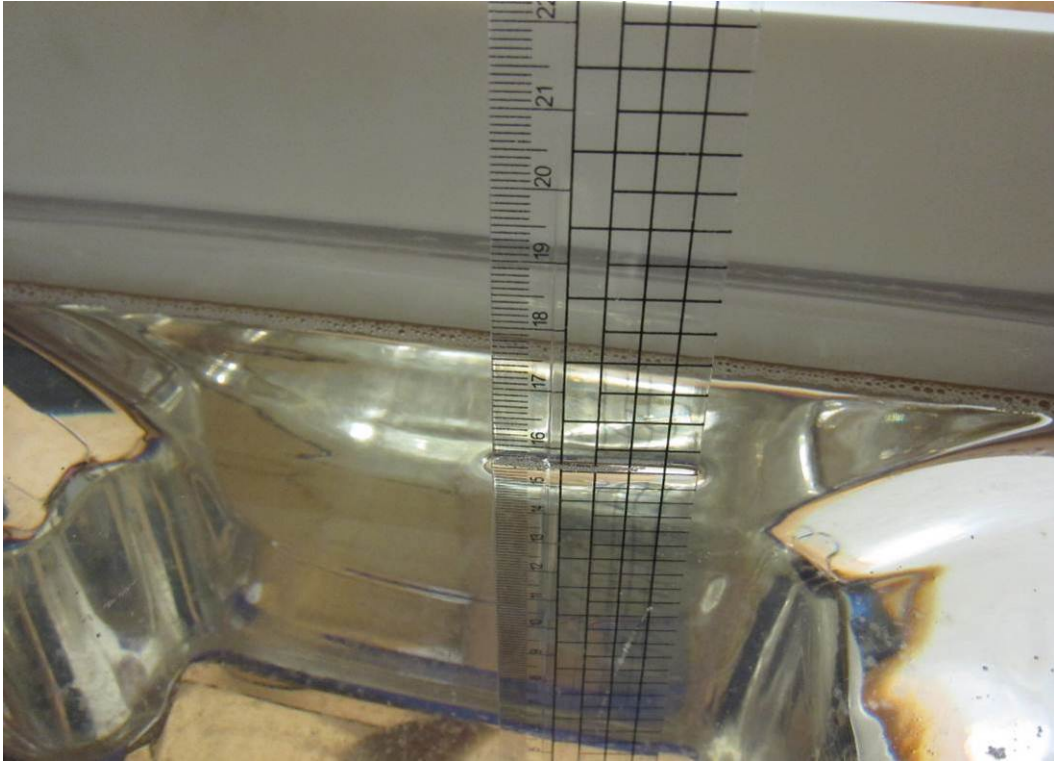

Bottom



Edge of Bottom



Edge of Right



Appendix B DUT Photos

Refer to FCC Part15.247 report.

Appendix C: System Performance Check

Refer to Appendix C

Appendix D: SAR Measurement Data

Refer to Appendix D

Appendix E: Probe Calibration Certificate

Refer to Appendix E

Appendix F: Dipole Calibration Certificate

Refer to Appendix F

~ end of Report ~

Appendix C: System Performance Check

Report Date : 26-Sep-2014
By Operator : Dino Chen
DUT : Dipole
Frequency : 2450.00 MHz
Max. Transmit Pwr : 1 W

APREL ALSAS-10U System Description

Phantom Data

Name : Universal Phantom
Type : ALS-P-UP-1

Tissue Data

Type : Body
Frequency : 2450.00 MHz

Probe Data

Name : E-field Probe
Model : ALS-E-020
Serial No. : 500-00283
Last Calib. Date : 19-Mar-2014

Measurement Data

Crest Factor : 1
Scan Type : Complete
Tissue Temp. : 21.50 °C
Ambient Temp. : 21.50 °C
Area Scan : 9x9x1 : Measurement x=10mm, y=10mm, z=4mm
Zoom Scan : 5x5x8 : Measurement x=8mm, y=8mm, z=4mm
Separation : 1cm



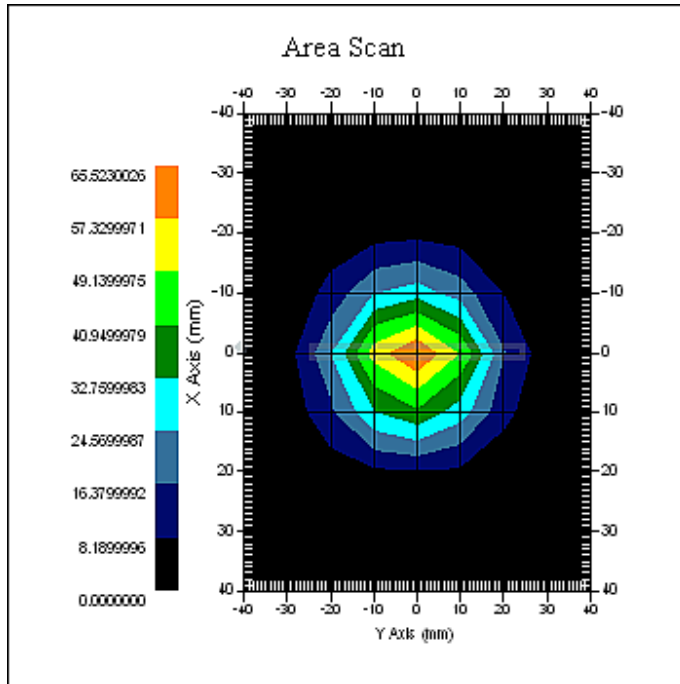

1 gram SAR value : 53.127 W/kg
10 gram SAR value : 25.066 W/kg
Area Scan Peak SAR : 65.352 W/kg
Zoom Scan Peak SAR : 104.014 W/kg

Appendix C: System Performance Check

Report Date : 26-Sep-2014
By Operator : Dino Chen
DUT : Dipole
Frequency : 5200.00 MHz
Max. Transmit Pwr : 1 W

APREL ALSAS-10U System Description

Phantom Data

Name : Universal Phantom
Type : ALS-P-UP-1

Tissue Data

Type : Body
Frequency : 5200.00 MHz

Probe Data

Name : E-field Probe
Model : ALS-E-020
Serial No. : 500-00283
Last Calib. Date : 08-Oct-2013

Measurement Data

Crest Factor : 1
Scan Type : Complete
Tissue Temp. : 21.500 °C
Ambient Temp. : 21.50 °C
Area Scan : 9x9x1 : Measurement x=10mm, y=10mm, z=4mm
Zoom Scan : 5x5x8 : Measurement x=8mm, y=8mm, z=4mm
Separation : 1cm



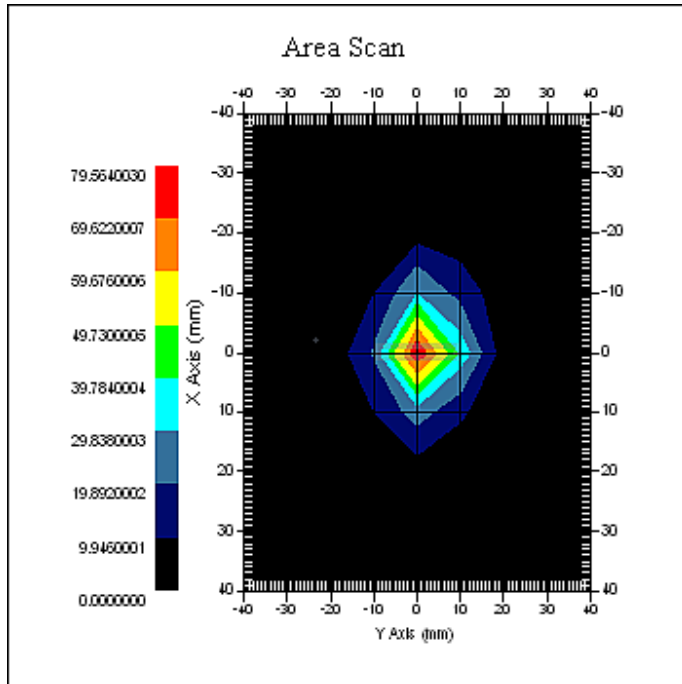

1 gram SAR value : 69.388 W/kg
10 gram SAR value : 22.041 W/kg
Area Scan Peak SAR : 79.439 W/kg
Zoom Scan Peak SAR : 188.627 W/kg

Appendix C: System Performance Check

Report Date :26-Sep-2014
By Operator : Dino Chen
DUT : Dipole
Frequency : 5800.00 MHz
Max. Transmit Pwr : 1 W

APREL ALSAS-10U System Description

Phantom Data

Name : Universal Phantom
Type : ALS-P-UP-1

Tissue Data

Type : Body
Frequency : 5800.00 MHz

Probe Data

Name : E-field Probe
Model : ALS-E-020
Serial No. : 500-00283
Last Calib. Date : 08-Oct-2013

Measurement Data

Crest Factor : 1
Scan Type : Complete
Tissue Temp. : 21.60 °C
Ambient Temp. : 21.60 °C
Area Scan : 9x9x1 : Measurement x=10mm, y=10mm, z=4mm
Zoom Scan : 5x5x8 : Measurement x=8mm, y=8mm, z=4mm
Separation : 1cm



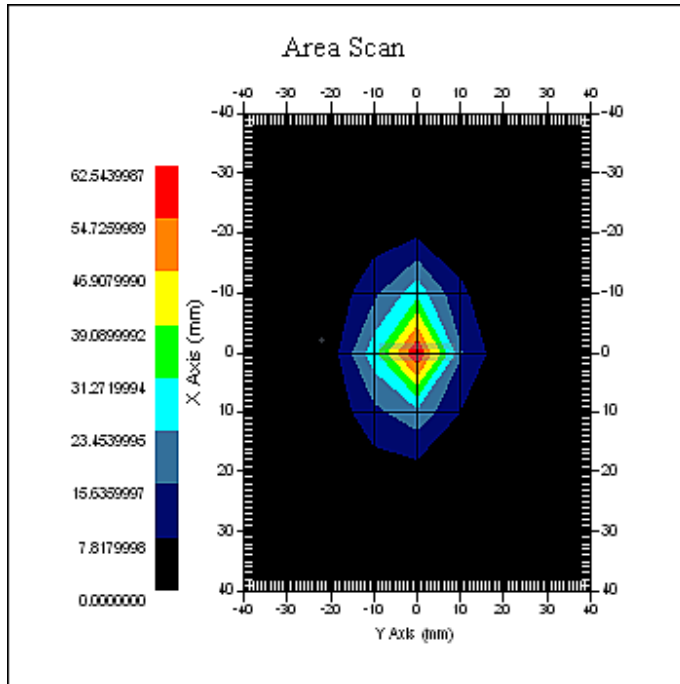

1 gram SAR value : 58.436 W/kg
10 gram SAR value : 20.118 W/kg
Area Scan Peak SAR : 62.663 W/kg
Zoom Scan Peak SAR : 162.051 W/kg

Appendix D: SAR Measurement Data

Data No.	Band	Mode	Test Position	Separation Distance (cm)	Channel	SAR 1g(W/kg)
1	Wifi	802.11b	Bottom	0	6	0.847
2	Wifi	802.11a	Bottom	0	149	0.620
3	Wifi	802.11b	Edge of Right	0	6	0.057
4	Wifi	802.11a	Edge of Right	0	149	0.003
5	Wifi	802.11b	Edge of Bottom	0	6	1.401
6	Wifi	802.11a	Edge of Bottom	0	149	1.378
7	Wifi	802.11b	Edge of Bottom	0	1	1.362
8	Wifi	802.11b	Edge of Bottom	0	11	1.398
9	Wifi	802.11g	Edge of Bottom	0	6	1.367
10	Wifi	802.11n 20	Edge of Bottom	0	6	1.357
11	BT	EDR2	Edge of Bottom	0	39	0.001
12	Wifi	802.11a	Edge of Bottom	0	36	1.019
13	Wifi	802.11a	Edge of Bottom	0	48	1.278
14	Wifi	802.11a	Edge of Bottom	0	157	1.295
15	Wifi	802.11a	Edge of Bottom	0	165	1.364
16	Wifi	802.11an 20	Edge of Bottom	0	36	0.988
17	Wifi	802.11an 20	Edge of Bottom	0	48	1.123
18	Wifi	802.11an 20	Edge of Bottom	0	149	1.284
19	Wifi	802.11an 20	Edge of Bottom	0	157	1.275
20	Wifi	802.11an 20	Edge of Bottom	0	165	1.146

Data No. 1:

Report Date : 29-Sep-2014
By Operator : 123
Measurement Date : 29-Sep-2014
Starting Time : 29-Sep-2014 04:18:29 PM
End Time : 29-Sep-2014 04:38:22 PM
Scanning Time : 1193 secs
Product Data
Device Name : 14LR223
Serial No. : NA
Type : Other
Model : Big
Frequency : 2450.00 MHz
Max. Transmit Pwr : 0.25 W
Drift Time : 1 min(s)
Length : 103 mm
Width : 89 mm
Depth : 22 mm
Antenna Type : Internal
Orientation : Touch
Power Drift-Start : 0.241 W/kg
Power Drift-Finish: 0.246 W/kg
Power Drift (%) : 2.128
Picture : C:\alsas\bitmap\Device-18.bmp

Phantom Data
Name : APREL-Uni
Type : Uni-Phantom
Size (mm) : 280 x 280 x 200
Serial No. : User Define
Location : Center
Description : Uni-Phantom

Tissue Data
Type : BODY
Serial No. : 2450B
Frequency : 2450.00 MHz
Last Calib. Date : 23-Sep-2014
Temperature : 21.50 °C
Ambient Temp. : 21.50 °C
Humidity : 62.00 RH%
Epsilon (Dielectric Constant) : 53.43
Sigma : 1.91 S/m
Density : 1000.00 kg/cu. m

Probe Data

Name : E-field
Model : E-020
Type : E-Field Triangle
Serial No. : 500-00283
Last Calib. Date : 08-Oct-2014
Frequency : 2450.00 MHz
Duty Cycle Factor (CreF) : 1
Conversion Factor : 4.3
Probe Sensitivity : 1.20 1.20 1.20 $\mu\text{V}/(\text{V}/\text{m})^2$
Compression Point : 9.50 mV
Offset : 1.56 mm

Measurement Data

Crest Factor : 1
Scan Type : Complete
Tissue Temp. : 21.50 °C
Ambient Temp. : 21.50 °C
Set-up Date : 29-Sep-2014
Set-up Time : 11:06:11 AM
Area Scan : 9x7x1 : Measurement x=10mm, y=10mm, z=4mm
Zoom Scan : 5x5x8 : Measurement x=8mm, y=8mm, z=4mm

Other Data

DUT Position : Touch
Separation : 0
Channel : Mid

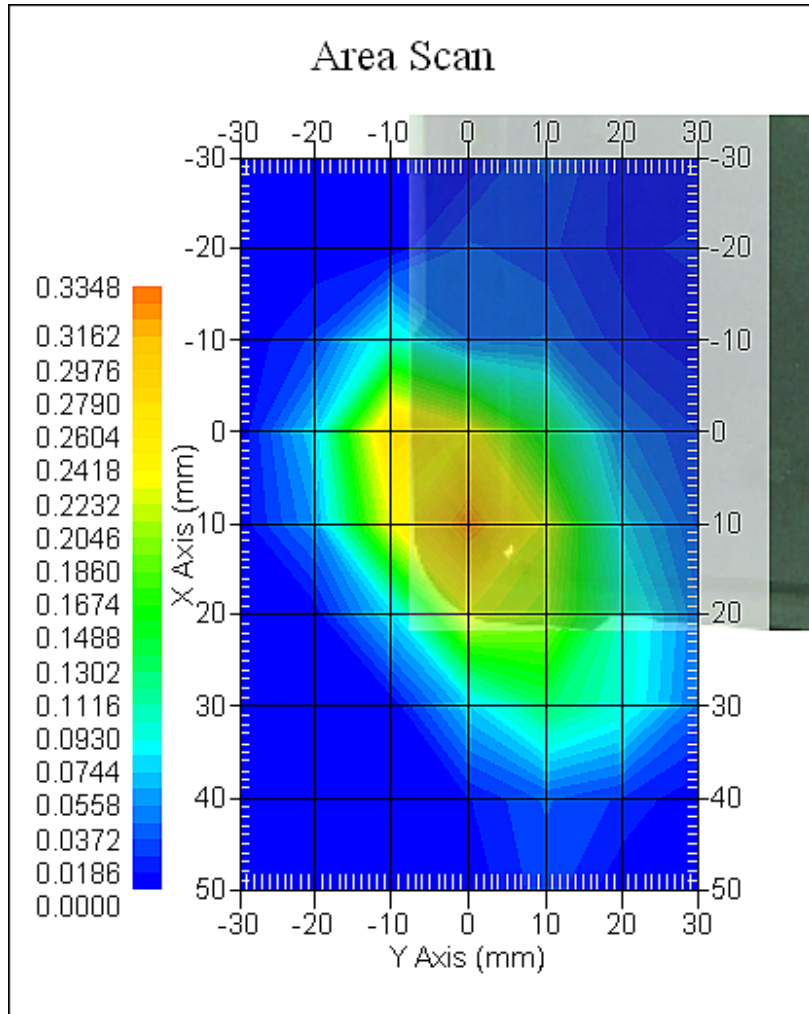

The system detected 1 maxima.
Selected highest maxima # = 1.
Maxima #1 coordinates: X = 10.110, Y = 0.000
1 gram SAR value : 0.281 W/kg
10 gram SAR value : 0.110 W/kg
Area Scan Peak SAR : 0.331 W/kg
Zoom Scan Peak SAR : 0.640 W/kg

Maxima Summary:

Maxima #1
Maxima coordinates: X = 10.110, Y = 0.000
1 gram SAR value : 0.281 W/kg
10 gram SAR value : 0.110 W/kg
Area Scan Peak SAR : 0.331 W/kg
Zoom Scan Peak SAR : 0.640 W/kg

Data No. 2:

Report Date : 29-Sep-2014
By Operator : 123
Measurement Date : 29-Sep-2014
Starting Time : 29-Sep-2014 05:30:32 PM
End Time : 29-Sep-2014 06:07:08 PM
Scanning Time : 2196 secs
Product Data
Device Name : 14LR223
Serial No. : NA
Type : Other
Model : Big
Frequency : 5800.00 MHz
Max. Transmit Pwr : 0.25 W
Drift Time : 1 min(s)
Length : 103 mm
Width : 89 mm
Depth : 22 mm
Antenna Type : Internal
Orientation : Touch
Power Drift-Start : 0.001 W/kg
Power Drift-Finish: 0.000 W/kg
Power Drift (%) : 0.000
Picture : C:\alsas\bitmap\Device-16.bmp

Phantom Data
Name : APREL-Uni
Type : Uni-Phantom
Size (mm) : 280 x 280 x 200
Serial No. : User Define
Location : Center
Description : Uni-Phantom

Tissue Data
Type : BODY
Serial No. : 5800B
Frequency : 5800.00 MHz
Last Calib. Date : 24-Sep-2014
Temperature : 21.60 °C
Ambient Temp. : 21.60 °C
Humidity : 58.00 RH%
Epsilon (Dielectric Constant) : 44.19
Sigma : 6.23 S/m
Density : 1000.00 kg/cu. m

Probe Data

Name : E-field
Model : E-020
Type : E-Field Triangle
Serial No. : 500-00283
Last Calib. Date : 08-Oct-2014
Frequency : 5800.00 MHz
Duty Cycle Factor (CreF) : 1
Conversion Factor : 2.5
Probe Sensitivity : 1.20 1.20 1.20 $\mu\text{V}/(\text{V}/\text{m})^2$
Compression Point : 95.00 mV
Offset : 1.56 mm

Measurement Data

Crest Factor : 1
Scan Type : Complete
Tissue Temp. : 21.60 °C
Ambient Temp. : 21.60 °C
Set-up Date : 29-Sep-2014
Set-up Time : 7:51:39 AM
Area Scan : 9x7x1 : Measurement x=10mm, y=10mm, z=4mm
Zoom Scan : 9x9x7 : Measurement x=4mm, y=4mm, z=5mm

Other Data

DUT Position : Touch
Separation : 0
Channel : Low

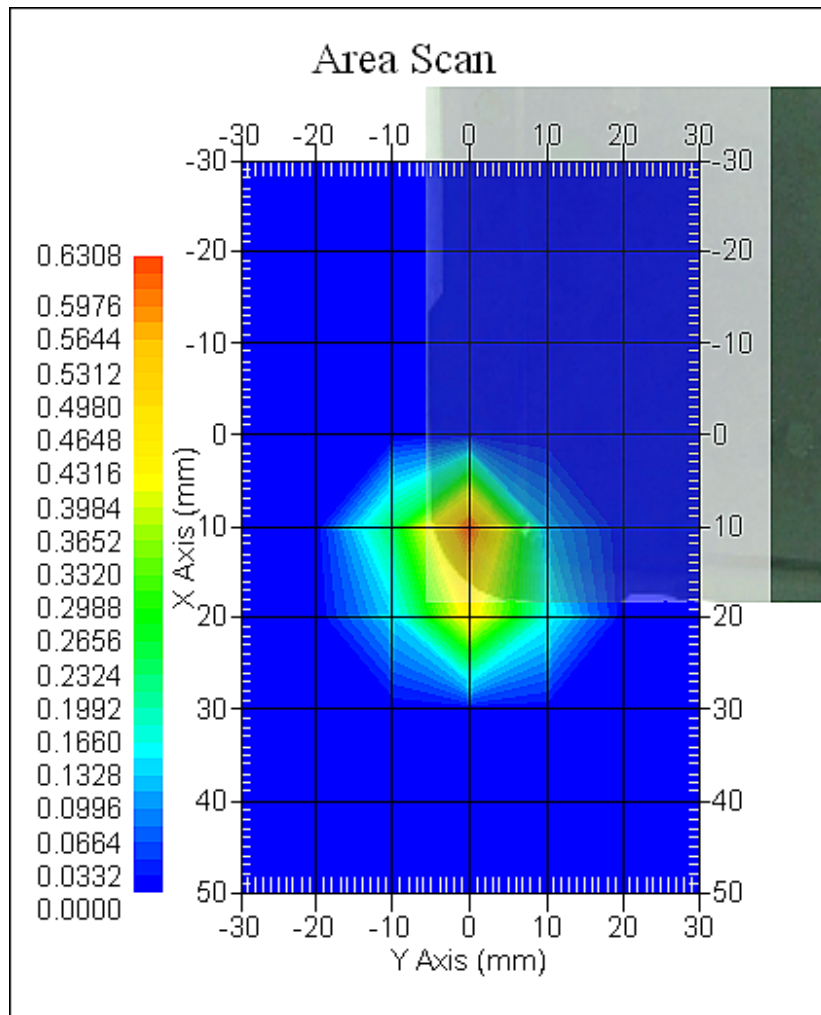

The system detected 1 maxima.
 Selected highest maxima # = 1.
 Maxima #1 coordinates: X = 14.080, Y = 0.000
 1 gram SAR value : 0.620 W/kg
 10 gram SAR value : 0.159 W/kg
 Area Scan Peak SAR : 0.624 W/kg
 Zoom Scan Peak SAR : 1.941 W/kg

Maxima Summary:

Maxima #1

Maxima coordinates: X = 14.080, Y = 0.000

1 gram SAR value : 0.620 W/kg

10 gram SAR value : 0.159 W/kg

Area Scan Peak SAR : 0.624 W/kg

Zoom Scan Peak SAR : 1.941 W/kg

Data No. 3:

Report Date : 29-Sep-2014
By Operator : 123
Measurement Date : 29-Sep-2014
Starting Time : 29-Sep-2014 03:56:35 PM
End Time : 29-Sep-2014 04:11:37 PM
Scanning Time : 902 secs
Product Data
Device Name : 14LR223
Serial No. : NA
Type : Other
Model : Big
Frequency : 2450.00 MHz
Max. Transmit Pwr : 0.25 W
Drift Time : 1 min(s)
Length : 89 mm
Width : 22 mm
Depth : 103 mm
Antenna Type : Internal
Orientation : Touch
Power Drift-Start : 0.064 W/kg
Power Drift-Finish: 0.068 W/kg
Power Drift (%) : 5.964
Picture : C:\alsas\bitmap\Device-16.bmp

Phantom Data
Name : APREL-Uni
Type : Uni-Phantom
Size (mm) : 280 x 280 x 200
Serial No. : User Define
Location : Center
Description : Uni-Phantom

Tissue Data
Type : BODY
Serial No. : 2450B
Frequency : 2450.00 MHz
Last Calib. Date : 23-Sep-2014
Temperature : 21.50 °C
Ambient Temp. : 21.50 °C
Humidity : 62.00 RH%
Epsilon (Dielectric Constant) : 53.43
Sigma : 1.91 S/m
Density : 1000.00 kg/cu. m

Probe Data

Name : E-field
Model : E-020
Type : E-Field Triangle
Serial No. : 500-00283
Last Calib. Date : 08-Oct-2014
Frequency : 2450.00 MHz
Duty Cycle Factor (CreF) : 1
Conversion Factor : 4.3
Probe Sensitivity : 1.20 1.20 1.20 $\mu\text{V}/(\text{V}/\text{m})^2$
Compression Point : 9.50 mV
Offset : 1.56 mm

Measurement Data

Crest Factor : 1
Scan Type : Complete
Tissue Temp. : 21.50 °C
Ambient Temp. : 21.50 °C
Set-up Date : 29-Sep-2014
Set-up Time : 11:06:11 AM
Area Scan : 7x5x1 : Measurement x=10mm, y=10mm, z=4mm
Zoom Scan : 5x5x8 : Measurement x=8mm, y=8mm, z=4mm

Other Data

DUT Position : Touch
Separation : 0
Channel : Mid

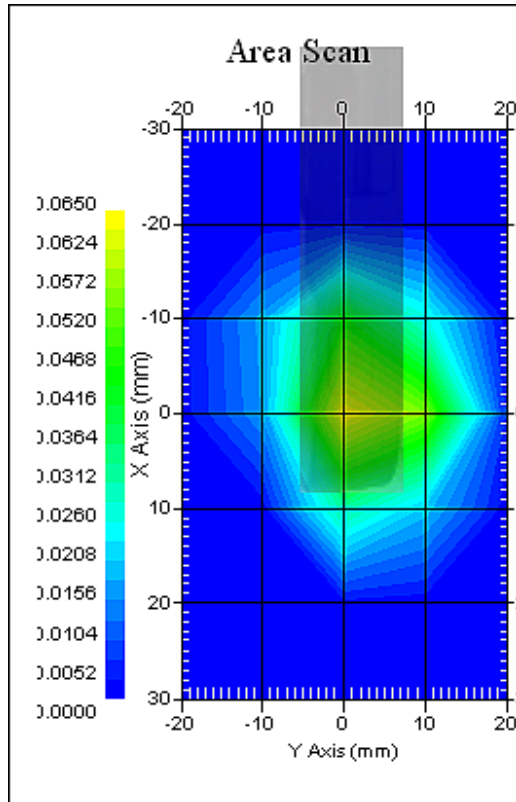

The system detected 1 maxima.
Selected highest maxima # = 1.
Maxima #1 coordinates: X = 0.040, Y = 0.000
1 gram SAR value : 0.057 W/kg
10 gram SAR value : 0.020 W/kg
Area Scan Peak SAR : 0.065 W/kg
Zoom Scan Peak SAR : 0.140 W/kg

Maxima Summary:
Maxima #1
Maxima coordinates: X = 0.040, Y = 0.000
1 gram SAR value : 0.057 W/kg
10 gram SAR value : 0.020 W/kg
Area Scan Peak SAR : 0.065 W/kg
Zoom Scan Peak SAR : 0.140 W/kg

Data No. 4:

Report Date : 29-Sep-2014
By Operator : 123
Measurement Date : 29-Sep-2014
Starting Time : 29-Sep-2014 02:57:30 PM
End Time : 29-Sep-2014 03:27:40 PM
Scanning Time : 1810 secs
Product Data
Device Name : 14LR223
Serial No. : NA
Type : Other
Model : Big
Frequency : 5800.00 MHz
Max. Transmit Pwr : 0.25 W
Drift Time : 1 min(s)
Length : 89 mm
Width : 22 mm
Depth : 103 mm
Antenna Type : Internal
Orientation : Touch
Power Drift-Start : 0.001 W/kg
Power Drift-Finish: 0.000 W/kg
Power Drift (%) : 0.000
Picture : C:\alsas\bitmap\Device-16.bmp

Phantom Data
Name : APREL-Uni
Type : Uni-Phantom
Size (mm) : 280 x 280 x 200
Serial No. : User Define
Location : Center
Description : Uni-Phantom

Tissue Data
Type : BODY
Serial No. : 5800B
Frequency : 5800.00 MHz
Last Calib. Date : 24-Sep-2014
Temperature : 21.60 °C
Ambient Temp. : 21.60 °C
Humidity : 58.00 RH%
Epsilon (Dielectric Constant) : 44.19
Sigma : 6.23 S/m
Density : 1000.00 kg/cu. m



Probe Data

Name : E-field
Model : E-020
Type : E-Field Triangle
Serial No. : 500-00283
Last Calib. Date : 08-Oct-2014
Frequency : 5800.00 MHz
Duty Cycle Factor (CreF) : 1
Conversion Factor : 2.5
Probe Sensitivity : 1.20 1.20 1.20 $\mu\text{V}/(\text{V}/\text{m})^2$
Compression Point : 95.00 mV
Offset : 1.56 mm

Measurement Data

Crest Factor : 1
Scan Type : Complete
Tissue Temp. : 21.60 °C
Ambient Temp. : 21.60 °C
Set-up Date : 29-Sep-2014
Set-up Time : 7:51:39 AM
Area Scan : 5x5x1 : Measurement x=10mm, y=10mm, z=4mm
Zoom Scan : 9x9x7 : Measurement x=4mm, y=4mm, z=5mm

Other Data

DUT Position : Touch
Separation : 0
Channel : Low

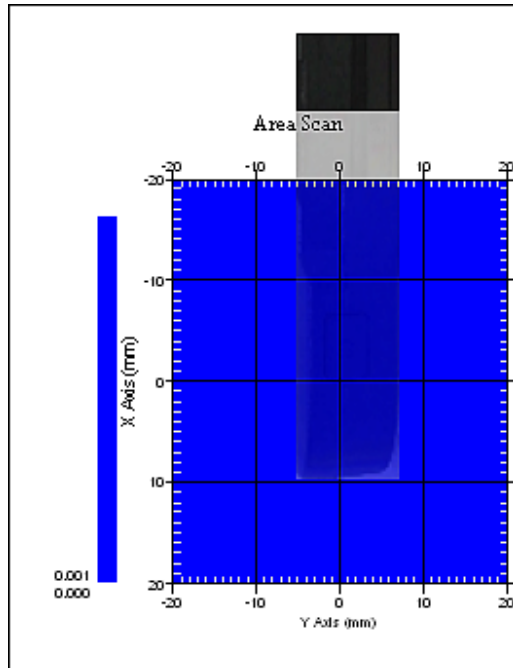

The system detected 1 maxima.
Selected highest maxima # = 1.
Maxima #1 coordinates: X = 7.090, Y = 14.900
1 gram SAR value : 0.003 W/kg
10 gram SAR value : 0.001 W/kg
Area Scan Peak SAR : 0.001 W/kg
Zoom Scan Peak SAR : 0.040 W/kg

Maxima Summary:

Maxima #1

Maxima coordinates: X = 7.090, Y = 14.900

1 gram SAR value : 0.003 W/kg

10 gram SAR value : 0.001 W/kg

Area Scan Peak SAR : 0.001 W/kg

Zoom Scan Peak SAR : 0.040 W/kg

Data No. 5:

Report Date : 26-Sep-2014
By Operator : 123
Measurement Date : 26-Sep-2014
Starting Time : 26-Sep-2014 06:01:13 AM
End Time : 26-Sep-2014 06:16:25 AM
Scanning Time : 912 secs
Product Data
Device Name : 14LR223
Serial No. : NA
Type : Other
Model : Big
Frequency : 2450.00 MHz
Max. Transmit Pwr : 0.25 W
Drift Time : 1 min(s)
Length : 89 mm
Width : 22 mm
Depth : 103 mm
Antenna Type : Internal
Orientation : Touch
Power Drift-Start : 1.699 W/kg
Power Drift-Finish: 1.699 W/kg
Power Drift (%) : -0.013
Picture : C:\alsas\bitmap\Device-16.bmp

Phantom Data
Name : APREL-Uni
Type : Uni-Phantom
Size (mm) : 280 x 280 x 200
Serial No. : User Define
Location : Center
Description : Uni-Phantom

Tissue Data
Type : BODY
Serial No. : 2450B
Frequency : 2450.00 MHz
Last Calib. Date : 23-Sep-2014
Temperature : 21.50 °C
Ambient Temp. : 21.50 °C
Humidity : 62.00 RH%
Epsilon (Dielectric Constant) : 53.43
Sigma : 1.91 S/m
Density : 1000.00 kg/cu. m

Probe Data

Name : E-field
Model : E-020
Type : E-Field Triangle
Serial No. : 500-00283
Last Calib. Date : 08-Oct-2014
Frequency : 2450.00 MHz
Duty Cycle Factor (CreF) : 1
Conversion Factor : 4.3
Probe Sensitivity : 1.20 1.20 1.20 $\mu\text{V}/(\text{V}/\text{m})^2$
Compression Point : 9.50 mV
Offset : 1.56 mm

Measurement Data

Crest Factor : 1
Scan Type : Complete
Tissue Temp. : 21.50 °C
Ambient Temp. : 21.50 °C
Set-up Date : 26-Sep-2014
Set-up Time : 11:06:11 AM
Area Scan : 7x5x1 : Measurement x=10mm, y=10mm, z=4mm
Zoom Scan : 5x5x8 : Measurement x=8mm, y=8mm, z=4mm

Other Data

DUT Position : Touch
Separation : 0
Channel : Mid

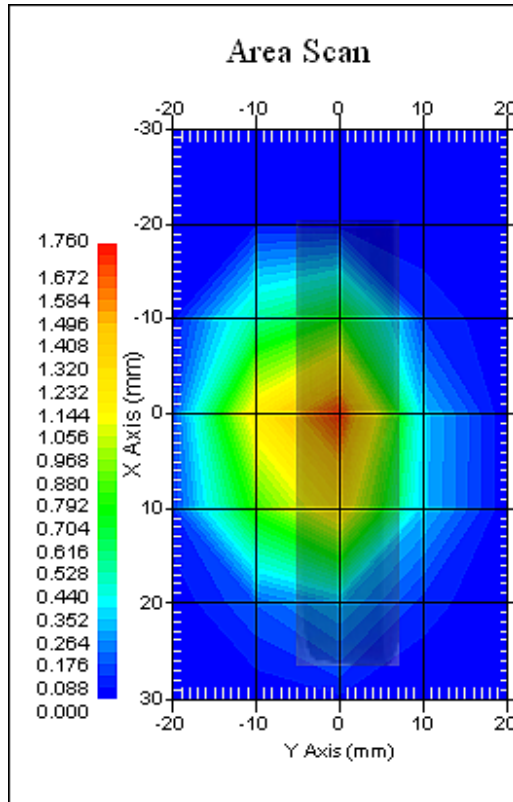

The system detected 1 maxima.
Selected highest maxima # = 1.
Maxima #1 coordinates: X = 0.110, Y = 0.000
1 gram SAR value : 1.401 W/kg
10 gram SAR value : 0.517 W/kg
Area Scan Peak SAR : 1.717 W/kg
Zoom Scan Peak SAR : 3.452 W/kg

Maxima Summary:
Maxima #1
Maxima coordinates: X = 0.110, Y = 0.000
1 gram SAR value : 1.401 W/kg
10 gram SAR value : 0.517 W/kg
Area Scan Peak SAR : 1.717 W/kg
Zoom Scan Peak SAR : 3.452 W/kg

Data No. 6:

Report Date : 26-Sep-2014
By Operator : 123
Measurement Date : 26-Sep-2014
Starting Time : 26-Sep-2014 11:56:09 AM
End Time : 26-Sep-2014 12:28:02 PM
Scanning Time : 1913 secs
Product Data
Device Name : 14LR223
Serial No. : NA
Type : Other
Model : Big
Frequency : 5800.00 MHz
Max. Transmit Pwr : 0.25 W
Drift Time : 1 min(s)
Length : 89 mm
Width : 22 mm
Depth : 103 mm
Antenna Type : Internal
Orientation : Touch
Power Drift-Start : 1.609 W/kg
Power Drift-Finish: 1.473 W/kg
Power Drift (%) : -8.484
Picture : C:\alsas\bitmap\Device-16.bmp

Phantom Data
Name : APREL-Uni
Type : Uni-Phantom
Size (mm) : 280 x 280 x 200
Serial No. : User Define
Location : Center
Description : Uni-Phantom

Tissue Data
Type : BODY
Serial No. : 5800B
Frequency : 5800.00 MHz
Last Calib. Date : 26-Sep-2014
Temperature : 21.60 °C
Ambient Temp. : 21.60 °C
Humidity : 58.00 RH%
Epsilon (Dielectric Constant) : 44.18
Sigma : 6.23 S/m
Density : 1000.00 kg/cu. m



Probe Data

Name : E-field
Model : E-020
Type : E-Field Triangle
Serial No. : 500-00283
Last Calib. Date : 08-Oct-2014
Frequency : 5800.00 MHz
Duty Cycle Factor (CreF) : 1
Conversion Factor : 2.5
Probe Sensitivity : 1.20 1.20 1.20 $\mu\text{V}/(\text{V}/\text{m})^2$
Compression Point : 95.00 mV
Offset : 1.56 mm

Measurement Data

Crest Factor : 1
Scan Type : Complete
Tissue Temp. : 21.60 °C
Ambient Temp. : 21.60 °C
Set-up Date : 26-Sep-2014
Set-up Time : 11:19:30 AM
Area Scan : 7x5x1 : Measurement x=10mm, y=10mm, z=4mm
Zoom Scan : 9x9x7 : Measurement x=4mm, y=4mm, z=5mm

Other Data

DUT Position : Touch
Separation : 0
Channel : Low

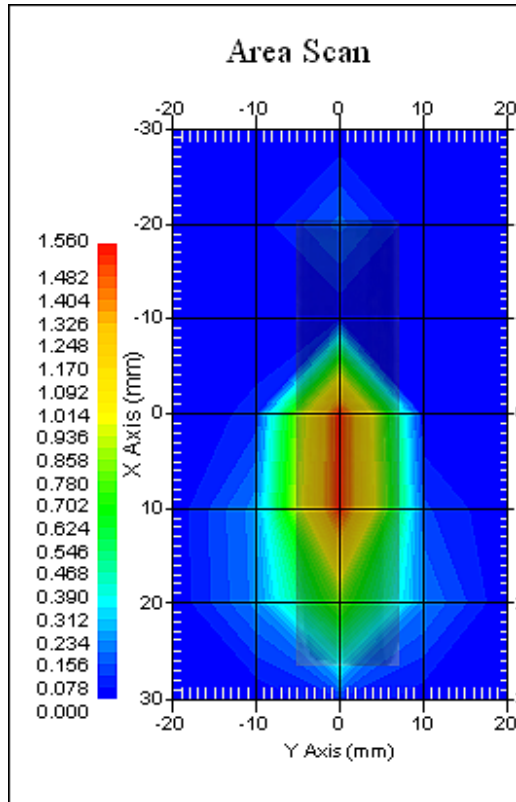

The system detected 1 maxima.
Selected highest maxima # = 1.
Maxima #1 coordinates: X = 12.110, Y = 0.000
1 gram SAR value : 1.378 W/kg
10 gram SAR value : 0.391 W/kg
Area Scan Peak SAR : 1.535 W/kg
Zoom Scan Peak SAR : 4.643 W/kg

Maxima Summary:

Maxima #1

Maxima coordinates: X = 12.110, Y = 0.000

1 gram SAR value : 1.378 W/kg

10 gram SAR value : 0.391 W/kg

Area Scan Peak SAR : 1.535 W/kg

Zoom Scan Peak SAR : 4.643 W/kg

Data No. 7:

Report Date : 26-Sep-2014
By Operator : 123
Measurement Date : 26-Sep-2014
Starting Time : 26-Sep-2014 05:38:12 AM
End Time : 26-Sep-2014 05:53:18 AM
Scanning Time : 906 secs
Product Data
Device Name : 14LR223
Serial No. : NA
Type : Other
Model : Big
Frequency : 2450.00 MHz
Max. Transmit Pwr : 0.25 W
Drift Time : 1 min(s)
Length : 89 mm
Width : 22 mm
Depth : 103 mm
Antenna Type : Internal
Orientation : Touch
Power Drift-Start : 1.733 W/kg
Power Drift-Finish: 1.670 W/kg
Power Drift (%) : -3.600
Picture : C:\alsas\bitmap\Device-16.bmp

Phantom Data
Name : APREL-Uni
Type : Uni-Phantom
Size (mm) : 280 x 280 x 200
Serial No. : User Define
Location : Center
Description : Uni-Phantom

Tissue Data
Type : BODY
Serial No. : 2450B
Frequency : 2450.00 MHz
Last Calib. Date : 26-Sep-2014
Temperature : 21.50 °C
Ambient Temp. : 21.50 °C
Humidity : 62.00 RH%
Epsilon (Dielectric Constant) : 53.41
Sigma : 1.91 S/m
Density : 1000.00 kg/cu. m



Probe Data

Name : E-field
Model : E-020
Type : E-Field Triangle
Serial No. : 500-00283
Last Calib. Date : 08-Oct-2014
Frequency : 2450.00 MHz
Duty Cycle Factor (CreF) : 1
Conversion Factor : 4.3
Probe Sensitivity : 1.20 1.20 1.20 $\mu\text{V}/(\text{V}/\text{m})^2$
Compression Point : 9.50 mV
Offset : 1.56 mm

Measurement Data

Crest Factor : 1
Scan Type : Complete
Tissue Temp. : 21.50 °C
Ambient Temp. : 21.50 °C
Set-up Date : 26-Sep-2014
Set-up Time : 11:06:11 AM
Area Scan : 7x5x1 : Measurement x=10mm, y=10mm, z=4mm
Zoom Scan : 5x5x8 : Measurement x=8mm, y=8mm, z=4mm

Other Data

DUT Position : Touch
Separation : 0
Channel : Low

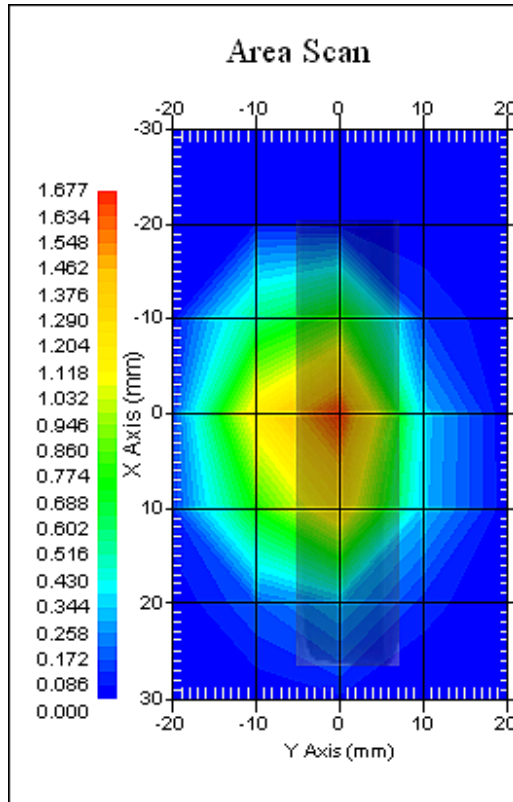

The system detected 1 maxima.
Selected highest maxima # = 1.
Maxima #1 coordinates: X = 0.060, Y = 0.000
1 gram SAR value : 1.362 W/kg
10 gram SAR value : 0.503 W/kg
Area Scan Peak SAR : 1.673 W/kg
Zoom Scan Peak SAR : 3.322 W/kg

Maxima Summary:
Maxima #1
Maxima coordinates: X = 0.060, Y = 0.000
1 gram SAR value : 1.362 W/kg
10 gram SAR value : 0.503 W/kg
Area Scan Peak SAR : 1.673 W/kg
Zoom Scan Peak SAR : 3.322 W/kg

Data No. 8:

Report Date : 26-Sep-2014
By Operator : 123
Measurement Date : 26-Sep-2014
Starting Time : 26-Sep-2014 06:17:43 AM
End Time : 26-Sep-2014 06:32:48 AM
Scanning Time : 905 secs
Product Data
Device Name : 14LR223
Serial No. : NA
Type : Other
Model : Big
Frequency : 2450.00 MHz
Max. Transmit Pwr : 0.25 W
Drift Time : 1 min(s)
Length : 89 mm
Width : 22 mm
Depth : 103 mm
Antenna Type : Internal
Orientation : Touch
Power Drift-Start : 1.774 W/kg
Power Drift-Finish: 1.734 W/kg
Power Drift (%) : -2.207
Picture : C:\alsas\bitmap\Device-16.bmp

Phantom Data
Name : APREL-Uni
Type : Uni-Phantom
Size (mm) : 280 x 280 x 200
Serial No. : User Define
Location : Center
Description : Uni-Phantom

Tissue Data
Type : BODY
Serial No. : 2450B
Frequency : 2450.00 MHz
Last Calib. Date : 26-Sep-2014
Temperature : 21.50 °C
Ambient Temp. : 21.50 °C
Humidity : 62.00 RH%
Epsilon (Dielectric Constant) : 53.41
Sigma : 1.91 S/m
Density : 1000.00 kg/cu. m

Probe Data

Name : E-field
Model : E-020
Type : E-Field Triangle
Serial No. : 500-00283
Last Calib. Date : 08-Oct-2014
Frequency : 2450.00 MHz
Duty Cycle Factor (CreF) : 1
Conversion Factor : 4.3
Probe Sensitivity : 1.20 1.20 1.20 $\mu\text{V}/(\text{V}/\text{m})^2$
Compression Point : 9.50 mV
Offset : 1.56 mm

Measurement Data

Crest Factor : 1
Scan Type : Complete
Tissue Temp. : 21.50 °C
Ambient Temp. : 21.50 °C
Set-up Date : 26-Sep-2014
Set-up Time : 11:06:11 AM
Area Scan : 7x5x1 : Measurement x=10mm, y=10mm, z=4mm
Zoom Scan : 5x5x8 : Measurement x=8mm, y=8mm, z=4mm

Other Data

DUT Position : Touch
Separation : 0
Channel : High

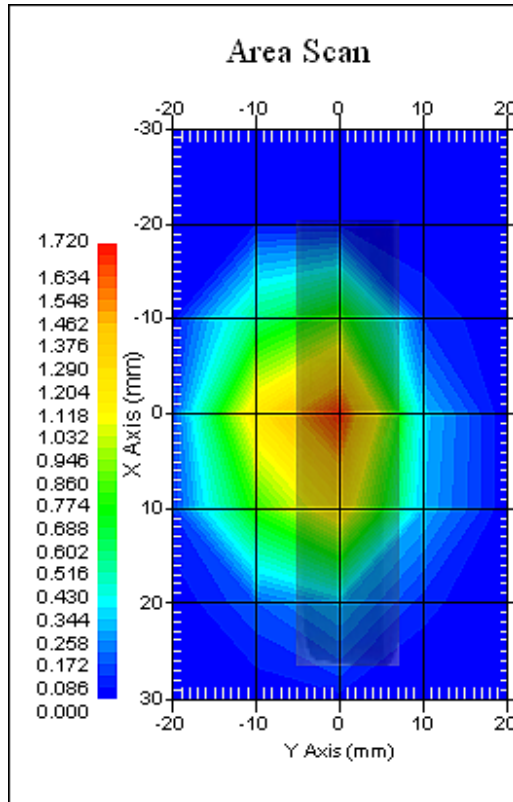

The system detected 1 maxima.
Selected highest maxima # = 1.
Maxima #1 coordinates: X = 0.100, Y = 0.000
1 gram SAR value : 1.398 W/kg
10 gram SAR value : 0.515 W/kg
Area Scan Peak SAR : 1.701 W/kg
Zoom Scan Peak SAR : 3.442 W/kg

Maxima Summary:
Maxima #1
Maxima coordinates: X = 0.100, Y = 0.000
1 gram SAR value : 1.398 W/kg
10 gram SAR value : 0.515 W/kg
Area Scan Peak SAR : 1.701 W/kg
Zoom Scan Peak SAR : 3.442 W/kg

Data No. 9:

Report Date : 26-Sep-2014
By Operator : 123
Measurement Date : 26-Sep-2014
Starting Time : 26-Sep-2014 08:35:16 AM
End Time : 26-Sep-2014 08:50:23 AM
Scanning Time : 907 secs
Product Data
Device Name : 14LR223
Serial No. : NA
Type : Other
Model : Big
Frequency : 2450.00 MHz
Max. Transmit Pwr : 0.25 W
Drift Time : 1 min(s)
Length : 89 mm
Width : 22 mm
Depth : 103 mm
Antenna Type : Internal
Orientation : Touch
Power Drift-Start : 1.671 W/kg
Power Drift-Finish: 1.544 W/kg
Power Drift (%) : -7.600
Picture : C:\alsas\bitmap\Device-16.bmp

Phantom Data
Name : APREL-Uni
Type : Uni-Phantom
Size (mm) : 280 x 280 x 200
Serial No. : User Define
Location : Center
Description : Uni-Phantom

Tissue Data
Type : BODY
Serial No. : 2450B
Frequency : 2450.00 MHz
Last Calib. Date : 26-Sep-2014
Temperature : 21.50 °C
Ambient Temp. : 21.50 °C
Humidity : 62.00 RH%
Epsilon (Dielectric Constant) : 53.41
Sigma : 1.91 S/m
Density : 1000.00 kg/cu. m



Probe Data

Name : E-field
Model : E-020
Type : E-Field Triangle
Serial No. : 500-00283
Last Calib. Date : 08-Oct-2014
Frequency : 2450.00 MHz
Duty Cycle Factor (CreF) : 1
Conversion Factor : 4.3
Probe Sensitivity : 1.20 1.20 1.20 $\mu\text{V}/(\text{V}/\text{m})^2$
Compression Point : 9.50 mV
Offset : 1.56 mm

Measurement Data

Crest Factor : 1
Scan Type : Complete
Tissue Temp. : 21.50 °C
Ambient Temp. : 21.50 °C
Set-up Date : 26-Sep-2014
Set-up Time : 11:06:11 AM
Area Scan : 7x5x1 : Measurement x=10mm, y=10mm, z=4mm
Zoom Scan : 5x5x8 : Measurement x=8mm, y=8mm, z=4mm

Other Data

DUT Position : Touch
Separation : 0
Channel : Mid

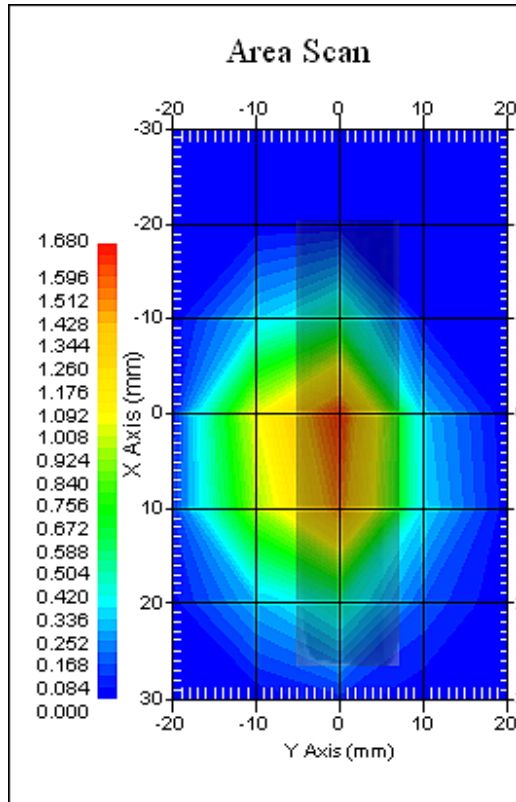

The system detected 1 maxima.
Selected highest maxima # = 1.
Maxima #1 coordinates: X = 8.060, Y = 0.000
1 gram SAR value : 1.367 W/kg
10 gram SAR value : 0.476 W/kg
Area Scan Peak SAR : 1.643 W/kg
Zoom Scan Peak SAR : 3.442 W/kg

Maxima Summary:
Maxima #1
Maxima coordinates: X = 8.060, Y = 0.000
1 gram SAR value : 1.367 W/kg
10 gram SAR value : 0.476 W/kg
Area Scan Peak SAR : 1.643 W/kg
Zoom Scan Peak SAR : 3.442 W/kg

Data No. 10:

Report Date : 26-Sep-2014
By Operator : 123
Measurement Date : 26-Sep-2014
Starting Time : 26-Sep-2014 08:54:06 AM
End Time : 26-Sep-2014 09:09:08 AM
Scanning Time : 902 secs
Product Data
Device Name : 14LR223
Serial No. : NA
Type : Other
Model : Big
Frequency : 2450.00 MHz
Max. Transmit Pwr : 0.25 W
Drift Time : 1 min(s)
Length : 89 mm
Width : 22 mm
Depth : 103 mm
Antenna Type : Internal
Orientation : Touch
Power Drift-Start : 1.609 W/kg
Power Drift-Finish: 1.608 W/kg
Power Drift (%) : -0.043
Picture : C:\alsas\bitmap\Device-16.bmp

Phantom Data
Name : APREL-Uni
Type : Uni-Phantom
Size (mm) : 280 x 280 x 200
Serial No. : User Define
Location : Center
Description : Uni-Phantom

Tissue Data
Type : BODY
Serial No. : 2450B
Frequency : 2450.00 MHz
Last Calib. Date : 26-Sep-2014
Temperature : 21.50 °C
Ambient Temp. : 21.50 °C
Humidity : 62.00 RH%
Epsilon (Dielectric Constant) : 53.41
Sigma : 1.91 S/m
Density : 1000.00 kg/cu. m



Probe Data

Name : E-field
Model : E-020
Type : E-Field Triangle
Serial No. : 500-00283
Last Calib. Date : 08-Oct-2014
Frequency : 2450.00 MHz
Duty Cycle Factor (CreF) : 1
Conversion Factor : 4.3
Probe Sensitivity : 1.20 1.20 1.20 $\mu\text{V}/(\text{V}/\text{m})^2$
Compression Point : 9.50 mV
Offset : 1.56 mm

Measurement Data

Crest Factor : 1
Scan Type : Complete
Tissue Temp. : 21.50 °C
Ambient Temp. : 21.50 °C
Set-up Date : 26-Sep-2014
Set-up Time : 11:06:11 AM
Area Scan : 7x5x1 : Measurement x=10mm, y=10mm, z=4mm
Zoom Scan : 5x5x8 : Measurement x=8mm, y=8mm, z=4mm

Other Data

DUT Position : Touch
Separation : 0
Channel : Mid

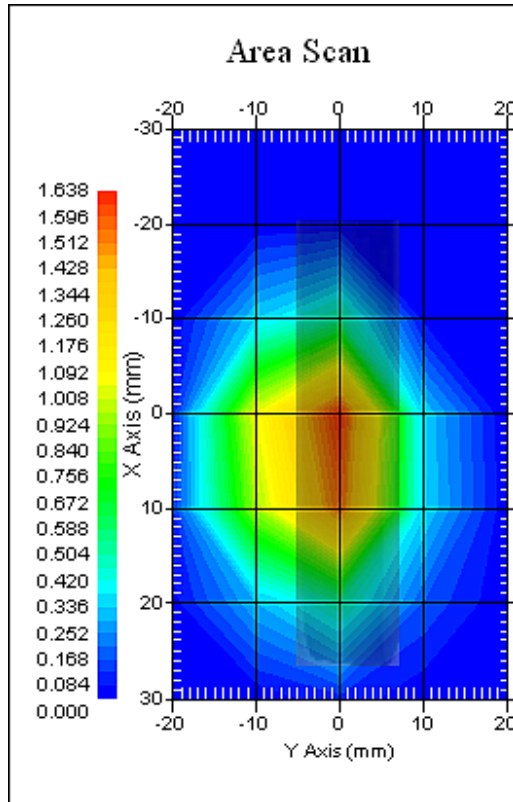

The system detected 1 maxima.
Selected highest maxima # = 1.
Maxima #1 coordinates: X = 8.110, Y = 0.000
1 gram SAR value : 1.357 W/kg
10 gram SAR value : 0.474 W/kg
Area Scan Peak SAR : 1.637 W/kg
Zoom Scan Peak SAR : 3.422 W/kg

Maxima Summary:
Maxima #1
Maxima coordinates: X = 8.110, Y = 0.000
1 gram SAR value : 1.357 W/kg
10 gram SAR value : 0.474 W/kg
Area Scan Peak SAR : 1.637 W/kg
Zoom Scan Peak SAR : 3.422 W/kg

Data No. 11:

Report Date : 26-Sep-2014
By Operator : 123
Measurement Date : 26-Sep-2014
Starting Time : 26-Sep-2014 06:54:43 AM
End Time : 26-Sep-2014 07:10:06 AM
Scanning Time : 923 secs
Product Data
Device Name : 14LR223
Serial No. : NA
Type : Other
Model : Big
Frequency : 2450.00 MHz
Max. Transmit Pwr : 0.25 W
Drift Time : 1 min(s)
Length : 89 mm
Width : 22 mm
Depth : 103 mm
Antenna Type : Internal
Orientation : Touch
Power Drift-Start : 0.001 W/kg
Power Drift-Finish: 0.000 W/kg
Power Drift (%) : 0.000
Picture : C:\alsas\bitmap\Device-16.bmp

Phantom Data
Name : APREL-Uni
Type : Uni-Phantom
Size (mm) : 280 x 280 x 200
Serial No. : User Define
Location : Center
Description : Uni-Phantom

Tissue Data
Type : BODY
Serial No. : 2450B
Frequency : 2450.00 MHz
Last Calib. Date : 26-Sep-2014
Temperature : 21.50 °C
Ambient Temp. : 21.50 °C
Humidity : 62.00 RH%
Epsilon (Dielectric Constant) : 53.41
Sigma : 1.91 S/m
Density : 1000.00 kg/cu. m



Probe Data

Name : E-field
Model : E-020
Type : E-Field Triangle
Serial No. : 500-00283
Last Calib. Date : 08-Oct-2014
Frequency : 2450.00 MHz
Duty Cycle Factor (CreF) : 1
Conversion Factor : 4.3
Probe Sensitivity : 1.20 1.20 1.20 $\mu\text{V}/(\text{V}/\text{m})^2$
Compression Point : 9.50 mV
Offset : 1.56 mm

Measurement Data

Crest Factor : 1
Scan Type : Complete
Tissue Temp. : 21.50 °C
Ambient Temp. : 21.50 °C
Set-up Date : 26-Sep-2014
Set-up Time : 11:06:11 AM
Area Scan : 7x5x1 : Measurement x=10mm, y=10mm, z=4mm
Zoom Scan : 5x5x8 : Measurement x=8mm, y=8mm, z=4mm

Other Data

DUT Position : Touch
Separation : 0
Channel : Mid

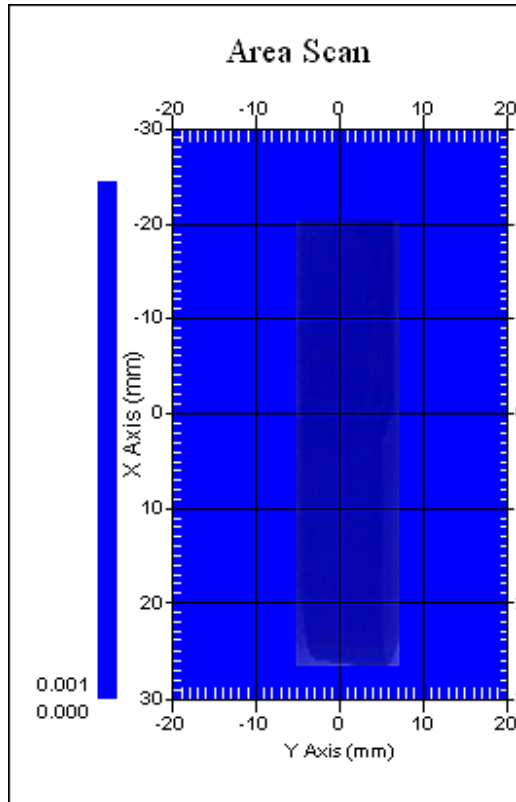

The system detected 1 maxima.
Selected highest maxima # = 1.
Maxima #1 coordinates: X = 13.140, Y = 2.900
1 gram SAR value : 0.001 W/kg
10 gram SAR value : 0.001 W/kg
Area Scan Peak SAR : 0.001 W/kg
Zoom Scan Peak SAR : 0.000 W/kg

Maxima Summary:

Maxima #1

Maxima coordinates: X = 13.140, Y = 2.900

1 gram SAR value : 0.001 W/kg

10 gram SAR value : 0.001 W/kg

Area Scan Peak SAR : 0.001 W/kg

Zoom Scan Peak SAR : 0.000 W/kg

Data No. 12:

Report Date : 29-Sep-2014
By Operator : 123
Measurement Date : 29-Sep-2014
Starting Time : 29-Sep-2014 12:53:41 PM
End Time : 29-Sep-2014 01:25:33 PM
Scanning Time : 1912 secs
Product Data
Device Name : 14LR223
Serial No. : NA
Type : Other
Model : Big
Frequency : 5200.00 MHz
Max. Transmit Pwr : 0.25 W
Drift Time : 1 min(s)
Length : 89 mm
Width : 22 mm
Depth : 103 mm
Antenna Type : Internal
Orientation : Touch
Power Drift-Start : 1.143 W/kg
Power Drift-Finish: 1.163 W/kg
Power Drift (%) : 1.824
Picture : C:\alsas\bitmap\Device-16.bmp

Phantom Data
Name : APREL-Uni
Type : Uni-Phantom
Size (mm) : 280 x 280 x 200
Serial No. : User Define
Location : Center
Description : Uni-Phantom

Tissue Data
Type : BODY
Serial No. : 5200B
Frequency : 5200.00 MHz
Last Calib. Date : 26-Sep-2014
Temperature : 21.50 °C
Ambient Temp. : 21.50 °C
Humidity : 54.00 RH%
Epsilon (Dielectric Constant) : 44.27
Sigma : 5.55 S/m
Density : 1000.00 kg/cu. m

Probe Data

Name : E-field
Model : E-020
Type : E-Field Triangle
Serial No. : 500-00283
Last Calib. Date : 08-Oct-2014
Frequency : 5200.00 MHz
Duty Cycle Factor (CreF) : 1
Conversion Factor : 3.5
Probe Sensitivity : 1.20 1.20 1.20 $\mu\text{V}/(\text{V}/\text{m})^2$
Compression Point : 95.00 mV
Offset : 1.56 mm

Measurement Data

Crest Factor : 1
Scan Type : Complete
Tissue Temp. : 21.50 °C
Ambient Temp. : 21.50 °C
Set-up Date : 29-Sep-2014
Set-up Time : 9:15:25 AM
Area Scan : 7x5x1 : Measurement x=10mm, y=10mm, z=4mm
Zoom Scan : 9x9x7 : Measurement x=4mm, y=4mm, z=5mm

Other Data

DUT Position : Touch
Separation : 0
Channel : Low

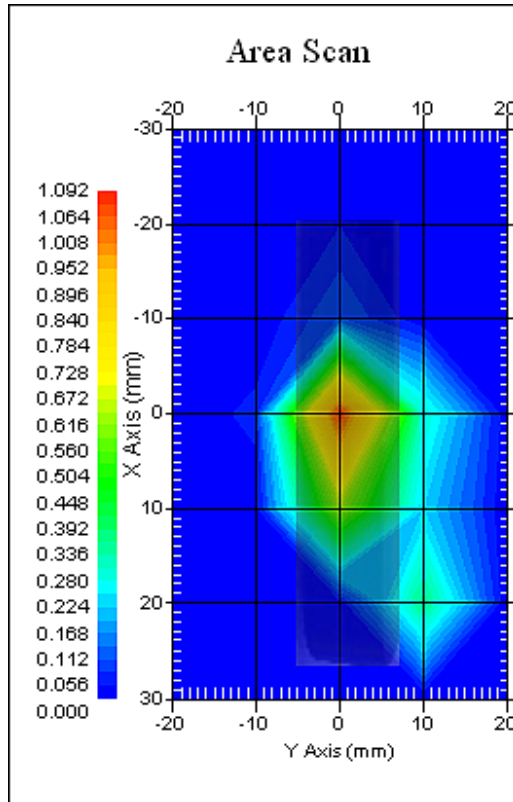

The system detected 1 maxima.
Selected highest maxima # = 1.
Maxima #1 coordinates: X = 4.120, Y = 0.000
1 gram SAR value : 1.091 W/kg
10 gram SAR value : 0.228 W/kg
Area Scan Peak SAR : 1.067 W/kg
Zoom Scan Peak SAR : 4.013 W/kg

Maxima Summary:
Maxima #1
Maxima coordinates: X = 4.120, Y = 0.000
1 gram SAR value : 1.091 W/kg
10 gram SAR value : 0.228 W/kg
Area Scan Peak SAR : 1.067 W/kg
Zoom Scan Peak SAR : 4.013 W/kg

Data No. 13:

Report Date : 29-Sep-2014
By Operator : 123
Measurement Date : 29-Sep-2014
Starting Time : 29-Sep-2014 10:18:19 AM
End Time : 29-Sep-2014 10:50:09 AM
Scanning Time : 1910 secs
Product Data
Device Name : 14LR223
Serial No. : NA
Type : Other
Model : Big
Frequency : 5200.00 MHz
Max. Transmit Pwr : 0.25 W
Drift Time : 1 min(s)
Length : 89 mm
Width : 22 mm
Depth : 103 mm
Antenna Type : Internal
Orientation : Touch
Power Drift-Start : 0.861 W/kg
Power Drift-Finish: 0.857 W/kg
Power Drift (%) : -0.535
Picture : C:\alsas\bitmap\Device-16.bmp

Phantom Data
Name : APREL-Uni
Type : Uni-Phantom
Size (mm) : 280 x 280 x 200
Serial No. : User Define
Location : Center
Description : Uni-Phantom

Tissue Data
Type : BODY
Serial No. : 5200B
Frequency : 5200.00 MHz
Last Calib. Date : 26-Sep-2014
Temperature : 21.50 °C
Ambient Temp. : 21.50 °C
Humidity : 54.00 RH%
Epsilon (Dielectric Constant): 44.27
Sigma : 5.55 S/m
Density : 1000.00 kg/cu. m

Probe Data

Name : E-field
Model : E-020
Type : E-Field Triangle
Serial No. : 500-00283
Last Calib. Date : 08-Oct-2014
Frequency : 5200.00 MHz
Duty Cycle Factor (CreF) : 1
Conversion Factor : 3.5
Probe Sensitivity : 1.20 1.20 1.20 $\mu\text{V}/(\text{V}/\text{m})^2$
Compression Point : 95.00 mV
Offset : 1.56 mm

Measurement Data

Crest Factor : 1
Scan Type : Complete
Tissue Temp. : 21.50 °C
Ambient Temp. : 21.50 °C
Set-up Date : 29-Sep-2014
Set-up Time : 9:15:25 AM
Area Scan : 7x5x1 : Measurement x=10mm, y=10mm, z=4mm
Zoom Scan : 9x9x7 : Measurement x=4mm, y=4mm, z=5mm

Other Data

DUT Position : Touch
Separation : 0
Channel : High

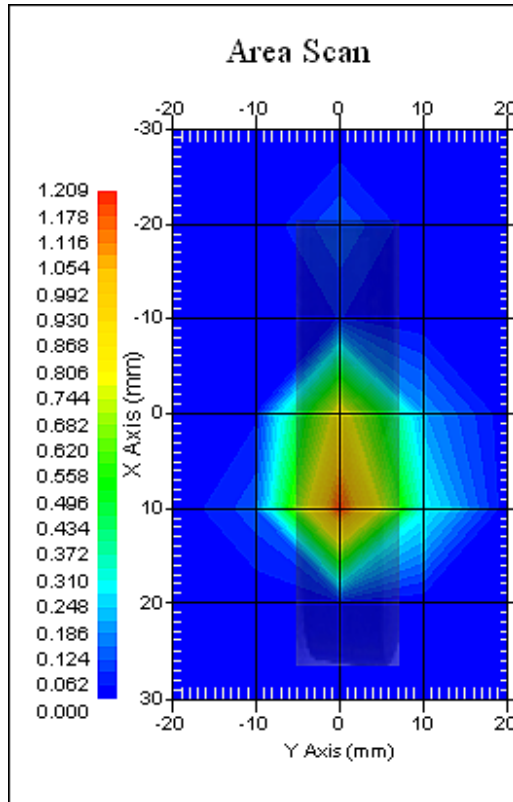

The system detected 1 maxima.
Selected highest maxima # = 1.
Maxima #1 coordinates: X = 6.070, Y = 0.000
1 gram SAR value : 1.278 W/kg
10 gram SAR value : 0.261 W/kg
Area Scan Peak SAR : 1.186 W/kg
Zoom Scan Peak SAR : 4.673 W/kg

Maxima Summary:
Maxima #1
Maxima coordinates: X = 6.070, Y = 0.000
1 gram SAR value : 1.278 W/kg
10 gram SAR value : 0.261 W/kg
Area Scan Peak SAR : 1.186 W/kg
Zoom Scan Peak SAR : 4.673 W/kg

Data No. 14:

Report Date : 26-Sep-2014
By Operator : 123
Measurement Date : 26-Sep-2014
Starting Time : 26-Sep-2014 10:38:12 AM
End Time : 26-Sep-2014 11:10:00 AM
Scanning Time : 1908 secs
Product Data
Device Name : 14LR223
Serial No. : NA
Type : Other
Model : Big
Frequency : 5800.00 MHz
Max. Transmit Pwr : 0.25 W
Drift Time : 1 min(s)
Length : 89 mm
Width : 22 mm
Depth : 103 mm
Antenna Type : Internal
Orientation : Touch
Power Drift-Start : 1.369 W/kg
Power Drift-Finish: 1.289 W/kg
Power Drift (%) : -5.802
Picture : C:\alsas\bitmap\Device-16.bmp

Phantom Data
Name : APREL-Uni
Type : Uni-Phantom
Size (mm) : 280 x 280 x 200
Serial No. : User Define
Location : Center
Description : Uni-Phantom

Tissue Data
Type : BODY
Serial No. : 5800B
Frequency : 5800.00 MHz
Last Calib. Date : 26-Sep-2014
Temperature : 21.60 °C
Ambient Temp. : 21.60 °C
Humidity : 58.00 RH%
Epsilon (Dielectric Constant): 44.18
Sigma : 6.23 S/m
Density : 1000.00 kg/cu. m

Probe Data

Name : E-field
Model : E-020
Type : E-Field Triangle
Serial No. : 500-00283
Last Calib. Date : 08-Oct-2014
Frequency : 5800.00 MHz
Duty Cycle Factor (CreF) : 1
Conversion Factor : 2.5
Probe Sensitivity : 1.20 1.20 1.20 $\mu\text{V}/(\text{V}/\text{m})^2$
Compression Point : 95.00 mV
Offset : 1.56 mm

Measurement Data

Crest Factor : 1
Scan Type : Complete
Tissue Temp. : 21.50 °C
Ambient Temp. : 21.50 °C
Set-up Date : 26-Sep-2014
Set-up Time : 9:15:25 AM
Area Scan : 7x5x1 : Measurement x=10mm, y=10mm, z=4mm
Zoom Scan : 9x9x7 : Measurement x=4mm, y=4mm, z=5mm

Other Data

DUT Position : Touch
Separation : 0
Channel : Mid

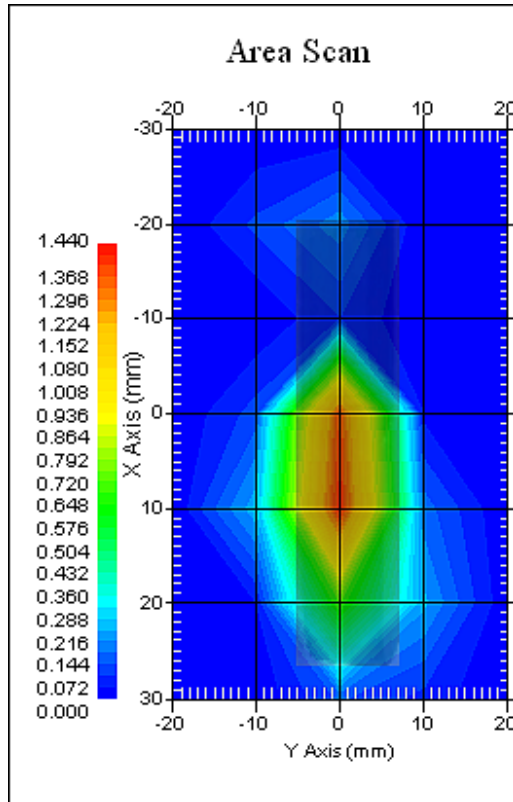

The system detected 1 maxima.
Selected highest maxima # = 1.
Maxima #1 coordinates: X = 14.090, Y = 0.000
1 gram SAR value : 1.295 W/kg
10 gram SAR value : 0.334 W/kg
Area Scan Peak SAR : 1.408 W/kg
Zoom Scan Peak SAR : 4.473 W/kg

Maxima Summary:

Maxima #1

Maxima coordinates: X = 14.090, Y = 0.000
1 gram SAR value : 1.295 W/kg
10 gram SAR value : 0.334 W/kg
Area Scan Peak SAR : 1.408 W/kg
Zoom Scan Peak SAR : 4.473 W/kg

Data No. 15:

Report Date : 29-Sep-2014
By Operator : 123
Measurement Date : 29-Sep-2014
Starting Time : 29-Sep-2014 03:43:47 PM
End Time : 29-Sep-2014 04:15:32 PM
Scanning Time : 1905 secs
Product Data
Device Name : 14LR223
Serial No. : NA
Type : Other
Model : Big
Frequency : 5800.00 MHz
Max. Transmit Pwr : 0.25 W
Drift Time : 1 min(s)
Length : 103 mm
Width : 22 mm
Depth : 89 mm
Antenna Type : Internal
Orientation : Touch
Power Drift-Start : 0.498 W/kg
Power Drift-Finish: 0.585 W/kg
Power Drift (%) : 17.384
Picture : C:\alsas\bitmap\Device-16.bmp

Phantom Data
Name : APREL-Uni
Type : Uni-Phantom
Size (mm) : 280 x 280 x 200
Serial No. : User Define
Location : Center
Description : Uni-Phantom

Tissue Data
Type : BODY
Serial No. : 5800B
Frequency : 5800.00 MHz
Last Calib. Date : 26-Sep-2014
Temperature : 21.60 °C
Ambient Temp. : 21.60 °C
Humidity : 58.00 RH%
Epsilon (Dielectric Constant) : 44.18
Sigma : 6.23 S/m
Density : 1000.00 kg/cu. m



Probe Data

Name : E-field
Model : E-020
Type : E-Field Triangle
Serial No. : 500-00283
Last Calib. Date : 08-Oct-2014
Frequency : 5800.00 MHz
Duty Cycle Factor (CreF) : 1
Conversion Factor : 2.5
Probe Sensitivity : 1.20 1.20 1.20 $\mu\text{V}/(\text{V}/\text{m})^2$
Compression Point : 95.00 mV
Offset : 1.56 mm

Measurement Data

Crest Factor : 1
Scan Type : Complete
Tissue Temp. : 21.60 °C
Ambient Temp. : 21.60 °C
Set-up Date : 29-Sep-2014
Set-up Time : 2:07:02 PM
Area Scan : 7x5x1 : Measurement x=10mm, y=10mm, z=4mm
Zoom Scan : 9x9x7 : Measurement x=4mm, y=4mm, z=5mm

Other Data

DUT Position : Touch
Separation : 0
Channel : High

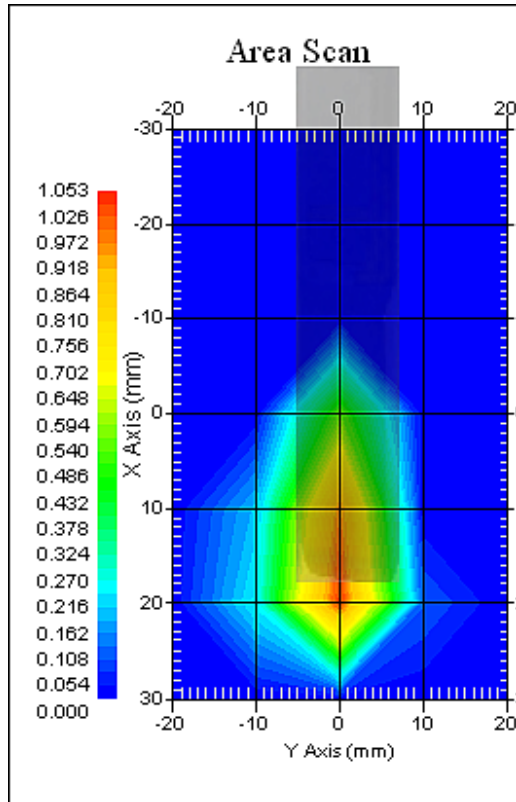

The system detected 1 maxima.
Selected highest maxima # = 1.
Maxima #1 coordinates: X = 16.080, Y = 0.000
1 gram SAR value : 1.364 W/kg
10 gram SAR value : 0.279 W/kg
Area Scan Peak SAR : 1.035 W/kg
Zoom Scan Peak SAR : 5.114 W/kg

Maxima Summary:

Maxima #1

Maxima coordinates: X = 16.080, Y = 0.000

1 gram SAR value : 1.364 W/kg

10 gram SAR value : 0.279 W/kg

Area Scan Peak SAR : 1.035 W/kg

Zoom Scan Peak SAR : 5.114 W/kg

Data No. 16:

Report Date : 29-Sep-2014
By Operator : 123
Measurement Date : 29-Sep-2014
Starting Time : 29-Sep-2014 10:51:15 AM
End Time : 29-Sep-2014 11:22:52 AM
Scanning Time : 1897 secs
Product Data
Device Name : 14LR223
Serial No. : NA
Type : Other
Model : Big
Frequency : 5200.00 MHz
Max. Transmit Pwr : 0.25 W
Drift Time : 1 min(s)
Length : 89 mm
Width : 22 mm
Depth : 103 mm
Antenna Type : Internal
Orientation : Touch
Power Drift-Start : 0.731 W/kg
Power Drift-Finish: 0.743 W/kg
Power Drift (%) : 1.702
Picture : C:\alsas\bitmap\Device-16.bmp

Phantom Data
Name : APREL-Uni
Type : Uni-Phantom
Size (mm) : 280 x 280 x 200
Serial No. : User Define
Location : Center
Description : Uni-Phantom

Tissue Data
Type : BODY
Serial No. : 5200B
Frequency : 5200.00 MHz
Last Calib. Date : 26-Sep-2014
Temperature : 21.50 °C
Ambient Temp. : 21.50 °C
Humidity : 54.00 RH%
Epsilon (Dielectric Constant): 44.27
Sigma : 5.55 S/m
Density : 1000.00 kg/cu. m

Probe Data

Name : E-field
Model : E-020
Type : E-Field Triangle
Serial No. : 500-00283
Last Calib. Date : 08-Oct-2014
Frequency : 5200.00 MHz
Duty Cycle Factor (CreF) : 1
Conversion Factor : 3.5
Probe Sensitivity : 1.20 1.20 1.20 $\mu\text{V}/(\text{V}/\text{m})^2$
Compression Point : 95.00 mV
Offset : 1.56 mm

Measurement Data

Crest Factor : 1
Scan Type : Complete
Tissue Temp. : 21.50 °C
Ambient Temp. : 21.50 °C
Set-up Date : 29-Sep-2014
Set-up Time : 9:15:25 AM
Area Scan : 7x5x1 : Measurement x=10mm, y=10mm, z=4mm
Zoom Scan : 9x9x7 : Measurement x=4mm, y=4mm, z=5mm

Other Data

DUT Position : Touch
Separation : 0
Channel : Low

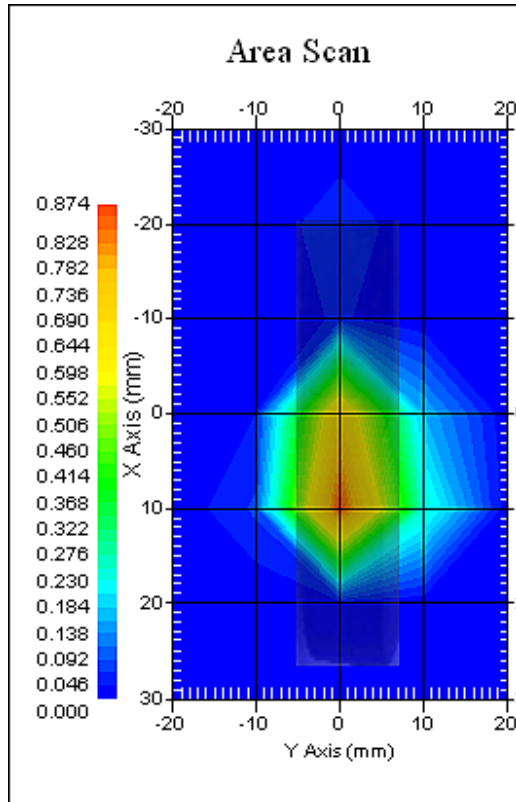

The system detected 1 maxima.
Selected highest maxima # = 1.
Maxima #1 coordinates: X = 6.100, Y = 0.000
1 gram SAR value : 0.988 W/kg
10 gram SAR value : 0.204 W/kg
Area Scan Peak SAR : 0.863 W/kg
Zoom Scan Peak SAR : 3.853 W/kg

Maxima Summary:
Maxima #1
Maxima coordinates: X = 6.100, Y = 0.000
1 gram SAR value : 0.988 W/kg
10 gram SAR value : 0.204 W/kg
Area Scan Peak SAR : 0.863 W/kg
Zoom Scan Peak SAR : 3.853 W/kg

Data No. 17:

Report Date : 29-Sep-2014
By Operator : 123
Measurement Date : 29-Sep-2014
Starting Time : 29-Sep-2014 12:16:56 PM
End Time : 29-Sep-2014 12:48:50 PM
Scanning Time : 1914 secs
Product Data
Device Name : 14LR223
Serial No. : NA
Type : Other
Model : Big
Frequency : 5200.00 MHz
Max. Transmit Pwr : 0.25 W
Drift Time : 1 min(s)
Length : 89 mm
Width : 22 mm
Depth : 103 mm
Antenna Type : Internal
Orientation : Touch
Power Drift-Start : 1.152 W/kg
Power Drift-Finish: 1.148 W/kg
Power Drift (%) : -0.386
Picture : C:\alsas\bitmap\Device-16.bmp

Phantom Data
Name : APREL-Uni
Type : Uni-Phantom
Size (mm) : 280 x 280 x 200
Serial No. : User Define
Location : Center
Description : Uni-Phantom

Tissue Data
Type : BODY
Serial No. : 5200B
Frequency : 5200.00 MHz
Last Calib. Date : 26-Sep-2014
Temperature : 21.50 °C
Ambient Temp. : 21.50 °C
Humidity : 54.00 RH%
Epsilon (Dielectric Constant): 44.27
Sigma : 5.55 S/m
Density : 1000.00 kg/cu. m



Probe Data

Name : E-field
Model : E-020
Type : E-Field Triangle
Serial No. : 500-00283
Last Calib. Date : 08-Oct-2014
Frequency : 5200.00 MHz
Duty Cycle Factor (CreF) : 1
Conversion Factor : 3.5
Probe Sensitivity : 1.20 1.20 1.20 $\mu\text{V}/(\text{V}/\text{m})^2$
Compression Point : 95.00 mV
Offset : 1.56 mm

Measurement Data

Crest Factor : 1
Scan Type : Complete
Tissue Temp. : 21.50 °C
Ambient Temp. : 21.50 °C
Set-up Date : 29-Sep-2014
Set-up Time : 9:15:25 AM
Area Scan : 7x5x1 : Measurement x=10mm, y=10mm, z=4mm
Zoom Scan : 9x9x7 : Measurement x=4mm, y=4mm, z=5mm

Other Data

DUT Position : Touch
Separation : 0
Channel : High

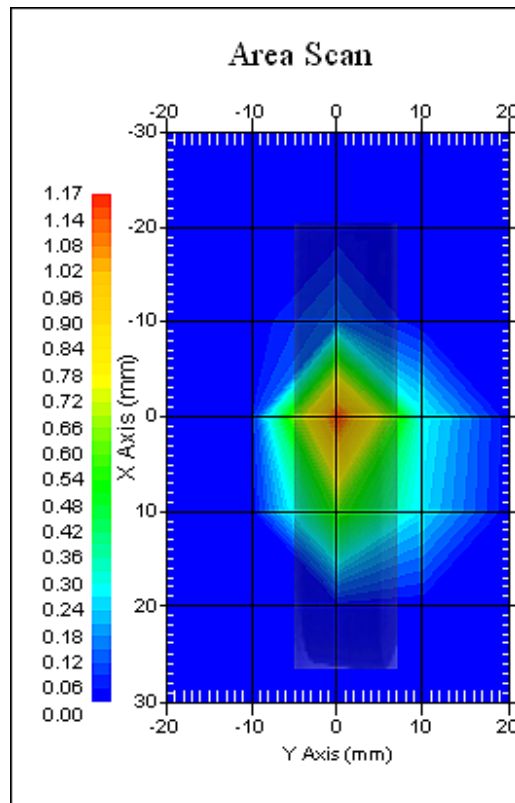

The system detected 1 maxima.
Selected highest maxima # = 1.
Maxima #1 coordinates: X = 4.060, Y = 0.000
1 gram SAR value : 1.123 W/kg
10 gram SAR value : 0.231 W/kg
Area Scan Peak SAR : 1.149 W/kg
Zoom Scan Peak SAR : 3.953 W/kg

Maxima Summary:
Maxima #1
Maxima coordinates: X = 4.060, Y = 0.000
1 gram SAR value : 1.123 W/kg
10 gram SAR value : 0.231 W/kg
Area Scan Peak SAR : 1.149 W/kg
Zoom Scan Peak SAR : 3.953 W/kg

Data No. 18:

Report Date : 29-Sep-2014
By Operator : 123
Measurement Date : 29-Sep-2014
Starting Time : 29-Sep-2014 03:45:29 AM
End Time : 29-Sep-2014 04:17:09 AM
Scanning Time : 1900 secs
Product Data
Device Name : 14LR223
Serial No. : NA
Type : Other
Model : Big
Frequency : 5800.00 MHz
Max. Transmit Pwr : 0.25 W
Drift Time : 1 min(s)
Length : 89 mm
Width : 22 mm
Depth : 103 mm
Antenna Type : Internal
Orientation : Touch
Power Drift-Start : 1.402 W/kg
Power Drift-Finish: 1.236 W/kg
Power Drift (%) : -11.841
Picture : C:\alsas\bitmap\Device-16.bmp

Phantom Data
Name : APREL-Uni
Type : Uni-Phantom
Size (mm) : 280 x 280 x 200
Serial No. : User Define
Location : Center
Description : Uni-Phantom

Tissue Data
Type : BODY
Serial No. : 5800B
Frequency : 5800.00 MHz
Last Calib. Date : 26-Sep-2014
Temperature : 21.60 °C
Ambient Temp. : 21.60 °C
Humidity : 58.00 RH%
Epsilon (Dielectric Constant) : 44.18
Sigma : 6.23 S/m
Density : 1000.00 kg/cu. m

Probe Data

Name : E-field
Model : E-020
Type : E-Field Triangle
Serial No. : 500-00283
Last Calib. Date : 08-Oct-2014
Frequency : 5800.00 MHz
Duty Cycle Factor (CreF) : 1
Conversion Factor : 2.5
Probe Sensitivity : 1.20 1.20 1.20 $\mu\text{V}/(\text{V}/\text{m})^2$
Compression Point : 95.00 mV
Offset : 1.56 mm

Measurement Data

Crest Factor : 1
Scan Type : Complete
Tissue Temp. : 21.60 °C
Ambient Temp. : 21.60 °C
Set-up Date : 26-Sep-2014
Set-up Time : 11:19:30 AM
Area Scan : 7x5x1 : Measurement x=10mm, y=10mm, z=4mm
Zoom Scan : 9x9x7 : Measurement x=4mm, y=4mm, z=5mm

Other Data

DUT Position : Touch
Separation : 0
Channel : Low

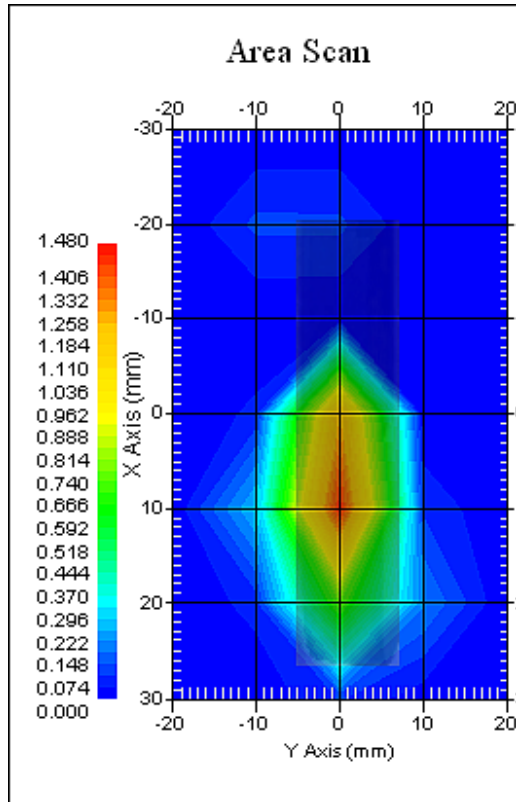

The system detected 1 maxima.
Selected highest maxima # = 1.
Maxima #1 coordinates: X = 14.070, Y = 0.000
1 gram SAR value : 1.284 W/kg
10 gram SAR value : 0.325 W/kg
Area Scan Peak SAR : 1.444 W/kg
Zoom Scan Peak SAR : 4.263 W/kg

Maxima Summary:

Maxima #1

Maxima coordinates: X = 14.070, Y = 0.000

1 gram SAR value : 1.284 W/kg

10 gram SAR value : 0.325 W/kg

Area Scan Peak SAR : 1.444 W/kg

Zoom Scan Peak SAR : 4.263 W/kg

Data No. 19:

Report Date : 29-Sep-2014
By Operator : 123
Measurement Date : 29-Sep-2014
Starting Time : 29-Sep-2014 04:21:07 AM
End Time : 29-Sep-2014 04:52:52 AM
Scanning Time : 1905 secs
Product Data
Device Name : 14LR223
Serial No. : NA
Type : Other
Model : Big
Frequency : 5800.00 MHz
Max. Transmit Pwr : 0.25 W
Drift Time : 1 min(s)
Length : 89 mm
Width : 22 mm
Depth : 103 mm
Antenna Type : Internal
Orientation : Touch
Power Drift-Start : 1.293 W/kg
Power Drift-Finish: 1.300 W/kg
Power Drift (%) : 0.565
Picture : C:\alsas\bitmap\Device-16.bmp

Phantom Data
Name : APREL-Uni
Type : Uni-Phantom
Size (mm) : 280 x 280 x 200
Serial No. : User Define
Location : Center
Description : Uni-Phantom

Tissue Data
Type : BODY
Serial No. : 5800B
Frequency : 5800.00 MHz
Last Calib. Date : 26-Sep-2014
Temperature : 21.60 °C
Ambient Temp. : 21.60 °C
Humidity : 58.00 RH%
Epsilon (Dielectric Constant) : 44.18
Sigma : 6.23 S/m
Density : 1000.00 kg/cu. m

Probe Data

Name : E-field
Model : E-020
Type : E-Field Triangle
Serial No. : 500-00283
Last Calib. Date : 08-Oct-2014
Frequency : 5800.00 MHz
Duty Cycle Factor (CreF) : 1
Conversion Factor : 2.5
Probe Sensitivity : 1.20 1.20 1.20 $\mu\text{V}/(\text{V}/\text{m})^2$
Compression Point : 95.00 mV
Offset : 1.56 mm

Measurement Data

Crest Factor : 1
Scan Type : Complete
Tissue Temp. : 21.60 °C
Ambient Temp. : 21.60 °C
Set-up Date : 26-Sep-2014
Set-up Time : 11:19:30 AM
Area Scan : 7x5x1 : Measurement x=10mm, y=10mm, z=4mm
Zoom Scan : 9x9x7 : Measurement x=4mm, y=4mm, z=5mm

Other Data

DUT Position : Touch
Separation : 0
Channel : Mid

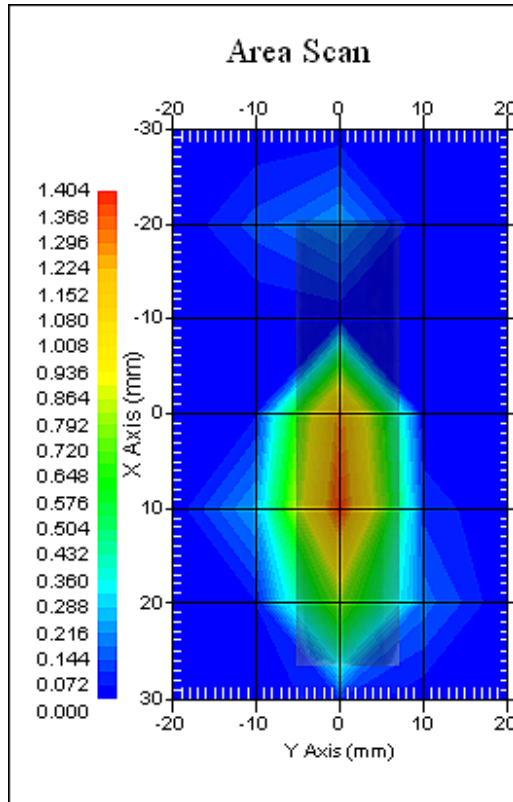

The system detected 1 maxima.
Selected highest maxima # = 1.
Maxima #1 coordinates: X = 14.110, Y = 0.000
1 gram SAR value : 1.275 W/kg
10 gram SAR value : 0.316 W/kg
Area Scan Peak SAR : 1.396 W/kg
Zoom Scan Peak SAR : 4.293 W/kg

Maxima Summary:

Maxima #1

Maxima coordinates: X = 14.110, Y = 0.000

1 gram SAR value : 1.275 W/kg

10 gram SAR value : 0.316 W/kg

Area Scan Peak SAR : 1.396 W/kg

Zoom Scan Peak SAR : 4.293 W/kg

Data No. 20:

Report Date : 29-Sep-2014
By Operator : 123
Measurement Date : 29-Sep-2014
Starting Time : 29-Sep-2014 04:54:18 AM
End Time : 29-Sep-2014 05:26:07 AM
Scanning Time : 1909 secs
Product Data
Device Name : 14LR223
Serial No. : NA
Type : Other
Model : Big
Frequency : 5800.00 MHz
Max. Transmit Pwr : 0.25 W
Drift Time : 1 min(s)
Length : 89 mm
Width : 22 mm
Depth : 103 mm
Antenna Type : Internal
Orientation : Touch
Power Drift-Start : 1.239 W/kg
Power Drift-Finish: 1.331 W/kg
Power Drift (%) : 7.471
Picture : C:\alsas\bitmap\Device-16.bmp

Phantom Data
Name : APREL-Uni
Type : Uni-Phantom
Size (mm) : 280 x 280 x 200
Serial No. : User Define
Location : Center
Description : Uni-Phantom

Tissue Data
Type : BODY
Serial No. : 5800B
Frequency : 5800.00 MHz
Last Calib. Date : 26-Sep-2014
Temperature : 21.60 °C
Ambient Temp. : 21.60 °C
Humidity : 58.00 RH%
Epsilon (Dielectric Constant) : 44.18
Sigma : 6.23 S/m
Density : 1000.00 kg/cu. m

Probe Data

Name : E-field
Model : E-020
Type : E-Field Triangle
Serial No. : 500-00283
Last Calib. Date : 08-Oct-2014
Frequency : 5800.00 MHz
Duty Cycle Factor (CreF) : 1
Conversion Factor : 2.5
Probe Sensitivity : 1.20 1.20 1.20 $\mu\text{V}/(\text{V}/\text{m})^2$
Compression Point : 95.00 mV
Offset : 1.56 mm

Measurement Data

Crest Factor : 1
Scan Type : Complete
Tissue Temp. : 21.60 °C
Ambient Temp. : 21.60 °C
Set-up Date : 26-Sep-2014
Set-up Time : 11:19:30 AM
Area Scan : 7x5x1 : Measurement x=10mm, y=10mm, z=4mm
Zoom Scan : 9x9x7 : Measurement x=4mm, y=4mm, z=5mm

Other Data

DUT Position : Touch
Separation : 0
Channel : High

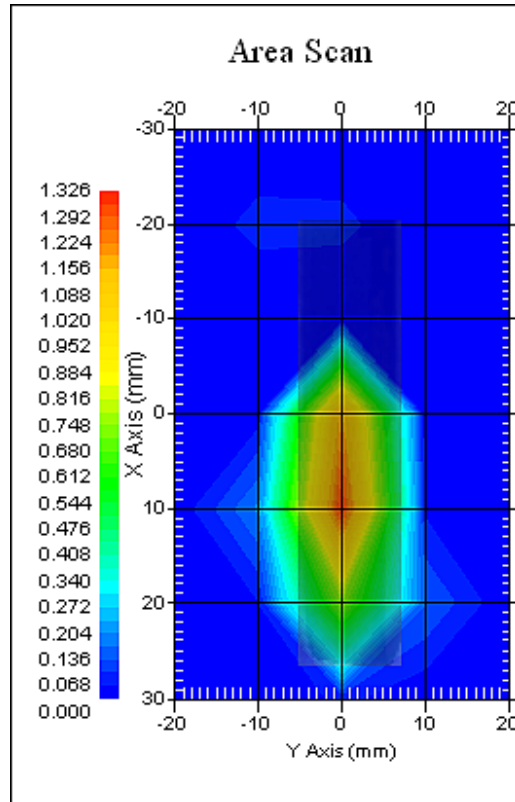

The system detected 1 maxima.
Selected highest maxima # = 1.
Maxima #1 coordinates: X = 14.110, Y = 0.000
1 gram SAR value : 1.146 W/kg
10 gram SAR value : 0.283 W/kg
Area Scan Peak SAR : 1.300 W/kg
Zoom Scan Peak SAR : 4.003 W/kg

Maxima Summary:

Maxima #1

Maxima coordinates: X = 14.110, Y = 0.000

1 gram SAR value : 1.146 W/kg

10 gram SAR value : 0.283 W/kg

Area Scan Peak SAR : 1.300 W/kg

Zoom Scan Peak SAR : 4.003 W/kg

SAR-Z Axis
at Hotspot x:0.11 y:-0.07

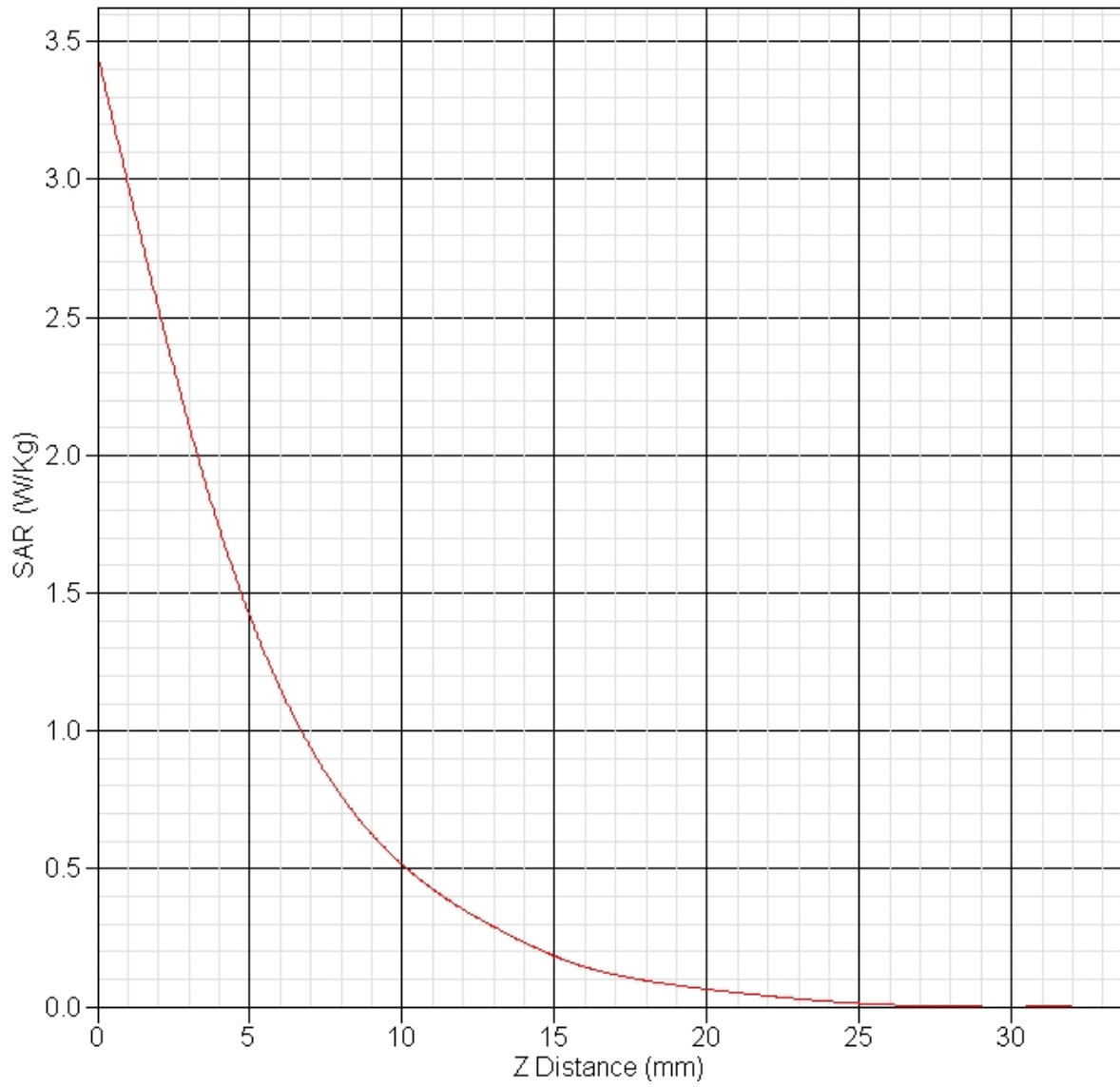

NCL CALIBRATION LABORATORIES

Calibration File No.: PC-1558

Client.: ISL

CERTIFICATE OF CALIBRATION

It is certified that the equipment identified below has been calibrated in the
NCL CALIBRATION LABORATORIES by qualified personnel following recognized
procedures and using transfer standards traceable to NRC/NIST.

Equipment: Miniature Isotropic RF Probe

Record of Calibration

Head & Body

Manufacturer: APREL Laboratories

Model No.: E-020

Serial No.: 266

Calibration Procedure: D01-032-E020-V2, D22-012-Tissue, D28-002-Dipole

Project No: ISL-E020-5754

Calibrated: 19th March 2014

Released on: 19th March 2014

This Calibration Certificate is Incomplete Unless Accompanied with the Calibration Results Summary

Released By: _____



Art Brennan, Quality Manager

NCL CALIBRATION LABORATORIES

303 Terry Fox Drive, Suite 102
Kanata, Ontario
CANADA K2K 3J1

Division of APREL
TEL: (613) 435-8300
FAX: (613) 435-8306

Introduction

This Calibration Report reproduces the results of the calibration performed in line with the references listed below. Calibration is performed using accepted methodologies as per the references listed below. Probes are calibrated for air, and tissue and the values reported are the results from the physical quantification of the probe through meteorological practices.

Calibration Method

Probes are calibrated using the following methods.

<1000MHz

TEM Cell for sensitivity in air

Standard phantom using temperature transfer method for sensitivity in tissue

>1000MHz

Waveguide* method to determine sensitivity in air and tissue

*Waveguide is numerically (simulation) assessed to determine the field distribution and power

The boundary effect for the probe is assessed using a standard flat phantom where the probe output is compared against a numerically simulated series of data points

References

- IEEE Standard 1528 (2003) including Amendment 1
IEEE Recommended Practice for Determining the Peak Spatial-Average Specific Absorption Rate (SAR) in the Human Head from Wireless Communications Devices: Measurement Techniques
- EN 62209-1 (2006)
Human Exposure to RF Fields from hand-held and body-mounted wireless communication devices - Human models, instrumentation, and procedures-Part 1: Procedure to measure the Specific Absorption Rate (SAR) for hand-held mobile wireless devices
- IEC 62209-2 Ed. 1.0 (2010-03)
Human exposure to RF fields from hand-held and body-mounted wireless devices - Human models, instrumentation, and procedures - Part 2: specific absorption rate (SAR) for wireless communication devices (30 MHz - 6 GHz)
- TP-D01-032-E020-V2 E-Field probe calibration procedure
- D22-012-Tissue dielectric tissue calibration procedure
- D28-002-Dipole procedure for validation of SAR system using a dipole
- IEEE 1309 Draft Standard for Calibration of Electromagnetic Field Sensors and Probes, Excluding Antennas, from 9kHz to 40GHz

NCL Calibration Laboratories

Division of APREL Inc.

Conditions

Probe 266 was a recalibration.

Ambient Temperature of the Laboratory: 22 °C +/- 1.5°C
Temperature of the Tissue: 21 °C +/- 1.5°C
Relative Humidity: < 60%

Primary Measurement Standards

Instrument	Serial Number	Cal due date
Tektronix USB Power Meter	11C940	May 14, 2015
Network Analyzer Anritsu 37347C	002106	Feb. 20, 2015

Secondary Measurement Standards

Signal Generator HP 83640B	3844A00689	Feb 12, 2015
----------------------------	------------	--------------

Attestation

The below named signatories have conducted the calibration and review of the data which is presented in this calibration report.

We the undersigned attest that to the best of our knowledge the calibration of this subject has been accurately conducted and that all information contained within the results pages have been reviewed for accuracy.



Art Brennan, Quality Manager



Dan Brooks, Test Engineer

Probe Summary

Probe Type:	E-Field Probe E020
Serial Number:	266
Frequency:	As presented on page 5
Sensor Offset:	1.56
Sensor Length:	2.5
Tip Enclosure:	Composite*
Tip Diameter:	< 2.9 mm
Tip Length:	55 mm
Total Length:	289 mm

*Resistive to recommended tissue recipes per IEEE-1528

Sensitivity in Air

Channel X:	1.2 $\mu\text{V}/(\text{V}/\text{m})^2$
Channel Y:	1.2 $\mu\text{V}/(\text{V}/\text{m})^2$
Channel Z:	1.2 $\mu\text{V}/(\text{V}/\text{m})^2$
Diode Compression Point:	95 mV

NCL Calibration Laboratories

Division of APREL Inc.

Calibration for Tissue (Head H, Body B)

Frequency	Tissue Type	Measured Epsilon	Measured Sigma	Calibration Uncertainty	Tolerance Uncertainty for 5%*	Conversion Factor
700 H	Head	X	X	X	X	X
700 B	Body	X	X	X	X	X
750 H	Head	X	X	X	X	X
750 B	Body	X	X	X	X	X
835 H	Head	X	X	X	X	X
835 B	Body	X	X	X	X	X
900 H	Head	40.59	0.95	3.5	2.7	6.8
900 B	Body	56.08	1.03	3.5	2.7	6.7
1450 H	Head	X	X	X	X	X
1450 B	Body	X	X	X	X	X
1500 H	Head	X	X	X	X	X
1500 B	Body	X	X	X	X	X
1640 H	Head	X	X	X	X	X
1640 B	Body	X	X	X	X	X
1750 H	Head	38.51	1.36	3.5	2.7	5.9
1750 B	Body	52.79	1.53	3.5	2.7	5.8
1800 H	Head	X	X	X	X	X
1800 B	Body	X	X	X	X	X
1900 H	Head	38.48	1.4	3.5	2.7	5.6
1900 B	Body	51.89	1.46	3.5	2.7	5.4
2000 H	Head	38.75	1.42	3.5	2.7	5.5
2000 B	Body	52.55	1.53	3.5	2.7	5.5
2100 H	Head	X	X	X	X	X
2100 B	Body	X	X	X	X	X
2300 H	Head	X	X	X	X	X
2300 B	Body	X	X	X	X	X
2450 H	Head	X	X	X	X	X
2450B	Body	52.37	2.04	3.5	2.7	4.6
2600 H	Head	X	X	X	X	X
2600 B	Body	X	X	X	X	X
3000 H	Head	X	X	X	X	X
3000 B	Body	X	X	X	X	X
3600 H	Head	X	X	X	X	X
3600 B	Body	X	X	X	X	X
5200 H	Head	X	X	X	X	X
5200 B	Body	X	X	X	X	X
5600 H	Head	X	X	X	X	X
5600 B	Body	X	X	X	X	X
5800 H	Head	X	X	X	X	X
5800 B	Body	X	X	X	X	X

Boundary Effect:

Uncertainty resulting from the boundary effect is less than 2.1% for the distance between the tip of the probe and the tissue boundary, when less than 0.58mm.

Spatial Resolution:

The spatial resolution uncertainty is less than 1.5% for 4.9mm diameter probe.
The spatial resolution uncertainty is less than 1.0% for 2.5mm diameter probe.

DAQ-PAQ Contribution

To minimize the uncertainty calculation all tissue sensitivity values were calculated using a load impedance of 5 M Ω .

Boundary Effect:

For a distance of 0.58mm the worst case evaluated uncertainty (increase in the probe sensitivity) is less than 2.1%.

NOTES:

*The maximum deviation from the centre frequency when comparing the lower to upper range is listed.

Receiving Pattern Air

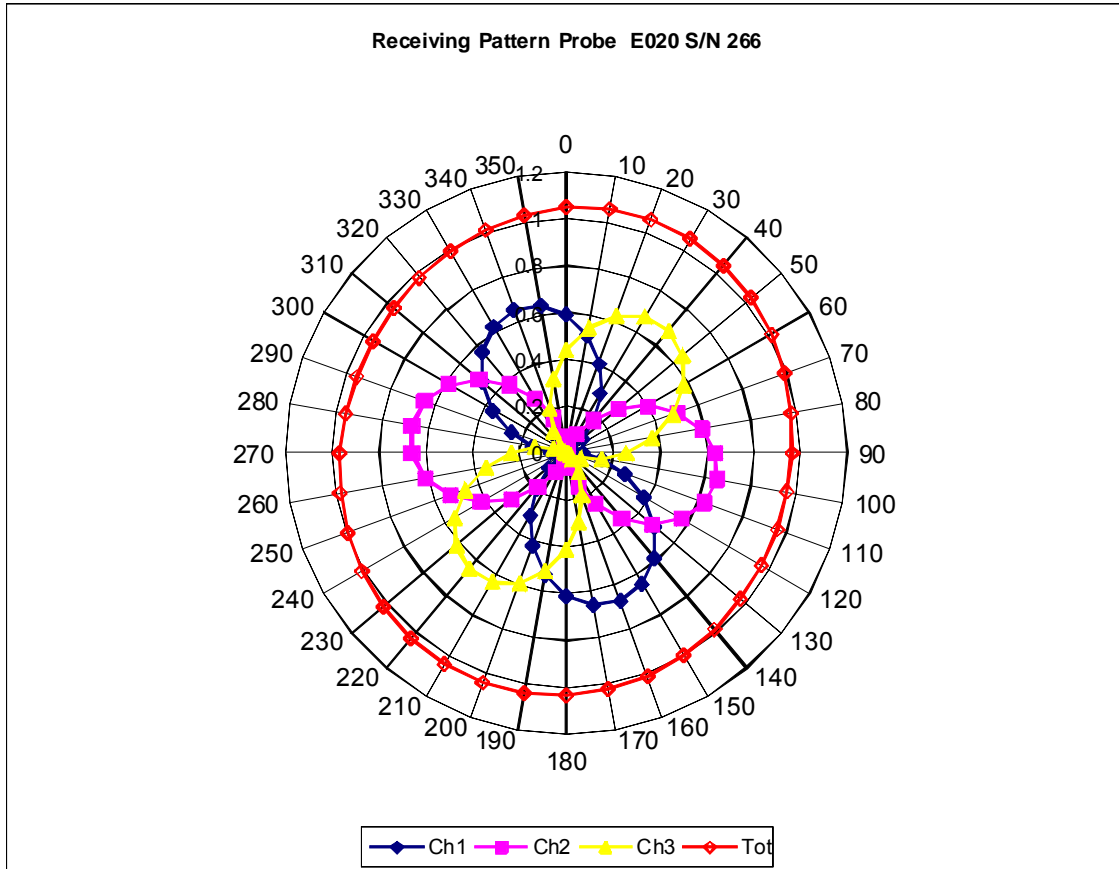

Isotropy Error Air

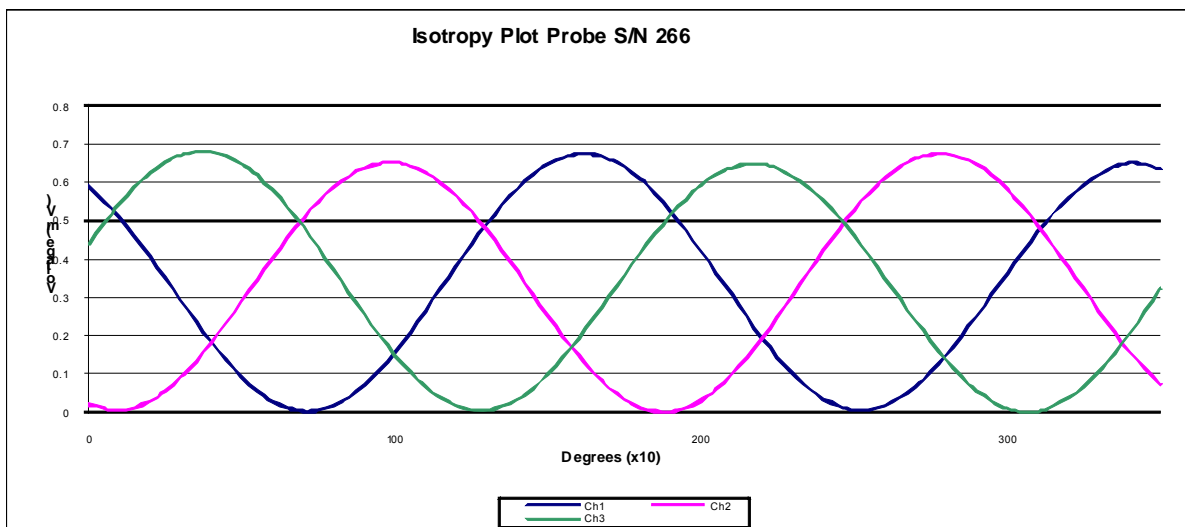
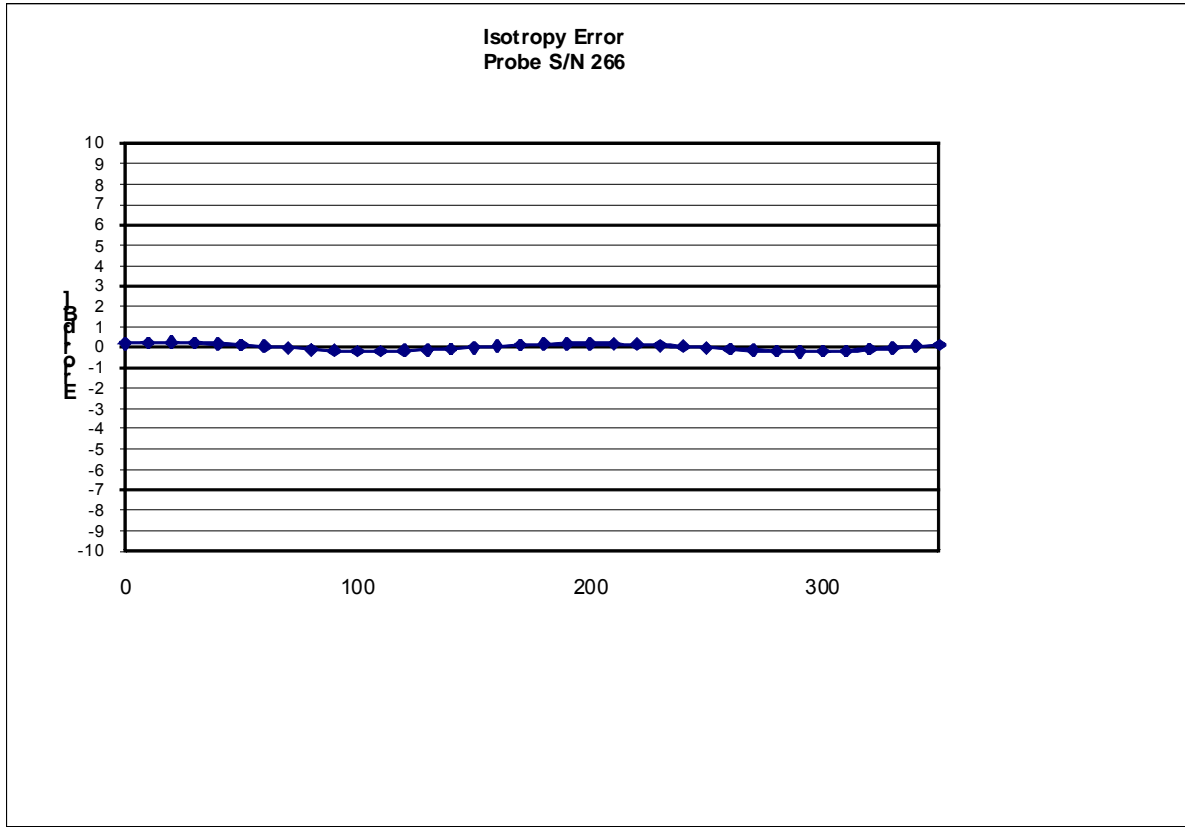

Isotropicity Tissue:

0.10 dB

Dynamic Range

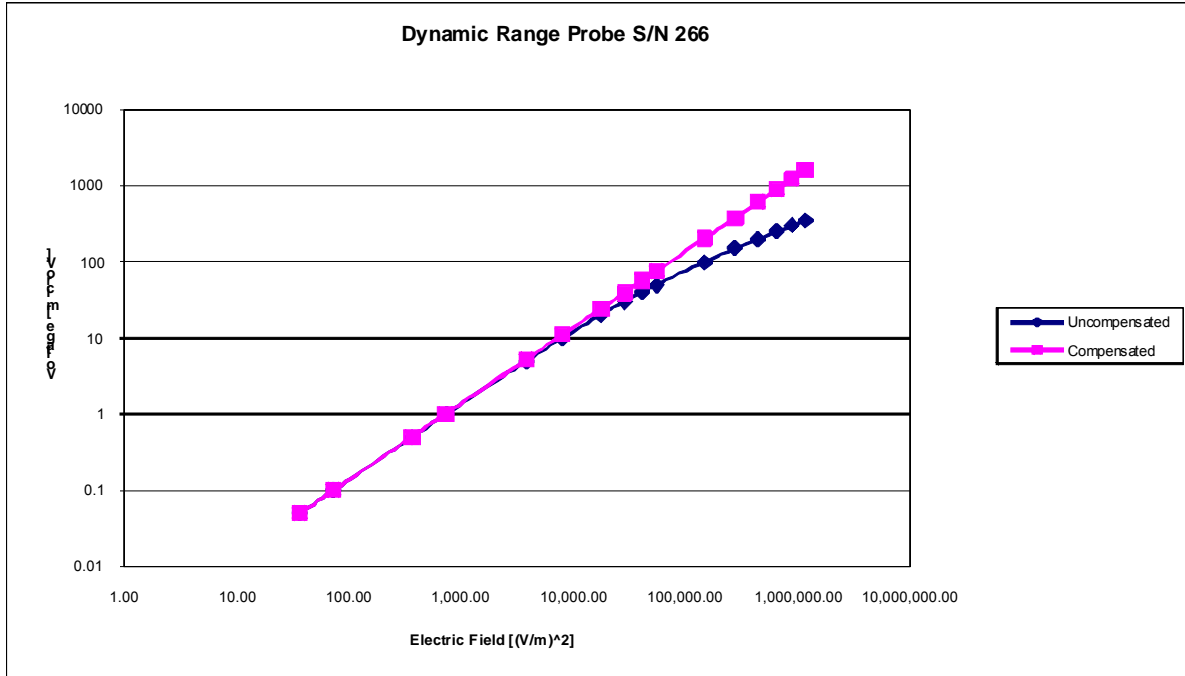

Video Bandwidth

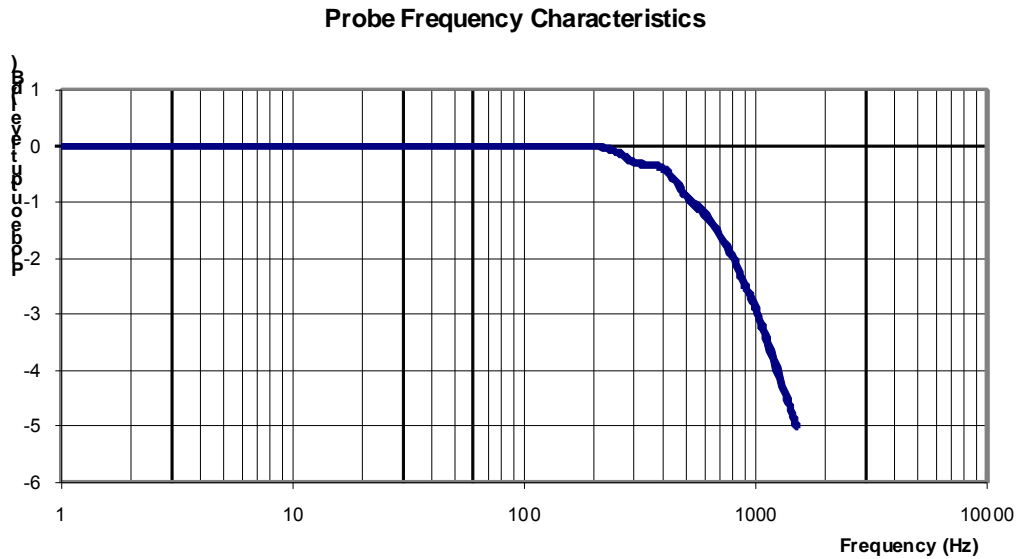

Video Bandwidth at 500 Hz 1 dB
Video Bandwidth at 1.02 KHz: 3 dB

Test Equipment

The test equipment used during Probe Calibration, manufacturer, model number and, current calibration status are listed and located on the main APREL server R:\NCL\Calibration Equipment\Instrument List May 2013.

NCL CALIBRATION LABORATORIES

Calibration File No: DC-1400
Project Number: ISL-D2450-cal-5639

C E R T I F I C A T E O F C A L I B R A T I O N

It is certified that the equipment identified below has been calibrated in the
NCL CALIBRATION LABORATORIES by qualified personnel following recognized
procedures and using transfer standards traceable to NRC/NIST.

ISL Body Validation Dipole

Manufacturer: APREL Laboratories

Part number: ALS-D-2450-S-2

Frequency: 2450 MHz

Serial No: 2450-220-00753

Customer: ISL

Calibrated: 25th January 2012
Released on: 25th January, 2012

This Calibration Certificate is Incomplete Unless Accompanied with the Calibration Results Summary

Released By: _____



Art Brennan, Quality Manager

NCL CALIBRATION LABORATORIES

Suite 102, 303 Terry Fox Dr,
OTTAWA, ONTARIO
CANADA K2K 3J1

Division of APREL Lab.
TEL: (613) 435-8300
FAX: (613) 435-8306

Conditions

Dipole 2450-220-00753 was a re-calibration.

Ambient Temperature of the Laboratory: 22 °C +/- 0.5°C
Temperature of the Tissue: 21 °C +/- 0.5°C

We the undersigned attest that to the best of our knowledge the calibration of this subject has been accurately conducted and that all information contained within the results pages have been reviewed for accuracy.



Art Brennan, Quality Manager



Constantin Teodorian, Test Engineer

Calibration Results Summary

The following results relate the Calibrated Dipole and should be used as a quick reference for the user.

Mechanical Dimensions

Length: 51.5 mm
Height: 30.4 mm

Electrical Specification

S11 R/L	-16.32 dB
SWR	1.37 U
Impedance	10.33 Ω

System Validation Results

Calibrated @ 100mW

Frequency	1 Gram	10 Gram	Peak
2450 MHz	55.57	25.80	112.98

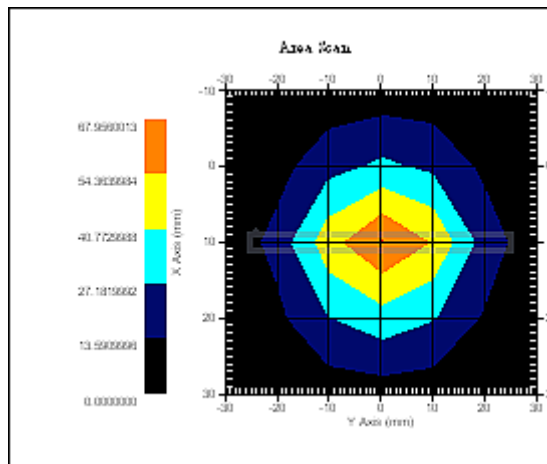

Introduction

This Calibration Report has been produced in line with the SSI Dipole Calibration Procedure SSI-TP-018-ALSAS. The results contained within this report are for Validation Dipole 235-00801. The calibration routine consisted of a three-step process. Step 1 was a mechanical verification of the dipole to ensure that it meets the mechanical specifications. Step 2 was an Electrical Calibration for the Validation Dipole, where the SWR, Impedance, and the Return loss were assessed. Step 3 involved a System Validation using the ALSAS-10U, along with APREL E-030 130 MHz to 26 GHz E-Field Probe Serial Number 215.

References

SSI-TP-018-ALSAS Dipole Calibration Procedure

SSI-TP-016 Tissue Calibration Procedure

IEEE 1528 “Recommended Practice for Determining the Peak Spatial-Average Specific Absorption Rate (SAR) in the Human Body Due to Wireless Communications Devices: Experimental Techniques”

IEC-62209 “Human exposure to radio frequency fields from hand-held and body-mounted wireless communication devices – Human models, instrumentation, and procedures”

Part 1: “Procedure to determine the Specific Absorption Rate (SAR) for hand-held devices used in close proximity of the ear (frequency range of 300 MHz to 3 GHz)”

IEC-62209 “Human exposure to radio frequency fields from hand-held and body-mounted wireless communication devices – Human models, instrumentation, and procedures”

Part 2 *Draft*: “Procedure to determine the Specific Absorption Rate (SAR) for hand-held devices used in close proximity of the ear (frequency range of 30 MHz to 6 GHz)”

Conditions

Ambient Temperature of the Laboratory: 22 °C +/- 0.5°C

Temperature of the Tissue: 20 °C +/- 0.5°C

This was a recalibration.

Dipole Calibration uncertainty

The calibration uncertainty for the dipole is made up of various parameters presented below.

Mechanical	1%
Positioning Error	1.22%
Electrical	1.7%
Tissue	2.2%
Dipole Validation	2.2%
TOTAL	8.32% (16.64% K=2)

Dipole Calibration Results

Mechanical Verification

APREL Length	APREL Height	Measured Length	Measured Height
51.5 mm	30.4 mm	52.1 mm	31.0 mm

Tissue Validation

Body Tissue 2450 MHz	Measured
Dielectric constant, ϵ_r	51.2
Conductivity, σ [S/m]	2.16

Electrical Calibration

Test	Result
S11 R/L	-16.32 dB
SWR	1.37 U
Impedance	10.33 Ω

The Following Graphs are the results as displayed on the Vector Network Analyzer.

S11 Parameter Return Loss

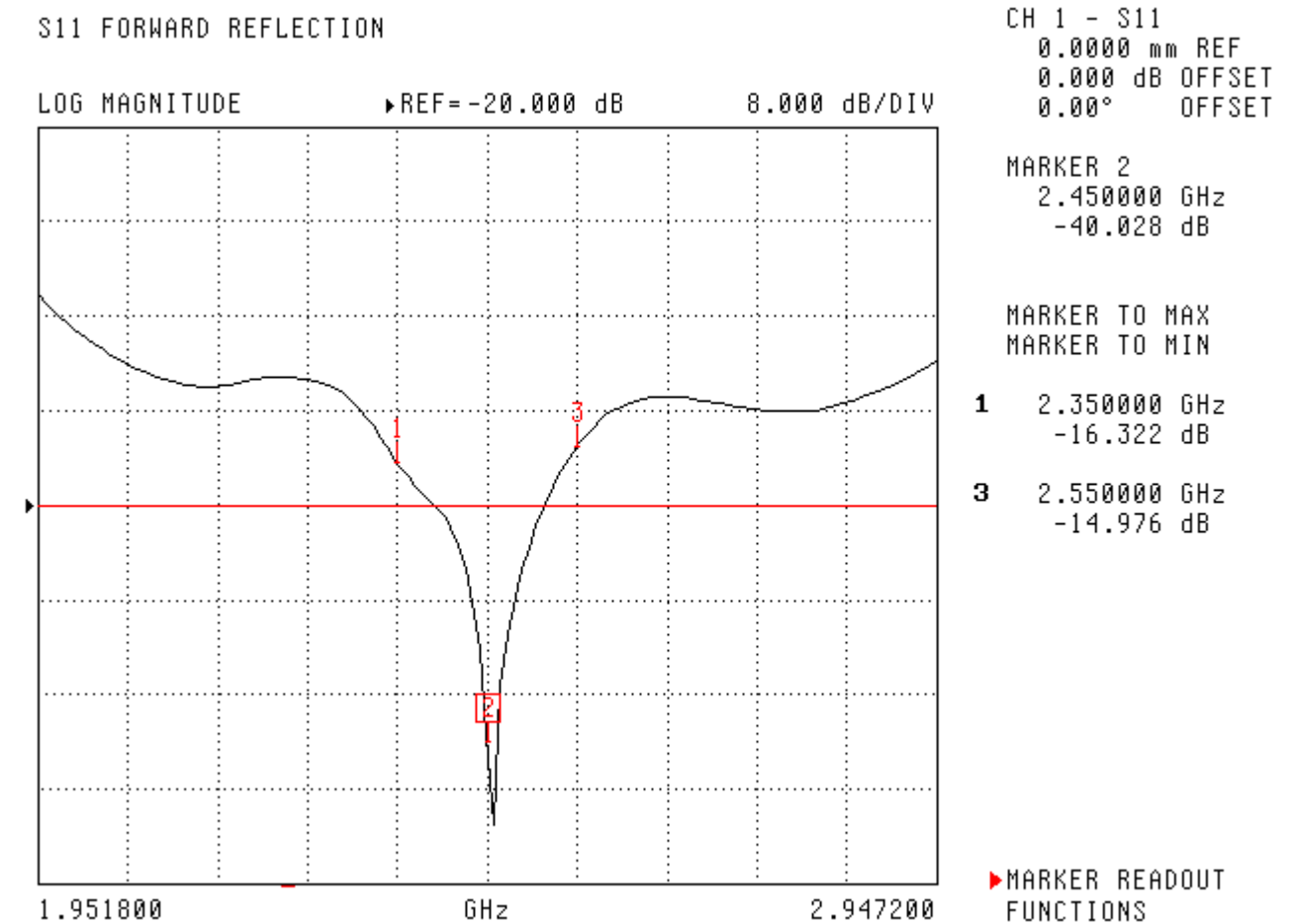

SWR

S11 FORWARD REFLECTION

SWR

REF=0.000 pU

2.000 U/DIV

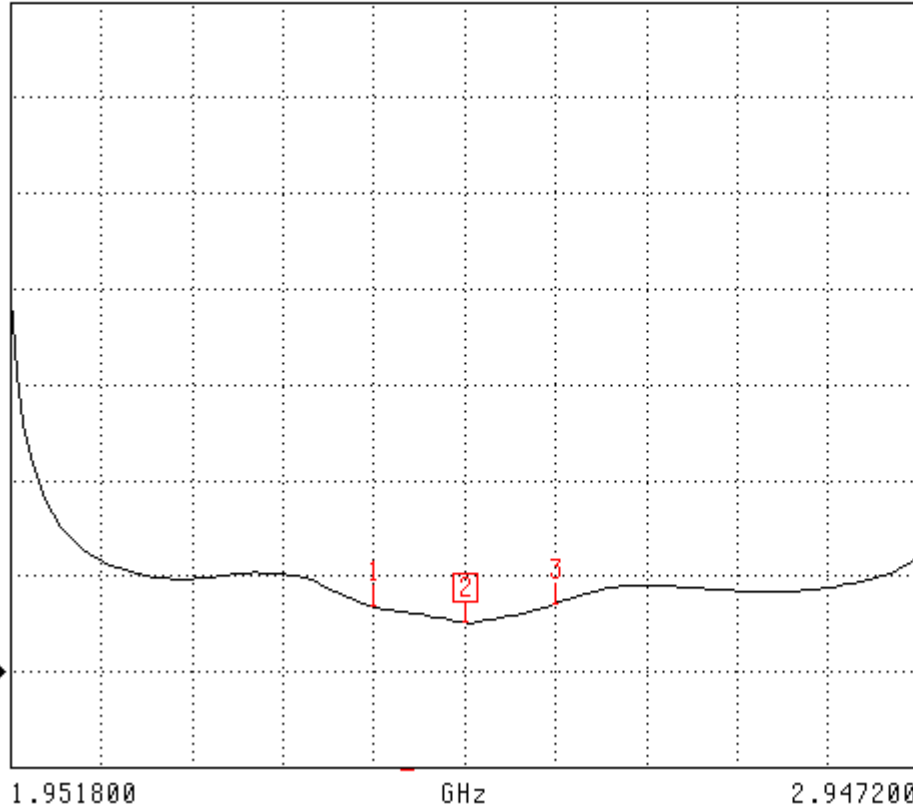

CH 1 - S11

0.0000 mm REF

0.000 dB OFFSET

0.00° OFFSET

MARKER 2

2.450000 GHz

1.021 U

MARKER TO MAX
MARKER TO MIN

1 2.350000 GHz
1.368 U

3 2.550000 GHz
1.430 U

MARKER READOUT
FUNCTIONS

Smith Chart Dipole Impedance

S11 FORWARD REFLECTION
IMPEDANCE

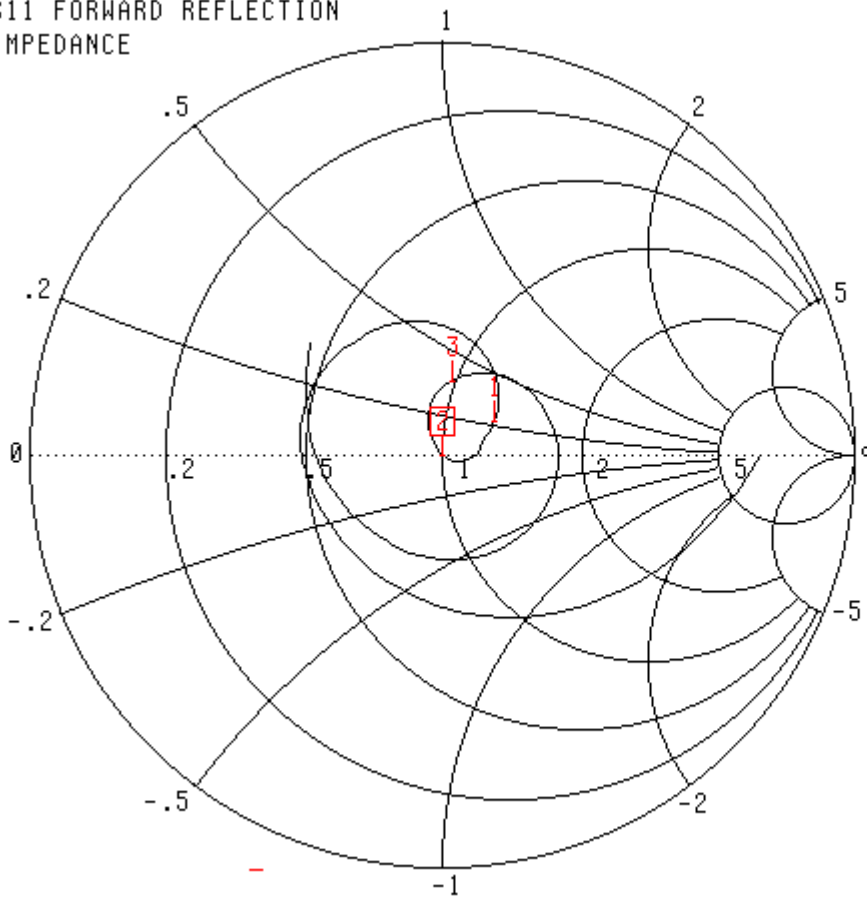

CH 1 - S11
0.0000 mm REF
0.000 dB OFFSET
0.00° OFFSET

MARKER 2
2.450000 GHz
50.713 Ω
-649.365 jΩ

MARKER TO MAX
MARKER TO MIN

- 1** 2.350000 GHz
64.146 Ω
10.325 jΩ
- 3** 2.550000 GHz
49.559 Ω
18.033 jΩ

▶ MARKER READOUT
FUNCTIONS

NCL Calibration Laboratories

Division of APREL Laboratories.

Test Equipment

The test equipment used during Probe Calibration, manufacturer, model number and, current calibration status are listed and located on the main APREL server R:\NCL\Calibration Equipment\Instrument List May 2011.

NCL CALIBRATION LABORATORIES

Calibration File No: DC-1401
Project Number: ISL-D5200-5640

C E R T I F I C A T E O F C A L I B R A T I O N

It is certified that the equipment identified below has been calibrated in the
NCL CALIBRATION LABORATORIES by qualified personnel following recognized
procedures and using transfer standards traceable to NRC/NIST.

ISL Body Validation Dipole

Manufacturer: APREL Laboratories

Part number: ALS-D-5200-S-2

Frequency: 5200 MHz

Serial No: 5200-230-00802

Customer: ISL

Calibrated: 25th January 2012
Released on: 25th January 2012

This Calibration Certificate is Incomplete Unless Accompanied with the Calibration Results Summary

Released By: _____



Art Brennan, Quality Manager

NCL CALIBRATION LABORATORIES

Suite 102, 303 Terry Fox Dr,
OTTAWA, ONTARIO
CANADA K2K 3J1

Division of APREL Lab.
TEL: (613) 435-8300
FAX: (613) 435-8306

NCL Calibration Laboratories

Division of APREL Laboratories.

Conditions

Dipole 5200-230-00802 was a re-calibration.

Ambient Temperature of the Laboratory: 22 °C +/- 0.5°C

Temperature of the Tissue: 21 °C +/- 0.5°C

We the undersigned attest that to the best of our knowledge the calibration of this subject has been accurately conducted and that all information contained within the results pages have been reviewed for accuracy.



Art Brennan, Quality Manager

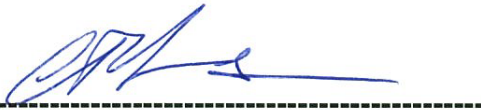

Constantin Teodorian, Test Engineer

Calibration Results Summary

The following results relate the Calibrated Dipole and should be used as a quick reference for the user.

Mechanical Dimensions

Length: 23.6 mm
Height: 14.0 mm

Electrical Specification

S11 R/L	-23.67 dB
SWR	1.14 U
Impedance	57.17 Ω

System Validation Results

Frequency	1 Gram	10 Gram	Peak
5200 MHz	67.35	22.23	199.16

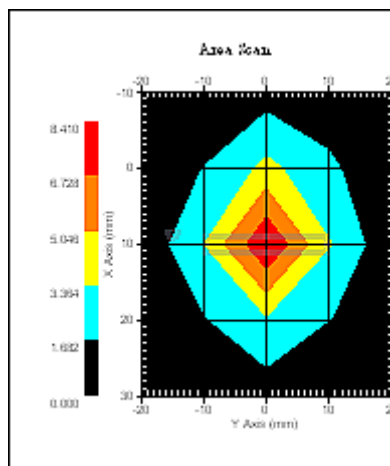

Introduction

This Calibration Report has been produced in line with the SSI Dipole Calibration Procedure SSI-TP-018-ALSAS. The results contained within this report are for Validation Dipole 235-00801. The calibration routine consisted of a three-step process. Step 1 was a mechanical verification of the dipole to ensure that it meets the mechanical specifications. Step 2 was an Electrical Calibration for the Validation Dipole, where the SWR, Impedance, and the Return loss were assessed. Step 3 involved a System Validation using the ALSAS-10U, along with APREL E-030 130 MHz to 26 GHz E-Field Probe Serial Number 215.

References

SSI-TP-018-ALSAS Dipole Calibration Procedure

SSI-TP-016 Tissue Calibration Procedure

IEEE 1528 “Recommended Practice for Determining the Peak Spatial-Average Specific Absorption Rate (SAR) in the Human Body Due to Wireless Communications Devices: Experimental Techniques”

IEC-62209 “Human exposure to radio frequency fields from hand-held and body-mounted wireless communication devices – Human models, instrumentation, and procedures”

Part 1: “Procedure to determine the Specific Absorption Rate (SAR) for hand-held devices used in close proximity of the ear (frequency range of 300 MHz to 3 GHz)”

IEC-62209 “Human exposure to radio frequency fields from hand-held and body-mounted wireless communication devices – Human models, instrumentation, and procedures”

Part 2 *Draft*: “Procedure to determine the Specific Absorption Rate (SAR) for hand-held devices used in close proximity of the ear (frequency range of 30 MHz to 6 GHz)”

Conditions

Ambient Temperature of the Laboratory: 22 °C +/- 0.5°C

Temperature of the Tissue: 20 °C +/- 0.5°C

This was a recalibration.

Dipole Calibration uncertainty

The calibration uncertainty for the dipole is made up of various parameters presented below.

Mechanical	1%
Positioning Error	1.22%
Electrical	1.7%
Tissue	2.2%
Dipole Validation	2.2%
TOTAL	8.32% (16.64% K=2)

Dipole Calibration Results

Mechanical Verification

APREL Length	APREL Height	Measured Length	Measured Height
23.6 mm	14.0 mm	23.4 mm	15.4 mm

Tissue Validation

Body Tissue 5200 MHz	Measured
Dielectric constant, ϵ_r	47.16
Conductivity, σ [S/m]	5.14

Electrical Calibration

Test	Result
S11 R/L	-23.67 dB
SWR	1.14 U
Impedance	57.17 Ω

The Following Graphs are the results as displayed on the Vector Network Analyzer.

S11 Parameter Return Loss

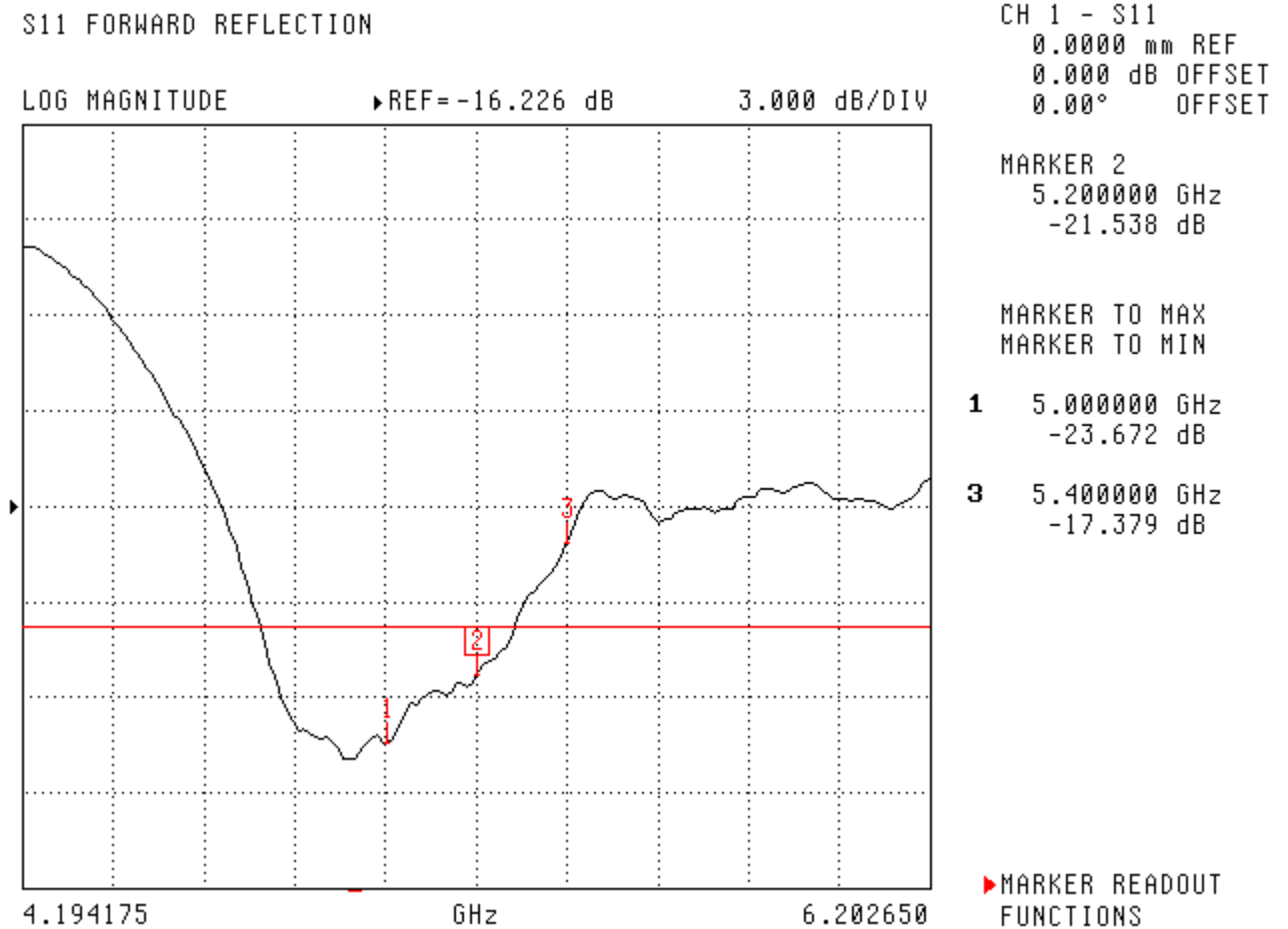

SWR

S11 FORWARD REFLECTION

SWR

REF=1.735 U

200.000 mU/DIV

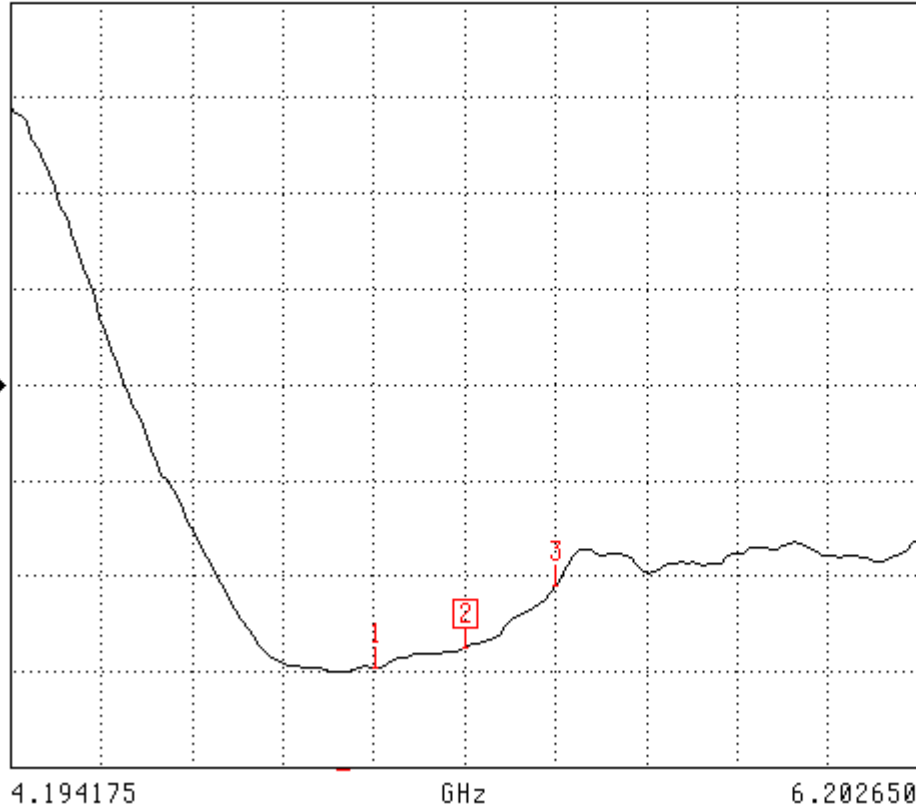

CH 1 - S11

0.0000 mm REF

0.000 dB OFFSET

0.00° OFFSET

MARKER 2

5.200000 GHz

1.183 U

MARKER TO MAX

MARKER TO MIN

1 5.000000 GHz

1.140 U

3 5.400000 GHz

1.313 U

MARKER READOUT FUNCTIONS

Smith Chart Dipole Impedance

S11 FORWARD REFLECTION
IMPEDANCE

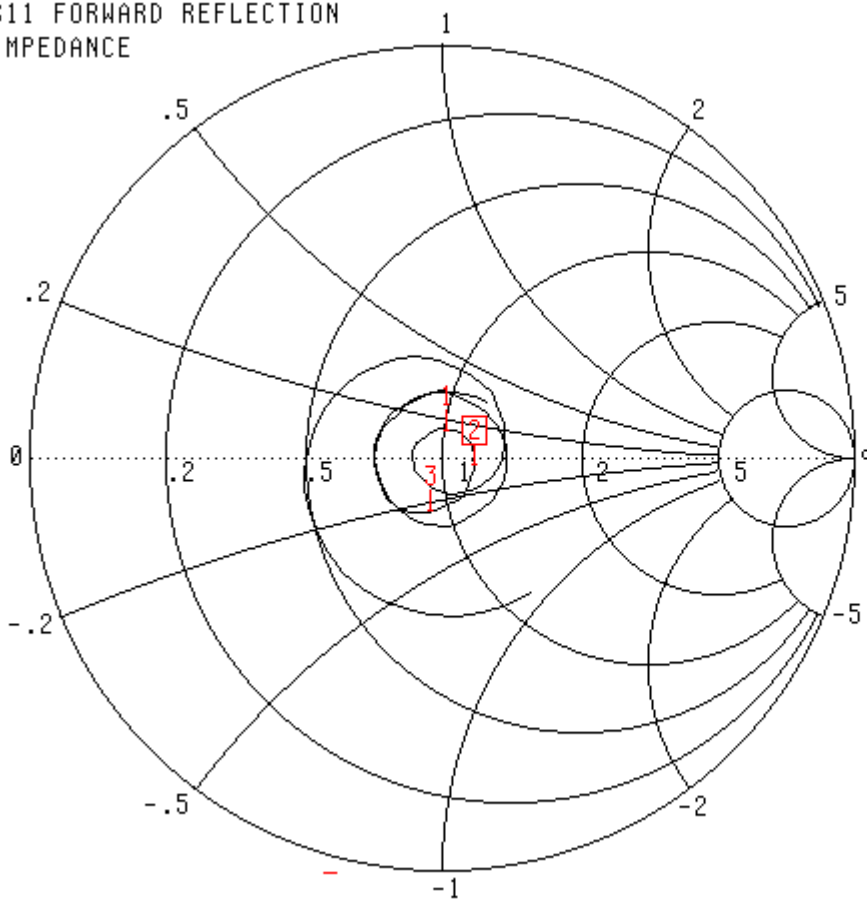

CH 1 - S11
0.0000 mm REF
0.000 dB OFFSET
0.00° OFFSET

MARKER 2
5.200000 GHz
58.753 Ω
-2.505 jΩ

MARKER TO MAX
MARKER TO MIN

1	5.000000 GHz	51.171 Ω	6.531 jΩ
3	5.400000 GHz	45.966 Ω	-12.434 jΩ

▶ MARKER READOUT
FUNCTIONS

NCL Calibration Laboratories

Division of APREL Laboratories.

Test Equipment

The test equipment used during Probe Calibration, manufacturer, model number and, current calibration status are listed and located on the main APREL server R:\NCL\Calibration Equipment\Instrument List May 2011.

NCL CALIBRATION LABORATORIES

Calibration File No: DC-1402
Project Number: ISL-D5800-cal-5641

CERTIFICATE OF CALIBRATION

It is certified that the equipment identified below has been calibrated in the
NCL CALIBRATION LABORATORIES by qualified personnel following recognized
procedures and using transfer standards traceable to NRC/NIST.

ISL Body Validation Dipole

Manufacturer: APREL Laboratories

Part number: ALS-D-5800-S-2

Frequency: 5800 MHz

Serial No: 5800-240-00852

Customer: ISL

Calibrated: 25th January, 2012
Released on: 25th January, 2012

This Calibration Certificate is Incomplete Unless Accompanied with the Calibration Results Summary

Released By: _____



Art Brennan, Quality Manager

NCL CALIBRATION LABORATORIES

Suite 102, 303 Terry Fox Dr,
OTTAWA, ONTARIO
CANADA K2K 3J1

Division of APREL Lab.
TEL: (613) 435-8300
FAX: (613) 435-8306

Conditions

Dipole 5800-240-00852 was a re-calibration.

Ambient Temperature of the Laboratory: 22 °C +/- 0.5°C
Temperature of the Tissue: 21 °C +/- 0.5°C

We the undersigned attest that to the best of our knowledge the calibration of this subject has been accurately conducted and that all information contained within the results pages have been reviewed for accuracy.



Art Brennan, Quality Manager



Constantin Teodorian, Test Engineer

Calibration Results Summary

The following results relate the Calibrated Dipole and should be used as a quick reference for the user.

Mechanical Dimensions

Length: 21.6 mm
Height: 12.6 mm

Electrical Specification

S11 R/L	-17.11 dB
SWR	1.32 U
Impedance	49.33 Ω

System Validation Results

Frequency	1 Gram	10 Gram	Peak
5800 MHz	59.32	20.12	173.14

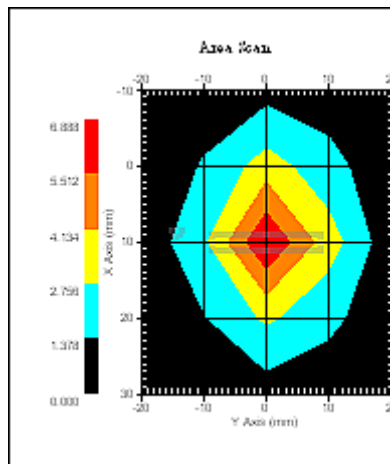

Introduction

This Calibration Report has been produced in line with the SSI Dipole Calibration Procedure SSI-TP-018-ALSAS. The results contained within this report are for Validation Dipole 235-00801. The calibration routine consisted of a three-step process. Step 1 was a mechanical verification of the dipole to ensure that it meets the mechanical specifications. Step 2 was an Electrical Calibration for the Validation Dipole, where the SWR, Impedance, and the Return loss were assessed. Step 3 involved a System Validation using the ALSAS-10U, along with APREL E-030 130 MHz to 26 GHz E-Field Probe Serial Number 215.

References

SSI-TP-018-ALSAS Dipole Calibration Procedure

SSI-TP-016 Tissue Calibration Procedure

IEEE 1528 “Recommended Practice for Determining the Peak Spatial-Average Specific Absorption Rate (SAR) in the Human Body Due to Wireless Communications Devices: Experimental Techniques”

IEC-62209 “Human exposure to radio frequency fields from hand-held and body-mounted wireless communication devices – Human models, instrumentation, and procedures”

Part 1: “Procedure to determine the Specific Absorption Rate (SAR) for hand-held devices used in close proximity of the ear (frequency range of 300 MHz to 3 GHz)”

IEC-62209 “Human exposure to radio frequency fields from hand-held and body-mounted wireless communication devices – Human models, instrumentation, and procedures”

Part 2 *Draft*: “Procedure to determine the Specific Absorption Rate (SAR) for hand-held devices used in close proximity of the ear (frequency range of 30 MHz to 6 GHz)”

Conditions

Ambient Temperature of the Laboratory: 22 °C +/- 0.5°C

Temperature of the Tissue: 20 °C +/- 0.5°C

This was a recalibration.

Dipole Calibration uncertainty

The calibration uncertainty for the dipole is made up of various parameters presented below.

Mechanical	1%
Positioning Error	1.22%
Electrical	1.7%
Tissue	2.2%
Dipole Validation	2.2%
TOTAL	8.32% (16.64% K=2)

Dipole Calibration Results

Mechanical Verification

APREL Length	APREL Height	Measured Length	Measured Height
21.6 mm	12.6 mm	21.6 mm	14.7 mm

Tissue Validation

Body Tissue 5800 MHz	Measured
Dielectric constant, ϵ_r	45.8
Conductivity, σ [S/m]	6.18

Electrical Calibration

Test	Result
S11 R/L	-17.11 dB
SWR	1.32 U
Impedance	49.33 Ω

The Following Graphs are the results as displayed on the Vector Network Analyzer.

S11 Parameter Return Loss

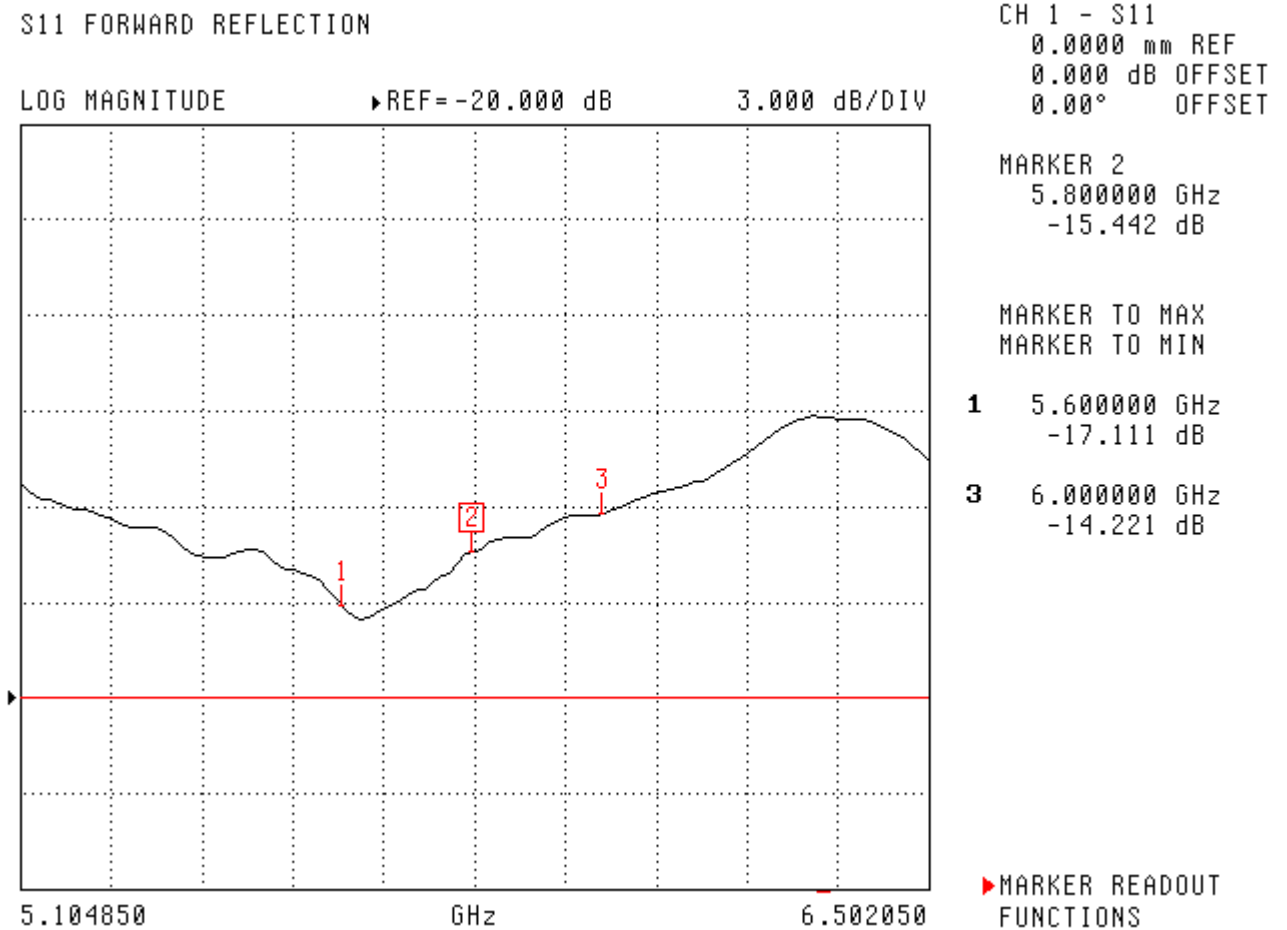

SWR

S11 FORWARD REFLECTION

SWR

REF=1.735 U

200.000 mU/DIV

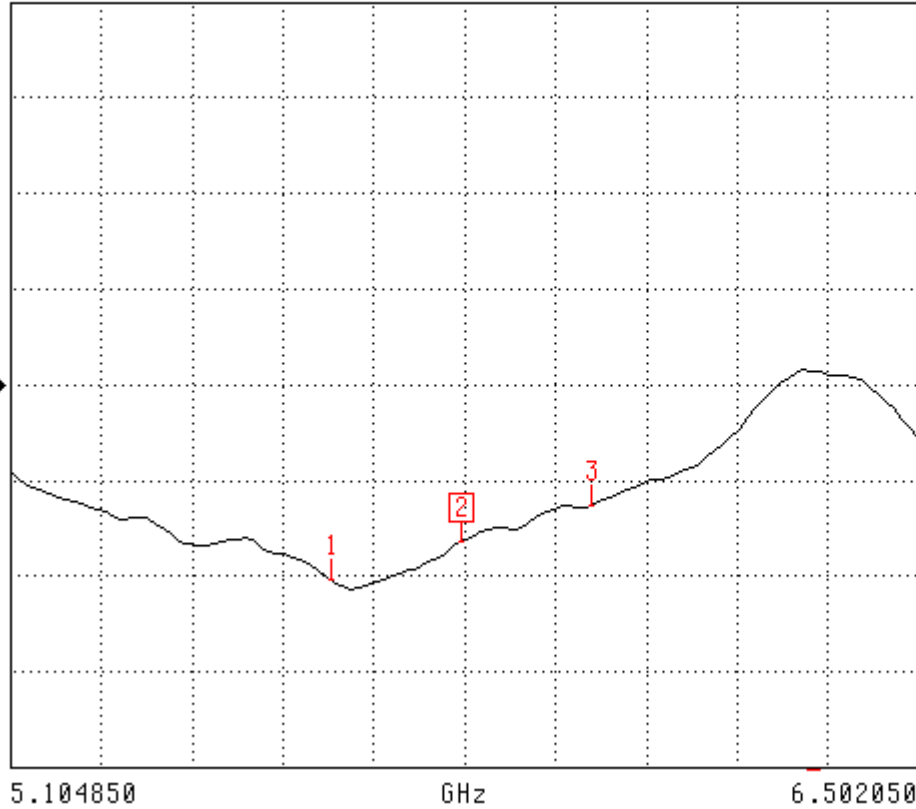

CH 1 - S11

0.0000 mm REF

0.000 dB OFFSET

0.00° OFFSET

MARKER 2

5.800000 GHz

1.407 U

MARKER TO MAX

MARKER TO MIN

1 5.600000 GHz

1.324 U

3 6.000000 GHz

1.483 U

MARKER READOUT FUNCTIONS

Smith Chart Dipole Impedance

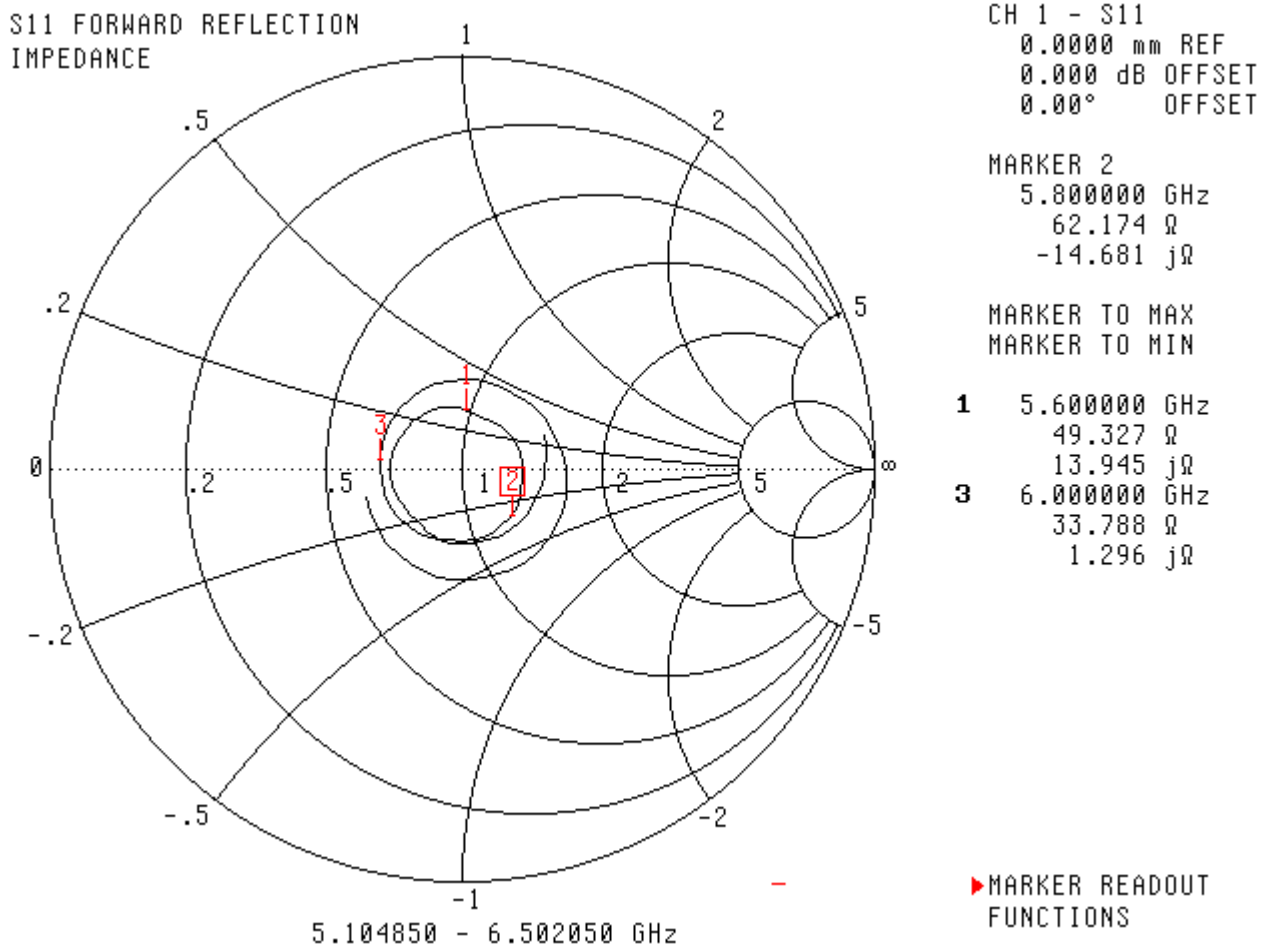

NCL Calibration Laboratories

Division of APREL Laboratories.

Test Equipment

The test equipment used during Probe Calibration, manufacturer, model number and, current calibration status are listed and located on the main APREL server R:\NCL\Calibration Equipment\Instrument List May 2011.