



Prüfbericht-Nr.: <i>Test report no.:</i>	CN21ADTW (FCC-SAR) 001	Auftrags-Nr.: <i>Order no.:</i>	238518076	Seite 1 von 34 Page 1 of 34
Kunden-Referenz-Nr.: <i>Client reference no.:</i>	N/A	Auftragsdatum: <i>Order date:</i>	2021-07-23	
Auftraggeber: <i>Client:</i>	Edimax Technology Co., Ltd. No.278, Xinhu 1st Rd., Neihu Dist., Taipei City, Taiwan			
Prüfgegenstand: <i>Test item:</i>	1T1R 11n Wireless LAN with Bluetooth USB Adapter			
Bezeichnung / Typ-Nr.: <i>Identification / Type no.:</i>	EW-7611ULB V2.0A, EW-7611ULB V2			
Auftrags-Inhalt: <i>Order content:</i>	Test Report for FCC SAR			
Prüfgrundlage: <i>Test specification:</i>	FCC 47 CFR §2.1093 IEEE Std 1528-2013 Published RF exposure KDB procedures			
Wareneingangsdatum: <i>Date of sample receipt:</i>	2021-07-26			
Prüfmuster-Nr.: <i>Test sample no.:</i>	A003098476-002			
Prüfzeitraum: <i>Testing period:</i>	2021-08-14			
Ort der Prüfung: <i>Place of testing:</i>	EMC/RF Taipei Testing Site			
Prüflaboratorium: <i>Testing laboratory:</i>	Taipei Testing Laboratories			
Prüfergebnis*: <i>Test result*:</i>	Pass			
überprüft von: <i>compiled by:</i>		genehmigt von: <i>authorized by:</i>		
Datum: <i>Date:</i>	2021-09-03	Ausstellungsdatum: <i>Issue date:</i>	2021-09-03	
Stellung / Position:	David Huang Project Manager	Stellung / Position:	Ryan Chen Senior Project Manager	
Sonstiges / Other:	The main model is EW-7611ULB V2.0A, and the series model is EW-7611ULB V2. Both models are electrically identical, different model names are for marketing purpose.			
Zustand des Prüfgegenstandes bei Anlieferung: <i>Condition of the test item at delivery:</i>	Prüfmuster vollständig und unbeschädigt <i>Test item complete and undamaged</i>			
* Legende:	1 = sehr gut P(ass) = entspricht o.g. Prüfgrundlage(n)	2 = gut F(ail) = entspricht nicht o.g. Prüfgrundlage(n)	3 = befriedigend 4 = ausreichend N/A = nicht anwendbar	5 = mangelhaft N/T = nicht getestet
* Legend:	1 = very good P(ass) = passed a.m. test specification(s)	2 = good F(ail) = failed a.m. test specification(s)	3 = satisfactory 4 = sufficient N/A = not applicable	5 = poor N/T = not tested
Dieser Prüfbericht bezieht sich nur auf das o.g. Prüfmuster und darf ohne Genehmigung der Prüfstelle nicht auszugsweise vervielfältigt werden. Dieser Bericht berechtigt nicht zur Verwendung eines Prüfzeichens. <i>This test report only relates to the a. m. test sample. Without permission of the test center this test report is not permitted to be duplicated in extracts. This test report does not entitle to carry any test mark.</i>				

v05

CONTENTS

HISTORY OF THIS TEST REPORT	4
1. GENERAL INFORMATION	5
1.1 STATEMENT OF COMPLIANCE	5
1.2 EQUIPMENT UNDER TEST (EUT) INFORMATION	6
1.2.1 GENERAL INFORMATION	6
1.2.2 WIRELESS TECHNOLOGIES	6
1.3 MAXIMUM CONDUCTED POWER	7
2. TEST SITES	8
2.1 TEST LABORATORY	8
2.2 TEST FACILITIES	8
2.3 LIST OF TEST AND MEASUREMENT INSTRUMENTS	9
3. MEASUREMENT UNCERTAINTY	10
4. TEST SPECIFICATION, METHODS AND PROCEDURES.....	13
5. RF EXPOSURE LIMITS.....	14
5.1 UNCONTROLLED ENVIRONMENT	14
5.2 CONTROLLED ENVIRONMENT.....	14
6. SAR MEASUREMENT SYSTEM.....	15
6.1 DEFINITION OF SPECIFIC ABSORPTION RATE (SAR).....	15
6.2 SPEAG DASY SYSTEM.....	15
6.2.1 ROBOT.....	16
6.2.2 PROBES	17
6.2.3 DATA ACQUISITION ELECTRONICS (DAE).....	17
6.2.4 PHANTOMS.....	18
6.2.5 DEVICE HOLDER	19
6.2.6 SYSTEM VALIDATION DIPOLES	19
6.2.7 TISSUE SIMULATING LIQUIDS	20
7. SAR MEASUREMENT PROCEDURE	22
7.1 AREA & ZOOM SCAN PROCEDURE	22
7.2 VOLUME SCAN PROCEDURE	22
7.3 POWER DRIFT MONITORING	23
7.4 SPATIAL PEAK SAR EVALUATION.....	23
7.5 SAR AVERAGED METHODS	23
8. SAR MEASUREMENT EVALUATION	24
8.1 EUT CONFIGURATION AND SETTING	24
8.2 EUT TESTING POSITION.....	26
8.2.1 BODY EXPOSURE CONDITIONS	26
8.2.2 ANTENNA LOCATION.....	26
8.2.3 SAR TEST EXCLUSION EVALUATIONS.....	27

8.3	SIMULTANEOUS TRANSMISSION POSSIBILITIES	27
8.4	TISSUE VERIFICATION	28
8.5	SYSTEM VALIDATION.....	29
	SYSTEM CHECK PROCEDURE.....	29
8.6	SYSTEM VERIFICATION.....	30
8.7	MAXIMUM OUTPUT POWER.....	31
8.7.1	MEASURED CONDUCTED POWER RESULT	31
8.8	SAR TESTING RESULTS.....	32
8.8.1	SAR TEST REDUCTION CONSIDERATIONS	32
8.8.2	SAR RESULTS FOR BODY EXPOSURE CONDITION (SEPARATION DISTANCE IS 0.5CM GAP).....	33
8.8.3	SAR MEASUREMENT VARIABILITY.....	33
9.	APPENDIXES	34

APPENDIX A – SAR PLOTS OF SYSTEM VERIFICATION

APPENDIX B – SAR PLOTS OF SAR MEASUREMENT

APPENDIX C – CALIBRATION CERTIFICATE FOR PROBE AND DIPOLE

APPENDIX D – PHOTOGRAPHS OF THE TEST SET-UP

HISTORY OF THIS TEST REPORT

Report No.	Description	Date Issued
CN21ADTW (FCC-SAR) 001	Original Release	2021-09-03

1. General Information

1.1 Statement of Compliance

The maximum results of Specific Absorption Rate (SAR) found during testing for the EUT are as follows:

Equipment Class	Operating Mode	Highest Reported Body SAR _{1g} (0.5 cm Gap) (W/kg)
DTS	2.4G WLAN	1.314
DSS	Bluetooth	N/A

Note:

The maximum results of Specific Absorption Rate (SAR) found during testing for the EUT are as follows: This device is in compliance with Specific Absorption Rate (SAR) for general population/uncontrolled exposure limits (1.6W/kg as averaged over any 1 gram of tissue; 10-gram SAR for Product Specific 10g SAR, limit: 4.0W/kg) specified in FCC 47 CFR part 2 (2.1093) and ANSI/IEEE C95.1-1992, and had been tested in accordance with the measurement methods and procedures specified in IEEE 1528-2013 and FCC KDB publications.

1.2 Equipment Under Test (EUT) Information

1.2.1 General Information

EUT Type	1T1R 11n Wireless LAN with Bluetooth USB Adapter
Model Name	EW-7611ULB V2.0A, EW-7611ULB V2
FCC ID	NDD9576112101
Antenna Type	PIFA Antenna
Antenna Gain:	1.6 dBi
EUT Stage	Identical Prototype

1.2.2 Wireless Technologies

Tx Frequency Bands (Unit: MHz)	WLAN 2.4GHz Band: 2412 MHz ~ 2462 MHz Bluetooth: 2402 MHz ~ 2480 MHz
Uplink Modulations	802.11b: DSSS 802.11g/n: OFDM Bluetooth: GFSK, $\pi/4$ -DQPSK, 8-DPSK Bluetooth LE: GFSK

1.3 Maximum Conducted Power

The maximum conducted average power (Unit: dBm) including tune-up tolerance is shown as below.

Mode	2.4G WLAN
802.11b	22.0
802.11g	21.0
802.11n HT20	22.5
802.11n HT40	18.5

Mode	2.4G Bluetooth
GFSK	9.5
$\pi/4$ -DQPSK	9.5
8DPSK	9.5
LE	9.5

2. Test Sites

2.1 Test Laboratory

Taipei Testing Laboratories

11F., No. 758, Sec. 4, Bade Rd., Songshan Dist., Taipei City 105 Taiwan (R.O.C.)

2.2 Test Facilities

Taipei Testing Laboratories

No. 458-18, Sec. 2, Fenliao Rd., Linkou Dist., New Taipei City 244 Taiwan (R.O.C.)

The tests at the test sites have been conducted under the supervision of a TÜV engineer.

2.3 List of Test and Measurement Instruments

Equipment	Manufacturer	Model	SN	Cal. Date	Cal. Interval
E-field probes	SPEAG	EX3DV4	7400	Apr.27,2021	1 Year
Data Acquisition Electronics	SPEAG	DAE4	855	Apr.28,2021	1 Year
System Validation Dipole	SPEAG	D2450V2	804	Mar.17,2021	1 Year
Power Meter	Anritsu	ML2495A	1901008	Mar.24,2021	1 Year
Power Sensor	Anritsu	MA2411B	1725269	Mar.24,2021	1 Year
Power Sensor	R&S	NRP33S	101622	Mar.19,2021	1 Year
Signal Analyzer	R&S	FSV40	101513	May.27,2021	1 Year
Signal Generator	R&S	SMB100A03	181334	Jan.29,2021	1 Year
Wireless Tester	R&S	CMW500	166923	Feb.17,2021	1 Year
Directional coupler	Fairview Microwave	FMCP1025-20	A000553136-001	N/A	N/A
Dielectric Assessment Kit	SPEAG	DAK-3.5	1292	N/A	N/A
Twin Sam Phantom	SPEAG	Twin Sam Phantom	TP-1467	N/A	N/A
Power Amplifier	EMCI	EMC2830P	980352	N/A	N/A

3. Measurement Uncertainty

The component of uncertainty may generally be categorized according to the methods used to evaluate them. The evaluation of uncertainty by the statistical analysis of a series of observations is termed a Type A evaluation of uncertainty. The evaluation of uncertainty by means other than the statistical analysis of a series of observation is termed a Type B evaluation of uncertainty. Each component of uncertainty, however evaluated, is represented by an estimated standard deviation, termed standard uncertainty, which is determined by the positive square root of the estimated variance.

A Type A evaluation of standard uncertainty may be based on any valid statistical method for treating data. This includes calculating the standard deviation of the mean of a series of independent observations; using the method of least squares to fit a curve to the data in order to estimate the parameter of the curve and their standard deviations; or carrying out an analysis of variance in order to identify and quantify random effects in certain kinds of measurement.

A type B evaluation of standard uncertainty is typically based on scientific judgment using all of the relevant information available. These may include previous measurement data, experience, and knowledge of the behavior and properties of relevant materials and instruments, manufacture's specification, data provided in calibration reports and uncertainties assigned to reference data taken from handbooks. Broadly speaking, the uncertainty is either obtained from an outdoor source or obtained from an assumed distribution, such as the normal distribution, rectangular or triangular distributions indicated in table below.

Uncertainty Distributions	Normal	Rectangular	Triangular	U-Shape
Multi-plying Factor(a)	1/k(b)	1/√3	1/√6	1/√2

- (a) standard uncertainty is determined as the product of the multiplying factor and the estimated range of variations in the measured quantity
- (b) κ is the coverage factor

Standard Uncertainty for Assumed Distribution

The combined standard uncertainty of the measurement result represents the estimated standard deviation of the result. It is obtained by combining the individual standard uncertainties of both Type A and Type B evaluation using the usual "root-sum-squares" (RSS) methods of combining standard deviations by taking the positive square root of the estimated variances.

Expanded uncertainty is a measure of uncertainty that defines an interval about the measurement result within which the measured value is confidently believed to lie. It is obtained by multiplying the combined standard uncertainty by a coverage factor. Typically, the coverage factor ranges from 2 to 3. Using a coverage factor allows the true value of a measured quantity to be specified with a defined probability within the specified uncertainty range. For purpose of this document, a coverage factor two is used, which corresponds to confidence interval of about 95 %. The DASY uncertainty Budget is shown in the following tables.

Source of Uncertainty	Tolerance (± %)	Probability Distribution	Divisor	C _i (1g)	C _i (10g)	Standard Uncertainty (1g)	Standard Uncertainty (10g)	V _i V _{eff}
Measurement System								
Probe Calibration	6	Normal	1	1	1	±6.0%	±6.0%	∞
Axial Isotropy	4.7	Rectangular	√3	0.7	0.7	±1.9%	±1.9%	∞
Hemispherical Isotropy	9.6	Rectangular	√3	0.7	0.7	±3.9%	±3.9%	∞
Boundary Effects	1	Rectangular	√3	1	1	±0.6%	±0.6%	∞
Linearity	4.7	Rectangular	√3	1	1	±2.7%	±2.7%	∞
Detection Limits	1	Rectangular	√3	1	1	±0.58%	±0.58%	∞
Modulation Response	2.4	Rectangular	√3	1	1	±1.4%	±1.4%	∞
Readout Electronics	0.3	Normal	1	1	1	±0.3%	±0.3%	∞
Response Time	0.8	Rectangular	√3	1	1	±0.5%	±0.5%	∞
Integration Time	2.6	Rectangular	√3	1	1	±1.5%	±1.5%	∞
RF Ambient – Noise	3	Rectangular	√3	1	1	±1.7%	±1.7%	∞
RF Ambient – Reflections	3	Rectangular	√3	1	1	±1.7%	±1.7%	∞
Probe Positioner	0.4	Rectangular	√3	1	1	±0.23%	±0.23%	∞
Probe Positioning	2.9	Rectangular	√3	1	1	±1.67%	±1.67%	∞
Max. SAR Evaluation	2	Rectangular	√3	1	1	±1.2%	±1.2%	∞
Test Sample Related								
Device Positioning	2.3 / 2.6	Normal	1	1	1	±2.3%	±2.6%	145
Device Holder	3.2 / 2.8	Normal	1	1	1	±3.2%	±2.8%	5
Power Drift	5	Rectangular	√3	1	1	±2.9%	±2.9%	∞
Power Scaling	0	Rectangular	√3	1	1	±0.0%	±0.0%	∞
Phantom and Setup								
Phantom Uncertainty	6.1	Rectangular	√3	1	1	±3.81%	±3.52%	∞
SAR correction	1.9	Rectangular	√3	1	0.84	±1.10%	±1.10%	∞
Liquid Conductivity (Meas.)	2.4	Normal	1	0.78	0.71	±1.08%	±1.08%	∞
Liquid Permittivity (Meas.)	2.4	Normal	1	0.26	0.26	±0.36%	±0.36%	∞
Temp. unc. - Conductivity	3.4	Rectangular	√3	0.78	0.71	±1.53%	±1.53%	∞
Temp. unc. - Permittivity	0.4	Rectangular	√3	0.23	0.26	±0.05%	±0.05%	∞
Combined Standard Uncertainty (K = 1)						±10.9%	±10.85%	361
Expanded Uncertainty (K = 2)						±21.79%	±21.71%	

Uncertainty budget for frequency range 300 MHz to 3 GHz

Source of Uncertainty	Tolerance (± %)	Probability Distribution	Divisor	C _i (1g)	C _i (10g)	Standard Uncertainty (1g)	Standard Uncertainty (10g)	V _i V _{eff}
Measurement System								
Probe Calibration	6.55	Normal	1	1	1	± 6.55 %	± 6.55 %	∞
Axial Isotropy	4.7	Rectangular	√3	0.7	0.7	±1.9%	±1.9%	∞
Hemispherical Isotropy	9.6	Rectangular	√3	0.7	0.7	±3.9%	±3.9%	∞
Boundary Effects	2	Rectangular	√3	1	1	±1.2%	±1.2%	∞
Linearity	4.7	Rectangular	√3	1	1	±2.7%	±2.7%	∞
Detection Limits	0.25	Rectangular	√3	1	1	±0.1%	±0.1%	∞
Modulation Response	2.4	Rectangular	√3	1	1	±1.4%	±1.4%	∞
Readout Electronics	0.3	Normal	1	1	1	±0.3%	±0.3%	∞
Response Time	0.8	Rectangular	√3	1	1	±0.0%	±0.0%	∞
Integration Time	1.7	Rectangular	√3	1	1	±1.0%	±1.0%	∞
RF Ambient – Noise	3	Rectangular	√3	1	1	±1.7%	±1.7%	∞
RF Ambient – Reflections	3	Rectangular	√3	1	1	±1.7%	±1.7%	∞
Probe Positioner	0.02	Rectangular	√3	1	1	±0.2%	±0.2%	∞
Probe Positioning	0.4	Rectangular	√3	1	1	±3.9%	±3.9%	∞
Max. SAR Evaluation	4	Rectangular	√3	1	1	±2.3%	±2.3%	∞
Test Sample Related								
Device Positioning	2.1 / 2.5	Normal	1	1	1	±2.1%	±2.5%	145
Device Holder	3.3 / 2.9	Normal	1	1	1	±3.3%	±2.9%	5
Power Drift	5	Rectangular	√3	1	1	±2.9%	±2.9%	∞
Power Scaling	0	Rectangular	√3	1	1	±0.0%	±0.0%	∞
Phantom and Setup								
Phantom Uncertainty	6.6	Rectangular	√3	1	1	±3.81%	±3.81%	∞
SAR correction	1.9	Rectangular	√3	1	0.84	±1.10%	±0.92%	∞
Liquid Conductivity (Meas.)	2.4	Normal	1	0.78	0.71	±1.08%	±0.98%	∞
Liquid Permittivity (Meas.)	2.4	Normal	1	0.26	0.26	±0.36%	±0.36%	∞
Temp. unc. - Conductivity	3.4	Rectangular	√3	0.78	0.71	±1.53%	±1.4%	∞
Temp. unc. - Permittivity	0.4	Rectangular	√3	0.23	0.26	±0.05%	±0.06%	∞
Combined Standard Uncertainty (K = 1)						±12.09%	±12.02%	361
Expanded Uncertainty (K = 2)						±24.18%	±24.05%	

Uncertainty budget for frequency range 3 GHz to 6 GHz

Per KDB865664 D01 SAR Measurement 100 MHz to 6 GHz, when the highest measured 1-g SAR within a frequency band is < 1.5 W/kg, the extensive SAR measurement uncertainty analysis described in IEEE Std 1528-2013 is not required in SAR reports submitted for equipment approval. The equivalent ratio (1.5/1.6) is applied to extremity and occupational exposure conditions.

4. Test Specification, Methods and Procedures

The tests documented in this report were performed in accordance with FCC 47 CFR §2.1093, IEEE STD 1528-2013, the following FCC Published RF exposure KDB procedures & manufacturer KDB inquiries:

- KDB 865664 D01 SAR Measurement 100 MHz to 6 GHz v01r04
- KDB 865664 D02 RF Exposure Reporting v01r02
- KDB 248227 D01 802.11 Wi-Fi SAR v02r02
- KDB 447498 D01 General RF Exposure Guidance v06
- KDB 447498 D02 SAR Procedures for Dongle Xmtr v02r01

In addition to the above, the following information was used:

- [TCB workshop](#) October, 2014; Page 36, RF Exposure Procedures Update (Overlapping LTE Bands)
- [TCB workshop](#) October, 2014; Page 37, LTE Considerations (LTE Band 41 Test Channels)

5. RF Exposure Limits

5.1 Uncontrolled Environment

Uncontrolled Environments are defined as locations where there is the exposure of individuals who have no knowledge or control of their exposure. The general population/uncontrolled exposure limits are applicable to situations in which the general public may be exposed or in which persons who are exposed as a consequence of their employment may not be made fully aware of the potential for exposure or cannot exercise control over their exposure. Members of the general public would come under this category when exposure is not employment-related; for example, in the case of a wireless transmitter that exposes persons in its vicinity.

5.2 Controlled Environment

Controlled Environments are defined as locations where there is exposure that may be incurred by persons who are aware of the potential for exposure, (i.e. as a result of employment or occupation). In general, occupational/controlled exposure limits are applicable to situations in which persons are exposed as a consequence of their employment, who have been made fully aware of the potential for exposure and can exercise control over their exposure. The exposure category is also applicable when the exposure is of a transient nature due to incidental passage through a location where the exposure levels may be higher than the general population/uncontrolled limits, but the exposed person is fully aware of the potential for exposure and can exercise control over his or her exposure by leaving the area or by some other appropriate means.

Limits for Occupational/Controlled Exposure (W/kg)

Whole-Body	Partial-Body	Hands, Wrists, Feet and Ankles
0.4	8.0	20.0

Limits for General Population/Uncontrolled Exposure (W/kg)

Whole-Body	Partial-Body	Hands, Wrists, Feet and Ankles
0.08	1.6	4.0

Whole-Body SAR is averaged over the entire body, partial-body SAR is averaged over any 1 gram of tissue defined as a tissue volume in the shape of a cube. SAR for hands, wrists, feet and ankles is average over any 10 grams of tissue defined as a tissue volume in the shape of a cube.

6. SAR Measurement System

6.1 Definition of Specific Absorption Rate (SAR)

SAR is related to the rate at which energy is absorbed per unit mass in an object exposed to a radio field. The SAR distribution in a biological body is complicated and is usually carried out by experimental techniques or numerical modeling. The standard recommends limits for two tiers of groups, occupational/controlled and general population/uncontrolled, based on a person's awareness and ability to exercise control over his or her exposure. In general, occupational/controlled exposure limits are higher than the limits for general population/uncontrolled.

The SAR definition is the time derivative (rate) of the incremental energy (dW) absorbed by (dissipated in) an incremental mass (dm) contained in a volume element (dv) of a given density (ρ). The equation description is as below:

$$\text{SAR} = \frac{d}{dt} \left(\frac{dW}{dm} \right) = \frac{d}{dt} \left(\frac{dW}{\rho dv} \right)$$

SAR is expressed in units of Watts per kilogram (W/kg)

SAR measurement can be related to the electrical field in the tissue by

$$\text{SAR} = \frac{\sigma |E|^2}{\rho}$$

Where: σ is the conductivity of the tissue, ρ is the mass density of the tissue and E is the RMS electrical field strength.

6.2 SPEAG DASY System

DASY system consists of high precision robot, probe alignment sensor, phantom, robot controller, controlled measurement server and near-field probe. The robot includes six axes that can move to the precision position of the DASY5 software defined. The DASY software can define the area that is detected by the probe. The robot is connected to controlled box. Controlled measurement server is connected to the controlled robot box. The DAE includes amplifier, signal multiplexing, AD converter, offset measurement and surface detection. It is connected to the Electro-optical coupler (ECO). The ECO performs the conversion from the optical into digital electric signal of the DAE and transfers data to the PC.

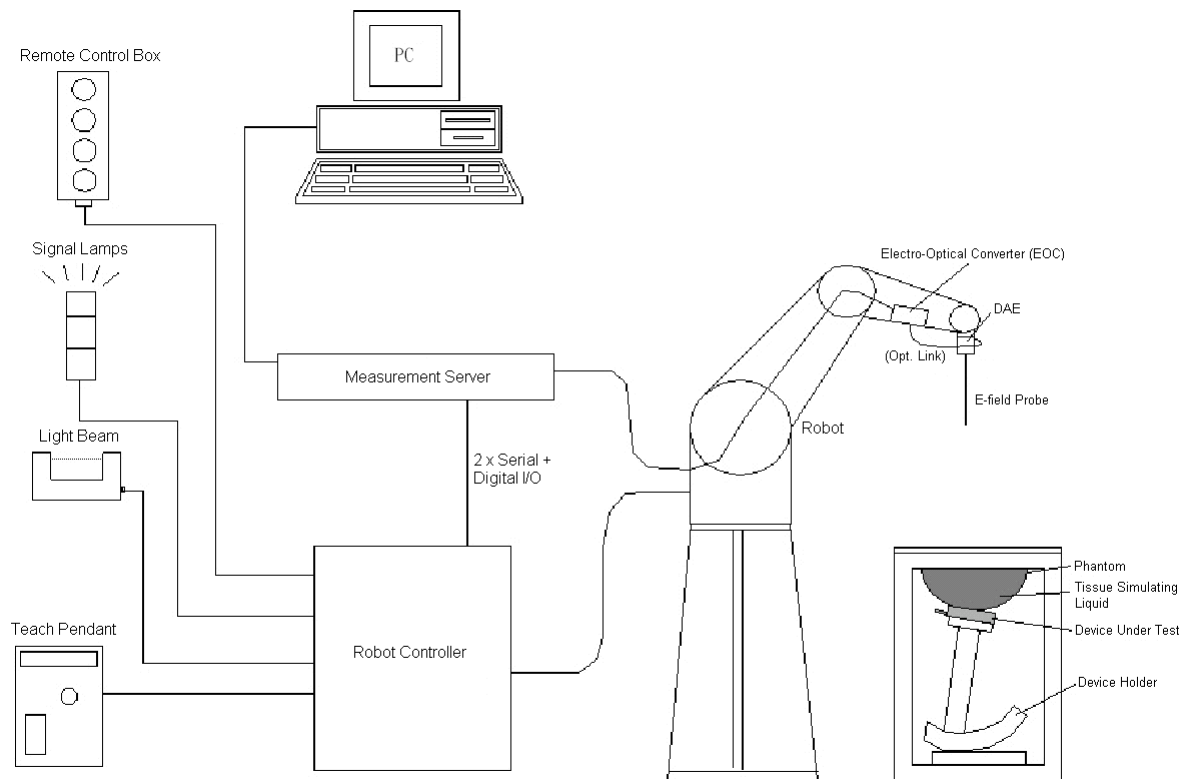

DASY System Setup

6.2.1 Robot

The DASY system uses the high precision robots from Stäubli SA (France). For the 6-axis controller system, the robot controller version (DASY5: CS8c) from Stäubli is used. The Stäubli robot series have many features that are important for our application:

- High precision (repeatability ± 0.035 mm)
- High reliability (industrial design)
- Jerk-free straight movements
- Low ELF interference (the closed metallic construction shields against motor control fields)

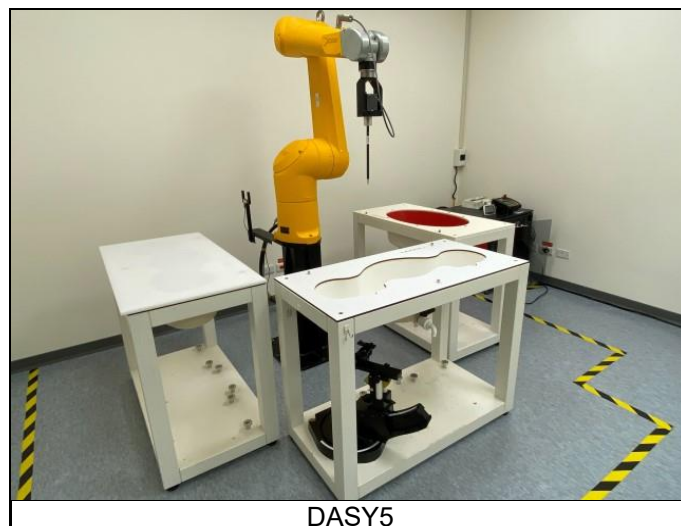

DASY5

6.2.2 Probes

The SAR measurement is conducted with the dosimetric probe. The probe is specially designed and calibrated for use in liquid with high permittivity. The dosimetric probe has special calibration in liquid at different frequency.

Model	EX3DV4	
Construction	Symmetrical design with triangular core. Built-in shielding against static charges. PEEK enclosure material (resistant to organic solvents, e.g., DGBE).	
Frequency	10 MHz to 6 GHz Linearity: ± 0.2 dB	
Directivity	± 0.3 dB in HSL (rotation around probe axis) ± 0.5 dB in tissue material (rotation normal to probe axis)	
Dynamic Range	10 μ W/g to 100 mW/g Linearity: ± 0.2 dB (noise: typically < 1 μ W/g)	
Dimensions	Overall length: 337 mm (Tip: 20 mm) Tip diameter: 2.5 mm (Body: 12 mm) Typical distance from probe tip to dipole centers: 1 mm	

6.2.3 Data Acquisition Electronics (DAE)

Model	DAE4	
Construction	Signal amplifier, multiplexer, A/D converter and control logic. Serial optical link for communication with DASY embedded system (fully remote controlled). Two step probe touch detector for mechanical surface detection and emergency robot stop.	
Measurement Range	-100 to +300 mV (16 bit resolution and two range settings: 4mV, 400mV)	
Input Offset Voltage	< 5 μ V (with auto zero)	
Input Bias Current	< 50 fA	
Dimensions	60 x 60 x 68 mm	

6.2.4 Phantoms

Model	Twin SAM	
Construction	The shell corresponds to the specifications of the Specific Anthropomorphic Mannequin (SAM) phantom defined in IEEE 1528 and IEC 62209-1. It enables the dosimetric evaluation of left and right hand phone usage as well as body mounted usage at the flat phantom region. A cover prevents evaporation of the liquid. Reference markings on the phantom allow the complete setup of all predefined phantom positions and measurement grids by teaching three points with the robot.	
Material	Vinylester, glass fiber reinforced (VE-GF)	
Shell Thickness	2 ± 0.2 mm (6 ± 0.2 mm at ear point)	
Dimensions	Length: 1000 mm Width: 500 mm Height: adjustable feet	
Filling Volume	approx. 25 liters	

Model	ELI	
Construction	Phantom for compliance testing of handheld and body-mounted wireless devices in the frequency range of 30 MHz to 6 GHz. ELI is fully compatible with the IEC 62209-2 standard and all known tissue simulating liquids. ELI has been optimized regarding its performance and can be integrated into our standard phantom tables. A cover prevents evaporation of the liquid. Reference markings on the phantom allow installation of the complete setup, including all predefined phantom positions and measurement grids, by teaching three points. The phantom is compatible with all SPEAG dosimetric probes and dipoles.	
Material	Vinylester, glass fiber reinforced (VE-GF)	
Shell Thickness	2.0 ± 0.2 mm (bottom plate)	
Dimensions	Major axis: 600 mm Minor axis: 400 mm	
Filling Volume	approx. 30 liters	

6.2.5 Device Holder

Model	Mounting Device	
Construction	In combination with the Twin SAM Phantom or ELI4, the Mounting Device enables the rotation of the mounted transmitter device in spherical coordinates. Rotation point is the ear opening point. Transmitter devices can be easily and accurately positioned according to IEC, IEEE, FCC or other specifications. The device holder can be locked for positioning at different phantom sections (left head, right head, flat).	
Material	POM	

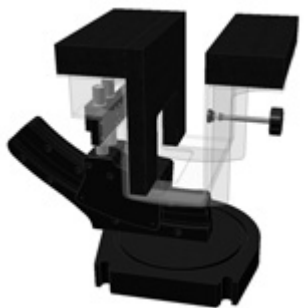
Model	Laptop Extensions Kit	
Construction	Simple but effective and easy-to-use extension for Mounting Device that facilitates the testing of larger devices according to IEC 62209-2 (e.g., laptops, cameras, etc.). It is lightweight and fits easily on the upper part of the Mounting Device in place of the phone positioner.	
Material	POM, Acrylic glass, Foam	

6.2.6 System Validation Dipoles

Model	D-Serial	
Construction	Symmetrical dipole with 1/4 balun. Enables measurement of feed point impedance with NWA. Matched for use near flat phantoms filled with tissue simulating solutions.	
Frequency	750 MHz to 5800 MHz	
Return Loss	> 20 dB	
Power Capability	> 100 W (f < 1GHz), > 40 W (f > 1GHz)	

6.2.7 Tissue Simulating Liquids

For SAR measurement of the field distribution inside the phantom, the phantom must be filled with homogeneous tissue simulating liquid to a depth of at least 15 cm. For head SAR testing, the liquid height from the ear reference point (ERP) of the phantom to the liquid top surface is larger than 15 cm. For body SAR testing, the liquid height from the center of the flat phantom to the liquid top surface is larger than 15 cm. The nominal dielectric values of the tissue simulating liquids in the phantom and the tolerance of 5% are listed.



Photo of Liquid Height for Head Position

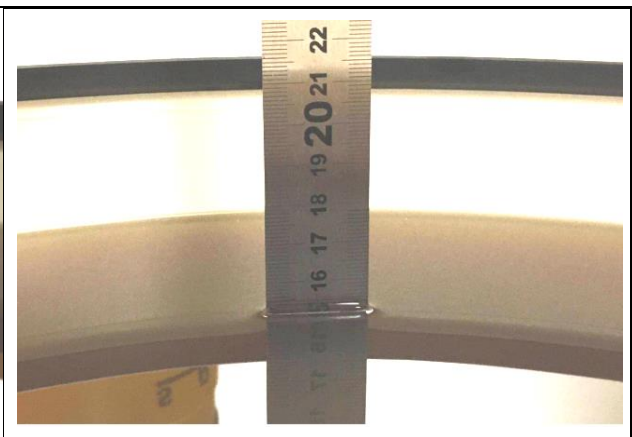

Photo of Liquid Height for Body Position

The dielectric properties of the head tissue simulating liquids are defined in IEEE 1528, and KDB 865664 D01 Appendix A. For the body tissue simulating liquids, the dielectric properties are defined in KDB 865664 D01 Appendix A. The dielectric properties of the tissue simulating liquids were verified prior to the SAR evaluation using a dielectric assessment kit and a network analyzer.

Targets of Tissue Simulating Liquid

Frequency (MHz)	Target Permittivity	Range of $\pm 5\%$	Target Conductivity	Range of $\pm 5\%$
For Head				
750	41.9	39.8 ~ 44.0	0.89	0.85 ~ 0.93
835	41.5	39.4 ~ 43.6	0.90	0.86 ~ 0.95
900	41.5	39.4 ~ 43.6	0.97	0.92 ~ 1.02
1450	40.5	38.5 ~ 42.5	1.20	1.14 ~ 1.26
1640	40.3	38.3 ~ 42.3	1.29	1.23 ~ 1.35
1750	40.1	38.1 ~ 42.1	1.37	1.30 ~ 1.44
1800	40.0	38.0 ~ 42.0	1.40	1.33 ~ 1.47
1900	40.0	38.0 ~ 42.0	1.40	1.33 ~ 1.47
2000	40.0	38.0 ~ 42.0	1.40	1.33 ~ 1.47
2300	39.5	37.5 ~ 41.5	1.67	1.59 ~ 1.75
2450	39.2	37.2 ~ 41.2	1.80	1.71 ~ 1.89
2600	39.0	37.1 ~ 41.0	1.96	1.86 ~ 2.06
3500	37.9	36.0 ~ 39.8	2.91	2.76 ~ 3.06
5200	36.0	34.2 ~ 37.8	4.66	4.43 ~ 4.89
5300	35.9	34.1 ~ 37.7	4.76	4.52 ~ 5.00
5500	35.6	33.8 ~ 37.4	4.96	4.71 ~ 5.21
5600	35.5	33.7 ~ 37.3	5.07	4.82 ~ 5.32
5800	35.3	33.5 ~ 37.1	5.27	5.01 ~ 5.53
For Body				
750	55.5	52.7 ~ 58.3	0.96	0.91 ~ 1.01
835	55.2	52.4 ~ 58.0	0.97	0.92 ~ 1.02
900	55.0	52.3 ~ 57.8	1.05	1.00 ~ 1.10
1450	54.0	51.3 ~ 56.7	1.30	1.24 ~ 1.37
1640	53.8	51.1 ~ 56.5	1.40	1.33 ~ 1.47
1750	53.4	50.7 ~ 56.1	1.49	1.42 ~ 1.56
1800	53.3	50.6 ~ 56.0	1.52	1.44 ~ 1.60
1900	53.3	50.6 ~ 56.0	1.52	1.44 ~ 1.60
2000	53.3	50.6 ~ 56.0	1.52	1.44 ~ 1.60
2300	52.9	50.3 ~ 55.5	1.81	1.72 ~ 1.90
2450	52.7	50.1 ~ 55.3	1.95	1.85 ~ 2.05
2600	52.5	49.9 ~ 55.1	2.16	2.05 ~ 2.27
3500	51.3	48.7 ~ 53.9	3.31	3.14 ~ 3.48
5200	49.0	46.6 ~ 51.5	5.30	5.04 ~ 5.57
5300	48.9	46.5 ~ 51.3	5.42	5.15 ~ 5.69
5500	48.6	46.2 ~ 51.0	5.65	5.37 ~ 5.93
5600	48.5	46.1 ~ 50.9	5.77	5.48 ~ 6.06
5800	48.2	45.8 ~ 50.6	6.00	5.70 ~ 6.30

7. SAR Measurement Procedure

According to the SAR test standard, the recommended procedure for assessing the peak spatial-average SAR value consists of the following steps:

- (a) Power reference measurement
- (b) Area scan
- (c) Zoom scan
- (d) Power drift measurement

The SAR measurement procedures for each of test conditions are as follows:

- (a) Make EUT to transmit maximum output power
- (b) Measure conducted output power through RF cable
- (c) Place the EUT in the specific position of phantom
- (d) Perform SAR testing steps on the DASY system
- (e) Record the SAR value

7.1 Area & Zoom Scan Procedure

First Area Scan is used to locate the approximate location(s) of the local peak SAR value(s). The measurement grid within an Area Scan is defined by the grid extent, grid step size and grid offset. Next, in order to determine the EM field distribution in a three-dimensional spatial extension, Zoom Scan is required. The Zoom Scan is performed around the highest E-field value to determine the averaged SAR-distribution over 10 g. According to KDB 865664 D01, the resolution for Area and Zoom scan is specified in the table below.

Items	≤ 2GHz	2-3 GHz	3-4 GHz	4-5 GHz	5-6 GHz
Area Scan ($\Delta x, \Delta y$)	≤ 15mm	≤ 12 mm	≤ 12 mm	≤ 10 mm	≤ 10 mm
Zoom Scan ($\Delta x, \Delta y$)	≤ 8 mm	≤ 5 mm	≤ 5 mm	≤ 4 mm	≤ 4 mm
Zoom Scan (Δz)	≤ 5 mm	≤ 5 mm	≤ 4 mm	≤ 3 mm	≤ 2 mm
Zoom Scan Volume	≥ 30 mm	≥ 30 mm	≥ 28 mm	≥ 25 mm	≥ 22 mm

Note:

When zoom scan is required and report SAR is ≤ 1.4 W/kg, the zoom scan resolution of $\Delta x / \Delta y$ (2-3 GHz): ≤ 8 mm, 3-4 GHz: ≤ 7 mm, 4-6 GHz: ≤ 5 mm) may be applied.

7.2 Volume Scan Procedure

The volume scan is used for assess overlapping SAR distributions for antennas transmitting in different frequency bands. It is equivalent to an oversized zoom scan used in standalone measurements. The measurement volume will be used to enclose all the simultaneous transmitting antennas. For antennas transmitting simultaneously in different frequency bands, the volume scan is measured separately in each frequency band. In order to sum correctly to compute the 1g aggregate SAR, the EUT remain in the same test position for all measurements and all volume scan use the same spatial resolution and grid spacing. When all volume scan were completed, the software, SEMCAD postprocessor can combine and subsequently superpose these measurement data to calculating the multiband SAR.

7.3 Power Drift Monitoring

All SAR testing is under the EUT install full charged battery and transmit maximum output power. In DASYS measurement software, the power reference measurement and power drift measurement procedures are used for monitoring the power drift of EUT during SAR test. Both these procedures measure the field at a specified reference position before and after the SAR testing. The software will calculate the field difference in dB. If the power drift more than 5%, the SAR will be retested.

7.4 Spatial Peak SAR Evaluation

The procedure for spatial peak SAR evaluation has been implemented according to the test standard. It can be conducted for 1g and 10g, as well as for user-specific masses. The DASYS software includes all numerical procedures necessary to evaluate the spatial peak SAR value.

The base for the evaluation is a "cube" measurement. The measured volume must include the 1g and 10g cubes with the highest averaged SAR values. For that purpose, the center of the measured volume is aligned to the interpolated peak SAR value of a previously performed area scan.

The entire evaluation of the spatial peak values is performed within the post-processing engine (SEMCAD). The system always gives the maximum values for the 1g and 10g cubes. The algorithm to find the cube with highest averaged SAR is divided into the following stages:

- (a) Extraction of the measured data (grid and values) from the Zoom Scan
- (b) Calculation of the SAR value at every measurement point based on all stored data (A/D values and measurement parameters)
- (c) Generation of a high-resolution mesh within the measured volume
- (d) Interpolation of all measured values from the measurement grid to the high-resolution grid
- (e) Extrapolation of the entire 3-D field distribution to the phantom surface over the distance from sensor to surface
- (f) Calculation of the averaged SAR within masses of 1g and 10g

7.5 SAR Averaged Methods

In DASYS, the interpolation and extrapolation are both based on the modified Quadratic Shepard's method. The interpolation scheme combines a least-square fitted function method and a weighted average method which are the two basic types of computational interpolation and approximation.

Extrapolation routines are used to obtain SAR values between the lowest measurement points and the inner phantom surface. The extrapolation distance is determined by the surface detection distance and the probe sensor offset. The uncertainty increases with the extrapolation distance. To keep the uncertainty within 1% for the 1 g and 10 g cubes, the extrapolation distance should not be larger than 5 mm.

8. SAR Measurement Evaluation

8.1 EUT Configuration and Setting

<Considerations Related to WLAN for Setup and Testing>

In general, various vendor specific external test software and chipset based internal test modes are typically used for SAR measurement. These chipset based test mode utilities are generally hardware and manufacturer dependent, and often include substantial flexibility to reconfigure or reprogram a device. A Wi-Fi device must be configured to transmit continuously at the required data rate, channel bandwidth and signal modulation, using the highest transmission duty factor supported by the test mode tools for SAR measurement. The test frequencies established using test mode must correspond to the actual channel frequencies. When 802.11 frame gaps are accounted for in the transmission, a maximum transmission duty factor of 92 - 96% is typically achievable in most test mode configurations. A minimum transmission duty factor of 85% is required to avoid certain hardware and device implementation issues related to wide range SAR scaling. In addition, a periodic transmission duty factor is required for current generation SAR systems to measure SAR correctly. The reported SAR must be scaled to 100% transmission duty factor to determine compliance at the maximum tune-up tolerance limit.

According to KDB 248227 D01, this device has installed WLAN engineering testing software which can provide continuous transmitting RF signal. During WLAN SAR testing, this device was operated to transmit continuously at the maximum transmission duty with specified transmission mode, operating frequency, lowest data rate, and maximum output power.

Initial Test Configuration

An initial test configuration is determined for OFDM transmission modes in 2.4 GHz and 5 GHz bands according to the channel bandwidth, modulation and data rate combination(s) with the highest maximum output power specified for production units in each standalone and aggregated frequency band. When the same maximum power is specified for multiple transmission modes in a frequency band, the largest channel bandwidth, lowest order modulation, lowest data rate and lowest order 802.11a/g/n/ac mode is used for SAR measurement, on the highest measured output power channel in the initial test configuration, for each frequency band.

Subsequent Test Configuration

SAR measurement requirements for the remaining 802.11 transmission mode configurations that have not been tested in the initial test configuration are determined separately for each standalone and aggregated frequency band, in each exposure condition, according to the maximum output power specified for production units. Additional power measurements may be required to determine if SAR measurements are required for subsequent highest output power channels in a subsequent test configuration. When the highest reported SAR for the initial test configuration according to the initial test position or fixed exposure position requirements, is adjusted by the ratio of the subsequent test configuration to initial test configuration specified maximum output power and the adjusted SAR is ≤ 1.2 W/kg, SAR is not required for that subsequent test configuration.

SAR Test Configuration and Channel Selection

When multiple channel bandwidth configurations in a frequency band have the same specified maximum output power, the initial test configuration is using largest channel bandwidth, lowest order modulation, lowest data rate, and lowest order 802.11 mode (i.e., 802.11a is chosen over 802.11n then 802.11ac or 802.11g is chosen over 802.11n). After an initial test configuration is determined, if multiple test channels have the same measured maximum output power, the channel chosen for SAR measurement is determined according to the following.

- 1) The channel closest to mid-band frequency is selected for SAR measurement.
- 2) For channels with equal separation from mid-band frequency; for example, high and low channels or two mid-band channels, the higher frequency (number) channel is selected for SAR measurement.

8.2 EUT Testing Position

According to KDB 648474 D02, the EUT is tested for SAR compliance in the use configurations described in the following subsections.

8.2.1 Body Exposure Conditions

<Simple Dongle Procedures>

For USB dongle transmitter, according to KDB 447498 D02, SAR evaluation is required for all USB orientations illustrated as below with a device-to-phantom separation distance of 5 mm or less. The typical Horizontal-Up USB connection, found in the majority of host computers, must be tested using an appropriate host computer. A host computer with either Vertical-Front or Vertical-Back USB connection should be used to test one of the vertical USB orientations. If a suitable host computer is not available for testing the Horizontal-Down or the remaining Vertical USB orientation, a high quality USB cable, 12 inches or less, may be used for testing these other orientations.

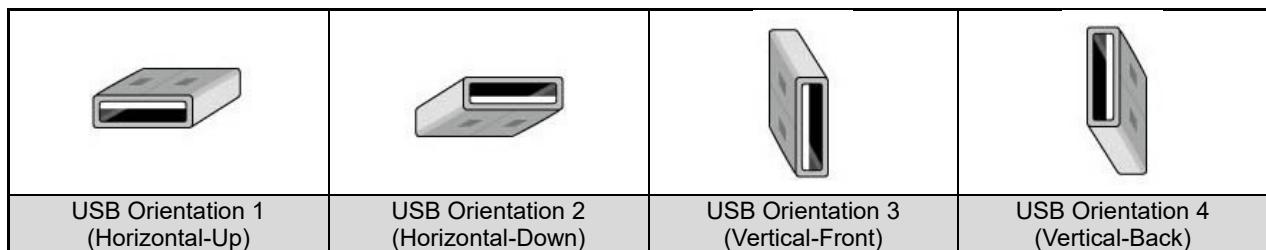
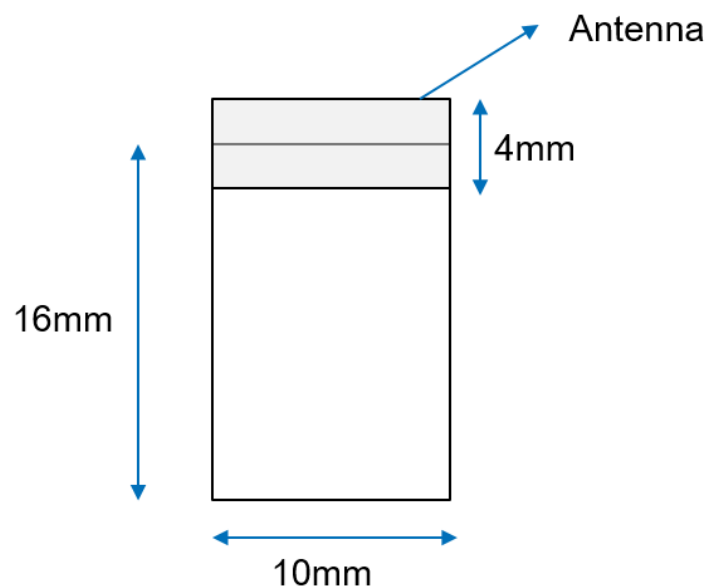

Illustration for USB Connector Orientations

8.2.2 Antenna Location



8.2.3 SAR Test Exclusion Evaluations

According to KDB 447498 D01, the SAR test exclusion condition is based on source-based time-averaged maximum conducted output power, adjusted for tune-up tolerance, and the minimum test separation distance required for the exposure conditions. The SAR exclusion threshold is determined by the following formula.

1. For the test separation distance ≤ 50 mm

$$\frac{\text{Max. Tune up Power}_{(mW)}}{\text{Min. Test Separation Distance}_{(mm)}} \times \sqrt{f_{(GHz)}} \leq 3.0 \text{ for SAR-1g, } \leq 7.5 \text{ for SAR-10g}$$

When the minimum test separation distance is < 5 mm, a distance of 5 mm is applied to determine SAR test exclusion.

Antennas ≤ 50 mm to edges (100MHz~6G)						
Radio	Frq. (MHz)	Tune-up Power		Separation distances (mm)	Calculated Threshold	
		dBm	mW		Result	limit
BT	2441	9.5	8.913	5	2.785	3
BLE	2440	9.5	8.913	5	2.784	3
Test Requirement (Yes/No)					NO	

Note:

1. When separation distance ≤ 50 mm and the calculated result shown in above table is ≤ 3.0 for SAR-1g exposure condition, or ≤ 7.5 for SAR-10g exposure condition, the SAR testing exclusion is applied.

8.3 Simultaneous Transmission Possibilities

There is no simultaneous transmission configuration in this device.

8.4 Tissue Verification

The simulating liquids should be checked at the beginning of a series of SAR measurements to determine if the dielectric parameters are within the tolerances of the specified target values. The measured conductivity and relative permittivity should be within $\pm 5\%$ of the target values.

The following materials are used for producing the tissue-equivalent materials.

Recipes of Tissue Simulating Liquid

Tissue Type	Bactericide	DGBE	HEC	NaCl	Sucrose	Triton X-100	Water	Diethylene Glycol Mono-hexylether
H750	0.2	-	0.2	1.5	56.0	-	42.1	-
H835	0.2	-	0.2	1.5	57.0	-	41.1	-
H900	0.2	-	0.2	1.4	58.0	-	40.2	-
H1450	-	43.3	-	0.6	-	-	56.1	-
H1640	-	45.8	-	0.5	-	-	53.7	-
H1750	-	47.0	-	0.4	-	-	52.6	-
H1800	-	44.5	-	0.3	-	-	55.2	-
H1900	-	44.5	-	0.2	-	-	55.3	-
H2000	-	44.5	-	0.1	-	-	55.4	-
H2300	-	44.9	-	0.1	-	-	55.0	-
H2450	-	45.0	-	0.1	-	-	54.9	-
H2600	-	45.1	-	0.1	-	-	54.8	-
H3500	-	8.0	-	0.2	-	20.0	71.8	-
H5G	-	-	-	-	-	17.2	65.5	17.3

Salt: 99+% Pure Sodium Chloride; Sugar: 98+% Pure Sucrose; Water: De-ionized, 16M +resistivity
 HEC: Hydroxyethyl Cellulose; DGBE: 99+% Di(ethylene glycol) butyl ether, [2-(2-butoxyethoxy) ethanol];
 Triton X-100 (ultra pure): Polyethylene glycol mono [4-(1,1,3,3-tetramethylbutyl) phenyl]ether.

The measuring results for tissue simulating liquid are shown as below.

Test Date	Tissue Type	Frequency (MHz)	Measured Conductivity (σ)	Measured Permittivity (ϵ_r)	Target Conductivity (σ)	Target Permittivity (ϵ_r)	Conductivity Deviation (%)	Permittivity Deviation (%)
Aug. 14, 2021	Head	2450	1.881	38.228	1.80	39.2	4.50	-2.48

Note:

The dielectric properties of the tissue simulating liquid must be measured within 24 hours before the SAR testing and within $\pm 5\%$ of the target values. Liquid temperature during the SAR testing must be within ± 2 °C.

8.5 System Validation

System check Procedure

The system check verifies that the system operates within its specifications. It is performed daily or before every SAR measurement. The system check uses normal SAR measurements in the flat section of the phantom with a matched dipole at a specified distance. The system verification setup is shown as below.

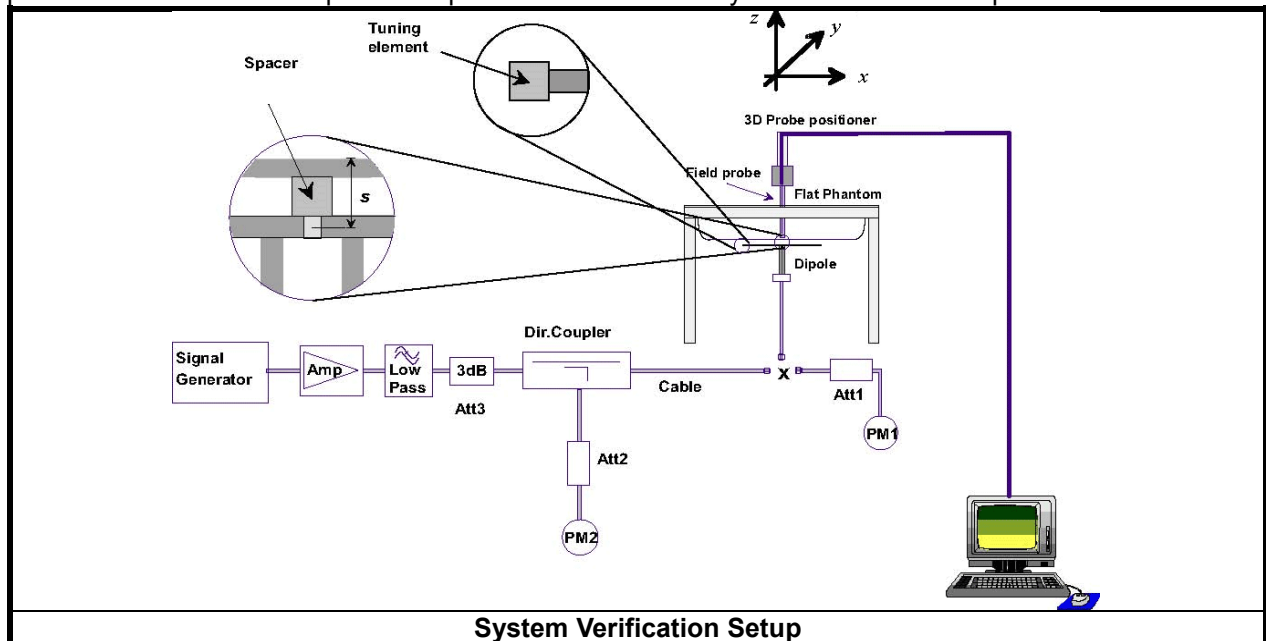

The validation dipole is placed beneath the flat phantom with the specific spacer in place. The distance spacer is touch the phantom surface with a light pressure at the reference marking and be oriented parallel to the long side of the phantom. The spectrum analyzer measures the forward power at the location of the system check dipole connector. The signal generator is adjusted for the desired forward power (250 mW is used for 700 MHz to 3 GHz, 100 mW is used for 3.5 GHz to 6 GHz) at the dipole connector and the power meter is read at that level. After connecting the cable to the dipole, the signal generator is readjusted for the same reading at power meter.

After system check testing, the SAR result will be normalized to 1W forward input power and compared with the reference SAR value derived from validation dipole certificate report. The deviation of system check should be within 10 %.

8.6 System Verification

The measuring results for system check are shown as below.

Test Date	Frequency (MHz)	1W Target SAR-1g (W/kg)	Measured SAR-1g (W/kg)	Normalized to 1W SAR-1g (W/kg)	Deviation (%)	Dipole S/N	Probe S/N	DAE S/N
Aug. 14, 2021	2450	53.20	13.80	55.20	3.76	804	7400	855

Note:

Comparing to the reference SAR value provided by SPEAG, the validation data should be within its specification of 10 %. The result indicates the system check can meet the variation criterion and the plots can be referred to Appendix A of this report.

8.7 Maximum Output Power

8.7.1 Measured Conducted Power Result

All Rate have been tested, the Worst average power (Unit: dBm) is shown as below.

<Bluetooth>

BT	Average Conducted Power (dBm)			
	Max. Tune up	CH0	CH39	CH78
		2402MHz	2441MHz	2480MHz
DH5	9.50	8.82	9.37	9.00
2DH5	9.50	8.70	9.21	8.84
3DH5	9.50	8.75	9.23	8.88

BT	Average Conducted Power (dBm)			
	Max. Tune up	CH0	CH19	CH39
		2402MHz	2440MHz	2480MHz
BLE(1M)	9.50	8.98	9.45	9.1

<WLAN 2.4G>

2.4G WIFI					
Mode	Channel	Frequency (MHz)	Data Rate (Mbps)	Max. Tune up	Average Power (dBm)
802.11b	1	2412	1	22.00	21.76
	7	2442		17.00	16.83
	13	2472		19.50	19.26
802.11g	1	2412	6	18.00	17.54
	7	2442		21.00	20.63
	13	2472		18.50	18.07
802.11n HT20	1	2412	MCS0	18.00	17.96
	7	2442		22.50	22.42
	13	2472		18.50	18.25
802.11n HT40	3	2422	MCS0	15.00	14.83
	7	2442		18.50	18.37
	11	2462		18.00	17.98

8.8 SAR Testing Results

8.8.1 SAR Test Reduction Considerations

<KDB 447498 D01, General RF Exposure Guidance>

Testing of other required channels within the operating mode of a frequency band is not required when the reported SAR for the mid-band or highest output power channel is:

- (1) ≤ 0.8 W/kg or 2.0 W/kg, for 1-g or 10-g respectively, when the transmission band is ≤ 100 MHz
- (2) ≤ 0.6 W/kg or 1.5 W/kg, for 1-g or 10-g respectively, when the transmission band is between 100 MHz and 200 MHz
- (3) ≤ 0.4 W/kg or 1.0 W/kg, for 1-g or 10-g respectively, when the transmission band is ≥ 200 MHz

<KDB 248227 D01, SAR Guidance for Wi-Fi Transmitters>

- (1) For handsets operating next to ear, hotspot mode or mini-tablet configurations, the initial test position procedures were applied. The test position with the highest extrapolated peak SAR will be used as the initial test position. When the reported SAR of initial test position is ≤ 0.4 W/kg, SAR testing for remaining test positions is not required. Otherwise, SAR is evaluated at the subsequent highest peak SAR positions until the reported SAR result is ≤ 0.8 W/kg or all test positions are measured.
- (2) For WLAN 2.4 GHz, the highest measured maximum output power channel for DSSS was selected for SAR measurement. When the reported SAR is ≤ 0.8 W/kg, no further SAR testing is required. Otherwise, SAR is evaluated at the next highest measured output power channel. When any reported SAR is > 1.2 W/kg, SAR is required for the third channel. For OFDM modes (802.11g/n), SAR is not required when the highest reported SAR for DSSS is adjusted by the ratio of OFDM to DSSS specified maximum output power and it is ≤ 1.2 W/kg.

8.8.2 SAR Results for Body Exposure Condition (Separation Distance is 0.5cm Gap)

Plot No.	Band	Mode	Ch.	Test Position	Max. Tune-up Power (dBm)	Measured Conducted Power (dBm)	Power Drift (dB)	Measured SAR-1g (W/kg)	Scaling Factor	Reported SAR-1g (W/kg)
1	802.11b	-	1	Horizontal up	22.0	21.76	0.15	0.748	1.057	0.790
2	802.11b	-	1	Horizontal Down	22.0	21.76	-0.09	0.914	1.057	0.966
3	802.11b	-	1	Vertical Front	22.0	21.76	0.07	0.62	1.057	0.655
4	802.11b	-	1	Vertical Back	22.0	21.736	-0.04	0.46	1.063	0.489
5	802.11b	-	1	Tip mode	22.0	21.736	-0.15	0.096	1.063	0.102
6	802.11b	-	6	Horizontal Down	17.0	16.83	-0.07	0.535	1.040	0.556
7	802.11b	-	11	Horizontal Down	19.5	19.26	0.12	0.886	1.057	0.936
14	802.11b	-	1	Horizontal Down	22.0	21.76	-0.09	0.908	1.057	0.960
7	802.11n	HT20	6	Horizontal up	22.5	22.42	0.03	0.94	1.019	0.957
8	802.11n	HT20	6	Horizontal Down	22.5	22.42	-0.05	1.29	1.019	1.314
9	802.11n	HT20	6	Vertical Front	22.5	22.42	0.14	0.882	1.019	0.898
10	802.11n	HT20	6	Vertical Back	22.5	22.42	-0.07	0.679	1.019	0.692
11	802.11n	HT20	6	Tip mode	22.5	22.42	-0.05	0.104	1.019	0.000
12	802.11n	HT20	1	Horizontal Down	18.0	17.96	-0.04	0.435	1.009	0.439
13	802.11n	HT20	11	Horizontal Down	18.5	18.25	-0.2	0.736	1.059	0.780
15	802.11n	HT20	6	Horizontal Down	22.5	22.42	0.17	1.27	1.019	1.294

8.8.3 SAR Measurement Variability

According to KDB 865664 D01, SAR measurement variability was assessed for each frequency band, which is determined by the SAR probe calibration point and tissue-equivalent medium used for the device measurements. When both head and body tissue-equivalent media are required for SAR measurements in a frequency band, the variability measurement procedures should be applied to the tissue medium with the highest measured SAR, using the highest measured SAR configuration for that tissue-equivalent medium. Alternatively, if the highest measured SAR for both head and body tissue-equivalent media are ≤ 1.45 W/kg and the ratio of these highest SAR values, i.e., largest divided by smallest value, is ≤ 1.10 , the highest SAR configuration for either head or body tissue-equivalent medium may be used to perform the repeated measurement. These additional measurements are repeated after the completion of all measurements requiring the same head or body tissue-equivalent medium in a frequency band. The test device should be returned to ambient conditions (normal room temperature) with the battery fully charged before it is re-mounted on the device holder for the repeated measurement(s) to minimize any unexpected variations in the repeated results.

SAR repeated measurement procedure:

1. When the highest measured SAR is < 0.80 W/kg, repeated measurement is not required.
2. When the highest measured SAR is ≥ 0.80 W/kg, repeat that measurement once.
3. If the ratio of largest to smallest SAR for the original and first repeated measurements is > 1.20 , or when the original or repeated measurement is ≥ 1.45 W/kg, perform a second repeated measurement.
4. If the ratio of largest to smallest SAR for the original, first and second repeated measurements is > 1.20 , and the original, first or second repeated measurement is ≥ 1.5 W/kg, perform a third repeated measurement.

Band	Test Position	Ch.	Original Measured SAR-1g (W/kg)	1st Repeated SAR-1g (W/kg)	L/S Ratio	2nd Repeated SAR-1g (W/kg)	L/S Ratio	3rd Repeated SAR-1g (W/kg)	L/S Ratio
802.11n HT20	Horizontal Down	6	1.29	1.27	1.02	N/A	N/A	N/A	N/A

9. Appendixes

Appendix A – SAR Plots of System Verification

Appendix B – SAR Plots of SAR Measurement

Appendix C – Calibration Certificate for Probe and Dipole

Appendix D – Photographs of the Test Set-Up

---END---