

<b>Prüfbericht-Nr.:</b> <i>Test report no.:</i>	CN21ADTW (P15C-BT) 001	<b>Auftrags-Nr.:</b> <i>Order no.:</i>	238518076	Seite 1 von 29 Page 1 of 29
<b>Kunden-Referenz-Nr.:</b> <i>Client reference no.:</i>	N/A	<b>Auftragsdatum:</b> <i>Order date:</i>	2021-07-23	
<b>Auftraggeber:</b> <i>Client:</i>	Edimax Technology Co., Ltd No.278, Xinhu 1st Rd., Neihu Dist., Taipei City, Taiwan			
<b>Prüfgegenstand:</b> <i>Test item:</i>	1T1R 11n Wireless LAN with Bluetooth USB Adapter			
<b>Bezeichnung / Typ-Nr.:</b> <i>Identification / Type no.:</i>	EW-7611ULB V2.0A, EW-7611ULB V2			
<b>Auftrags-Inhalt:</b> <i>Order content:</i>	FCC Part 15C Test report (BT)			
<b>Prüfgrundlage:</b> <i>Test specification:</i>	FCC 47CFR Part 15: Subpart C Section 15.247			
<b>Wareneingangsdatum:</b> <i>Date of sample receipt:</i>	2021-07-26			
<b>Prüfmuster-Nr.:</b> <i>Test sample no.:</i>	A003098476-004 A003098476-002			
<b>Prüfzeitraum:</b> <i>Testing period:</i>	2021-08-11 - 2021-08-19			
<b>Ort der Prüfung:</b> <i>Place of testing:</i>	EMC/RF Taipei Testing Site			
<b>Prüflaboratorium:</b> <i>Testing laboratory:</i>	Taipei Testing Laboratories			
<b>Prüfergebnis*:</b> <i>Test result*:</i>	Pass			
<b>überprüft von:</b> <i>compiled by:</i>		<b>genehmigt von:</b> <i>authorized by:</i>		
<b>Datum:</b> <i>Date:</i>	2021-09-06	<b>Ausstellungsdatum:</b> <i>Issue date:</i>	2021-09-06	
<b>Stellung / Position:</b>	David Huang Project Manager	<b>Stellung / Position:</b>	Brenda Chen Senior Project Manager	
<b>Sonstiges / Other:</b>	The main model is EW-7611ULB V2.0A, and the series model is EW-7611ULB V2. Both models are electrically identical, different model names are for marketing purpose.			
<b>Zustand des Prüfgegenstandes bei Anlieferung:</b> <i>Condition of the test item at delivery:</i>	Prüfmuster vollständig und unbeschädigt <i>Test item complete and undamaged</i>			
* Legende:	1 = sehr gut P(ass) = entspricht o.g. Prüfgrundlage(n)	2 = gut F(ail) = entspricht nicht o.g. Prüfgrundlage(n)	3 = befriedigend N/A = nicht anwendbar	4 = ausreichend N/T = nicht getestet
* Legend:	1 = very good P(ass) = passed a.m. test specification(s)	2 = good F(ail) = failed a.m. test specification(s)	3 = satisfactory N/A = not applicable	4 = sufficient N/T = not tested
<b>Dieser Prüfbericht bezieht sich nur auf das o.g. Prüfmuster und darf ohne Genehmigung der Prüfstelle nicht auszugsweise vervielfältigt werden. Dieser Bericht berechtigt nicht zur Verwendung eines Prüfzeichens.</b> <i>This test report only relates to the a. m. test sample. Without permission of the test center this test report is not permitted to be duplicated in extracts. This test report does not entitle to carry any test mark.</i>				

## TEST SUMMARY

Report Section	FCC Clause	Test Item	Result
5.1.1	15.247(b) & 15.203	Antenna Requirement	Pass
5.1.2	15.247(b)(1)	Peak Output Power	Pass
5.1.3	15.247(a)(1)	20 dB Bandwidth	Pass
5.1.3	2.1049	99% Occupied Bandwidth	Pass
5.1.4	15.247(d)	Conducted Spurious Emission and Band Edges	Pass
5.1.5	15.247(d) & 15.205 & 15.209	Radiated Spurious Emissions and Band Edges	Pass
5.1.6	15.247(a)(1)	Hopping Channel Separation	Pass
5.1.7	15.247(a)(1) (iii)	Number of Hopping Frequency Used	Pass
5.1.8	15.247(a)(1) (iii)	Dwell Time on Each Channel	Pass
5.2.1	15.207	Mains Conducted Emission	Pass

**Note:**

1. If the Frequency Hopping Systems operating in 2400-2483.5 MHz band and the output power less than 125 mW. The hopping channel carrier frequencies separated by a minimum of 25 kHz or two-thirds of the 20 dB bandwidth of hopping channel whichever is greater.
2. Determining compliance based on the results of the compliance measurement, not taking into account measurement instrumentation uncertainty.

## Contents

<b>HISTORY OF THIS TEST REPORT .....</b>	<b>5</b>
<b>1. GENERAL REMARKS .....</b>	<b>6</b>
<b>1.1 COMPLEMENTARY MATERIALS.....</b>	<b>6</b>
<b>1.2 DECISION RULE OF CONFORMITY .....</b>	<b>6</b>
<b>2. TEST SITES .....</b>	<b>7</b>
<b>2.1 TEST LABORATORY .....</b>	<b>7</b>
<b>2.2 TEST FACILITY.....</b>	<b>7</b>
<b>2.3 TRACEABILITY .....</b>	<b>8</b>
<b>2.4 CALIBRATION .....</b>	<b>8</b>
<b>2.5 MEASUREMENT UNCERTAINTY .....</b>	<b>8</b>
<b>3. GENERAL PRODUCT INFORMATION.....</b>	<b>9</b>
<b>3.1 PRODUCT FUNCTION AND INTENDED USE .....</b>	<b>9</b>
<b>3.2 SYSTEM DETAILS AND RATINGS.....</b>	<b>9</b>
<b>3.3 NOISE GENERATING AND NOISE SUPPRESSING PARTS .....</b>	<b>10</b>
<b>3.4 SUBMITTED DOCUMENTS.....</b>	<b>10</b>
<b>4. TEST SET-UP AND OPERATION MODES.....</b>	<b>11</b>
<b>4.1 PRINCIPLE OF CONFIGURATION SELECTION .....</b>	<b>11</b>
<b>4.2 CARRIER FREQUENCY AND CHANNEL.....</b>	<b>11</b>
<b>4.3 TEST OPERATION AND TEST SOFTWARE.....</b>	<b>12</b>
<b>4.4 SPECIAL ACCESSORIES AND AUXILIARY EQUIPMENT .....</b>	<b>13</b>
<b>4.5 TEST SETUP DIAGRAM .....</b>	<b>14</b>
<b>5. TEST RESULTS .....</b>	<b>15</b>
<b>5.1 TRANSMITTER REQUIREMENT &amp; TEST SUITES .....</b>	<b>15</b>
5.1.1 <i>Antenna Requirement .....</i>	<i>15</i>
5.1.2 <i>Peak Output Power .....</i>	<i>16</i>
5.1.3 <i>20 dB Bandwidth and 99% Occupied Bandwidth.....</i>	<i>18</i>
5.1.4 <i>Conducted Spurious Emissions and Frequency Band Edges Measured in 100kHz Bandwidth.....</i>	<i>19</i>
5.1.5 <i>Radiated Spurious Emissions and Band Edges .....</i>	<i>20</i>
5.1.6 <i>Hopping Channel Separation.....</i>	<i>25</i>
5.1.7 <i>Number of Hopping Frequency.....</i>	<i>26</i>
5.1.8 <i>Dwell Time.....</i>	<i>27</i>
<b>5.2 MAINS EMISSION .....</b>	<b>28</b>
5.2.1 <i>Mains Conducted Emission.....</i>	<i>28</i>

**Prüfbericht - Nr.: CN21ADTW (P15C-BT) 001**  
Test Report No.

**Seite 4 von 29**  
Page 4 of 29

**APPENDIX A - TEST RESULT OF CONDUCTED**

**APPENDIX B - TEST RESULT OF RADIATED EMISSIONS & MAINS CONDUCTED EMISSION**

**APPENDIX SP - PHOTOGRAPHS TEST SETUP**

**APPENDIX EP - PHOTOGRAPHS OF EUT**

**Prüfbericht - Nr.: CN21ADTW (P15C-BT) 001**  
Test Report No.

**Seite 5 von 29**  
Page 5 of 29

### HISTORY OF THIS TEST REPORT

Report No.	Description	Date Issued
CN21ADTW (P15C-BT) 001	Original Release	2021-09-06

## 1. General Remarks

### 1.1 Complementary Materials

All attachments are integral parts of this test report. This applies especially to the following appendix:

**Appendix A - Test Result of Conducted**

**Appendix B - Test Result of Radiated Emissions & Mains Conducted Emission**

**Appendix SP - Photographs Test Setup**

**Appendix EP - Photographs of EUT**

### Applied Standard and Test Levels

Radio
FCC 47CFR Part 15: Subpart C Section 15.247
FCC 47CFR Part 2: Subpart J Section 2.1049
ANSI C63.10:2013
KDB 558074 D01 15.247 Meas Guidance v05r02

### 1.2 Decision Rule of Conformity

The decision rule of conformity of this test report is following the requirements of the requested standard in the quotation, and agreed among testing laboratory and manufacturer (applicant) to exclude the consideration of Measurement Uncertainty, unless it is required by the specific standard.

## 2. Test Sites

### 2.1 Test Laboratory

Taipei Testing Laboratories

11F. No.758, Sec. 4, Bade Rd., Songshan Dist.  
Taipei City 105  
Taiwan (R.O.C.)

### 2.2 Test Facility

Taipei Testing Laboratories

No.458-18, Sec. 2, Fenliao Rd., Linkou Dist.,  
New Taipei City 244  
Taiwan (R.O.C.)  
FCC Registration No.: 226631  
ISED Registration No.: 25563

## 2.3 Traceability

All measurement equipment calibrations are traceable to NML(Taiwan)/NIST(USA) or where calibration is performed outside Taiwan, to equivalent nationally recognized standards organizations.

## 2.4 Calibration

Equipment requiring calibration is calibrated periodically in a suitably accredited Calibration Lab. Additionally all equipment is verified for proper performance on a regular basis using in house standards or comparisons.

## 2.5 Measurement Uncertainty

All measurement uncertainty values are shown with a coverage factor of  $k=2$  to indicate a 95% level of confidence.

### Emission Measurement Uncertainty

Parameter	Uncertainty
Radiated Emission (9 kHz ~ 30 MHz)	$\pm 1.15$ dB
Radiated Emission (30 MHz ~ 200 MHz)	$\pm 1.30$ dB
Radiated Emission (200 MHz ~ 1 GHz)	$\pm 1.30$ dB
Radiated Emission (1 GHz ~ 18 GHz)	$\pm 1.54$ dB
Radiated Emission (18 GHz ~ 40 GHz)	$\pm 2.52$ dB
Mains Conducted Emission	$\pm 1.65$ dB



### 3. General Product Information

#### 3.1 Product Function and Intended Use

The EUT is a 1T1R 11n Wireless LAN with Bluetooth USB Adapter. It contains a Bluetooth compatible module enabling the user to communicate data through a Wireless interface.

For details refer to the User Guide, Data Sheet and Circuit Diagram.

#### 3.2 System Details and Ratings

##### Basic Information of EUT

Item	EUT information
Kind of Equipment/Test Item	1T1R 11n Wireless LAN with Bluetooth USB Adapter
Type Identification	EW-7611ULB V2.0A, EW-7611ULB V2
FCC ID	NDD9576112101

##### Technical Specification of EUT

Item	EUT information
Operating Frequency	2402 MHz ~ 2480 MHz
Channel Number	79
Operation Voltage	5 Vdc
Modulation	GFSK, $\pi/4$ -DQPSK, 8DPSK
Maximum Output Power (mW)	15.56
Antenna Information	Refer to 5.1.1
Accessory Device	Refer to 4.4

### **3.3 Noise Generating and Noise Suppressing Parts**

Refer to the Circuit Diagram.

### **3.4 Submitted Documents**

- Circuit Diagram
- Instruction Manual
- Rating Label
- Technical Description

## 4. Test Set-up and Operation Modes

### 4.1 Principle of Configuration Selection

The test modes were adapted accordingly in reference to the instructions for use.

During testing, Channel and Power Controlling Software provided by the customer was used to control the operating channel as well as the output power level. The RF output power selection is for the setting of RF output expected by the customer and is going to be fixed on the firmware of the final end product.

**Table for Parameters of Test Software Setting**

Frequency (MHz)	Power Setting		
	GFSK	$\pi/4$ -DQPSK	8DPSK
2402	24	26	26
2441	26	27	27
2480	26	27	27

### 4.2 Carrier Frequency and Channel

Channel	Freq. (MHz)	Channel	Freq. (MHz)	Channel	Freq. (MHz)	Channel	Freq. (MHz)
0	2402	20	2422	40	2442	60	2462
1	2403	21	2423	41	2443	61	2463
2	2404	22	2424	42	2444	62	2464
3	2405	23	2425	43	2445	63	2465
4	2406	24	2426	44	2446	64	2466
5	2407	25	2427	45	2447	65	2467
6	2408	26	2428	46	2448	66	2468
7	2409	27	2429	47	2449	67	2469
8	2410	28	2430	48	2450	68	2470
9	2411	29	2431	49	2451	69	2471
10	2412	30	2432	50	2452	70	2472
11	2413	31	2433	51	2453	71	2473
12	2414	32	2434	52	2454	72	2474
13	2415	33	2435	53	2455	73	2475
14	2416	34	2436	54	2456	74	2476
15	2417	35	2437	55	2457	75	2477
16	2418	36	2438	56	2458	76	2478
17	2419	37	2439	57	2459	77	2479
18	2420	38	2440	58	2460	78	2480
19	2421	39	2441	59	2461		

### 4.3 Test Operation and Test Software

Setup for testing: Test samples are provided with a USB interface which makes it possible to control them through a test software installed on a notebook computer.

This software was running on the laptop computer connected to the EUT. It was used to enable the operation modes listed as below.

Test Software	BT-RTLTAPP(41945)
---------------	-------------------

The samples were used as follows:

A003098476-004

A003098476-002

Full test was applied on all test modes, but only worst case was shown.

EUT Configure Mode	Applicable To				Description
	Antenna Port Conducted Measurement	Radiated Spurious Emissions above 1 GHz	Radiated Spurious Emissions below 1 GHz	Mains Conducted Emission	
-	√	√	√	√	-

Note:

1. For Radiated emission test, pre-tested GFSK, π/4-DQPSK, 8DPSK modulation type and found GFSK was the worse, therefore chosen for the final test and presented in the test report.
2. The EUT had been pre-tested on the positioned of each 3 axis. The worst case was found when position on **Z-plane**.
3. "-" means no effect.

#### Antenna Port Conducted Measurement

Pre-Scan full test was applied on all test modes, but only worst case was shown.

Following channel(s) was (were) selected for the final test as listed below.

EUT Configure Mode	Available Frequency (MHz)	Tested Frequency (MHz)	Modulation Type	Packet Type
-	2402 to 2480	2402, 2441, 2480	GFSK	1DH5
-	2402 to 2480	2402, 2441, 2480	8DPSK	3DH5

#### Radiated Spurious Emissions (Above 1 GHz)

Pre-Scan full test was applied on all test modes, but only worst case was shown.

Following channel(s) was (were) selected for the final test as listed below.

EUT Configure Mode	Available Frequency (MHz)	Tested Frequency (MHz)	Modulation Type	Packet Type
-	2402 to 2480	2402, 2441, 2480	GFSK	1DH5
-	2402 to 2480	2402, 2441, 2480	8DPSK	3DH5

#### Radiated Spurious Emissions (Below 1 GHz)

Pre-Scan full test was applied on all test modes, but only worst case was shown.

Following channel(s) was (were) selected for the final test as listed below.

EUT Configure Mode	Available Frequency (MHz)	Tested Frequency (MHz)	Modulation Type	Packet Type
-	2402 to 2480	2402	GFSK	1DH5

#### Mains Conducted Emission Test

Pre-Scan full test was applied on all test modes, but only worst case was shown.

Following channel(s) was (were) selected for the final test as listed below.

EUT Configure Mode	Available Frequency (MHz)	Tested Frequency (MHz)	Modulation Type	Packet Type
-	2402 to 2480	2402	GFSK	1DH5

**Test Condition**

Test Item	Ambient Temperature	Relative Humidity	Tested by
Conducted Measurement	24.1 °C	51.6-55.7 %	Chun Wu
Radiated Spurious Emissions above 1 GHz	20.1-24.1 °C	60-65 %	Simon Tsai
Radiated Spurious Emissions below 1 GHz	20.1-24.1 °C	60-65 %	Simon Tsai
Mains Conducted Emission	24.3-26.2 °C	64.4-65.1 %	Simon Tsai

## 4.4 Special Accessories and Auxiliary Equipment

The product has been tested together with the following additional accessories:

**Accessory of EUT**

None

**Support Unit**

Support Unit								
No	Description	Brand	Model	S/N	Shielded	Ferrite Core (Qty)	Length (cm)	Remark
1	Notebook	Lenovo	TP00094F	PF-1V4YV0	-	-	-	--
2	Adapter	Lenovo	ADLX65YLC3A	N/A	NO	NO	180	--

## 4.5 Test Setup Diagram

<Radiated Spurious Emissions mode>

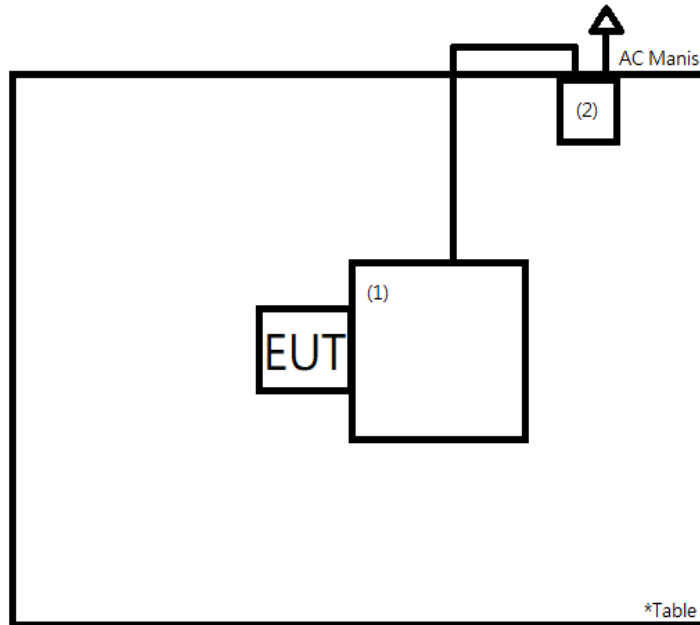

<Mains Conducted Emission mode>

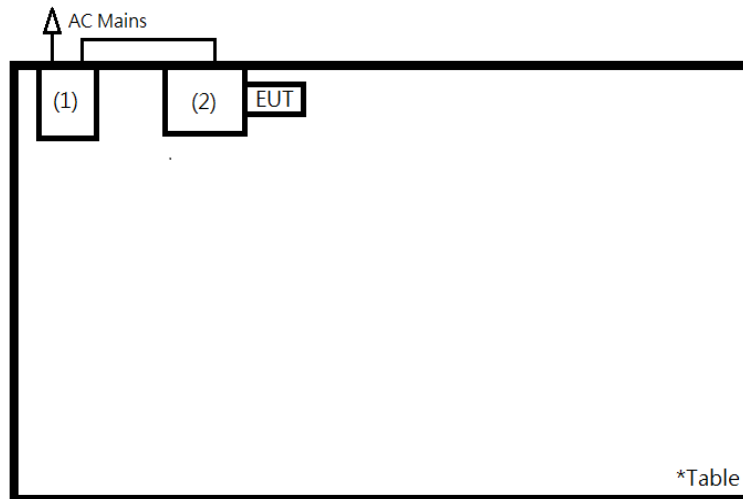

## 5. Test Results

### 5.1 Transmitter Requirement & Test Suites

#### 5.1.1 Antenna Requirement

**Requirement** Use of approved antennas only

According to the manufacturer declaration, the EUT has an antenna with a directional gain of 1.6 dBi. The antenna is PIFA antenna with no possibility of replacement with a non-approved antenna by the by the end-user. Therefore, the EUT is considered to comply with this provision.  
Refer to EUT photo for details.

## 5.1.2 Peak Output Power

### Limit

For frequency hopping systems operating in the 2400-2483.5 MHz band employing at least 75 non-overlapping hopping channels, and all frequency hopping systems in the 5725-5850 MHz band: 1 watt. For all other frequency hopping systems in the 2400-2483.5 MHz band: 0.125 watts.

**Kind of Test Site**                      Shielded room

### Test Setup

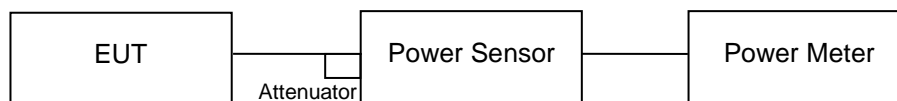

### Test Instruments

Kind of Equipment	Manufacturer	Type	S/N	Calibration Date	Calibration Due Date	Test Date	
						From	Until
Power Meter	Anritsu	ML2495A	1901008	2021/3/24	2022/3/23	2021/8/13	2021/8/13
Power Sensor	Anritsu	MA2411B	1725269	2021/3/24	2022/3/23	2021/8/13	2021/8/13

### Test Procedures

A peak power sensor was used on the output port of the EUT. A power meter was used to read the response of the peak power sensor. Record the power level.

Average power sensor was used to perform output power measurement, trigger and gating function of wide band power meter is enabled to measure max output power of TX on burst. Duty factor is not added to measured value.



**Test Result**
**Peak Output Power**
**<GFSK>**

Channel	Channel Frequency	Peak Output Power		Limit
	(MHz)	(dBm)	(mW)	(mW)
Low Channel	2402	9.06	8.05	125
Middle Channel	2441	9.54	8.99	125
High Channel	2480	9.23	8.38	125

**<8DPSK>**

Channel	Channel Frequency	Peak Output Power		Limit
	(MHz)	(dBm)	(mW)	(mW)
Low Channel	2402	11.46	14.00	125
Middle Channel	2441	11.92	15.56	125
High Channel	2480	11.63	14.55	125

**Average Power**
**<GFSK>**

Channel	Channel Frequency	Average Power	
	(MHz)	(dBm)	(mW)
Low Channel	2402	8.82	7.62
Middle Channel	2441	9.37	8.65
High Channel	2480	9.00	7.94

**<8DPSK>**

Channel	Channel Frequency	Average Power	
	(MHz)	(dBm)	(mW)
Low Channel	2402	8.75	7.50
Middle Channel	2441	9.23	8.38
High Channel	2480	8.88	7.73

### 5.1.3 20 dB Bandwidth and 99% Occupied Bandwidth

**Kind of Test Site**                      Shielded room

**Test Setup**

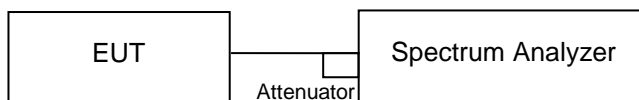

**Test Instruments**

Kind of Equipment	Manufacturer	Type	S/N	Calibration Date	Calibration Due Date	Test Date	
						From	Until
Spectrum Analyzer	R&S	FSV40	101512	2021/1/29	2022/1/28	2021/8/11	2021/8/18

**Test Procedure**

- a. Check the calibration of the measuring instrument using either an internal calibrator or a known signal from an external generator.
- b. Turn on the EUT and connect it to measurement instrument. Then set it to any one convenient frequency within its operating range. Set a reference level on the measuring instrument equal to the highest peak value.
- c. Measure the frequency difference of two frequencies that were attenuated 20 dB from the reference level. Record the frequency difference as the emission bandwidth.
- d. Repeat above procedures until all frequencies measured were complete.
- e. The transmitter output was connected to the spectrum analyzer through an attenuator. The bandwidth of the fundamental frequency was measured by spectrum analyzer with resolution bandwidth in the range of 1 % to 5 % of the anticipated emission bandwidth, and a video bandwidth at least 3x the resolution bandwidth and set the detector to PEAK. The width of a frequency band such that, below the lower and above the upper frequency limits, the mean powers emitted are each equal to a specified percentage 0.5 % of the total mean power of a given emission.

**Test Results**

Please refer to Appendix A.

### 5.1.4 Conducted Spurious Emissions and Frequency Band Edges Measured in 100kHz Bandwidth

**Limit**

20dB (below that in the 100 kHz bandwidth within the band that contains the highest level of the desired power.)

**Kind of Test Site**                      Shielded room

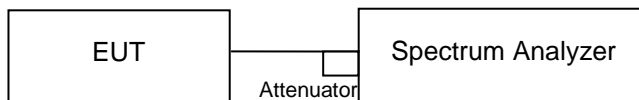
**Test Setup**

**Test Instruments**

Kind of Equipment	Manufacturer	Type	S/N	Calibration Date	Calibration Due Date	Test Date	
						From	Until
Spectrum Analyzer	R&S	FSV40	101512	2021/1/29	2022/1/28	2021/8/11	2021/8/18

**Test Procedure**

The transmitter output was connected to the spectrum analyzer via a low lose cable. Set both RBW and VBW of spectrum analyzer to 100 kHz and 300 kHz with suitable frequency span including 100 MHz bandwidth from band edge. The band edges was measured and recorded.

**Test Results**

Please refer to Appendix A.

### 5.1.5 Radiated Spurious Emissions and Band Edges

#### Limit

Radiated emissions which fall in the restricted bands, as defined in §15.205(a), must comply with the radiated emission limits specified in §15.209(a).

Emissions radiated outside the restricted and authorized frequency bands must either comply with the radiated emission limits specified for the restricted bands or in §15.247(d).

**Kind of Test Site**                      3m Semi-Anechoic Chamber

#### Test Setup

**<Radiated Emissions below 30 MHz>**

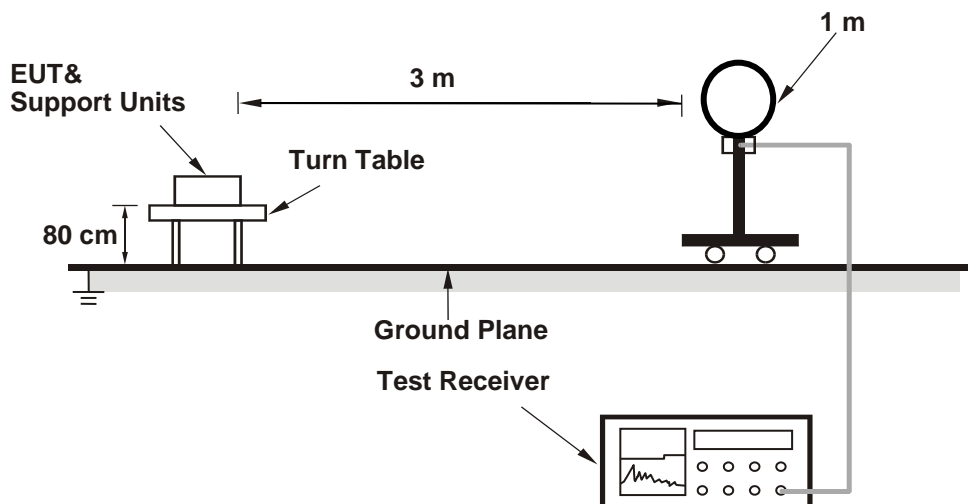

**<Radiated Emissions 30 MHz to 1 GHz>**

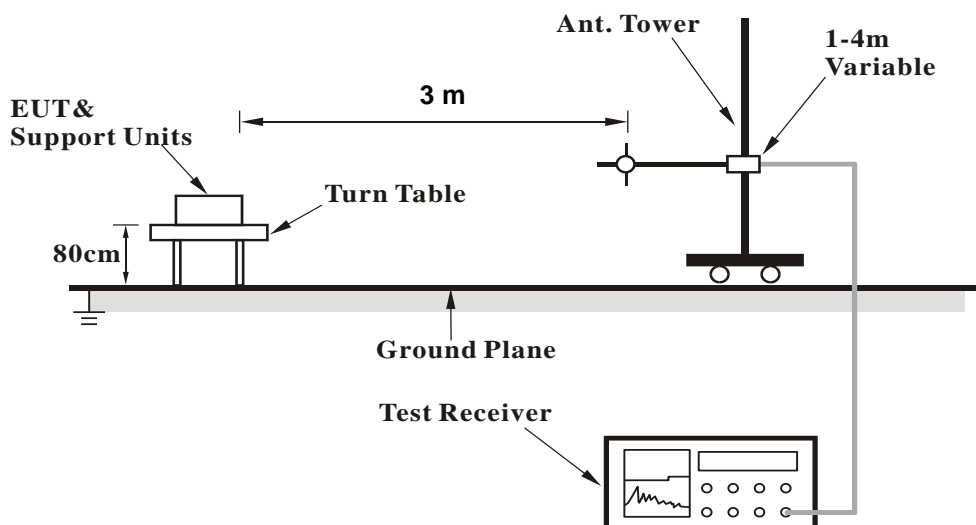

## &lt;Radiated Emissions above 1 GHz&gt;

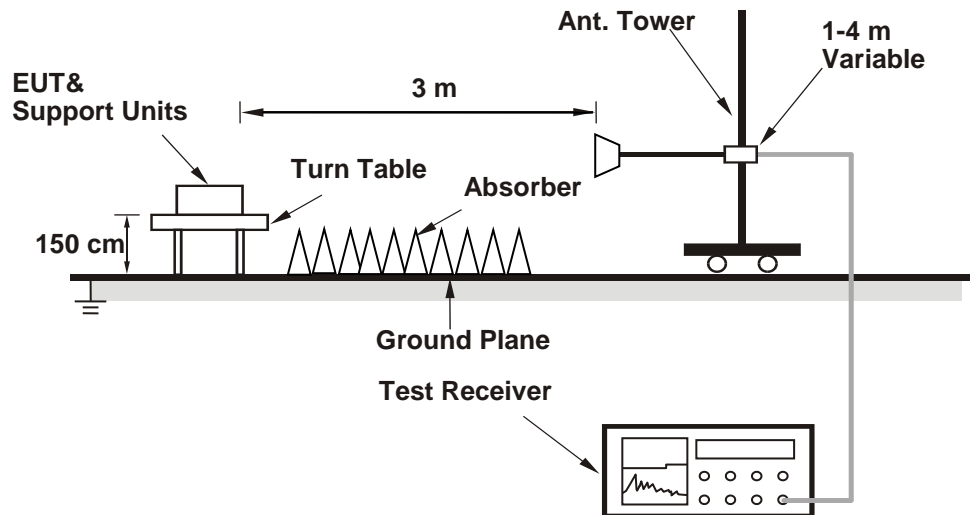

For the actual test configuration, please refer to the attached file (Test Setup Photo).

**Test Instruments**

Kind of Equipment	Manufacturer	Type	S/N	Calibration Date	Calibration Due Date
Signal Analyzer	R&S	FSV40	101508	2021/3/16	2022/3/15
Receiver	R&S	ESR7	102109	2021/3/16	2022/3/15
Bilog Antenna	SCHWARZBECK	VULB-9168	00951	2021/2/18	2022/2/17
Horn Antenna	ETS-Lindgren	3117	00218930	2020/12/1	2021/11/30
LF-AMP	Agilent	8447D	2944A10772	2021/2/18	2022/2/17
HF-AMP + AC source	EMCI	EMC051845SE	980633	2021/2/9	2022/2/8
HF-AMP + AC source	EMCI	EMC184045SE	980657	2021/2/1	2022/1/31
Horn Antenna	SCHWARZBECK	BBHA 9170	00887	2021/4/8	2022/4/7
Microwave Cable	HUBER+SUHNER	SUCOFLEX 104EA	800056/4EA	2021/3/17	2022/3/16
Microwave Cable	HUBER+SUHNER	SUCOFLEX 104	804680/4	2021/3/17	2022/3/16
Microwave Cable	HUBER+SUHNER	SUCOFLEX 104	MY37202/4	2021/3/17	2022/3/16
Microwave Cable	HUBER+SUHNER	SUCOFLEX 102EA	800898/2EA	2021/4/16	2022/4/15
Microwave Cable	HUBER+SUHNER	SUCOFLEX 102EA	800901/2EA	2021/4/16	2022/4/15
Microwave Cable	HUBER+SUHNER	SUCOFLEX 102EA	801027/2EA	2021/4/16	2022/4/15
Loop Antenna	Chance Most	EMCILPA600 +calibration	287	2021/1/15	2022/1/14

**Test Procedures****For Radiated Emissions below 30 MHz**

- a. The EUT was placed on the top of a rotating table 0.8 meters above the ground at a 3 meter chamber room. The table was rotated 360 degrees to determine the position of the highest radiation.
- b. The EUT was set 3 meters away from the interference-receiving antenna, which was mounted on the top of a variable-height antenna tower.
- c. Parallel (OPEN), perpendicular (CLOSE), and ground-parallel (GROUND) orientations of the antenna are set to make the measurement.
- d. For each suspected emission, the EUT was arranged to its worst case and the rotatable table was turned from 0 degrees to 360 degrees to find the maximum reading.
- e. The test-receiver system was set to Quasi-Peak Detect Function and Specified Bandwidth with Maximum Hold Mode.

## Note:

1. The resolution bandwidth and video bandwidth of test receiver/spectrum analyzer is 9 kHz at frequency below 30 MHz.
2. All modes of operation were investigated and the worst-case emissions are reported.

**For Radiated Emissions above 30 MHz**

- a. The EUT was placed on the top of a rotating table 0.8 meters (for 30 MHz ~ 1 GHz) / 1.5 meters (for above 1 GHz) above the ground at 3 meter chamber room for test. The table was rotated 360 degrees to determine the position of the highest radiation.
- b. The EUT was set 3 meters away from the interference-receiving antenna, which was mounted on the top of a variable-height antenna tower.
- c. The height of antenna is varied from one meter to four meters above the ground to determine the maximum value of the field strength. Both horizontal and vertical polarizations of the antenna are set to make the measurement.
- d. For each suspected emission, the EUT was arranged to its worst case and then the antenna was tuned to heights from 1 meter to 4 meters and the rotatable table was turned from 0 degrees to 360 degrees to find the maximum reading.
- e. The test-receiver system was set to quasi-peak detect function and specified bandwidth with maximum hold mode when the test frequency is below 1 GHz.
- f. The test-receiver system was set to peak and average detected function and specified bandwidth with maximum hold mode when the test frequency is above 1 GHz. If the peak reading value also meets average limit, measurement with the average detector is unnecessary.

## Note:

1. The resolution bandwidth and video bandwidth of test receiver/spectrum analyzer is 120 kHz for Quasi-peak detection (QP) or Peak detection (PK) at frequency below 1 GHz.
2. The resolution bandwidth of test receiver/spectrum analyzer is 1 MHz and the video bandwidth is 3 MHz for Peak detection (PK) at frequency above 1 GHz.
3. The resolution bandwidth of test receiver/spectrum analyzer is 1 MHz and the video bandwidth is  $\geq 1/T$  (Duty cycle < 98 %) or 10 Hz (Duty cycle  $\geq 98$  %) for Average detection (AV) at frequency above 1 GHz.
4. All modes of operation were investigated and the worst-case emissions are reported.
5. The Radiated Emissions testing was performed in the X(E1), Y(H) and Z(E2) axis orientation. The worst-case Axis orientation is recorded in this test report.

**Prüfbericht - Nr.: CN21ADTW (P15C-BT) 001**  
*Test Report No.*

**Seite 24 von 29**  
*Page 24 of 29*

**Test Results**

Factor (dB/m) = Antenna Factor (dB/m) + Cable Loss (dB)  
Level (dBuV/m) = Reading (dBuV) + Factor (dB/m)

Please refer to Appendix B.



### 5.1.6 Hopping Channel Separation

**Limit**  $\geq 25$  kHz or 2/3 of 20 dB bandwidth, whichever is greater

**Kind of Test Site** Shielded room

#### Test Setup

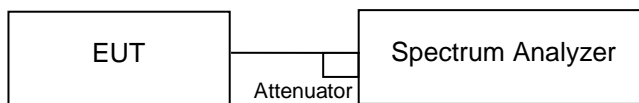

#### Test Instruments

Kind of Equipment	Manufacturer	Type	S/N	Calibration Date	Calibration Due Date	Test Date	
						From	Until
Spectrum Analyzer	R&S	FSV40	101512	2021/1/29	2022/1/28	2021/8/11	2021/8/18

#### Test Procedure

Measurement Procedure REF

- Check the calibration of the measuring instrument using either an internal calibrator or a known signal from an external generator.
- Turn on the EUT and connect it to measurement instrument. Then set it to any one convenient frequency within its operating range.
- By using the MaxHold function record the separation of two adjacent channels.
- Measure the frequency difference of these two adjacent channels by SA MARK function. And then plot the result on SA screen.
- Repeat above procedures until all frequencies measured were complete.

#### Test Results

Please refer to Appendix A.

### 5.1.7 Number of Hopping Frequency

**Limit**  $\geq 15$  non-overlapping channels

**Kind of Test Site** Shielded room

**Test Setup**

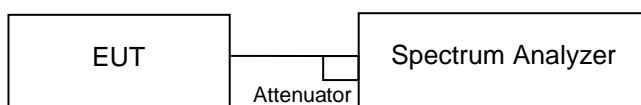

**Test Instruments**

Kind of Equipment	Manufacturer	Type	S/N	Calibration Date	Calibration Due Date	Test Date	
						From	Until
Spectrum Analyzer	R&S	FSV40	101512	2021/1/29	2022/1/28	2021/8/11	2021/8/18

**Test Procedure**

- a. Check the calibration of the measuring instrument (SA) using either an internal calibrator or a known signal from an external generator.
- b. Turn on the EUT and connect its antenna terminal to measurement via a low loss cable. Then set it to any one measured frequency within its operating range and make sure the instrument is operated in its linear range.
- c. Set the SA on MaxHold Mode, and then keep the EUT in hopping mode. Record all the signals from each channel until each one has been recorded.
- d. Set the SA on View mode and then plot the result on SA screen.
- e. Repeat above procedures until all frequencies measured were complete.

**Test Results**

Please refer to Appendix A.

### 5.1.8 Dwell Time

**Limit** 0.4s

**Kind of Test Site** Shielded room

**Test Setup**

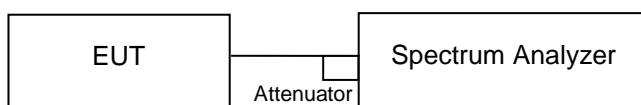

**Test Instruments**

Kind of Equipment	Manufacturer	Type	S/N	Calibration Date	Calibration Due Date	Test Date	
						From	Until
Spectrum Analyzer	R&S	FSV40	101512	2021/1/29	2022/1/28	2021/8/11	2021/8/18

**Test Procedures**

- a. Check the calibration of the measuring instrument (SA) using either an internal calibrator or a known signal from an external generator.
- b. Turn on the EUT and connect its antenna terminal to measurement via a low loss cable. Then set it to any one measured frequency within its operating range and make sure the instrument is operated in its linear range.
- c. Adjust the center frequency of SA on any frequency be measured and set SA to zero span mode. And then, set RBW and VBW of spectrum analyzer to proper value.
- d. Measure the time duration of one transmission on the measured frequency. And then plot the result with time difference of this time duration.
- e. Repeat above procedures until all different time-slot modes have been completed.

**Test Results**

Please refer to Appendix A.

## 5.2 Mains Emission

### 5.2.1 Mains Conducted Emission

#### Limit

Mains Conducted Emission as defined in §15.207 must comply with the mains conducted emission limits.

**Kind of Test Site**                      Shielded room

#### Test Setup

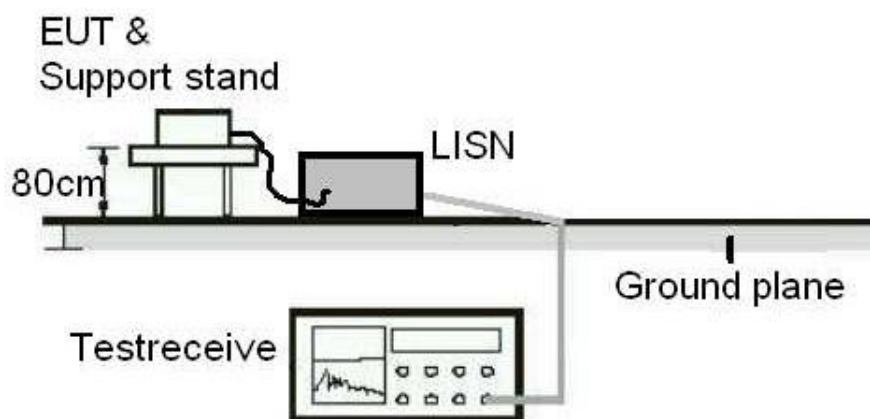

#### Test Instruments

Kind of Equipment	Manufacturer	Type	S/N	Calibration Date	Calibration Due Date
TWO-LINE V-NETWORK	R&S	ENV216	1816064	2020/9/10	2021/9/9
EMI Test Receiver	R&S	ESCI	1816063	2020/11/17	2021/11/16
RF Cable	N/A	N/A	EMC-003	2020/11/15	2021/11/14

### Test Procedures

- a. The EUT was placed 0.4 meters from the conducting wall of the shielded room with EUT being connected to the power mains through a line impedance stabilization network (LISN). Other support units were connected to the power mains through another LISN. The two LISNs provide 50 ohm/50 uH of coupling impedance for the measuring instrument.
- b. Both lines of the power mains connected to the EUT were checked for maximum conducted interference.
- c. The frequency range from 150 kHz to 30 MHz was searched. Emission levels under (Limit – 20 dB) was not recorded.

Note: The resolution bandwidth and video bandwidth of test receiver is 9 kHz for quasi-peak detection (QP) and average detection (AV) at frequency 0.15 MHz – 30 MHz.

### Test Results

Please refer to Appendix B.

## Appendix A: Test Results of Conducted Test

### Test Result of 20 dB Bandwidth

#### GFSK

Channel	Channel Frequency (MHz)	20 dB Bandwidth (kHz)	Result
Low Channel	2402	938.06	Pass
Middle Channel	2441	938.06	Pass
High Channel	2480	938.06	Pass

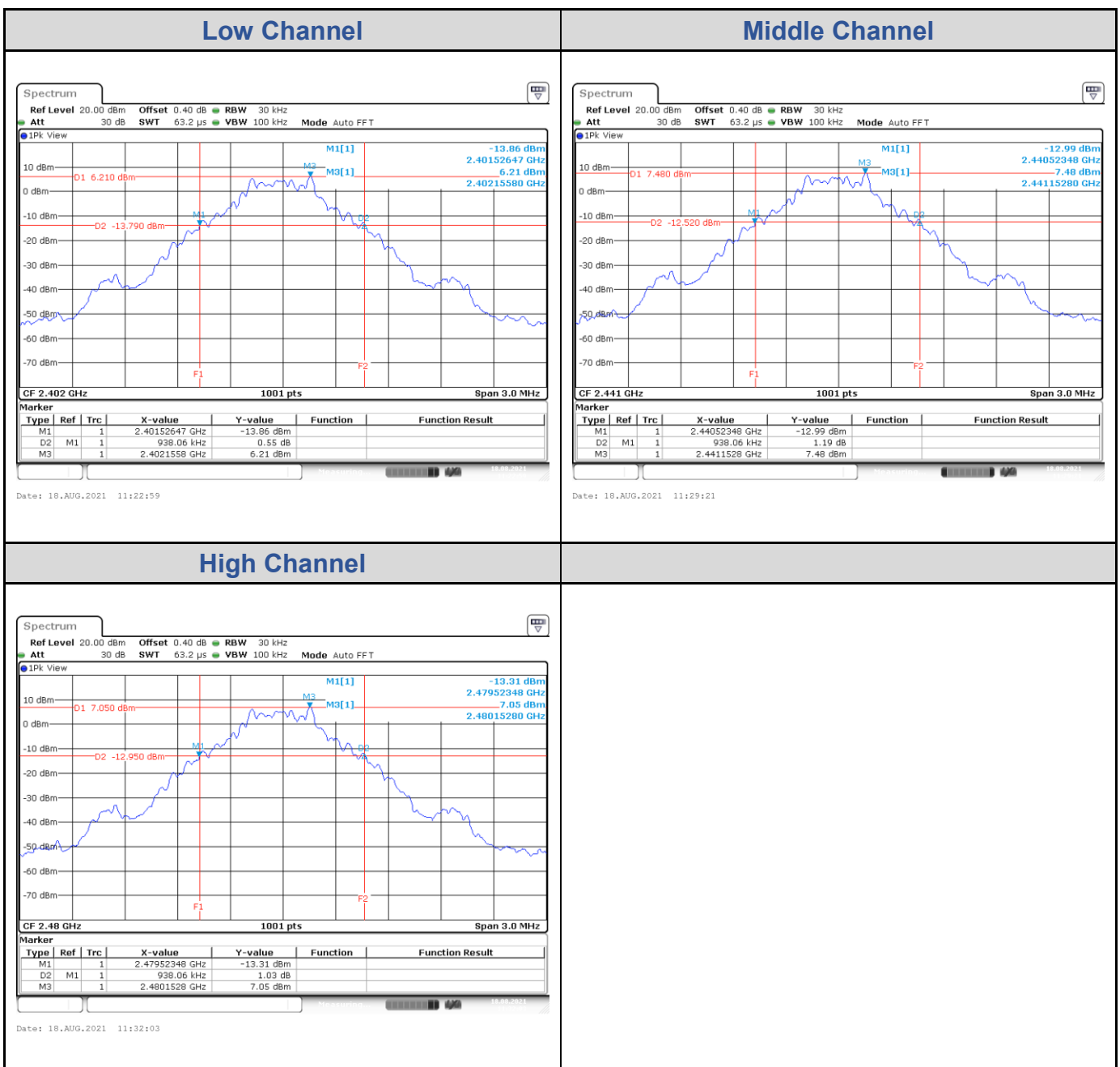

**8DPSK**

Channel	Channel Frequency (MHz)	20 dB Bandwidth (kHz)	Result
Low Channel	2402	1285.71	Pass
Middle Channel	2441	1288.71	Pass
High Channel	2480	1288.71	Pass

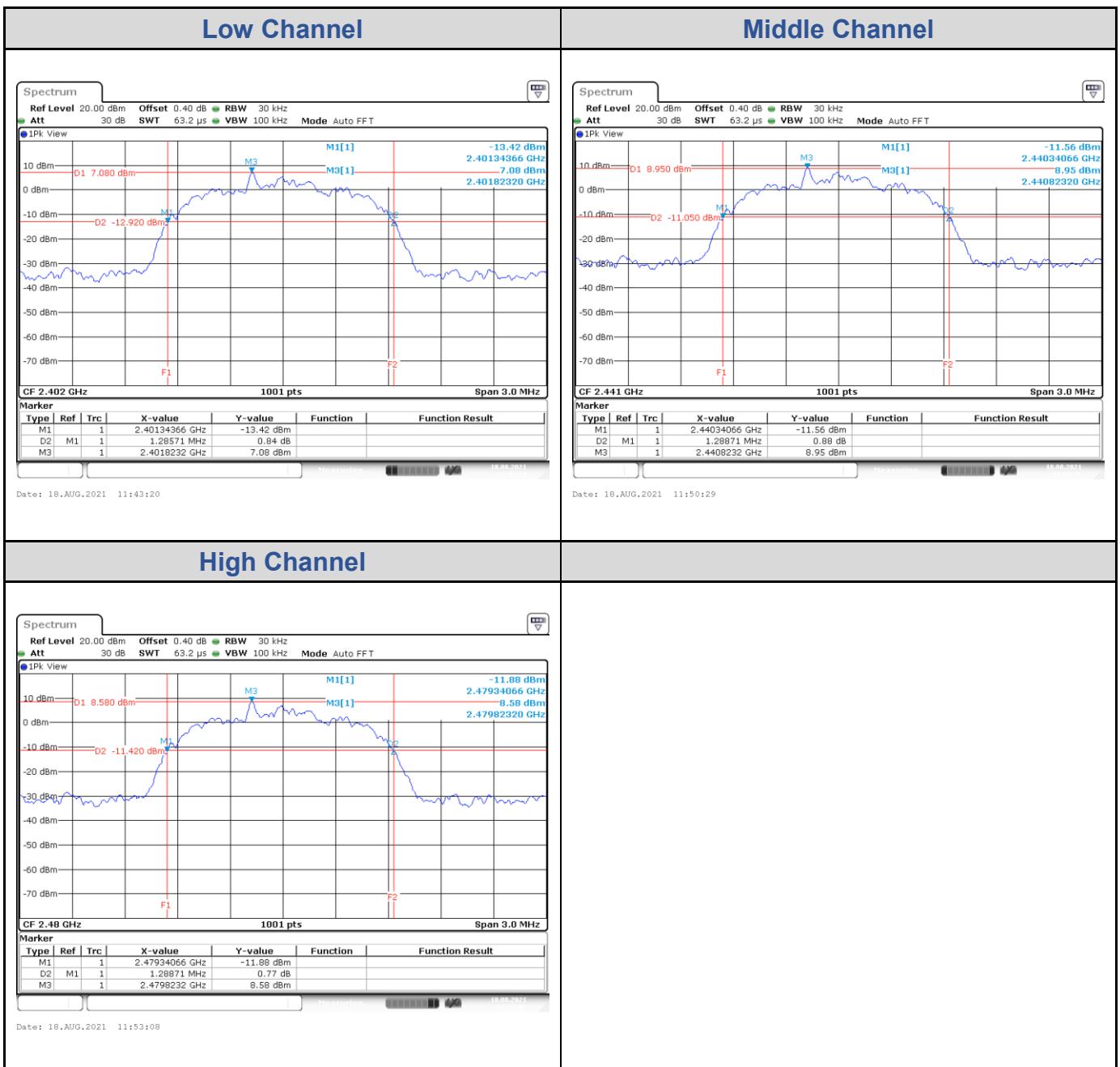

## Test Result of 99% Occupied Bandwidth

### GFSK

Channel	Channel Frequency (MHz)	99% Bandwidth (kHz)
Low Channel	2402	848.15
Middle Channel	2441	848.15
High Channel	2480	848.15

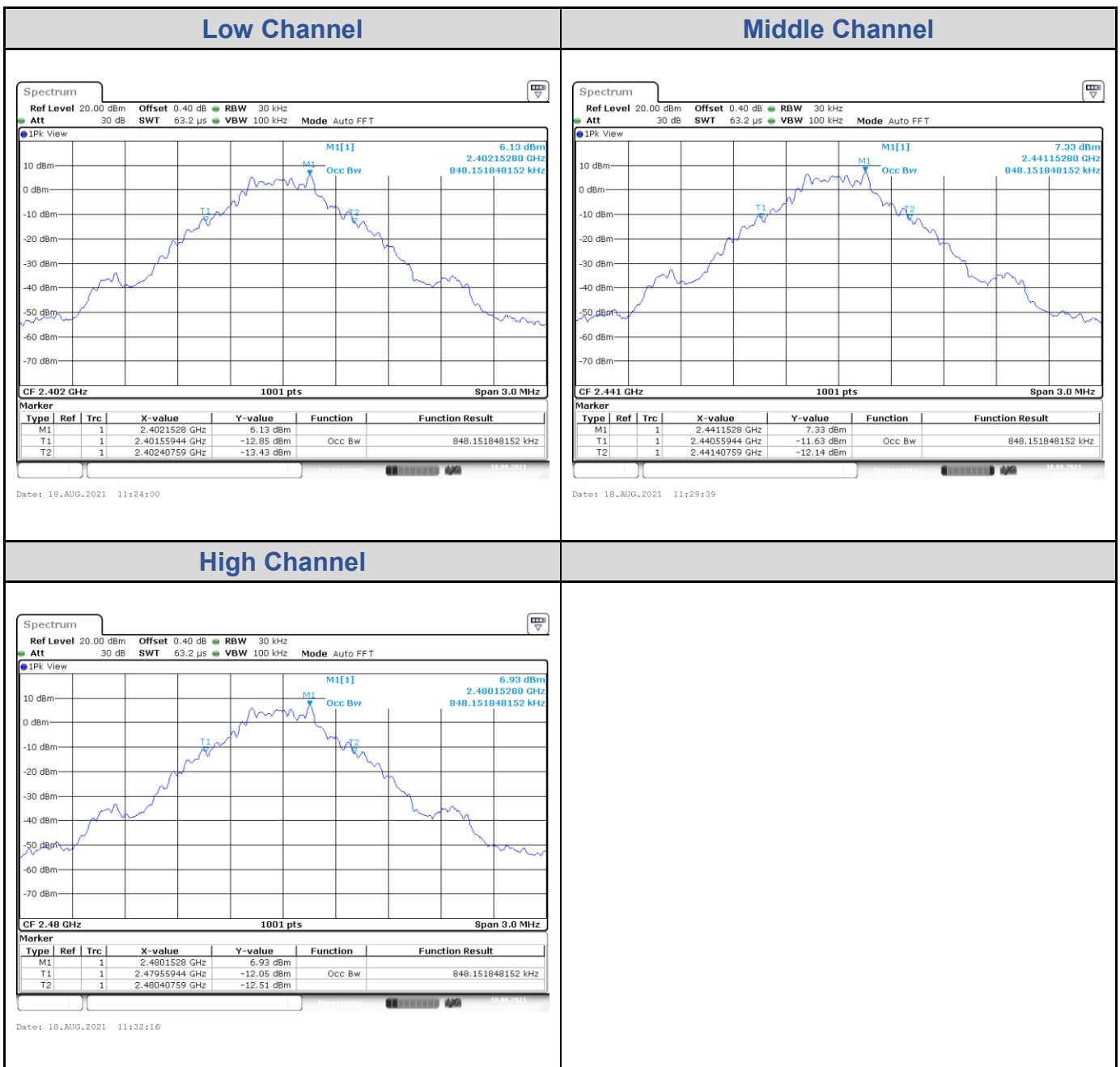



**8DPSK**

Channel	Channel Frequency (MHz)	99% Bandwidth (kHz)
Low Channel	2402	1171.83
Middle Channel	2441	1162.84
High Channel	2480	1162.84

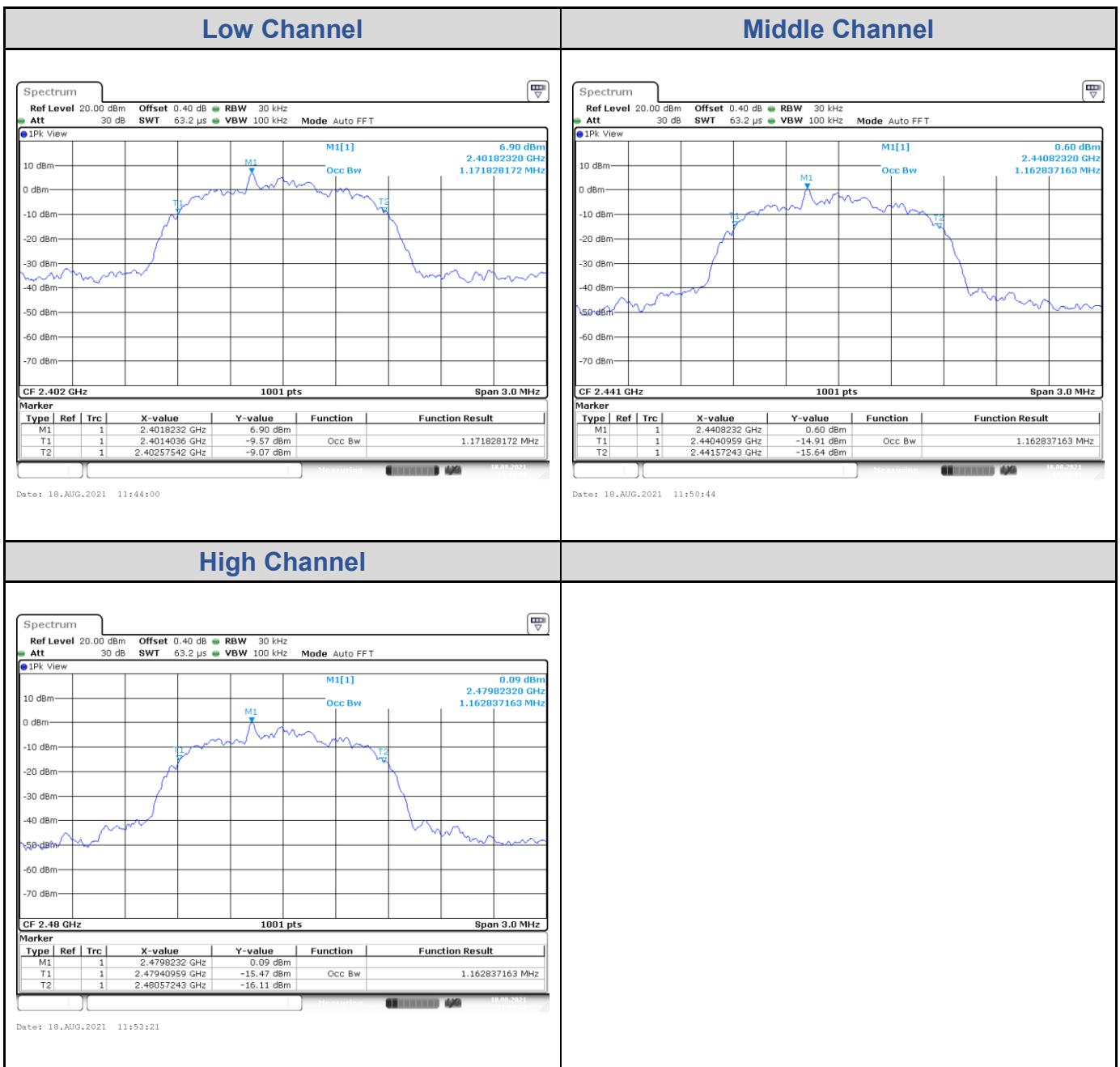

### Test Result of Conducted Spurious Emissions, Tx Mode

#### GFSK

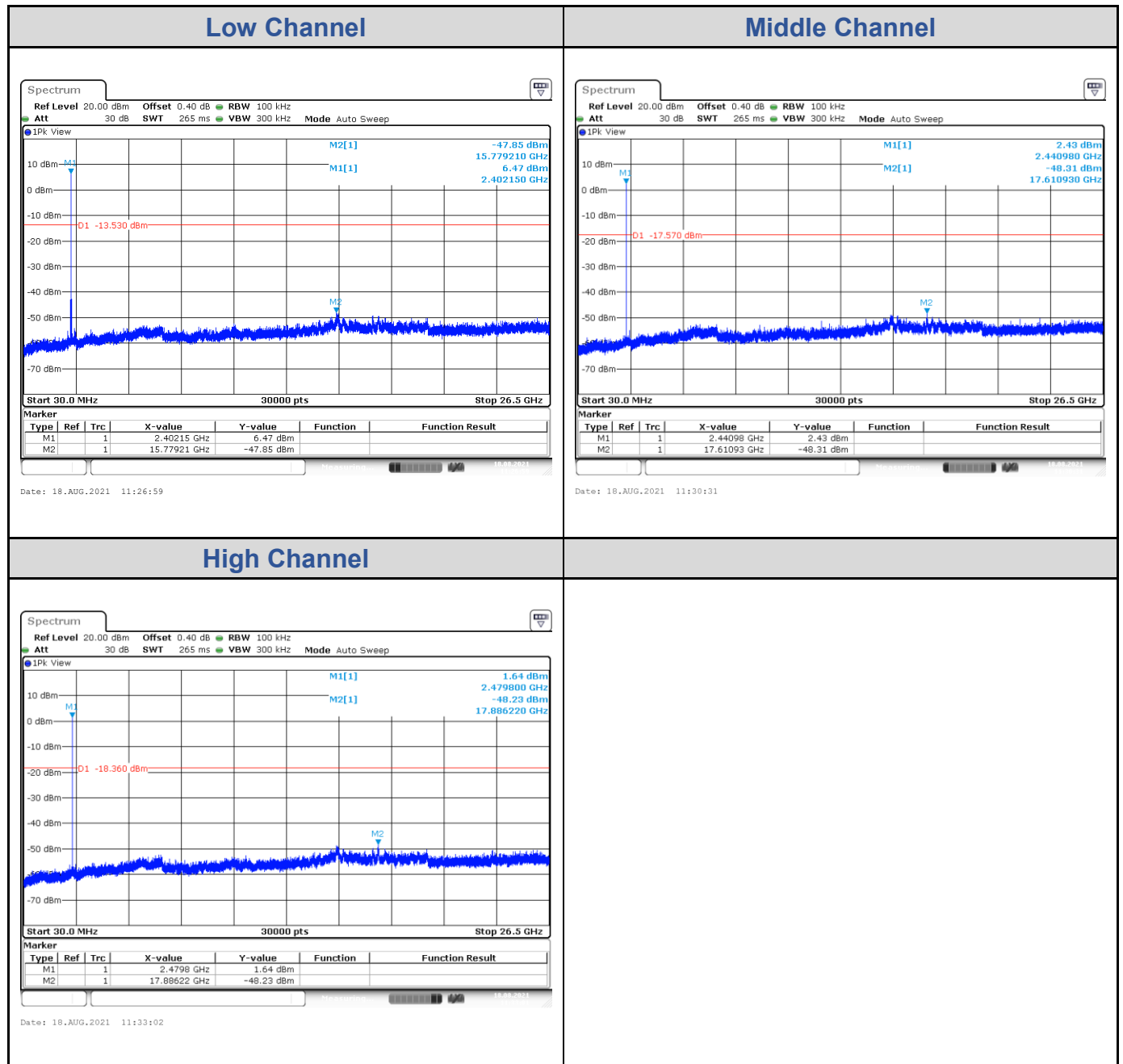

8DPSK

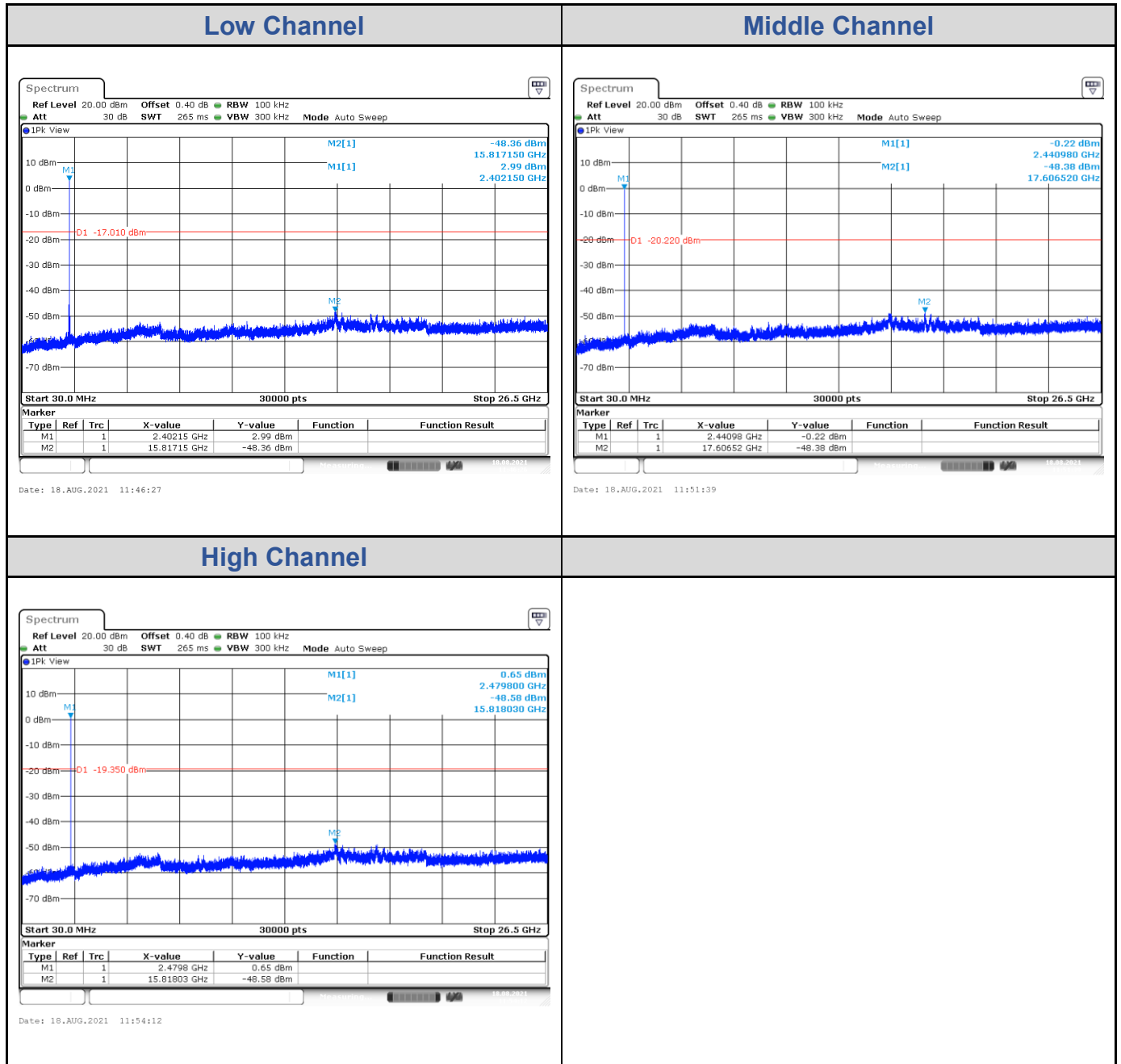

## Test Result of Conducted Band Edge, Tx Mode

### GFSK

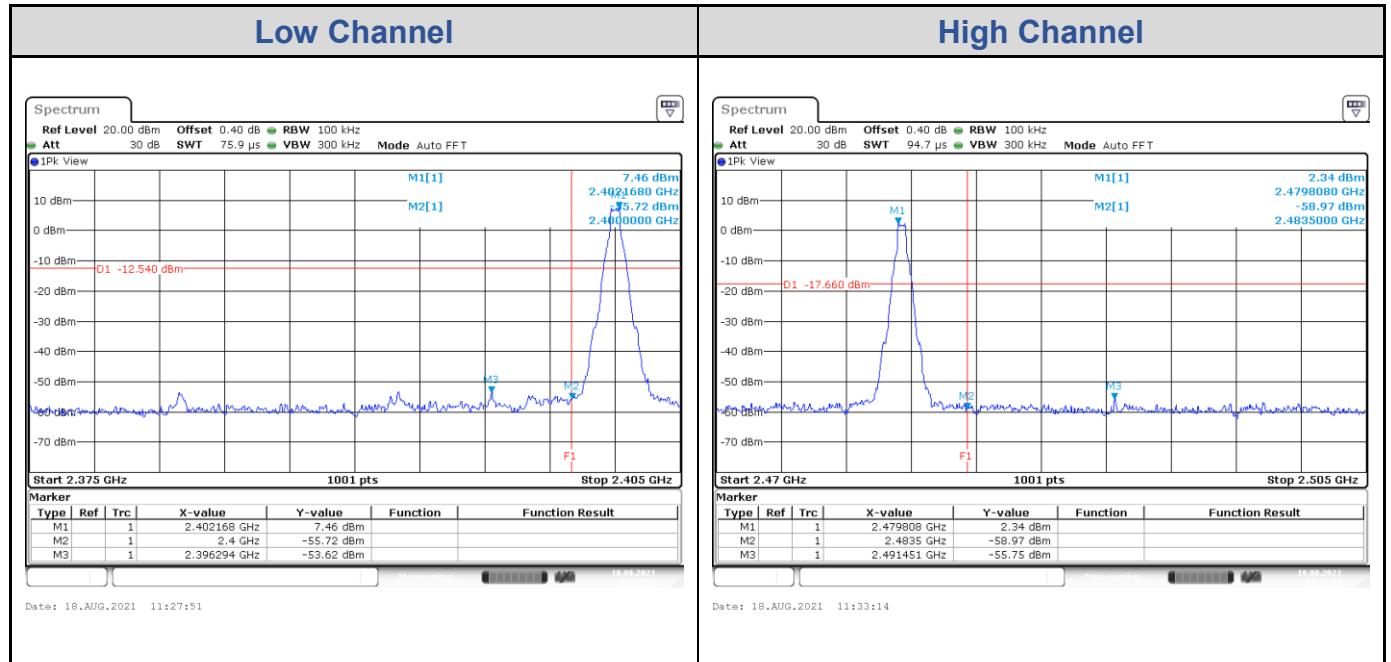

### 8DPSK

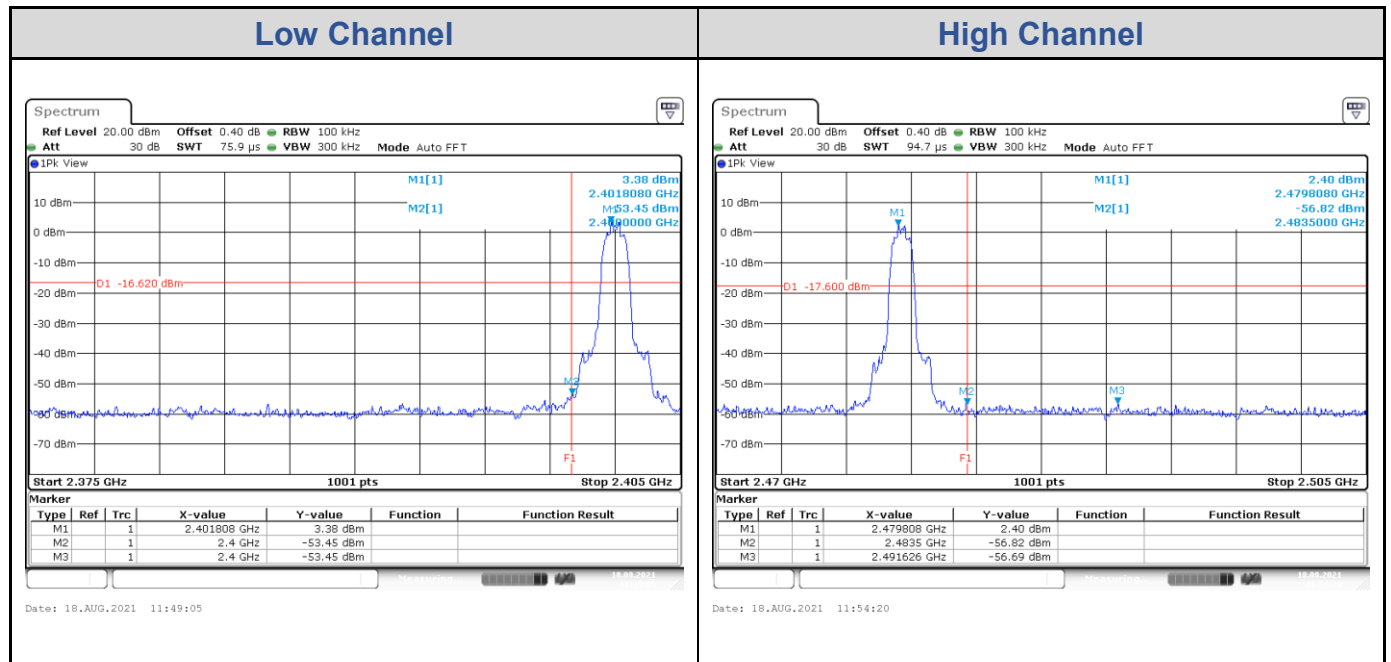

## Test Result of Hopping Band Edge

### GFSK

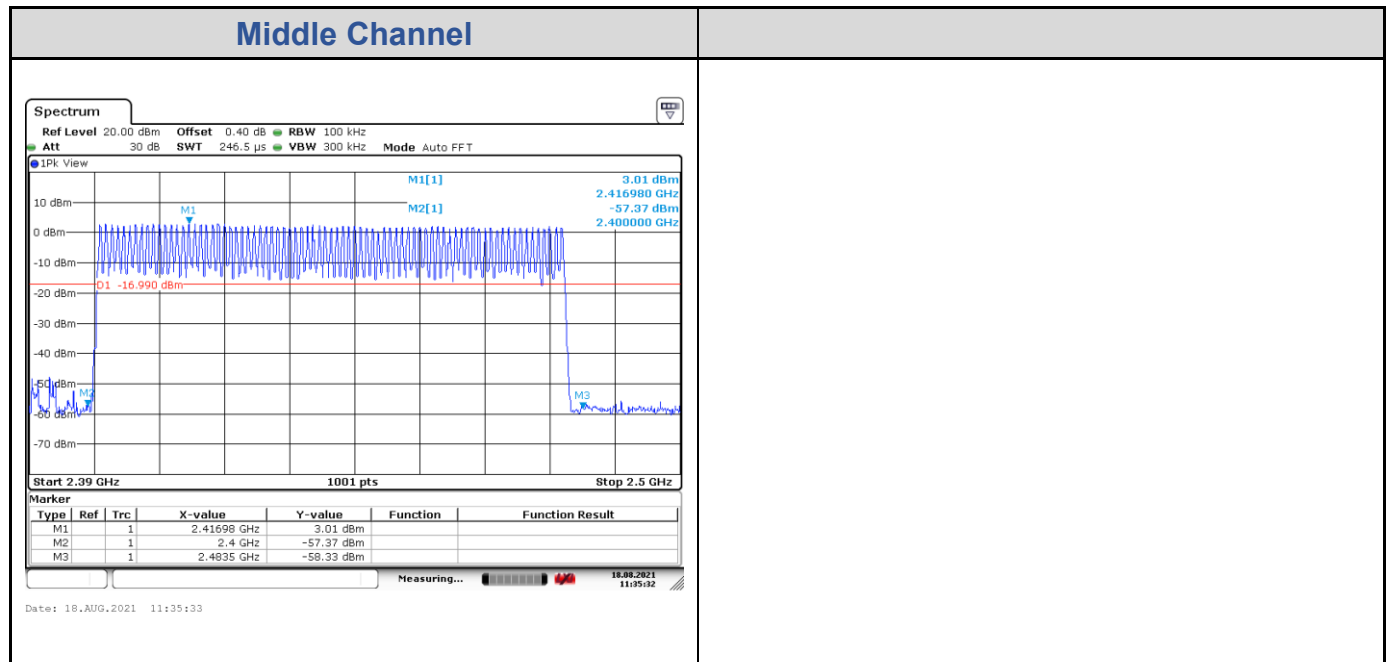

### 8DPSK

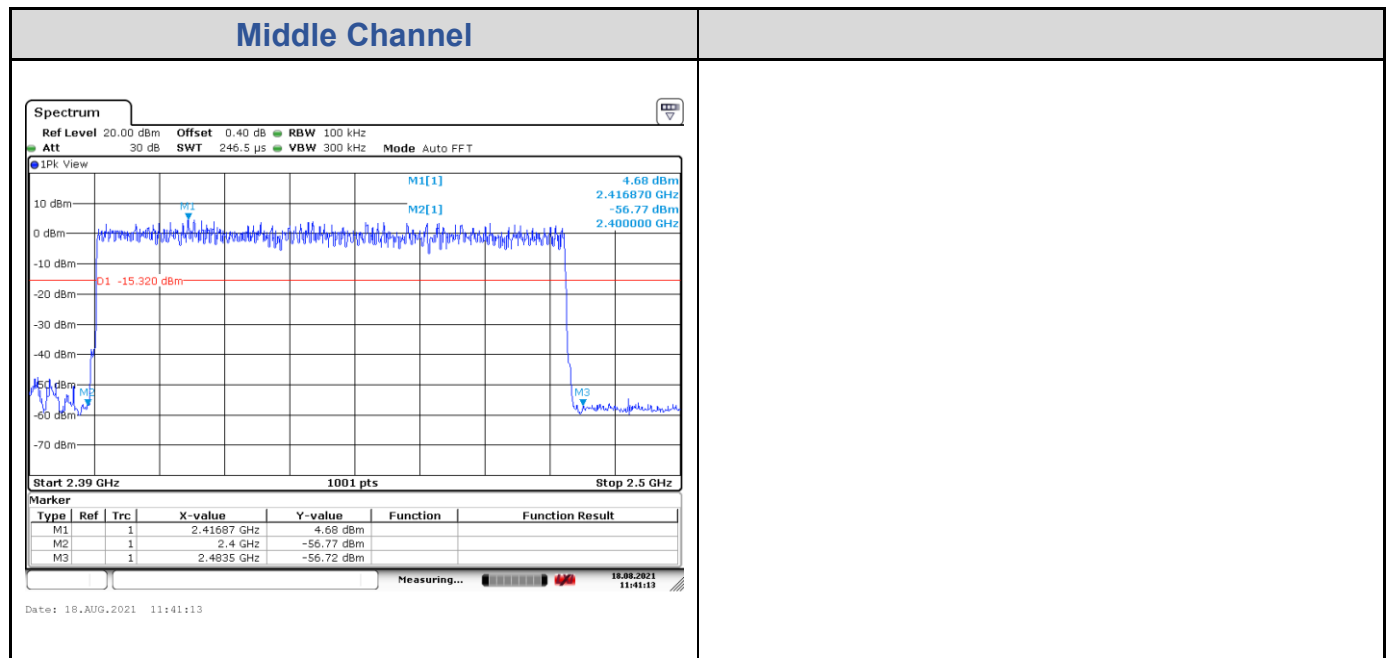

## Test Result of Hopping Channel Separation

### GFSK

Channel	Channel Frequency (MHz)	Adjacent Channel Separation (MHz)	20 dB Bandwidth (kHz)	Minimum Limit (MHz)	Result
0	2402	1.00	938.06	0.625	Pass
39	2441	1.00	938.06	0.625	Pass
78	2480	1.00	938.06	0.625	Pass

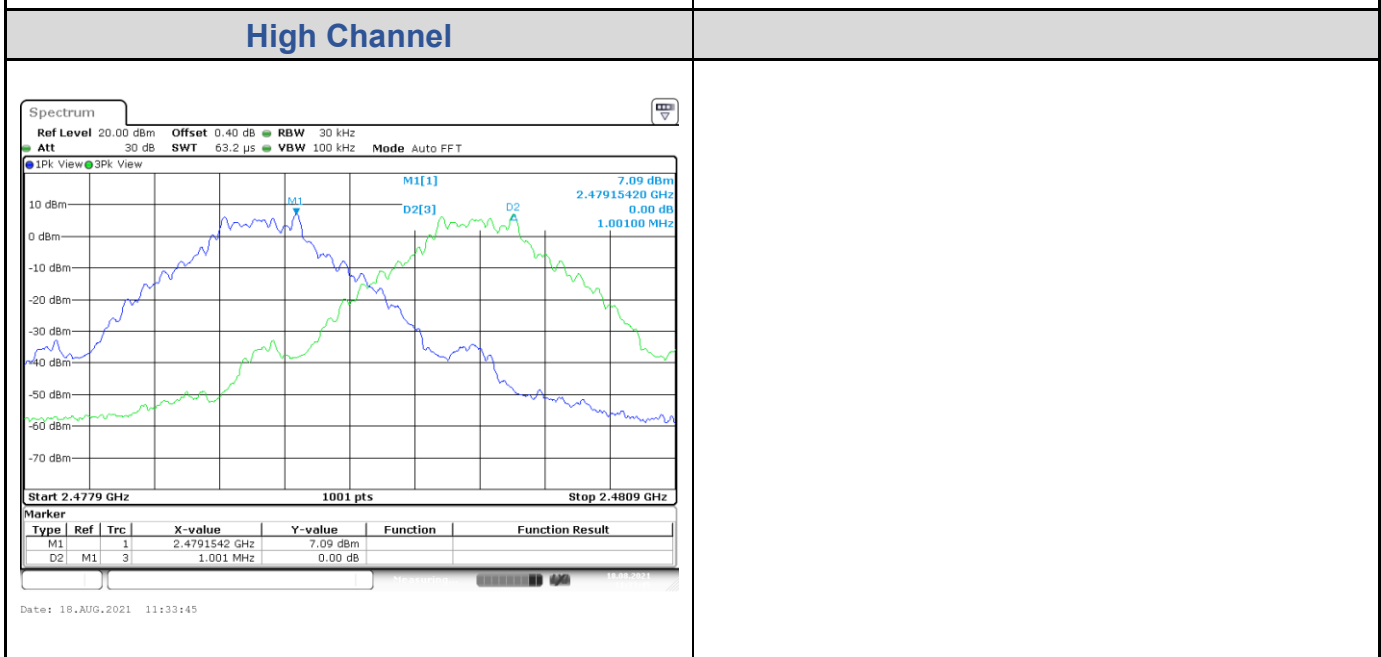
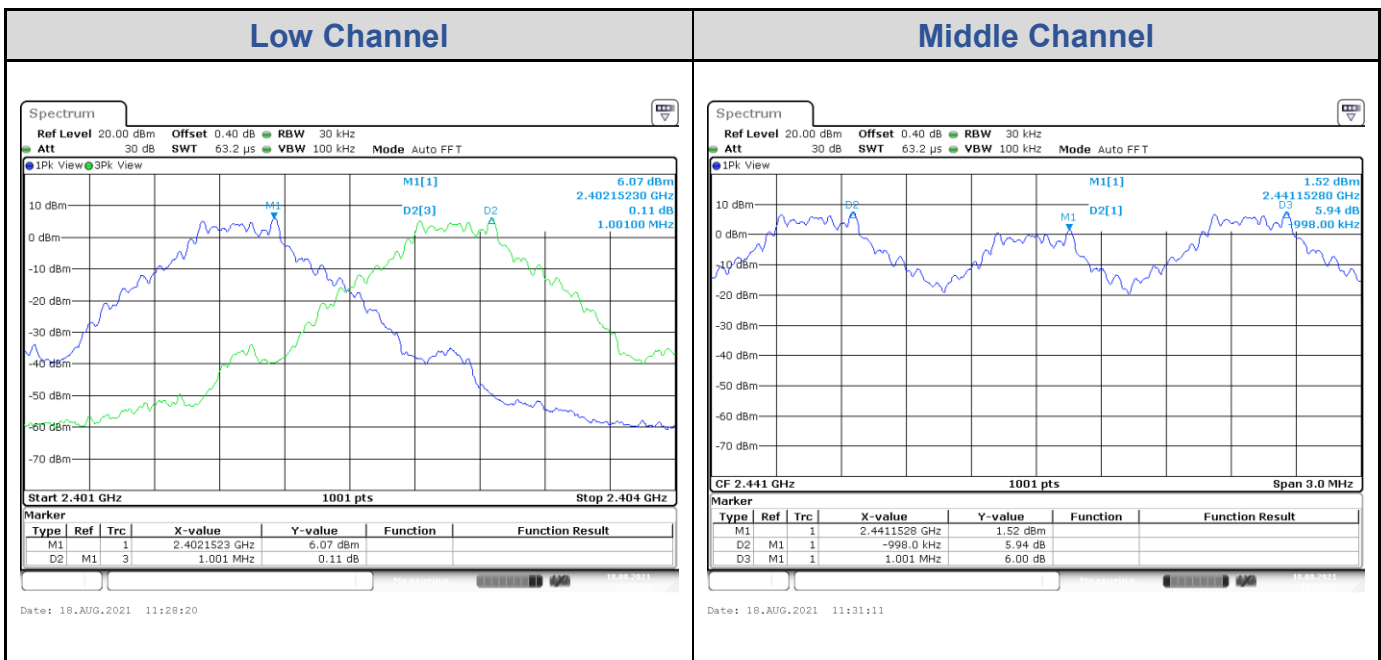

**8DPSK**

Channel	Channel Frequency (MHz)	Adjacent Channel Separation (MHz)	20 dB Bandwidth (kHz)	Minimum Limit (MHz)	Result
0	2402	1.00	1285.71	0.857	Pass
39	2441	1.00	1288.71	0.859	Pass
78	2480	1.00	1288.71	0.859	Pass

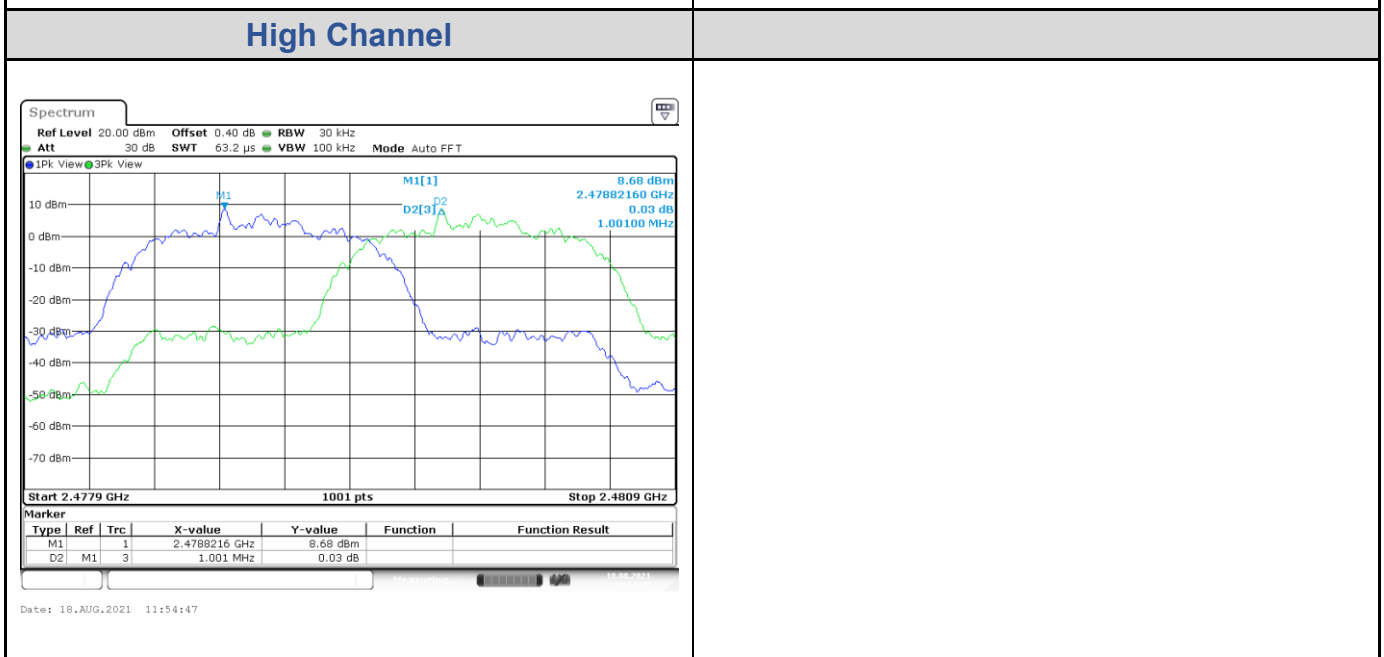
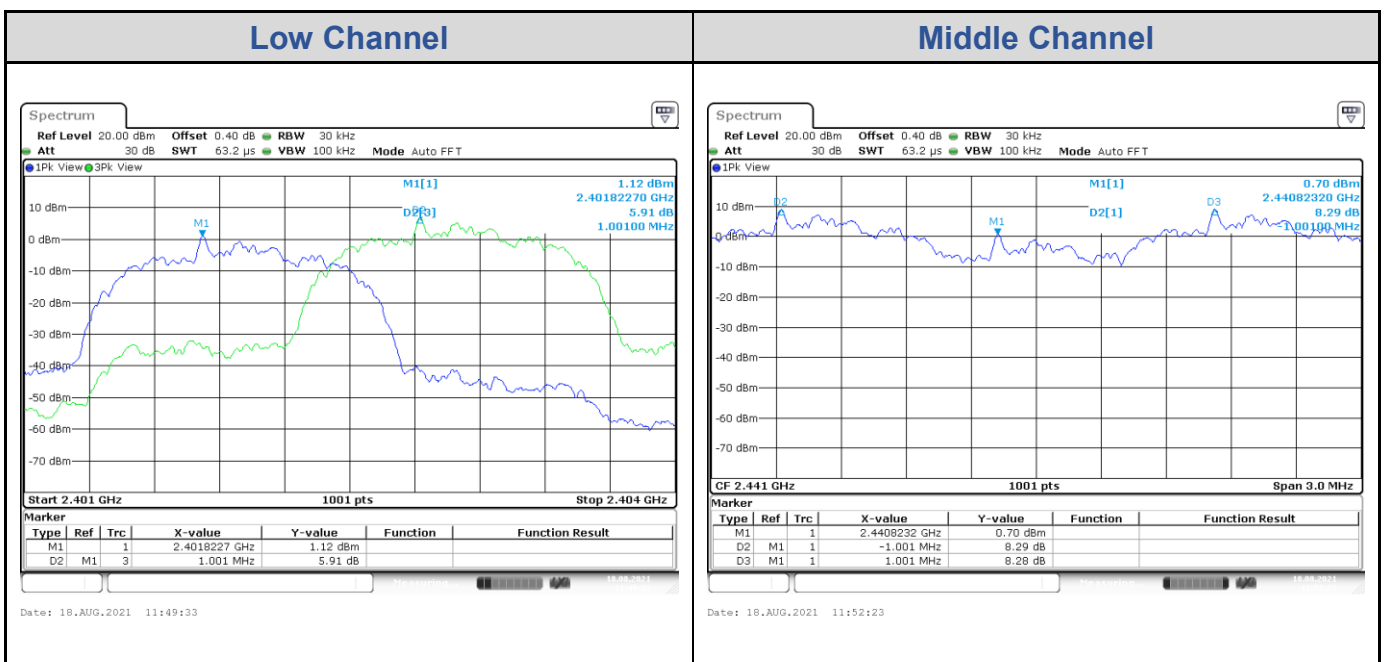

## Test Result of Number of Hopping Frequency

Frequency Range	Measured Quantity of Hopping Channel	Limit	Result
2400 to 2483.5 MHz	79	≥15	Pass

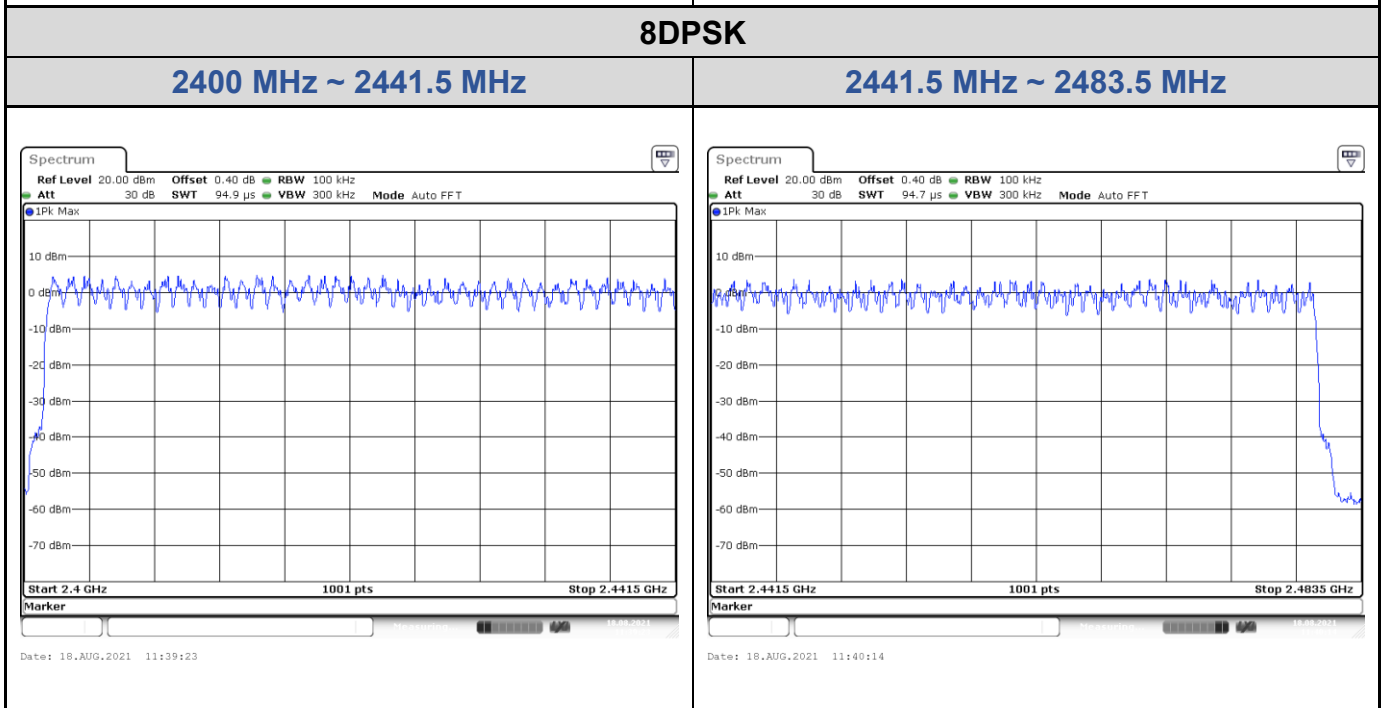
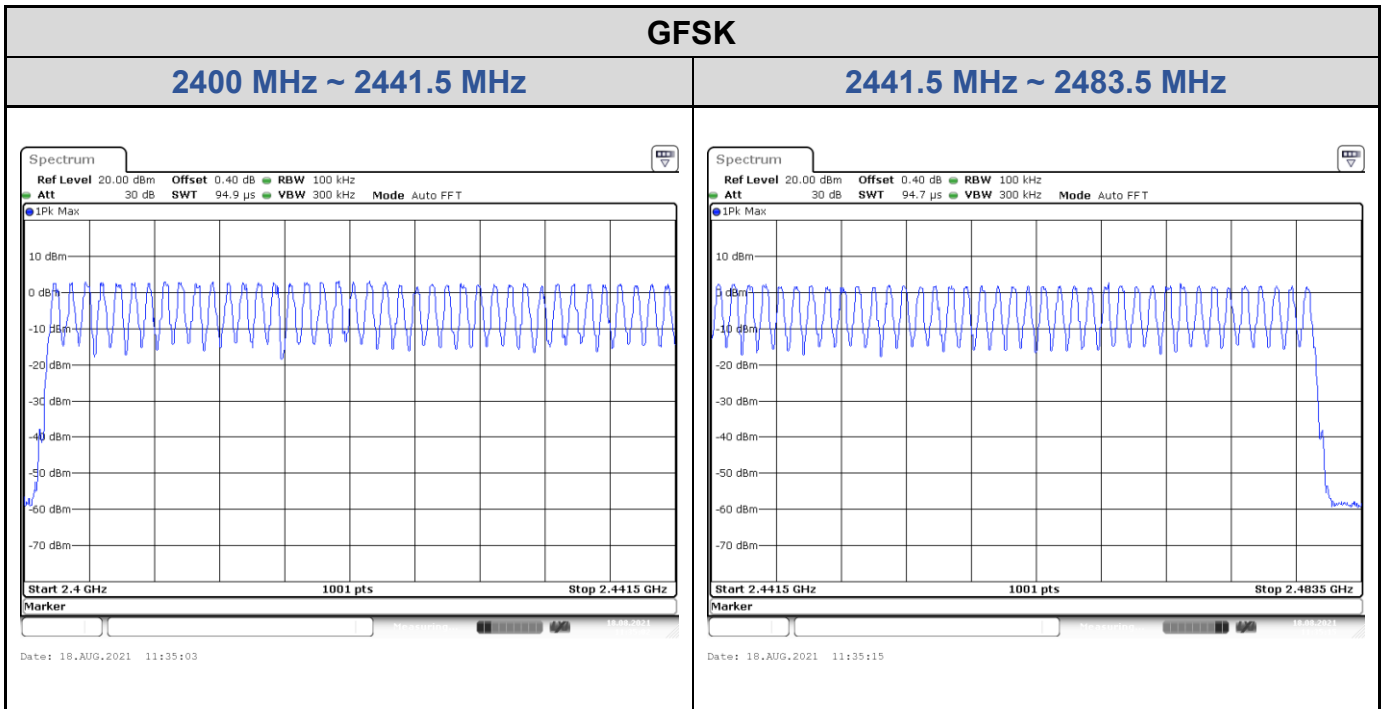



## Test Result of Dwell Time

### GFSK

Data Mode	Number of transfer in a 31.6 (79Hopping*0.4s)	Package transfer time (msec)	Dwell time (s)	Limit (s)	Result
1DH5	16 (times / 5 sec) * 6.32 = 101.12 times	2.92	0.29527	0.4	Pass

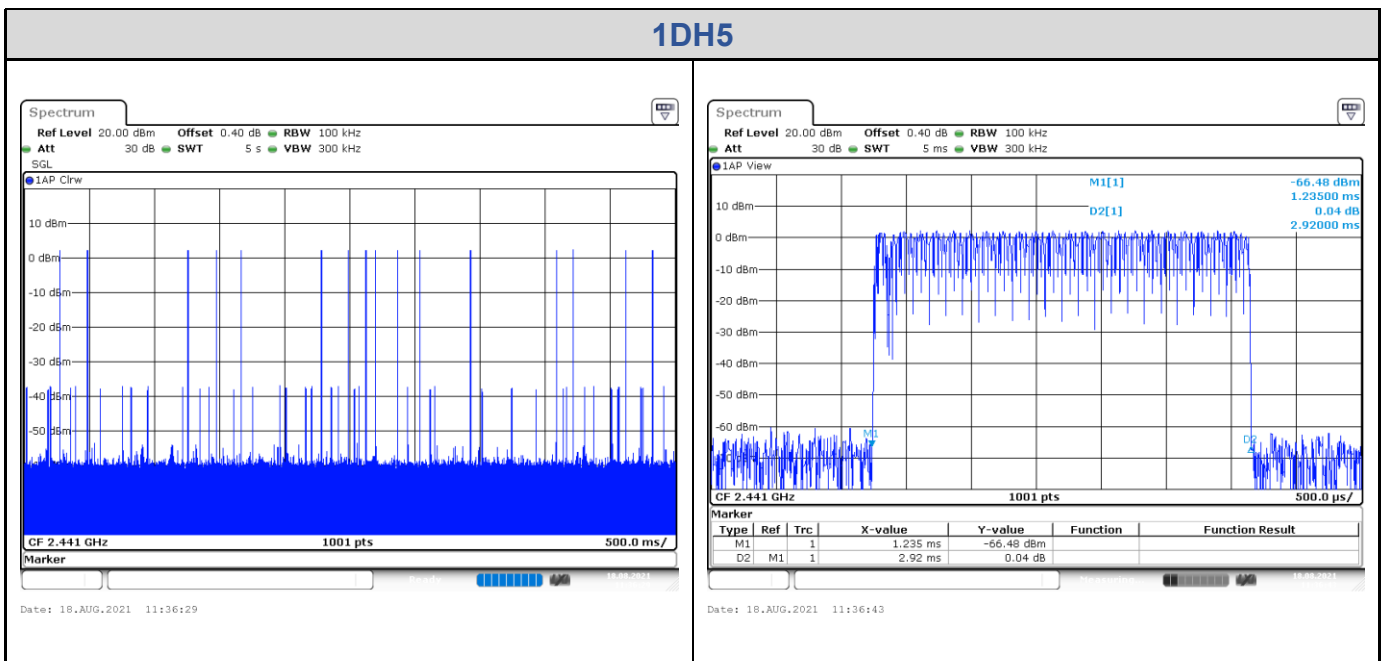

**8DPSK**

Data Mode	Number of transfer in a 31.6 (79Hopping*0.4s)	Package transfer time (msec)	Dwell time (s)	Limit (s)	Result
3DH5	15 (times / 5 sec) * 6.32 = 94.8 times	2.925	0.27729	0.4	Pass

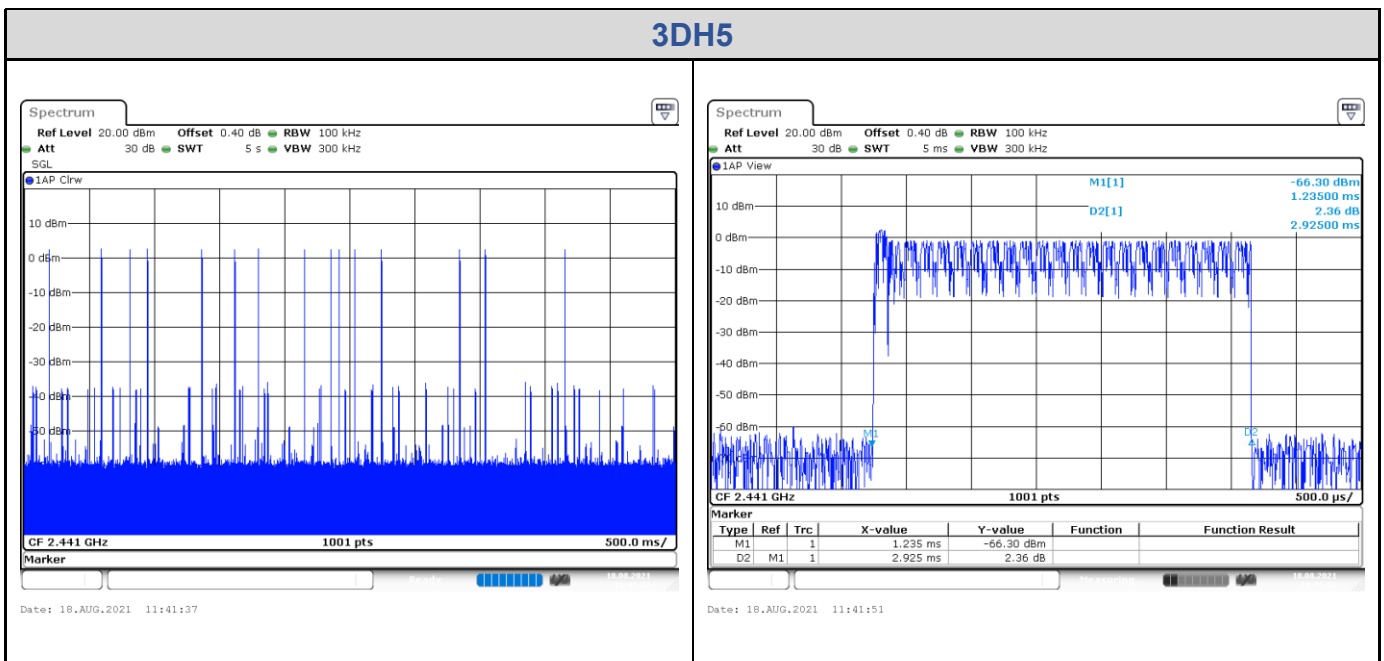

# Appendix B: Test Results of Radiated Emissions & Mains Conducted

## Emission Test

### Band Edges, 2.31GHz ~ 2.9GHz

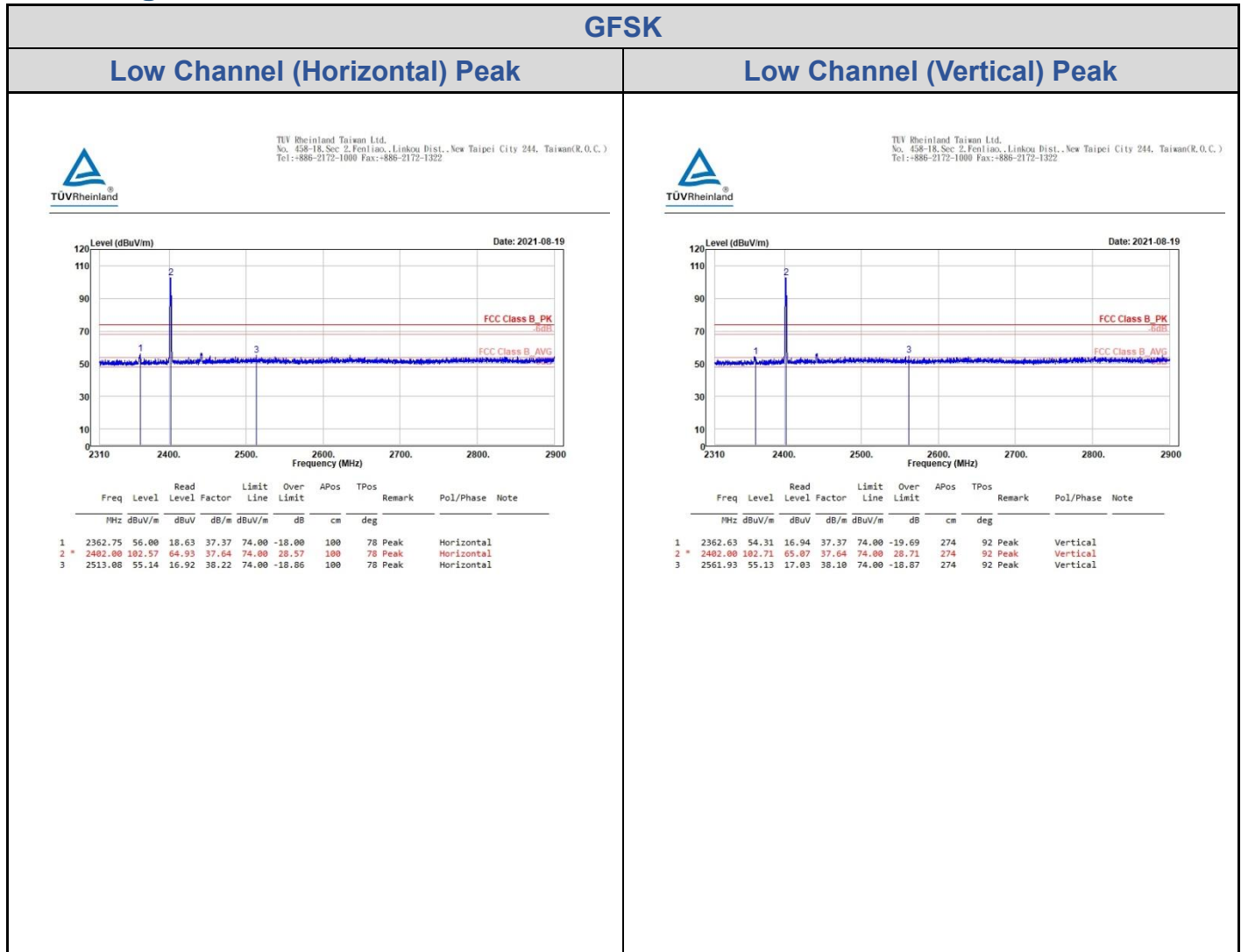

GFSK

Low Channel (Horizontal) Average

Low Channel (Vertical) Average



TÜV Rheinland Taiwan Ltd.  
No. 438-18, Sec. 2, Fenliao, Linkou Dist., New Taipei City 244, Taiwan(R.O.C.)  
Tel: +886-2172-1000 Fax: +886-2172-1322

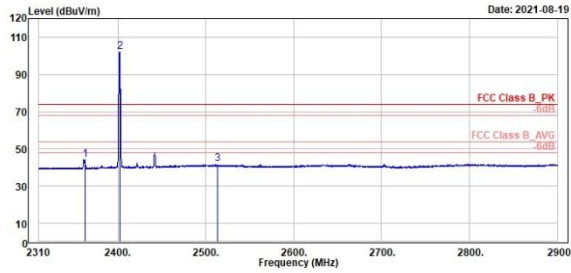

Freq	Level	Read	Limit	Over	APos	TPos	Remark	Pol/Phase	Note
MHz	dBuV/m	dBuV	dB/m	dBuV/m	dB	cm	deg		
1	2362.75	44.28	6.91	37.37	54.00	-9.72	100	78 Average	Horizontal
2 *	2482.00	102.03	64.39	37.64	54.00	48.03	100	78 average	Horizontal
3	2513.00	41.78	3.56	38.22	54.00	-12.22	100	78 Average	Horizontal



TÜV Rheinland Taiwan Ltd.  
No. 438-18, Sec. 2, Fenliao, Linkou Dist., New Taipei City 244, Taiwan(R.O.C.)  
Tel: +886-2172-1000 Fax: +886-2172-1322

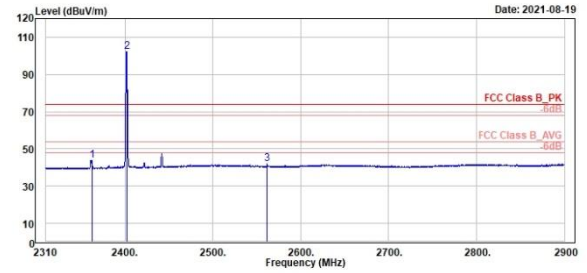

Freq	Level	Read	Limit	Over	APos	TPos	Remark	Pol/Phase	Note
MHz	dBuV/m	dBuV	dB/m	dBuV/m	dB	cm	deg		
1	2362.63	43.91	6.54	37.37	54.00	-10.09	274	92 Average	Vertical
2 *	2482.00	102.18	64.54	37.64	54.00	48.18	274	92 Average	Vertical
3	2561.93	41.92	3.82	38.10	54.00	-12.08	274	92 Average	Vertical

**GFSK**
**High Channel (Horizontal) Peak**
**High Channel (Vertical) Peak**

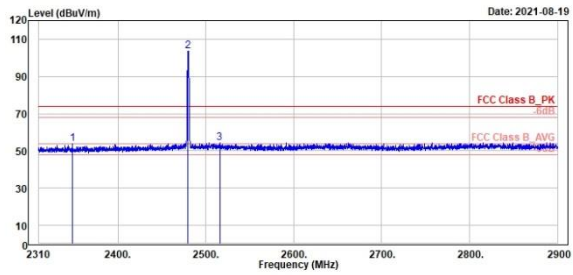

TÜV Rheinland Taiwan Ltd.  
 No. 438-18, Sec. 2, Fenliao, Linkou Dist., New Taipei City 244, Taiwan(R.O.C.)  
 Tel: +886-2172-1000 Fax: +886-2172-1322



Peak	Freq (MHz)	Level (dBuV/m)	Read Level (dBuV)	Level Factor (dB/m)	Limit Line (dBuV/m)	Over Limit (dB)	APos (cm)	TPos (deg)	Remark	Pol/Phase	Note
1	2348.47	53.73	16.46	37.27	74.00	-20.27	187	99	Peak	Horizontal	
2 *	2480.00	103.36	65.21	38.15	74.00	29.36	187	99	Peak	Horizontal	
3	2515.79	54.51	16.30	38.21	74.00	-19.49	187	99	Peak	Horizontal	

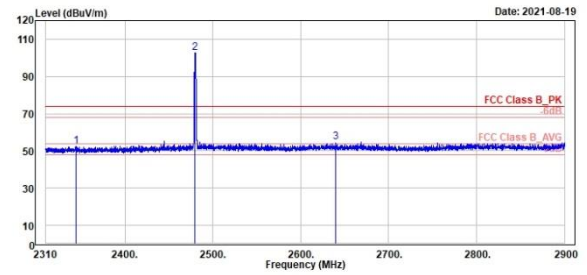

TÜV Rheinland Taiwan Ltd.  
 No. 438-18, Sec. 2, Fenliao, Linkou Dist., New Taipei City 244, Taiwan(R.O.C.)  
 Tel: +886-2172-1000 Fax: +886-2172-1322



Peak	Freq (MHz)	Level (dBuV/m)	Read Level (dBuV)	Level Factor (dB/m)	Limit Line (dBuV/m)	Over Limit (dB)	APos (cm)	TPos (deg)	Remark	Pol/Phase	Note
1	2344.57	52.63	15.37	37.26	74.00	-21.37	290	93	Peak	Vertical	
2 *	2480.00	102.63	64.48	38.15	74.00	28.63	290	93	Peak	Vertical	
3	2639.93	54.70	16.66	38.04	74.00	-19.30	290	93	Peak	Vertical	

GFSK

High Channel (Horizontal) Average

High Channel (Vertical) Average



TÜV Rheinland Taiwan Ltd.  
No. 438-18, Sec. 2, Fenhiao, Linkou Dist., New Taipei City 244, Taiwan(R.O.C.)  
Tel: +886-2172-1000 Fax: +886-2172-1322

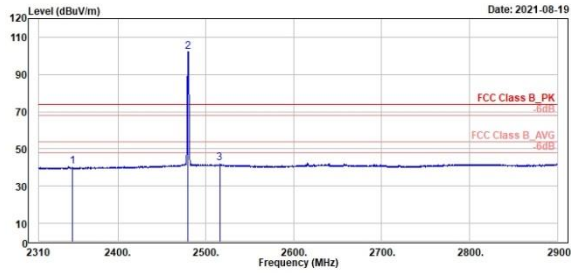

Freq	Level	Read	Level	Factor	Limit	Over	APos	TPos	Remark	Pol/Phase	Note
MHz	dBuV/m	dBuV	dB/m	dBuV/m	dB	cm	cm	deg			
1	2348.47	48.41	3.14	37.27	54.00	-13.59	187	99	Average	Horizontal	
2 *	2480.00	102.36	64.21	38.15	54.00	48.36	187	99	average	Horizontal	
3	2515.79	42.56	4.35	38.21	54.00	-11.44	187	99	Average	Horizontal	



TÜV Rheinland Taiwan Ltd.  
No. 438-18, Sec. 2, Fenhiao, Linkou Dist., New Taipei City 244, Taiwan(R.O.C.)  
Tel: +886-2172-1000 Fax: +886-2172-1322

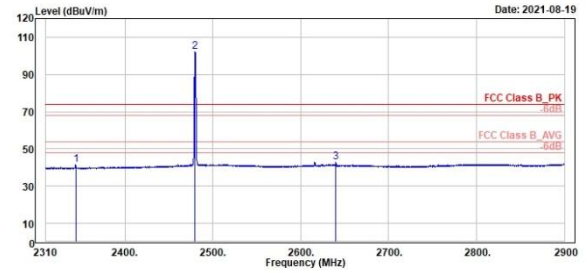

Freq	Level	Read	Level	Factor	Limit	Over	APos	TPos	Remark	Pol/Phase	Note
MHz	dBuV/m	dBuV	dB/m	dBuV/m	dB	cm	cm	deg			
1	2344.57	41.58	4.24	37.26	54.00	-12.50	290	93	Average	Vertical	
2 *	2480.00	102.16	64.01	38.15	54.00	48.16	290	93	Average	Vertical	
3	2639.93	42.77	4.73	38.04	54.00	-11.23	290	93	Average	Vertical	

**8DPSK**
**Low Channel (Horizontal) Peak**
**Low Channel (Vertical) Peak**

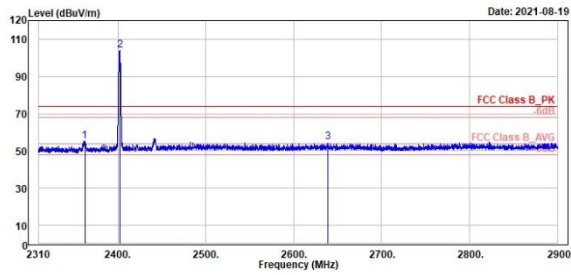

TÜV Rheinland Taiwan Ltd.  
 No. 438-18, Sec. 2, Fenliao, Linkou Dist., New Taipei City 244, Taiwan(R.O.C.)  
 Tel: +886-2172-1000 Fax: +886-2172-1322



Freq	Level	Read	Limit	Over	APos	TPos	Remark	Pol/Phase	Note
MHz	dBuV/m	dBuV	dB/m	dBuV/m	dB	cm	deg		
1	2362.39	55.15	17.79	37.36	74.00	-18.85	115	72 Peak	Horizontal
2 *	2402.00	103.97	66.33	37.64	74.00	29.97	115	72 Peak	Horizontal
3	2638.75	54.73	16.70	38.03	74.00	-19.27	115	72 Peak	Horizontal

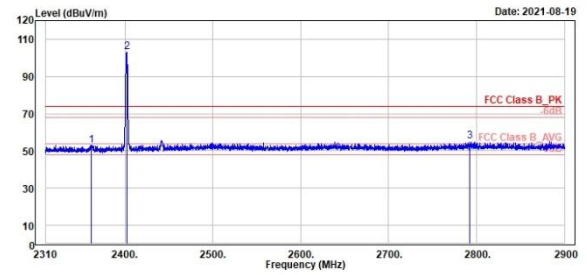

TÜV Rheinland Taiwan Ltd.  
 No. 438-18, Sec. 2, Fenliao, Linkou Dist., New Taipei City 244, Taiwan(R.O.C.)  
 Tel: +886-2172-1000 Fax: +886-2172-1322



Freq	Level	Read	Limit	Over	APos	TPos	Remark	Pol/Phase	Note
MHz	dBuV/m	dBuV	dB/m	dBuV/m	dB	cm	deg		
1	2361.92	52.93	15.57	37.36	74.00	-21.07	273	100 Peak	Vertical
2 *	2402.00	103.14	65.58	37.64	74.00	29.14	273	100 Peak	Vertical
3	2792.38	55.08	16.80	38.28	74.00	-18.92	273	100 Peak	Vertical

8DPSK

Low Channel (Horizontal) Average

Low Channel (Vertical) Average



TÜV Rheinland Taiwan Ltd.  
No. 438-18, Sec. 2, Fenhiao, Linkou Dist., New Taipei City 244, Taiwan(R.O.C.)  
Tel: +886-2172-1000 Fax: +886-2172-1322

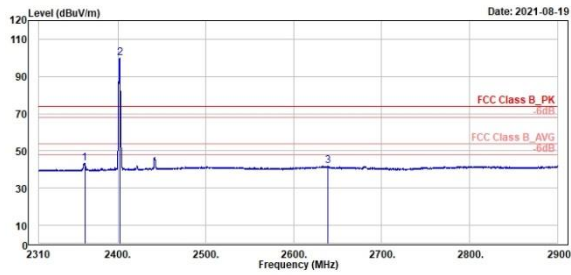

1	2	3
MHz	Level (dBuV/m)	Read Level (dBuV)
2362.39	43.45	6.09
2482.00	99.91	62.27
2638.75	41.83	3.80



TÜV Rheinland Taiwan Ltd.  
No. 438-18, Sec. 2, Fenhiao, Linkou Dist., New Taipei City 244, Taiwan(R.O.C.)  
Tel: +886-2172-1000 Fax: +886-2172-1322

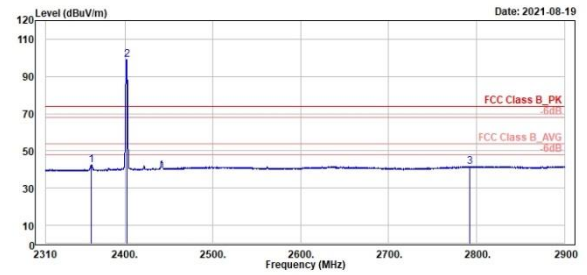

1	2	3
MHz	Level (dBuV/m)	Read Level (dBuV)
2361.92	42.30	4.94
2482.00	99.08	61.44
2792.38	41.72	3.44



8DPSK

High Channel (Horizontal) Peak

High Channel (Vertical) Peak



TÜV Rheinland Taiwan Ltd.  
No. 438-18, Sec. 2, Fenliao, Linkou Dist., New Taipei City 244, Taiwan(R.O.C.)  
Tel: +886-2172-1000 Fax: +886-2172-1322

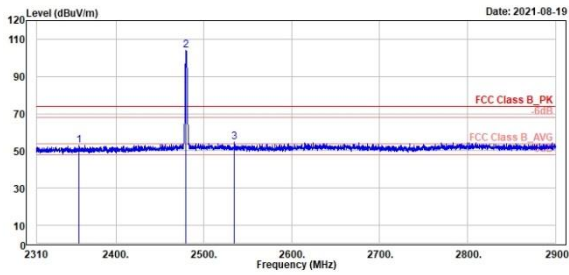

Peak	Freq (MHz)	Level (dBuV/m)	Read Level (dBuV)	Level Factor (dB/m)	Limit Line (dBuV/m)	Over Limit (dB)	APos (cm)	TPos (deg)	Remark	Pol/Phase	Note
1	2358.83	52.82	15.49	37.33	74.00	-21.18	186	99	Peak	Horizontal	
2 *	2488.00	103.82	65.67	38.15	74.00	29.82	186	99	Peak	Horizontal	
3	2534.79	54.71	16.56	38.15	74.00	-19.29	186	99	Peak	Horizontal	



TÜV Rheinland Taiwan Ltd.  
No. 438-18, Sec. 2, Fenliao, Linkou Dist., New Taipei City 244, Taiwan(R.O.C.)  
Tel: +886-2172-1000 Fax: +886-2172-1322

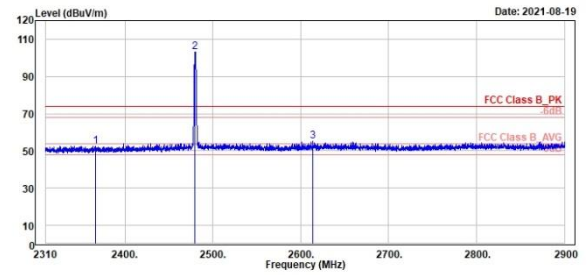

Peak	Freq (MHz)	Level (dBuV/m)	Read Level (dBuV)	Level Factor (dB/m)	Limit Line (dBuV/m)	Over Limit (dB)	APos (cm)	TPos (deg)	Remark	Pol/Phase	Note
1	2366.52	52.63	15.24	37.39	74.00	-21.37	290	94	Peak	Vertical	
2 *	2488.00	103.83	64.88	38.15	74.00	29.83	290	94	Peak	Vertical	
3	2613.85	55.09	17.84	38.05	74.00	-18.91	290	94	Peak	Vertical	

**8DPSK**
**High Channel (Horizontal) Average**
**High Channel (Vertical) Average**

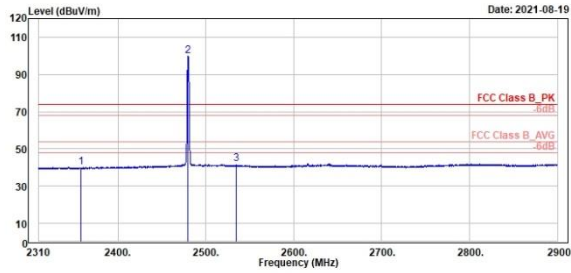

TÜV Rheinland Taiwan Ltd.  
 No. 438-18, Sec. 2, Fenliao, Linkou Dist., New Taipei City 244, Taiwan(R.O.C.)  
 Tel: +886-2172-1000 Fax: +886-2172-1322



Freq	Level	Read	Level	Factor	Limit	Over	APos	TPos	Remark	Pol/Phase	Note
MHz	dBuV/m	dBuV	dB/m	dBuV/m	dB	cm	deg				
1	2358.03	40.17	2.84	37.33	54.00	-13.83	186	99	Average	Horizontal	
2 *	2480.00	99.79	61.64	38.15	54.00	45.79	186	99	average	Horizontal	
3	2534.79	41.92	3.77	38.15	54.00	-12.08	186	99	Average	Horizontal	

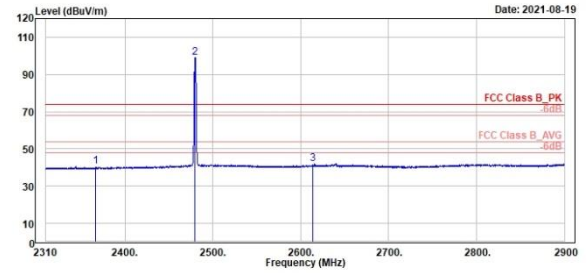

TÜV Rheinland Taiwan Ltd.  
 No. 438-18, Sec. 2, Fenliao, Linkou Dist., New Taipei City 244, Taiwan(R.O.C.)  
 Tel: +886-2172-1000 Fax: +886-2172-1322



Freq	Level	Read	Level	Factor	Limit	Over	APos	TPos	Remark	Pol/Phase	Note
MHz	dBuV/m	dBuV	dB/m	dBuV/m	dB	cm	deg				
1	2366.52	40.50	3.11	37.39	54.00	-13.50	290	94	Average	Vertical	
2 *	2480.00	99.07	60.92	38.15	54.00	45.07	290	94	Average	Vertical	
3	2613.85	42.04	3.99	38.05	54.00	-11.96	290	94	Average	Vertical	

Spurious Emissions, Tx Mode, 9kHz ~ 30MHz

GFSK

Low Channel(Open) 9kHz~150kHz

Low Channel(Open) 150kHz~30MHz



TUV Rheinland Taiwan Ltd.  
No. 458-18, Sec. 2, Fenhiao, Linkou Dist., New Taipei City 244, Taiwan(R.O.C.)  
Tel:+886-2172-1000 Fax:+886-2172-1322

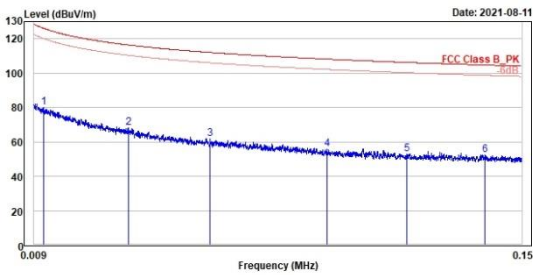

1	2	3	4	5	6
0.01	0.04	0.06	0.09	0.12	0.14
80.01	68.14	61.66	55.88	52.88	52.32
3.96	0.93	-0.88	-2.21	-3.66	-3.24
76.05	67.21	62.54	58.09	56.54	55.56
126.20	116.39	112.05	108.16	106.25	104.71
-46.19	-48.25	-50.39	-52.28	-53.37	-52.39
100	100	100	100	100	100
383	282	236	143	294	213
QP	QP	QP	QP	QP	QP
Open	Open	Open	Open	Open	Open



TUV Rheinland Taiwan Ltd.  
No. 458-18, Sec. 2, Fenhiao, Linkou Dist., New Taipei City 244, Taiwan(R.O.C.)  
Tel:+886-2172-1000 Fax:+886-2172-1322

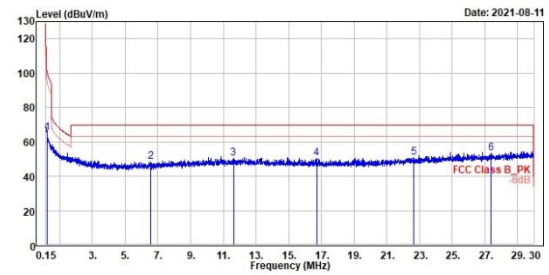

1	2	3	4	5	6
0.23	6.57	11.62	16.71	22.66	27.37
65.38	48.52	50.47	50.61	50.80	53.16
13.85	11.59	12.41	12.92	12.11	12.26
51.53	36.93	38.06	37.69	38.69	40.90
100.23	69.50	69.50	69.50	69.50	69.50
-34.85	-20.98	-19.03	-18.89	-18.70	-16.34
100	100	100	100	100	100
7	139	265	274	233	124
QP	QP	QP	QP	QP	QP
Open	Open	Open	Open	Open	Open

GFSK

Low Channel(Close) 9kHz~150kHz

Low Channel(Close) 150kHz~30MHz



TUV Rheinland Taiwan Ltd.  
No. 458-18, Sec. 2, Fenhiao, Linkou Dist., New Taipei City 244, Taiwan(R.O.C.)  
Tel:+886-2172-1000 Fax:+886-2172-1322

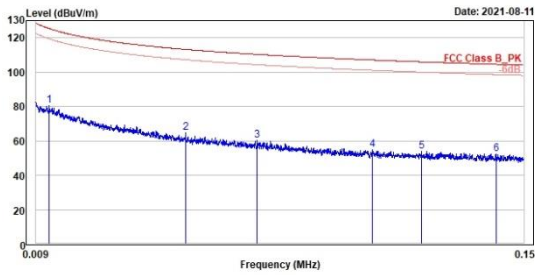

Freq	Level	Read	Limit	Over	APos	TPos	Remark	Pol/Phase	Note
MHz	dBuV/m	dBuV	dB/m	dBuV/m	dB	cm	deg		
1	0.01	80.46	4.87	75.59	125.40	-44.94	100	25 QP	Close
2	0.05	64.60	1.05	63.55	113.23	-48.63	100	72 QP	Close
3	0.07	60.20	-0.62	60.82	110.34	-50.14	100	79 QP	Close
4	0.11	54.69	-2.30	56.99	107.06	-52.37	100	314 QP	Close
5	0.12	54.04	-2.34	56.38	105.98	-51.94	100	350 QP	Close
6	0.14	52.46	-3.00	55.46	104.55	-52.09	100	113 QP	Close



TUV Rheinland Taiwan Ltd.  
No. 458-18, Sec. 2, Fenhiao, Linkou Dist., New Taipei City 244, Taiwan(R.O.C.)  
Tel:+886-2172-1000 Fax:+886-2172-1322

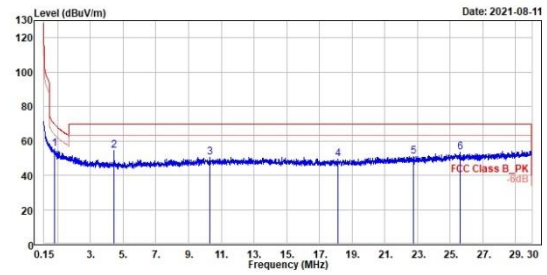

Freq	Level	Read	Limit	Over	APos	TPos	Remark	Pol/Phase	Note
MHz	dBuV/m	dBuV	dB/m	dBuV/m	dB	cm	deg		
1	0.70	55.20	12.41	42.79	69.73	-14.53	100	187 QP	Close
2	4.43	54.28	17.77	36.51	69.50	-15.22	100	331 QP	Close
3	10.30	50.60	12.44	38.16	69.50	-16.90	100	0 QP	Close
4	18.12	49.50	11.91	37.59	69.50	-20.00	100	0 QP	Close
5	22.75	51.05	12.32	38.73	69.50	-18.45	100	184 QP	Close
6	25.60	53.31	13.24	40.07	69.50	-16.19	100	300 QP	Close

**Spurious Emissions, Tx Mode, 30MHz ~ 1GHz**
**GFSK**
**Low Channel (Horizontal)**
**Low Channel (Vertical)**

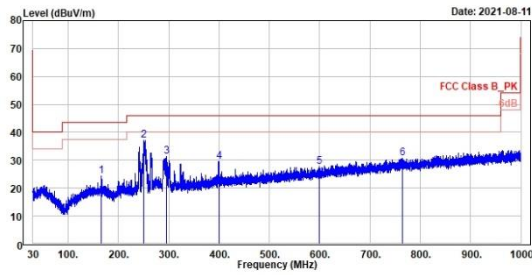

TUV Rheinland Taiwan Ltd.  
 No. 458-18, Sec. 2, Fenhiao, Linkou Dist., New Taipei City 244, Taiwan(R.O.C.)  
 Tel: +886-2172-1000 Fax: +886-2172-1322



Freq	Level	Read	Limit	Over	Apos	TPos	Remark	Pol/Phase	Note
MHz	dBuV/m	dBuV	dB/m	dBuV/m	dB	cm	deg		
1	166.38	24.30	31.35	-7.05	43.50	-19.20	100	280 QP	Horizontal
2	250.87	37.20	45.34	-8.14	46.00	-8.80	100	68 QP	Horizontal
3	295.68	31.30	37.86	-6.56	46.00	-14.70	100	70 QP	Horizontal
4	399.96	29.58	33.80	-4.22	46.00	-16.42	100	60 QP	Horizontal
5	598.61	27.60	28.95	-1.35	46.00	-18.40	100	98 QP	Horizontal
6	765.07	30.73	29.29	1.44	46.00	-15.27	100	133 QP	Horizontal

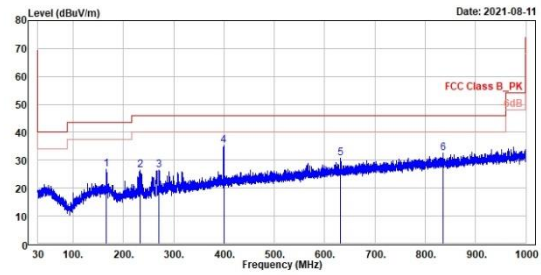

TUV Rheinland Taiwan Ltd.  
 No. 458-18, Sec. 2, Fenhiao, Linkou Dist., New Taipei City 244, Taiwan(R.O.C.)  
 Tel: +886-2172-1000 Fax: +886-2172-1322



Freq	Level	Read	Limit	Over	Apos	TPos	Remark	Pol/Phase	Note
MHz	dBuV/m	dBuV	dB/m	dBuV/m	dB	cm	deg		
1	166.19	26.84	33.85	-7.01	43.50	-16.66	100	10 QP	Vertical
2	233.99	26.43	34.91	-8.48	46.00	-19.57	100	107 QP	Vertical
3	270.95	26.41	33.74	-7.33	46.00	-19.59	100	130 QP	Vertical
4	399.47	35.34	39.56	-4.22	46.00	-10.66	100	193 QP	Vertical
5	631.21	30.87	31.70	-0.83	46.00	-15.13	100	228 QP	Vertical
6	835.20	32.40	29.91	2.49	46.00	-13.60	100	125 QP	Vertical

Spurious Emissions, Tx Mode, 1GHz ~ 26.5GHz

GFSK

Low Channel (Horizontal)

Low Channel (Vertical)



TÜV Rheinland Taiwan Ltd.  
No. 438-18, Sec. 2, Fenliao, Linkou Dist., New Taipei City 244, Taiwan(R.O.C.)  
Tel: +886-2172-1000 Fax: +886-2172-1322

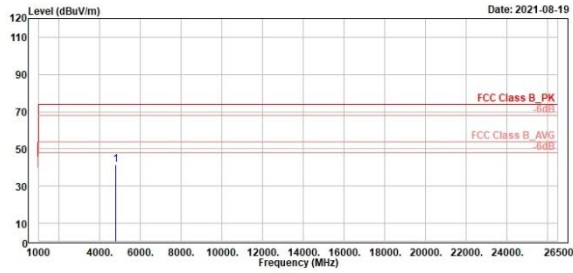

Freq	Level	Read	Limit	Over	APos	TPos	Remark	Pol/Phase	Note
MHz	dBuV/m	dBuV	dB/m	dBuV/m	dB	cm	deg		
1	4884.00	41.36	51.14	-9.78	74.00	-32.64	400	182 Peak	Horizontal



TÜV Rheinland Taiwan Ltd.  
No. 438-18, Sec. 2, Fenliao, Linkou Dist., New Taipei City 244, Taiwan(R.O.C.)  
Tel: +886-2172-1000 Fax: +886-2172-1322

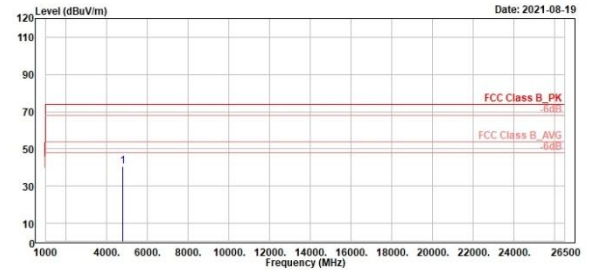

Freq	Level	Read	Limit	Over	APos	TPos	Remark	Pol/Phase	Note
MHz	dBuV/m	dBuV	dB/m	dBuV/m	dB	cm	deg		
1	4884.00	40.65	50.43	-9.78	74.00	-33.35	200	128 Peak	Vertical

GFSK

Middle Channel (Horizontal)

Middle Channel (Vertical)



TÜV Rheinland Taiwan Ltd.  
No. 438-18, Sec. 2, Fenliao, Linkou Dist., New Taipei City 244, Taiwan(R.O.C.)  
Tel: +886-2172-1000 Fax: +886-2172-1322

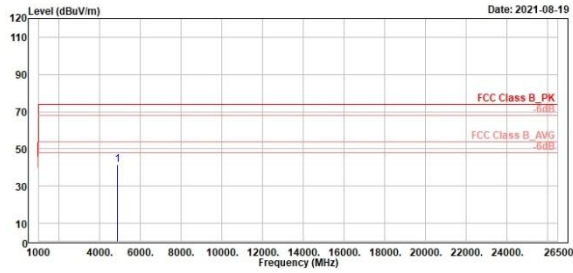

Freq	Level	Read Level	Factor	Limit Line	Over Limit	APos	TPos	Remark	Pol/Phase	Note
MHz	dBuV/m	dBuV	dB/m	dBuV/m	dB	cm	deg			
1 4882.00	41.37	51.03	-9.66	74.00	-32.63	400	104	Peak	Horizontal	



TÜV Rheinland Taiwan Ltd.  
No. 438-18, Sec. 2, Fenliao, Linkou Dist., New Taipei City 244, Taiwan(R.O.C.)  
Tel: +886-2172-1000 Fax: +886-2172-1322

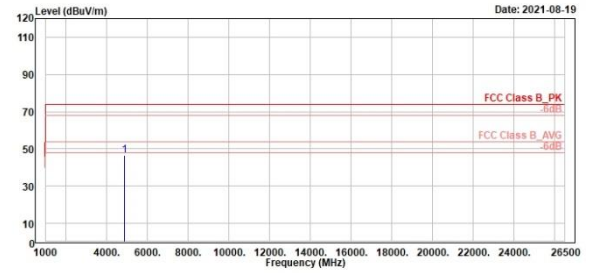

Freq	Level	Read Level	Factor	Limit Line	Over Limit	APos	TPos	Remark	Pol/Phase	Note
MHz	dBuV/m	dBuV	dB/m	dBuV/m	dB	cm	deg			
1 4882.00	46.66	56.32	-9.66	74.00	-27.34	100	165	Peak	Vertical	

GFSK

High Channel (Horizontal)

High Channel (Vertical)



TÜV Rheinland Taiwan Ltd.  
No. 438-18, Sec. 2, Fenhiao, Linkou Dist., New Taipei City 244, Taiwan(R.O.C.)  
Tel: +886-2172-1000 Fax: +886-2172-1322

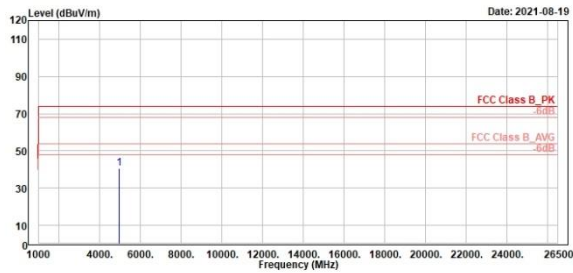

Freq	Level	Read Level	Factor	Limit Line	Over Limit	APos	TPos	Remark	Pol/Phase	Note
MHz	dBuV/m	dBuV	dB/m	dBuV/m	dB	cm	deg			
1	4960.00	40.63	50.09	-9.46	74.00	-33.37	100	194 Peak	Horizontal	



TÜV Rheinland Taiwan Ltd.  
No. 438-18, Sec. 2, Fenhiao, Linkou Dist., New Taipei City 244, Taiwan(R.O.C.)  
Tel: +886-2172-1000 Fax: +886-2172-1322

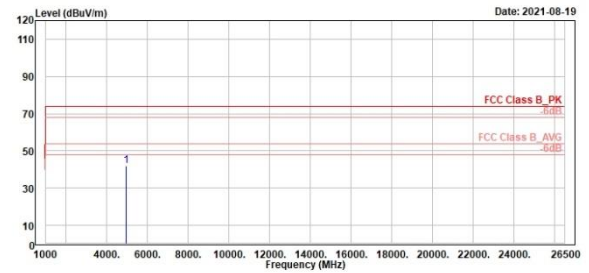

Freq	Level	Read Level	Factor	Limit Line	Over Limit	APos	TPos	Remark	Pol/Phase	Note
MHz	dBuV/m	dBuV	dB/m	dBuV/m	dB	cm	deg			
1	4960.00	42.05	51.51	-9.46	74.00	-31.95	100	100 Peak	Vertical	



8DPSK

Low Channel (Horizontal)

Low Channel (Vertical)



TÜV Rheinland Taiwan Ltd.  
No. 438-18, Sec. 2, Fenhiao, Linkou Dist., New Taipei City 244, Taiwan(R.O.C.)  
Tel: +886-2172-1000 Fax: +886-2172-1322

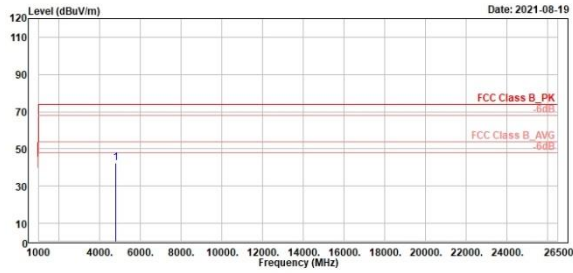

1	4884.00	42.58	52.36	-9.78	74.00	-31.42	100	100	Peak	Horizontal
---	---------	-------	-------	-------	-------	--------	-----	-----	------	------------



TÜV Rheinland Taiwan Ltd.  
No. 438-18, Sec. 2, Fenhiao, Linkou Dist., New Taipei City 244, Taiwan(R.O.C.)  
Tel: +886-2172-1000 Fax: +886-2172-1322

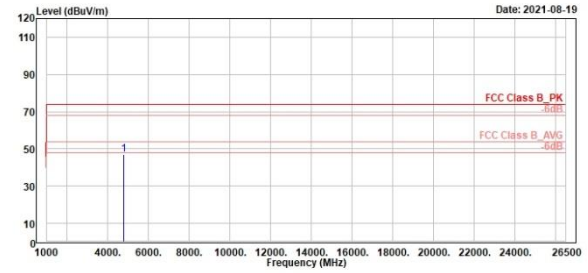

1	4884.00	46.89	56.67	-9.78	74.00	-27.11	100	255	Peak	Vertical
---	---------	-------	-------	-------	-------	--------	-----	-----	------	----------

8DPSK

Middle Channel (Horizontal)

Middle Channel (Vertical)



TÜV Rheinland Taiwan Ltd.  
No. 438-18, Sec. 2, Fenliao, Linkou Dist., New Taipei City 244, Taiwan(R.O.C.)  
Tel: +886-2172-1000 Fax: +886-2172-1322

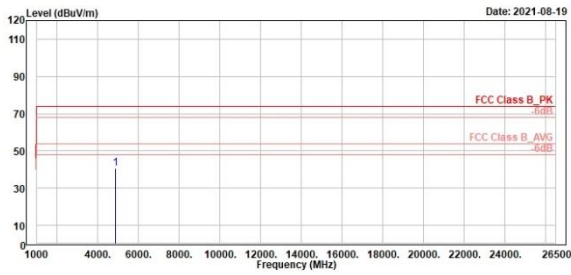

Freq	Level	Read Level	Factor	Limit Line	Over Limit	APos	TPos	Remark	Pol/Phase	Note
MHz	dBuV/m	dBuV	dB/m	dBuV/m	dB	cm	deg			
1	4882.00	40.41	50.07	-9.66	74.00	-33.59	100	251 Peak	Horizontal	



TÜV Rheinland Taiwan Ltd.  
No. 438-18, Sec. 2, Fenliao, Linkou Dist., New Taipei City 244, Taiwan(R.O.C.)  
Tel: +886-2172-1000 Fax: +886-2172-1322

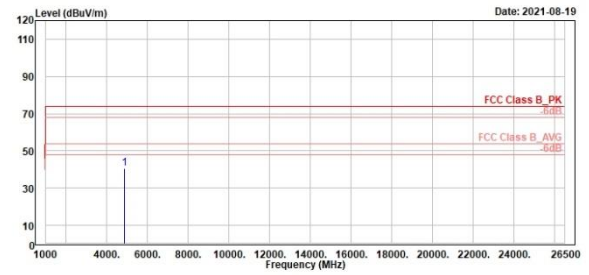

Freq	Level	Read Level	Factor	Limit Line	Over Limit	APos	TPos	Remark	Pol/Phase	Note
MHz	dBuV/m	dBuV	dB/m	dBuV/m	dB	cm	deg			
1	4882.00	40.61	50.27	-9.66	74.00	-33.39	400	201 Peak	Vertical	

8DPSK

High Channel (Horizontal)

High Channel (Vertical)



TÜV Rheinland Taiwan Ltd.  
No. 438-18, Sec. 2, Fenliao, Linkou Dist., New Taipei City 244, Taiwan(R.O.C.)  
Tel: +886-2172-1000 Fax: +886-2172-1322

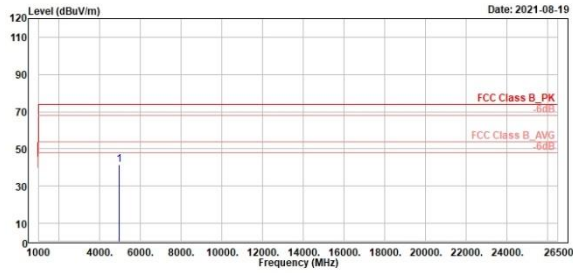

Freq	Level	Read Level	Factor	Limit Line	Over Limit	APos	TPos	Remark	Pol/Phase	Note
MHz	dBuV/m	dBuV	dB/m	dBuV/m	dB	cm	deg			
1	4960.00	41.32	50.78	-9.46	74.00	-32.68	300	198 Peak	Horizontal	



TÜV Rheinland Taiwan Ltd.  
No. 438-18, Sec. 2, Fenliao, Linkou Dist., New Taipei City 244, Taiwan(R.O.C.)  
Tel: +886-2172-1000 Fax: +886-2172-1322

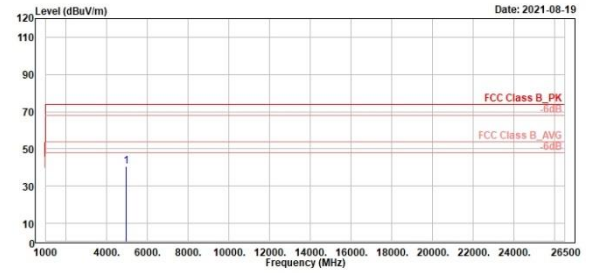

Freq	Level	Read Level	Factor	Limit Line	Over Limit	APos	TPos	Remark	Pol/Phase	Note
MHz	dBuV/m	dBuV	dB/m	dBuV/m	dB	cm	deg			
1	4960.00	40.46	49.92	-9.46	74.00	-33.54	100	313 Peak	Vertical	

Mains Conducted Emission, 150kHz ~ 30MHz

Worst Band

(Line)

(Neutral)



TÜV Rheinland Taiwan Ltd.  
No. 458-18, Sec. 2, Fenhiao, Linkou Dist., New Taipei City 244, Taiwan (R.O.C.)  
Tel: +886-2112-1000 Fax: +886-2112-1322

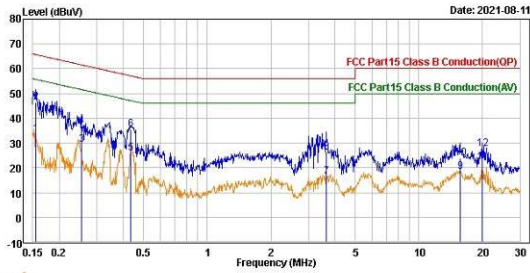

Date: 2021-08-11

Trace: 1

	Freq	Level	Read Level	Factor	Limit Line	Over Limit	Remark	Pol/Phase	Note
	MHz	dBuV	dBuV	dB	dBuV	dB			
1	0.15	33.57	23.91	9.66	55.75	-22.18	Average	line1	
2	0.15	46.46	36.80	9.66	65.75	-19.29	QP	line1	
3	0.25	29.28	19.63	9.65	51.61	-22.33	Average	line1	
4	0.25	36.72	27.07	9.65	61.61	-24.89	QP	line1	
5	0.43	25.93	16.28	9.65	47.18	-21.25	Average	line1	
6	0.43	35.42	25.77	9.65	57.18	-21.76	QP	line1	
7	3.64	16.24	6.54	9.70	46.00	-29.76	Average	line1	
8	3.64	26.17	16.47	9.70	56.00	-29.83	QP	line1	
9	15.62	18.35	8.60	9.75	50.00	-31.65	Average	line1	
10	15.62	23.78	14.03	9.75	60.00	-36.22	QP	line1	
11	19.84	22.07	12.33	9.74	50.00	-27.93	Average	line1	
12	19.84	27.71	17.97	9.74	60.00	-32.29	QP	line1	



TÜV Rheinland Taiwan Ltd.  
No. 458-18, Sec. 2, Fenhiao, Linkou Dist., New Taipei City 244, Taiwan (R.O.C.)  
Tel: +886-2112-1000 Fax: +886-2112-1322

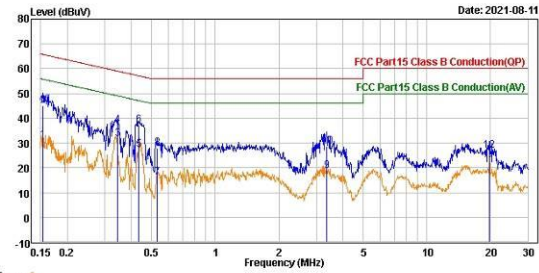

Date: 2021-08-11

Trace: 1

	Freq	Level	Read Level	Factor	Limit Line	Over Limit	Remark	Pol/Phase	Note
	MHz	dBuV	dBuV	dB	dBuV	dB			
1	0.15	31.00	21.32	9.68	55.79	-24.79	Average	neutral	
2	0.15	44.99	35.31	9.68	65.79	-20.80	QP	neutral	
3	0.34	31.70	22.05	9.65	49.09	-17.39	Average	neutral	
4	0.34	37.25	27.60	9.65	59.09	-21.84	QP	neutral	
5	0.44	27.43	17.77	9.66	47.14	-19.71	Average	neutral	
6	0.44	37.20	27.54	9.66	57.14	-19.94	QP	neutral	
7	0.53	15.98	6.32	9.66	46.00	-30.02	Average	neutral	
8	0.53	27.94	18.28	9.66	56.00	-28.06	QP	neutral	
9	3.36	18.67	8.96	9.71	46.00	-27.33	Average	neutral	
10	3.36	28.66	18.95	9.71	56.00	-27.34	QP	neutral	
11	19.64	21.27	11.44	9.83	50.00	-28.73	Average	neutral	
12	19.64	27.08	17.25	9.83	60.00	-32.92	QP	neutral	