

## FCC Test Report

**Report No.:** RF190422C26-1

**FCC ID:** NDD9532311903

**Test Model:** IC-3231GLP

**Series Model:** IC-S200WD (refer to item 3.1 for more details)

**Received Date:** Apr. 22, 2019

**Test Date:** May 08 ~ May 15, 2019

**Issued Date:** May 23, 2019

**Applicant:** EDIMAX TECHNOLOGY CO., LTD.

**Address:** No. 3, Wuquan 3rd Rd., Wugu Dist., New Taipei City 248, Taiwan (R.O.C.)

**Issued By:** Bureau Veritas Consumer Products Services (H.K.) Ltd., Taoyuan Branch

**Lab Address:** No. 47-2, 14th Ling, Chia Pau Vil., Lin Kou Dist., New Taipei City, Taiwan (R.O.C.)

**Test Location:** No. 19, Hwa Ya 2nd Rd., Wen Hwa Vil., Kwei Shan Dist., Taoyuan City 33383, TAIWAN (R.O.C.)

**FCC Registration /  
Designation Number:** 788550 / TW0003



This report is for your exclusive use. Any copying or replication of this report to or for any other person or entity, or use of our name or trademark, is permitted only with our prior written permission. This report sets forth our findings solely with respect to the test samples identified herein. The results set forth in this report are not indicative or representative of the quality or characteristics of the lot from which a test sample was taken or any similar or identical product specifically and expressly noted. Our report includes all of the tests requested by you and the results thereof based upon the information that you provided to us. You have 60 days from date of issuance of this report to notify us of any material error or omission caused by our negligence, provided, however, that such notice shall be in writing and shall specifically address the issue you wish to raise. A failure to raise such issue within the prescribed time shall constitute your unqualified acceptance of the completeness of this report, the tests conducted and the correctness of the report contents. Unless specific mention, the uncertainty of measurement has been explicitly taken into account to declare the compliance or non-compliance to the specification. The report must not be used by the client to claim product certification, approval, or endorsement by TAF or any government agencies.

## Table of Contents

<b>Release Control Record</b> .....	<b>4</b>
<b>1 Certificate of Conformity</b> .....	<b>5</b>
<b>2 Summary of Test Results</b> .....	<b>6</b>
2.1 Measurement Uncertainty.....	6
2.2 Modification Record.....	6
<b>3 General Information</b> .....	<b>7</b>
3.1 General Description of EUT.....	7
3.2 Description of Test Modes.....	9
3.2.1 Test Mode Applicability and Tested Channel Detail.....	10
3.3 Duty Cycle of Test Signal.....	12
3.4 Description of Support Units.....	13
3.4.1 Configuration of System under Test.....	13
3.5 General Description of Applied Standards.....	13
<b>4 Test Types and Results</b> .....	<b>14</b>
4.1 Radiated Emission and Bandedge Measurement.....	14
4.1.1 Limits of Radiated Emission and Bandedge Measurement.....	14
4.1.2 Test Instruments.....	15
4.1.3 Test Procedures.....	16
4.1.4 Deviation from Test Standard.....	16
4.1.5 Test Setup.....	17
4.1.6 EUT Operating Conditions.....	18
4.1.7 Test Results.....	19
4.2 Conducted Emission Measurement.....	41
4.2.1 Limits of Conducted Emission Measurement.....	41
4.2.2 Test Instruments.....	41
4.2.3 Test Procedures.....	42
4.2.4 Deviation from Test Standard.....	42
4.2.5 Test Setup.....	42
4.2.6 EUT Operating Conditions.....	42
4.2.7 Test Results.....	43
4.3 Transmit Power Measurement.....	47
4.3.1 Limits of Transmit Power Measurement.....	47
4.3.2 Test Setup.....	47
4.3.3 Test Instruments.....	47
4.3.4 Test Procedure.....	47
4.3.5 Deviation from Test Standard.....	47
4.3.6 EUT Operating Conditions.....	47
4.3.7 Test Result.....	48
4.4 Occupied Bandwidth Measurement.....	49
4.4.1 Test Setup.....	49
4.4.2 Test Instruments.....	49
4.4.3 Test Procedure.....	49
4.4.4 Test Result.....	50
4.5 Peak Power Spectral Density Measurement.....	52
4.5.1 Limits of Peak Power Spectral Density Measurement.....	52
4.5.2 Test Setup.....	52
4.5.3 Test Instruments.....	52
4.5.4 Test Procedures.....	52
4.5.5 Deviation from Test Standard.....	53
4.5.6 EUT Operating Conditions.....	53
4.5.7 Test Results.....	54
4.6 Frequency Stability.....	58
4.6.1 Limits of Frequency Stability Measurement.....	58

4.6.2	Test Setup.....	58
4.6.3	Test Instruments .....	58
4.6.4	Test Procedure .....	58
4.6.5	Deviation from Test Standard .....	59
4.6.6	EUT Operating Condition .....	59
4.6.7	Test Results .....	59
4.7	6dB Bandwidth Measurement.....	60
4.7.1	Limits of 6dB Bandwidth Measurement.....	60
4.7.2	Test Setup.....	60
4.7.3	Test Instruments .....	60
4.7.4	Test Procedure .....	60
4.7.5	Deviation from Test Standard .....	60
4.7.6	EUT Operating Condition .....	60
4.7.7	Test Results .....	61
<b>5</b>	<b>Pictures of Test Arrangements.....</b>	<b>63</b>
	<b>Annex A- Radiated Out of Band Emission (OOBE) Measurement (For U-NII-3 band).....</b>	<b>64</b>
	<b>Appendix – Information of the Testing Laboratories .....</b>	<b>67</b>

### Release Control Record

Issue No.	Description	Date Issued
RF190422C26-1	Original release	May 23, 2019

## 1 Certificate of Conformity

**Product:** Wireless 802.11a/b/g/n/ac Dual Band IP Camera

**Brand:** EDIMAX

**Test Model:** IC-3231GLP

**Series Model:** IC-S200WD (refer to item 3.1 for more details)

**Sample Status:** Engineering sample

**Applicant:** EDIMAX TECHNOLOGY CO., LTD.

**Test Date:** May 08 ~ May 15, 2019

**Standards:** 47 CFR FCC Part 15, Subpart E (Section 15.407)  
ANSI C63.10:2013

The above equipment has been tested by **Bureau Veritas Consumer Products Services (H.K.) Ltd., Taoyuan Branch**, and found compliance with the requirement of the above standards. The test record, data evaluation & Equipment Under Test (EUT) configurations represented herein are true and accurate accounts of the measurements of the sample's RF characteristics under the conditions specified in this report.

**Prepared by :** Celine Chou , **Date:** May 23, 2019  
Celine Chou / Senior Specialist

**Approved by :** Bruce Chen , **Date:** May 23, 2019  
Bruce Chen / Project Engineer

## 2 Summary of Test Results

47 CFR FCC Part 15, Subpart E (Section 15.407)			
FCC Clause	Test Item	Result	Remarks
15.407(b)(6)	AC Power Conducted Emissions	Pass	Meet the requirement of limit. Minimum passing margin is -10.35dB at 0.44507MHz.
15.407(b)(1/2/3/4(i/ii)/6)	Radiated Emissions & Band Edge Measurement	Pass	Meet the requirement of limit. Minimum passing margin is -0.9dB at 5150.00MHz.
15.407(a)(1/2/3)	Max Average Transmit Power	Pass	Meet the requirement of limit.
---	Occupied Bandwidth Measurement	-	Reference only.
15.407(a)(1/2/3)	Peak Power Spectral Density	Pass	Meet the requirement of limit.
15.407(e)	6dB bandwidth	Pass	Meet the requirement of limit. (U-NII-3 Band only)
15.407(g)	Frequency Stability	Pass	Meet the requirement of limit.
15.203	Antenna Requirement	Pass	Antenna connector is i-pex(MHF) not a standard connector.

Note:

- Determining compliance based on the results of the compliance measurement, not taking into account measurement instrumentation uncertainty.
- For U-NII-3 band compliance with rule part 15.407(b)(4)(i), the OOB test plots were recorded in Annex A.

### 2.1 Measurement Uncertainty

Where relevant, the following measurement uncertainty levels have been estimated for tests performed on the EUT as specified in CISPR 16-4-2:

Measurement	Frequency	Expanded Uncertainty (k=2) (±)
Conducted Emissions at mains ports	150kHz ~ 30MHz	2.94 dB
Radiated Emissions up to 1 GHz	9kHz ~ 30MHz	3.04 dB
	30MHz ~ 200MHz	3.59 dB
	200MHz ~ 1000MHz	3.60 dB
Radiated Emissions above 1 GHz	1GHz ~ 18GHz	2.29 dB
	18GHz ~ 40GHz	2.29 dB

### 2.2 Modification Record

There were no modifications required for compliance.

### 3 General Information

#### 3.1 General Description of EUT

Product	Wireless 802.11a/b/g/n/ac Dual Band IP Camera
Brand	EDIMAX
Test Model	IC-3231GLP
Series Model	IC-S200WD
Model Difference	Refer to note
Sample Status	Engineering sample
Power Supply Rating	12Vdc from adapter
Modulation Type	256QAM, 64QAM, 16QAM, QPSK, BPSK
Modulation Technology	OFDM
Transfer Rate	802.11a: 54/48/36/24/18/12/9/6Mbps 802.11n: up to 150Mbps 802.11ac: up to 433.3Mbps
Operating Frequency	5180 ~ 5240MHz, 5745 ~ 5825MHz
Number of Channel	5180 ~ 5240MHz: 802.11a, 802.11n (HT20), 802.11ac (VHT20): 4 802.11n (HT40), 802.11ac (VHT40): 2 802.11ac (VHT80): 1 5745 ~ 5825MHz: 802.11a, 802.11n (HT20), 802.11ac (VHT20): 5 802.11n (HT40), 802.11ac (VHT40): 2 802.11ac (VHT80): 1
Output Power	5180 ~ 5240MHz: 103.039mW 5745 ~ 5825MHz: 148.936mW
Antenna Type	PIFA antenna with 4dBi gain
Antenna Connector	i-pex(MHF)
Accessory Device	Adapter
Cable Supplied	0.65m shielded cable without core attached on EUT

Note:

1. All models are listed as below.

Brand	Model	Description
EDIMAX	IC-3231GLP	For marketing purpose.
	IC-S200WD	

\* The model of the IC-3231GLP was chosen for final test.

2. The EUT provide 1 completed transmitter and 1 receiver.

Modulation Mode	TX Function
802.11a	1TX
802.11n (HT20)	1TX
802.11n (HT40)	1TX
802.11ac (VHT20)	1TX
802.11ac (VHT40)	1TX
802.11ac (VHT80)	1TX

\* The bandwidth and modulation are similar for HT20/HT40 on 802.11n mode and VHT20/VHT40 on 802.11ac mode, therefore investigated worst case to representative mode in test report. (Final test mode refer section 3.2.1)

3. The EUT consumes power from the following adapters.

Adapter 1	
Brand	AMIGO
Model	AMS159A-1201000FU
Input Power	100-240Vac, 50/60Hz, 0.5A
Output Power	12Vdc, 1A

Adapter 2	
Brand	DVE
Model	DSA-12PFT-12 FUS 120100
Input Power	100-240Vac, 50/60Hz, 0.5A
Output Power	12Vdc, 1A

4. WLAN, BT and BT LE technology cannot transmit simultaneously.



### 3.2 Description of Test Modes

#### For 5180 ~ 5240MHz:

4 channels are provided for 802.11a, 802.11n (HT20), 802.11ac (VHT20):

Channel	Frequency	Channel	Frequency
36	5180 MHz	44	5220 MHz
40	5200 MHz	48	5240 MHz

2 channels are provided for 802.11n (HT40), 802.11ac (VHT40):

Channel	Frequency	Channel	Frequency
38	5190 MHz	46	5230 MHz

1 channel is provided for 802.11ac (VHT80):

Channel	Frequency
42	5210MHz

#### For 5745 ~ 5825MHz:

5 channels are provided for 802.11a, 802.11n (HT20), 802.11ac (VHT20):

Channel	Frequency	Channel	Frequency
149	5745MHz	161	5805MHz
153	5765MHz	165	5825MHz
157	5785MHz		

2 channels are provided for 802.11n (HT40), 802.11ac (VHT40):

Channel	Frequency	Channel	Frequency
151	5755MHz	159	5795MHz

1 channel is provided for 802.11ac (VHT80):

Channel	Frequency
155	5775MHz

### 3.2.1 Test Mode Applicability and Tested Channel Detail

EUT Configure Mode	Applicable to				Description
	RE $\geq$ 1G	RE<1G	PLC	APCM	
A	√	√	√	√	Powered by adapter 1
B	-	√	√	-	Powered by adapter 2

Where RE $\geq$ 1G: Radiated Emission above 1GHz & Bandedge Measurement  
 RE<1G: Radiated Emission below 1GHz  
 PLC: Power Line Conducted Emission  
 APCM: Antenna Port Conducted Measurement

Note: The EUT had been pre-tested on the positioned of each 3 axis. The worst case was found when positioned on **Y-plane**.

#### **Radiated Emission Test (Above 1GHz):**

- Pre-Scan has been conducted to determine the worst-case mode from all possible combinations between available modulations, data rates and antenna ports (if EUT with antenna diversity architecture).
- Following channel(s) was (were) selected for the final test as listed below.

EUT Configure Mode	Mode	Frequency Band (MHz)	Available Channel	Tested Channel	Modulation Technology	Data Rate (Mbps)
A	802.11a	5180-5240	36 to 48	36, 40, 48	OFDM	6.0
	802.11n (HT20)		36 to 48	36, 40, 48	OFDM	6.5
	802.11n (HT40)		38 to 46	38, 46	OFDM	13.5
	802.11ac (VHT80)		42	42	OFDM	29.3
A	802.11a	5745-5825	149 to 165	149, 157, 165	OFDM	6.0
	802.11n (HT20)		149 to 165	149, 157, 165	OFDM	6.5
	802.11n (HT40)		151 to 159	151, 159	OFDM	13.5
	802.11ac (VHT80)		155	155	OFDM	29.3

#### **Radiated Emission Test (Below 1GHz):**

- Pre-Scan has been conducted to determine the worst-case mode from all possible combinations between available modulations, data rates and antenna ports (if EUT with antenna diversity architecture).
- Following channel(s) was (were) selected for the final test as listed below.

EUT Configure Mode	Mode	Frequency Band (MHz)	Available Channel	Tested Channel	Modulation Technology	Data Rate (Mbps)
A, B	802.11a	5180-5240	36 to 48	40	OFDM	6.0
A, B	802.11a	5745-5825	149 to 165		OFDM	6.0

#### **Power Line Conducted Emission Test:**

- Pre-Scan has been conducted to determine the worst-case mode from all possible combinations between available modulations, data rates and antenna ports (if EUT with antenna diversity architecture).
- Following channel(s) was (were) selected for the final test as listed below.

EUT Configure Mode	Mode	Frequency Band (MHz)	Available Channel	Tested Channel	Modulation Technology	Data Rate (Mbps)
A, B	802.11a	5180-5240	36 to 48	40	OFDM	6.0
A, B	802.11a	5745-5825	149 to 165		OFDM	6.0

**Antenna Port Conducted Measurement:**

- This item includes all test value of each mode, but only includes spectrum plot of worst value of each mode.
- Pre-Scan has been conducted to determine the worst-case mode from all possible combinations between available modulations, data rates and antenna ports (if EUT with antenna diversity architecture).
- Following channel(s) was (were) selected for the final test as listed below.

EUT Configure Mode	Mode	Frequency Band (MHz)	Available Channel	Tested Channel	Modulation Technology	Data Rate (Mbps)
A	802.11a	5180-5240	36 to 48	36, 40, 48	OFDM	6.0
	802.11n (HT20)		36 to 48	36, 40, 48	OFDM	6.5
	802.11n (HT40)		38 to 46	38, 46	OFDM	13.5
	802.11ac (VHT80)		42	42	OFDM	29.3
A	802.11a	5745-5825	149 to 165	149, 157, 165	OFDM	6.0
	802.11n (HT20)		149 to 165	149, 157, 165	OFDM	6.5
	802.11n (HT40)		151 to 159	151, 159	OFDM	13.5
	802.11ac (VHT80)		155	155	OFDM	29.3

**Test Condition:**

Applicable to	Environmental Conditions	Input Power	Tested by
RE <sub>≥</sub> 1G	25 deg. C, 65% RH	120Vac, 60Hz	Greg Lin
RE <sub>&lt;</sub> 1G	25 deg. C, 65% RH	120Vac, 60Hz	Greg Lin
PLC	25 deg. C, 75% RH	120Vac, 60Hz	Greg Lin
APCM	25 deg. C, 60% RH	120Vac, 60Hz	Frank Liu

### 3.3 Duty Cycle of Test Signal

Duty cycle of test signal is < 98%, duty factor is required.

802.11a: Duty cycle =  $2.059/2.112 = 0.975$ , Duty factor =  $10 * \log(1/0.975) = 0.11$

802.11n (HT20): Duty cycle =  $1.334/1.391 = 0.959$ , Duty factor =  $10 * \log(1/0.959) = 0.18$

802.11n (HT40): Duty cycle =  $0.939/1.058 = 0.888$ , Duty factor =  $10 * \log(1/0.888) = 0.52$

802.11ac (VHT80): Duty cycle =  $0.458/0.570 = 0.804$ , Duty factor =  $10 * \log(1/0.804) = 0.95$

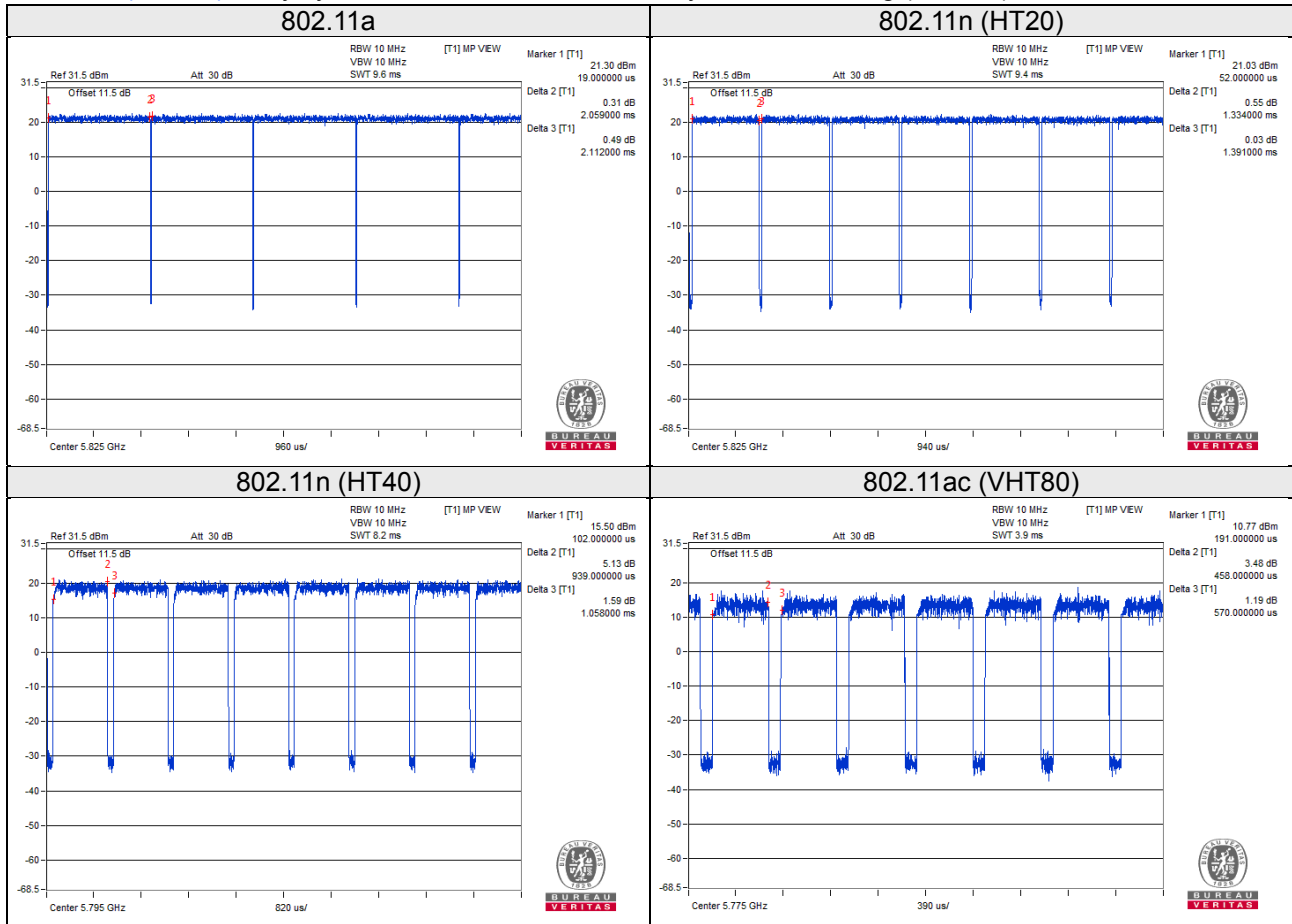

### 3.4 Description of Support Units

The EUT has been tested as an independent unit.

#### 3.4.1 Configuration of System under Test

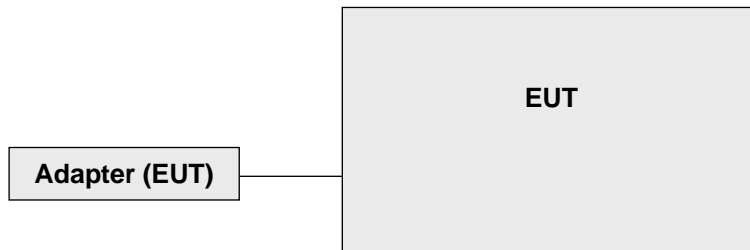

### 3.5 General Description of Applied Standards

The EUT is a RF Product. According to the specifications of the manufacturer, it must comply with the requirements of the following standards:

**FCC Part 15, Subpart E (15.407)**

**KDB 789033 D02 General UNII Test Procedure New Rules v02r01**

ANSI C63.10:2013

All test items have been performed and recorded as per the above standards.

## 4 Test Types and Results

### 4.1 Radiated Emission and Bandedge Measurement

#### 4.1.1 Limits of Radiated Emission and Bandedge Measurement

Radiated emissions which fall in the restricted bands must comply with the radiated emission limits specified as below table.

Frequencies (MHz)	Field Strength (microvolts/meter)	Measurement Distance (meters)
0.009 ~ 0.490	2400/F(kHz)	300
0.490 ~ 1.705	24000/F(kHz)	30
1.705 ~ 30.0	30	30
30 ~ 88	100	3
88 ~ 216	150	3
216 ~ 960	200	3
Above 960	500	3

Note:

1. The lower limit shall apply at the transition frequencies.
2. Emission level (dBuV/m) = 20 log Emission level (uV/m).
3. For frequencies above 1000MHz, the field strength limits are based on average detector, however, the peak field strength of any emission shall not exceed the maximum permitted average limits, specified above by more than 20dB under any condition of modulation.

Limits of unwanted emission out of the restricted bands

Applicable To		Limit	
789033 D02 General UNII Test Procedure New Rules v02r01		Field Strength at 3m	
		PK: 74 (dBuV/m)	AV: 54 (dBuV/m)
Frequency Band	Applicable To	EIRP Limit	Equivalent Field Strength at 3m
5150~5250 MHz	15.407(b)(1)	PK: -27 (dBm/MHz)	PK: 68.2(dBuV/m)
5250~5350 MHz	15.407(b)(2)		
5470~5725 MHz	15.407(b)(3)		
5725~5850 MHz	<input checked="" type="checkbox"/> 15.407(b)(4)(i)	PK: -27 (dBm/MHz) <sup>*1</sup> PK: 10 (dBm/MHz) <sup>*2</sup> PK: 15.6 (dBm/MHz) <sup>*3</sup> PK: 27 (dBm/MHz) <sup>*4</sup>	PK: 68.2(dBuV/m) <sup>*1</sup> PK: 105.2 (dBuV/m) <sup>*2</sup> PK: 110.8(dBuV/m) <sup>*3</sup> PK: 122.2 (dBuV/m) <sup>*4</sup>
	<input type="checkbox"/> 15.407(b)(4)(ii)	Emission limits in section 15.247(d)	
<sup>*1</sup> beyond 75 MHz or more above of the band edge.		<sup>*2</sup> below the band edge increasing linearly to 10 dBm/MHz at 25 MHz above.	
<sup>*3</sup> below the band edge increasing linearly to a level of 15.6 dBm/MHz at 5 MHz above.		<sup>*4</sup> from 5 MHz above or below the band edge increasing linearly to a level of 27 dBm/MHz at the band edge.	

Note: The following formula is used to convert the equipment isotropic radiated power (eirp) to field strength:

$$E = \frac{1000000 \sqrt{30P}}{3} \mu\text{V/m, where P is the eirp (Watts).}$$

#### 4.1.2 Test Instruments

Description & Manufacturer	Model No.	Serial No.	Cal. Date	Cal. Due
Test Receiver KEYSIGHT	N9038A	MY55420137	Apr. 15, 2019	Apr. 14, 2020
Spectrum Analyzer ROHDE & SCHWARZ	FSP40	100269	May 29, 2018	May 28, 2019
BILOG Antenna SCHWARZBECK	VULB9168	9168-160	Nov. 21, 2018	Nov. 20, 2019
HORN Antenna SCHWARZBECK	BBHA 9120 D	9120D-1169	Nov. 25, 2018	Nov. 24, 2019
HORN Antenna SCHWARZBECK	BBHA 9170	BBHA9170241	Nov. 25, 2018	Nov. 24, 2019
Loop Antenna TESEQ	HLA 6121	45745	Jun. 14, 2018	Jun. 13, 2019
Preamplifier Agilent (Below 1GHz)	8447D	2944A10638	Aug. 08, 2018	Aug. 07, 2019
Preamplifier Agilent (Above 1GHz)	8449B	3008A02367	Feb. 19, 2019	Feb. 18, 2020
RF signal cable HUBER+SUHNER&EMCI	SUCOFLEX 104 & EMC104-SM-SM80 00	CABLE-CH9-02 (248780+171006)	Jan. 19, 2019	Jan. 18, 2020
RF signal cable HUBER+SUHNER	SUCOFLEX 104	CABLE-CH9-(250795/4)	Aug. 08, 2018	Aug. 07, 2019
RF signal cable Woken	8D-FB	Cable-CH9-01	Jul. 31, 2018	Jul. 30, 2019
Software BV ADT	ADT_Radiated_ V7.6.15.9.5	NA	NA	NA
Antenna Tower EMCO	2070/2080	512.835.4684	NA	NA
Turn Table EMCO	2087-2.03	NA	NA	NA
Antenna Tower & Turn BV ADT	AT100	AT93021705	NA	NA
Turn Table BV ADT	TT100	TT93021705	NA	NA
Turn Table Controller BV ADT	SC100	SC93021705	NA	NA
Boresight Antenna Fixture	FBA-01	FBA-SIP01	NA	NA
Pre-amplifier (18GHz-40GHz) EMC	EMC184045B	980175	Nov. 14, 2018	Nov. 13, 2019
USB Wideband Power Sensor KEYSIGHT	U2021XA	MY55050005/MY55190 004/MY55190007/MY55 210005	Jul. 17, 2018	Jul. 16, 2019

Note: 1. The calibration interval of the above test instruments is 12 months and the calibrations are traceable to NML/ROC and NIST/USA.  
2. The test was performed in HwaYa Chamber 9.

### 4.1.3 Test Procedures

#### For Radiated emission below 30MHz

- a. The EUT was placed on the top of a rotating table 0.8 meters above the ground at a 3 meter chamber room. The table was rotated 360 degrees to determine the position of the highest radiation.
- b. The EUT was set 3 meters away from the interference-receiving antenna, which was mounted on the top of a variable-height antenna tower.
- c. Parallel, perpendicular, and ground-parallel orientations of the antenna are set to make the measurement.
- d. For each suspected emission, the EUT was arranged to its worst case and the rotatable table was turned from 0 degrees to 360 degrees to find the maximum reading.
- e. The test-receiver system was set to Quasi-Peak Detect Function and Specified Bandwidth with Maximum Hold Mode.

Note:

1. The resolution bandwidth and video bandwidth of test receiver/spectrum analyzer is 9kHz at frequency below 30MHz.

#### For Radiated emission above 30MHz

- a. The EUT was placed on the top of a rotating table 0.8 meters (for 30MHz ~ 1GHz) / 1.5 meters (for above 1GHz) above the ground at 3 meter chamber room for test. The table was rotated 360 degrees to determine the position of the highest radiation.
- b. The EUT was set 3 meters away from the interference-receiving antenna, which was mounted on the top of a variable-height antenna tower.
- c. The height of antenna is varied from one meter to four meters above the ground to determine the maximum value of the field strength. Both horizontal and vertical polarizations of the antenna are set to make the measurement.
- d. For each suspected emission, the EUT was arranged to its worst case and then the antenna was tuned to heights from 1 meter to 4 meters and the rotatable table was turned from 0 degrees to 360 degrees to find the maximum reading.
- e. The test-receiver system was set to quasi-peak detect function and specified bandwidth with maximum hold mode when the test frequency is below 1 GHz.
- f. The test-receiver system was set to peak and average detect function and specified bandwidth with maximum hold mode when the test frequency is above 1 GHz. If the peak reading value also meets average limit, measurement with the average detector is unnecessary.

Note:

1. The resolution bandwidth and video bandwidth of test receiver/spectrum analyzer is 120kHz for Quasi-peak detection (QP) at frequency below 1GHz.
2. The resolution bandwidth of test receiver/spectrum analyzer is 1 MHz and the video bandwidth is 3 MHz for Peak detection (PK) at frequency above 1GHz.
3. The resolution bandwidth of test receiver/spectrum analyzer is 1MHz and the video bandwidth is  $\geq 1/T$  (Duty cycle < 98%) or 10Hz (Duty cycle  $\geq 98\%$ ) for Average detection (AV) at frequency above 1GHz.
4. All modes of operation were investigated and the worst-case emissions are reported.

### 4.1.4 Deviation from Test Standard

No deviation.



#### 4.1.5 Test Setup

##### For Radiated emission below 30MHz

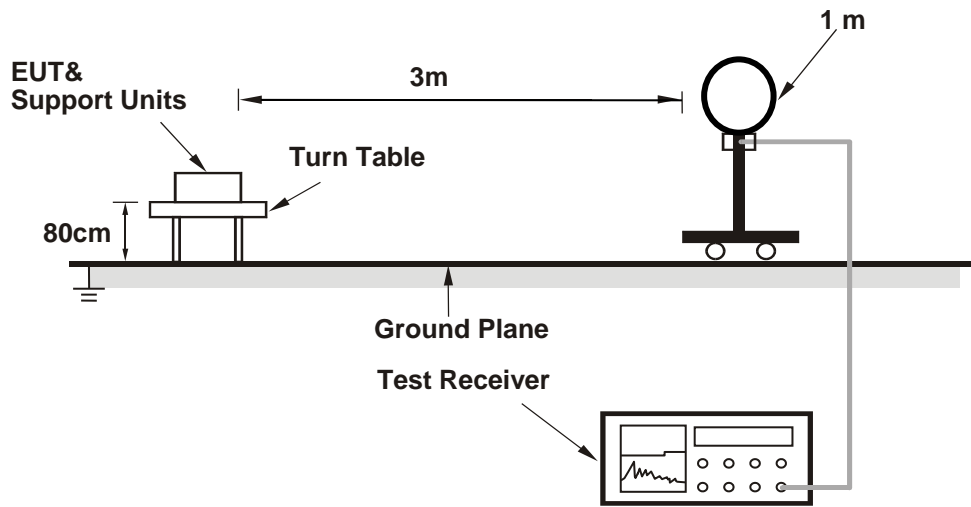

##### For Radiated emission 30MHz to 1GHz

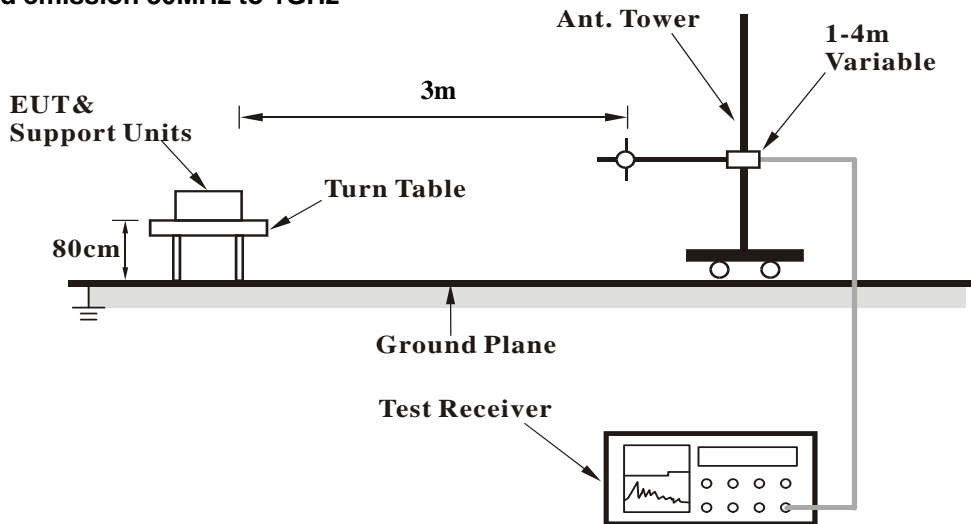

### For Radiated emission above 1GHz

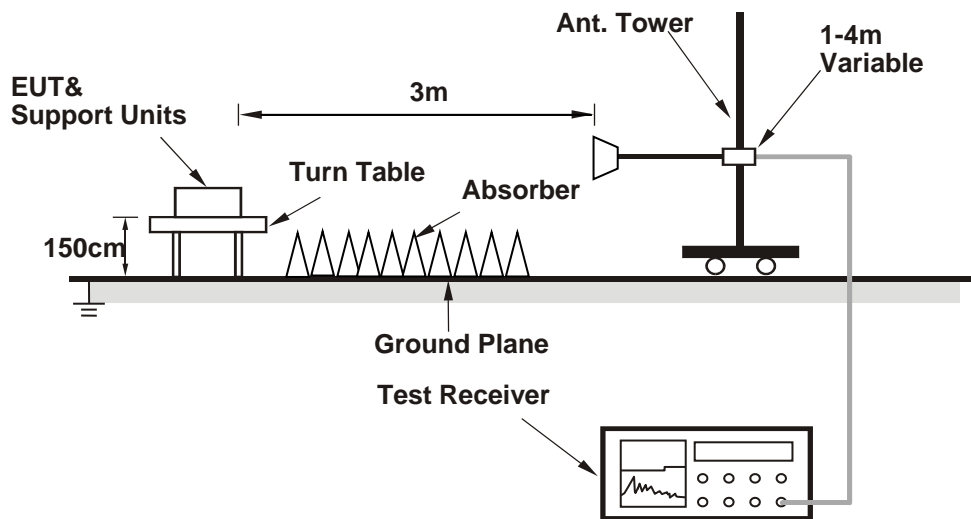

For the actual test configuration, please refer to the attached file (Test Setup Photo).

#### 4.1.6 EUT Operating Conditions

- a. Set the EUT under transmission condition continuously at specific channel frequency.

#### 4.1.7 Test Results

Above 1GHz data:

802.11a

CHANNEL	TX Channel 36	DETECTOR FUNCTION	Peak (PK) Average (AV)
FREQUENCY RANGE	1GHz ~ 40GHz		

ANTENNA POLARITY & TEST DISTANCE: HORIZONTAL AT 3 M								
NO.	FREQ. (MHz)	EMISSION LEVEL (dBuV/m)	LIMIT (dBuV/m)	MARGIN (dB)	ANTENNA HEIGHT (m)	TABLE ANGLE (Degree)	RAW VALUE (dBuV)	CORRECTION FACTOR (dB/m)
1	5150.00	64.2 PK	74.0	-9.8	1.16 H	127	60.7	3.5
2	5150.00	47.0 AV	54.0	-7.0	1.16 H	127	43.5	3.5
3	*5180.00	104.5 PK			1.22 H	131	66.5	38.0
4	*5180.00	94.7 AV			1.22 H	131	56.7	38.0
5	#10360.00	56.0 PK	68.2	-12.2	2.87 H	114	40.4	15.6
ANTENNA POLARITY & TEST DISTANCE: VERTICAL AT 3 M								
NO.	FREQ. (MHz)	EMISSION LEVEL (dBuV/m)	LIMIT (dBuV/m)	MARGIN (dB)	ANTENNA HEIGHT (m)	TABLE ANGLE (Degree)	RAW VALUE (dBuV)	CORRECTION FACTOR (dB/m)
1	5150.00	69.6 PK	74.0	-4.4	1.00 V	292	66.1	3.5
2	5150.00	52.9 AV	54.0	-1.1	1.00 V	292	49.4	3.5
3	*5180.00	110.6 PK			1.15 V	293	72.6	38.0
4	*5180.00	100.8 AV			1.15 V	293	62.8	38.0
5	#10360.00	56.9 PK	68.2	-11.3	1.67 V	254	41.3	15.6

Remarks:

1. Emission Level(dBuV/m) = Raw Value(dBuV) + Correction Factor(dB/m).
2. Correction Factor(dB/m) = Antenna Factor(dB/m) + Cable Factor(dB) – Pre-Amplifier Factor(dB).
3. Margin value = Emission Level – Limit value.
4. The other emission levels were very low against the limit.
5. " \* ": Fundamental frequency.
6. " # ": The radiated frequency is out of the restricted band.

CHANNEL	TX Channel 40	DETECTOR FUNCTION	Peak (PK) Average (AV)
FREQUENCY RANGE	1GHz ~ 40GHz		

**ANTENNA POLARITY & TEST DISTANCE: HORIZONTAL AT 3 M**

NO.	FREQ. (MHz)	EMISSION LEVEL (dBuV/m)	LIMIT (dBuV/m)	MARGIN (dB)	ANTENNA HEIGHT (m)	TABLE ANGLE (Degree)	RAW VALUE (dBuV)	CORRECTION FACTOR (dB/m)
1	5150.00	61.2 PK	74.0	-12.8	1.14 H	124	57.7	3.5
2	5150.00	47.3 AV	54.0	-6.7	1.14 H	124	43.8	3.5
3	*5200.00	108.9 PK			1.24 H	133	71.0	37.9
4	*5200.00	99.1 AV			1.24 H	133	61.2	37.9
5	#10400.00	56.4 PK	68.2	-11.8	2.93 H	117	40.8	15.6

**ANTENNA POLARITY & TEST DISTANCE: VERTICAL AT 3 M**

NO.	FREQ. (MHz)	EMISSION LEVEL (dBuV/m)	LIMIT (dBuV/m)	MARGIN (dB)	ANTENNA HEIGHT (m)	TABLE ANGLE (Degree)	RAW VALUE (dBuV)	CORRECTION FACTOR (dB/m)
1	5150.00	67.4 PK	74.0	-6.6	1.00 V	293	63.9	3.5
<b>2</b>	<b>5150.00</b>	<b>53.1 AV</b>	<b>54.0</b>	<b>-0.9</b>	<b>1.00 V</b>	<b>293</b>	<b>49.6</b>	<b>3.5</b>
3	*5200.00	114.7 PK			1.15 V	295	76.8	37.9
4	*5200.00	104.9 AV			1.15 V	295	67.0	37.9
5	#10400.00	57.3 PK	68.2	-10.9	1.73 V	261	41.7	15.6

Remarks:

1. Emission Level(dBuV/m) = Raw Value(dBuV) + Correction Factor(dB/m).
2. Correction Factor(dB/m) = Antenna Factor(dB/m) + Cable Factor(dB) – Pre-Amplifier Factor(dB).
3. Margin value = Emission Level – Limit value.
4. The other emission levels were very low against the limit.
5. " \* " : Fundamental frequency.
6. " # " : The radiated frequency is out of the restricted band.

CHANNEL	TX Channel 48	DETECTOR FUNCTION	Peak (PK) Average (AV)
FREQUENCY RANGE	1GHz ~ 40GHz		

**ANTENNA POLARITY & TEST DISTANCE: HORIZONTAL AT 3 M**

NO.	FREQ. (MHz)	EMISSION LEVEL (dBuV/m)	LIMIT (dBuV/m)	MARGIN (dB)	ANTENNA HEIGHT (m)	TABLE ANGLE (Degree)	RAW VALUE (dBuV)	CORRECTION FACTOR (dB/m)
1	*5240.00	110.1 PK			1.20 H	136	72.4	37.7
2	*5240.00	100.3 AV			1.20 H	136	62.6	37.7
3	5350.00	54.1 PK	74.0	-19.9	1.12 H	124	50.7	3.4
4	5350.00	42.2 AV	54.0	-11.8	1.12 H	124	38.8	3.4
5	#10480.00	56.5 PK	68.2	-11.7	2.83 H	117	41.1	15.4

**ANTENNA POLARITY & TEST DISTANCE: VERTICAL AT 3 M**

NO.	FREQ. (MHz)	EMISSION LEVEL (dBuV/m)	LIMIT (dBuV/m)	MARGIN (dB)	ANTENNA HEIGHT (m)	TABLE ANGLE (Degree)	RAW VALUE (dBuV)	CORRECTION FACTOR (dB/m)
1	*5240.00	116.0 PK			1.06 V	294	78.3	37.7
2	*5240.00	106.2 AV			1.06 V	294	68.5	37.7
3	5350.00	55.2 PK	74.0	-18.8	1.03 V	291	51.8	3.4
4	5350.00	43.1 AV	54.0	-10.9	1.03 V	291	39.7	3.4
5	#10480.00	57.7 PK	68.2	-10.5	1.71 V	256	42.3	15.4

Remarks:

1. Emission Level(dBuV/m) = Raw Value(dBuV) + Correction Factor(dB/m).
2. Correction Factor(dB/m) = Antenna Factor(dB/m) + Cable Factor(dB) – Pre-Amplifier Factor(dB).
3. Margin value = Emission Level – Limit value.
4. The other emission levels were very low against the limit.
5. " \* " : Fundamental frequency.
6. " # " : The radiated frequency is out of the restricted band.

CHANNEL	TX Channel 149	DETECTOR FUNCTION	Peak (PK) Average (AV)
FREQUENCY RANGE	1GHz ~ 40GHz		

**ANTENNA POLARITY & TEST DISTANCE: HORIZONTAL AT 3 M**

NO.	FREQ. (MHz)	EMISSION LEVEL (dBuV/m)	LIMIT (dBuV/m)	MARGIN (dB)	ANTENNA HEIGHT (m)	TABLE ANGLE (Degree)	RAW VALUE (dBuV)	CORRECTION FACTOR (dB/m)
1	#5635.20	55.0 PK	68.2	-13.2	1.14 H	187	51.0	4.0
2	*5745.00	111.3 PK			1.14 H	187	72.8	38.5
3	*5745.00	101.1 AV			1.14 H	187	62.6	38.5
4	#5960.00	55.7 PK	68.2	-12.5	1.14 H	187	50.9	4.8
5	11490.00	57.4 PK	74.0	-16.6	3.02 H	141	41.7	15.7
6	11490.00	43.1 AV	54.0	-10.9	3.02 H	141	27.4	15.7

**ANTENNA POLARITY & TEST DISTANCE: VERTICAL AT 3 M**

NO.	FREQ. (MHz)	EMISSION LEVEL (dBuV/m)	LIMIT (dBuV/m)	MARGIN (dB)	ANTENNA HEIGHT (m)	TABLE ANGLE (Degree)	RAW VALUE (dBuV)	CORRECTION FACTOR (dB/m)
1	#5636.80	57.1 PK	68.2	-11.1	1.05 V	318	53.1	4.0
2	*5745.00	117.3 PK			1.05 V	318	78.8	38.5
3	*5745.00	107.2 AV			1.05 V	318	68.7	38.5
4	#5952.80	52.8 PK	68.2	-15.4	1.05 V	318	48.1	4.7
5	11490.00	58.3 PK	74.0	-15.7	1.76 V	263	42.6	15.7
6	11490.00	43.9 AV	54.0	-10.1	1.76 V	263	28.2	15.7

Remarks:

1. Emission Level(dBuV/m) = Raw Value(dBuV) + Correction Factor(dB/m).
2. Correction Factor(dB/m) = Antenna Factor(dB/m) + Cable Factor(dB) – Pre-Amplifier Factor(dB).
3. Margin value = Emission Level – Limit value.
4. The other emission levels were very low against the limit.
5. " \* " : Fundamental frequency.
6. " # " : The radiated frequency is out of the restricted band.

CHANNEL	TX Channel 157	DETECTOR FUNCTION	Peak (PK) Average (AV)
FREQUENCY RANGE	1GHz ~ 40GHz		

**ANTENNA POLARITY & TEST DISTANCE: HORIZONTAL AT 3 M**

NO.	FREQ. (MHz)	EMISSION LEVEL (dBuV/m)	LIMIT (dBuV/m)	MARGIN (dB)	ANTENNA HEIGHT (m)	TABLE ANGLE (Degree)	RAW VALUE (dBuV)	CORRECTION FACTOR (dB/m)
1	#5611.20	55.1 PK	68.2	-13.1	1.19 H	186	51.3	3.8
2	*5785.00	110.4 PK			1.19 H	186	71.7	38.7
3	*5785.00	100.1 AV			1.19 H	186	61.4	38.7
4	#5989.60	55.6 PK	68.2	-12.6	1.19 H	186	50.9	4.7
5	11570.00	57.0 PK	74.0	-17.0	2.94 H	135	41.5	15.5
6	11570.00	42.9 AV	54.0	-11.1	2.94 H	135	27.4	15.5

**ANTENNA POLARITY & TEST DISTANCE: VERTICAL AT 3 M**

NO.	FREQ. (MHz)	EMISSION LEVEL (dBuV/m)	LIMIT (dBuV/m)	MARGIN (dB)	ANTENNA HEIGHT (m)	TABLE ANGLE (Degree)	RAW VALUE (dBuV)	CORRECTION FACTOR (dB/m)
1	#5640.00	54.0 PK	68.2	-14.2	1.08 V	316	49.9	4.1
2	*5785.00	116.5 PK			1.08 V	316	77.8	38.7
3	*5785.00	106.0 AV			1.08 V	316	67.3	38.7
4	#5935.20	53.3 PK	68.2	-14.9	1.08 V	316	48.6	4.7
5	11570.00	58.3 PK	74.0	-15.7	1.79 V	264	42.8	15.5
6	11570.00	43.9 AV	54.0	-10.1	1.79 V	264	28.4	15.5

Remarks:

1. Emission Level(dBuV/m) = Raw Value(dBuV) + Correction Factor(dB/m).
2. Correction Factor(dB/m) = Antenna Factor(dB/m) + Cable Factor(dB) – Pre-Amplifier Factor(dB).
3. Margin value = Emission Level – Limit value.
4. The other emission levels were very low against the limit.
5. " \* " : Fundamental frequency.
6. " # " : The radiated frequency is out of the restricted band.

CHANNEL	TX Channel 165	DETECTOR FUNCTION	Peak (PK) Average (AV)
FREQUENCY RANGE	1GHz ~ 40GHz		

**ANTENNA POLARITY & TEST DISTANCE: HORIZONTAL AT 3 M**

NO.	FREQ. (MHz)	EMISSION LEVEL (dBuV/m)	LIMIT (dBuV/m)	MARGIN (dB)	ANTENNA HEIGHT (m)	TABLE ANGLE (Degree)	RAW VALUE (dBuV)	CORRECTION FACTOR (dB/m)
1	#5630.40	53.2 PK	68.2	-15.0	1.17 H	182	49.3	3.9
2	*5825.00	109.9 PK			1.17 H	182	71.1	38.8
3	*5825.00	99.7 AV			1.17 H	182	60.9	38.8
4	#5943.20	53.2 PK	68.2	-15.0	1.17 H	182	48.5	4.7
5	11650.00	57.0 PK	74.0	-17.0	2.94 H	135	41.6	15.4
6	11650.00	43.0 AV	54.0	-11.0	2.94 H	135	27.6	15.4

**ANTENNA POLARITY & TEST DISTANCE: VERTICAL AT 3 M**

NO.	FREQ. (MHz)	EMISSION LEVEL (dBuV/m)	LIMIT (dBuV/m)	MARGIN (dB)	ANTENNA HEIGHT (m)	TABLE ANGLE (Degree)	RAW VALUE (dBuV)	CORRECTION FACTOR (dB/m)
1	#5610.40	53.1 PK	68.2	-15.1	1.03 V	315	49.3	3.8
2	*5825.00	116.0 PK			1.03 V	315	77.2	38.8
3	*5825.00	105.8 AV			1.03 V	315	67.0	38.8
4	#5972.80	53.5 PK	68.2	-14.7	1.03 V	315	48.8	4.7
5	11650.00	58.1 PK	74.0	-15.9	1.77 V	268	42.7	15.4
6	11650.00	43.9 AV	54.0	-10.1	1.77 V	268	28.5	15.4

Remarks:

1. Emission Level(dBuV/m) = Raw Value(dBuV) + Correction Factor(dB/m).
2. Correction Factor(dB/m) = Antenna Factor(dB/m) + Cable Factor(dB) – Pre-Amplifier Factor(dB).
3. Margin value = Emission Level – Limit value.
4. The other emission levels were very low against the limit.
5. " \* " : Fundamental frequency.
6. " # " : The radiated frequency is out of the restricted band.



802.11n (HT20)

CHANNEL	TX Channel 36	DETECTOR FUNCTION	Peak (PK) Average (AV)
FREQUENCY RANGE	1GHz ~ 40GHz		

ANTENNA POLARITY & TEST DISTANCE: HORIZONTAL AT 3 M								
NO.	FREQ. (MHz)	EMISSION LEVEL (dBuV/m)	LIMIT (dBuV/m)	MARGIN (dB)	ANTENNA HEIGHT (m)	TABLE ANGLE (Degree)	RAW VALUE (dBuV)	CORRECTION FACTOR (dB/m)
1	5150.00	63.7 PK	74.0	-10.3	1.21 H	126	60.2	3.5
2	5150.00	46.8 AV	54.0	-7.2	1.21 H	126	43.3	3.5
3	*5180.00	104.4 PK			1.27 H	138	66.4	38.0
4	*5180.00	94.0 AV			1.27 H	138	56.0	38.0
5	#10360.00	56.2 PK	68.2	-12.0	2.83 H	116	40.6	15.6

ANTENNA POLARITY & TEST DISTANCE: VERTICAL AT 3 M								
NO.	FREQ. (MHz)	EMISSION LEVEL (dBuV/m)	LIMIT (dBuV/m)	MARGIN (dB)	ANTENNA HEIGHT (m)	TABLE ANGLE (Degree)	RAW VALUE (dBuV)	CORRECTION FACTOR (dB/m)
1	5150.00	69.1 PK	74.0	-4.9	1.21 V	297	65.6	3.5
2	5150.00	52.7 AV	54.0	-1.3	1.21 V	297	49.2	3.5
3	*5180.00	110.5 PK			1.11 V	294	72.5	38.0
4	*5180.00	99.9 AV			1.11 V	294	61.9	38.0
5	#10360.00	57.0 PK	68.2	-11.2	1.73 V	261	41.4	15.6

Remarks:

1. Emission Level(dBuV/m) = Raw Value(dBuV) + Correction Factor(dB/m).
2. Correction Factor(dB/m) = Antenna Factor(dB/m) + Cable Factor(dB) – Pre-Amplifier Factor(dB).
3. Margin value = Emission Level – Limit value.
4. The other emission levels were very low against the limit.
5. " \* ": Fundamental frequency.
6. " # ": The radiated frequency is out of the restricted band.

CHANNEL	TX Channel 40	DETECTOR FUNCTION	Peak (PK) Average (AV)
FREQUENCY RANGE	1GHz ~ 40GHz		

**ANTENNA POLARITY & TEST DISTANCE: HORIZONTAL AT 3 M**

NO.	FREQ. (MHz)	EMISSION LEVEL (dBuV/m)	LIMIT (dBuV/m)	MARGIN (dB)	ANTENNA HEIGHT (m)	TABLE ANGLE (Degree)	RAW VALUE (dBuV)	CORRECTION FACTOR (dB/m)
1	5150.00	63.8 PK	74.0	-10.2	1.17 H	122	60.3	3.5
2	5150.00	46.9 AV	54.0	-7.1	1.17 H	122	43.4	3.5
3	*5200.00	108.5 PK			1.26 H	134	70.6	37.9
4	*5200.00	98.0 AV			1.26 H	134	60.1	37.9
5	#10400.00	56.4 PK	68.2	-11.8	2.78 H	121	40.8	15.6

**ANTENNA POLARITY & TEST DISTANCE: VERTICAL AT 3 M**

NO.	FREQ. (MHz)	EMISSION LEVEL (dBuV/m)	LIMIT (dBuV/m)	MARGIN (dB)	ANTENNA HEIGHT (m)	TABLE ANGLE (Degree)	RAW VALUE (dBuV)	CORRECTION FACTOR (dB/m)
1	5150.00	69.4 PK	74.0	-4.6	1.01 V	299	65.9	3.5
2	5150.00	53.0 AV	54.0	-1.0	1.01 V	299	49.5	3.5
3	*5200.00	114.4 PK			1.20 V	294	76.5	37.9
4	*5200.00	103.9 AV			1.20 V	294	66.0	37.9
5	#10400.00	58.8 PK	68.2	-9.4	1.64 V	259	43.2	15.6

**Remarks:**

1. Emission Level(dBuV/m) = Raw Value(dBuV) + Correction Factor(dB/m).
2. Correction Factor(dB/m) = Antenna Factor(dB/m) + Cable Factor(dB) – Pre-Amplifier Factor(dB).
3. Margin value = Emission Level – Limit value.
4. The other emission levels were very low against the limit.
5. " \* ": Fundamental frequency.
6. " # ": The radiated frequency is out of the restricted band.

CHANNEL	TX Channel 48	DETECTOR FUNCTION	Peak (PK) Average (AV)
FREQUENCY RANGE	1GHz ~ 40GHz		

**ANTENNA POLARITY & TEST DISTANCE: HORIZONTAL AT 3 M**

NO.	FREQ. (MHz)	EMISSION LEVEL (dBuV/m)	LIMIT (dBuV/m)	MARGIN (dB)	ANTENNA HEIGHT (m)	TABLE ANGLE (Degree)	RAW VALUE (dBuV)	CORRECTION FACTOR (dB/m)
1	*5240.00	109.6 PK			1.17 H	139	71.9	37.7
2	*5240.00	99.5 AV			1.17 H	139	61.8	37.7
3	5350.00	54.1 PK	74.0	-19.9	1.26 H	143	50.7	3.4
4	5350.00	42.1 AV	54.0	-11.9	1.26 H	143	38.7	3.4
5	#10480.00	56.6 PK	68.2	-11.6	2.75 H	123	41.2	15.4

**ANTENNA POLARITY & TEST DISTANCE: VERTICAL AT 3 M**

NO.	FREQ. (MHz)	EMISSION LEVEL (dBuV/m)	LIMIT (dBuV/m)	MARGIN (dB)	ANTENNA HEIGHT (m)	TABLE ANGLE (Degree)	RAW VALUE (dBuV)	CORRECTION FACTOR (dB/m)
1	*5240.00	115.6 PK			1.04 V	315	77.9	37.7
2	*5240.00	105.5 AV			1.04 V	315	67.8	37.7
3	5350.00	55.8 PK	74.0	-18.2	1.07 V	296	52.4	3.4
4	5350.00	42.7 AV	54.0	-11.3	1.07 V	296	39.3	3.4
5	#10480.00	59.0 PK	68.2	-9.2	1.66 V	253	43.6	15.4

Remarks:

1. Emission Level(dBuV/m) = Raw Value(dBuV) + Correction Factor(dB/m).
2. Correction Factor(dB/m) = Antenna Factor(dB/m) + Cable Factor(dB) – Pre-Amplifier Factor(dB).
3. Margin value = Emission Level – Limit value.
4. The other emission levels were very low against the limit.
5. " \* " : Fundamental frequency.
6. " # " : The radiated frequency is out of the restricted band.

CHANNEL	TX Channel 149	DETECTOR FUNCTION	Peak (PK) Average (AV)
FREQUENCY RANGE	1GHz ~ 40GHz		

**ANTENNA POLARITY & TEST DISTANCE: HORIZONTAL AT 3 M**

NO.	FREQ. (MHz)	EMISSION LEVEL (dBuV/m)	LIMIT (dBuV/m)	MARGIN (dB)	ANTENNA HEIGHT (m)	TABLE ANGLE (Degree)	RAW VALUE (dBuV)	CORRECTION FACTOR (dB/m)
1	#5640.00	54.6 PK	68.2	-13.6	1.21 H	183	50.5	4.1
2	*5745.00	109.1 PK			1.21 H	183	70.6	38.5
3	*5745.00	98.7 AV			1.21 H	183	60.2	38.5
4	#5993.60	54.8 PK	68.2	-13.4	1.21 H	183	50.1	4.7
5	11490.00	57.4 PK	74.0	-16.6	2.97 H	139	41.7	15.7
6	11490.00	43.2 AV	54.0	-10.8	2.97 H	139	27.5	15.7

**ANTENNA POLARITY & TEST DISTANCE: VERTICAL AT 3 M**

NO.	FREQ. (MHz)	EMISSION LEVEL (dBuV/m)	LIMIT (dBuV/m)	MARGIN (dB)	ANTENNA HEIGHT (m)	TABLE ANGLE (Degree)	RAW VALUE (dBuV)	CORRECTION FACTOR (dB/m)
1	#5644.80	59.5 PK	68.2	-8.7	1.01 V	316	55.4	4.1
2	*5745.00	115.0 PK			1.01 V	316	76.5	38.5
3	*5745.00	104.6 AV			1.01 V	316	66.1	38.5
4	#5982.40	55.5 PK	68.2	-12.7	1.01 V	316	50.8	4.7
5	11490.00	58.3 PK	74.0	-15.7	1.82 V	265	42.6	15.7
6	11490.00	44.3 AV	54.0	-9.7	1.82 V	265	28.6	15.7

Remarks:

1. Emission Level(dBuV/m) = Raw Value(dBuV) + Correction Factor(dB/m).
2. Correction Factor(dB/m) = Antenna Factor(dB/m) + Cable Factor(dB) – Pre-Amplifier Factor(dB).
3. Margin value = Emission Level – Limit value.
4. The other emission levels were very low against the limit.
5. " \* " : Fundamental frequency.
6. " # " : The radiated frequency is out of the restricted band.

CHANNEL	TX Channel 157	DETECTOR FUNCTION	Peak (PK) Average (AV)
FREQUENCY RANGE	1GHz ~ 40GHz		

**ANTENNA POLARITY & TEST DISTANCE: HORIZONTAL AT 3 M**

NO.	FREQ. (MHz)	EMISSION LEVEL (dBuV/m)	LIMIT (dBuV/m)	MARGIN (dB)	ANTENNA HEIGHT (m)	TABLE ANGLE (Degree)	RAW VALUE (dBuV)	CORRECTION FACTOR (dB/m)
1	#5620.00	54.3 PK	68.2	-13.9	1.19 H	189	50.4	3.9
2	*5785.00	108.6 PK			1.19 H	189	69.9	38.7
3	*5785.00	98.3 AV			1.19 H	189	59.6	38.7
4	#5928.00	56.4 PK	68.2	-11.8	1.19 H	189	51.7	4.7
5	11570.00	57.3 PK	74.0	-16.7	2.99 H	138	41.8	15.5
6	11570.00	42.8 AV	54.0	-11.2	2.99 H	138	27.3	15.5

**ANTENNA POLARITY & TEST DISTANCE: VERTICAL AT 3 M**

NO.	FREQ. (MHz)	EMISSION LEVEL (dBuV/m)	LIMIT (dBuV/m)	MARGIN (dB)	ANTENNA HEIGHT (m)	TABLE ANGLE (Degree)	RAW VALUE (dBuV)	CORRECTION FACTOR (dB/m)
1	#5604.80	53.5 PK	68.2	-14.7	1.07 V	310	49.7	3.8
2	*5785.00	114.5 PK			1.07 V	310	75.8	38.7
3	*5785.00	104.2 AV			1.07 V	310	65.5	38.7
4	#5936.80	53.1 PK	68.2	-15.1	1.07 V	310	48.4	4.7
5	11570.00	57.9 PK	74.0	-16.1	1.74 V	258	42.4	15.5
6	11570.00	43.7 AV	54.0	-10.3	1.74 V	258	28.2	15.5

**Remarks:**

1. Emission Level(dBuV/m) = Raw Value(dBuV) + Correction Factor(dB/m).
2. Correction Factor(dB/m) = Antenna Factor(dB/m) + Cable Factor(dB) – Pre-Amplifier Factor(dB).
3. Margin value = Emission Level – Limit value.
4. The other emission levels were very low against the limit.
5. " \* " : Fundamental frequency.
6. " # " : The radiated frequency is out of the restricted band.

CHANNEL	TX Channel 165	DETECTOR FUNCTION	Peak (PK) Average (AV)
FREQUENCY RANGE	1GHz ~ 40GHz		

ANTENNA POLARITY & TEST DISTANCE: HORIZONTAL AT 3 M								
NO.	FREQ. (MHz)	EMISSION LEVEL (dBuV/m)	LIMIT (dBuV/m)	MARGIN (dB)	ANTENNA HEIGHT (m)	TABLE ANGLE (Degree)	RAW VALUE (dBuV)	CORRECTION FACTOR (dB/m)
1	#5635.20	54.1 PK	68.2	-14.1	1.22 H	179	50.1	4.0
2	*5825.00	108.0 PK			1.22 H	179	69.2	38.8
3	*5825.00	97.5 AV			1.22 H	179	58.7	38.8
4	#5975.20	56.4 PK	68.2	-11.8	1.22 H	179	51.7	4.7
5	11650.00	57.2 PK	74.0	-16.8	2.96 H	132	41.8	15.4
6	11650.00	43.0 AV	54.0	-11.0	2.96 H	132	27.6	15.4

ANTENNA POLARITY & TEST DISTANCE: VERTICAL AT 3 M								
NO.	FREQ. (MHz)	EMISSION LEVEL (dBuV/m)	LIMIT (dBuV/m)	MARGIN (dB)	ANTENNA HEIGHT (m)	TABLE ANGLE (Degree)	RAW VALUE (dBuV)	CORRECTION FACTOR (dB/m)
1	#5635.20	54.0 PK	68.2	-14.2	1.21 V	317	50.0	4.0
2	*5825.00	114.0 PK			1.21 V	317	75.2	38.8
3	*5825.00	103.5 AV			1.21 V	317	64.7	38.8
4	#5982.40	53.8 PK	68.2	-14.4	1.21 V	317	49.1	4.7
5	11650.00	58.1 PK	74.0	-15.9	1.79 V	264	42.7	15.4
6	11650.00	43.8 AV	54.0	-10.2	1.79 V	264	28.4	15.4

Remarks:

1. Emission Level(dBuV/m) = Raw Value(dBuV) + Correction Factor(dB/m).
2. Correction Factor(dB/m) = Antenna Factor(dB/m) + Cable Factor(dB) – Pre-Amplifier Factor(dB).
3. Margin value = Emission Level – Limit value.
4. The other emission levels were very low against the limit.
5. " \* " : Fundamental frequency.
6. " # " : The radiated frequency is out of the restricted band.

802.11n (HT40)

CHANNEL	TX Channel 38	DETECTOR FUNCTION	Peak (PK) Average (AV)
FREQUENCY RANGE	1GHz ~ 40GHz		

ANTENNA POLARITY & TEST DISTANCE: HORIZONTAL AT 3 M								
NO.	FREQ. (MHz)	EMISSION LEVEL (dBuV/m)	LIMIT (dBuV/m)	MARGIN (dB)	ANTENNA HEIGHT (m)	TABLE ANGLE (Degree)	RAW VALUE (dBuV)	CORRECTION FACTOR (dB/m)
1	5150.00	63.9 PK	74.0	-10.1	1.18 H	128	60.4	3.5
2	5150.00	47.0 AV	54.0	-7.0	1.18 H	128	43.5	3.5
3	*5190.00	99.2 PK			1.24 H	134	61.3	37.9
4	*5190.00	89.1 AV			1.24 H	134	51.2	37.9
5	#10380.00	56.0 PK	68.2	-12.2	2.74 H	121	40.3	15.7

ANTENNA POLARITY & TEST DISTANCE: VERTICAL AT 3 M								
NO.	FREQ. (MHz)	EMISSION LEVEL (dBuV/m)	LIMIT (dBuV/m)	MARGIN (dB)	ANTENNA HEIGHT (m)	TABLE ANGLE (Degree)	RAW VALUE (dBuV)	CORRECTION FACTOR (dB/m)
1	5150.00	69.3 PK	74.0	-4.7	1.16 V	296	65.8	3.5
2	5150.00	52.9 AV	54.0	-1.1	1.16 V	296	49.4	3.5
3	*5190.00	105.0 PK			1.19 V	298	67.1	37.9
4	*5190.00	94.9 AV			1.19 V	298	57.0	37.9
5	#10380.00	57.2 PK	68.2	-11.0	1.71 V	258	41.5	15.7

Remarks:

1. Emission Level(dBuV/m) = Raw Value(dBuV) + Correction Factor(dB/m).
2. Correction Factor(dB/m) = Antenna Factor(dB/m) + Cable Factor(dB) – Pre-Amplifier Factor(dB).
3. Margin value = Emission Level – Limit value.
4. The other emission levels were very low against the limit.
5. " \* ": Fundamental frequency.
6. " # ": The radiated frequency is out of the restricted band.

CHANNEL	TX Channel 46	DETECTOR FUNCTION	Peak (PK) Average (AV)
FREQUENCY RANGE	1GHz ~ 40GHz		

**ANTENNA POLARITY & TEST DISTANCE: HORIZONTAL AT 3 M**

NO.	FREQ. (MHz)	EMISSION LEVEL (dBuV/m)	LIMIT (dBuV/m)	MARGIN (dB)	ANTENNA HEIGHT (m)	TABLE ANGLE (Degree)	RAW VALUE (dBuV)	CORRECTION FACTOR (dB/m)
1	5150.00	64.3 PK	74.0	-9.7	1.31 H	133	60.8	3.5
2	5150.00	47.4 AV	54.0	-6.6	1.31 H	133	43.9	3.5
3	*5230.00	105.4 PK			1.26 H	128	67.7	37.7
4	*5230.00	95.2 AV			1.26 H	128	57.5	37.7
5	5350.00	54.0 PK	74.0	-20.0	1.20 H	137	50.6	3.4
6	5350.00	43.1 AV	54.0	-10.9	1.20 H	137	39.7	3.4
7	#10460.00	56.6 PK	68.2	-11.6	2.67 H	119	41.2	15.4

**ANTENNA POLARITY & TEST DISTANCE: VERTICAL AT 3 M**

NO.	FREQ. (MHz)	EMISSION LEVEL (dBuV/m)	LIMIT (dBuV/m)	MARGIN (dB)	ANTENNA HEIGHT (m)	TABLE ANGLE (Degree)	RAW VALUE (dBuV)	CORRECTION FACTOR (dB/m)
1	5150.00	69.4 PK	74.0	-4.6	1.16 V	297	65.9	3.5
<b>2</b>	<b>5150.00</b>	<b>53.1 AV</b>	<b>54.0</b>	<b>-0.9</b>	<b>1.16 V</b>	<b>297</b>	<b>49.6</b>	<b>3.5</b>
3	*5230.00	111.2 PK			1.04 V	294	73.5	37.7
4	*5230.00	101.0 AV			1.04 V	294	63.3	37.7
5	5350.00	57.9 PK	74.0	-16.1	1.24 V	307	54.5	3.4
6	5350.00	43.7 AV	54.0	-10.3	1.24 V	307	40.3	3.4
7	#10460.00	58.1 PK	68.2	-10.1	1.76 V	265	42.7	15.4

Remarks:

1. Emission Level(dBuV/m) = Raw Value(dBuV) + Correction Factor(dB/m).
2. Correction Factor(dB/m) = Antenna Factor(dB/m) + Cable Factor(dB) – Pre-Amplifier Factor(dB).
3. Margin value = Emission Level – Limit value.
4. The other emission levels were very low against the limit.
5. " \* ": Fundamental frequency.
6. " # ": The radiated frequency is out of the restricted band.



CHANNEL	TX Channel 151	DETECTOR FUNCTION	Peak (PK) Average (AV)
FREQUENCY RANGE	1GHz ~ 40GHz		

**ANTENNA POLARITY & TEST DISTANCE: HORIZONTAL AT 3 M**

NO.	FREQ. (MHz)	EMISSION LEVEL (dBuV/m)	LIMIT (dBuV/m)	MARGIN (dB)	ANTENNA HEIGHT (m)	TABLE ANGLE (Degree)	RAW VALUE (dBuV)	CORRECTION FACTOR (dB/m)
1	#5649.60	61.5 PK	68.2	-6.7	1.24 H	191	57.4	4.1
2	*5755.00	106.0 PK			1.24 H	191	67.4	38.6
3	*5755.00	95.4 AV			1.24 H	191	56.8	38.6
4	#5968.80	55.9 PK	68.2	-12.3	1.24 H	191	51.1	4.8
5	11510.00	57.5 PK	74.0	-16.5	2.93 H	135	41.8	15.7
6	11510.00	43.2 AV	54.0	-10.8	2.93 H	135	27.5	15.7

**ANTENNA POLARITY & TEST DISTANCE: VERTICAL AT 3 M**

NO.	FREQ. (MHz)	EMISSION LEVEL (dBuV/m)	LIMIT (dBuV/m)	MARGIN (dB)	ANTENNA HEIGHT (m)	TABLE ANGLE (Degree)	RAW VALUE (dBuV)	CORRECTION FACTOR (dB/m)
1	#5648.80	66.4 PK	68.2	-1.8	1.14 V	311	62.3	4.1
2	*5755.00	112.1 PK			1.14 V	311	73.5	38.6
3	*5755.00	101.5 AV			1.14 V	311	62.9	38.6
4	#5940.00	56.0 PK	68.2	-12.2	1.14 V	311	51.3	4.7
5	11510.00	58.2 PK	74.0	-15.8	1.84 V	144	42.5	15.7
6	11510.00	43.8 AV	54.0	-10.2	1.84 V	144	28.1	15.7

Remarks:

1. Emission Level(dBuV/m) = Raw Value(dBuV) + Correction Factor(dB/m).
2. Correction Factor(dB/m) = Antenna Factor(dB/m) + Cable Factor(dB) – Pre-Amplifier Factor(dB).
3. Margin value = Emission Level – Limit value.
4. The other emission levels were very low against the limit.
5. " \* " : Fundamental frequency.
6. " # " : The radiated frequency is out of the restricted band.

CHANNEL	TX Channel 159	DETECTOR FUNCTION	Peak (PK) Average (AV)
FREQUENCY RANGE	1GHz ~ 40GHz		

**ANTENNA POLARITY & TEST DISTANCE: HORIZONTAL AT 3 M**

NO.	FREQ. (MHz)	EMISSION LEVEL (dBuV/m)	LIMIT (dBuV/m)	MARGIN (dB)	ANTENNA HEIGHT (m)	TABLE ANGLE (Degree)	RAW VALUE (dBuV)	CORRECTION FACTOR (dB/m)
1	#5648.80	56.3 PK	68.2	-11.9	1.23 H	191	52.2	4.1
2	*5795.00	105.1 PK			1.23 H	191	66.4	38.7
3	*5795.00	95.0 AV			1.23 H	191	56.3	38.7
4	#5938.40	55.3 PK	68.2	-12.9	1.23 H	191	50.6	4.7
5	11590.00	56.8 PK	74.0	-17.2	2.98 H	137	41.4	15.4
6	11590.00	42.4 AV	54.0	-11.6	2.98 H	137	27.0	15.4

**ANTENNA POLARITY & TEST DISTANCE: VERTICAL AT 3 M**

NO.	FREQ. (MHz)	EMISSION LEVEL (dBuV/m)	LIMIT (dBuV/m)	MARGIN (dB)	ANTENNA HEIGHT (m)	TABLE ANGLE (Degree)	RAW VALUE (dBuV)	CORRECTION FACTOR (dB/m)
1	#5646.40	61.1 PK	68.2	-7.1	1.14 V	311	57.0	4.1
2	*5795.00	111.0 PK			1.14 V	311	72.3	38.7
3	*5795.00	100.9 AV			1.14 V	311	62.2	38.7
4	#5929.60	56.9 PK	68.2	-11.3	1.14 V	311	52.2	4.7
5	11590.00	57.9 PK	74.0	-16.1	1.93 V	142	42.5	15.4
6	11590.00	43.6 AV	54.0	-10.4	1.93 V	142	28.2	15.4

Remarks:

1. Emission Level(dBuV/m) = Raw Value(dBuV) + Correction Factor(dB/m).
2. Correction Factor(dB/m) = Antenna Factor(dB/m) + Cable Factor(dB) – Pre-Amplifier Factor(dB).
3. Margin value = Emission Level – Limit value.
4. The other emission levels were very low against the limit.
5. " \* " : Fundamental frequency.
6. " # " : The radiated frequency is out of the restricted band.

802.11ac (VHT80)

CHANNEL	TX Channel 42	DETECTOR FUNCTION	Peak (PK) Average (AV)
FREQUENCY RANGE	1GHz ~ 40GHz		

ANTENNA POLARITY & TEST DISTANCE: HORIZONTAL AT 3 M

NO.	FREQ. (MHz)	EMISSION LEVEL (dBuV/m)	LIMIT (dBuV/m)	MARGIN (dB)	ANTENNA HEIGHT (m)	TABLE ANGLE (Degree)	RAW VALUE (dBuV)	CORRECTION FACTOR (dB/m)
1	5150.00	61.5 PK	74.0	-12.5	1.14 H	135	58.0	3.5
2	5150.00	48.1 AV	54.0	-5.9	1.14 H	135	44.6	3.5
3	*5210.00	95.5 PK			1.05 H	130	57.7	37.8
4	*5210.00	84.5 AV			1.05 H	130	46.7	37.8
5	5350.00	54.0 PK	74.0	-20.0	1.00 H	127	50.6	3.4
6	5350.00	42.8 AV	54.0	-11.2	1.00 H	127	39.4	3.4
7	#10420.00	55.4 PK	68.2	-12.8	2.76 H	109	39.8	15.6

ANTENNA POLARITY & TEST DISTANCE: VERTICAL AT 3 M

NO.	FREQ. (MHz)	EMISSION LEVEL (dBuV/m)	LIMIT (dBuV/m)	MARGIN (dB)	ANTENNA HEIGHT (m)	TABLE ANGLE (Degree)	RAW VALUE (dBuV)	CORRECTION FACTOR (dB/m)
1	5150.00	68.4 PK	74.0	-5.6	1.20 V	297	64.9	3.5
2	5150.00	53.0 AV	54.0	-1.0	1.20 V	297	49.5	3.5
3	*5210.00	100.2 PK			1.11 V	299	62.4	37.8
4	*5210.00	89.3 AV			1.11 V	299	51.5	37.8
5	5350.00	55.7 PK	74.0	-18.3	1.12 V	305	52.3	3.4
6	5350.00	43.8 AV	54.0	-10.2	1.12 V	305	40.4	3.4
7	#10420.00	56.6 PK	68.2	-11.6	1.76 V	255	41.0	15.6

Remarks:

1. Emission Level(dBuV/m) = Raw Value(dBuV) + Correction Factor(dB/m).
2. Correction Factor(dB/m) = Antenna Factor(dB/m) + Cable Factor(dB) – Pre-Amplifier Factor(dB).
3. Margin value = Emission Level – Limit value.
4. The other emission levels were very low against the limit.
5. " \* ": Fundamental frequency.
6. " # ": The radiated frequency is out of the restricted band.

CHANNEL	TX Channel 155	DETECTOR FUNCTION	Peak (PK) Average (AV)
FREQUENCY RANGE	1GHz ~ 40GHz		

**ANTENNA POLARITY & TEST DISTANCE: HORIZONTAL AT 3 M**

NO.	FREQ. (MHz)	EMISSION LEVEL (dBuV/m)	LIMIT (dBuV/m)	MARGIN (dB)	ANTENNA HEIGHT (m)	TABLE ANGLE (Degree)	RAW VALUE (dBuV)	CORRECTION FACTOR (dB/m)
1	#5647.20	57.7 PK	68.2	-10.5	1.18 H	188	53.6	4.1
2	#5650.00	60.9 PK	68.2	-7.3	1.21 H	194	56.8	4.1
3	*5775.00	100.5 PK			1.18 H	188	61.9	38.6
4	*5775.00	89.0 AV			1.18 H	188	50.4	38.6
5	#5925.00	56.4 PK	68.2	-11.8	1.12 H	182	51.7	4.7
6	#5964.00	55.4 PK	68.2	-12.8	1.18 H	188	50.6	4.8
7	11550.00	57.1 PK	74.0	-16.9	3.03 H	141	41.5	15.6
8	11550.00	42.8 AV	54.0	-11.2	3.03 H	141	27.2	15.6

**ANTENNA POLARITY & TEST DISTANCE: VERTICAL AT 3 M**

NO.	FREQ. (MHz)	EMISSION LEVEL (dBuV/m)	LIMIT (dBuV/m)	MARGIN (dB)	ANTENNA HEIGHT (m)	TABLE ANGLE (Degree)	RAW VALUE (dBuV)	CORRECTION FACTOR (dB/m)
1	#5637.60	65.1 PK	68.2	-3.1	1.13 V	311	61.1	4.0
2	#5650.00	67.0 PK	68.2	-1.2	1.16 V	312	62.9	4.1
3	*5775.00	106.6 PK			1.13 V	311	68.0	38.6
4	*5775.00	95.1 AV			1.13 V	311	56.5	38.6
5	#5925.00	58.2 PK	68.2	-10.0	1.08 V	307	53.5	4.7
6	#5932.80	55.4 PK	68.2	-12.8	1.13 V	311	50.7	4.7
7	11550.00	58.2 PK	74.0	-15.8	1.87 V	147	42.6	15.6
8	11550.00	43.9 AV	54.0	-10.1	1.87 V	147	28.3	15.6

**Remarks:**

1. Emission Level(dBuV/m) = Raw Value(dBuV) + Correction Factor(dB/m).
2. Correction Factor(dB/m) = Antenna Factor(dB/m) + Cable Factor(dB) – Pre-Amplifier Factor(dB).
3. Margin value = Emission Level – Limit value.
4. The other emission levels were very low against the limit.
5. " \* ": Fundamental frequency.
6. " # ": The radiated frequency is out of the restricted band.

Below 1GHz Worst-Case Data:

802.11a

CHANNEL	TX Channel 40	DETECTOR FUNCTION	Quasi-Peak (QP)
FREQUENCY RANGE	9kHz ~ 1GHz		
TEST MODE	A		

ANTENNA POLARITY & TEST DISTANCE: HORIZONTAL AT 3 M								
NO.	FREQ. (MHz)	EMISSION LEVEL (dBuV/m)	LIMIT (dBuV/m)	MARGIN (dB)	ANTENNA HEIGHT (m)	TABLE ANGLE (Degree)	RAW VALUE (dBuV)	CORRECTION FACTOR (dB/m)
1	115.36	27.4 QP	43.5	-16.1	1.00 H	117	39.4	-12.0
2	224.97	27.5 QP	46.0	-18.5	1.25 H	261	38.6	-11.1
3	335.55	42.4 QP	46.0	-3.6	1.50 H	248	49.6	-7.2
4	623.64	38.5 QP	46.0	-7.5	1.25 H	323	40.3	-1.8
5	719.67	39.0 QP	46.0	-7.0	1.50 H	213	39.2	-0.2
6	864.20	33.8 QP	46.0	-12.2	1.00 H	1	31.1	2.7

Remarks:

1. Emission Level(dBuV/m) = Raw Value(dBuV) + Correction Factor(dB/m).
2. Correction Factor(dB/m) = Antenna Factor(dB/m) + Cable Factor(dB) – Pre-Amplifier Factor(dB).
3. The other emission levels were very low against the limit of frequency range 30MHz ~ 1000MHz.
4. Margin value = Emission Level – Limit value.
5. The emission levels were very low against the limit of frequency range 9kHz ~ 30MHz: the amplitude of spurious emissions attenuated more than 20 dB below the permissible value to be report.

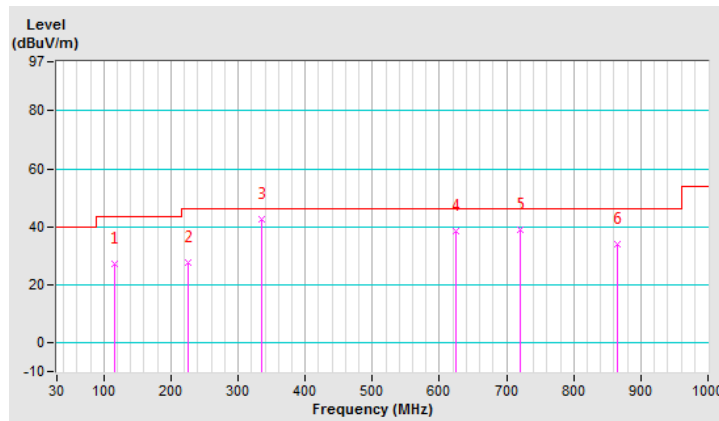

CHANNEL	TX Channel 40	DETECTOR FUNCTION	Quasi-Peak (QP)
FREQUENCY RANGE	9kHz ~ 1GHz		
TEST MODE	A		

ANTENNA POLARITY & TEST DISTANCE: VERTICAL AT 3 M								
NO.	FREQ. (MHz)	EMISSION LEVEL (dBuV/m)	LIMIT (dBuV/m)	MARGIN (dB)	ANTENNA HEIGHT (m)	TABLE ANGLE (Degree)	RAW VALUE (dBuV)	CORRECTION FACTOR (dB/m)
1	32.91	29.7 QP	40.0	-10.3	1.50 V	153	40.8	-11.1
2	112.45	27.4 QP	43.5	-16.1	1.50 V	15	39.6	-12.2
3	240.49	31.6 QP	46.0	-14.4	1.00 V	274	41.6	-10.0
4	431.58	38.1 QP	46.0	-7.9	1.25 V	199	43.6	-5.5
5	623.64	35.7 QP	46.0	-10.3	1.00 V	56	37.5	-1.8
6	815.70	33.7 QP	46.0	-12.3	1.50 V	195	31.8	1.9

Remarks:

1. Emission Level(dBuV/m) = Raw Value(dBuV) + Correction Factor(dB/m).
2. Correction Factor(dB/m) = Antenna Factor(dB/m) + Cable Factor(dB) – Pre-Amplifier Factor(dB).
3. The other emission levels were very low against the limit of frequency range 30MHz ~ 1000MHz.
4. Margin value = Emission Level – Limit value.
5. The emission levels were very low against the limit of frequency range 9kHz ~ 30MHz: the amplitude of spurious emissions attenuated more than 20 dB below the permissible value to be report.

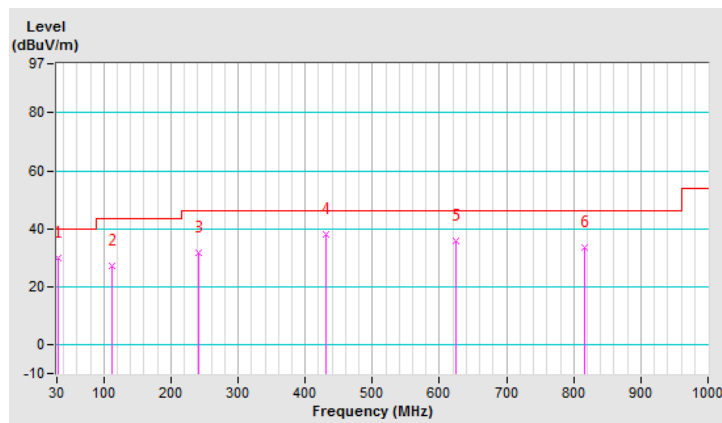

CHANNEL	TX Channel 40	DETECTOR FUNCTION	Quasi-Peak (QP)
FREQUENCY RANGE	9kHz ~ 1GHz		
TEST MODE	B		

ANTENNA POLARITY & TEST DISTANCE: HORIZONTAL AT 3 M								
NO.	FREQ. (MHz)	EMISSION LEVEL (dBuV/m)	LIMIT (dBuV/m)	MARGIN (dB)	ANTENNA HEIGHT (m)	TABLE ANGLE (Degree)	RAW VALUE (dBuV)	CORRECTION FACTOR (dB/m)
1	33.88	38.0 QP	40.0	-2.0	1.25 H	26	48.7	-10.7
2	216.24	33.7 QP	46.0	-12.3	1.50 H	290	45.0	-11.3
3	359.80	39.7 QP	46.0	-6.3	1.00 H	123	46.8	-7.1
4	431.58	39.7 QP	46.0	-6.3	1.00 H	128	45.2	-5.5
5	647.89	37.8 QP	46.0	-8.2	1.00 H	158	39.1	-1.3
6	815.70	32.9 QP	46.0	-13.1	1.25 H	233	31.0	1.9

Remarks:

1. Emission Level(dBuV/m) = Raw Value(dBuV) + Correction Factor(dB/m).
2. Correction Factor(dB/m) = Antenna Factor(dB/m) + Cable Factor(dB) – Pre-Amplifier Factor(dB).
3. The other emission levels were very low against the limit of frequency range 30MHz ~ 1000MHz.
4. Margin value = Emission Level – Limit value.
5. The emission levels were very low against the limit of frequency range 9kHz ~ 30MHz: the amplitude of spurious emissions attenuated more than 20 dB below the permissible value to be report.

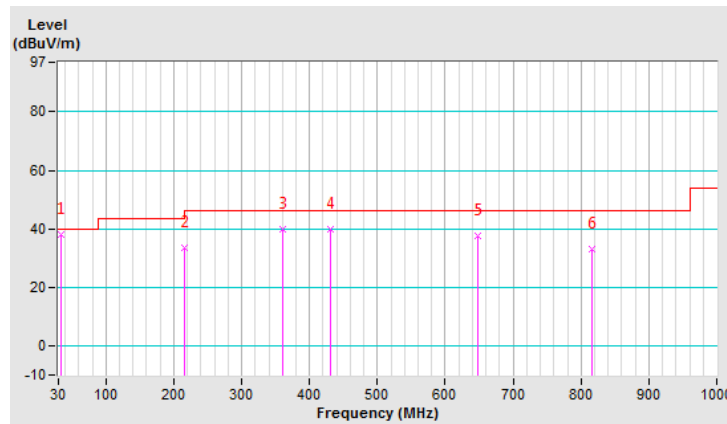

CHANNEL	TX Channel 40	DETECTOR FUNCTION	Quasi-Peak (QP)
FREQUENCY RANGE	9kHz ~ 1GHz		
TEST MODE	B		

ANTENNA POLARITY & TEST DISTANCE: VERTICAL AT 3 M								
NO.	FREQ. (MHz)	EMISSION LEVEL (dBuV/m)	LIMIT (dBuV/m)	MARGIN (dB)	ANTENNA HEIGHT (m)	TABLE ANGLE (Degree)	RAW VALUE (dBuV)	CORRECTION FACTOR (dB/m)
1	62.01	35.7 QP	40.0	-4.3	1.50 V	204	46.4	-10.7
2	240.49	30.5 QP	46.0	-15.5	1.25 V	284	40.5	-10.0
3	323.91	37.8 QP	46.0	-8.2	1.25 V	302	45.2	-7.4
4	431.58	44.9 QP	46.0	-1.1	1.50 V	155	50.4	-5.5
5	540.22	37.8 QP	46.0	-8.2	1.00 V	314	41.7	-3.9
6	683.78	32.1 QP	46.0	-13.9	1.25 V	299	33.1	-1.0

Remarks:

1. Emission Level(dBuV/m) = Raw Value(dBuV) + Correction Factor(dB/m).
2. Correction Factor(dB/m) = Antenna Factor(dB/m) + Cable Factor(dB) – Pre-Amplifier Factor(dB).
3. The other emission levels were very low against the limit of frequency range 30MHz ~ 1000MHz.
4. Margin value = Emission Level – Limit value.
5. The emission levels were very low against the limit of frequency range 9kHz ~ 30MHz: the amplitude of spurious emissions attenuated more than 20 dB below the permissible value to be report.

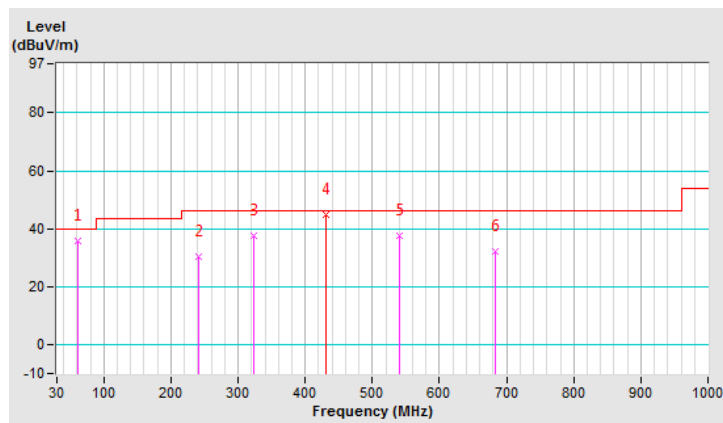



## 4.2 Conducted Emission Measurement

### 4.2.1 Limits of Conducted Emission Measurement

Frequency (MHz)	Conducted Limit (dBuV)	
	Quasi-peak	Average
0.15 - 0.5	66 - 56	56 - 46
0.50 - 5.0	56	46
5.0 - 30.0	60	50

Note: 1. The lower limit shall apply at the transition frequencies.

2. The limit decreases in line with the logarithm of the frequency in the range of 0.15 to 0.50MHz.

### 4.2.2 Test Instruments

Description & Manufacturer	Model No.	Serial No.	Cal. Date	Cal. Due
Test Receiver ROHDE & SCHWARZ	ESCI	100613	Dec. 10, 2018	Dec. 09, 2019
RF signal cable Woken	5D-FB	Cable-cond1-01	Sep. 05, 2018	Sep. 04, 2019
LISN ROHDE & SCHWARZ (EUT)	ENV216	101826	Feb. 21, 2019	Feb. 20, 2020
LISN ROHDE & SCHWARZ (Peripheral)	ESH3-Z5	100311	Aug. 19, 2018	Aug. 18, 2019
Software ADT	BV ADT_Cond_ V7.3.7.4	NA	NA	NA

Note: 1. The calibration interval of the above test instruments is 12 months and the calibrations are traceable to NML/ROC and NIST/USA.

2. The test was performed in HwaYa Shielded Room 1.

3. The VCCI Site Registration No. is C-12040.

#### 4.2.3 Test Procedures

- The EUT was placed 0.4 meters from the conducting wall of the shielded room with EUT being connected to the power mains through a line impedance stabilization network (LISN). Other support units were connected to the power mains through another LISN. The two LISNs provide 50 ohm/ 50uH of coupling impedance for the measuring instrument.
- Both lines of the power mains connected to the EUT were checked for maximum conducted interference.
- The frequency range from 150kHz to 30MHz was searched. Emission levels under (Limit - 20dB) was not recorded.

Note: The resolution bandwidth and video bandwidth of test receiver is 9kHz for quasi-peak detection (QP) and average detection (AV) at frequency 0.15MHz-30MHz.

#### 4.2.4 Deviation from Test Standard

No deviation.

#### 4.2.5 Test Setup

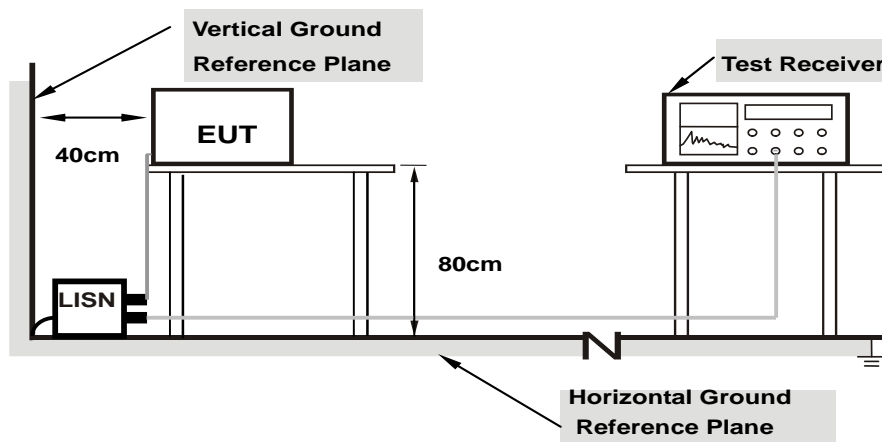

Note: 1.Support units were connected to second LISN.

For the actual test configuration, please refer to the attached file (Test Setup Photo).

#### 4.2.6 EUT Operating Conditions

Same as 4.1.6.

#### 4.2.7 Test Results

Worst-case data:

802.11a

Phase	Line (L)	Detector Function	Quasi-Peak (QP) / Average (AV)
Test Mode	A		

No	Freq. [MHz]	Corr. Factor (dB)	Reading Value		Emission Level		Limit		Margin	
			[dB (uV)]		[dB (uV)]		[dB (uV)]		(dB)	
			Q.P.	AV.	Q.P.	AV.	Q.P.	AV.	Q.P.	AV.
1	0.15000	9.69	32.12	18.92	41.81	28.61	66.00	56.00	-24.19	-27.39
2	0.19255	9.68	28.36	15.58	38.04	25.26	63.93	53.93	-25.89	-28.67
3	0.45107	9.68	20.90	13.21	30.58	22.89	56.86	46.86	-26.28	-23.97
4	1.20181	9.68	10.56	3.56	20.24	13.24	56.00	46.00	-35.76	-32.76
5	3.07863	9.73	7.92	2.61	17.65	12.34	56.00	46.00	-38.35	-33.66
6	9.22902	9.85	12.70	6.06	22.55	15.91	60.00	50.00	-37.45	-34.09

Remarks:

1. Q.P. and AV. are abbreviations of quasi-peak and average individually.
2. The emission levels of other frequencies were very low against the limit.
3. Margin value = Emission level - Limit value
4. Correction factor = Insertion loss + Cable loss
5. Emission Level = Correction Factor + Reading Value.

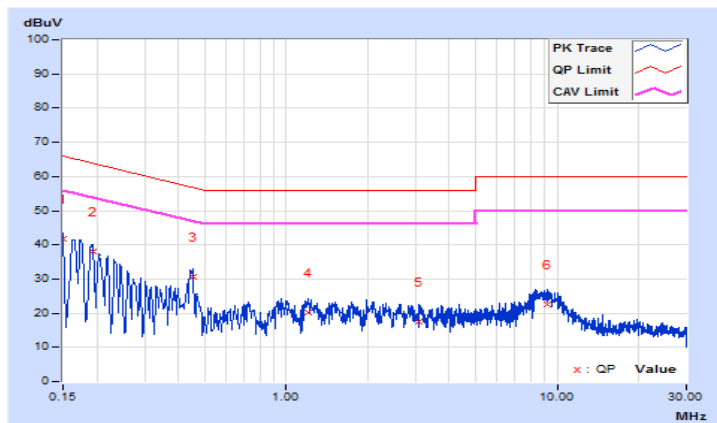

Phase	Neutral (N)	Detector Function	Quasi-Peak (QP) / Average (AV)
Test Mode	A		

No	Freq. [MHz]	Corr. Factor (dB)	Reading Value [dB (uV)]		Emission Level [dB (uV)]		Limit [dB (uV)]		Margin (dB)	
			Q.P.	AV.	Q.P.	AV.	Q.P.	AV.	Q.P.	AV.
			1	0.15000	9.66	32.14	18.75	41.80	28.41	66.00
2	0.19692	9.66	28.10	16.65	37.76	26.31	63.74	53.74	-25.98	-27.43
<b>3</b>	<b>0.44507</b>	<b>9.65</b>	<b>30.84</b>	<b>26.97</b>	<b>40.49</b>	<b>36.62</b>	<b>56.97</b>	<b>46.97</b>	<b>-16.48</b>	<b>-10.35</b>
4	0.72848	9.64	16.34	12.61	25.98	22.25	56.00	46.00	-30.02	-23.75
5	1.47214	9.65	14.90	10.13	24.55	19.78	56.00	46.00	-31.45	-26.22
6	4.45882	9.73	13.33	6.18	23.06	15.91	56.00	46.00	-32.94	-30.09

Remarks:

1. Q.P. and AV. are abbreviations of quasi-peak and average individually.
2. The emission levels of other frequencies were very low against the limit.
3. Margin value = Emission level - Limit value
4. Correction factor = Insertion loss + Cable loss
5. Emission Level = Correction Factor + Reading Value.

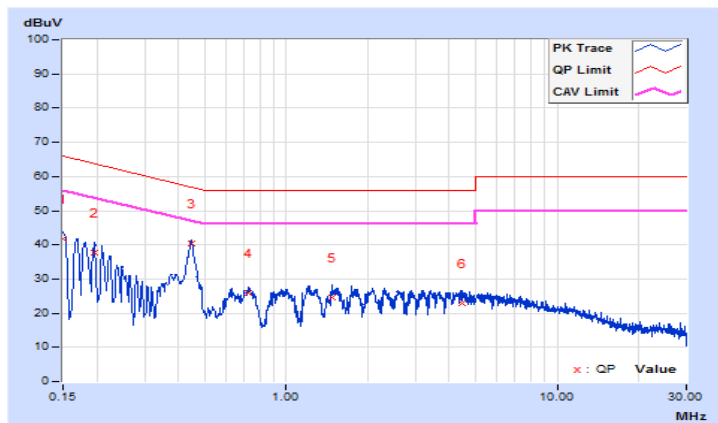

Phase	Line (L)	Detector Function	Quasi-Peak (QP) / Average (AV)
Test Mode	B		

No	Freq. [MHz]	Corr. Factor (dB)	Reading Value [dB (uV)]		Emission Level [dB (uV)]		Limit [dB (uV)]		Margin (dB)	
			Q.P.	AV.	Q.P.	AV.	Q.P.	AV.	Q.P.	AV.
			1	0.15782	9.69	36.44	20.65	46.13	30.34	65.58
2	0.20084	9.68	31.48	14.90	41.16	24.58	63.58	53.58	-22.42	-29.00
3	0.42445	9.68	20.14	14.01	29.82	23.69	57.36	47.36	-27.54	-23.67
4	5.18999	9.77	18.32	10.93	28.09	20.70	60.00	50.00	-31.91	-29.30
5	8.20435	9.83	22.98	15.46	32.81	25.29	60.00	50.00	-27.19	-24.71
6	13.93325	9.90	17.71	10.74	27.61	20.64	60.00	50.00	-32.39	-29.36

Remarks:

1. Q.P. and AV. are abbreviations of quasi-peak and average individually.
2. The emission levels of other frequencies were very low against the limit.
3. Margin value = Emission level - Limit value
4. Correction factor = Insertion loss + Cable loss
5. Emission Level = Correction Factor + Reading Value.

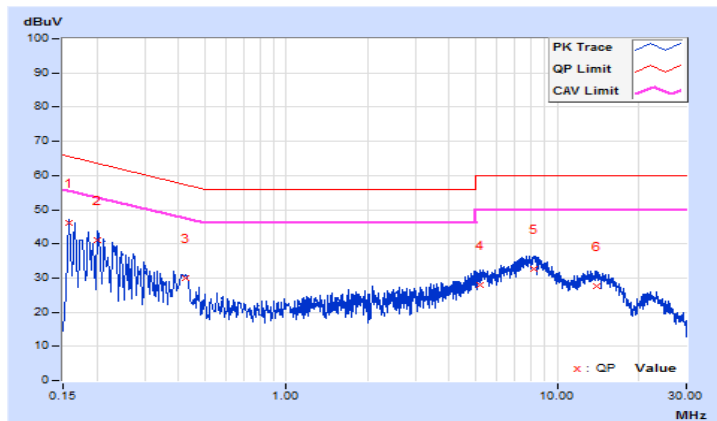

Phase	Neutral (N)	Detector Function	Quasi-Peak (QP) / Average (AV)
Test Mode	B		

No	Freq. [MHz]	Corr. Factor (dB)	Reading Value [dB (uV)]		Emission Level [dB (uV)]		Limit [dB (uV)]		Margin (dB)	
			Q.P.	AV.	Q.P.	AV.	Q.P.	AV.	Q.P.	AV.
			1	0.15802	9.66	36.35	20.39	46.01	30.05	65.57
2	0.23094	9.66	28.14	13.94	37.80	23.60	62.42	52.42	-24.62	-28.82
3	0.43122	9.65	18.09	9.29	27.74	18.94	57.23	47.23	-29.49	-28.29
4	5.58881	9.75	15.65	7.66	25.40	17.41	60.00	50.00	-34.60	-32.59
5	7.74322	9.80	20.30	13.26	30.10	23.06	60.00	50.00	-29.90	-26.94
6	13.63559	9.91	15.63	8.87	25.54	18.78	60.00	50.00	-34.46	-31.22

Remarks:

1. Q.P. and AV. are abbreviations of quasi-peak and average individually.
2. The emission levels of other frequencies were very low against the limit.
3. Margin value = Emission level - Limit value
4. Correction factor = Insertion loss + Cable loss
5. Emission Level = Correction Factor + Reading Value.

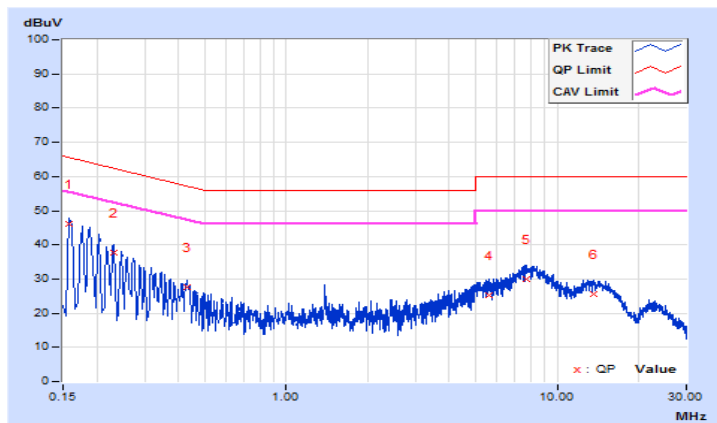

### 4.3 Transmit Power Measurement

#### 4.3.1 Limits of Transmit Power Measurement

Operation Band	EUT Category		Limit
U-NII-1		Outdoor Access Point	1 Watt (30 dBm) (Max. e.i.r.p $\leq$ 125mW(21 dBm) at any elevation angle above 30 degrees as measured from the horizon)
		Fixed point-to-point Access Point	1 Watt (30 dBm)
		Indoor Access Point	1 Watt (30 dBm)
	√	Mobile and Portable client device	250mW (24 dBm)
U-NII-2A			250mW (24 dBm) or 11 dBm+10 log B*
U-NII-2C			250mW (24 dBm) or 11 dBm+10 log B*
U-NII-3	√		1 Watt (30 dBm)

\*B is the 26 dB emission bandwidth in megahertz

#### 4.3.2 Test Setup

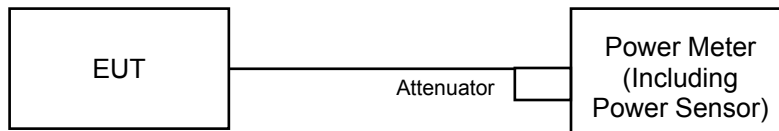

#### 4.3.3 Test Instruments

Refer to section 4.1.2 to get information of above instrument.

#### 4.3.4 Test Procedure

Method PM is used to perform output power measurement, trigger and gating function of wide band power meter is enabled to measure max output power of TX on burst and set the detector to average. Duty factor is not added to measured value.

#### 4.3.5 Deviation from Test Standard

No deviation.

#### 4.3.6 EUT Operating Conditions

The software provided by client to enable the EUT under transmission condition continuously at lowest, middle and highest channel frequencies individually.

#### 4.3.7 Test Result

##### 802.11a

Chan.	Freq. (MHz)	Maximum Conducted Power (mW)	Maximum Conducted Power (dBm)	Power Limit (dBm)	Pass / Fail
36	5180	36.475	15.62	24.00	Pass
40	5200	102.802	20.12	24.00	Pass
48	5240	64.121	18.07	24.00	Pass
149	5745	145.546	21.63	30.00	Pass
157	5785	144.544	21.60	30.00	Pass
165	5825	143.549	21.57	30.00	Pass

##### 802.11n (HT20)

Chan.	Freq. (MHz)	Maximum Conducted Power (mW)	Maximum Conducted Power (dBm)	Power Limit (dBm)	Pass / Fail
36	5180	41.020	16.13	24.00	Pass
40	5200	<b>103.039</b>	20.13	24.00	Pass
48	5240	64.714	18.11	24.00	Pass
149	5745	145.881	21.64	30.00	Pass
157	5785	143.880	21.58	30.00	Pass
165	5825	144.544	21.60	30.00	Pass

##### 802.11n (HT40)

Chan.	Freq. (MHz)	Maximum Conducted Power (mW)	Maximum Conducted Power (dBm)	Power Limit (dBm)	Pass / Fail
38	5190	24.660	13.92	24.00	Pass
46	5230	95.280	19.79	24.00	Pass
151	5755	116.145	20.65	30.00	Pass
159	5795	<b>148.936</b>	21.73	30.00	Pass

##### 802.11ac (VHT80)

Chan.	Freq. (MHz)	Maximum Conducted Power (mW)	Maximum Conducted Power (dBm)	Power Limit (dBm)	Pass / Fail
42	5210	16.634	12.21	24.00	Pass
155	5775	84.333	19.26	30.00	Pass



## 4.4 Occupied Bandwidth Measurement

### 4.4.1 Test Setup

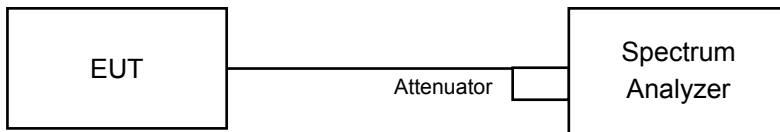

### 4.4.2 Test Instruments

Refer to section 4.1.2 to get information of above instrument.

### 4.4.3 Test Procedure

The transmitter output was connected to the spectrum analyzer through an attenuator. The bandwidth of the fundamental frequency was measured by spectrum analyzer with resolution bandwidth in the range of 1% to 5% of the anticipated emission bandwidth, and a video bandwidth at least 3x the resolution bandwidth and set the detector to sampling. The width of a frequency band such that, below the lower and above the upper frequency limits, the mean powers emitted are each equal to a specified percentage 0.5 %of the total mean power of a given emission.

#### 4.4.4 Test Result

##### 802.11a

Chan.	Freq. (MHz)	Occupied Bandwidth (MHz)
36	5180	17.16
40	5200	24.72
48	5240	19.08
149	5745	30.00
157	5785	29.28
165	5825	28.68

##### 802.11n (HT20)

Chan.	Freq. (MHz)	Occupied Bandwidth (MHz)
36	5180	18.00
40	5200	23.76
48	5240	18.84
149	5745	32.64
157	5785	31.32
165	5825	32.04

##### 802.11n (HT40)

Chan.	Freq. (MHz)	Occupied Bandwidth (MHz)
38	5190	36.60
46	5230	38.40
151	5755	47.76
159	5795	48.00

##### 802.11ac (VHT80)

Chan.	Freq. (MHz)	Occupied Bandwidth (MHz)
42	5210	75.60
155	5775	76.32

### Spectrum Plot of Worst Value

#### 802.11a

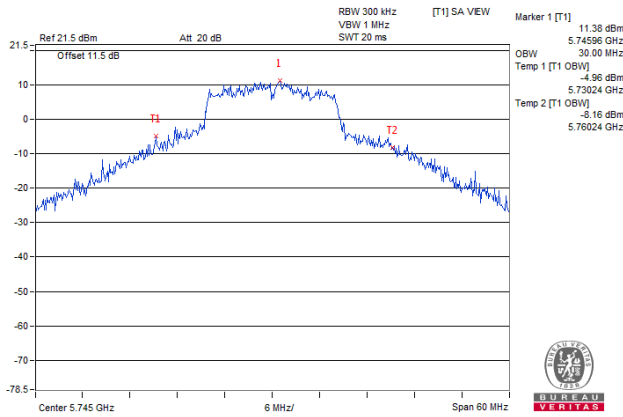

#### 802.11n (HT20)

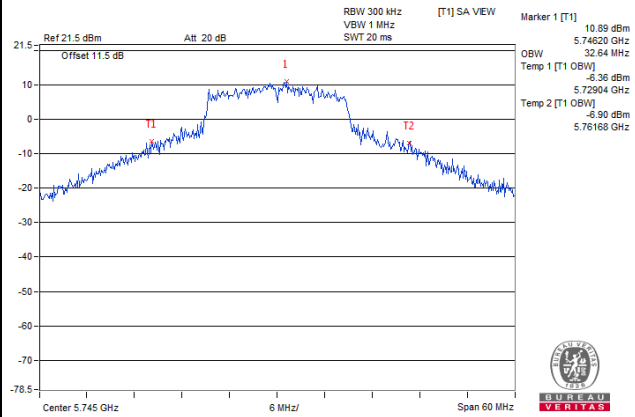

#### 802.11n (HT40)

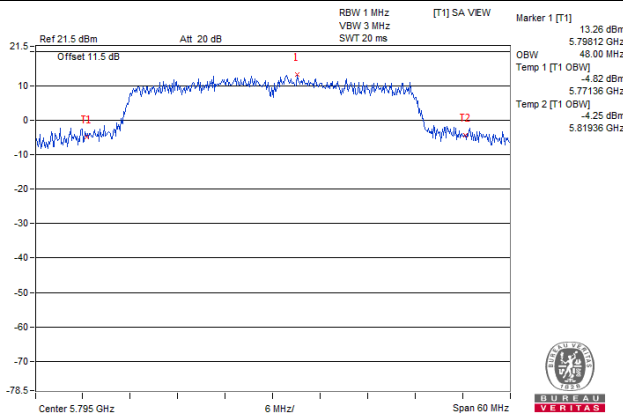

#### 802.11ac (VHT80)

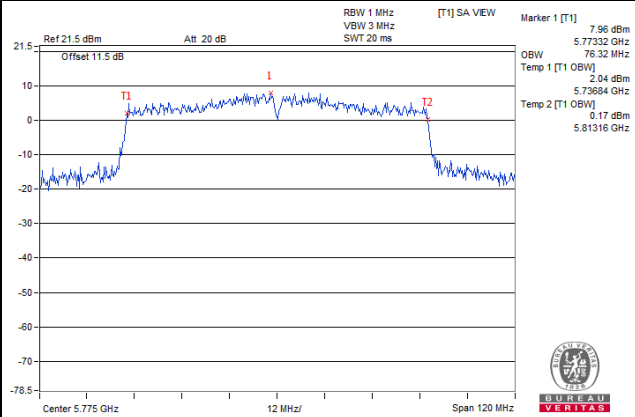

## 4.5 Peak Power Spectral Density Measurement

### 4.5.1 Limits of Peak Power Spectral Density Measurement

Operation Band	EUT Category		Limit
U-NII-1		Outdoor Access Point	17dBm/ MHz
		Fixed point-to-point Access Point	
		Indoor Access Point	
	√	Mobile and Portable client device	11dBm/ MHz
U-NII-2A			11dBm/ MHz
U-NII-2C			11dBm/ MHz
U-NII-3	√		30dBm/ 500kHz

### 4.5.2 Test Setup

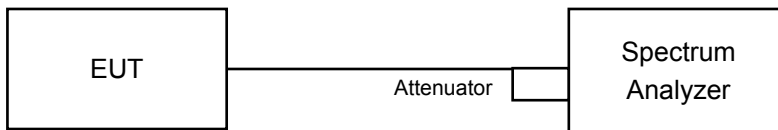

### 4.5.3 Test Instruments

Refer to section 4.1.2 to get information of above instrument.

### 4.5.4 Test Procedures

For U-NII-1 band:

Using method SA-2

- Set span to encompass the entire emission bandwidth (EBW) of the signal.
- Set RBW = 1MHz, Set VBW  $\geq$  3 MHz, Detector = RMS
- Set Channel power measure = 1MHz
- Sweep time = auto, trigger set to "free run".
- Trace average at least 100 traces in power averaging mode.
- Record the max value and add  $10 \log (1/\text{duty cycle})$

For U-NII-3 band:

- Set span to encompass the entire emission bandwidth (EBW) of the signal.
- Set RBW = 300 kHz, Set VBW  $\geq$  1 MHz, Detector = RMS
- Use the peak marker function to determine the maximum power level in any 300 kHz band segment within the fundamental EBW.
- Scale the observed power level to an equivalent value in 500 kHz by adjusting (reducing) the measured power by a bandwidth correction factor (BWCF) where  $\text{BWCF} = 10\log(500 \text{ kHz} / 300 \text{ kHz})$
- Sweep time = auto, trigger set to "free run".
- Trace average at least 100 traces in power averaging mode.
- Record the max value and add  $10 \log (1/\text{duty cycle})$

#### **4.5.5 Deviation from Test Standard**

No deviation.

#### **4.5.6 EUT Operating Conditions**

Same as 4.3.6.

#### 4.5.7 Test Results

For U-NII-1 band:

##### 802.11a

Chan.	Freq. (MHz)	PSD w/o Duty Factor (dBm/MHz)	Duty Factor (dB)	PSD with Duty Factor (dBm/MHz)	Max. Limit (dBm/MHz)	Pass / Fail
36	5180	1.75	0.11	1.86	11.00	Pass
40	5200	6.07	0.11	6.18	11.00	Pass
48	5240	4.56	0.11	4.67	11.00	Pass

Note: Refer to section 3.3 for duty cycle spectrum plot.

##### 802.11n (HT20)

Chan.	Freq. (MHz)	PSD w/o Duty Factor (dBm/MHz)	Duty Factor (dB)	PSD with Duty Factor (dBm/MHz)	Max. Limit (dBm/MHz)	Pass / Fail
36	5180	1.61	0.18	1.79	11.00	Pass
40	5200	5.60	0.18	5.78	11.00	Pass
48	5240	4.14	0.18	4.32	11.00	Pass

Note: Refer to section 3.3 for duty cycle spectrum plot.

##### 802.11n (HT40)

Chan.	Freq. (MHz)	PSD w/o Duty Factor (dBm/MHz)	Duty Factor (dB)	PSD with Duty Factor (dBm/MHz)	Max. Limit (dBm/MHz)	Pass / Fail
38	5190	-3.67	0.52	-3.15	11.00	Pass
46	5230	2.30	0.52	2.82	11.00	Pass

Note: Refer to section 3.3 for duty cycle spectrum plot.

##### 802.11ac (VHT80)

Chan.	Freq. (MHz)	PSD w/o Duty Factor (dBm/MHz)	Duty Factor (dB)	PSD with Duty Factor (dBm/MHz)	Max. Limit (dBm/MHz)	Pass / Fail
42	5210	-8.80	0.95	-7.85	11.00	Pass

Note: Refer to section 3.3 for duty cycle spectrum plot.

### Spectrum Plot of Worst Value

#### 802.11a

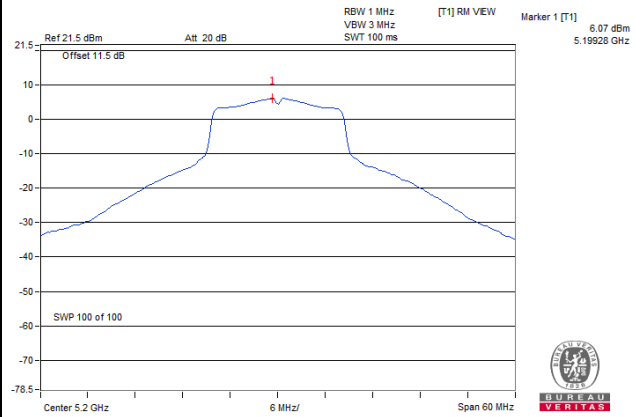

#### 802.11n (HT20)

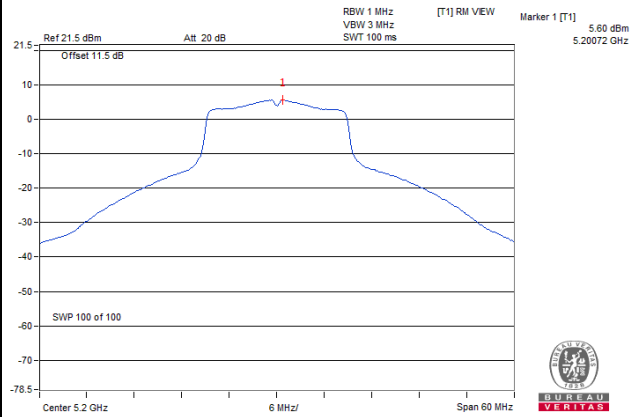

#### 802.11n (HT40)

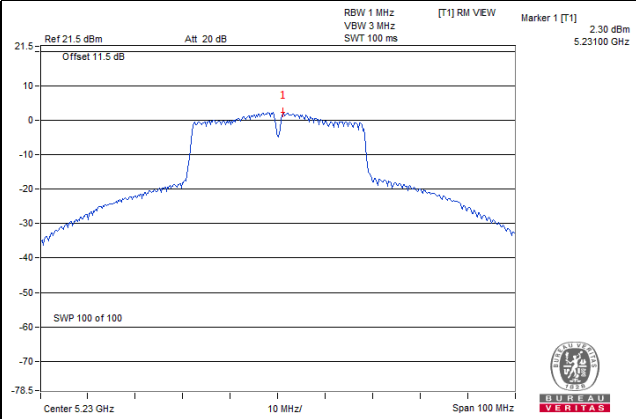

#### 802.11ac (VHT80)

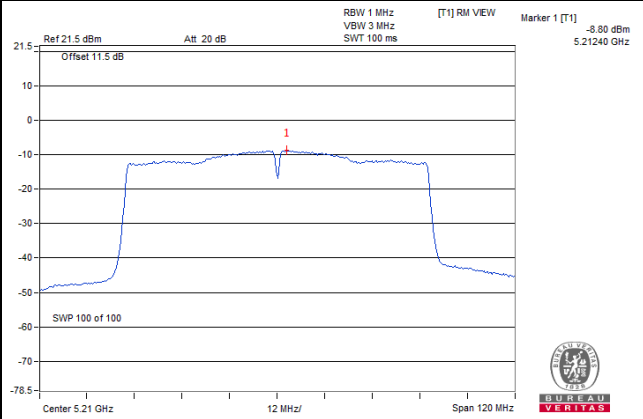

For U-NII-3 band:

802.11a

Chan.	Freq. (MHz)	PSD w/o Duty Factor		Duty Factor (dB)	Total PSD with Duty Factor (dBm/500kHz)	Limit (dBm/500kHz)	Pass / Fail
		(dBm/300kHz)	(dBm/500kHz)				
149	5745	0.18	2.40	0.11	2.51	30.00	Pass
157	5785	0.03	2.25	0.11	2.36	30.00	Pass
165	5825	0.06	2.28	0.11	2.39	30.00	Pass

Note: Refer to section 3.3 for duty cycle spectrum plot.

802.11n (HT20)

Chan.	Freq. (MHz)	PSD w/o Duty Factor		Duty Factor (dB)	Total PSD with Duty Factor (dBm/500kHz)	Limit (dBm/500kHz)	Pass / Fail
		(dBm/300kHz)	(dBm/500kHz)				
149	5745	-0.42	1.80	0.18	1.98	30.00	Pass
157	5785	-0.60	1.62	0.18	1.80	30.00	Pass
165	5825	-0.60	1.62	0.18	1.80	30.00	Pass

Note: Refer to section 3.3 for duty cycle spectrum plot.

802.11n (HT40)

Chan.	Freq. (MHz)	PSD w/o Duty Factor		Duty Factor (dB)	Total PSD with Duty Factor (dBm/500kHz)	Limit (dBm/500kHz)	Pass / Fail
		(dBm/300kHz)	(dBm/500kHz)				
151	5755	-4.42	-2.20	0.52	-1.68	30.00	Pass
159	5795	-4.65	-2.43	0.52	-1.91	30.00	Pass

Note: Refer to section 3.3 for duty cycle spectrum plot.

802.11ac (VHT80)

Chan.	Freq. (MHz)	PSD w/o Duty Factor		Duty Factor (dB)	Total PSD with Duty Factor (dBm/500kHz)	Limit (dBm/500kHz)	Pass / Fail
		(dBm/300kHz)	(dBm/500kHz)				
155	5775	-10.01	-7.79	0.95	-6.84	30.00	Pass

Note: Refer to section 3.3 for duty cycle spectrum plot.



### Spectrum Plot of Worst Value

#### 802.11a

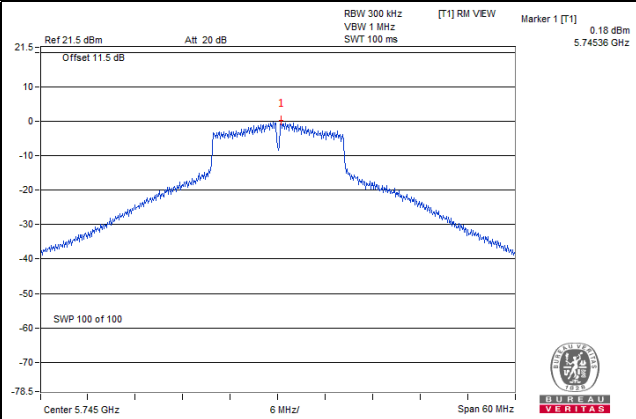

#### 802.11n (HT20)

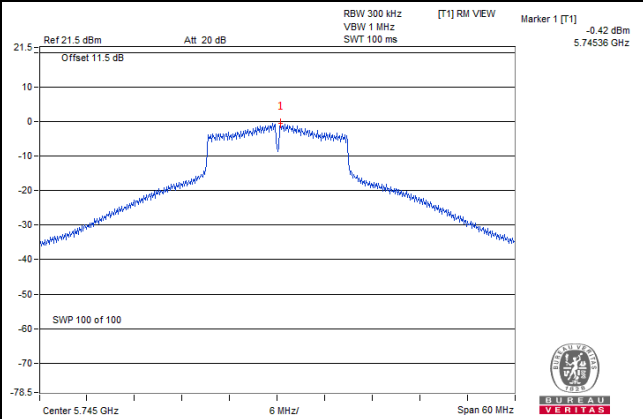

#### 802.11n (HT40)

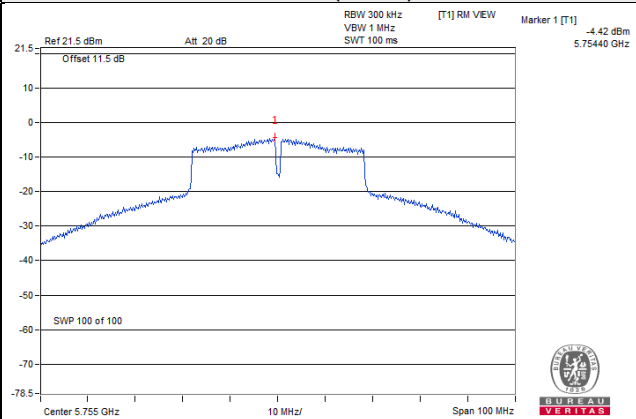

#### 802.11ac (VHT80)

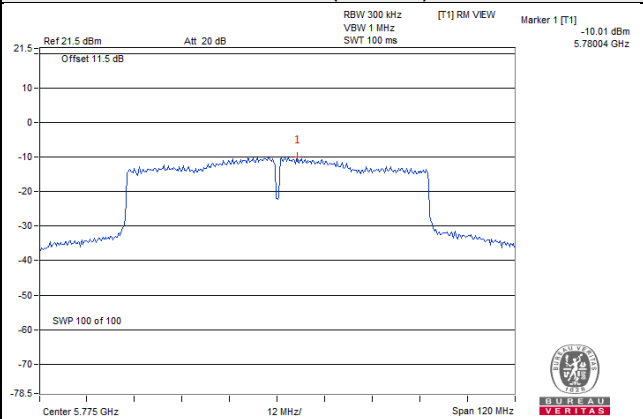

## 4.6 Frequency Stability

### 4.6.1 Limits of Frequency Stability Measurement

The frequency of the carrier signal shall be maintained within band of operation

### 4.6.2 Test Setup

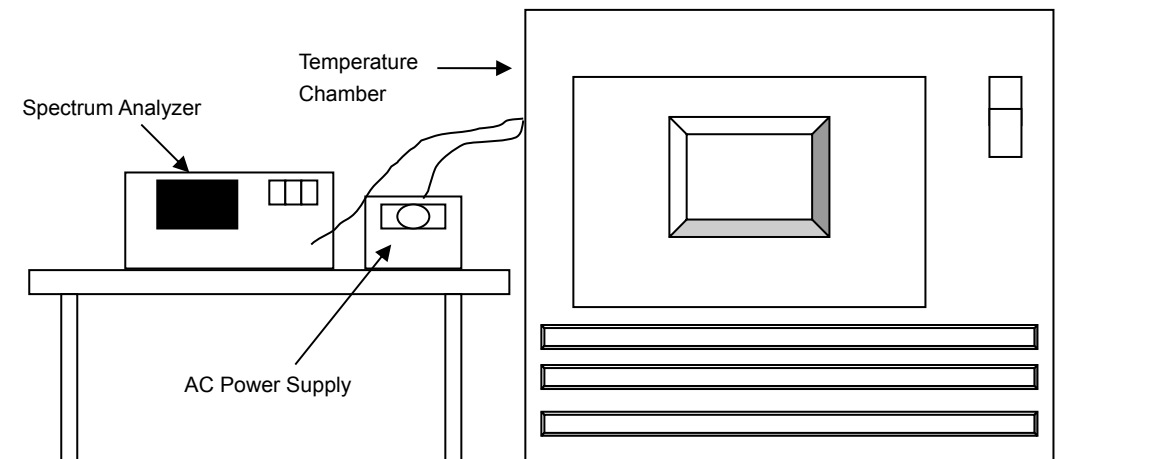

### 4.6.3 Test Instruments

Description & Manufacturer	Model No.	Serial No.	Cal. Date	Cal. Due
Spectrum Analyzer ROHDE & SCHWARZ	FSP40	100039	Jun. 11, 2018	Jun. 10, 2019
WIT Standard Temperature And Humidity Chamber	TH-4S-C	W981030	Jun. 04, 2018	Jun. 03, 2019
Digital Multimeter Fluke	87-III	70360742	Jun. 29, 2018	Jun. 28, 2019
AC Power Supply Extech	CFW-105	E000603	NA	NA

Note: 1. The calibration interval of the above test instruments is 12 months and the calibrations are traceable to NML/ROC and NIST/USA.

### 4.6.4 Test Procedure

- The EUT was placed inside the environmental test chamber and powered by nominal AC voltage.
- Turn the EUT on and couple its output to a spectrum analyzer.
- Turn the EUT off and set the chamber to the highest temperature specified.
- Allow sufficient time (approximately 30 min) for the temperature of the chamber to stabilize, turn the EUT on and measure the operating frequency after 2, 5, and 10 minutes.
- Repeat step c and d with every 10 degrees reduction until the lowest temperature achieved.
- The test chamber was allowed to stabilize at +20 degree C for a minimum of 30 minutes. The supply voltage was then adjusted on the EUT from 85% to 115% and the frequency record.

#### 4.6.5 Deviation from Test Standard

No deviation.

#### 4.6.6 EUT Operating Condition

Set the EUT transmit at un-modulation mode to test frequency stability.

#### 4.6.7 Test Results

Frequency Stability Versus Temp.									
Operating Frequency: 5180MHz									
Temp. (°C)	Power Supply (Vac)	0 Minute		2 Minute		5 Minute		10 Minute	
		Measured Frequency (MHz)	Result	Measured Frequency (MHz)	Result	Measured Frequency (MHz)	Result	Measured Frequency (MHz)	Result
50	120	5179.9846	Pass	5179.9813	Pass	5179.9827	Pass	5179.9819	Pass
40	120	5180.0081	Pass	5180.0106	Pass	5180.0073	Pass	5180.0098	Pass
30	120	5180.0199	Pass	5180.0203	Pass	5180.0178	Pass	5180.0196	Pass
20	120	5179.9862	Pass	5179.9869	Pass	5179.9898	Pass	5179.9894	Pass
10	120	5180.0144	Pass	5180.0129	Pass	5180.0116	Pass	5180.0156	Pass
0	120	5180.0055	Pass	5180.0018	Pass	5180.0036	Pass	5180.0052	Pass
-10	120	5179.9788	Pass	5179.9799	Pass	5179.9776	Pass	5179.9772	Pass
-20	120	5179.9884	Pass	5179.9868	Pass	5179.9896	Pass	5179.9894	Pass
-30	120	5179.9766	Pass	5179.9719	Pass	5179.9749	Pass	5179.9769	Pass

Frequency Stability Versus Voltage									
Operating Frequency: 5180MHz									
Temp. (°C)	Power Supply (Vac)	0 Minute		2 Minute		5 Minute		10 Minute	
		Measured Frequency (MHz)	Result	Measured Frequency (MHz)	Result	Measured Frequency (MHz)	Result	Measured Frequency (MHz)	Result
20	138	5179.9862	Pass	5179.9876	Pass	5179.9898	Pass	5179.9897	Pass
	120	5179.9862	Pass	5179.9869	Pass	5179.9898	Pass	5179.9894	Pass
	102	5179.9872	Pass	5179.9866	Pass	5179.9889	Pass	5179.9898	Pass

## 4.7 6dB Bandwidth Measurement

### 4.7.1 Limits of 6dB Bandwidth Measurement

The minimum of 6dB Bandwidth Measurement is 0.5MHz.

### 4.7.2 Test Setup

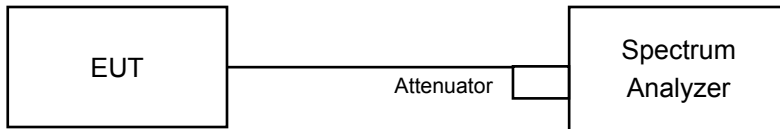

### 4.7.3 Test Instruments

Refer to section 4.1.2 to get information of above instrument.

### 4.7.4 Test Procedure

- Set resolution bandwidth (RBW) = 100kHz
- Set the video bandwidth (VBW)  $\geq 3 \times$  RBW, Detector = Peak.
- Trace mode = max hold.
- Sweep = auto couple.
- Measure the maximum width of the emission that is constrained by the frequencies associated with the two amplitude points (upper and lower) that are attenuated by 6 dB relative to the maximum level measured in the fundamental emission

### 4.7.5 Deviation from Test Standard

No deviation.

### 4.7.6 EUT Operating Condition

The software provided by client to enable the EUT under transmission condition continuously at lowest, middle and highest channel frequencies individually.

#### 4.7.7 Test Results

##### 802.11a

Channel	Frequency (MHz)	6dB Bandwidth (MHz)	Minimum Limit (MHz)	Pass / Fail
149	5745	15.86	0.5	Pass
157	5785	16.04	0.5	Pass
165	5825	16.11	0.5	Pass

##### 802.11n (HT20)

Channel	Frequency (MHz)	6dB Bandwidth (MHz)	Minimum Limit (MHz)	Pass / Fail
149	5745	17.62	0.5	Pass
157	5785	17.61	0.5	Pass
165	5825	17.37	0.5	Pass

##### 802.11n (HT40)

Channel	Frequency (MHz)	6dB Bandwidth (MHz)	Minimum Limit (MHz)	Pass / Fail
151	5755	36.32	0.5	Pass
159	5795	36.07	0.5	Pass

##### 802.11ac (VHT80)

Channel	Frequency (MHz)	6dB Bandwidth (MHz)	Minimum Limit (MHz)	Pass / Fail
155	5775	75.65	0.5	Pass

### Spectrum Plot of Worst Value

#### 802.11a

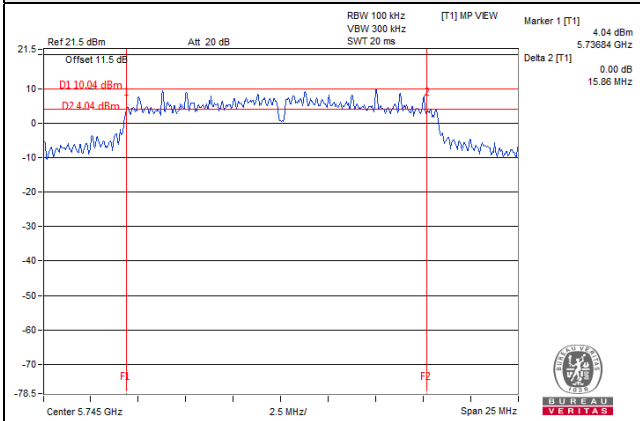

#### 802.11n (HT20)

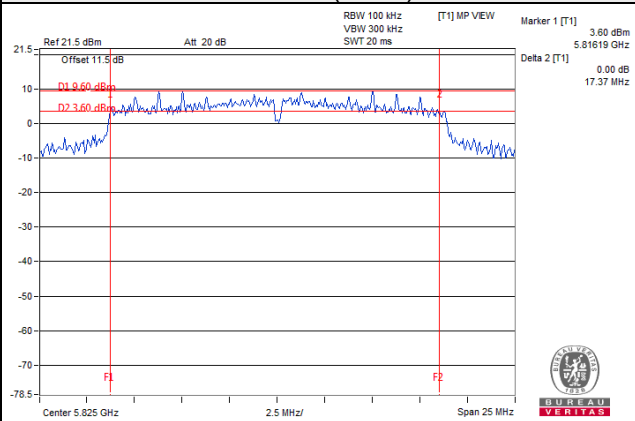

#### 802.11n (HT40)

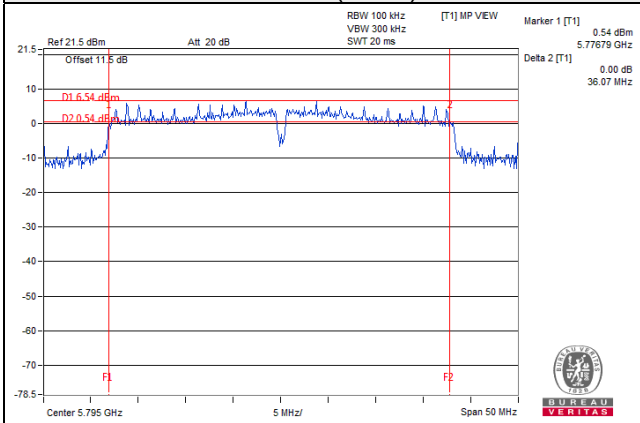

#### 802.11ac (VHT80)

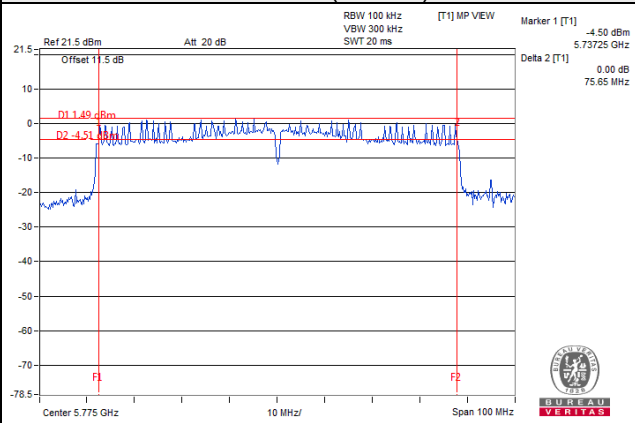

## 5 Pictures of Test Arrangements

Please refer to the attached file (Test Setup Photo).

## Annex A- Radiated Out of Band Emission (OOBE) Measurement (For U-NII-3 band)

802.11a

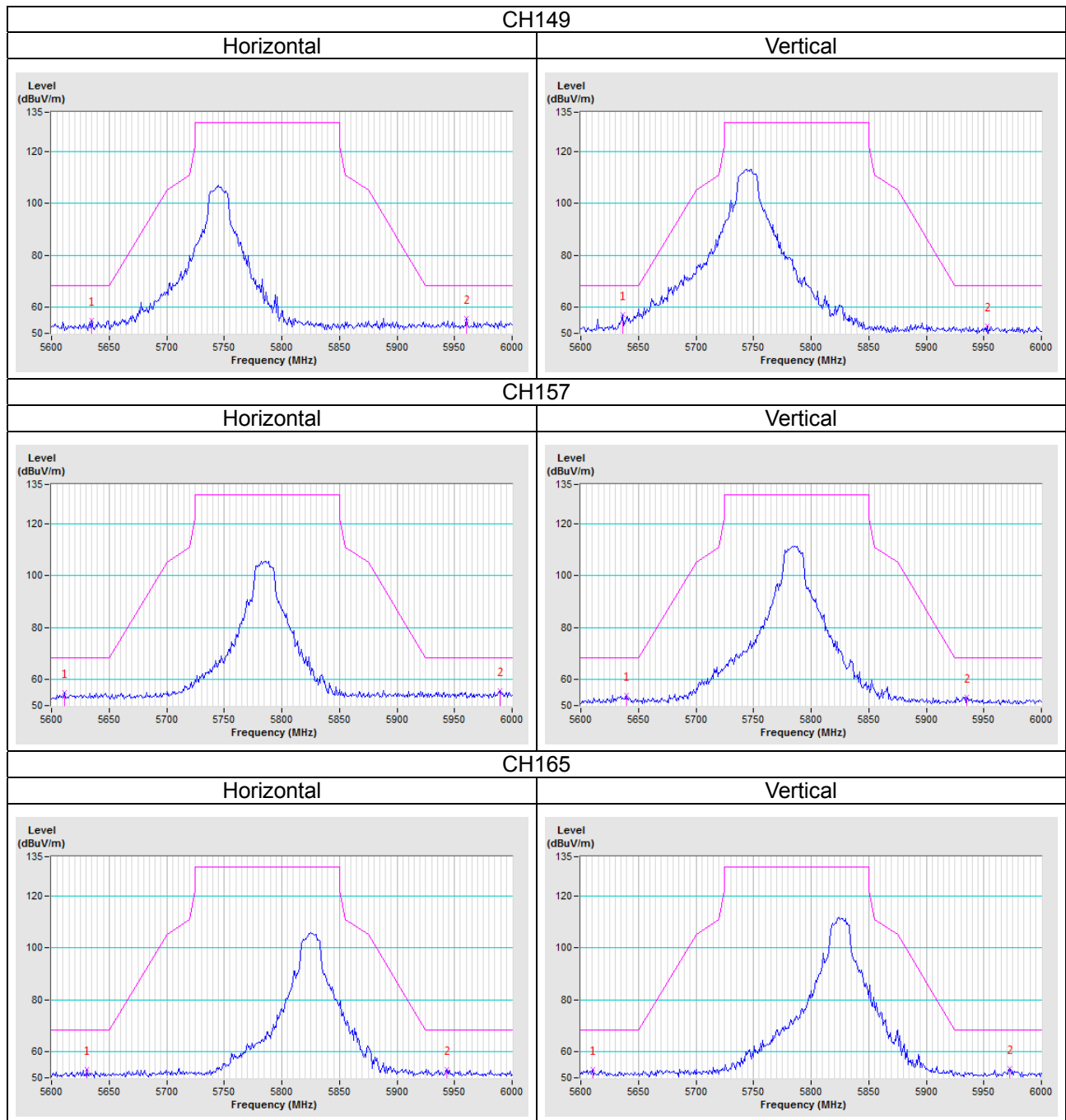



802.11n (HT20)

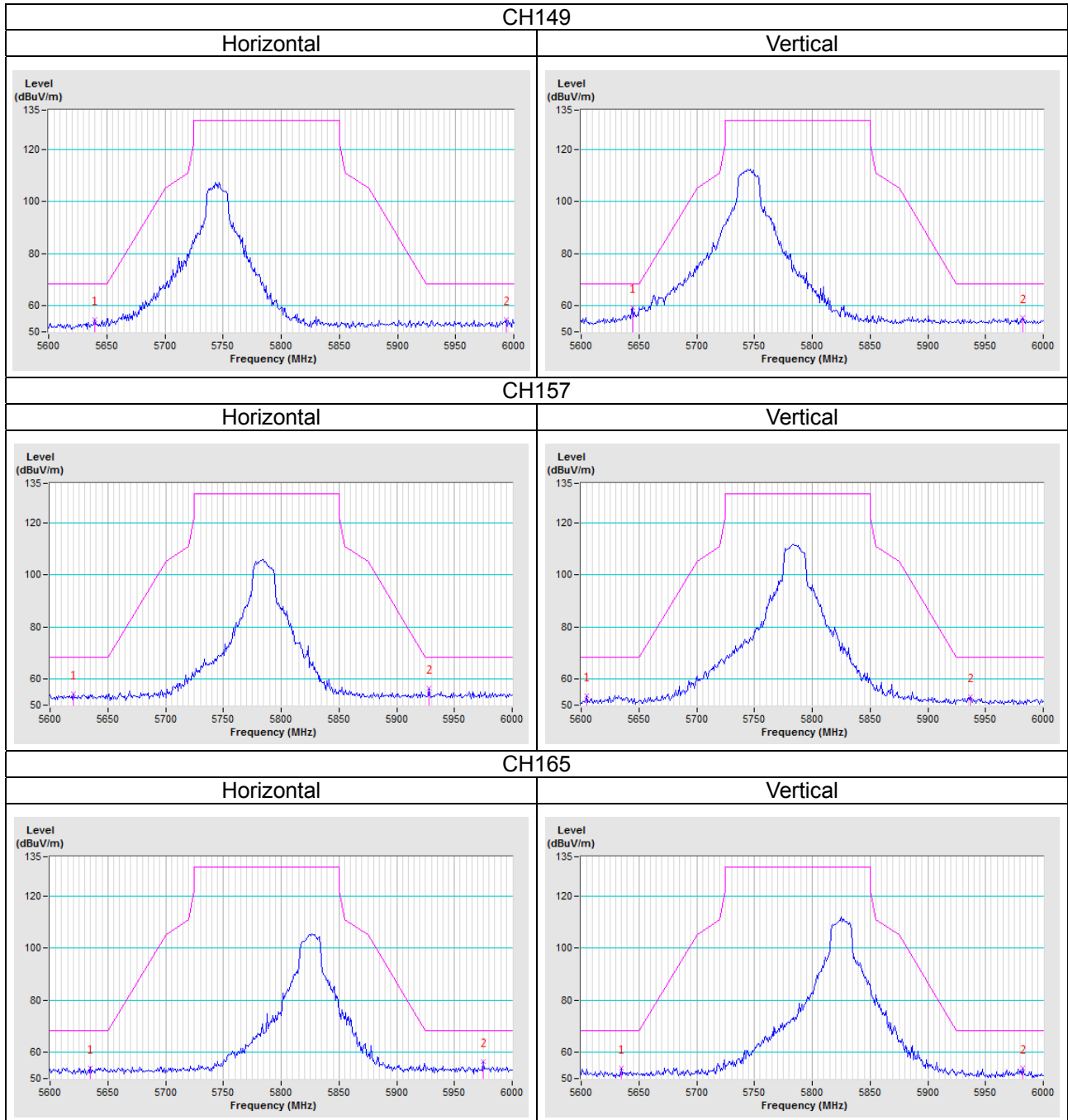

802.11n (HT40)

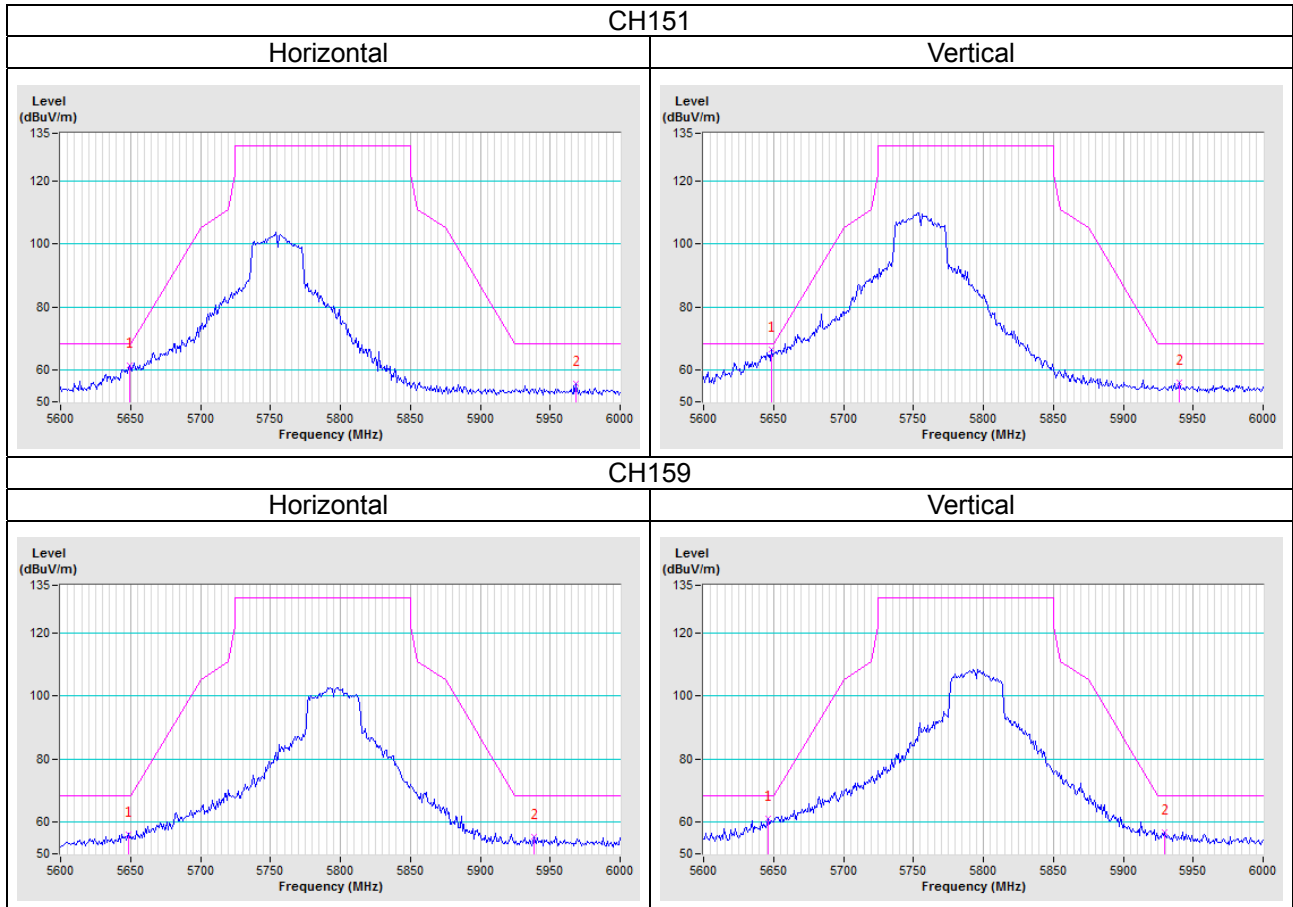

802.11ac (VHT80)

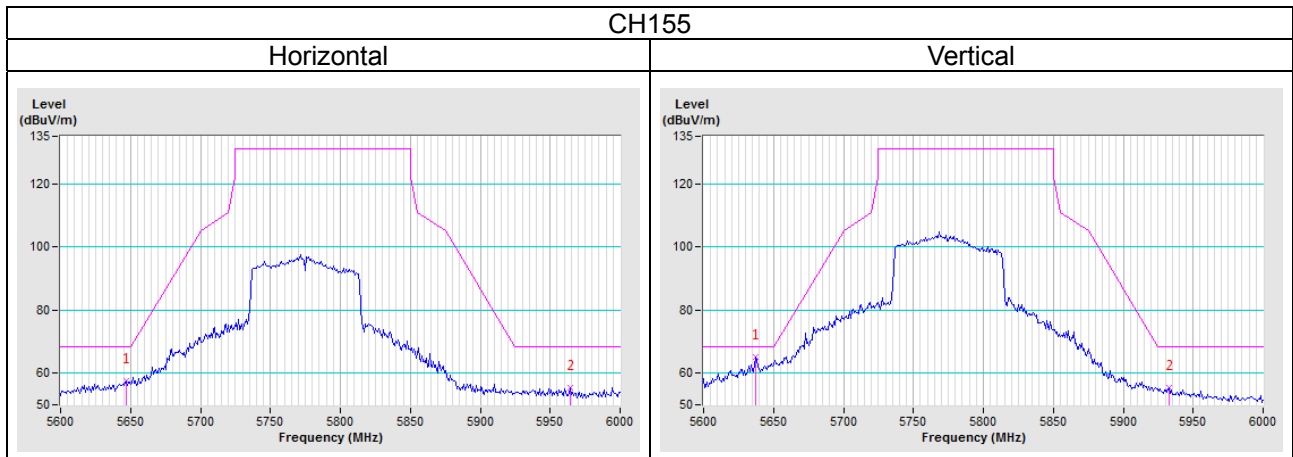

## Appendix – Information of the Testing Laboratories

We, Bureau Veritas Consumer Products Services (H.K.) Ltd., Taoyuan Branch, were founded in 1988 to provide our best service in EMC, Radio, Telecom and Safety consultation. Our laboratories are FCC recognized accredited test firms and accredited and approved according to ISO/IEC 17025.

If you have any comments, please feel free to contact us at the following:

### Lin Kou EMC/RF Lab

Tel: 886-2-26052180

Fax: 886-2-26051924

### Hsin Chu EMC/RF/Telecom Lab

Tel: 886-3-6668565

Fax: 886-3-6668323

### Hwa Ya EMC/RF/Safety

Tel: 886-3-3183232

Fax: 886-3-3270892

**Email:** [service.adt@tw.bureauveritas.com](mailto:service.adt@tw.bureauveritas.com)

**Web Site:** [www.bureauveritas-adt.com](http://www.bureauveritas-adt.com)

The address and road map of all our labs can be found in our web site also.

--- END ---