

# FCC RADIO TEST REPORT

according to

47 CFR FCC Part 15 Subpart C § 15.247

**Equipment** : Entry Level 802.11n Wireless Internet Camera  
**Model No.** : IC-3015WN / GC-D315N  
**Brand Name** : EDIMAX  
**Filing Type** : New Application  
**Applicant** : EDIMAX TECHNOLOGY CO., LTD.  
**Manufacturer** : No.3, Wu Chuan 3rd Road, Wu-Ku Industrial Park,  
Taipei Hsien, Taiwan  
**FCC ID** : NDD9530151106  
**Received Date** : Jul. 11, 2011  
**Final Test Date** : Aug. 12, 2011  
**Multiple Listing** : Please refer to section 2.5

## Statement

**Test result included is only for the 802.11b/g part of the product.**

The test result in this report refers exclusively to the presented test model / sample.

Without written approval of SPORTON International Inc., the test report shall not be reproduced except in full.

The measurements and test results shown in this test report were made in accordance with the procedures and found in compliance with the limit given in **ANSI C63.4-2003** and **47 CFR FCC Part 15 Subpart C**.

The test equipment used to perform the test is calibrated and traceable to NML/ROC.



***SPORTON International Inc.***

*No. 52 Hwa Ya 1<sup>st</sup> Rd., Hwa Ya Technology Park, Kwei-Shan Hsiang, Tao Yuan Hsien, Taiwan, R.O.C.*

**Table of Contents**

**1 SUMMARY OF THE TEST RESULT ..... 2**

**2 GENERAL INFORMATION..... 3**

2.1 Product Details.....3

2.2 Accessories.....3

2.3 Table for Filed Antenna.....3

2.4 Table for Carrier Frequencies.....3

2.5 Table for Multiple Listing.....3

2.6 Table for Test Modes.....4

2.7 Table for Testing Locations.....4

2.8 Table for Supporting Units.....4

2.9 Table for Parameters of Test Software Setting.....4

2.10 EUT Operation during Test.....5

2.11 Test Configuration.....6

**3 TEST RESULT ..... 7**

3.1 AC Power Line Conducted Emissions Measurement .....7

3.2 Maximum Peak Output Power Measurement .....13

3.3 Power Spectral Density Measurement.....15

3.4 6dB Spectrum Bandwidth Measurement .....21

3.5 Radiated Emissions Measurement .....27

3.6 Band Edge and Fundamental Emissions Measurement.....47

3.7 Antenna Requirements .....52

**4 LIST OF MEASURING EQUIPMENTS..... 53**

**5 TEST LOCATION..... 55**

**6 TAF CERTIFICATE OF ACCREDITATION..... 56**

**APPENDIX A. MAXIMUM PERMISSIBLE EXPOSURE ..... A1 ~ A3**

**APPENDIX B. TEST PHOTOS ..... B1 ~ B8**

**APPENDIX C. PHOTOGRAPHS OF EUT ..... C1 ~ C8**



# CERTIFICATE OF COMPLIANCE

according to

47 CFR FCC Part 15 Subpart C § 15.247

Equipment : Entry Level 802.11n Wireless Internet Camera  
Model No. : IC-3015WN / GC-D315N  
Brand Name : EDIMAX  
Applicant : EDIMAX TECHNOLOGY CO., LTD.  
No.3, Wu Chuan 3rd Road, Wu-Ku Industrial Park,  
Taipei Hsien, Taiwan

Sporton International as requested by the applicant to evaluate the EMC performance of the product sample received on Jul. 11, 2011 would like to declare that the tested sample has been evaluated and found to be in compliance with the tested rule parts. The data recorded as well as the test configuration specified is true and accurate for showing the sample's EMC nature.



Wayne Hsu / Vice Manager

## **SPORTON International Inc.**

No. 52 Hwa Ya 1st Rd., Hwa Ya Technology Park, Kwei-Shan Hsiang, Tao Yuan Hsien, Taiwan, R.O.C.

**1 SUMMARY OF THE TEST RESULT**

<b>Applied Standard: 47 CFR FCC Part 15 Subpart C</b>				
<b>Part</b>	<b>Rule Section</b>	<b>Description of Test</b>	<b>Result</b>	<b>Under Limit</b>
3.1	15.207	AC Power Line Conducted Emissions	Complies	7.06 dB
3.2	15.247(b)(3)	Maximum Peak Output Power Measurement	Complies	12.64 dB
3.3	15.247(e)	Power Spectral Density	Complies	21.94 dB
3.4	15.247(a)(2)	6dB Spectrum Bandwidth	Complies	-
3.5	15.247(d)	Radiated Emissions	Complies	0.29 dB
3.6	15.247(d)	Band Edge Emissions	Complies	1.28 dB
3.7	15.203	Antenna Requirements	Complies	-

<b>Test Items</b>	<b>Uncertainty</b>	<b>Remark</b>
AC Power Line Conducted Emissions	±2.3dB	Confidence levels of 95%
Maximum Peak Output Power Measurement	±0.8dB	Confidence levels of 95%
Power Spectral Density	±0.5dB	Confidence levels of 95%
6dB Spectrum Bandwidth	±8.5×10 <sup>-8</sup>	Confidence levels of 95%
Radiated Emissions (9kHz~30MHz)	±0.8dB	Confidence levels of 95%
Radiated Emissions (30MHz~1000MHz)	±1.9dB	Confidence levels of 95%
Radiated / Band Edge Emissions (1GHz~18GHz)	±1.9dB	Confidence levels of 95%
Radiated Emissions (18GHz~40GHz)	±1.9dB	Confidence levels of 95%
Temperature	±0.7°C	Confidence levels of 95%
Humidity	±3.2%	Confidence levels of 95%
DC / AC Power Source	±1.4%	Confidence levels of 95%

## 2 GENERAL INFORMATION

### 2.1 Product Details

There are two difference appearance of product. Only the radio detail of IEEE 802.11b/g is shown in the table below. For more detailed features description, please refer to the manufacturer's specifications or user's manual.

Items	Description
Power Type	5V from adapter
Modulation	DSSS for IEEE 802.11b ; OFDM for IEEE 802.11g
Data Modulation	DSSS (DBPSK / DQPSK / CCK) ; OFDM (BPSK / QPSK / 16QAM / 64QAM)
Data Rate (Mbps)	DSSS (1/ 2/ 5.5/11) ; OFDM (6/9/12/18/24/36/48/54)
Frequency Range	2400 ~ 2483.5MHz
Channel Number	11b/g: 11
Channel Band Width (99%)	11b: 14.96 MHz ; 11g: 16.48 MHz
Peak Output Power	11b: 17.36 dBm ; 11g: 15.51 dBm

### 2.2 Accessories

Power	Brand	Model	Rating
Switching Adapter	DVE	DSC-6PFA-05 FUS 050100	INPUT : 100-240V ~ 50/60Hz 0.2A OUTPUT : 5V 1A

### 2.3 Table for Filed Antenna

Ant.	Antenna Type	Connector	Gain (dBi)	Remark
A	Dipole Antenna	Fixed on Board	2.00	TX / RX

### 2.4 Table for Carrier Frequencies

#### Frequency Allocation for 802.11b/g

Frequency Band	Channel No.	Frequency	Channel No.	Frequency
2400~2483.5MHz	1	2412 MHz	7	2442 MHz
	2	2417 MHz	8	2447 MHz
	3	2422 MHz	9	2452 MHz
	4	2427 MHz	10	2457 MHz
	5	2432 MHz	11	2462 MHz
	6	2437 MHz	-	-

### 2.5 Table for Multiple Listing

No.	Brand Name	Model Name
1	EDIMAX	IC-3015Wn / GC-D315N / GCD315N

**2.6 Table for Test Modes**

Preliminary tests were performed in different data rate to find the worst radiated emission. The data rate shown in the table below is the worst-case rate with respect to the specific test item. Investigation has been done on the entire possible configuration for searching the worst cases. The following table is a list of the test modes shown in this test report.

Test Items	Mode	Data Rate	Channel
AC Power Line Conducted Emissions Radiated Emissions Below 1GHz	LAN Mode / Wireless Mode	Auto	-
Maximum Conducted Output Power Power Spectral Density 6dB Spectrum Bandwidth Radiated Emissions Above 1GHz Fundamental Emissions	11b/CCK	1 Mbps	1/6/11
	11g/BPSK	6 Mbps	1/6/11
Band Edge Emissions	11b/CCK	1 Mbps	1/11
	11g/BPSK	6 Mbps	1/11

**2.7 Table for Testing Locations**

Test Site No.	Site Category	Location	FCC Reg. No.	IC File No.
03CH02-HY	SAC	Hwa Ya	643075	IC 4086B-1
CO04-HY	Conduction	Hwa Ya	643075	IC 4086B-1
TH01-HY	OVEN Room	Hwa Ya	-	-

Semi Anechoic Chamber (SAC).

**2.8 Table for Supporting Units**

Support Unit	Brand	Model	FCC ID	Remark
Notebook	DELL	E5500	DoC	Conducted
(USB) Mouse	Microsoft	1004	DoC	
Modem	ACEEX	DM1414	DoC	
Wireless AP (Remote Workstation)	D-Link	DNS-G120	N/A	
Notebook (Remote Workstation)	DELL	E5500	DoC	Radiated

**2.9 Table for Parameters of Test Software Setting**

During testing, Channel & Power Controlling Software provided by the customer was used to control the operating channel as well as the output power level. The RF output power selection is for the setting of RF output power expected by the customer and is going to be fixed on the firmware of the final end product.

**Power Parameters of IEEE 802.11b/g**

Test Software Version	MP N Test*		
	2412 MHz	2437 MHz	2462 MHz
Frequency	40	39	39
IEEE 802.11b	30	29	28
IEEE 802.11g			

## 2.10 EUT Operation during Test

An executive program, "EMCTEST.EXE" under WIN XP, which generates a complete line of continuously repeating "H" pattern was used as the test software.

The program was executed as follows :

- a. Turn on the power of all equipment.
- b. The NB reads the test program from the hard disk drive and runs it.
- c. The NB sends "H" messages to the panel and displays "H" patterns on the screen.
- d. The NB sends messages to the modem.
- e. Repeat the steps from c to d.

-Executed " LANTEST" to link with the remote workstation to receive and transmit data via RJ45 cable.

- Executed "Ping.exe" to link with the remote workstation to receive and transmit data via RJ45 cable.

-Executed " Ping.exe " was executed to link with the remote workstation to receive and transmit data by WiFi.

- Executed " IE6.0" to link with the remote workstation to receive and transmit data via RJ45 cable.

-Executed " IE6.0" was executed to link with the remote workstation to receive and transmit data by WiFi.

Only Radiated used:

- Executed "**MP N Test\***" to keep transmitting signals at fixed frequency.



### 2.11 Test Configuration

#### Radiation Emissions Test Configuration For radiated emissions 9kHz~1GHz

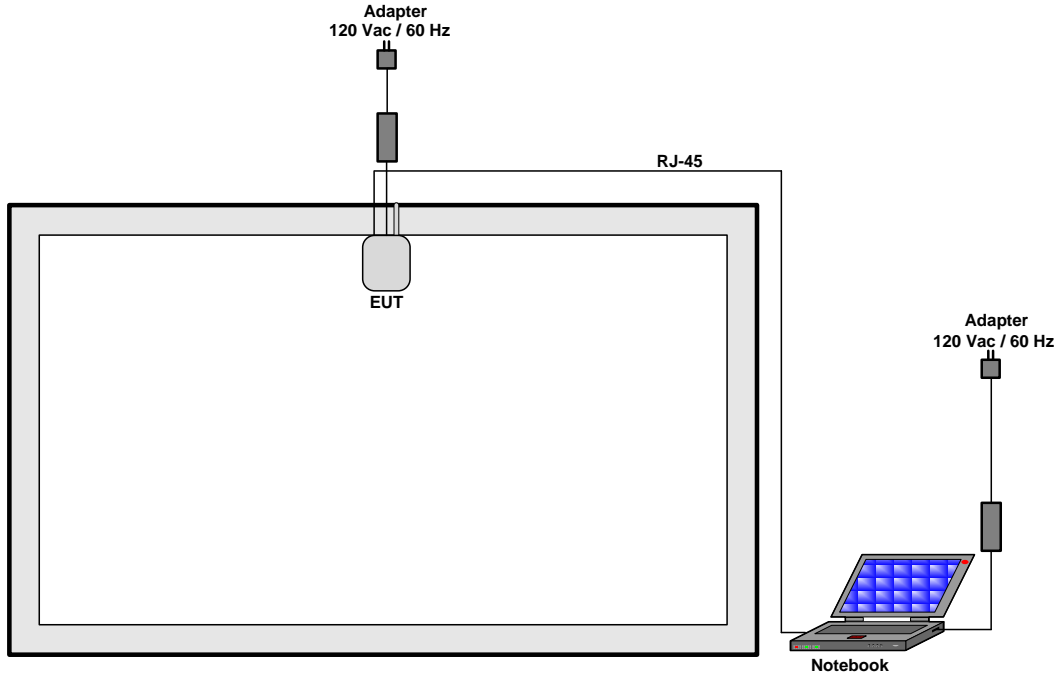

#### For radiated emissions above 1GHz

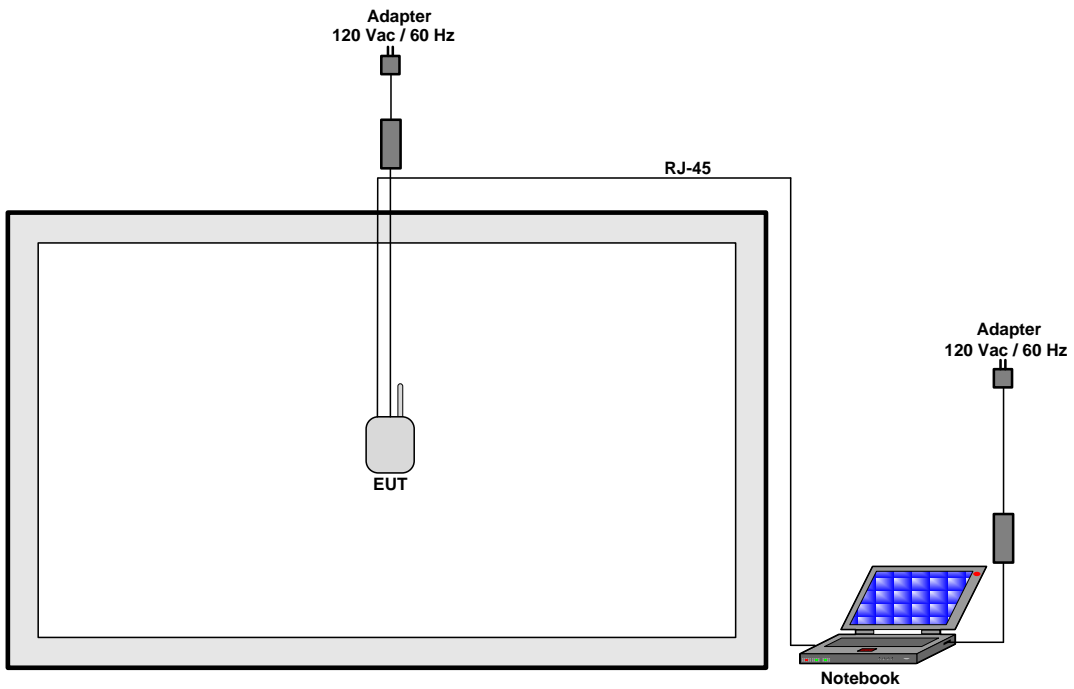

### 3 TEST RESULT

#### 3.1 AC Power Line Conducted Emissions Measurement

##### 3.1.1 Limit

For this product which is designed to be connected to the AC power line, the radio frequency voltage that is conducted back onto the AC power line on any frequency or frequencies within the band 150 kHz to 30 MHz shall not exceed below limits table.

**Class B**

Frequency (MHz)	QP Limit (dBuV)	AV Limit (dBuV)
0.15~0.5	66~56	56~46
0.5~5	56	46
5~30	60	50

##### 3.1.2 Measuring Instruments and Setting

Please refer to section 4 of equipments list in this report. The following table is the setting of the receiver.

Receiver Parameters	Setting
Attenuation	10 dB
Start Frequency	0.15 MHz
Stop Frequency	30 MHz
IF Bandwidth	9 KHz

##### 3.1.3 Test Procedures

1. Configure the EUT according to ANSI C63.4. The EUT or host of EUT has to be placed 0.4 meter far from the conducting wall of the shielding room and at least 80 centimeters from any other grounded conducting surface.
2. Connect EUT or host of EUT to the power mains through a line impedance stabilization network (LISN).
3. All the support units are connected to the other LISNs. The LISN should provide 50uH/50ohms coupling impedance.
4. The frequency range from 150 KHz to 30 MHz was searched.
5. Set the test-receiver system to Peak Detect Function and Specified Bandwidth with Maximum Hold Mode.
6. The measurement has to be done between each power line and ground at the power terminal.

3.1.4 Test Setup Layout

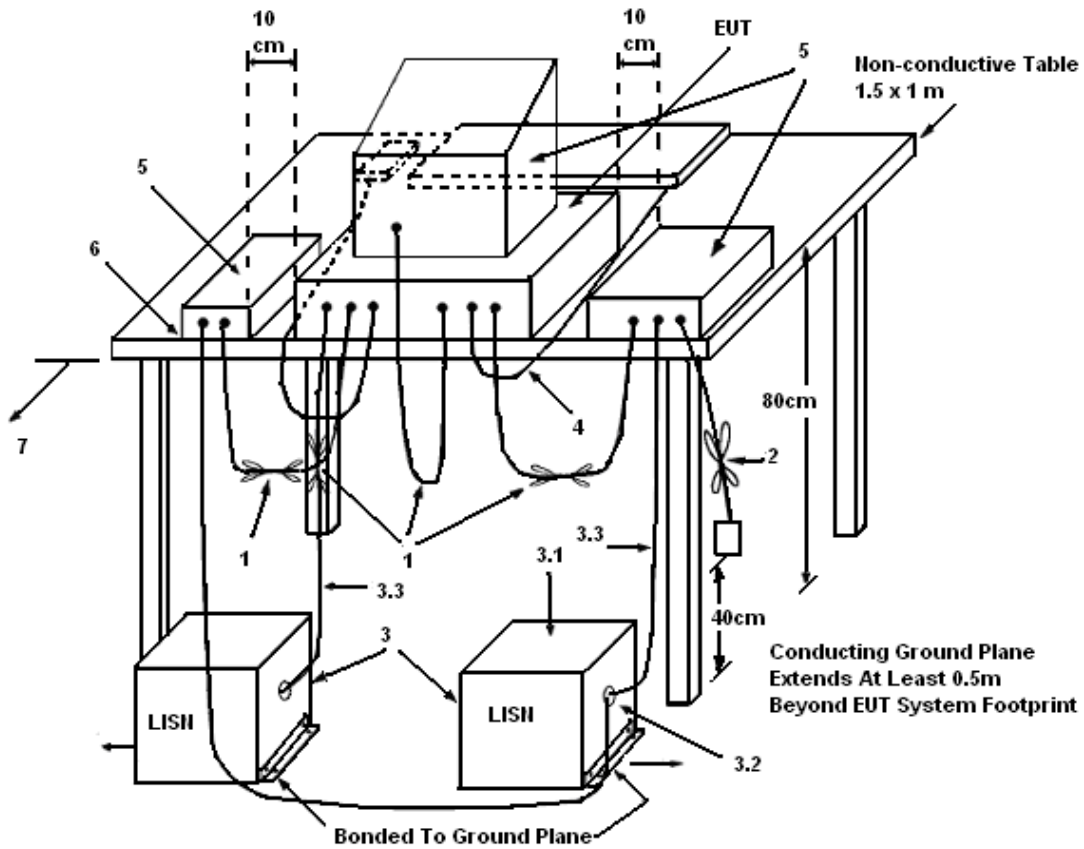

LEGEND:

- (1) Interconnecting cables that hang closer than 40 cm to the ground plane shall be folded back and forth in the center forming a bundle 30 to 40 cm long.
- (2) I/O cables that are not connected to a peripheral shall be bundled in the center. The end of the cable may be terminated, if required, using the correct terminating impedance. The overall length shall not exceed 1 m.
- (3) EUT connected to one LISN. Unused LISN measuring port connectors shall be terminated in 50 Ω. LISN can be placed on top of, or immediately beneath, reference ground plane.
- (3.1) All other equipment powered from additional LISN(s).
- (3.2) Multiple outlet strip can be used for multiple power cords of non-EUT equipment.
- (3.3) LISN at least 80 cm from nearest part of EUT chassis.
- (4) Cables of hand-operated devices, such as keyboards, mice, etc., shall be placed as for normal use.
- (5) Non-EUT components of EUT system being tested.
- (6) Rear of EUT, including peripherals, shall all be aligned and flush with rear of tabletop.
- (7) Rear of tabletop shall be 40 cm removed from a vertical conducting plane that is bonded to the ground plane.

3.1.5 Test Deviation

There is no deviation with the original standard.

3.1.6 Results of AC Power Line Conducted Emissions Measurement

<b>Final Test date</b>	Aug. 12, 2011	<b>Test Site No.</b>	CO04-HY
<b>Temperature</b>	26.6°C	<b>Humidity</b>	57.2%
<b>Test Engineer</b>	Jason	<b>Configuration</b>	LAN Mode

Line

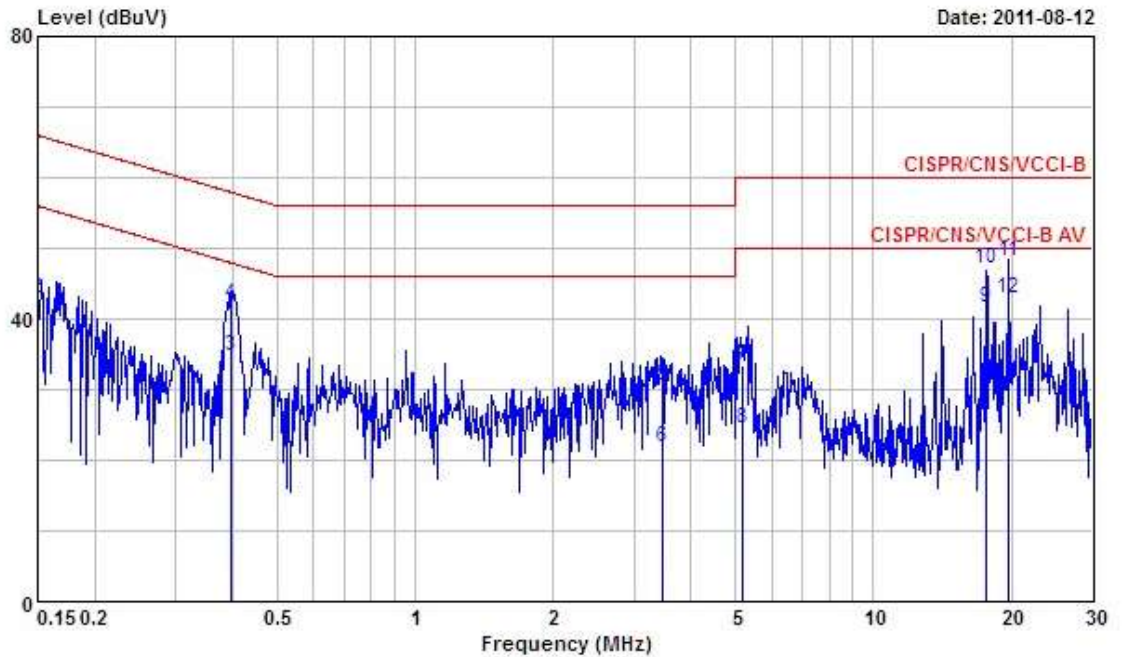

	Freq	Level	Over Limit	Limit Line	Read Level	LISN Factor	Cable Loss	Remark
	MHz	dBuV	dB	dBuV	dBuV	dB	dB	
1	0.1500000	32.73	-23.27	56.00	32.37	0.30	0.06	Average
2	0.1500000	42.84	-23.16	66.00	42.48	0.30	0.06	QP
3	0.3955300	34.71	-13.24	47.95	34.12	0.29	0.30	Average
4	0.3955300	42.18	-15.77	57.95	41.59	0.29	0.30	QP
5	3.462	30.44	-25.56	56.00	29.61	0.33	0.50	QP
6	3.462	21.96	-24.04	46.00	21.13	0.33	0.50	Average
7	5.164	33.54	-26.46	60.00	32.67	0.37	0.50	QP
8	5.164	24.51	-25.49	50.00	23.64	0.37	0.50	Average
9	17.693	41.63	-8.37	50.00	40.47	0.56	0.60	Average
10	17.693	47.10	-12.90	60.00	45.94	0.56	0.60	QP
11	19.708	48.12	-11.88	60.00	46.94	0.58	0.60	QP
12	19.708	42.94	-7.06	50.00	41.76	0.58	0.60	Average

Neutral

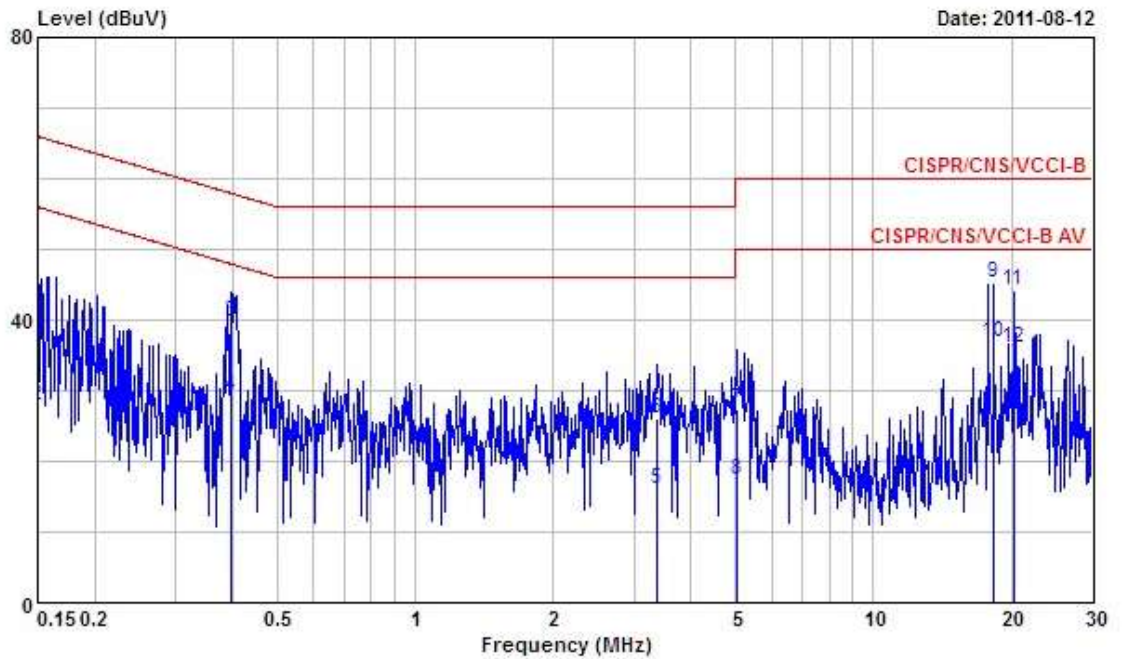

	Freq	Level	Over Limit	Limit Line	Read Level	LISN Factor	Cable Loss	Remark
	MHz	dBuV	dB	dBuV	dBuV	dB	dB	
1	0.1500000	43.94	-22.06	66.00	43.61	0.27	0.06	QP
2	0.1500000	27.95	-28.05	56.00	27.62	0.27	0.06	Average
3	0.3976320	39.74	-18.16	57.90	39.20	0.24	0.30	QP
4	0.3976320	29.25	-18.65	47.90	28.71	0.24	0.30	Average
5	3.360	15.96	-30.04	46.00	15.18	0.28	0.50	Average
6	3.360	26.09	-29.91	56.00	25.31	0.28	0.50	QP
7	5.030	27.43	-32.57	60.00	26.62	0.31	0.50	QP
8	5.030	17.30	-32.70	50.00	16.49	0.31	0.50	Average
9	18.243	45.38	-14.62	60.00	44.31	0.47	0.60	QP
10	18.243	36.82	-13.18	50.00	35.75	0.47	0.60	Average
11	20.259	44.25	-15.75	60.00	43.17	0.48	0.60	QP
12	20.259	35.96	-14.04	50.00	34.88	0.48	0.60	Average

Note:  
Level = Read Level + LISN Factor + Cable Loss.

Final Test date	Aug. 11, 2011	Test Site No.	CO04-HY
Temperature	26.6°C	Humidity	57.2%
Test Engineer	Jason	Configuration	Wireless Mode

Line

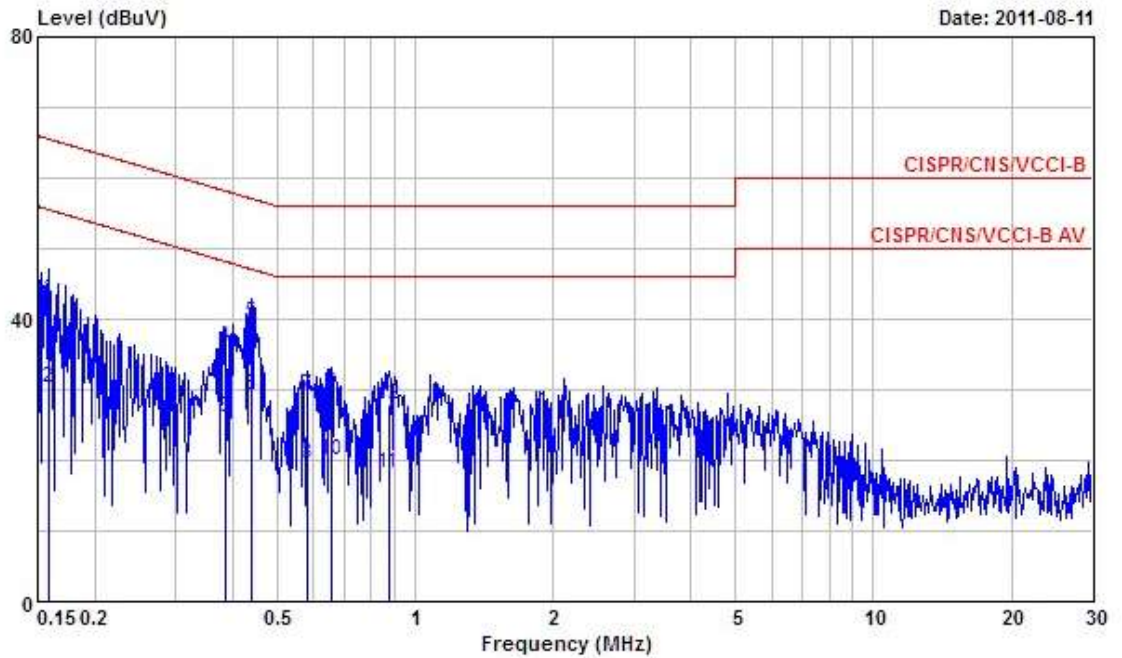

	Freq	Level	Over Limit	Limit Line	Read Level	LISN Factor	Cable Loss	Remark
	MHz	dBuV	dB	dBuV	dBuV	dB	dB	
1	0.1590020	42.79	-22.73	65.52	42.42	0.30	0.07	QP
2	0.1590020	30.36	-25.16	55.52	29.99	0.30	0.07	Average
3	0.3845300	26.05	-22.13	48.18	25.46	0.30	0.29	Average
4	0.3845300	36.16	-22.02	58.18	35.57	0.30	0.29	QP
5	0.4397440	39.40	-17.67	57.07	38.79	0.29	0.32	QP
6	0.4397440	29.27	-17.80	47.07	28.66	0.29	0.32	Average
7	0.5792340	29.31	-26.69	56.00	28.64	0.29	0.38	QP
8	0.5792340	19.36	-26.64	46.00	18.69	0.29	0.38	Average
9	0.6543010	29.78	-26.22	56.00	29.08	0.29	0.41	QP
10	0.6543010	20.13	-25.87	46.00	19.43	0.29	0.41	Average
11	0.8756580	18.18	-27.82	46.00	17.42	0.29	0.47	Average
12	0.8756580	27.78	-28.22	56.00	27.02	0.29	0.47	QP

Neutral

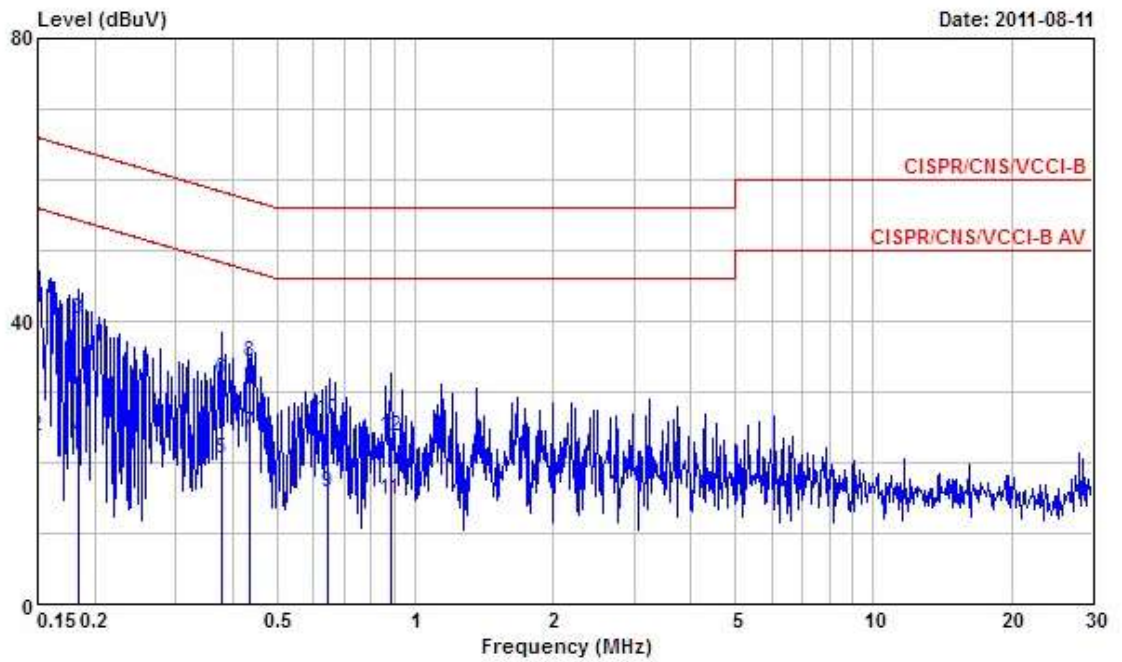

	Freq	Level	Over Limit	Limit Line	Read Level	LISN Factor	Cable Loss	Remark
	MHz	dBuV	dB	dBuV	dBuV	dB	dB	
1	0.1500000	41.94	-24.06	66.00	41.61	0.27	0.06	QP
2	0.1500000	23.60	-32.40	56.00	23.27	0.27	0.06	Average
3	0.1844300	40.20	-24.08	64.28	39.85	0.26	0.09	QP
4	0.1844300	23.42	-30.86	54.28	23.07	0.26	0.09	Average
5	0.3791160	20.41	-27.89	48.30	19.89	0.24	0.28	Average
6	0.3791160	31.90	-26.40	58.30	31.38	0.24	0.28	QP
7	0.4341230	24.32	-22.85	47.17	23.76	0.24	0.32	Average
8	0.4341230	34.18	-22.99	57.17	33.62	0.24	0.32	QP
9	0.6445940	15.68	-30.32	46.00	15.03	0.25	0.40	Average
10	0.6445940	26.13	-29.87	56.00	25.48	0.25	0.40	QP
11	0.8849860	14.68	-31.32	46.00	13.96	0.25	0.47	Average
12	0.8849860	23.70	-32.30	56.00	22.98	0.25	0.47	QP

Note:  
Level = Read Level + LISN Factor + Cable Loss.

**3.2 Maximum Peak Output Power Measurement**

**3.2.1 Limit**

For systems using digital modulation in the 2400-2483.5MHz, the limit for peak output power is 30dBm. The limited has to be reduced by the amount in dB that the gain of the antenna exceed 6dBi. In case of point-to-point operation, the limit has to be reduced by 1dB for every 3dB that the directional gain of the antenna exceeds 6dBi.

**3.2.2 Measuring Instruments and Setting**

Please refer to section 4 of equipments list in this report. The following table is the setting of the spectrum analyzer.

<b>Power Meter Parameter</b>	<b>Setting</b>
Attenuation	Auto
Span Frequency	Encompass the entire emissions bandwidth (EBW) of the signal
RB	1000 kHz
VB	3000 kHz
Detector	rms
Trace	Max Hold
Sweep Time	Auto

**3.2.3 Test Procedures**

1. The transmitter output (antenna port) was connected to the power meter.
2. Turn on the EUT and power meter and then record the peak power value.
3. Repeat above procedures on all channels needed to be tested.

**3.2.4 Test Setup Layout**

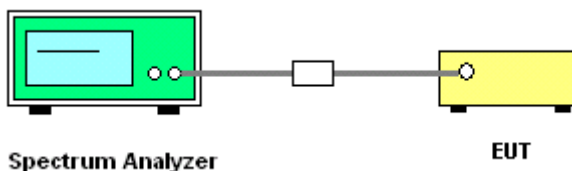

**3.2.5 Test Deviation**

There is no deviation with the original standard.

**3.2.6 EUT Operation during Test**

The EUT was programmed to be in continuously transmitting mode.



**3.2.7 Test Result of Maximum Peak Output Power**

<b>Final Test date</b>	Aug. 09, 2011	<b>Test Site No.</b>	TH01-HY
<b>Temperature</b>	28.2°C	<b>Humidity</b>	49%
<b>Test Engineer</b>	Ian	<b>Configurations</b>	802.11b/g

**Configuration IEEE 802.11b**

Channel	Frequency	Conducted Power (dBm)	Max. Limit (dBm)	Result
1	2412 MHz	17.08	30.00	<b>Complies</b>
6	2437 MHz	17.02	30.00	<b>Complies</b>
11	2462 MHz	17.36	30.00	<b>Complies</b>

**Configuration IEEE 802.11g**

Channel	Frequency	Conducted Power (dBm)	Max. Limit (dBm)	Result
1	2412 MHz	15.49	30.00	<b>Complies</b>
6	2437 MHz	15.51	30.00	<b>Complies</b>
11	2462 MHz	15.42	30.00	<b>Complies</b>

**3.3 Power Spectral Density Measurement**

**3.3.1 Limit**

For digitally modulated systems, the power spectral density conducted from the intentional radiator to the antenna shall not be greater than 8 dBm in any 3 kHz band during any time interval of continuous transmission.

**3.3.2 Measuring Instruments and Setting**

Please refer to section 4 of equipments list in this report. The following table is the setting of the spectrum analyzer.

<b>Spectrum Parameter</b>	<b>Setting</b>
Attenuation	Auto
Span Frequency	1.5MHz
RB	3 kHz
VB	30 kHz
Detector	Peak
Trace	Max Hold
Sweep Time	500s

**3.3.3 Test Procedures**

1. The transmitter output (antenna port) was connected to the spectrum analyzer.
2. Set RBW of spectrum analyzer to 3 kHz and VBW to 30 kHz. Set Detector to Peak, Trace to Max Hold.
3. Mark the frequency with maximum peak power as the center of the display of the spectrum.
4. Set the span to 1.5MHz and the sweep time to 500s and record the maximum peak value.

**3.3.4 Test Setup Layout**

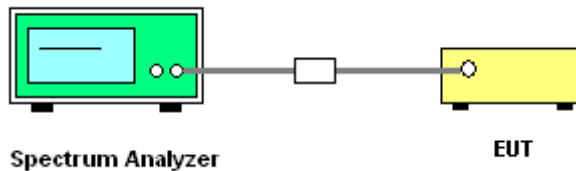

**3.3.5 Test Deviation**

There is no deviation with the original standard.

**3.3.6 EUT Operation during Test**

The EUT was programmed to be in continuously transmitting mode.

**3.3.7 Test Result of Power Spectral Density**

<b>Final Test date</b>	Aug. 09, 2011	<b>Test Site No.</b>	TH01-HY
<b>Temperature</b>	28.2°C	<b>Humidity</b>	49%
<b>Test Engineer</b>	Ian	<b>Configurations</b>	802.11b/g

**Configuration IEEE 802.11b**

Channel	Frequency	Power Density (dBm)	Max. Limit (dBm)	Result
1	2412 MHz	-13.93	8.00	<b>Complies</b>
6	2437 MHz	-15.91	8.00	<b>Complies</b>
11	2462 MHz	-14.50	8.00	<b>Complies</b>

**Configuration IEEE 802.11g**

Channel	Frequency	Power Density (dBm)	Max. Limit (dBm)	Result
1	2412 MHz	-21.09	8.00	<b>Complies</b>
6	2437 MHz	-21.19	8.00	<b>Complies</b>
11	2462 MHz	-21.18	8.00	<b>Complies</b>

Power Density Plot on Configuration IEEE 802.11b / 2412 MHz

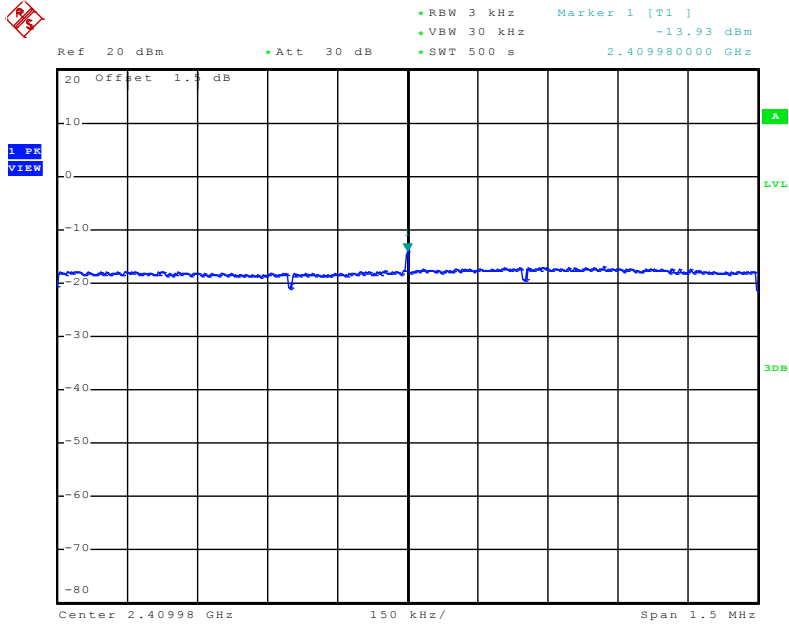

Date: 9.AUG.2011 15:43:07

Power Density Plot on Configuration IEEE 802.11b / 2437 MHz

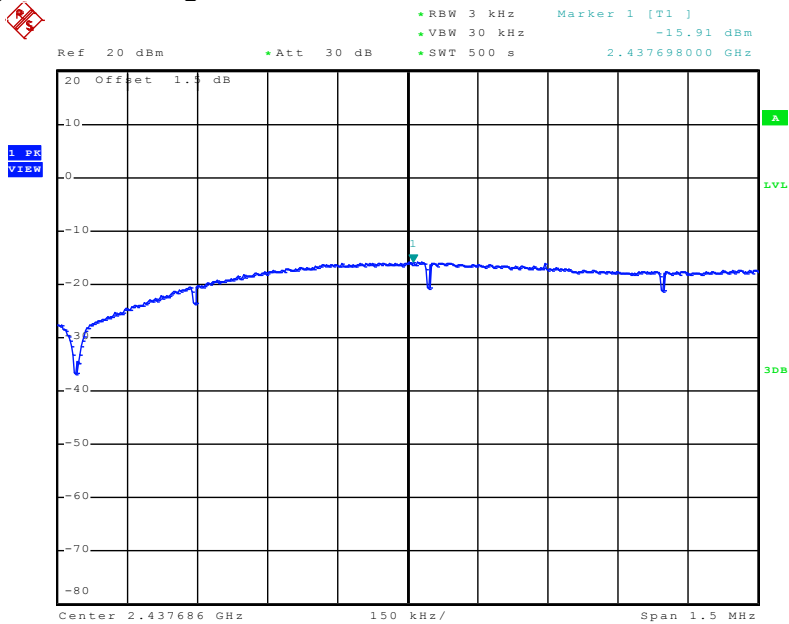

Date: 9.AUG.2011 15:45:41

Power Density Plot on Configuration IEEE 802.11b / 2462 MHz

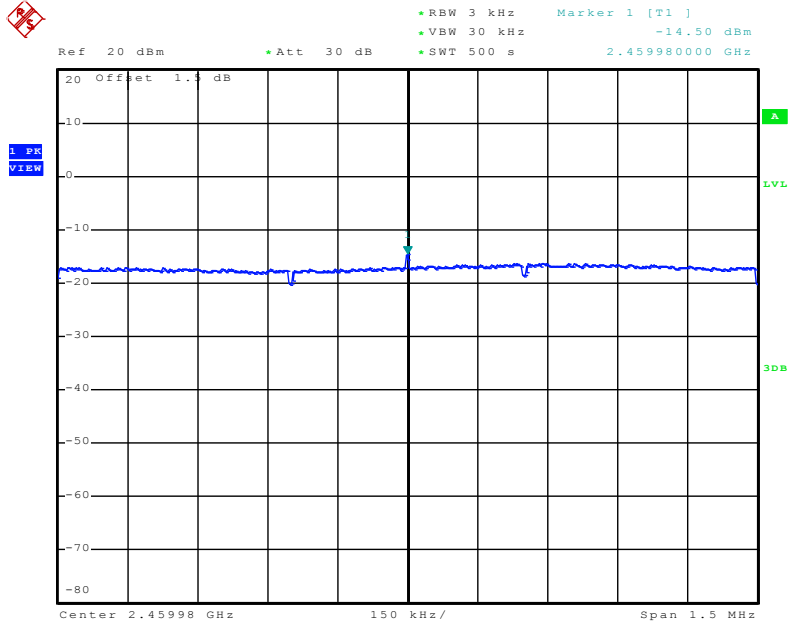

Date: 9.AUG.2011 15:49:18

Power Density Plot on Configuration IEEE 802.11g / 2412 MHz

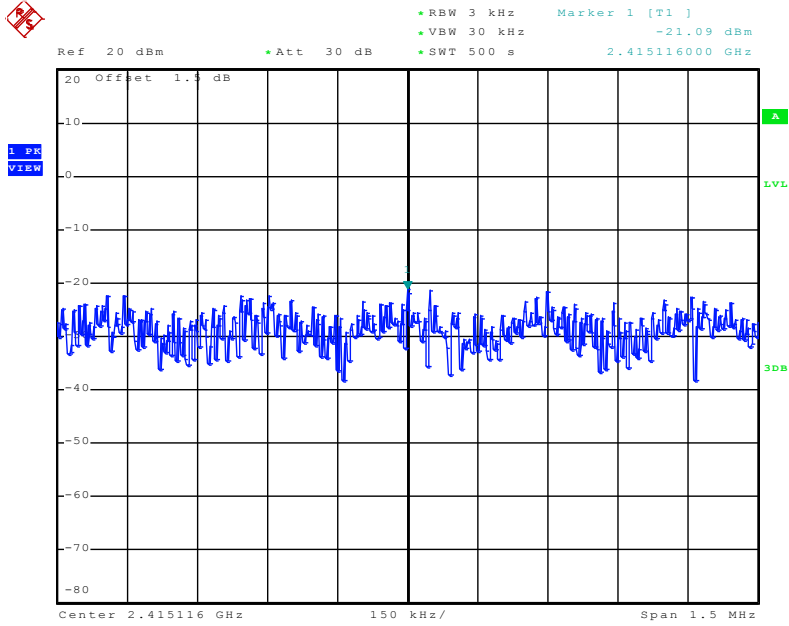

Date: 9.AUG.2011 15:56:53

Power Density Plot on Configuration IEEE 802.11g / 2437 MHz

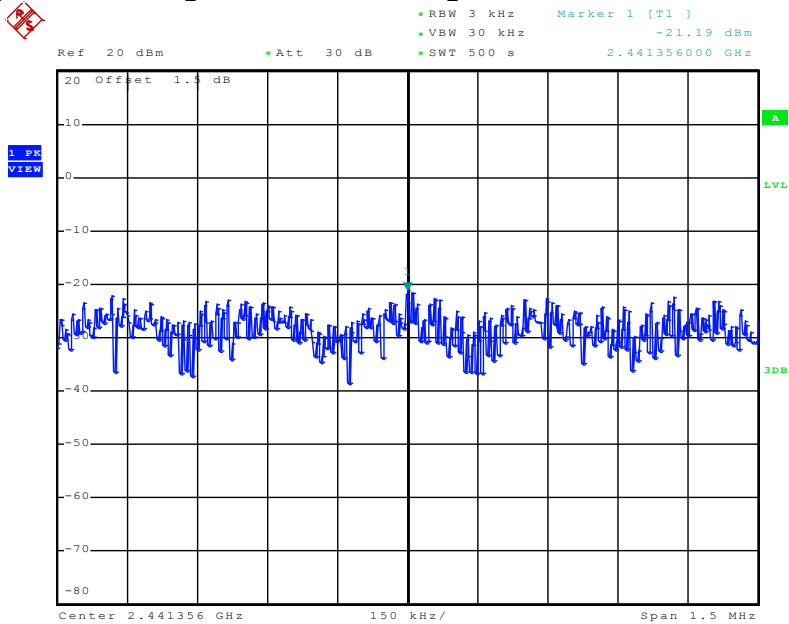

Date: 9.AUG.2011 15:59:36

Power Density Plot on Configuration IEEE 802.11g / 2462 MHz

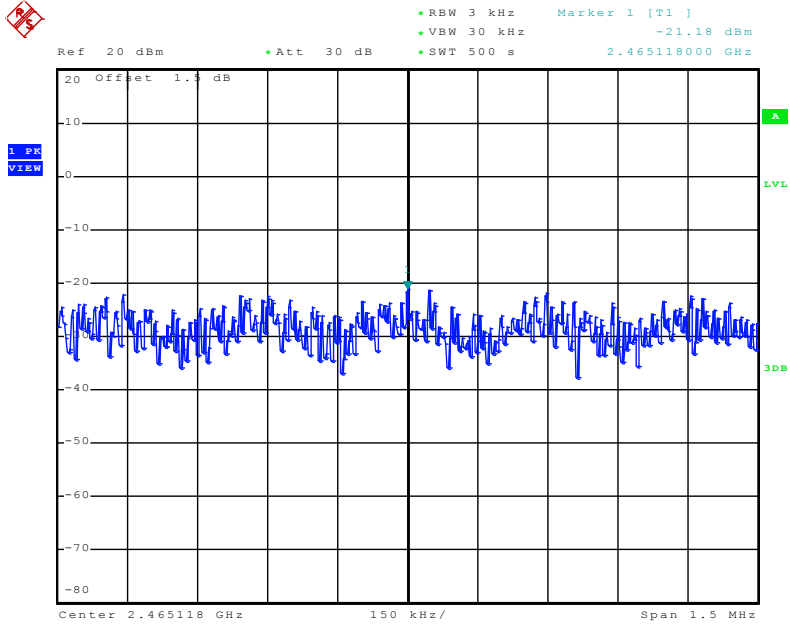

Date: 9.AUG.2011 16:02:51

**3.4 6dB Spectrum Bandwidth Measurement**

**3.4.1 Limit**

For digital modulation systems, the minimum 6dB bandwidth shall be at least 500 kHz.

**3.4.2 Measuring Instruments and Setting**

Please refer to section 4 of equipments list in this report. The following table is the setting of the spectrum analyzer.

<b>Spectrum Parameters</b>	<b>Setting</b>
Attenuation	Auto
Span Frequency	> 6dB Bandwidth
RB	100 kHz
VB	100 kHz
Detector	Peak
Trace	Max Hold
Sweep Time	Auto

**3.4.3 Test Procedures**

1. The transmitter output (antenna port) was connected to the spectrum analyzer in peak hold mode.
2. The resolution bandwidth of 100 kHz and the video bandwidth of 100 kHz were used.
3. Measured the spectrum width with power higher than 6dB below carrier.

**3.4.4 Test Setup Layout**

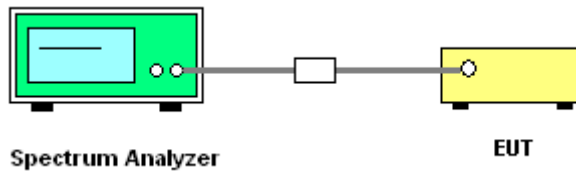

**3.4.5 Test Deviation**

There is no deviation with the original standard.

**3.4.6 EUT Operation during Test**

The EUT was programmed to be in continuously transmitting mode.



**3.4.7 Test Result of 6dB Spectrum Bandwidth**

<b>Final Test date</b>	Aug. 09, 2011	<b>Test Site No.</b>	TH01-HY
<b>Temperature</b>	28.2°C	<b>Humidity</b>	49%
<b>Test Engineer</b>	Ian	<b>Configurations</b>	802.11b/g

**Configuration IEEE 802.11b**

Channel	Frequency	6dB Bandwidth (MHz)	99% Occupied Bandwidth (MHz)	Min. Limit (kHz)	Test Result
1	2412 MHz	10.12	14.88	500	<b>Complies</b>
6	2437 MHz	10.12	14.92	500	<b>Complies</b>
11	2462 MHz	10.12	14.96	500	<b>Complies</b>

**Configuration IEEE 802.11g**

Channel	Frequency	6dB Bandwidth (MHz)	99% Occupied Bandwidth (MHz)	Min. Limit (kHz)	Test Result
1	2412 MHz	16.52	16.44	500	<b>Complies</b>
6	2437 MHz	16.52	16.44	500	<b>Complies</b>
11	2462 MHz	16.52	16.48	500	<b>Complies</b>

6 dB Bandwidth Plot on Configuration IEEE 802.11b / 2412 MHz

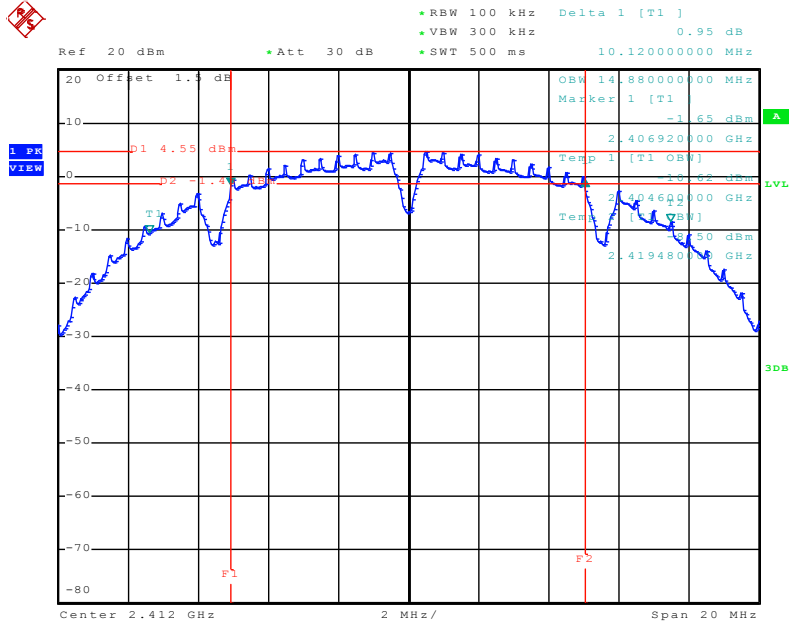

Date: 9.AUG.2011 15:25:58

6 dB Bandwidth Plot on Configuration IEEE 802.11b / 2437 MHz

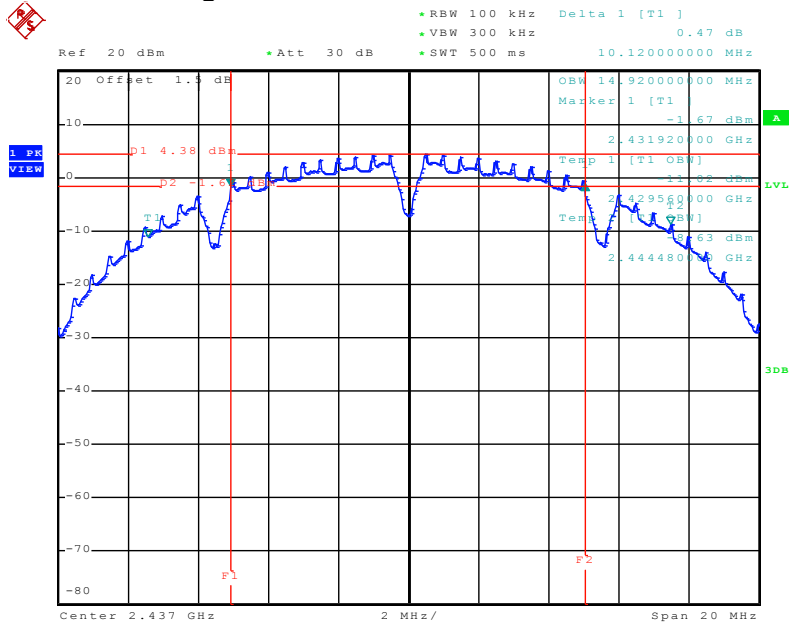

Date: 9.AUG.2011 15:44:39

6 dB Bandwidth Plot on Configuration IEEE 802.11b / 2462 MHz

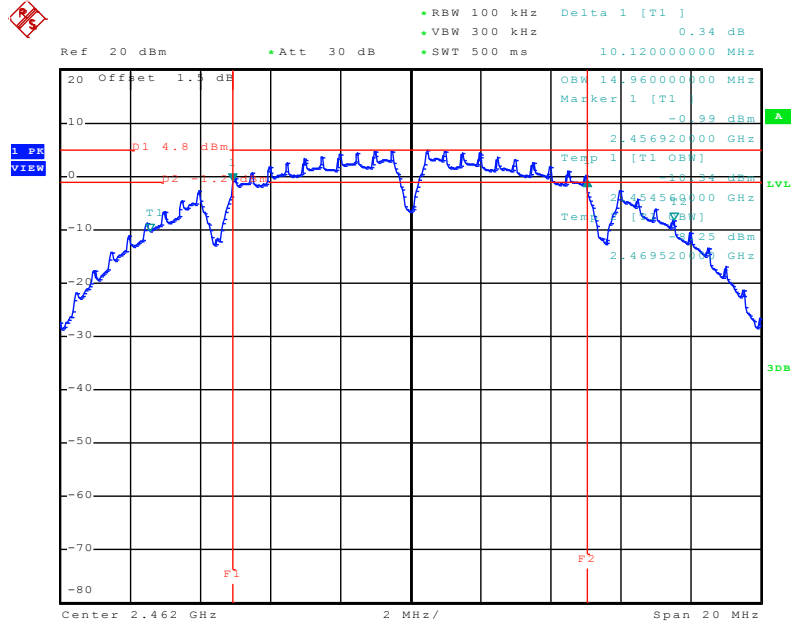

Date: 9.AUG.2011 15:47:07

6 dB Bandwidth Plot on Configuration IEEE 802.11g / 2412 MHz

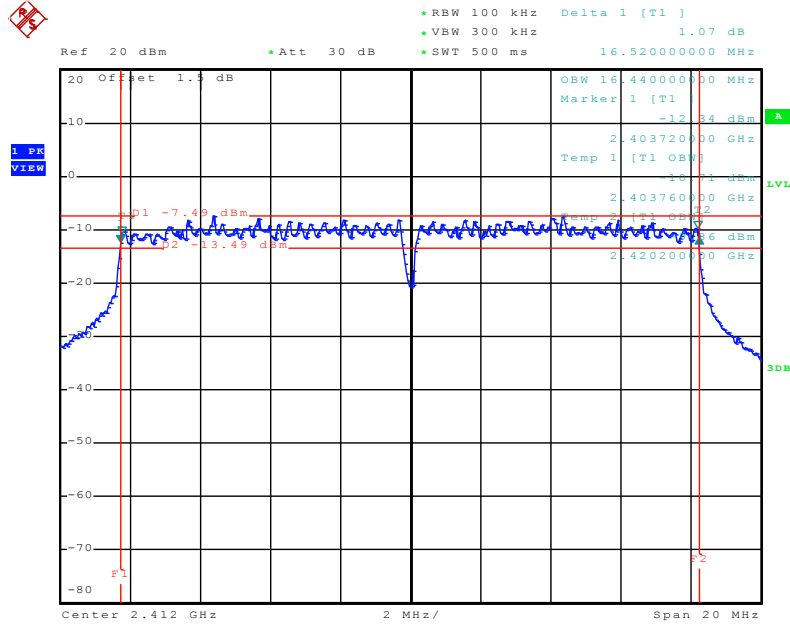

Date: 9.AUG.2011 15:53:08

6 dB Bandwidth Plot on Configuration IEEE 802.11g / 2437 MHz

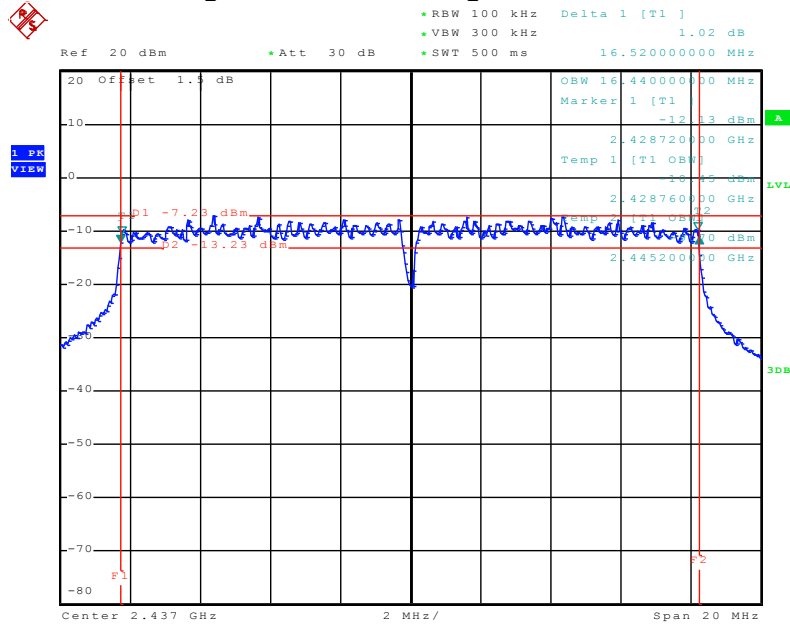

Date: 9.AUG.2011 15:58:34

6 dB Bandwidth Plot on Configuration IEEE 802.11g / 2462 MHz

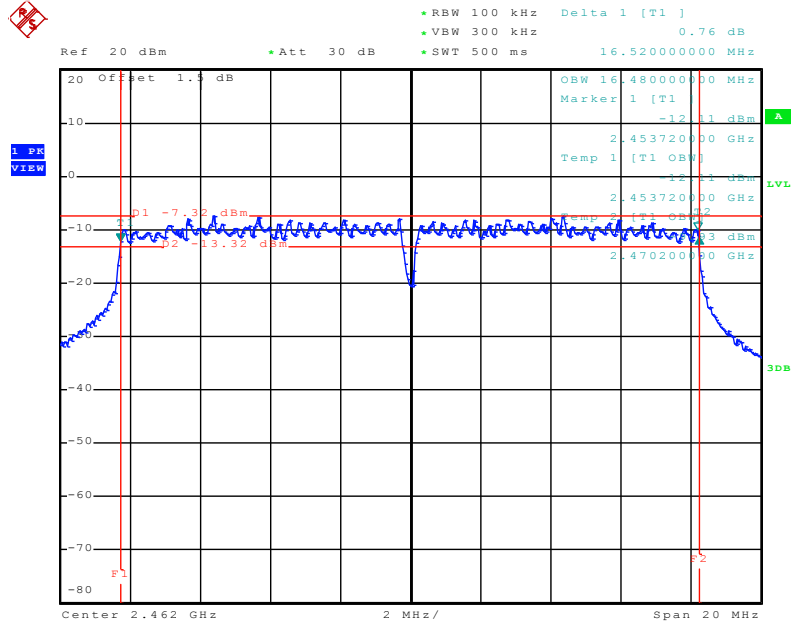

Date: 9.AUG.2011 16:01:07

**3.5 Radiated Emissions Measurement**

**3.5.1 Limit**

20dBc in any 100 kHz bandwidth outside the operating frequency band. In case the emission fall within the restricted band specified on 15.205(a), then the 15.209(a) limit in the table below has to be followed.

<b>Frequencies (MHz)</b>	<b>Field Strength (micorvolts/meter)</b>	<b>Measurement Distance (meters)</b>
0.009~0.490	2400/F(KHz)	300
0.490~1.705	24000/F(KHz)	30
1.705~30.0	30	30
30~88	100	3
88~216	150	3
216~960	200	3
Above 960	500	3

**3.5.2 Measuring Instruments and Setting**

Please refer to section 4 of equipments list in this report. The following table is the setting of spectrum analyzer and receiver.

<b>Spectrum Parameter</b>	<b>Setting</b>
Attenuation	Auto
Start Frequency	1000 MHz
Stop Frequency	10th carrier harmonic
RB / VB (Emission in restricted band)	1MHz / 1MHz for Peak, 1 MHz / 10Hz for Average
RB / VB (Emission in non-restricted band)	1MHz / 1MHz for peak

<b>Receiver Parameter</b>	<b>Setting</b>
Attenuation	Auto
Start ~ Stop Frequency	9kHz~150kHz / RB 200Hz for QP
Start ~ Stop Frequency	150kHz~30MHz / RB 9kHz for QP
Start ~ Stop Frequency	30MHz~1000MHz / RB 120kHz for QP

**3.5.3 Test Procedures**

1. Configure the EUT according to ANSI C63.4. The EUT was placed on the top of the turntable 0.8 meter above ground. The phase center of the receiving antenna mounted on the top of a height-variable antenna tower was placed 3 meters far away from the turntable.
2. Power on the EUT and all the supporting units. The turntable was rotated by 360 degrees to determine the position of the highest radiation.
3. The height of the broadband receiving antenna was varied between one meter and four meters above ground to find the maximum emissions field strength of both horizontal and vertical polarization.
4. For each suspected emissions, the antenna tower was scan (from 1 M to 4 M) and then the turntable was rotated (from 0 degree to 360 degrees) to find the maximum reading.
5. Set the test-receiver system to Peak or CISPR quasi-peak Detect Function with specified bandwidth under Maximum Hold Mode.
6. For emissions above 1GHz, use 1MHz VBW and RBW for peak reading. Then 1MHz RBW and 10Hz VBW for average reading in spectrum analyzer.
7. When the radiated emissions limits are expressed in terms of the average value of the emissions, and pulsed operation is employed, the measurement field strength shall be determined by averaging over one complete pulse train, including blanking intervals, as long as the pulse train does not exceed 0.1 seconds. As an alternative (provided the transmitter operates for longer than 0.1 seconds) or in cases where the pulse train exceeds 0.1 seconds, the measured field strength shall be determined from the average absolute voltage during a 0.1 second interval during which the field strength is at its maximum value.
8. If the emissions level of the EUT in peak mode was 3 dB lower than the average limit specified, then testing will be stopped and peak values of EUT will be reported, otherwise, the emissions which do not have 3 dB margin will be repeated one by one using the quasi-peak method for below 1GHz.
9. For testing above 1GHz, the emissions level of the EUT in peak mode was lower than average limit (that means the emissions level in peak mode also complies with the limit in average mode), then testing will be stopped and peak values of EUT will be reported, otherwise, the emissions will be measured in average mode again and reported.
10. In case the emission is lower than 30MHz, loop antenna has to be used for measurement and the recorded data should be QP measured by receiver. High – Low scan is not required in this case.

3.5.4 Test Setup Layout

For radiated emissions below 30MHz

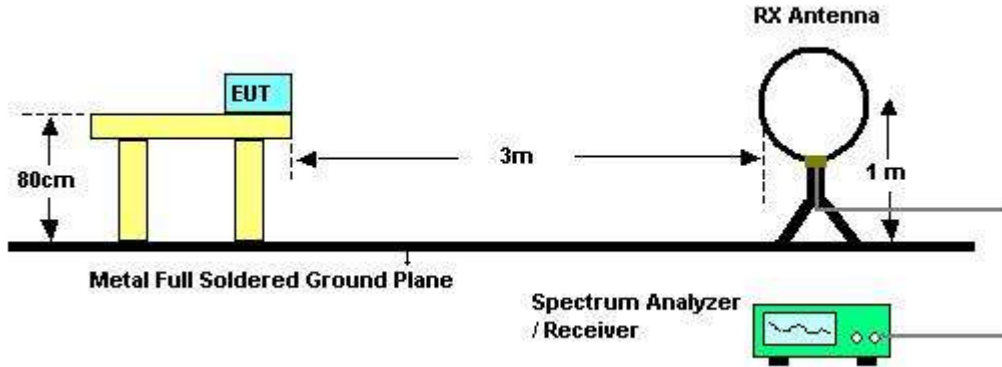

For radiated emissions above 30MHz

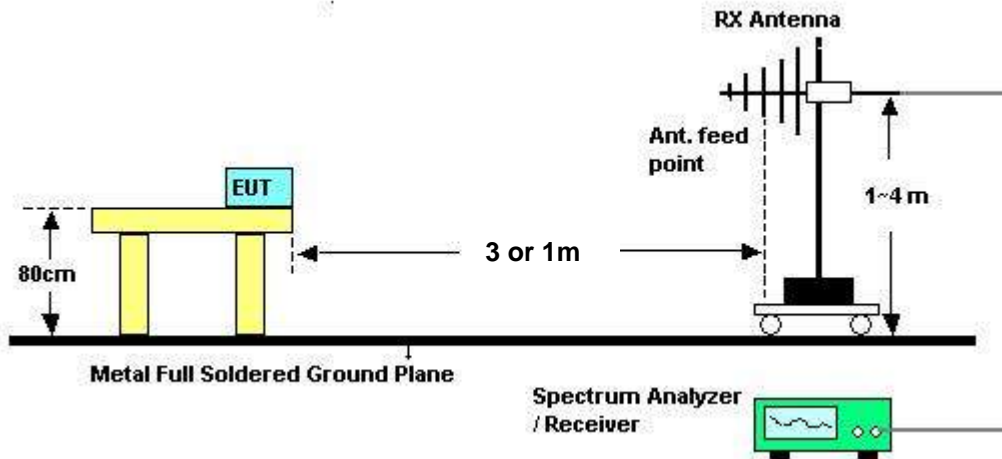

Above 10 GHz shall be extrapolated to the specified distance using an extrapolation factor of 20 dB/decade from 3m to 1m.

Distance extrapolation factor =  $20 \log (\text{specific distance [3m]} / \text{test distance [1m]})$  (dB);

Limit line = specific limits (dBuV) + distance extrapolation factor [9.54 dB].

3.5.5 Test Deviation

There is no deviation with the original standard.

3.5.6 EUT Operation during Test

The EUT was programmed to be in continuously transmitting mode.



**3.5.7 Results of Radiated Emissions (9kHz~30MHz)**

<b>Final Test date</b>	Jul. 13, 2011	<b>Test Site No.</b>	03CH02-HY
<b>Temperature</b>	23°C	<b>Humidity</b>	59%
<b>Test Engineer</b>	Streak		

<b>Freq. (MHz)</b>	<b>Level (dBuV)</b>	<b>Over Limit (dB)</b>	<b>Limit Line (dBuV)</b>	<b>Remark</b>
-	-	-	-	See Note

**Note:**

The amplitude of spurious emissions that are attenuated by more than 20 dB below the permissible value has no need to be reported.

Distance extrapolation factor =  $40 \log$  (specific distance / test distance) (dB);

Limit line = specific limits (dBuV) + distance extrapolation factor.

3.5.8 Results of Radiated Emissions (30MHz~1GHz)

Final Test date	Jul. 13, 2011	Test Site No.	03CH02-HY
Temperature	23°C	Humidity	59%
Test Engineer	Streak	Configurations	LAN Mode

Horizontal

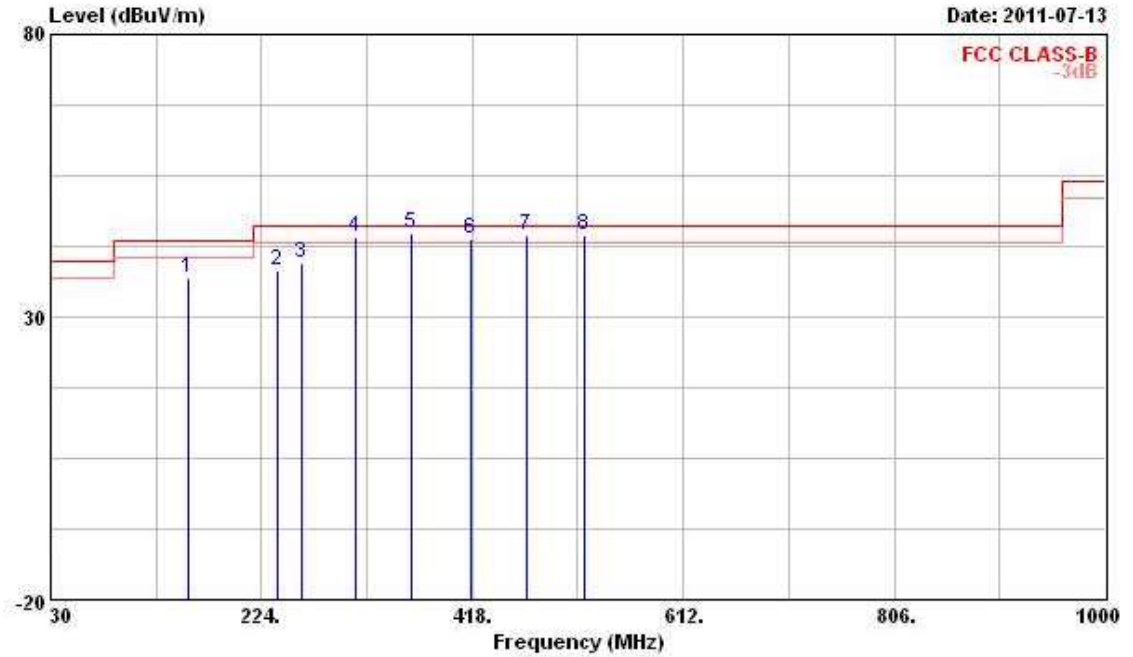

	Freq	Level	Over Limit	Limit Line	Read Level	Antenna Factor	Cable Loss	Preamp Factor	Remark	Ant Pos	Table Pos
	MHz	dBuV/m	dB	dBuV/m	dBuV	dB/m	dB	dB		cm	deg
1	156.100	36.87	-6.63	43.50	50.91	10.64	2.07	26.75	Peak	---	---
2	238.550	38.12	-7.88	46.00	49.65	12.62	2.60	26.75	Peak	---	---
3	260.860	39.55	-6.45	46.00	49.82	13.15	2.74	26.16	Peak	---	---
4 !	311.300	44.31	-1.69	46.00	53.80	13.88	2.93	26.30	QP	---	---
5 !	362.710	44.83	-1.17	46.00	53.74	14.68	3.09	26.68	QP	---	---
6 !	416.060	43.89	-2.11	46.00	51.98	15.59	3.39	27.07	QP	---	---
7 !	467.470	44.54	-1.46	46.00	51.82	16.63	3.60	27.51	QP	---	---
8 !	521.790	44.39	-1.61	46.00	50.36	17.93	3.79	27.69	QP	---	---

Vertical

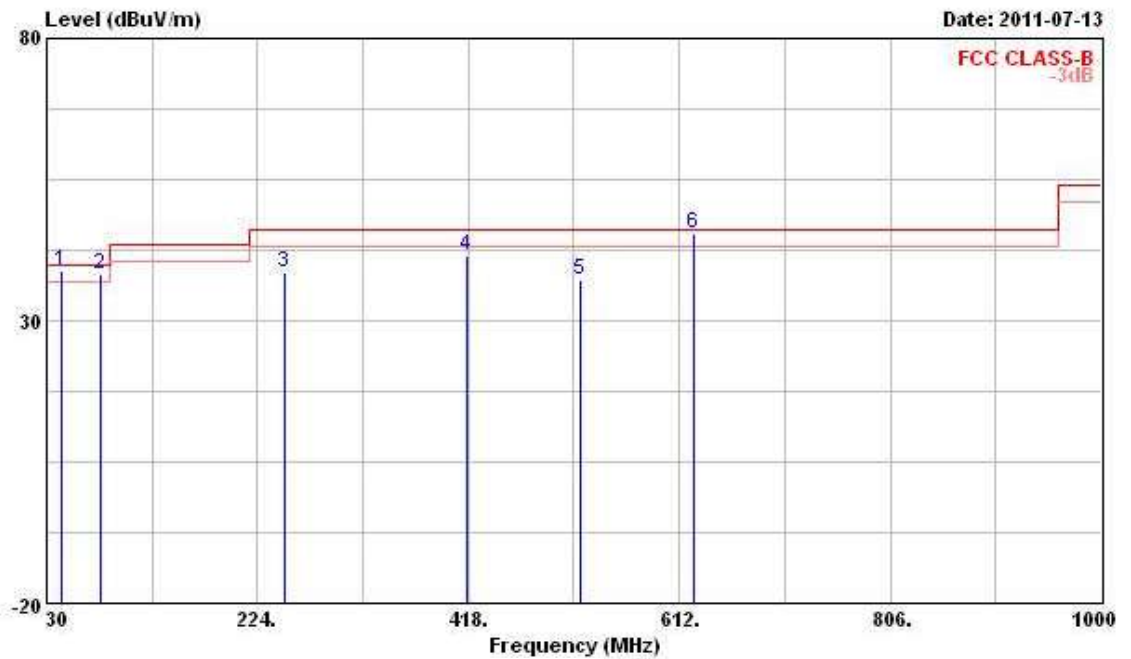

	Freq	Level	Over Limit	Limit Line	ReadAntenna Level	Antenna Factor	Cable Loss	Preamp Factor	Remark	Ant Pos	Table Pos
	MHz	dBuV/m	dB	dBuV/m	dBuV	dB/m	dB	dB		cm	deg
1 !	43.580	38.93	-1.07	40.00	52.97	12.27	1.04	27.35	QP	---	---
2 !	79.470	38.24	-1.76	40.00	56.09	7.37	1.41	26.63	QP	---	---
3	249.220	38.54	-7.46	46.00	49.38	12.97	2.68	26.49	Peak	---	---
4	416.060	41.46	-4.54	46.00	49.55	15.59	3.39	27.07	QP	---	---
5	520.820	37.28	-8.72	46.00	43.29	17.90	3.79	27.70	QP	---	---
6 !	625.580	45.50	-0.50	46.00	49.33	19.84	4.14	27.81	QP	---	---

Note:

The amplitude of spurious emissions that are attenuated by more than 20dB below the permissible value has no need to be reported.

Emission level (dBuV/m) = 20 log Emission level (uV/m).

Corrected Reading: Antenna Factor + Cable Loss + Read Level - Preamp Factor = Level.

Final Test date	Jul. 13, 2011	Test Site No.	03CH02-HY
Temperature	23°C	Humidity	59%
Test Engineer	Streak	Configurations	Wireless Mode

Horizontal

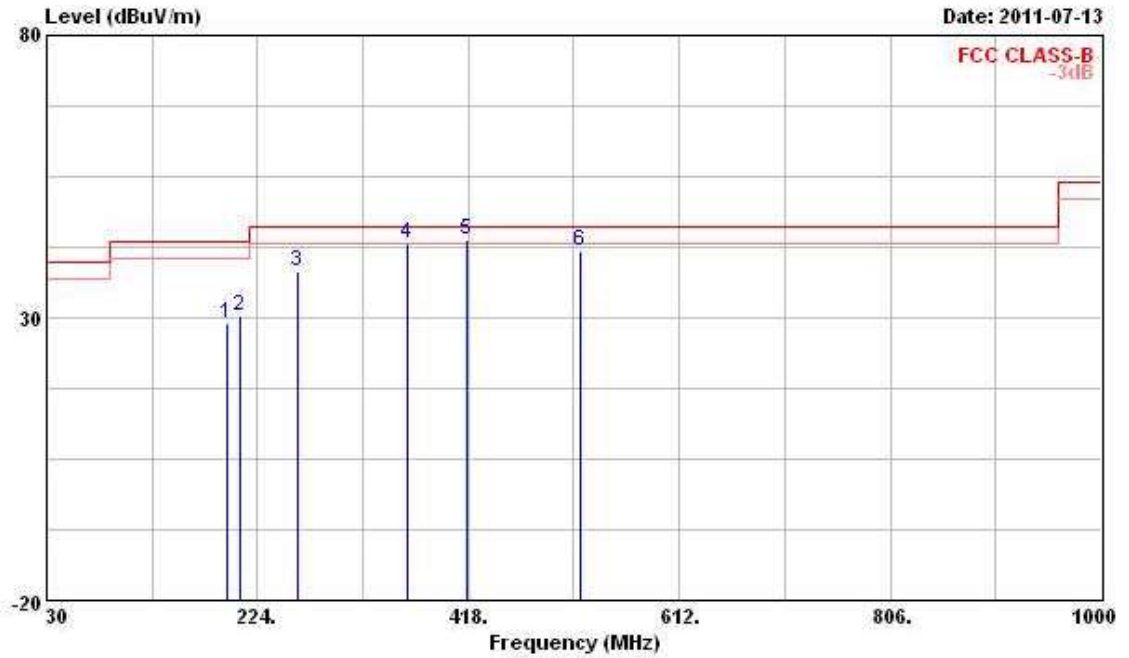

	Freq	Level	Over Limit	Limit Line	Read Level	Antenna Factor	Cable Loss	Preamp Factor	Remark	Ant Pos	Table Pos
	MHz	dBuV/m	dB	dBuV/m	dBuV	dB/m	dB	dB		cm	deg
1	195.870	28.86	-14.64	43.50	42.40	11.06	2.30	26.90	Peak	---	---
2	207.510	30.27	-13.23	43.50	43.13	11.60	2.37	26.83	Peak	---	---
3	260.860	38.28	-7.72	46.00	48.55	13.15	2.74	26.16	Peak	---	---
4 !	362.710	43.14	-2.86	46.00	52.05	14.68	3.09	26.68	QP	---	---
5 !	416.060	43.68	-2.32	46.00	51.77	15.59	3.39	27.07	QP	---	---
6	520.820	41.97	-4.03	46.00	47.98	17.90	3.79	27.70	Peak	---	---

Vertical

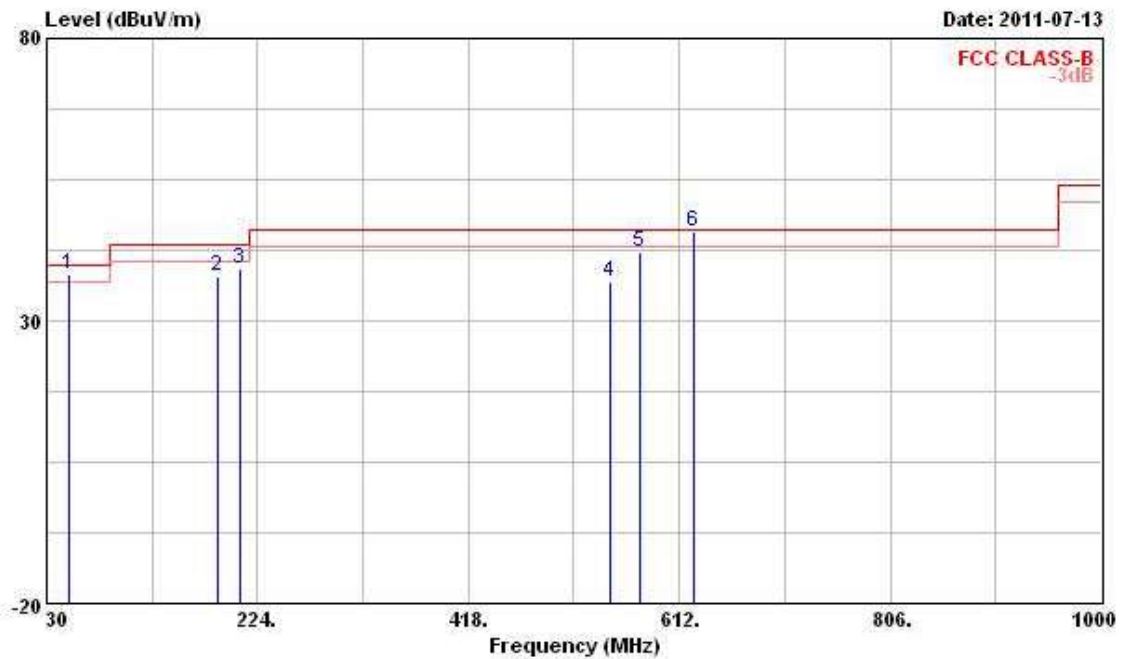

	Freq	Level	Over Limit	Limit Line	ReadAntenna Level	Antenna Factor	Cable Loss	Preamp Factor	Remark	Ant Pos	Table Pos
	MHz	dBuV/m	dB	dBuV/m	dBuV	dB/m	dB	dB		cm	deg
1	51.340	38.07	-1.93	40.00	55.20	9.16	1.14	27.43	QP	---	---
2	188.110	37.95	-5.55	43.50	52.05	10.48	2.25	26.83	Peak	---	---
3	207.510	39.25	-4.25	43.50	52.11	11.60	2.37	26.83	Peak	---	---
4	547.980	36.76	-9.24	46.00	41.82	18.66	3.78	27.50	QP	---	---
5	575.140	42.21	-3.79	46.00	46.42	19.45	3.90	27.56	QP	---	---
6	625.580	45.71	-0.29	46.00	49.54	19.84	4.14	27.81	QP	---	---

Note:

The amplitude of spurious emissions that are attenuated by more than 20dB below the permissible value has no need to be reported.

Emission level (dBuV/m) = 20 log Emission level (uV/m).

Corrected Reading: Antenna Factor + Cable Loss + Read Level - Preamp Factor = Level

3.5.9 Results for Radiated Emissions (1GHz~10<sup>th</sup> Harmonic)

Final Test date	Jul. 11, 2011	Test Site No.	03CH02-HY
Temperature	23°C	Humidity	59%
Test Engineer	Streak	Configuration	802.11b Ch. 1

Horizontal

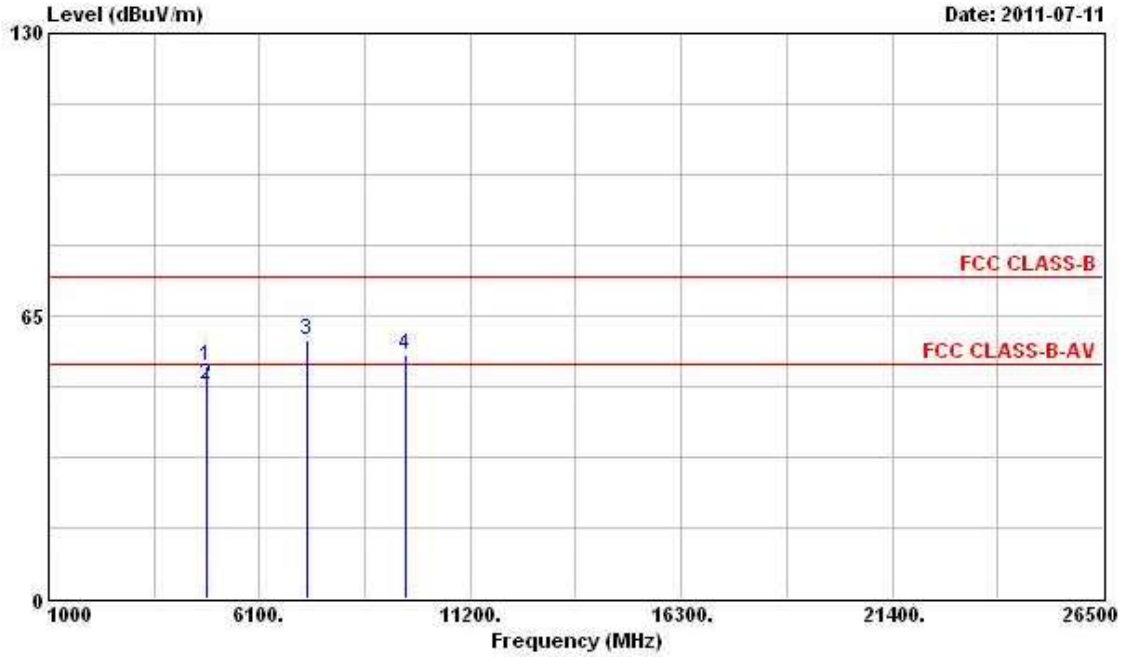

	Freq	Level	Over Limit	Limit Line	Read Level	Antenna Factor	Cable Loss	Preamp Factor	Remark	Ant Pos	Table Pos
	MHz	dBuV/m	dB	dBuV/m	dBuV	dB/m	dB	dB		cm	deg
1	4824.000	53.60	-20.40	74.00	47.77	35.76	4.58	34.51	Peak	---	---
2	4824.000	49.01	-4.99	54.00	43.18	35.76	4.58	34.51	Average	---	---
3	7236.000	59.51			50.32	37.85	5.63	34.29	Peak	---	---
4	9648.000	56.15			45.05	39.39	6.34	34.63	Peak	---	---

Note: The items 3 and 4 are on un-restricted band, so the limit is -20dB for the field strength of the fundamental emissions (see section 3.6.7).

Vertical

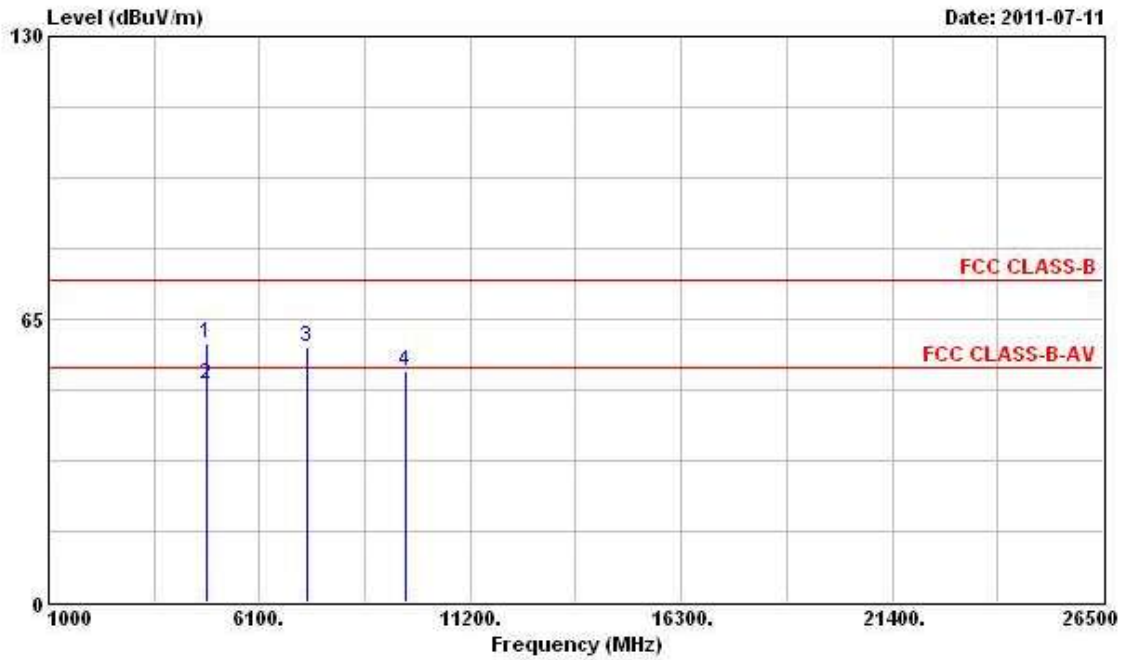

	Freq	Level	Over Limit	Limit Line	Read Level	Antenna Factor	Cable Loss	Preamp Factor	Remark	Ant Pos	Table Pos
	MHz	dBuV/m	dB	dBuV/m	dBuV	dB/m	dB	dB		cm	deg
1	4824.000	59.24	-14.76	74.00	54.04	35.13	4.58	34.51	Peak	---	---
2	4824.000	50.03	-3.97	54.00	44.83	35.13	4.58	34.51	Average	---	---
3	7236.000	58.50			50.26	36.90	5.63	34.29	Peak	---	---
4	9648.000	52.91			42.61	38.59	6.34	34.63	Peak	---	---

Note: The items 3 and 4 are on un-restricted band, so the limit is -20dB for the field strength of the fundamental emissions (see section 3.6.7).

Final Test date	Jul. 12, 2011	Test Site No.	03CH02-HY
Temperature	23°C	Humidity	59%
Test Engineer	Streak	Configuration	802.11b Ch. 6

Horizontal

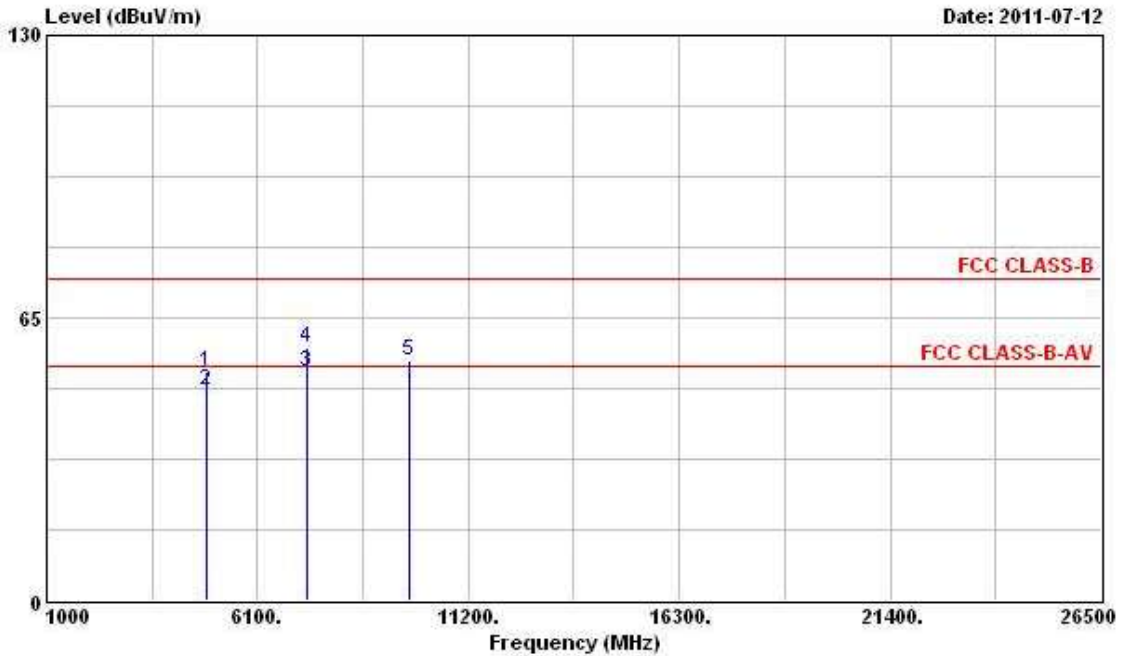

	Freq	Level	Over Limit	Limit Line	Read Level	Antenna Factor	Cable Loss	Preamp Factor	Remark	Ant Pos	Table Pos
	MHz	dBuV/m	dB	dBuV/m	dBuV	dB/m	dB	dB		cm	deg
1	4874.000	52.66	-21.34	74.00	46.67	35.83	4.61	34.45	Peak	---	---
2	4874.000	48.36	-5.64	54.00	42.37	35.83	4.61	34.45	Average	---	---
3	7311.000	52.59	-1.41	54.00	43.38	37.86	5.64	34.29	Average	---	---
4	7311.000	58.19	-15.81	74.00	48.98	37.86	5.64	34.29	Peak	---	---
5	9748.000	55.12			43.83	39.51	6.36	34.58	Peak	---	---

Note: The item 5 is on un-restricted band, so the limit is -20dB for the field strength of the fundamental emissions (see section 3.6.7).



Vertical

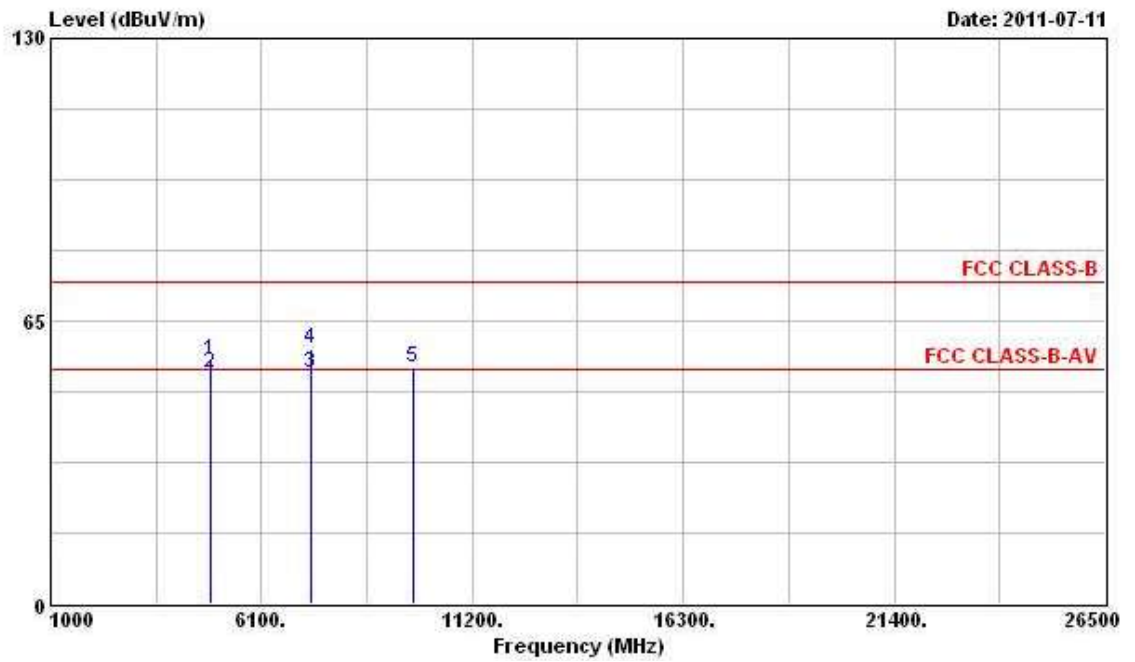

	Freq	Level	Over Limit	Limit Line	ReadAntenna Level	Antenna Factor	Cable Loss	Preamp Factor	Remark	Ant Pos	Table Pos
	MHz	dBuV/m	dB	dBuV/m	dBuV	dB/m	dB	dB		cm	deg
1	4874.000	56.03	-17.97	74.00	50.69	35.18	4.61	34.45	Peak	---	---
2	4874.000	52.92	-1.08	54.00	47.58	35.18	4.61	34.45	Average	---	---
3	7311.000	52.82	-1.18	54.00	44.55	36.92	5.64	34.29	Average	---	---
4	7311.000	58.45	-15.55	74.00	50.18	36.92	5.64	34.29	Peak	---	---
5	9748.000	54.18			43.69	38.71	6.36	34.58	Peak	---	---

Note: The item 5 is on un-restricted band, so the limit is -20dB for the field strength of the fundamental emissions (see section 3.6.7).

Final Test date	Jul. 12, 2011	Test Site No.	03CH02-HY
Temperature	23°C	Humidity	59%
Test Engineer	Streak	Configuration	802.11b Ch. 11

Horizontal

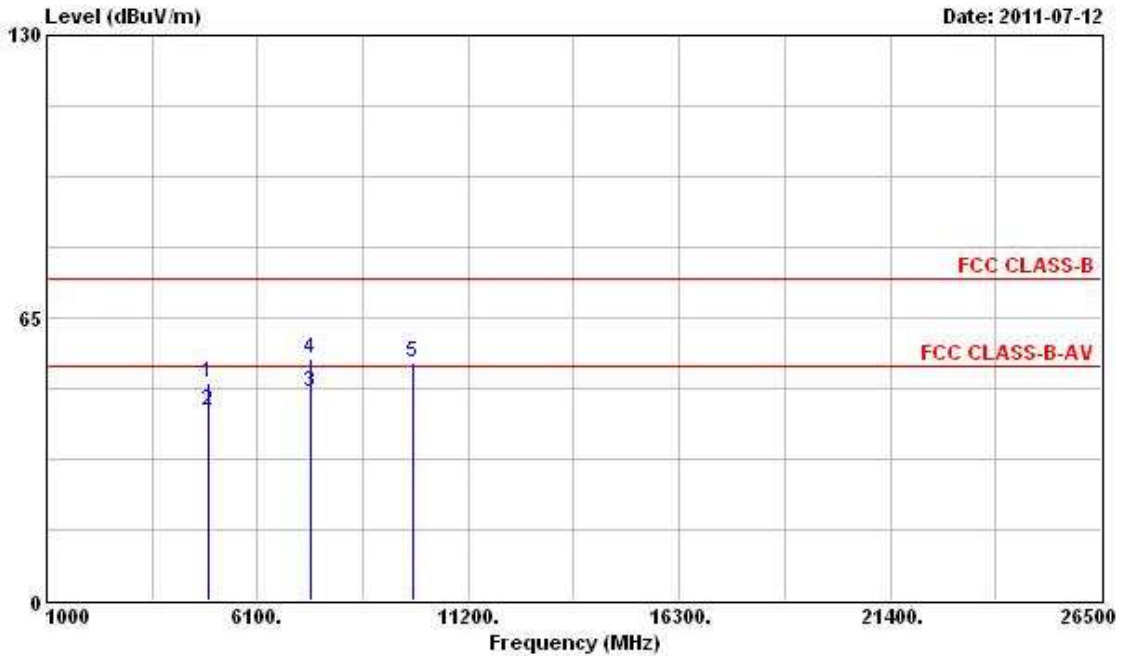

	Freq	Level	Over Limit	Limit Line	Read Level	Antenna Factor	Cable Loss	Preamp Factor	Remark	Ant Pos	Table Pos
	MHz	dBuV/m	dB	dBuV/m	dBuV	dB/m	dB	dB		cm	deg
1	4924.000	50.21	-23.79	74.00	44.01	35.90	4.68	34.38	Peak	---	---
2	4924.000	43.50	-10.50	54.00	37.30	35.90	4.68	34.38	Average	---	---
3	7386.000	47.85	-6.15	54.00	38.61	37.88	5.65	34.29	Average	---	---
4	7386.000	55.65	-18.35	74.00	46.41	37.88	5.65	34.29	Peak	---	---
5	9848.000	54.61			43.16	39.61	6.38	34.54	Peak	---	---

Note: The item 5 is on un-restricted band, so the limit is -20dB for the field strength of the fundamental emissions (see section 3.6.7).

Vertical

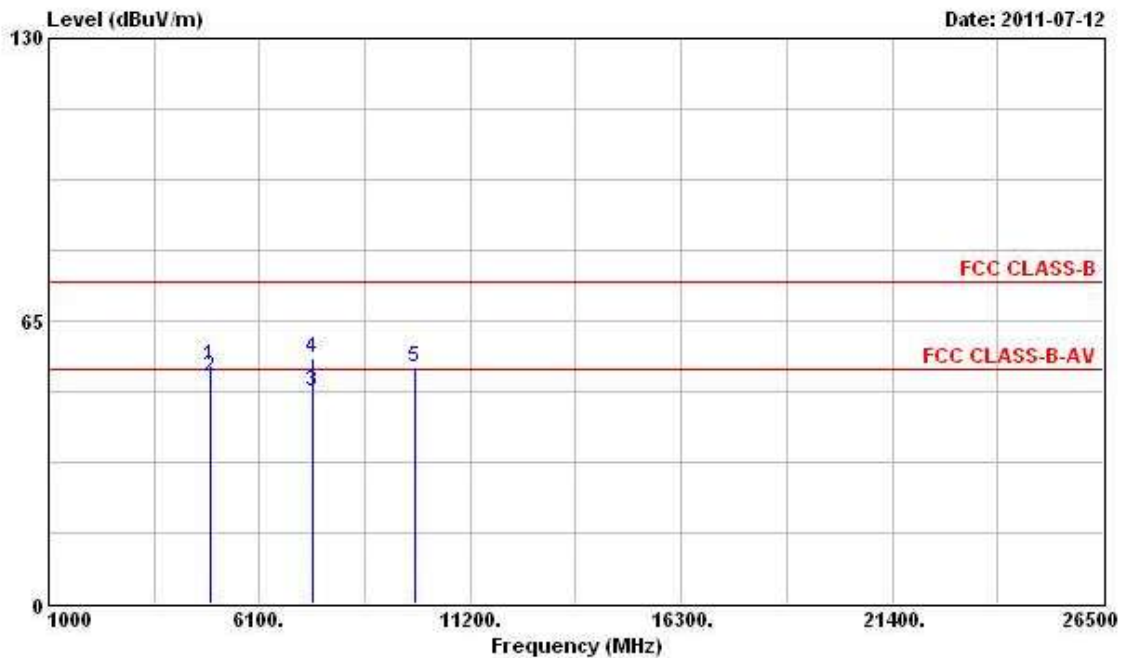

	Freq	Level	Over Limit	Limit Line	ReadAntenna Level	Antenna Factor	Cable Loss	Preamp Factor	Remark	Ant Pos	Table Pos
	MHz	dBuV/m	dB	dBuV/m	dBuV	dB/m	dB	dB		cm	deg
1	4924.000	54.69	-19.31	74.00	49.16	35.23	4.68	34.38	Peak	---	---
2	4924.000	52.28	-1.72	54.00	46.75	35.23	4.68	34.38	Average	---	---
3	7386.000	48.78	-5.22	54.00	40.46	36.96	5.65	34.29	Average	---	---
4	7386.000	56.45	-17.55	74.00	48.13	36.96	5.65	34.29	Peak	---	---
5	9848.000	54.47			43.82	38.81	6.38	34.54	Peak	---	---

Note: The item 5 is on un-restricted band, so the limit is -20dB for the field strength of the fundamental emissions (see section 3.6.7).

Final Test date	Jul. 12, 2011	Test Site No.	03CH02-HY
Temperature	23°C	Humidity	59%
Test Engineer	Streak	Configuration	802.11g Ch. 1

Horizontal

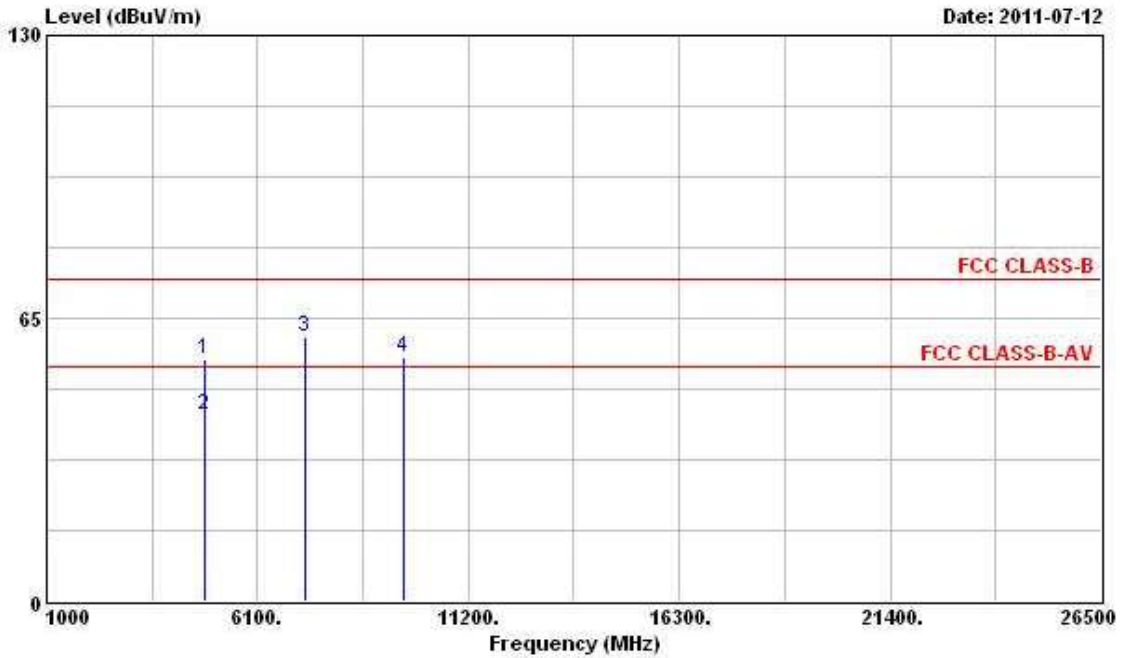

	Freq	Level	Over Limit	Limit Line	Read Level	Antenna Factor	Cable Loss	Preamp Factor	Remark	Ant Pos	Table Pos
	MHz	dBuV/m	dB	dBuV/m	dBuV	dB/m	dB	dB		cm	deg
1	4824.000	55.71	-18.29	74.00	49.88	35.76	4.58	34.51	Peak	---	---
2	4824.000	42.92	-11.08	54.00	37.09	35.76	4.58	34.51	Average	---	---
3	7236.000	60.73			51.54	37.85	5.63	34.29	Peak	---	---
4	9648.000	55.89			44.79	39.39	6.34	34.63	Peak	---	---

Note: The items 3 and 4 are on un-restricted band, so the limit is -20dB for the field strength of the fundamental emissions (see section 3.6.7).

Vertical

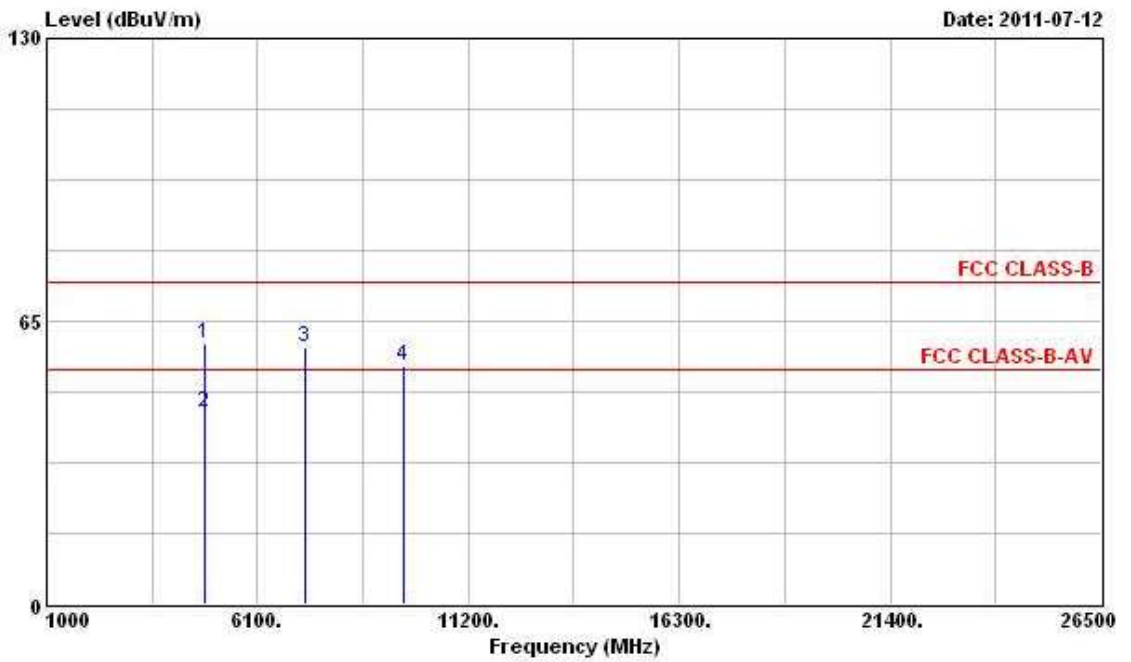

	Freq	Level	Over Limit	Limit Line	ReadAntenna Level	Antenna Factor	Cable Loss	Preamp Factor	Remark	Ant Pos	Table Pos
	MHz	dBuV/m	dB	dBuV/m	dBuV	dB/m	dB	dB		cm	deg
1	4824.000	59.86	-14.14	74.00	54.66	35.13	4.58	34.51	Peak	---	---
2	4824.000	44.11	-9.89	54.00	38.91	35.13	4.58	34.51	Average	---	---
3	7236.000	58.93			50.69	36.90	5.63	34.29	Peak	---	---
4	9648.000	54.94			44.64	38.59	6.34	34.63	Peak	---	---

Note: An item 3 and 4 are on un-restricted band, so the limit is -20dB for the field strength of the fundamental emissions (see section 3.6.7).

Final Test date	Jul. 12, 2011	Test Site No.	03CH02-HY
Temperature	23°C	Humidity	59%
Test Engineer	Streak	Configuration	802.11g Ch. 6

Horizontal

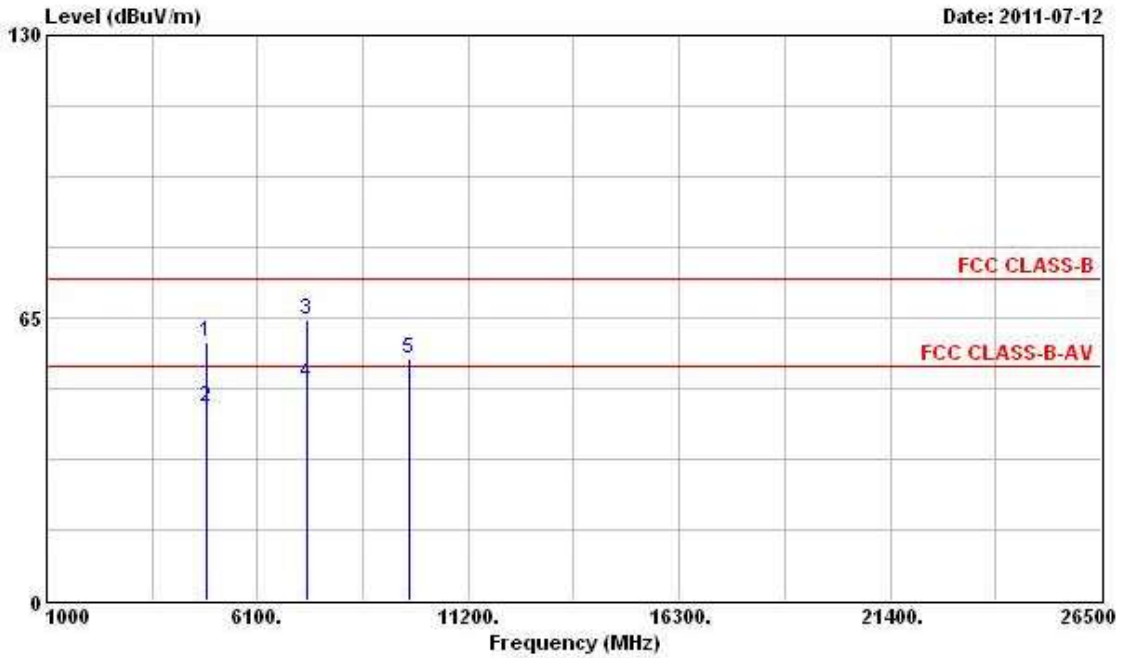

	Freq	Level	Over Limit	Limit Line	Read Level	Antenna Factor	Cable Loss	Preamp Factor	Remark	Ant Pos	Table Pos
	MHz	dBuV/m	dB	dBuV/m	dBuV	dB/m	dB	dB		cm	deg
1	4874.000	59.37	-14.63	74.00	53.38	35.83	4.61	34.45	Peak	---	---
2	4874.000	44.39	-9.61	54.00	38.40	35.83	4.61	34.45	Average	---	---
3	7311.000	64.47	-9.53	74.00	55.26	37.86	5.64	34.29	Peak	---	---
4	7311.000	50.12	-3.88	54.00	40.91	37.86	5.64	34.29	Average	---	---
5	9748.000	55.40			44.11	39.51	6.36	34.58	Peak	---	---

Note: The item 5 is on un-restricted band, so the limit is -20dB for the field strength of the fundamental emissions (see section 3.6.7).

Vertical

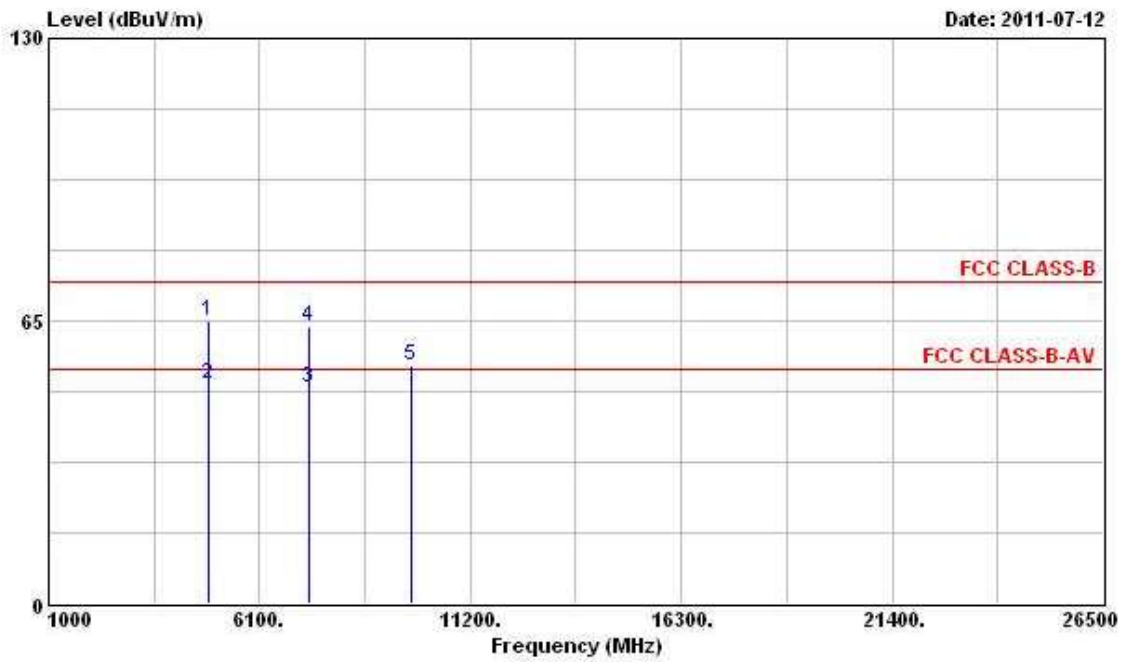

	Freq	Level	Over Limit	Limit Line	ReadAntenna Level	Antenna Factor	Cable Loss	Preamp Factor	Remark	Ant Pos	Table Pos
	MHz	dBuV/m	dB	dBuV/m	dBuV	dB/m	dB	dB		cm	deg
1	4874.000	64.94	-9.06	74.00	59.60	35.18	4.61	34.45	Peak	---	---
2	4874.000	50.28	-3.72	54.00	44.94	35.18	4.61	34.45	Average	---	---
3	7311.000	49.63	-4.37	54.00	41.36	36.92	5.64	34.29	Average	---	---
4	7311.000	63.62	-10.38	74.00	55.35	36.92	5.64	34.29	Peak	---	---
5	9748.000	54.79			44.30	38.71	6.36	34.58	Peak	---	---

Note: The item 5 is on un-restricted band, so the limit is -20dB for the field strength of the fundamental emissions (see section 3.6.7).

Final Test date	Jul. 12, 2011	Test Site No.	03CH02-HY
Temperature	23°C	Humidity	59%
Test Engineer	Streak	Configuration	802.11g Ch. 11

Horizontal

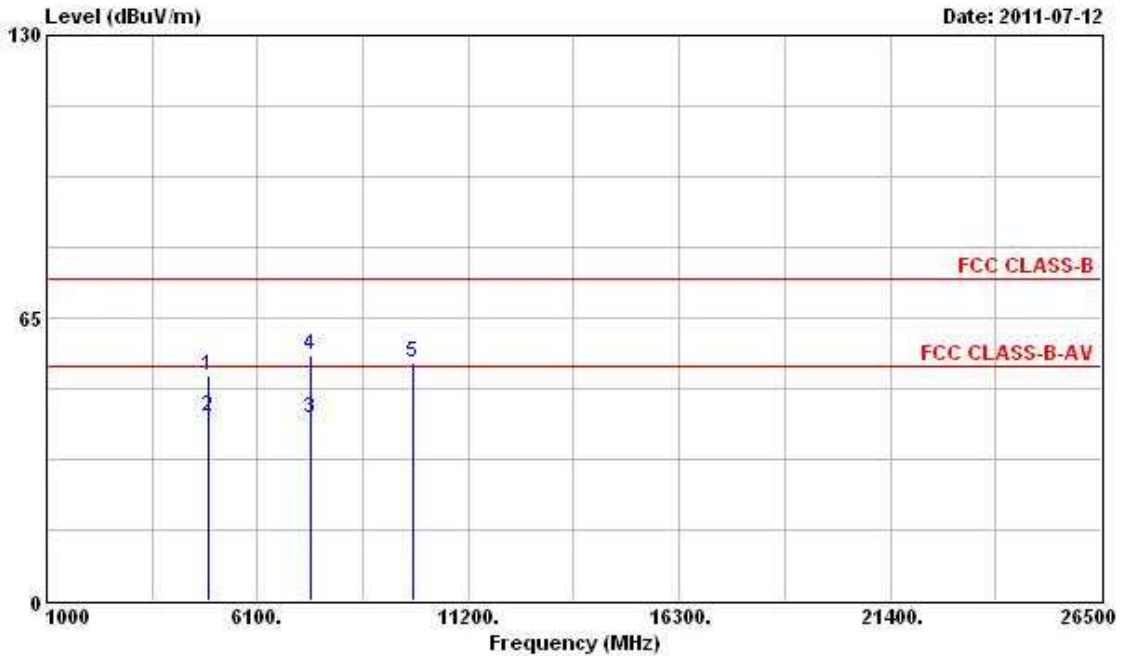

	Freq	Level	Over Limit	Limit Line	Read Level	Antenna Factor	Cable Loss	Preamp Factor	Remark	Ant Pos	Table Pos
	MHz	dBuV/m	dB	dBuV/m	dBuV	dB/m	dB	dB		cm	deg
1	4924.000	51.56	-22.44	74.00	45.36	35.90	4.68	34.38	Peak	---	---
2	4924.000	42.50	-11.50	54.00	36.30	35.90	4.68	34.38	Average	---	---
3	7386.000	41.85	-12.15	54.00	32.61	37.88	5.65	34.29	Average	---	---
4	7386.000	56.37	-17.63	74.00	47.13	37.88	5.65	34.29	Peak	---	---
5	9848.000	54.69			43.24	39.61	6.38	34.54	Peak	---	---

Note: The item 5 is on un-restricted band, so the limit is -20dB for the field strength of the fundamental emissions (see section 3.6.7).



Vertical

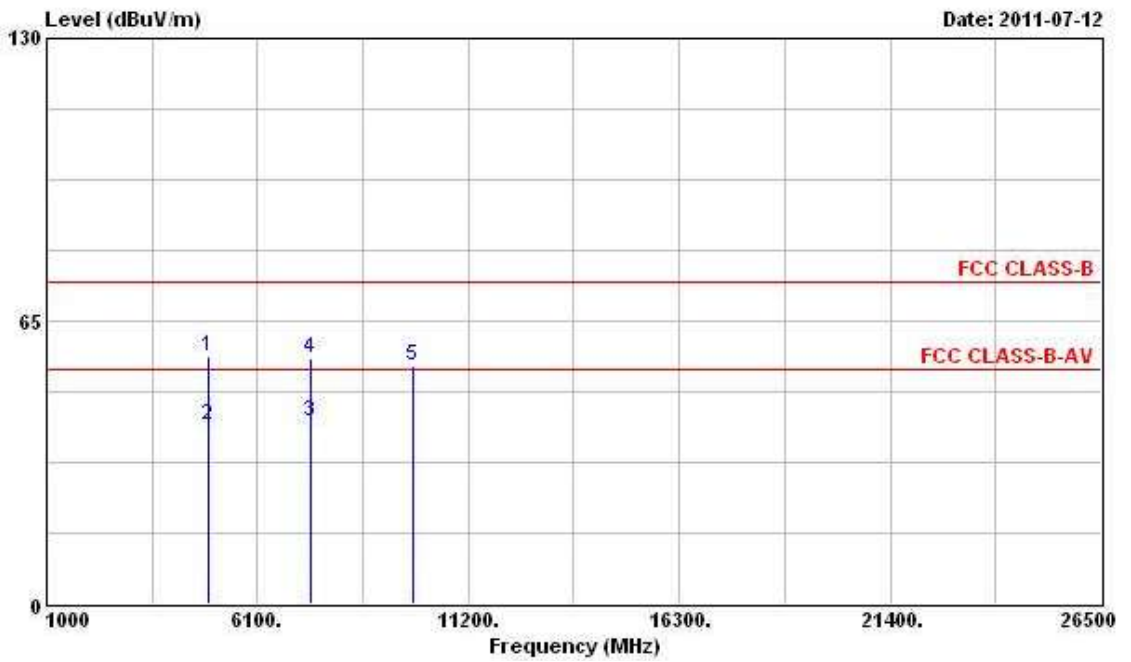

	Freq	Level	Over Limit	Limit Line	ReadAntenna Level	Antenna Factor	Cable Loss	Preamp Factor	Remark	Ant Pos	Table Pos
	MHz	dBuV/m	dB	dBuV/m	dBuV	dB/m	dB	dB		cm	deg
1	4924.000	56.83	-17.17	74.00	51.30	35.23	4.68	34.38	Peak	---	---
2	4924.000	41.23	-12.77	54.00	35.70	35.23	4.68	34.38	Average	---	---
3	7386.000	42.09	-11.91	54.00	33.77	36.96	5.65	34.29	Average	---	---
4	7386.000	56.53	-17.47	74.00	48.21	36.96	5.65	34.29	Peak	---	---
5	9848.000	54.66			44.01	38.81	6.38	34.54	Peak	---	---

Note: The item 5 is on un-restricted band, so the limit is -20dB for the field strength of the fundamental emissions (see section 3.6.7).

Emission level (dBuV/m) = 20 log Emission level (uV/m).

Corrected Reading: Antenna Factor + Cable Loss + Read Level - Preamp Factor = Level.

**3.6 Band Edge and Fundamental Emissions Measurement**

**3.6.1 Limit**

20dBc in any 100 kHz bandwidth outside the operating frequency band. In case the emission fall within the restricted band specified on 15.205(a), then the 15.209(a) limit in the table below has to be followed.

<b>Frequencies (MHz)</b>	<b>Field Strength (micorvolts/meter)</b>	<b>Measurement Distance (meters)</b>
0.009~0.490	2400/F(KHz)	300
0.490~1.705	24000/F(KHz)	30
1.705~30.0	30	30
30~88	100	3
88~216	150	3
216~960	200	3
Above 960	500	3

**3.6.2 Measuring Instruments and Setting**

Please refer to section 4 of equipments list in this report. The following table is the setting of the spectrum analyzer.

<b>Spectrum Parameter</b>	<b>Setting</b>
Attenuation	Auto
Span Frequency	100 MHz
RB / VB (Emission in restricted band)	1MHz / 1MHz for Peak, 1 MHz / 10Hz for Average
RB / VB (Emission in non-restricted band)	100 KHz /100 KHz for Peak

**3.6.3 Test Procedures**

1. The test procedure is the same as section 3.5.3; only the frequency range investigated is limited to 100MHz around band edges.
2. In case the emission is fail due to the used RB/VB is too wide, marker-delta method of FCC Public Notice DA00-705 will be followed.

**3.6.4 Test Setup Layout**

This test setup layout is the same as that shown in section 3.5.4.

**3.6.5 Test Deviation**

There is no deviation with the original standard.

**3.6.6 EUT Operation during Test**

The EUT was programmed to be in continuously transmitting mode.

3.6.7 Test Result of Band Edge and Fundamental Emissions

<b>Final Test date</b>	Jul. 11, 2011	<b>Test Site No.</b>	03CH02-HY
<b>Temperature</b>	23°C	<b>Humidity</b>	59%
<b>Test Engineer</b>	Streak	<b>Configuration</b>	802.11b Ch. 1, 6, 11

Channel 1

	Freq	Level	Over Limit	Limit Line	ReadAntenna Level	Antenna Factor	Cable Loss	Preamp Factor	Remark	Ant Pos	Table Pos
	MHz	dBuV/m	dB	dBuV/m	dBuV	dB/m	dB	dB		cm	deg
1	2331.660	62.60	-11.40	74.00	27.86	31.78	2.96	0.00	Peak	---	---
2 @	2413.170	114.41			79.30	32.09	3.02	0.00	Peak	---	---
1	2385.810	49.62	-4.38	54.00	14.57	32.03	3.02	0.00	Average	---	---
2 @	2412.410	109.47			74.36	32.09	3.02	0.00	Average	---	---

The item 2 is Fundamental Emissions.

Channel 6

	Freq	Level	Over Limit	Limit Line	ReadAntenna Level	Antenna Factor	Cable Loss	Preamp Factor	Remark	Ant Pos	Table Pos
	MHz	dBuV/m	dB	dBuV/m	dBuV	dB/m	dB	dB		cm	deg
1 @	2438.060	113.63			78.37	32.21	3.05	0.00	Peak	---	---
1 @	2437.490	108.98			73.72	32.21	3.05	0.00	Average	---	---

The item 1 is Fundamental Emissions.

Channel 11

	Freq	Level	Over Limit	Limit Line	ReadAntenna Level	Antenna Factor	Cable Loss	Preamp Factor	Remark	Ant Pos	Table Pos
	MHz	dBuV/m	dB	dBuV/m	dBuV	dB/m	dB	dB		cm	deg
1 @	2460.860	114.26			78.93	32.28	3.05	0.00	Peak	---	---
2	2483.850	63.01	-10.99	74.00	27.59	32.34	3.08	0.00	Peak	---	---
1 @	2461.050	109.58			74.25	32.28	3.05	0.00	Average	---	---
2	2483.500	52.13	-1.87	54.00	16.71	32.34	3.08	0.00	Average	---	---

The item 1 is Fundamental Emissions.

Note:

Emission level (dBuV/m) = 20 log Emission level (uV/m).

Corrected Reading: Antenna Factor + Cable Loss + Read Level - Preamp Factor = Level.

Final Test date	Jul. 11, 2011	Test Site No.	03CH02-HY
Temperature	23°C	Humidity	59%
Test Engineer	Streak	Configuration	802.11g Ch. 1, 6, 11

**Channel 1**

	Freq	Level	Over Limit	Limit Line	ReadAntenna Level	Antenna Factor	Cable Loss	Preamp Factor	Remark	Ant Pos	Table Pos
	MHz	dBuV/m	dB	dBuV/m	dBuV	dB/m	dB	dB		cm	deg
1	2390.000	71.36	-2.64	74.00	36.31	32.03	3.02	0.00	Peak	---	---
2 @	2413.740	115.50			80.39	32.09	3.02	0.00	Peak	---	---
1	2390.000	52.72	-1.28	54.00	17.67	32.03	3.02	0.00	Average	---	---
2 @	2413.930	104.99			69.88	32.09	3.02	0.00	Average	---	---

The item 2 is Fundamental Emissions.

**Channel 6**

	Freq	Level	Over Limit	Limit Line	ReadAntenna Level	Antenna Factor	Cable Loss	Preamp Factor	Remark	Ant Pos	Table Pos
	MHz	dBuV/m	dB	dBuV/m	dBuV	dB/m	dB	dB		cm	deg
1 @	2438.820	117.43			82.17	32.21	3.05	0.00	Peak	---	---
1 @	2441.100	106.88			71.62	32.21	3.05	0.00	Average	---	---

The item 1 is Fundamental Emissions.

**Channel 11**

	Freq	Level	Over Limit	Limit Line	ReadAntenna Level	Antenna Factor	Cable Loss	Preamp Factor	Remark	Ant Pos	Table Pos
	MHz	dBuV/m	dB	dBuV/m	dBuV	dB/m	dB	dB		cm	deg
1 @	2463.900	111.63			76.27	32.28	3.08	0.00	Peak	---	---
2	2483.500	68.65	-5.35	74.00	33.23	32.34	3.08	0.00	Peak	---	---
1 @	2466.180	101.12			65.76	32.28	3.08	0.00	Average	---	---
2	2483.500	52.22	-1.78	54.00	16.80	32.34	3.08	0.00	Average	---	---

The item 1 is Fundamental Emissions.

Note:

Emission level (dBuV/m) = 20 log Emission level (uV/m).

Corrected Reading: Antenna Factor + Cable Loss + Read Level - Preamp Factor = Level.

For Emission not in Restricted Band

Final Test Date	Aug. 09, 2011	Test Site No.	TH01-HY
Temperature	28.2°C	Humidity	49%
Test Engineer	Ian	Configurations	802.11b/g

Low Band Edge Plot on Configuration IEEE 802.11b / 2412 MHz

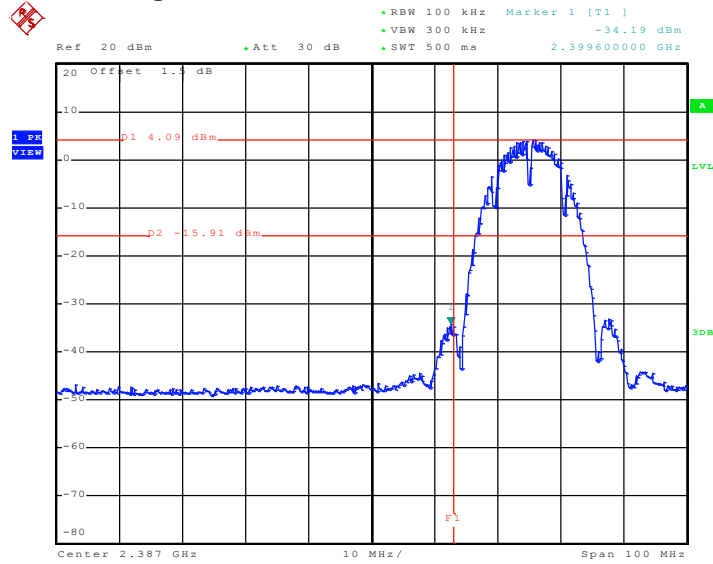

Date: 9.AUG.2011 15:35:28

High Band Edge Plot on Configuration IEEE 802.11b / 2462 MHz

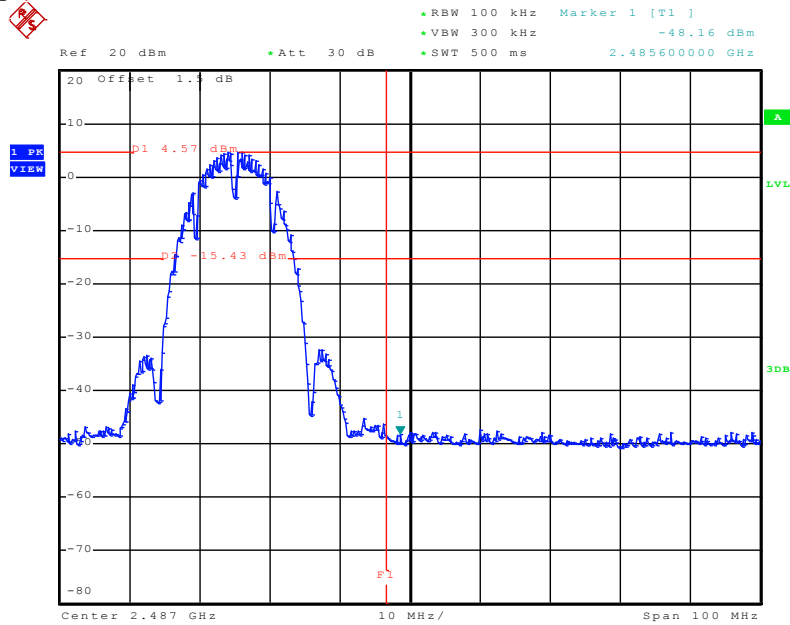

Date: 9.AUG.2011 15:48:15

Low Band Edge Plot on Configuration IEEE 802.11g / 2412 MHz

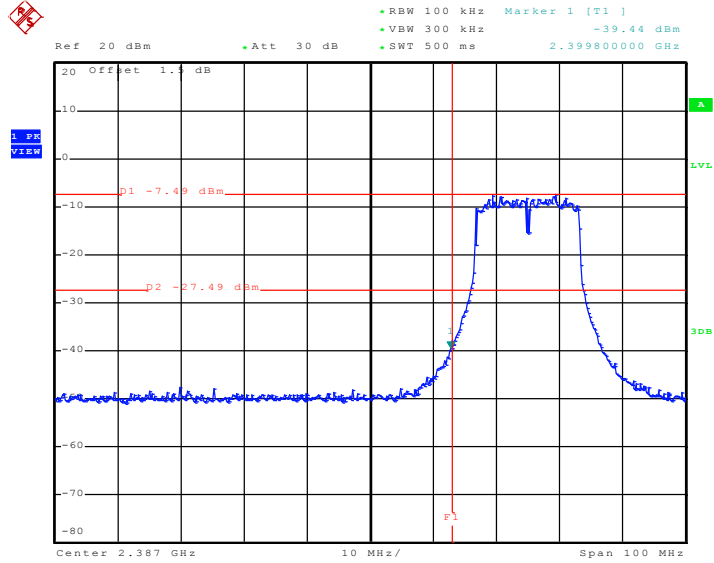

Date: 9.AUG.2011 15:54:11

High Band Edge Plot on Configuration IEEE 802.11g / 2462 MHz

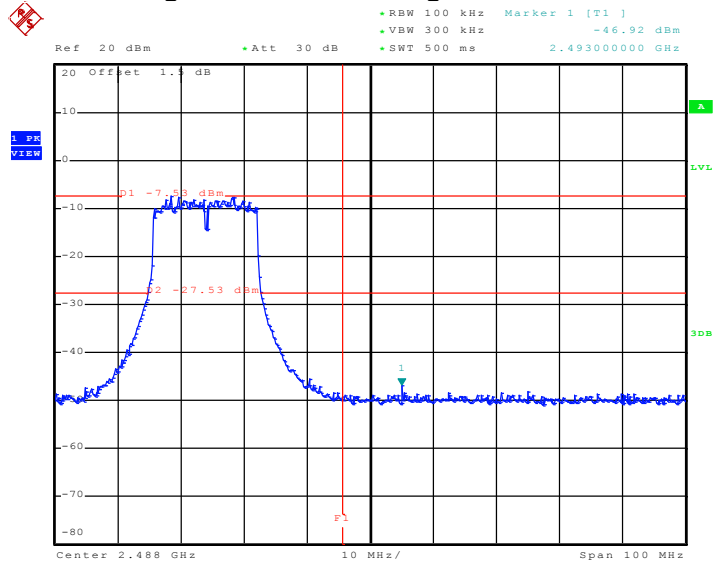

Date: 9.AUG.2011 16:01:53

### **3.7 Antenna Requirements**

#### **3.7.1 Limit**

Except for special regulations, the Low-power Radio-frequency Devices must not be equipped with any jacket for installing an antenna with extension cable. An intentional radiator shall be designed to ensure that no antenna other than that furnished by the responsible party shall be used with the device. The use of a permanently attached antenna or of an antenna that uses a unique coupling to the intentional radiator shall be considered sufficient to comply with the provisions of this Section. The manufacturer may design the unit so that the user can replace a broken antenna, but the use of a standard antenna jack or electrical connector is prohibited.

#### **3.7.2 Antenna Connector Construction**

Please refer to section 2.3 in this test report; antenna connector complied with the requirements.

**4 LIST OF MEASURING EQUIPMENTS**

Instrument	Manufacturer	Model No.	Serial No.	Characteristics	Calibration Date	Remark
EMC Receiver	R&S	ESCS 30	100174	9 kHz ~ 2.75 GHz	Apr. 20, 2011	Conduction (CO04-HY)
LISN	MessTec	NNB-2/16Z	99041	9 kHz ~ 30 MHz	Mar. 10, 2011	Conduction (CO04-HY)
LISN (Support Unit)	EMCO	3810/2NM	9703-1839	9 kHz ~ 30 MHz	May 04, 2011	Conduction (CO04-HY)
RF Cable-CON	HUBER+SUHNER	RG213/U	CB049	9 kHz ~ 30 MHz	Apr. 21, 2011	Conduction (CO04-HY)

Note: Calibration Interval of instruments listed above is one year.

Instrument	Manufacturer	Model No.	Serial No.	Characteristics	Calibration Date	Remark
Spectrum Analyzer	R&S	FSP 30	100023	9 KHz ~ 30 GHz	Mar. 15, 2011	Conducted (TH01-HY)
DC Power Source	G.W.	GPC-6030D	C671845	DC 1V ~ 60V	Jun. 03, 2011	Conducted (TH01-HY)
Temp. and Humidity Chamber	Giant Force	GTH-225-20-S	MAB0103-001	N/A	Oct. 22, 2010	Conducted (TH01-HY)
RF Cable-1m	Jye Bao	RG142	CB034-1m	20 MHz ~ 7 GHz	Dec. 02, 2010	Conducted (TH01-HY)
RF Cable-2m	Jye Bao	RG142	CB035-2m	20 MHz ~ 1 GHz	Dec. 02, 2010	Conducted (TH01-HY)
Signal Generator	R&S	SMR40	100116	10 MHz ~ 40 GHz	Jun. 07, 2011	Conducted (TH01-HY)
Power Sensor	Anritsu	MA2411B	0917017	300 MHz ~ 40 GHz	Jan. 06, 2011	Conducted (TH01-HY)
Power Meter	Anritsu	ML2495A	0949003	300 MHz ~ 40 GHz	Jan. 06, 2011	Conducted (TH01-HY)

Note: Calibration Interval of instruments listed above is one year.

Instrument	Manufacturer	Model No.	Serial No.	Characteristics	Calibration Date	Remark
AC Power Source	HPC	HPA-500W	HPA-9100024	AC 0 ~ 300V	Jun. 09, 2011*	Conducted (TH01-HY)

Note: Calibration Interval of instruments listed above is two year.



Instrument	Manufacturer	Model No.	Serial No.	Characteristics	Calibration Date	Remark
Spectrum Analyzer	R&S	FSP40	100305/040	9 kHz ~ 40 GHz	Feb. 11, 2011	Radiation (03CH02-HY)
3m Semi Anechoic Chamber	SIDT FRANKONIA	SAC-3M	03CH02-HY	30 MHz ~ 1 GHz 3m	May 11, 2011	Radiation (03CH02-HY)
Amplifier	Agilent	8447D	2944A11146	100 kHz ~ 1.3 GHz	Jul. 23, 2010	Radiation (03CH02-HY)
Amplifier	Agilent	8449B	3008A02373	1 GHz ~ 26.5 GHz	Jul. 23, 2010	Radiation (03CH02-HY)
Horn Antenna	ETS-LINDGREN	3117	00091920	1 GHz ~ 18 GHz	Nov. 11, 2010	Radiation (03CH02-HY)
RF Cable-R03m	Jye Bao	RG142	CB021	30 MHz ~ 1 GHz	Mar. 07, 2011	Radiation (03CH02-HY)
RF Cable-high	SUHNER	SUCOFLEX106	03CH02-HY	1 GHz ~ 40 GHz	Mar. 07, 2011	Radiation (03CH02-HY)
Bilog Antenna	SCHAFFNER	CBL61128	2723	30 MHz ~ 2 GHz	Oct. 16, 2010	Radiation (03CH02-HY)
Turn Table	HD	DS 420	420/649/00	0 - 360 degree	N/A	Radiation (03CH02-HY)
Antenna Mast	HD	MA 240	240/559/00	1 m - 4 m	N/A	Radiation (03CH02-HY)

Note: Calibration Interval of instruments listed above is one year.

Instrument	Manufacturer	Model No.	Serial No.	Characteristics	Calibration Date	Remark
Loop Antenna	R&S	HFH2-Z2	860004/001	9 kHz - 30 MHz	Jul. 29, 2010*	Radiation (03CH02-HY)

Note: Calibration Interval of instruments listed above is two year.

**5 TEST LOCATION**

SHIJR	ADD : 6Fl., No. 106, Sec. 1, Shintai 5th Rd., Shijr City, Taipei, Taiwan 221, R.O.C. TEL : 886-2-2696-2468 FAX : 886-2-2696-2255
HWA YA	ADD : No. 52, Hwa Ya 1st Rd., Kwei-Shan Hsiang, Tao Yuan Hsien, Taiwan, R.O.C. TEL : 886-3-327-3456 FAX : 886-3-318-0055
LINKOU	ADD : No. 30-2, Dingfu Tsuen, Linkou Shiang, Taipei, Taiwan 244, R.O.C TEL : 886-2-2601-1640 FAX : 886-2-2601-1695
DUNGHU	ADD : No. 3, Lane 238, Kangle St., Neihu Chiu, Taipei, Taiwan 114, R.O.C. TEL : 886-2-2631-4739 FAX : 886-2-2631-9740
JUNGHE	ADD : 7Fl., No. 758, Jungjeng Rd., Junghe City, Taipei, Taiwan 235, R.O.C. TEL : 886-2-8227-2020 FAX : 886-2-8227-2626
NEIHU	ADD : 4Fl., No. 339, Hsin Hu 2 <sup>nd</sup> Rd., Taipei 114, Taiwan, R.O.C. TEL : 886-2-2794-8886 FAX : 886-2-2794-9777
JHUBEI	ADD : No.8, Lane 724, Bo-ai St., Jhubei City, HsinChu County 302, Taiwan, R.O.C. TEL : 886-3-656-9065 FAX : 886-3-656-9085

## 6 TAF CERTIFICATE OF ACCREDITATION

  
Certificate No. : L1190-110111

**財團法人全國認證基金會**  
**Taiwan Accreditation Foundation**

**Certificate of Accreditation**

This is to certify that

**Sporton International Inc.**  
**EMC & Wireless Communications Laboratory**  
No.52, Hwa Ya 1st Rd., Hwa Ya Technology Park, Kwei-Shan Hsiang, Tao Yuan Hsien,  
Taiwan, R.O.C.

**is accredited in respect of laboratory**

<b>Accreditation Criteria</b>	: ISO/IEC 17025:2005
<b>Accreditation Number</b>	: 1190
<b>Originally Accredited</b>	: December 15, 2003
<b>Effective Period</b>	: January 10, 2010 to January 09, 2013
<b>Accredited Scope</b>	: Testing Field, see described in the Appendix
<b>Specific Accreditation Program</b>	: Accreditation Program for Designated Testing Laboratory for Commodities Inspection Accreditation Program for Telecommunication Equipment Testing Laboratory Accreditation Program for BSMI Mutual Recognition Arrangement with Foreign Authorities

  
Jay-San Chen  
President, Taiwan Accreditation Foundation  
Date : January 11, 2011

PI, total 24 pages