

FCC RADIO TEST REPORT

according to

47 CFR FCC Part 15 Subpart C § 15.247

Equipment : **Wireless Projector Server**
Model No. : **WP-S1300**
Brand Name : **EDIMAX**
Filing Type : **New Application**
Applicant : **EDIMAX TECHNOLOGY CO., LTD**
No.3, Wu Chuan 3rd Road, Wu-Ku
Industrial Park, Taipei Hsien, Taiwan
FCC ID : **NDD9513001020**
Manufacturer : **EDIMAX TECHNOLOGY CO., LTD**
No.3, Wu Chuan 3rd Road, Wu-Ku
Industrial Park, Taipei Hsien, Taiwan
Received Date : Aug. 17, 2010
Final Test Date : Sep. 13, 2010

Statement

Test result included is only for the 802.11n of the product.

The test result in this report refers exclusively to the presented test model / sample.

Without written approval of SPORTON International Inc., the test report shall not be reproduced except in full.

The measurements and test results shown in this test report were made in accordance with the procedures and found in compliance with the limit given in **ANSI C63.4-2003** and **47 CFR FCC Part 15 Subpart C**.

The test equipment used to perform the test is calibrated and traceable to NML/ROC.



SPORTON International Inc.

No. 52 Hwa Ya 1st Rd., Hwa Ya Technology Park, Kwei-Shan Hsiang, Tao Yuan Hsien, Taiwan, R.O.C.

Table of Contents

1 SUMMARY OF THE TEST RESULT 2

2 GENERAL INFORMATION..... 3

2.1 Product Details 3

2.2 Accessories 3

2.3 Table for Filed Antenna 3

2.4 Table for Carrier Frequencies 4

2.5 Table for Test Modes 5

2.6 Table for Testing Locations 5

2.7 Table for Supporting Units..... 5

2.8 Table for Parameters of Test Software Setting 6

2.9 EUT Operation during Test 6

2.10 Test Configuration 7

3 TEST RESULT 9

3.1 AC Power Line Conducted Emissions Measurement..... 9

3.2 Maximum Conducted Output Power Measurement 13

3.3 Power Spectral Density Measurement 15

3.4 6dB Spectrum Bandwidth Measurement..... 21

3.5 Radiated Emissions Measurement..... 27

3.6 Band Edge and Fundamental Emissions Measurement 45

3.7 Antenna Requirements..... 50

4 LIST OF MEASURING EQUIPMENTS 51

5 TEST LOCATION..... 53

6 TAF CERTIFICATE OF ACCREDITATION 54

APPENDIX A. MAXIMUM PERMISSIBLE EXPOSURE..... A1 ~ A3

APPENDIX B. TEST PHOTOS B1 ~ B6

APPENDIX C. PHOTOGRAPHS OF EUT C1 ~ C10

History of This Test Report

Original Issue Date: Sep. 21, 2010

Report No.: FR082508AI

No additional attachment.

Additional attachment were issued as following record:

| Attachment No. | Issue Date | Description |
|----------------|------------|-------------|
| | | |
| | | |
| | | |
| | | |
| | | |
| | | |
| | | |
| | | |
| | | |
| | | |
| | | |
| | | |
| | | |
| | | |
| | | |

CERTIFICATE OF COMPLIANCE

according to

47 CFR FCC Part 15 Subpart C § 15.247

Equipment : Wireless Projector Server
Model No. : WP-S1300
Brand Name : EDIMAX
Applicant : EDIMAX TECHNOLOGY CO., LTD
No.3, Wu Chuan 3rd Road, Wu-Ku
Industrial Park, Taipei Hsien, Taiwan

Sporton International as requested by the applicant to evaluate the EMC performance of the product sample received on Aug. 17, 2010 would like to declare that the tested sample has been evaluated and found to be in compliance with the tested rule parts. The data recorded as well as the test configuration specified is true and accurate for showing the sample's EMC nature.



Wayne Hsu / Vice Manager

SPORTON International Inc.

No. 52 Hwa Ya 1st Rd., Hwa Ya Technology Park, Kwei-Shan Hsiang, Tao Yuan Hsien, Taiwan, R.O.C.

1 SUMMARY OF THE TEST RESULT

| Applied Standard: 47 CFR FCC Part 15 Subpart C | | | | |
|---|---------------------|-----------------------------------|---------------|--------------------|
| Part | Rule Section | Description of Test | Result | Under Limit |
| 3.1 | 15.207 | AC Power Line Conducted Emissions | Complies | 9.24 dB |
| 3.2 | 15.247(b)(3) | Maximum Conducted Output Power | Complies | 14.43 dB |
| 3.3 | 15.247(e) | Power Spectral Density | Complies | 27.80 dB |
| 3.4 | 15.247(a)(2) | 6dB Spectrum Bandwidth | Complies | - |
| 3.5 | 15.247(d) | Radiated Emissions | Complies | 1.26 dB |
| 3.6 | 15.247(d) | Band Edge Emissions | Complies | 1.51 dB |
| 3.7 | 15.203 | Antenna Requirements | Complies | - |

| Test Items | Uncertainty | Remark |
|---|-----------------------|--------------------------|
| AC Power Line Conducted Emissions | ±2.3dB | Confidence levels of 95% |
| Maximum Peak Conducted Output Power | ±0.8dB | Confidence levels of 95% |
| Power Spectral Density | ±0.5dB | Confidence levels of 95% |
| 6dB Spectrum Bandwidth | ±8.5×10 ⁻⁸ | Confidence levels of 95% |
| Radiated Emissions (9kHz~30MHz) | ±0.8dB | Confidence levels of 95% |
| Radiated Emissions (30MHz~1000MHz) | ±1.9dB | Confidence levels of 95% |
| Radiated / Band Edge Emissions (1GHz~18GHz) | ±1.9dB | Confidence levels of 95% |
| Radiated Emissions (18GHz~40GHz) | ±1.9dB | Confidence levels of 95% |
| Temperature | ±0.7 | Confidence levels of 95% |
| Humidity | ±3.2% | Confidence levels of 95% |
| DC / AC Power Source | ±1.4% | Confidence levels of 95% |

2 GENERAL INFORMATION

2.1 Product Details

Only the radio detail of IEEE 802.11n is shown in this report. For more detailed features description, please refer to the manufacturer's specifications or user's manual.

| Items | Description |
|--------------------------|---|
| Power Type | 12V from Adapter |
| Modulation | See the below table for IEEE 802.11n |
| Data Modulation | OFDM (BPSK / QPSK / 16QAM / 64QAM) |
| Data Rate (Mbps) | See the below table for IEEE 802.11n |
| Frequency Range | 2400 ~ 2483.5MHz |
| Channel Number | 11 for 20MHz bandwidth ; 7 for 40MHz bandwidth |
| Channel Band Width (99%) | MCS 0 (20MHz) : 16.44 MHz ; MCS 0 (40MHz) : 35.84 MHz |
| Conducted Output Power | MCS 0 (20MHz) : 15.39 dBm ; MCS 0 (40MHz) : 15.57 dBm |

2.2 Accessories

| Power | Brand | Model | Rating |
|--|---------|------------|--|
| AC adapter | PHIHONG | PSA12A-120 | INPUT : 100-120V~50/60Hz 0.5A OUTPUT : 12V 1.0A |
| Other | | | |
| Remote controller / USB cable / IR receiver extension cord | | | |

2.3 Table for Filed Antenna

| Ant. | Antenna Type | Connector | Gain (dBi) | Remark |
|------|----------------|----------------|------------|---------|
| A | Dipole Antenna | Fixed on Board | 2.00 | TX / RX |
| B | Dipole Antenna | Fixed on Board | 2.00 | RX |

Note: The antennas are 1T2R spatial Multiplexing MIMO configuration.

IEEE 802.11n Modulation Scheme

| MCS Index | Nss | Modulation | R | NBPS | NCBPS | | NDBPS | | Data rate(Mbps) | |
|-----------|-----|------------|-----|------|-------|-------|-------|-------|-----------------|-------|
| | | | | | | | | | 800nsGI | |
| | | | | | 20MHz | 40MHz | 20MHz | 40MHz | 20MHz | 40MHz |
| 0 | 1 | BPSK | 1/2 | 1 | 52 | 108 | 26 | 54 | 6.5 | 13.5 |
| 1 | 1 | QPSK | 1/2 | 2 | 104 | 216 | 52 | 108 | 13.0 | 27.0 |
| 2 | 1 | QPSK | 3/4 | 2 | 104 | 216 | 78 | 162 | 19.5 | 40.5 |
| 3 | 1 | 16-QAM | 1/2 | 4 | 208 | 432 | 104 | 216 | 26.0 | 54.0 |
| 4 | 1 | 16-QAM | 3/4 | 4 | 208 | 432 | 156 | 324 | 39.0 | 81.0 |
| 5 | 1 | 64-QAM | 2/3 | 6 | 312 | 648 | 208 | 432 | 52.0 | 108.0 |
| 6 | 1 | 64-QAM | 3/4 | 6 | 312 | 648 | 234 | 486 | 58.5 | 121.5 |
| 7 | 1 | 64-QAM | 5/6 | 6 | 312 | 648 | 260 | 540 | 65.0 | 135.0 |

| Symbol | Explanation |
|--------|---|
| NSS | Number of spatial streams |
| R | Code rate |
| NBPS | Number of coded bits per single carrier |
| NCBPS | Number of coded bits per symbol |
| NDBPS | Number of data bits per symbol |
| GI | guard interval |

2.4 Table for Carrier Frequencies

There are two bandwidth systems for IEEE 802.11n.

For 20MHz bandwidth systems, use Channel 1~Channel 11.

For 40MHz bandwidth systems, use Channel 3~Channel 9.

| Frequency Band | Channel No. | Frequency | Channel No. | Frequency |
|----------------|-------------|-----------|-------------|-----------|
| 2400~2483.5MHz | 1 | 2412 MHz | 7 | 2442 MHz |
| | 2 | 2417 MHz | 8 | 2447 MHz |
| | 3 | 2422 MHz | 9 | 2452 MHz |
| | 4 | 2427 MHz | 10 | 2457 MHz |
| | 5 | 2432 MHz | 11 | 2462 MHz |
| | 6 | 2437 MHz | - | - |

2.5 Table for Test Modes

Preliminary tests were performed in different data rate to find the worst radiated emission. The data rate shown in the table below is the worst-case rate with respect to the specific test item. Investigation has been done on the entire possible configuration for searching the worst cases. The following table is a list of the test modes shown in this test report.

| Test Items | Mode | Data Rate | Channel |
|-----------------------------------|---------------|-----------|---------|
| AC Power Line Conducted Emissions | Normal Mode | Auto | - |
| Maximum Conducted Output Power | MCS 0 (20MHz) | 13 Mbps | 1/6/11 |
| Power Spectral Density | MCS 0 (40MHz) | 27 Mbps | 3/6/9 |
| 6dB Spectrum Bandwidth | | | |
| Radiated Emissions Above 1GHz | | | |
| Radiated Emissions 9kHz~1GHz | Normal Mode | Auto | - |
| Band Edge Emissions | MCS 0 (20MHz) | 13 Mbps | 1/6/11 |
| | MCS 0 (40MHz) | 27 Mbps | 3/6/9 |

2.6 Table for Testing Locations

| Test Site No. | Site Category | Location |
|---------------|---------------|----------|
| CO01-LK | Conduction | Lin Kou |
| TH01-HY | OVEN Room | Hwa Ya |
| 03CH02-HY | SAC | Hwa Ya |

Semi Anechoic Chamber (SAC).

2.7 Table for Supporting Units

| Support Unit | Brand | Model | FCC ID | Remark |
|----------------------------------|--------|------------|--------|-----------|
| LCD Monitor | DELL | E198WFPf | DoC | Conducted |
| Printer | HP | C2642A | DoC | |
| Modem | ACEEX | DM1414 | DoC | |
| Mic+Earphone | i-Acon | HOH-323-BK | DoC | |
| Personal Computer | DELL | DCTA | DoC | |
| USB Keyboard | DELL | SK-8175 | DoC | |
| USB Mouse x2 | DELL | MOC5UO | DoC | |
| Remote Control | - | - | - | |
| Notebook (Remote workstation) | HP | 541 | | |
| Notebook | DELL | PP01L | N/A | Radiated |

2.8 Table for Parameters of Test Software Setting

During testing, Channel & Power Controlling Software provided by the customer was used to control the operating channel as well as the output power level. The RF output power selection is for the setting of RF output power expected by the customer and is going to be fixed on the firmware of the final end product.

Power Parameters of IEEE 802.11n

| Test Software Version | Ralink RT2880 QA | | |
|-----------------------|------------------|----------|----------|
| Frequency | 2412 MHz | 2437 MHz | 2462 MHz |
| IEEE 802.11n(20MHz) | 7 | 8 | 7 |
| Frequency | 2422 MHz | 2437 MHz | 2452 MHz |
| IEEE 802.11n(40MHz) | 8 | 8 | 8 |

2.9 EUT Operation during Test

Conducted

An executive program, "EMCTEST.EXE" under WIN XP, which generates a complete line of continuously repeating "H" pattern was used as the test software.

The program was executed as follows :

- a. Turn on the power of all equipment.
- b. The PC reads the test program from the hard disk drive and runs it.
- c. The PC sends "H" messages to the monitor, and the monitor displays "H" patterns on the screen.
- d. The PC sends "H" messages to the printer, then the printer prints them on the paper.
- e. The PC sends signal messages to the modem.
- f. The PC sends signal messages to the internal Hard Disk, and the Hard Disk reads and writes the message.
- g. Repeat the steps from c to f.

At the same time, "PING.EXE" was executed to link with the remote workstation to receive and transmit data by LAN cable and WiFi.

Radiated

- Executed "Ralink RT2880 QA" to keep transmitting signals at fixed frequency.

2.10 Test Configuration

2.10.1 Radiation Emissions Test Configuration

For radiated emissions 9kHz~1GHz

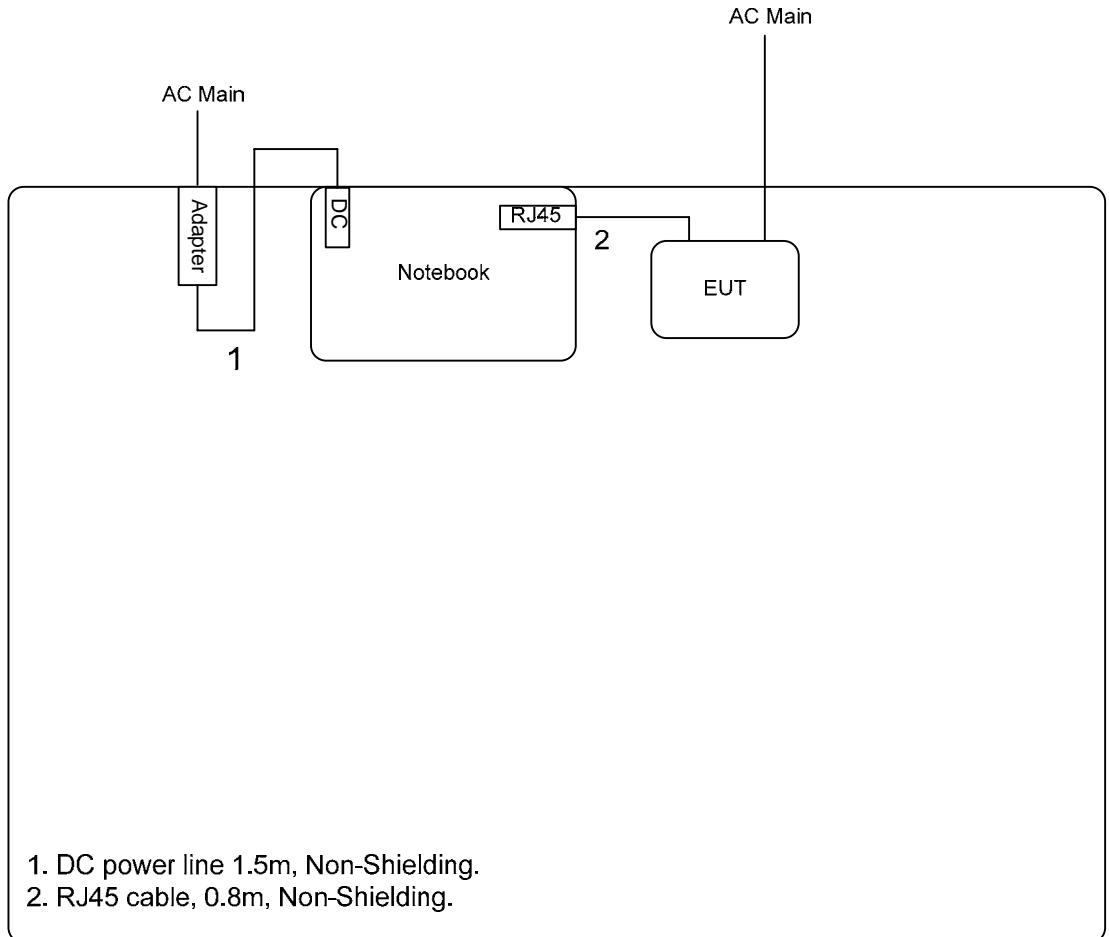

For radiated emissions above 1GHz

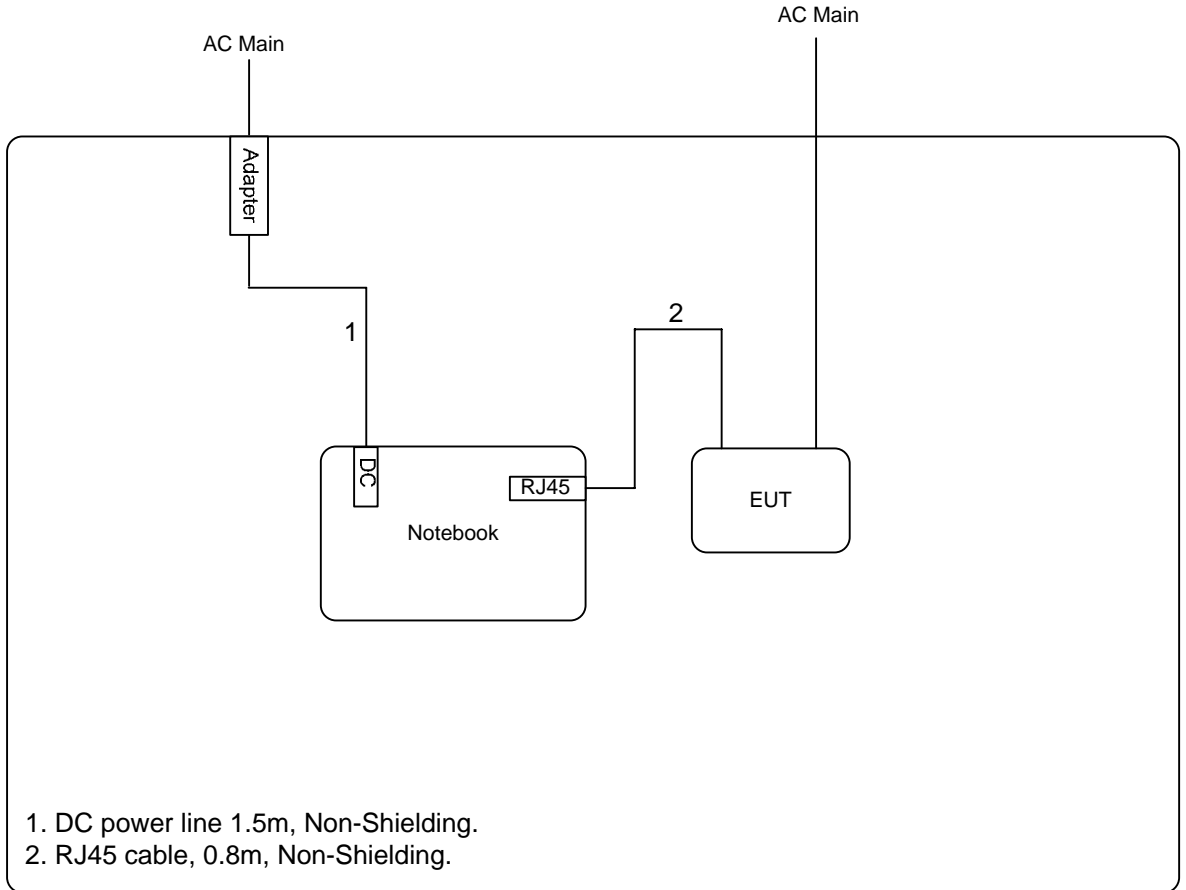

3 TEST RESULT

3.1 AC Power Line Conducted Emissions Measurement

3.1.1 Limit

For this product which is designed to be connected to the AC power line, the radio frequency voltage that is conducted back onto the AC power line on any frequency or frequencies within the band 150 kHz to 30 MHz shall not exceed below limits table.

Class B

| Frequency (MHz) | QP Limit (dBuV) | AV Limit (dBuV) |
|-----------------|-----------------|-----------------|
| 0.15~0.5 | 66~56 | 56~46 |
| 0.5~5 | 56 | 46 |
| 5~30 | 60 | 50 |

3.1.2 Measuring Instruments and Setting

Please refer to section 4 of equipments list in this report. The following table is the setting of the receiver.

| Receiver Parameters | Setting |
|---------------------|----------|
| Attenuation | 10 dB |
| Start Frequency | 0.15 MHz |
| Stop Frequency | 30 MHz |
| IF Bandwidth | 9 KHz |

3.1.3 Test Procedures

1. The EUT warm up about 15 minutes then start test.
2. Configure the EUT according to ANSI C63.4. The EUT or host of EUT has to be placed 0.4 meter far from the conducting wall of the shielding room and at least 80 centimeters from any other grounded conducting surface.
3. Connect EUT or host of EUT to the power mains through a line impedance stabilization network (LISN).
4. All the support units are connected to the other LISNs. The LISN should provide 50uH/50ohms coupling impedance.
5. The frequency range from 150 KHz to 30 MHz was searched.
6. Set the test-receiver system to Peak Detect Function and Specified Bandwidth with Maximum Hold Mode.
7. The measurement has to be done between each power line and ground at the power terminal.

3.1.4 Test Setup Layout

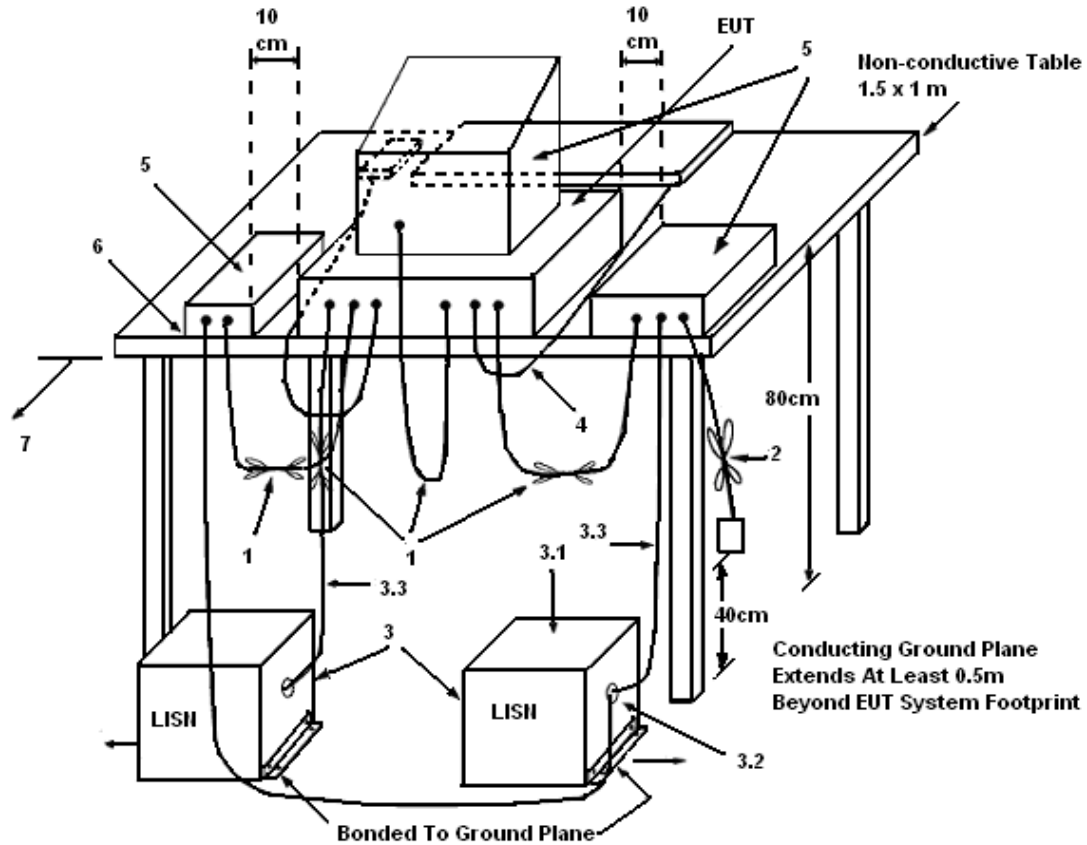

LEGEND:

- (1) Interconnecting cables that hang closer than 40 cm to the ground plane shall be folded back and forth in the center forming a bundle 30 to 40 cm long.
- (2) I/O cables that are not connected to a peripheral shall be bundled in the center. The end of the cable may be terminated, if required, using the correct terminating impedance. The overall length shall not exceed 1 m.
- (3) EUT connected to one LISN. Unused LISN measuring port connectors shall be terminated in 50 Ω. LISN can be placed on top of, or immediately beneath, reference ground plane.
 - (3.1) All other equipment powered from additional LISN(s).
 - (3.2) Multiple outlet strip can be used for multiple power cords of non-EUT equipment.
 - (3.3) LISN at least 80 cm from nearest part of EUT chassis.
- (4) Cables of hand-operated devices, such as keyboards, mice, etc., shall be placed as for normal use.
- (5) Non-EUT components of EUT system being tested.
- (6) Rear of EUT, including peripherals, shall all be aligned and flush with rear of tabletop.
- (7) Rear of tabletop shall be 40 cm removed from a vertical conducting plane that is bonded to the ground plane.

3.1.5 Test Deviation

There is no deviation with the original standard.

3.1.6 EUT Operation during Test

The EUT was placed on the test table and programmed in normal function.

3.1.7 Results of AC Power Line Conducted Emissions Measurement

| | | | |
|-----------------|---------------|---------------|-------------|
| Final Test Date | Sep. 13, 2010 | Test Site No. | CO01-LK |
| Temperature | 24 | Humidity | 51% |
| Test Engineer | Eddie | Configuration | Normal Mode |

Line

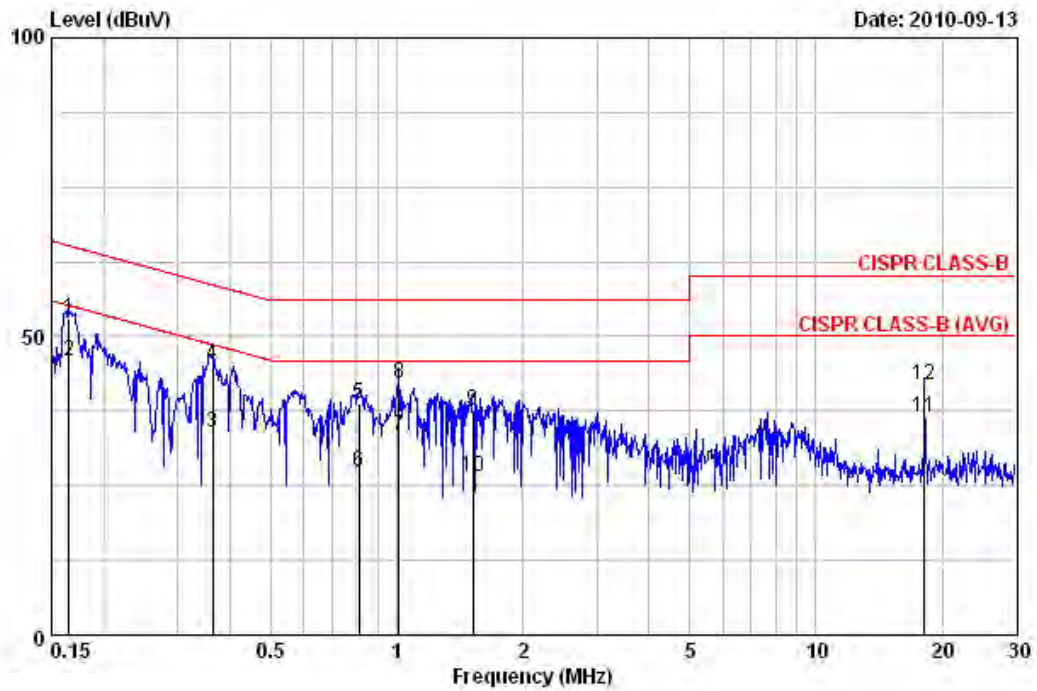

| | Freq | Level | Over Limit | Limit Line | Read Level | LISN Factor | Cable Loss | Remark |
|----|--------|-------|------------|------------|------------|-------------|------------|---------|
| | MHz | dBuV | dB | dBuV | dBuV | dB | dB | |
| 1 | 0.165 | 53.11 | -12.10 | 65.21 | 42.32 | 10.69 | 0.10 | QP |
| 2 | 0.165 | 45.97 | -9.24 | 55.21 | 35.18 | 10.69 | 0.10 | AVERAGE |
| 3 | 0.363 | 33.76 | -14.89 | 48.65 | 23.02 | 10.65 | 0.10 | AVERAGE |
| 4 | 0.363 | 45.18 | -13.47 | 58.65 | 34.44 | 10.65 | 0.10 | QP |
| 5 | 0.813 | 38.61 | -17.39 | 56.00 | 27.88 | 10.63 | 0.10 | QP |
| 6 | 0.813 | 27.24 | -18.76 | 46.00 | 16.51 | 10.63 | 0.10 | AVERAGE |
| 7 | 1.010 | 33.23 | -12.77 | 46.00 | 22.50 | 10.63 | 0.10 | AVERAGE |
| 8 | 1.010 | 42.30 | -13.70 | 56.00 | 31.57 | 10.63 | 0.10 | QP |
| 9 | 1.519 | 37.50 | -18.50 | 56.00 | 26.70 | 10.64 | 0.16 | QP |
| 10 | 1.519 | 26.60 | -19.40 | 46.00 | 15.80 | 10.64 | 0.16 | AVERAGE |
| 11 | 18.124 | 36.55 | -13.45 | 50.00 | 25.45 | 10.83 | 0.27 | AVERAGE |
| 12 | 18.124 | 41.93 | -18.07 | 60.00 | 30.83 | 10.83 | 0.27 | QP |

Neutral

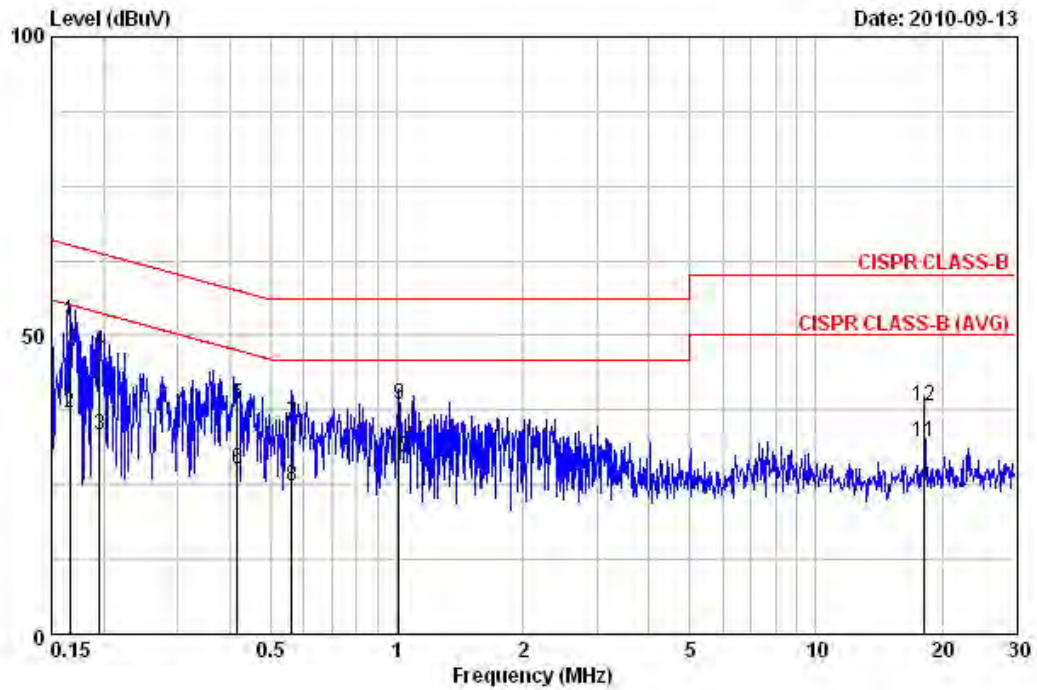

| | Freq | Level | Over Limit | Limit Line | Read Level | LISN Factor | Cable Loss | Remark |
|----|--------|-------|------------|------------|------------|-------------|------------|---------|
| | MHz | dBuV | dB | dBuV | dBuV | dB | dB | |
| 1 | 0.166 | 52.56 | -12.61 | 65.16 | 42.23 | 10.23 | 0.10 | QP |
| 2 | 0.166 | 37.08 | -18.09 | 55.16 | 26.75 | 10.23 | 0.10 | AVERAGE |
| 3 | 0.195 | 33.20 | -20.60 | 53.80 | 22.87 | 10.23 | 0.10 | AVERAGE |
| 4 | 0.195 | 47.34 | -16.46 | 63.80 | 37.01 | 10.23 | 0.10 | QP |
| 5 | 0.417 | 38.38 | -19.13 | 57.51 | 28.05 | 10.22 | 0.10 | QP |
| 6 | 0.417 | 27.64 | -19.87 | 47.51 | 17.31 | 10.22 | 0.10 | AVERAGE |
| 7 | 0.561 | 35.45 | -20.55 | 56.00 | 25.13 | 10.22 | 0.10 | QP |
| 8 | 0.561 | 24.72 | -21.28 | 46.00 | 14.40 | 10.22 | 0.10 | AVERAGE |
| 9 | 1.010 | 38.40 | -17.60 | 56.00 | 28.07 | 10.23 | 0.10 | QP |
| 10 | 1.010 | 29.67 | -16.33 | 46.00 | 19.34 | 10.23 | 0.10 | AVERAGE |
| 11 | 18.127 | 32.17 | -17.83 | 50.00 | 21.43 | 10.48 | 0.27 | AVERAGE |
| 12 | 18.127 | 38.26 | -21.74 | 60.00 | 27.52 | 10.48 | 0.27 | QP |

Note:

Level = Read Level + LISN Factor + Cable Loss.

3.2 Maximum Conducted Output Power Measurement

3.2.1 Limit

For systems using digital modulation in the 2400-2483.5MHz, the limit for peak output power is 30dBm. The limited has to be reduced by the amount in dB that the gain of the antenna exceed 6dBi. In case of point-to-multipoint antenna reduction operation, the limit has to be reduced by 1dB for every dB that the directional gain of the antenna exceeds 6dBi. Systems operating in the 5725-5850 MHz band that are used exclusively for fixed, point-to-point operations may employ transmitting antennas with directional gain greater than 6 dBi without any corresponding reduction in transmitter conducted output power.

3.2.2 Measuring Instruments and Setting

Please refer to section 4 of equipments list in this report. The following table is the setting of the power meter.

| Power Meter Parameter | Setting |
|------------------------------|----------------|
| Filter No. | Auto |
| Measurement time | 0.135 s ~ 26 s |
| Used Peak Sensor | MA2411B |

3.2.3 Test Procedures

1. The transmitter output (antenna port) was connected to the power meter.
2. Turn on the EUT and power meter and then record the peak power value.
3. Repeat above procedures on all channels needed to be tested.

3.2.4 Test Setup Layout

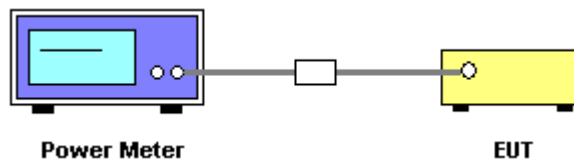

3.2.5 Test Deviation

There is no deviation with the original standard.

3.2.6 EUT Operation during Test

The EUT was programmed to be in continuously transmitting mode.

3.2.7 Test Result of Maximum Conducted Output Power

| | | | |
|------------------------|---------------|----------------------|---------|
| Final Test Date | Aug. 17, 2010 | Test Site No. | TH01-HY |
| Temperature | 24 | Humidity | 60% |
| Test Engineer | Ian | Configuration | 802.11n |

Configuration of IEEE 802.11n (20MHz)

| Channel | Frequency | Conducted Power (dBm) | Max. Limit (dBm) | Result |
|---------|-----------|-----------------------|------------------|----------|
| 1 | 2412 MHz | 15.36 | 30.00 | Complies |
| 6 | 2437 MHz | 15.41 | 30.00 | Complies |
| 11 | 2462 MHz | 15.39 | 30.00 | Complies |

Configuration of IEEE 802.11n (40MHz)

| Channel | Frequency | Conducted Power (dBm) | Max. Limit (dBm) | Result |
|---------|-----------|-----------------------|------------------|-----------------|
| 3 | 2422 MHz | 15.27 | 30.00 | Complies |
| 6 | 2437 MHz | 15.32 | 30.00 | Complies |
| 9 | 2452 MHz | 15.57 | 30.00 | Complies |

3.3 Power Spectral Density Measurement

3.3.1 Limit

For digitally modulated systems, the power spectral density conducted from the intentional radiator to the antenna shall not be greater than 8 dBm in any 3 kHz band during any time interval of continuous transmission.

3.3.2 Measuring Instruments and Setting

Please refer to section 4 of equipments list in this report. The following table is the setting of the spectrum analyzer.

| Spectrum Parameter | Setting |
|--------------------|----------|
| Attenuation | Auto |
| Span Frequency | 1.5MHz |
| RB | 3 kHz |
| VB | 30 kHz |
| Detector | Peak |
| Trace | Max Hold |
| Sweep Time | 500s |

3.3.3 Test Procedures

1. The transmitter output (antenna port) was connected to the spectrum analyzer.
2. Set RBW of spectrum analyzer to 3kHz and VBW to 30kHz. Set Detector to Peak, Trace to Max Hold.
3. Mark the frequency with maximum peak power as the center of the display of the spectrum.
4. Set the span to 1.5MHz and the sweep time to 500s and record the maximum peak value.

3.3.4 Test Setup Layout

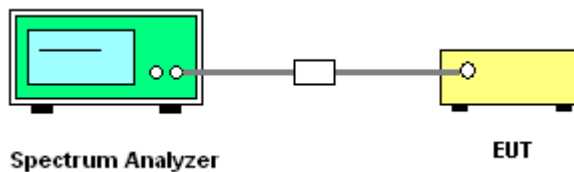

3.3.5 Test Deviation

There is no deviation with the original standard.

3.3.6 EUT Operation during Test

The EUT was programmed to be in continuously transmitting mode.

3.3.7 Test Result of Power Spectral Density

| | | | |
|------------------------|---------------|----------------------|---------|
| Final Test Date | Aug. 17, 2010 | Test Site No. | TH01-HY |
| Temperature | 24 | Humidity | 60% |
| Test Engineer | Ian | Configuration | 802.11n |

Configuration of IEEE 802.11n (20MHz)

| Channel | Frequency | Power Density (dBm) | Max. Limit (dBm) | Result |
|---------|-----------|---------------------|------------------|-----------------|
| 1 | 2412 MHz | -21.68 | 8.00 | Complies |
| 6 | 2437 MHz | -19.80 | 8.00 | Complies |
| 11 | 2462 MHz | -21.59 | 8.00 | Complies |

Configuration of IEEE 802.11n (40MHz)

| Channel | Frequency | Power Density (dBm) | Max. Limit (dBm) | Result |
|---------|-----------|---------------------|------------------|-----------------|
| 3 | 2422 MHz | -21.10 | 8.00 | Complies |
| 6 | 2437 MHz | -21.17 | 8.00 | Complies |
| 9 | 2452 MHz | -21.01 | 8.00 | Complies |

Power Density Plot on Configuration of IEEE 802.11n (20MHz) / 2412 MHz

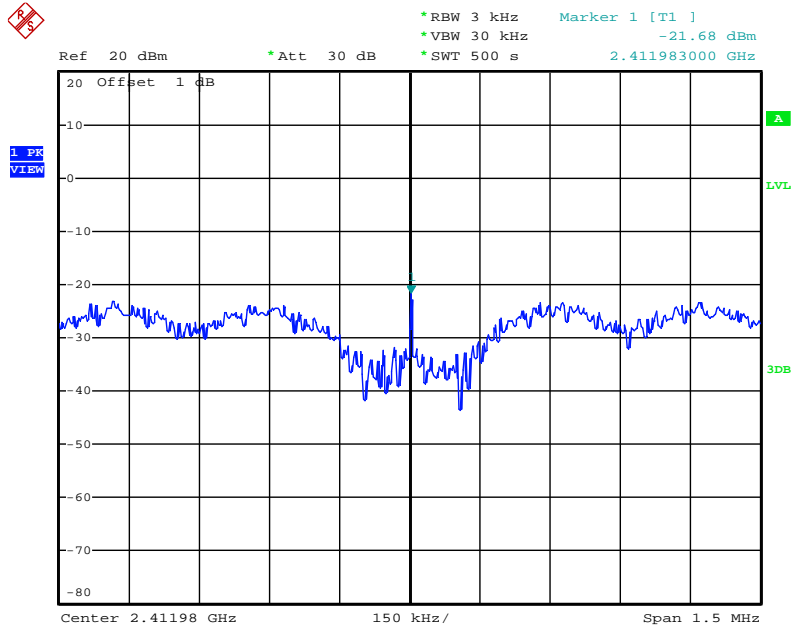

Date: 17.AUG.2010 17:57:42

Power Density Plot on Configuration of IEEE 802.11n (20MHz) / 2437 MHz

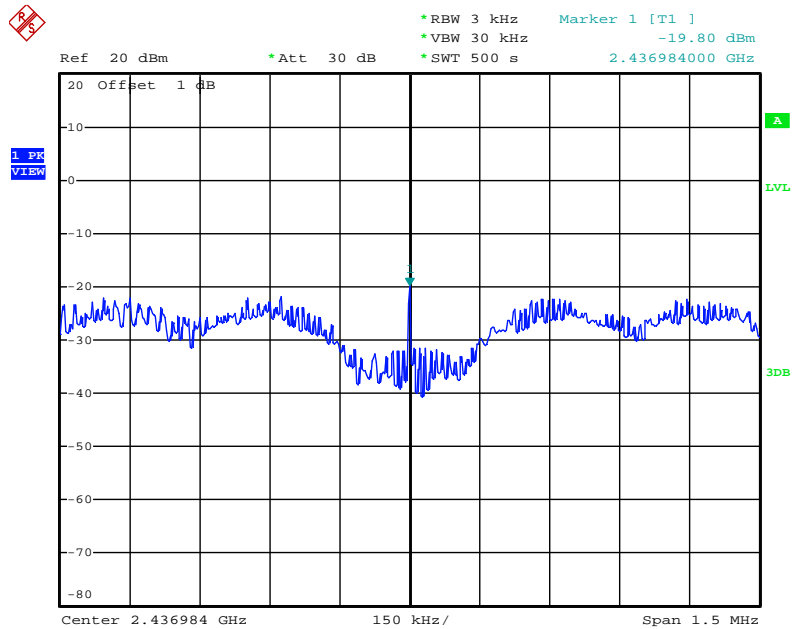

Date: 17.AUG.2010 18:38:14

Power Density Plot on Configuration of IEEE 802.11n (20MHz) / 2462 MHz

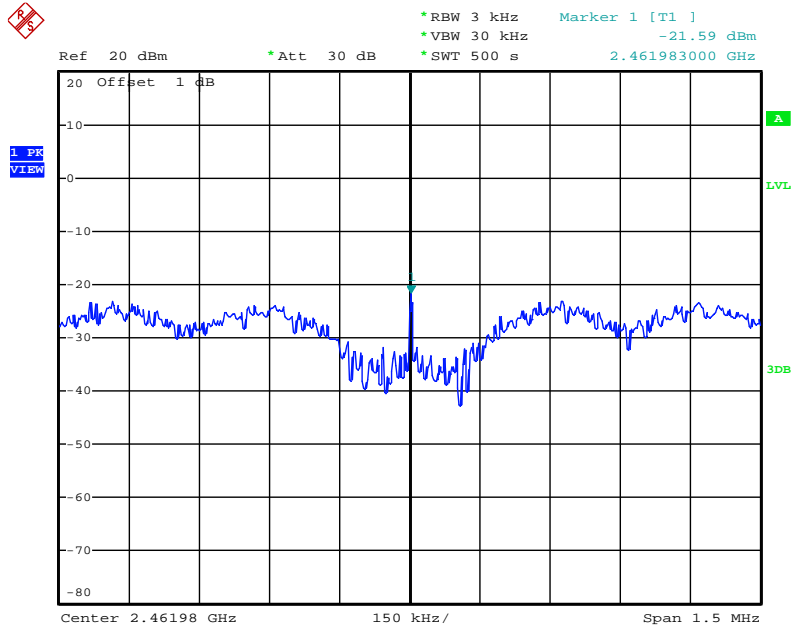

Date: 17.AUG.2010 18:03:39

Power Density Plot on Configuration of IEEE 802.11n (40MHz) / 2422 MHz

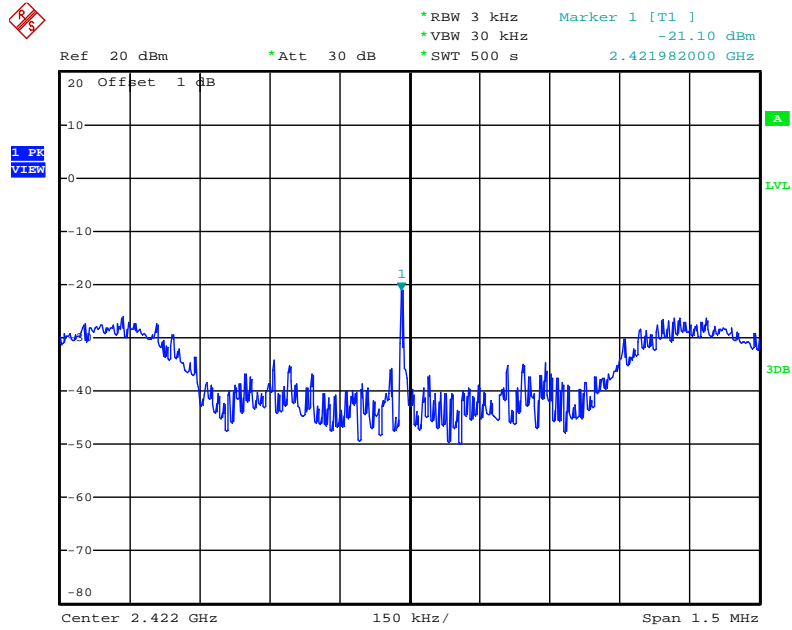

Date: 17.AUG.2010 18:16:29

Power Density Plot on Configuration of IEEE 802.11n (40MHz) / 2437 MHz

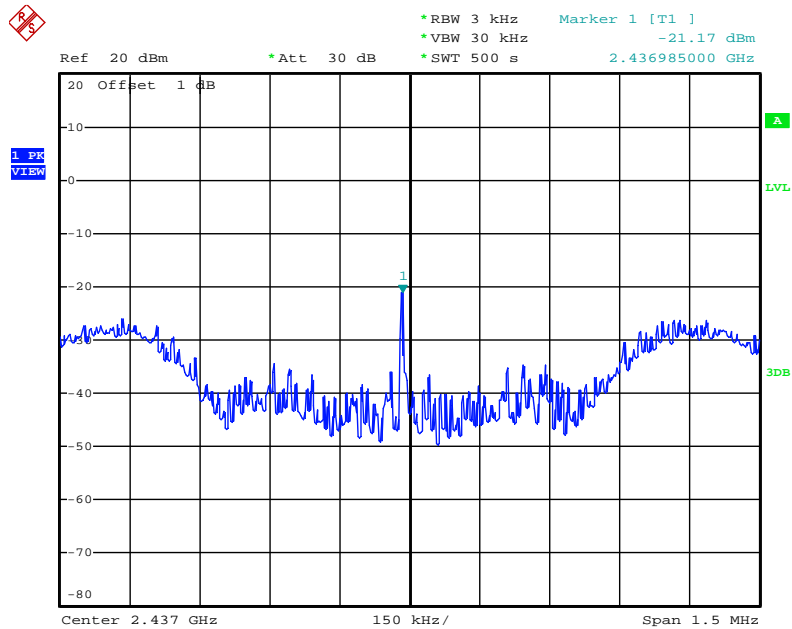

Date: 17.AUG.2010 18:18:59

Power Density Plot on Configuration of IEEE 802.11n (40MHz) / 2452 MHz

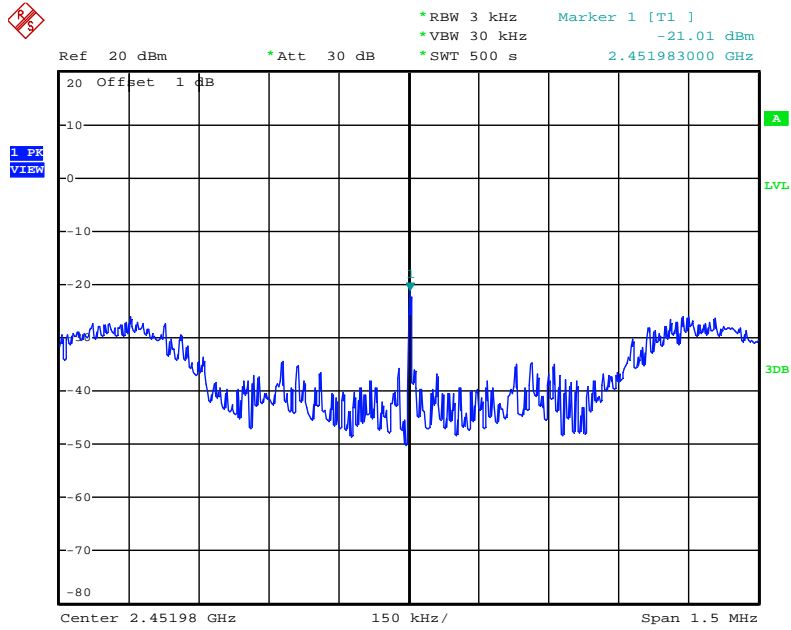

Date: 17.AUG.2010 18:23:21

3.4 6dB Spectrum Bandwidth Measurement

3.4.1 Limit

For digital modulation systems, the minimum 6dB bandwidth shall be at least 500 kHz.

3.4.2 Measuring Instruments and Setting

Please refer to section 4 of equipments list in this report. The following table is the setting of the spectrum analyzer.

| Spectrum Parameters | Setting |
|---------------------|-----------------|
| Attenuation | Auto |
| Span Frequency | > 6dB Bandwidth |
| RB | 100 kHz |
| VB | 100 kHz |
| Detector | Peak |
| Trace | Max Hold |
| Sweep Time | Auto |

3.4.3 Test Procedures

1. The transmitter output (antenna port) was connected to the spectrum analyzer in peak hold mode.
2. The resolution bandwidth of 100 kHz and the video bandwidth of 100 kHz were used.
3. Measured the spectrum width with power higher than 6dB below carrier.

3.4.4 Test Setup Layout

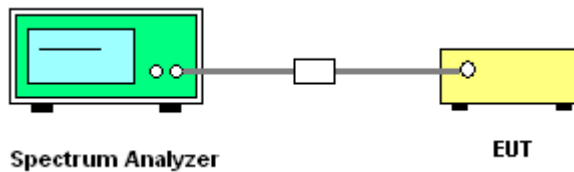

3.4.5 Test Deviation

There is no deviation with the original standard.

3.4.6 EUT Operation during Test

The EUT was programmed to be in continuously transmitting mode.

3.4.7 Test Result of 6dB Spectrum Bandwidth

| | | | |
|------------------------|---------------|----------------------|---------|
| Final Test Date | Aug. 17, 2010 | Test Site No. | TH01-HY |
| Temperature | 24 | Humidity | 60% |
| Test Engineer | Ian | Configuration | 802.11n |

Configuration of IEEE 802.11n (20MHz)

| Channel | Frequency | 6dB Bandwidth (MHz) | 99% Occupied Bandwidth (MHz) | Min. Limit (kHz) | Test Result |
|---------|-----------|---------------------|------------------------------|------------------|-----------------|
| 1 | 2412 MHz | 16.52 | 16.40 | 500 | Complies |
| 6 | 2437 MHz | 16.52 | 16.44 | 500 | Complies |
| 11 | 2462 MHz | 16.52 | 16.44 | 500 | Complies |

Configuration of IEEE 802.11n (40MHz)

| Channel | Frequency | 6dB Bandwidth (MHz) | 99% Occupied Bandwidth (MHz) | Min. Limit (kHz) | Test Result |
|---------|-----------|---------------------|------------------------------|------------------|-----------------|
| 3 | 2422 MHz | 36.48 | 35.84 | 500 | Complies |
| 6 | 2437 MHz | 36.32 | 35.84 | 500 | Complies |
| 9 | 2452 MHz | 36.32 | 35.84 | 500 | Complies |

6 dB Bandwidth Plot on Configuration of IEEE 802.11n (20MHz) / 2412 MHz

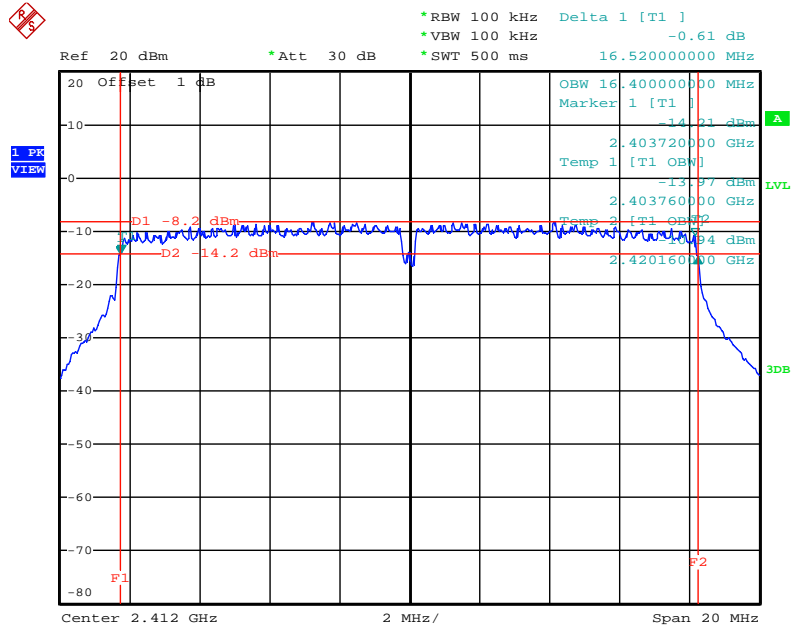

Date: 17.AUG.2010 17:56:50

6 dB Bandwidth Plot on Configuration of IEEE 802.11n (20MHz) / 2437 MHz

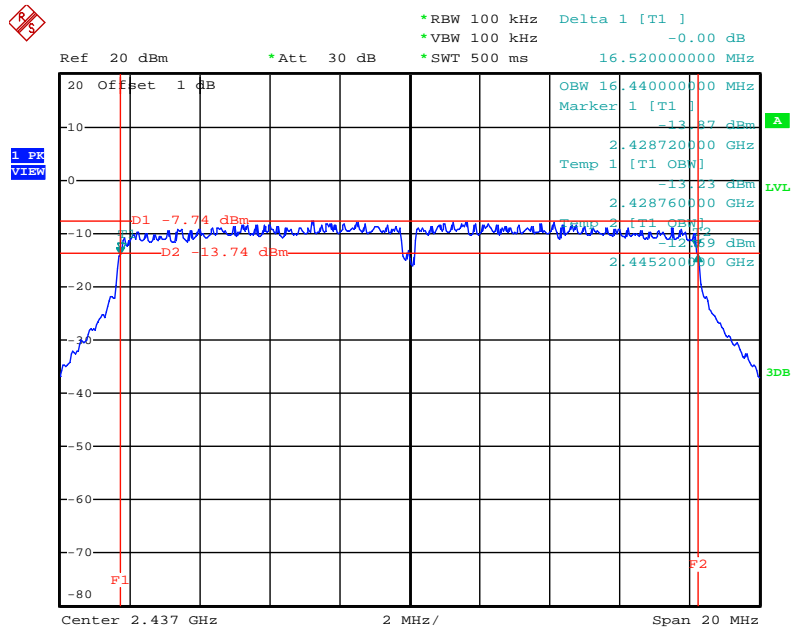

Date: 17.AUG.2010 18:06:57

6 dB Bandwidth Plot on Configuration of IEEE 802.11n (20MHz) / 2462 MHz

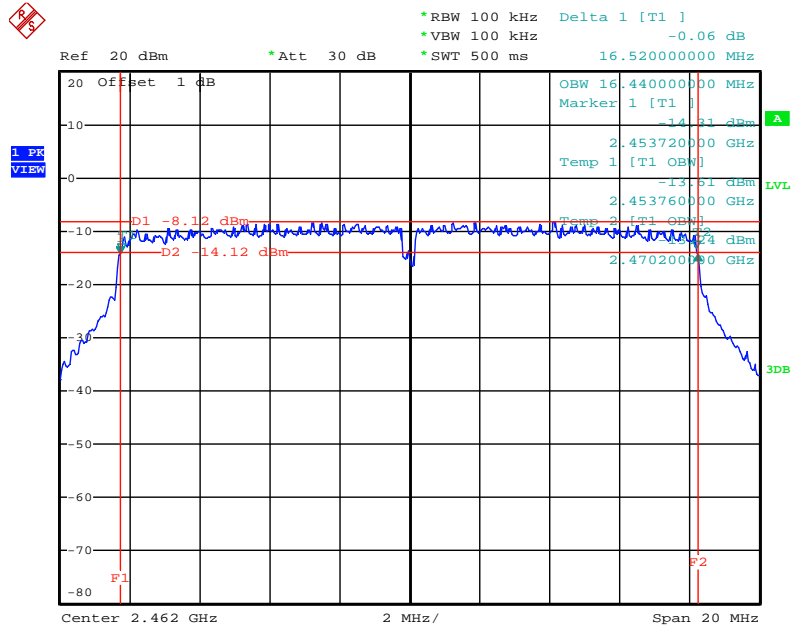

Date: 17.AUG.2010 18:02:53

6 dB Bandwidth Plot on Configuration of IEEE 802.11n (40MHz) / 2422 MHz

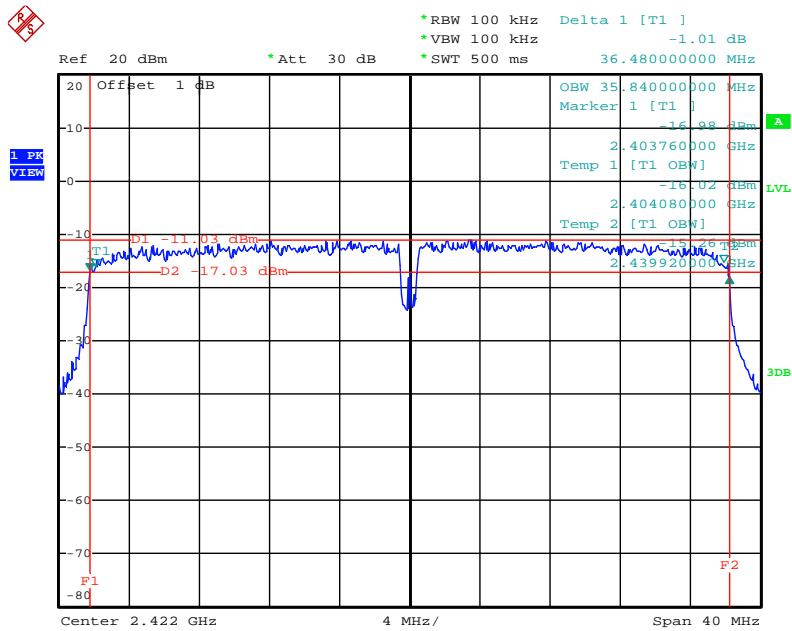

Date: 17.AUG.2010 18:15:14

6 dB Bandwidth Plot on Configuration of IEEE 802.11n (40MHz) / 2437 MHz

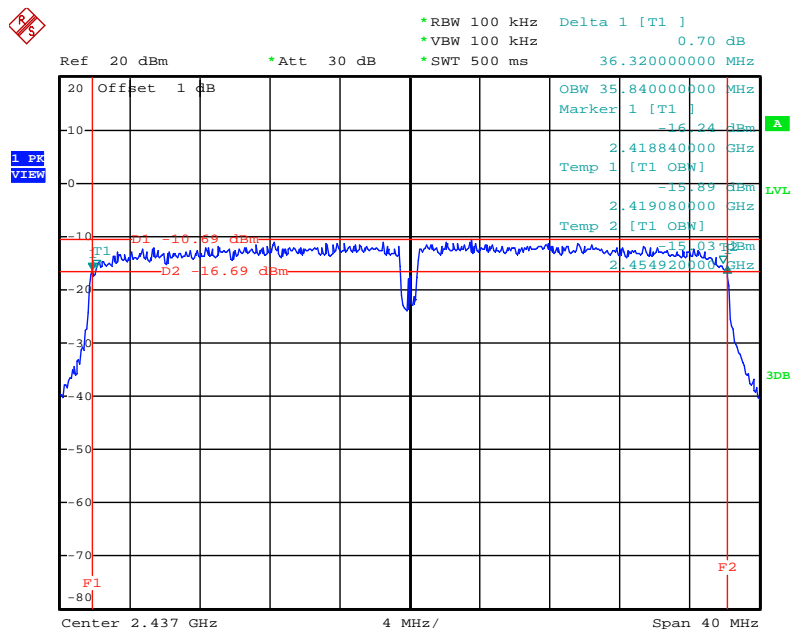

Date: 17.AUG.2010 18:17:56

6 dB Bandwidth Plot on Configuration of IEEE 802.11n (40MHz) / 2452 MHz

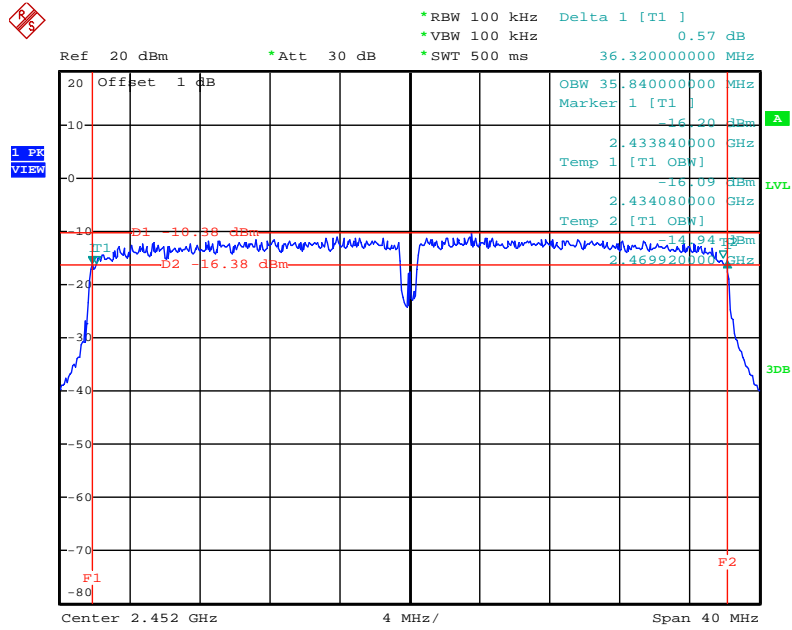

Date: 17.AUG.2010 18:22:01

3.5 Radiated Emissions Measurement

3.5.1 Limit

20dBc in any 100 kHz bandwidth outside the operating frequency band. In case the emission fall within the restricted band specified on 15.205(a), then the 15.209(a) limit in the table below has to be followed.

| Frequencies (MHz) | Field Strength (microvolt/meter) | Measurement Distance (meters) |
|------------------------------|---|--|
| 0.009~0.490 | 2400/F(KHz) | 300 |
| 0.490~1.705 | 24000/F(KHz) | 30 |
| 1.705~30.0 | 30 | 30 |
| 30~88 | 100 | 3 |
| 88~216 | 150 | 3 |
| 216~960 | 200 | 3 |
| Above 960 | 500 | 3 |

3.5.2 Measuring Instruments and Setting

Please refer to section 4 of equipments list in this report. The following table is the setting of spectrum analyzer and receiver.

| Spectrum Parameter | Setting |
|---|--|
| Attenuation | Auto |
| Start Frequency | 1000 MHz |
| Stop Frequency | 10th carrier harmonic |
| RB / VB (Emission in restricted band) | 1MHz / 1MHz for Peak, 1 MHz / 10Hz for Average |
| RB / VB (Emission in non-restricted band) | 1MHz / 1MHz for peak |

| Receiver Parameter | Setting |
|---------------------------|----------------------------------|
| Attenuation | Auto |
| Start ~ Stop Frequency | 9kHz~150kHz / RB 200Hz for QP |
| Start ~ Stop Frequency | 150kHz~30MHz / RB 9kHz for QP |
| Start ~ Stop Frequency | 30MHz~1000MHz / RB 120kHz for QP |

3.5.3 Test Procedures

1. Configure the EUT according to ANSI C63.4. The EUT was placed on the top of the turntable 0.8 meter above ground. The phase center of the receiving antenna mounted on the top of a height-variable antenna tower was placed 3 meters far away from the turntable.
2. Power on the EUT and all the supporting units. The turntable was rotated by 360 degrees to determine the position of the highest radiation.
3. The height of the broadband receiving antenna was varied between one meter and four meters above ground to find the maximum emissions field strength of both horizontal and vertical polarization.
4. For each suspected emissions, the antenna tower was scan (from 1 M to 4 M) and then the turntable was rotated (from 0 degree to 360 degrees) to find the maximum reading.
5. Set the test-receiver system to Peak or CISPR quasi-peak Detect Function with specified bandwidth under Maximum Hold Mode.
6. For emissions above 1GHz, use 1MHz VBW and RBW for peak reading. Then 1MHz RBW and 10Hz VBW for average reading in spectrum analyzer.
7. When the radiated emissions limits are expressed in terms of the average value of the emissions, and pulsed operation is employed, the measurement field strength shall be determined by averaging over one complete pulse train, including blanking intervals, as long as the pulse train does not exceed 0.1 seconds. As an alternative (provided the transmitter operates for longer than 0.1 seconds) or in cases where the pulse train exceeds 0.1 seconds, the measured field strength shall be determined from the average absolute voltage during a 0.1 second interval during which the field strength is at its maximum value.
8. If the emissions level of the EUT in peak mode was 3 dB lower than the average limit specified, then testing will be stopped and peak values of EUT will be reported, otherwise, the emissions which do not have 3 dB margin will be repeated one by one using the quasi-peak method for below 1GHz.
9. For testing above 1GHz, the emissions level of the EUT in peak mode was lower than average limit (that means the emissions level in peak mode also complies with the limit in average mode), then testing will be stopped and peak values of EUT will be reported, otherwise, the emissions will be measured in average mode again and reported.
10. In case the emission is lower than 30MHz, loop antenna has to be used for measurement and the recorded data should be QP measured by receiver. High – Low scan is not required in this case.

3.5.4 Test Setup Layout

For radiated emissions below 30MHz

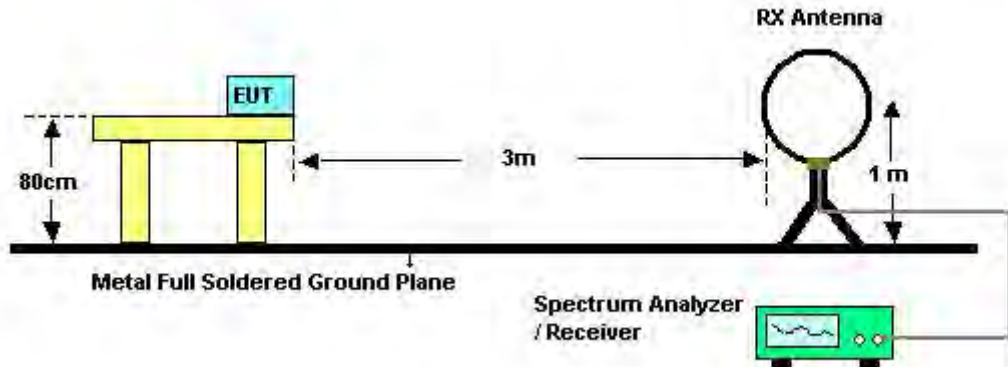

For radiated emissions above 30MHz

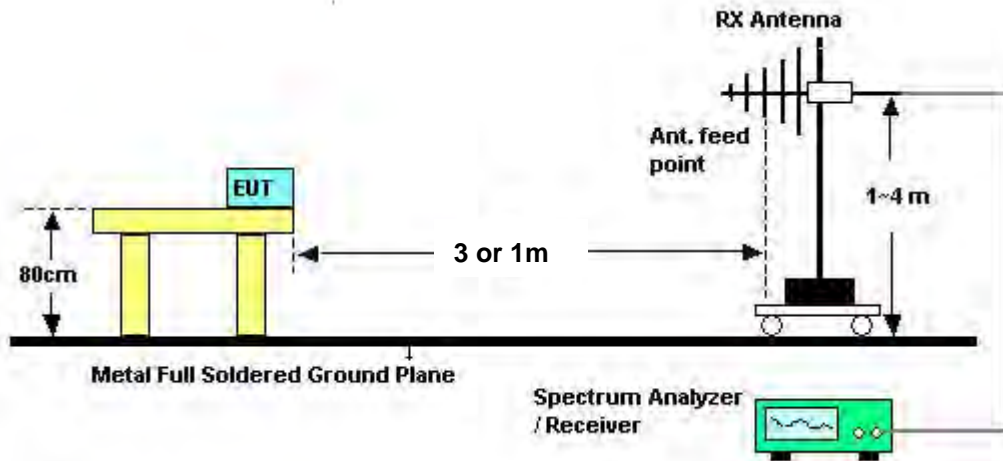

Above 10 GHz shall be extrapolated to the specified distance using an extrapolation factor of 20 dB/decade from 3m to 1m.

Distance extrapolation factor = $20 \log (\text{specific distance [3m]} / \text{test distance [1m]})$ (dB);

Limit line = specific limits (dBuV) + distance extrapolation factor [9.54 dB].

3.5.5 Test Deviation

There is no deviation with the original standard.

3.5.6 EUT Operation during Test

The EUT was programmed to be in continuously transmitting mode.

3.5.7 Results of Radiated Emissions (9kHz~30MHz)

| | | | |
|------------------------|---------------|----------------------|-----------|
| Final Test Date | Aug. 31, 2010 | Test Site No. | 03CH02-HY |
| Temperature | 28 | Humidity | 55% |
| Test Engineer | Daniel | | |

| Freq. (MHz) | Level (dBuV) | Over Limit (dB) | Limit Line (dBuV) | Remark |
|--------------------|---------------------|------------------------|--------------------------|---------------|
| - | - | - | - | See Note |

Note:

The amplitude of spurious emissions that are attenuated by more than 20 dB below the permissible value has no need to be reported.

Distance extrapolation factor = $40 \log(\text{specific distance} / \text{test distance})$ (dB);

Limit line = specific limits (dBuV) + distance extrapolation factor.

3.5.8 Results of Radiated Emissions (30MHz~1GHz)

| | | | |
|-----------------|---------------|---------------|-------------|
| Final Test Date | Aug. 31, 2010 | Test Site No. | 03CH02-HY |
| Temperature | 28 | Humidity | 55% |
| Test Engineer | Daniel | Configuration | Normal Mode |

Horizontal

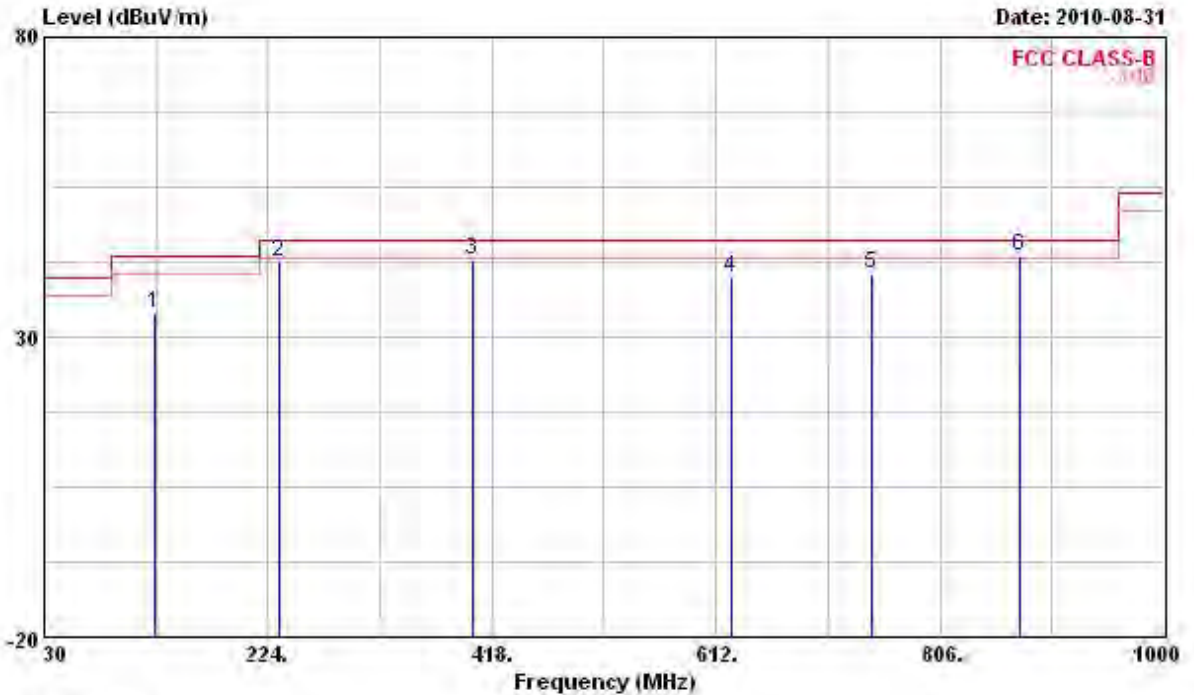

| Freq | Level | Over Limit | Limit | ReadAntenna | Cable | Preamp | Remark | | |
|------|---------|------------|--------|-------------|-------|--------|--------|-------|------|
| MHz | dBuV/m | dB | dBuV/m | dBuV | dB/m | dB | dB | | |
| 1 | 125.060 | 33.80 | -9.70 | 43.50 | 46.33 | 13.18 | 1.82 | 27.53 | Peak |
| 2 | 232.730 | 42.58 | -3.42 | 46.00 | 54.49 | 12.43 | 2.56 | 26.90 | Peak |
| 3 | 400.540 | 42.67 | -3.33 | 46.00 | 51.73 | 15.27 | 3.34 | 27.67 | QP |
| 4 | 625.580 | 39.85 | -6.15 | 46.00 | 44.00 | 19.84 | 4.14 | 28.13 | Peak |
| 5 | 746.830 | 40.52 | -5.48 | 46.00 | 44.33 | 19.51 | 4.56 | 27.88 | Peak |
| 6 | 874.870 | 43.51 | -2.49 | 46.00 | 45.93 | 20.09 | 4.93 | 27.44 | Peak |

Vertical

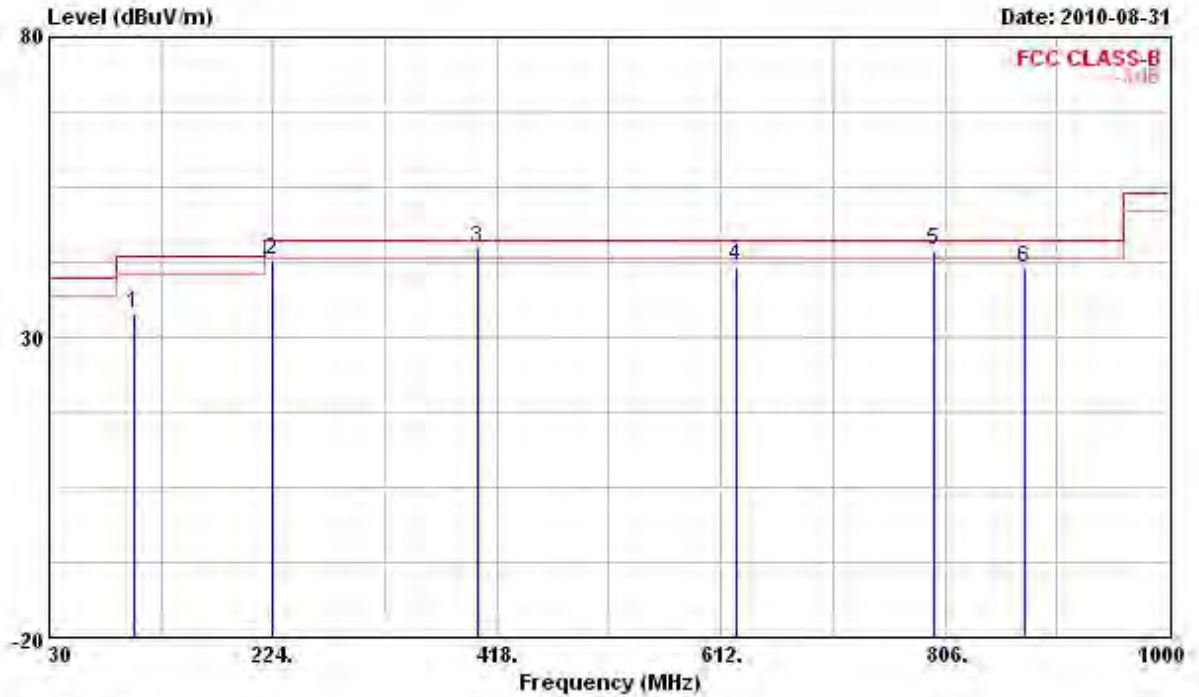

| | Freq | Level | Over Limit | Limit Line | ReadAntenna Level | Antenna Factor | Cable Loss | Preamp Factor | Remark |
|---|---------|--------|------------|------------|-------------------|----------------|------------|---------------|--------|
| | MHz | dBuV/m | dB | dBuV/m | dBuV | dB/m | dB | dB | |
| 1 | 102.750 | 33.81 | -9.69 | 43.50 | 48.23 | 11.53 | 1.64 | 27.59 | QP |
| 2 | 223.030 | 42.78 | -3.22 | 46.00 | 55.13 | 12.11 | 2.49 | 26.95 | Peak |
| 3 | 400.540 | 44.74 | -1.26 | 46.00 | 53.80 | 15.27 | 3.34 | 27.67 | QP |
| 4 | 625.580 | 41.90 | -4.10 | 46.00 | 46.05 | 19.84 | 4.14 | 28.13 | Peak |
| 5 | 796.300 | 44.55 | -1.45 | 46.00 | 47.33 | 20.21 | 4.75 | 27.74 | QP |
| 6 | 874.870 | 41.62 | -4.38 | 46.00 | 44.04 | 20.09 | 4.93 | 27.44 | Peak |

Note:

The amplitude of spurious emissions that are attenuated by more than 20dB below the permissible value has no need to be reported.

Emission level (dBuV/m) = 20 log Emission level (uV/m).

Corrected Reading: Antenna Factor + Cable Loss + Read Level - Preamp Factor = Level.

3.5.9 Results for Radiated Emissions (1GHz~10th Harmonic)

| | | | |
|------------------------|---------------|----------------------|-----------------------|
| Final Test Date | Aug. 31, 2010 | Test Site No. | 03CH02-HY |
| Temperature | 28 | Humidity | 55% |
| Test Engineer | Eddie | Configuration | 802.11n Ch. 1 (20MHz) |

Horizontal

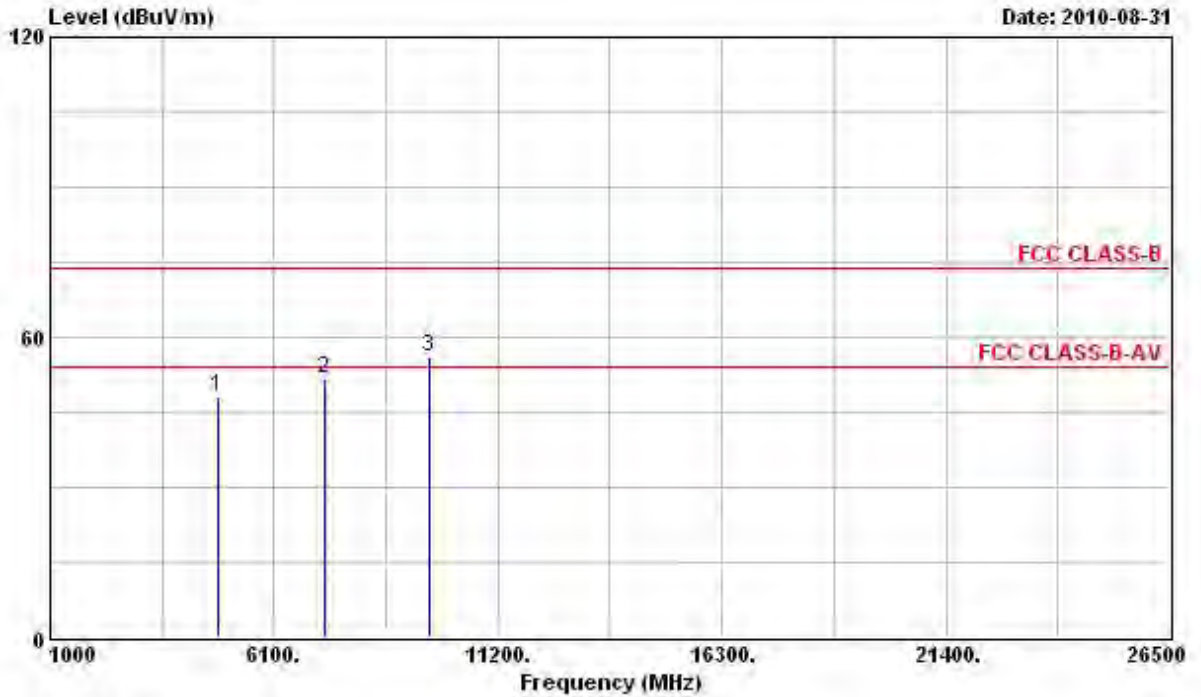

| Freq | Level | Over Limit | Limit Line | ReadAntenna Level | Antenna Factor | Cable Loss | Preamp Factor | Remark |
|------------|--------|------------|------------|-------------------|----------------|------------|---------------|--------|
| MHz | dBuV/m | dB | dBuV/m | dBuV | dB/m | dB | dB | |
| 1 4824.000 | 48.26 | -5.74 | 54.00 | 42.43 | 35.76 | 4.58 | 34.51 | PK |
| 2 7236.000 | 51.89 | | | 42.70 | 37.85 | 5.63 | 34.29 | Peak |
| 3 9648.000 | 56.16 | | | 45.06 | 39.39 | 6.34 | 34.63 | Peak |

Note: The items 2 and 3 are on un-restricted band, so the limit is -20dB for the field strength of the fundamental emissions (see section 3.6.7).

Vertical

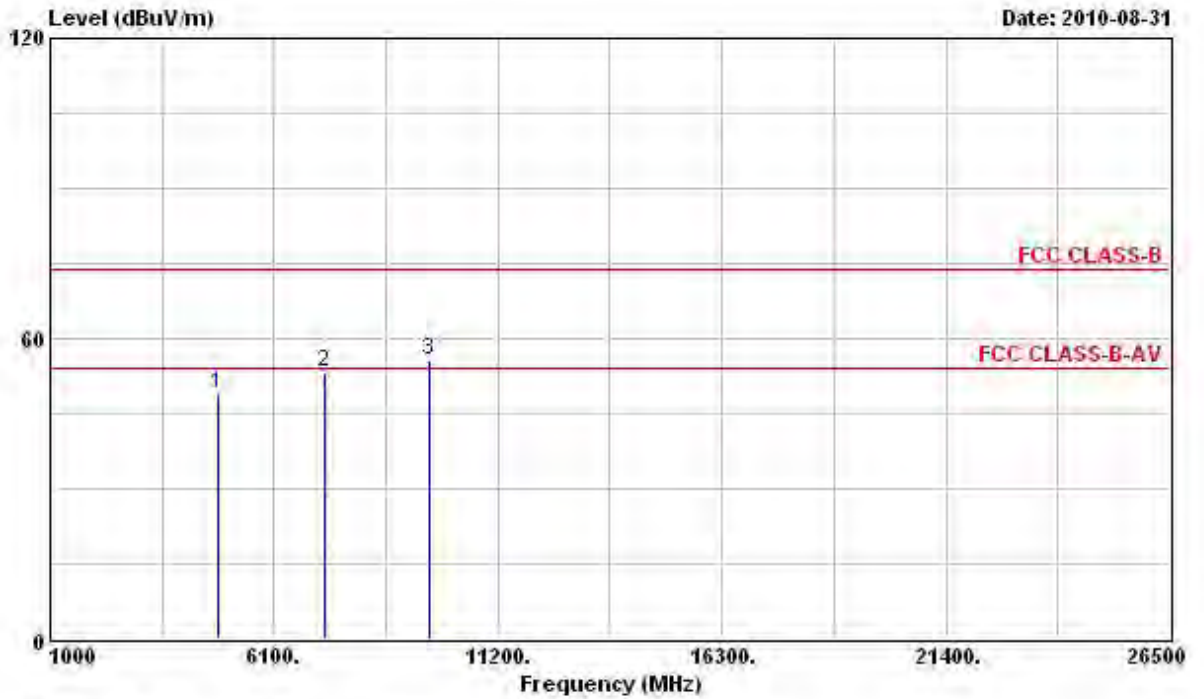

| Freq | Level | Over Limit | Limit Line | ReadAntenna Level | Antenna Factor | Cable Loss | Preamp Factor | Remark |
|------|----------|------------|------------|-------------------|----------------|------------|---------------|------------|
| MHz | dBuV/m | dB | dBuV/m | dBuV | dB/m | dB | dB | |
| 1 | 4824.000 | 48.78 | -5.22 | 54.00 | 43.58 | 35.13 | 4.58 | 34.51 PK |
| 2 | 7236.000 | 53.47 | | | 45.23 | 36.90 | 5.63 | 34.29 Peak |
| 3 | 9648.000 | 55.85 | | | 45.55 | 38.59 | 6.34 | 34.63 Peak |

Note: The items 2 and 3 are on un-restricted band, so the limit is -20dB for the field strength of the fundamental emissions (see section 3.6.7).

| | | | |
|------------------------|---------------|----------------------|-----------------------|
| Final Test Date | Aug. 31, 2010 | Test Site No. | 03CH02-HY |
| Temperature | 28 | Humidity | 55% |
| Test Engineer | Eddie | Configuration | 802.11n Ch. 6 (20MHz) |

Horizontal

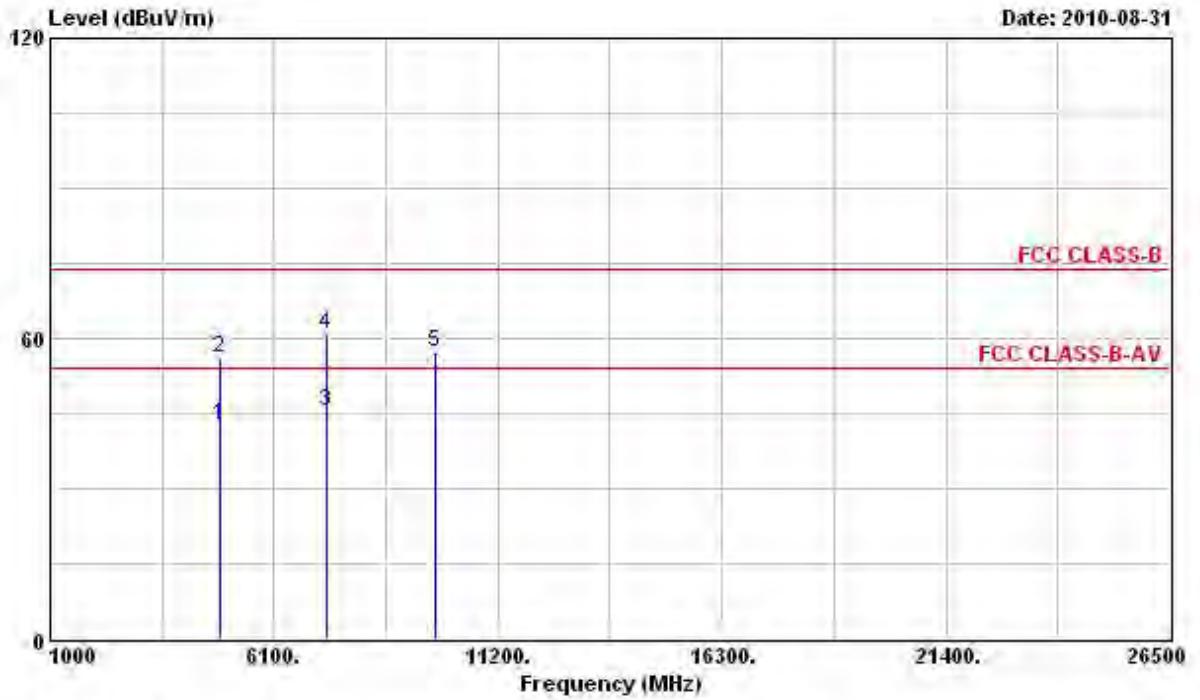

| | Freq | Level | Over Limit | Limit Line | ReadAntenna | Cable | Preamp | Remark |
|---|----------|--------|------------|------------|-------------|-------|--------|---------------|
| | MHz | dBuV/m | dB | dBuV/m | dBuV | dB/m | dB | dB |
| 1 | 4874.000 | 42.68 | -11.32 | 54.00 | 36.69 | 35.83 | 4.61 | 34.45 Average |
| 2 | 4874.000 | 56.10 | -17.90 | 74.00 | 50.11 | 35.83 | 4.61 | 34.45 Peak |
| 3 | 7311.000 | 45.37 | -8.63 | 54.00 | 36.16 | 37.86 | 5.64 | 34.29 Average |
| 4 | 7311.000 | 60.97 | -13.03 | 74.00 | 51.76 | 37.86 | 5.64 | 34.29 Peak |
| 5 | 9748.000 | 57.37 | | | 46.08 | 39.51 | 6.36 | 34.58 Peak |

Note: The item 5 is on un-restricted band, so the limit is -20dB for the field strength of the fundamental emissions (see section 3.6.7).

Vertical

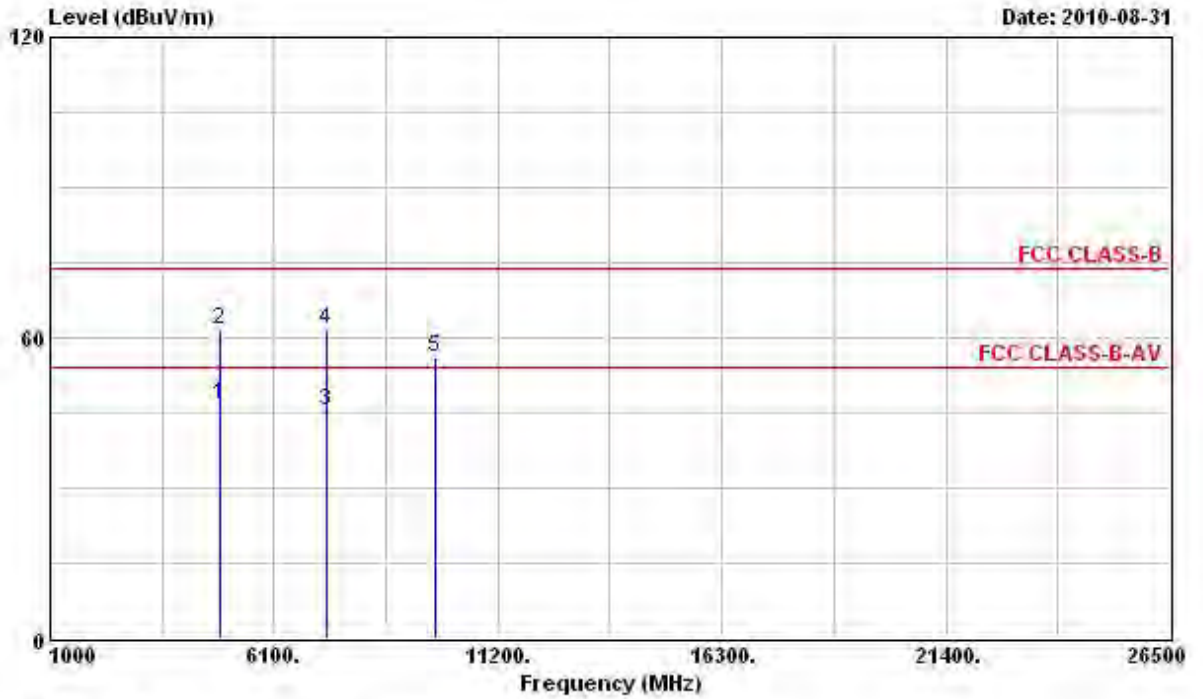

| | Freq | Level | Over Limit | Limit Line | ReadAntenna Level | Antenna Factor | Cable Loss | Preamp Factor | Remark |
|---|----------|--------|------------|------------|-------------------|----------------|------------|---------------|---------|
| | MHz | dBuV/m | dB | dBuV/m | dBuV | dB/m | dB | dB | |
| 1 | 4874.000 | 46.74 | -7.26 | 54.00 | 41.40 | 35.18 | 4.61 | 34.45 | Average |
| 2 | 4874.000 | 61.65 | -12.35 | 74.00 | 56.31 | 35.18 | 4.61 | 34.45 | Peak |
| 3 | 7311.000 | 45.58 | -8.42 | 54.00 | 37.31 | 36.92 | 5.64 | 34.29 | Average |
| 4 | 7311.000 | 61.54 | -12.46 | 74.00 | 53.27 | 36.92 | 5.64 | 34.29 | Peak |
| 5 | 9748.000 | 56.16 | | | 45.67 | 38.71 | 6.36 | 34.58 | Peak |

Note: The item 5 is on un-restricted band, so the limit is -20dB for the field strength of the fundamental emissions (see section 3.6.7).

| | | | |
|-----------------|---------------|---------------|------------------------|
| Final Test Date | Aug. 31, 2010 | Test Site No. | 03CH02-HY |
| Temperature | 28 | Humidity | 55% |
| Test Engineer | Eddie | Configuration | 802.11n Ch. 11 (20MHz) |

Horizontal

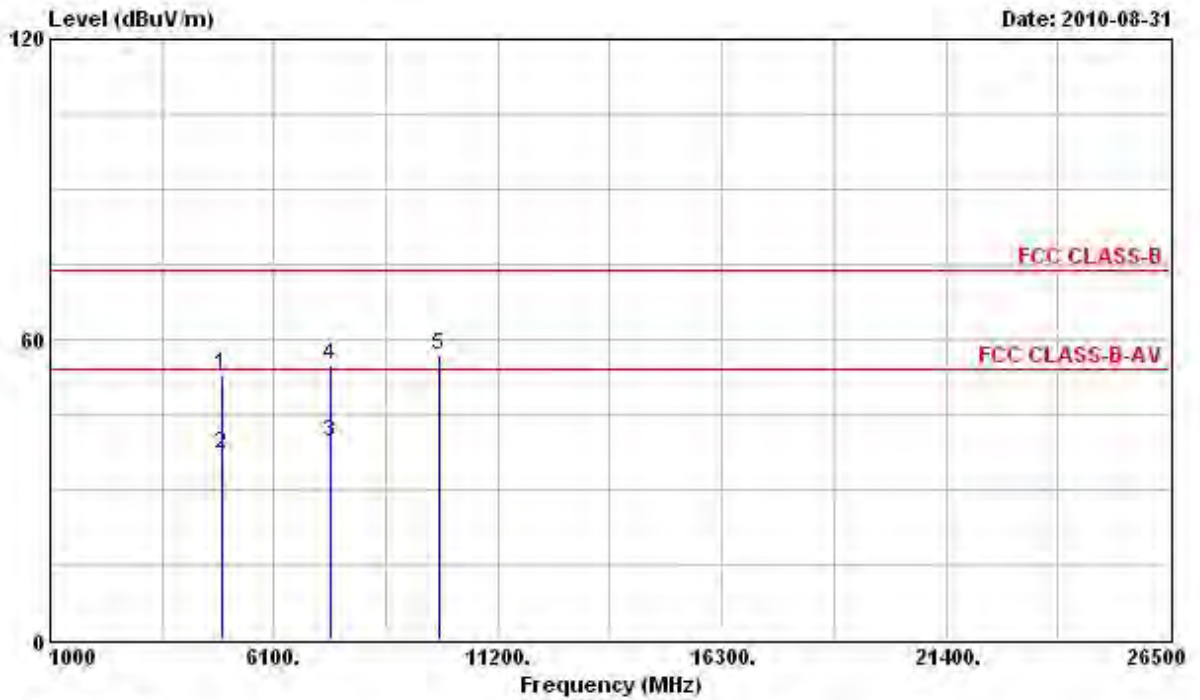

| | Freq | Level | Over Limit | Limit Line | ReadAntenna Level | Antenna Factor | Cable Loss | Preamp Factor | Remark |
|---|----------|--------|------------|------------|-------------------|----------------|------------|---------------|---------|
| | MHz | dBuV/m | dB | dBuV/m | dBuV | dB/m | dB | dB | |
| 1 | 4924.000 | 52.72 | -21.28 | 74.00 | 46.52 | 35.90 | 4.68 | 34.38 | Peak |
| 2 | 4924.000 | 37.30 | -16.70 | 54.00 | 31.10 | 35.90 | 4.68 | 34.38 | Average |
| 3 | 7386.000 | 39.53 | -14.47 | 54.00 | 30.29 | 37.88 | 5.65 | 34.29 | Average |
| 4 | 7386.000 | 54.84 | -19.16 | 74.00 | 45.60 | 37.88 | 5.65 | 34.29 | Peak |
| 5 | 9848.000 | 57.02 | | | 45.57 | 39.61 | 6.38 | 34.54 | Peak |

Note: The item 5 is on un-restricted band, so the limit is -20dB for the field strength of the fundamental emissions (see section 3.6.7).

Vertical

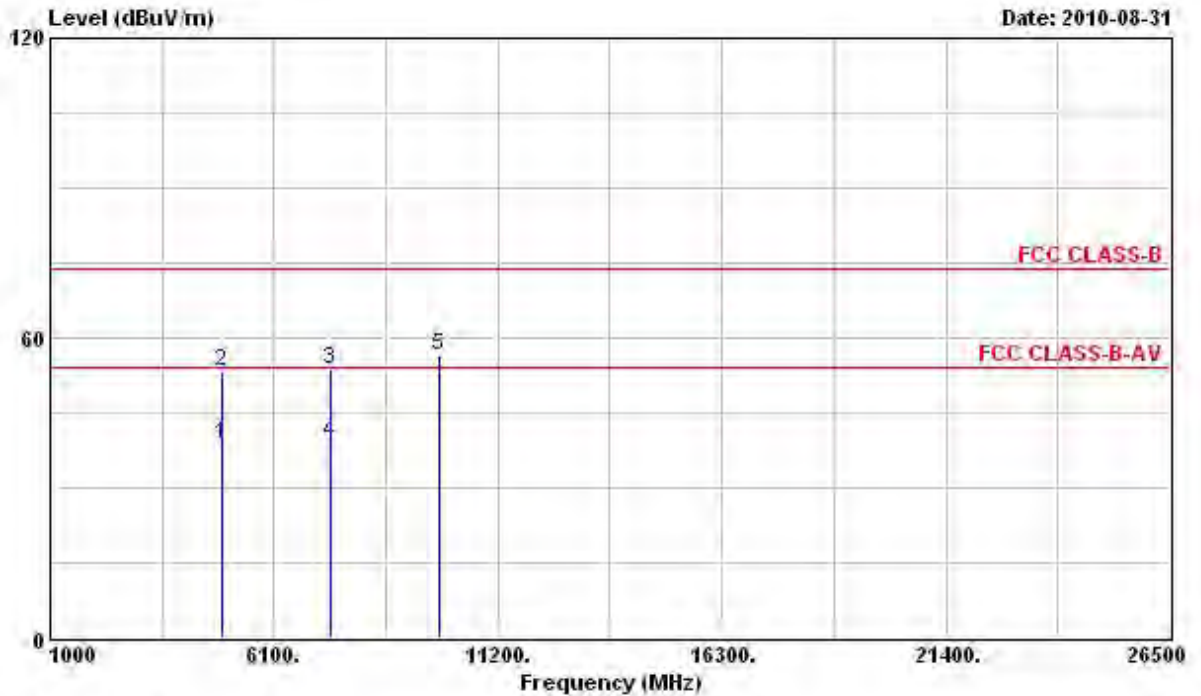

| | Freq | Level | Over Limit | Limit Line | ReadAntenna Level | Antenna Factor | Cable Loss | Preamp Factor | Remark |
|---|----------|--------|------------|------------|-------------------|----------------|------------|---------------|---------|
| | MHz | dBuV/m | dB | dBuV/m | dBuV | dB/m | dB | dB | |
| 1 | 4924.000 | 38.75 | -15.25 | 54.00 | 33.22 | 35.23 | 4.68 | 34.38 | Average |
| 2 | 4924.000 | 53.30 | -20.70 | 74.00 | 47.77 | 35.23 | 4.68 | 34.38 | Peak |
| 3 | 7386.000 | 53.64 | -20.36 | 74.00 | 45.32 | 36.96 | 5.65 | 34.29 | Peak |
| 4 | 7386.000 | 39.17 | -14.83 | 54.00 | 30.85 | 36.96 | 5.65 | 34.29 | Average |
| 5 | 9848.000 | 56.36 | | | 45.71 | 38.81 | 6.38 | 34.54 | Peak |

Note: The item 5 is on un-restricted band, so the limit is -20dB for the field strength of the fundamental emissions (see section 3.6.7).

| | | | |
|------------------------|---------------|----------------------|-----------------------|
| Final Test Date | Aug. 31, 2010 | Test Site No. | 03CH02-HY |
| Temperature | 28 | Humidity | 55% |
| Test Engineer | Eddie | Configuration | 802.11n Ch. 3 (40MHz) |

Horizontal

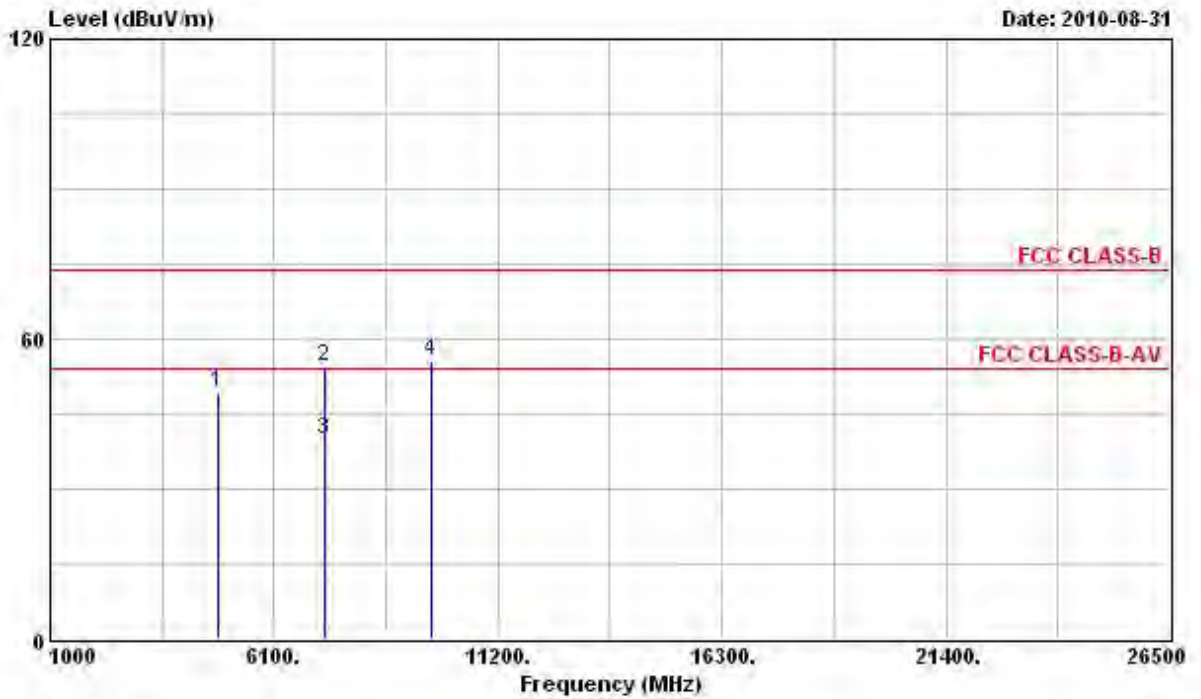

| | Freq | Level | Over | Limit | ReadAntenna | Cable | Preamp | Remark |
|----------|-----------------|---------------|---------------|---------------|--------------------|--------------|---------------|----------------------|
| | MHz | dBuV/m | dB | dBuV/m | dBuV | Loss | Factor | |
| | | | | | dB/m | dB | dB | |
| 1 | 4844.000 | 49.18 | -4.82 | 54.00 | 43.27 | 35.78 | 4.61 | 34.48 PK |
| 2 | 7266.000 | 54.28 | -19.72 | 74.00 | 45.08 | 37.86 | 5.63 | 34.29 Peak |
| 3 | 7266.000 | 39.68 | -14.32 | 54.00 | 30.48 | 37.86 | 5.63 | 34.29 Average |
| 4 | 9688.000 | 55.50 | | | 44.32 | 39.43 | 6.35 | 34.60 Peak |

Note: The item 4 is on un-restricted band, so the limit is -20dB for the field strength of the fundamental emissions (see section 3.6.7).

Vertical

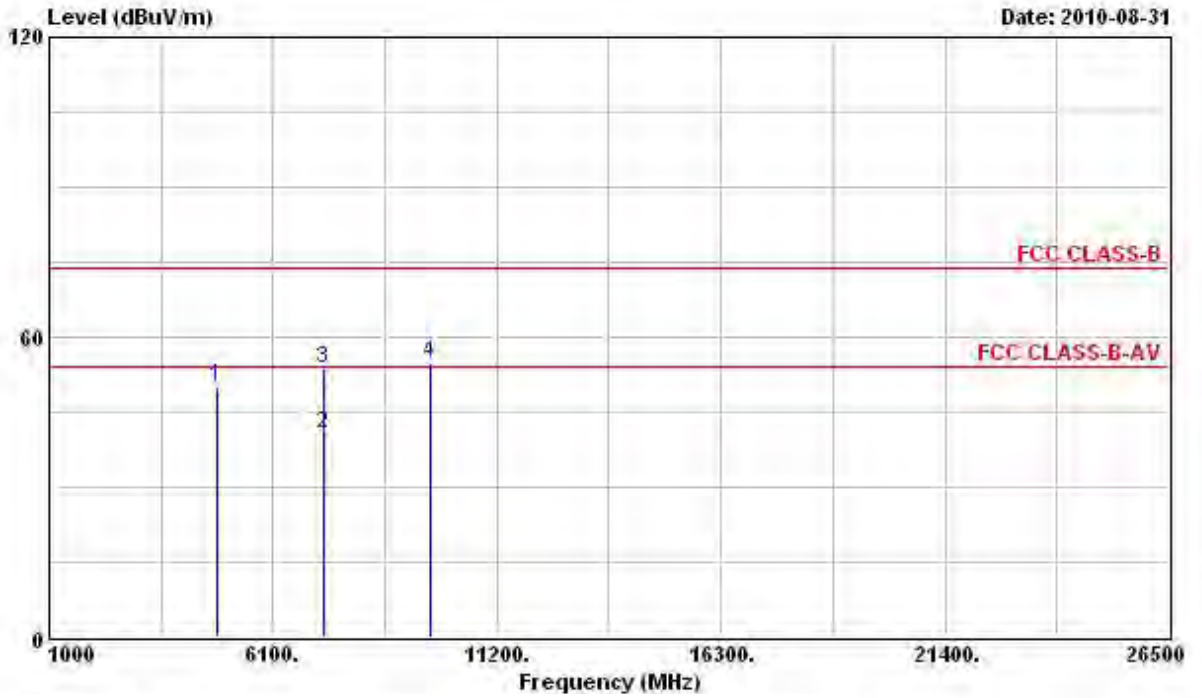

| | Freq | Level | Over Limit | Limit Line | ReadAntenna Level | Cable Loss | Preamp Factor | Remark |
|---|----------|--------|------------|------------|-------------------|------------|---------------|---------------|
| | MHz | dBuV/m | dB | dBuV/m | dBuV | dB/m | dB | dB |
| 1 | 4844.000 | 50.12 | -3.88 | 54.00 | 44.85 | 35.14 | 4.61 | 34.48 PK |
| 2 | 7266.000 | 40.85 | -13.15 | 54.00 | 32.60 | 36.91 | 5.63 | 34.29 Average |
| 3 | 7266.000 | 53.85 | -20.15 | 74.00 | 45.60 | 36.91 | 5.63 | 34.29 Peak |
| 4 | 9688.000 | 55.05 | | | 44.67 | 38.63 | 6.35 | 34.60 Peak |

Note: The item 4 is on un-restricted band, so the limit is -20dB for the field strength of the fundamental emissions (see section 3.6.7).

| | | | |
|------------------------|---------------|----------------------|-----------------------|
| Final Test Date | Aug. 31, 2010 | Test Site No. | 03CH02-HY |
| Temperature | 28 | Humidity | 55% |
| Test Engineer | Eddie | Configuration | 802.11n Ch. 6 (40MHz) |

Horizontal

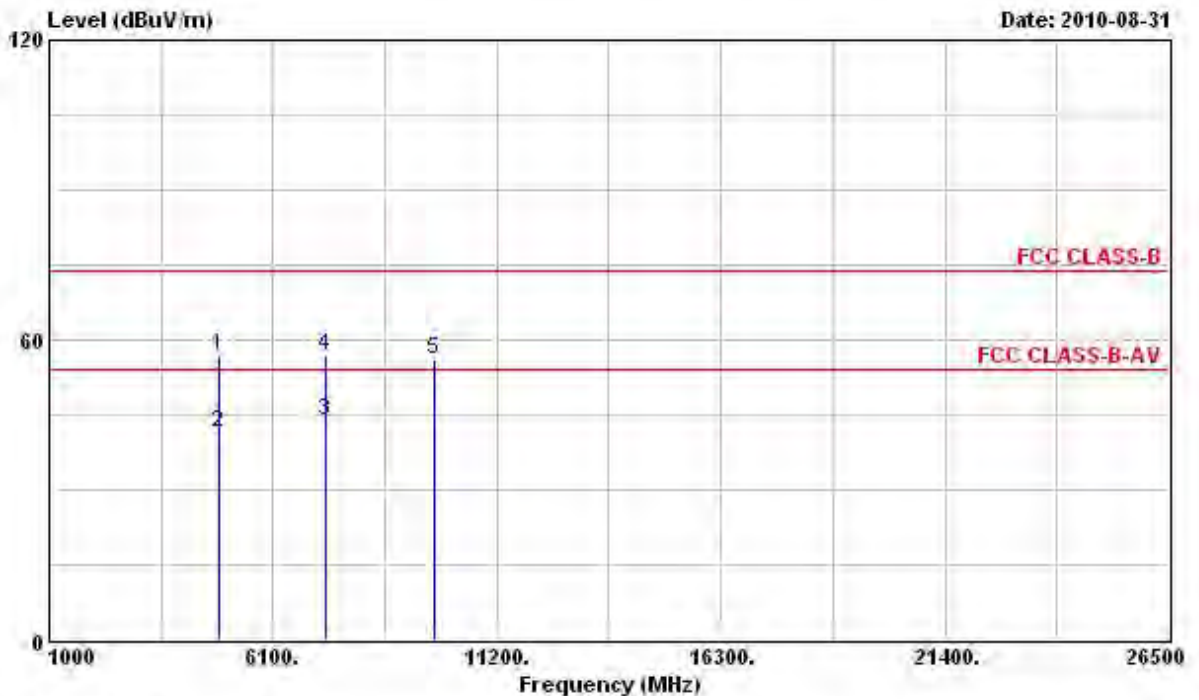

| | Freq | Level | Over Limit | Limit Line | ReadAntenna Level | Antenna Factor | Cable Loss | Preamp Factor | Remark |
|---|----------|--------|------------|------------|-------------------|----------------|------------|---------------|---------|
| | MHz | dBuV/m | dB | dBuV/m | dBuV | dB/m | dB | dB | |
| 1 | 4874.000 | 56.65 | -17.35 | 74.00 | 50.66 | 35.83 | 4.61 | 34.45 | Peak |
| 2 | 4874.000 | 41.60 | -12.40 | 54.00 | 35.61 | 35.83 | 4.61 | 34.45 | Average |
| 3 | 7311.000 | 43.64 | -10.36 | 54.00 | 34.43 | 37.86 | 5.64 | 34.29 | Average |
| 4 | 7311.000 | 56.85 | -17.15 | 74.00 | 47.64 | 37.86 | 5.64 | 34.29 | Peak |
| 5 | 9748.000 | 55.88 | | | 44.59 | 39.51 | 6.36 | 34.58 | Peak |

Note: The item 5 is on un-restricted band, so the limit is -20dB for the field strength of the fundamental emissions (see section 3.6.7).

Vertical

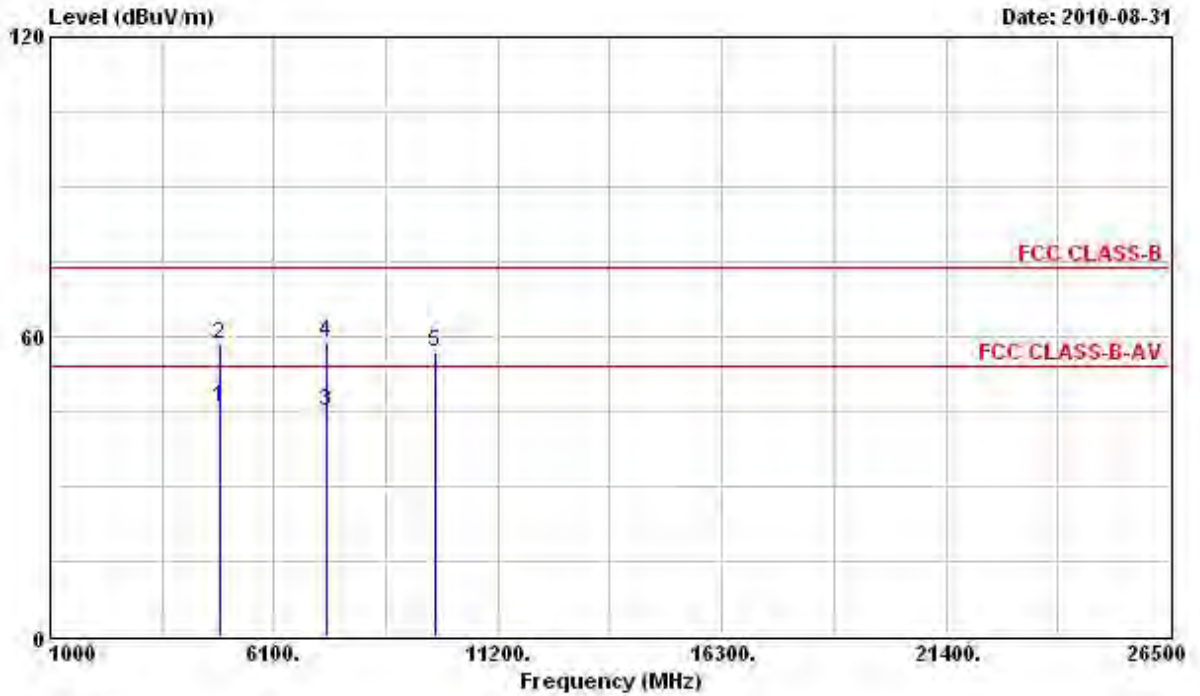

| | Freq | Level | Over Limit | Limit Line | ReadAntenna Level | Antenna Factor | Cable Loss | Preamp Factor | Remark |
|---|----------|--------|------------|------------|-------------------|----------------|------------|---------------|---------|
| | MHz | dBuV/m | dB | dBuV/m | dBuV | dB/m | dB | dB | |
| 1 | 4874.000 | 45.68 | -8.32 | 54.00 | 40.34 | 35.18 | 4.61 | 34.45 | Average |
| 2 | 4874.000 | 58.59 | -15.41 | 74.00 | 53.25 | 35.18 | 4.61 | 34.45 | Peak |
| 3 | 7311.000 | 45.14 | -8.86 | 54.00 | 36.87 | 36.92 | 5.64 | 34.29 | Average |
| 4 | 7311.000 | 59.00 | -15.00 | 74.00 | 50.73 | 36.92 | 5.64 | 34.29 | Peak |
| 5 | 9748.000 | 56.79 | | | 46.30 | 38.71 | 6.36 | 34.58 | Peak |

Note: The item 5 is on un-restricted band, so the limit is -20dB for the field strength of the fundamental emissions (see section 3.6.7).

| | | | |
|-----------------|---------------|---------------|-----------------------|
| Final Test Date | Aug. 31, 2010 | Test Site No. | 03CH02-HY |
| Temperature | 28 | Humidity | 55% |
| Test Engineer | Eddie | Configuration | 802.11n Ch. 9 (40MHz) |

Horizontal

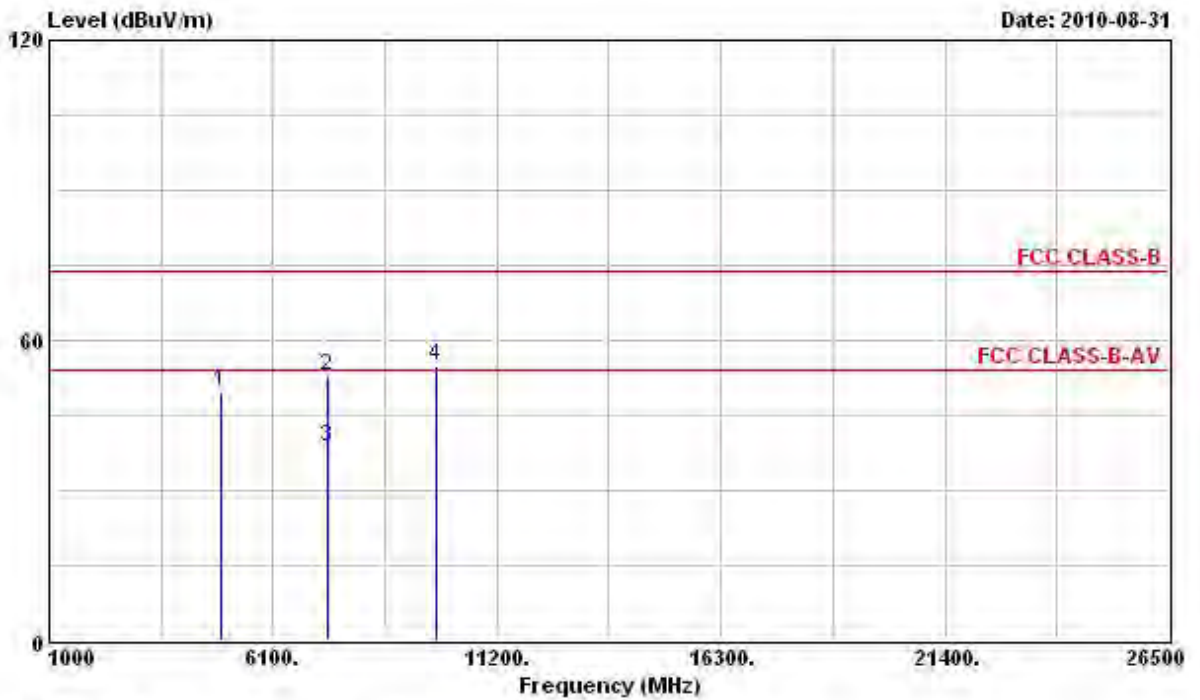

| | Freq | Level | Over Limit | Limit Line | ReadAntenna Level | Antenna Factor | Cable Loss | Preamp Factor | Remark |
|---|----------|--------|------------|------------|-------------------|----------------|------------|---------------|---------|
| | MHz | dBuV/m | dB | dBuV/m | dBuV | dB/m | dB | dB | |
| 1 | 4904.000 | 49.70 | -4.30 | 54.00 | 43.60 | 35.88 | 4.64 | 34.42 | PK |
| 2 | 7356.000 | 53.02 | -20.98 | 74.00 | 43.80 | 37.87 | 5.64 | 34.29 | Peak |
| 3 | 7356.000 | 38.86 | -15.14 | 54.00 | 29.64 | 37.87 | 5.64 | 34.29 | Average |
| 4 | 9808.000 | 54.98 | | | 43.60 | 39.57 | 6.37 | 34.56 | Peak |

Note: The item 4 is on un-restricted band, so the limit is -20dB for the field strength of the fundamental emissions (see section 3.6.7).

Vertical

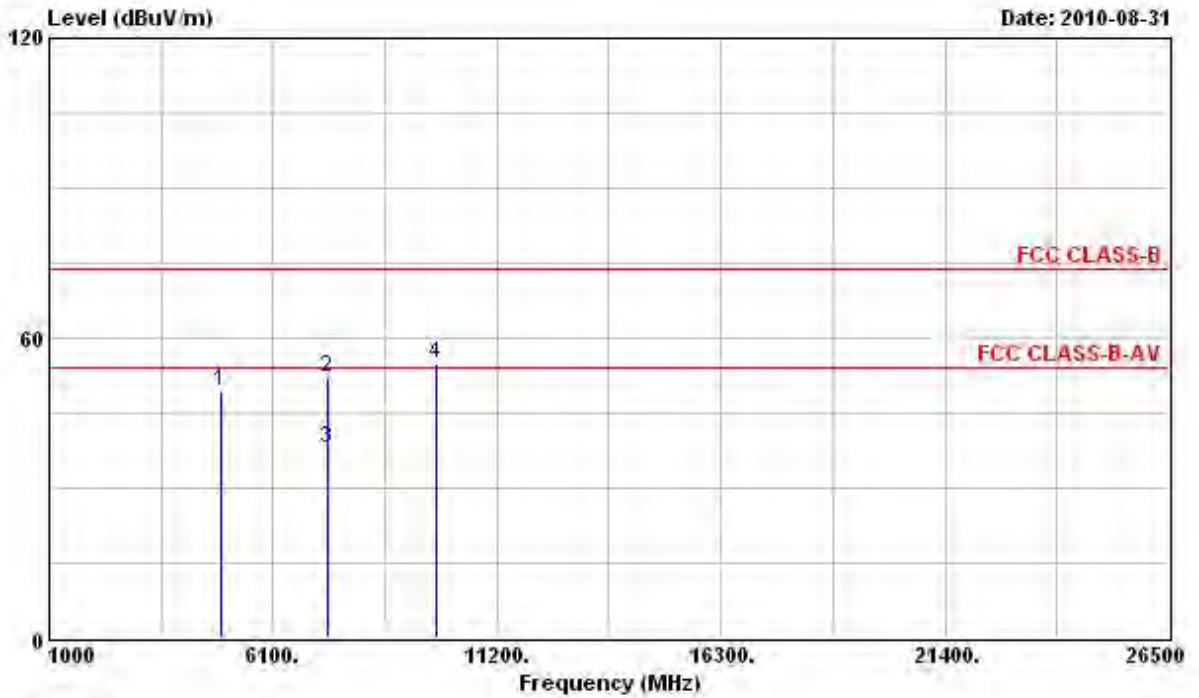

| Freq | Level | Over Limit | Limit Line | ReadAntenna Level | Antenna Factor | Cable Loss | Preamp Factor | Remark |
|------|----------|------------|------------|-------------------|----------------|------------|---------------|---------------|
| MHz | dBuV/m | dB | dBuV/m | dBuV | dB/m | dB | dB | |
| 1 | 4904.000 | 49.22 | -4.78 | 54.00 | 43.79 | 35.21 | 4.64 | 34.42 PK |
| 2 | 7356.000 | 52.18 | -21.82 | 74.00 | 43.89 | 36.94 | 5.64 | 34.29 Peak |
| 3 | 7356.000 | 37.96 | -16.04 | 54.00 | 29.67 | 36.94 | 5.64 | 34.29 Average |
| 4 | 9808.000 | 55.02 | | | 44.44 | 38.77 | 6.37 | 34.56 Peak |

Note: The item 4 is on un-restricted band, so the limit is -20dB for the field strength of the fundamental emissions (see section 3.6.7).

Emission level (dBuV/m) = 20 log Emission level (uV/m).

Corrected Reading: Antenna Factor + Cable Loss + Read Level - Preamp Factor = Level.

3.6 Band Edge and Fundamental Emissions Measurement

3.6.1 Limit

20dBc in any 100 kHz bandwidth outside the operating frequency band. In case the emission fall within the restricted band specified on 15.205(a), then the 15.209(a) limit in the table below has to be followed.

| Frequencies (MHz) | Field Strength (micorvolts/meter) | Measurement Distance (meters) |
|------------------------------|--|--|
| 0.009~0.490 | 2400/F(KHz) | 300 |
| 0.490~1.705 | 24000/F(KHz) | 30 |
| 1.705~30.0 | 30 | 30 |
| 30~88 | 100 | 3 |
| 88~216 | 150 | 3 |
| 216~960 | 200 | 3 |
| Above 960 | 500 | 3 |

3.6.2 Measuring Instruments and Setting

Please refer to section 4 of equipments list in this report. The following table is the setting of the spectrum analyzer.

| Spectrum Parameter | Setting |
|---|--|
| Attenuation | Auto |
| Span Frequency | 100 MHz |
| RB / VB (Emission in restricted band) | 1MHz / 1MHz for Peak, 1 MHz / 10Hz for Average |
| RB / VB (Emission in non-restricted band) | 1MHz / 1MHz for Peak |

3.6.3 Test Procedures

1. The test procedure is the same as section 3.5.3; only the frequency range investigated is limited to 100MHz around band edges.
2. In case the emission is fail due to the used RB/VB is too wide, marker-delta method of FCC Public Notice DA00-705 will be followed.

3.6.4 Test Setup Layout

This test setup layout is the same as that shown in section 3.5.4.

3.6.5 Test Deviation

There is no deviation with the original standard.

3.6.6 EUT Operation during Test

The EUT was programmed to be in continuously transmitting mode.

3.6.7 Test Result of Band Edge and Fundamental Emissions

| | | | |
|------------------------|---------------|----------------------|------------------------------|
| Final Test Date | Aug. 31, 2010 | Test Site No. | 03CH02-HY |
| Temperature | 28 | Humidity | 55% |
| Test Engineer | Daniel | Configuration | 802.11n Ch. 1, 6, 11 (20MHz) |

Channel 1

| | Freq | Level | Over Limit | Limit Line | ReadAntenna Level | Antenna Factor | Cable Loss | Preamp Factor | Remark |
|------------|-----------------|---------------|-------------------|-------------------|--------------------------|-----------------------|-------------------|----------------------|----------------|
| | MHz | dBuV/m | dB | dBuV/m | dBuV | dB/m | dB | dB | |
| 1 | 2359.780 | 62.69 | -11.31 | 74.00 | 27.80 | 31.90 | 2.99 | 0.00 | Peak |
| 2 @ | 2413.740 | 111.36 | | | 76.25 | 32.09 | 3.02 | 0.00 | Peak |
| 1 @ | 2359.780 | 50.29 | -3.71 | 54.00 | 15.40 | 31.90 | 2.99 | 0.00 | Average |
| 2 @ | 2414.690 | 100.52 | | | 65.41 | 32.09 | 3.02 | 0.00 | Average |

The item 2 is Fundamental Emissions.

Channel 6

| | Freq | Level | Over Limit | Limit Line | ReadAntenna Level | Antenna Factor | Cable Loss | Preamp Factor | Remark |
|------------|-----------------|---------------|-------------------|-------------------|--------------------------|-----------------------|-------------------|----------------------|----------------|
| | MHz | dBuV/m | dB | dBuV/m | dBuV | dB/m | dB | dB | |
| 1 @ | 2433.500 | 118.99 | | | 83.79 | 32.15 | 3.05 | 0.00 | Peak |
| 1 @ | 2433.500 | 108.07 | | | 72.87 | 32.15 | 3.05 | 0.00 | Average |

The item 1 is Fundamental Emissions.

Channel 11

| | Freq | Level | Over Limit | Limit Line | ReadAntenna Level | Antenna Factor | Cable Loss | Preamp Factor | Remark |
|------------|-----------------|---------------|-------------------|-------------------|--------------------------|-----------------------|-------------------|----------------------|----------------|
| | MHz | dBuV/m | dB | dBuV/m | dBuV | dB/m | dB | dB | |
| 1 @ | 2466.370 | 114.44 | | | 79.08 | 32.28 | 3.08 | 0.00 | Peak |
| 2 @ | 2483.660 | 70.08 | -3.92 | 74.00 | 34.66 | 32.34 | 3.08 | 0.00 | Peak |
| 1 @ | 2464.850 | 103.91 | | | 68.55 | 32.28 | 3.08 | 0.00 | Average |
| 2 @ | 2483.500 | 52.17 | -1.83 | 54.00 | 16.75 | 32.34 | 3.08 | 0.00 | Average |

The item 1 is Fundamental Emissions.

Note:

Emission level (dBuV/m) = 20 log Emission level (uV/m).

Corrected Reading: Antenna Factor + Cable Loss + Read Level - Preamp Factor = Level.

| | | | |
|------------------------|---------------|----------------------|-----------------------------|
| Final Test Date | Aug. 31, 2010 | Test Site No. | 03CH02-HY |
| Temperature | 28 | Humidity | 55% |
| Test Engineer | Daniel | Configuration | 802.11n Ch. 3, 6, 9 (40MHz) |

Channel 3

| | Freq | Level | Over Limit | Limit Line | ReadAntenna Level | Antenna Factor | Cable Loss | Preamp Factor | Remark |
|-----|-------------|--------------|-------------------|-------------------|--------------------------|-----------------------|-------------------|----------------------|---------------|
| | MHz | dBuV/m | dB | dBuV/m | dBuV | dB/m | dB | dB | |
| 1 | 2389.990 | 65.11 | -8.89 | 74.00 | 30.06 | 32.03 | 3.02 | 0.00 | Peak |
| 2 @ | 2418.490 | 108.45 | | | 73.34 | 32.09 | 3.02 | 0.00 | Peak |
| 1 @ | 2389.990 | 51.53 | -2.47 | 54.00 | 16.48 | 32.03 | 3.02 | 0.00 | Average |
| 2 @ | 2418.300 | 97.74 | | | 62.63 | 32.09 | 3.02 | 0.00 | Average |

The item 2 is Fundamental Emissions.

Channel 6

| | Freq | Level | Over Limit | Limit Line | ReadAntenna Level | Antenna Factor | Cable Loss | Preamp Factor | Remark |
|-----|-------------|--------------|-------------------|-------------------|--------------------------|-----------------------|-------------------|----------------------|---------------|
| | MHz | dBuV/m | dB | dBuV/m | dBuV | dB/m | dB | dB | |
| 1 X | 2434.450 | 106.26 | | | 71.29 | 31.92 | 3.05 | 0.00 | Peak |
| 1 @ | 2440.340 | 95.46 | | | 60.42 | 31.99 | 3.05 | 0.00 | Average |

The item 1 is Fundamental Emissions.

Channel 9

| | Freq | Level | Over Limit | Limit Line | ReadAntenna Level | Antenna Factor | Cable Loss | Preamp Factor | Remark |
|-----|-------------|--------------|-------------------|-------------------|--------------------------|-----------------------|-------------------|----------------------|---------------|
| | MHz | dBuV/m | dB | dBuV/m | dBuV | dB/m | dB | dB | |
| 1 @ | 2448.130 | 110.24 | | | 74.98 | 32.21 | 3.05 | 0.00 | Peak |
| 2 | 2484.420 | 67.91 | -6.09 | 74.00 | 32.49 | 32.34 | 3.08 | 0.00 | Peak |
| 1 @ | 2448.130 | 99.43 | | | 64.17 | 32.21 | 3.05 | 0.00 | Average |
| 2 @ | 2484.420 | 52.49 | -1.51 | 54.00 | 17.07 | 32.34 | 3.08 | 0.00 | Average |

The item 1 is Fundamental Emissions.

Note:

Emission level (dBuV/m) = 20 log Emission level (uV/m).

Corrected Reading: Antenna Factor + Cable Loss + Read Level - Preamp Factor = Level.

For Emission not in Restricted Band

| | | | |
|-----------------|---------------|---------------|---------|
| Final Test Date | Aug. 17, 2010 | Test Site No. | TH01-HY |
| Temperature | 24 | Humidity | 60% |
| Test Engineer | Ian | Configuration | 802.11n |

Low Band Edge Plot on Configuration of IEEE 802.11n (20MHz) / 2412 MHz

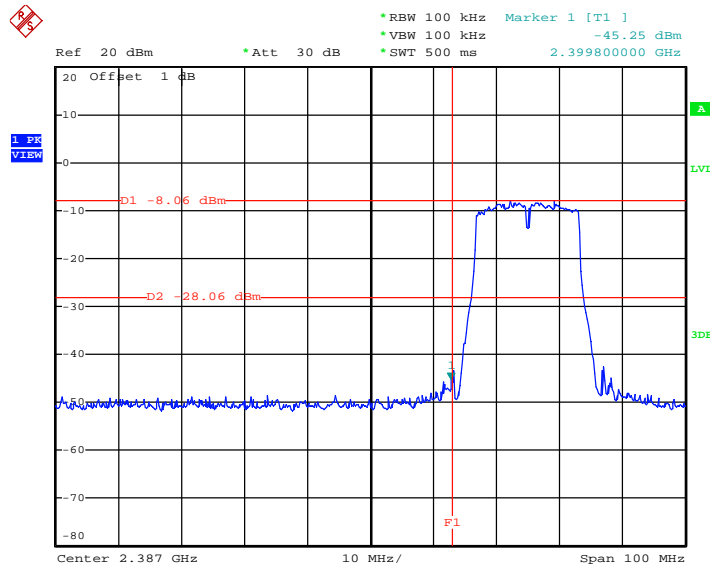

Date: 17.AUG.2010 17:55:53

High Band Edge Plot on Configuration of IEEE 802.11n (20MHz) / 2462 MHz

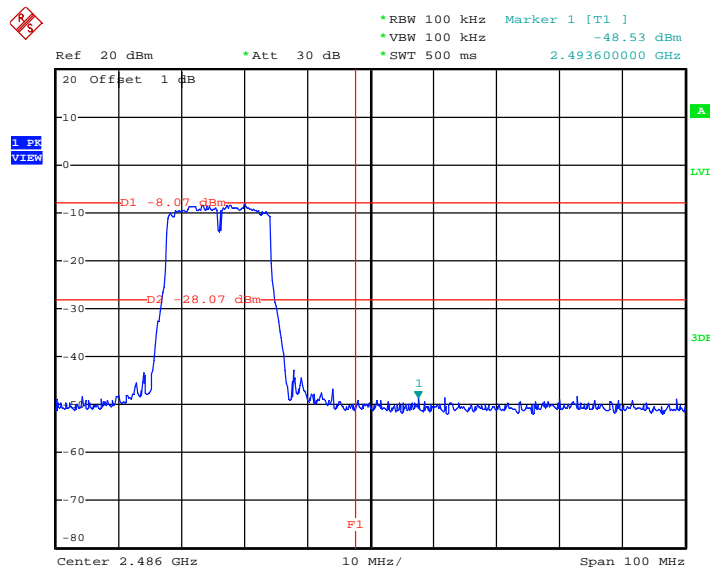

Date: 17.AUG.2010 18:02:00

Low Band Edge Plot on Configuration of IEEE 802.11n (40MHz) / 2422 MHz

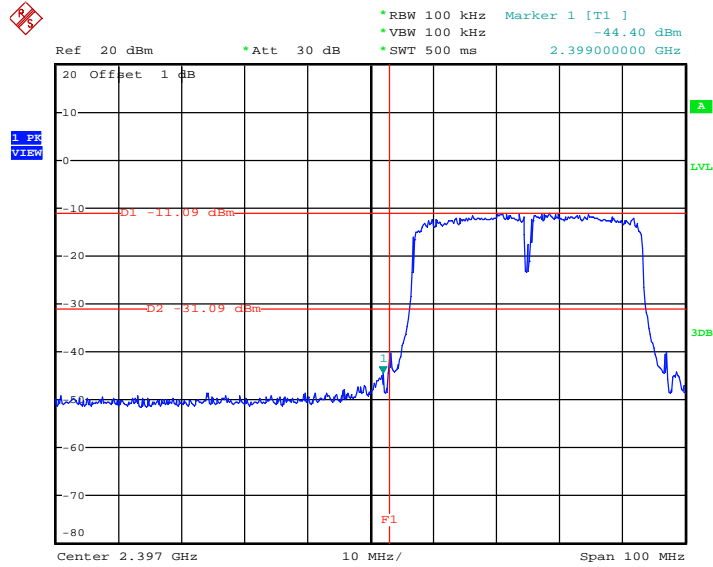

Date: 17.AUG.2010 18:13:54

High Band Edge Plot on Configuration of IEEE 802.11n (40MHz) / 2452 MHz

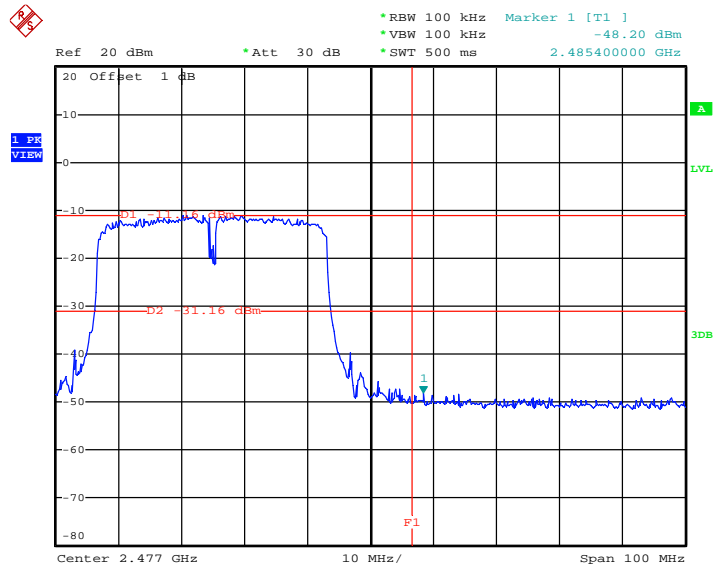

Date: 17.AUG.2010 18:21:09

3.7 Antenna Requirements

3.7.1 Limit

Except for special regulations, the Low-power Radio-frequency Devices must not be equipped with any jacket for installing an antenna with extension cable. An intentional radiator shall be designed to ensure that no antenna other than that furnished by the responsible party shall be used with the device. The use of a permanently attached antenna or of an antenna that uses a unique coupling to the intentional radiator shall be considered sufficient to comply with the provisions of this Section. The manufacturer may design the unit so that the user can replace a broken antenna, but the use of a standard antenna jack or electrical connector is prohibited.

3.7.2 Antenna Connector Construction

Please refer to section 2.3 in this test report; antenna connector complied with the requirements.

4 LIST OF MEASURING EQUIPMENTS

| Instrument | Manufacturer | Model No. | Serial No. | Characteristics | Calibration Date | Remark |
|--------------|--------------------|-----------|------------|------------------|------------------|----------------------|
| Receiver | R&S | ESCS 30 | 838251/003 | 9 kHz - 2.75 GHz | Apr. 16, 2010 | Conduction (CO01-LK) |
| LISN | Rolf Heine | NNB-2/16Z | 98087 | 9 kHz - 30 MHz | Oct. 07, 2009 | Conduction (CO01-LK) |
| RF Cable-CON | Suhner Switzerland | RG223/U | CB017 | 9 kHz - 30 MHz | Nov. 04, 2009 | Conduction (CO01-LK) |

Note: Calibration Interval of instruments listed above is one year.

| Instrument | Manufacturer | Model No. | Serial No. | Characteristics | Calibration Date | Remark |
|----------------------------|--------------|--------------|-------------|-----------------|------------------|---------------------|
| Spectrum Analyzer | R&S | FSU26.5 | 100015 | 20Hz ~ 26.5GHz | Oct. 29, 2009 | Conducted (TH01-HY) |
| DC Power Source | G.W. | GPC-6030D | C671845 | DC 1V ~ 60V | Apr. 16, 2010 | Conducted (TH01-HY) |
| Temp. and Humidity Chamber | Giant Force | GTH-225-20-S | MAB0103-001 | N/A | Aug. 05, 2010 | Conducted (TH01-HY) |
| RF CABLE-1m | Jye Bao | RG142 | CB034-1m | 20MHz ~ 7GHz | Dec. 02, 2009 | Conducted (TH01-HY) |
| RF CABLE-2m | Jye Bao | RG142 | CB035-2m | 20MHz ~ 1GHz | Dec. 02, 2009 | Conducted (TH01-HY) |
| Signal Generator | R&S | SMR40 | 100116 | 10MHz ~ 40GHz | Mar. 30, 2010 | Conducted (TH01-HY) |
| Power Sensor | Anritsu | MA2411B | 0917017 | 300MHz~40GHz | Dec. 03, 2009 | Conducted (TH01-HY) |
| Power Meter | Anritsu | ML2495A | 0949003 | 300MHz~40GHz | Dec. 03, 2009 | Conducted (TH01-HY) |

Note: Calibration Interval of instruments listed above is one year.

| Instrument | Manufacturer | Model No. | Serial No. | Characteristics | Calibration Date | Remark |
|-----------------|--------------|-----------|-------------|-----------------|------------------|---------------------|
| AC Power Source | HPC | HPA-500W | HPA-9100024 | AC 0 ~ 300V | Jul. 26, 2010* | Conducted (TH01-HY) |

Note: Calibration Interval of instruments listed above is two year.

| Instrument | Manufacturer | Model No. | Serial No. | Characteristics | Calibration Date | Remark |
|--------------------------|----------------|-------------|------------|----------------------|------------------|-----------------------|
| Spectrum Analyzer | R&S | FSP40 | 100305/040 | 9 kHz - 40GHz | Feb. 02, 2010 | Radiation (03CH02-HY) |
| 3m Semi Anechoic Chamber | SIDT FRANKONIA | SAC-3M | 03CH02-HY | 30 MHz - 1 GHz 3m | May 01, 2010 | Radiation (03CH02-HY) |
| Amplifier | Agilent | 8447D | 2944A11146 | 100 kHz – 1.3 GHz | Jul. 23, 2010 | Radiation (03CH02-HY) |
| Amplifier | Agilent | 8449B | 3008A02373 | 1GHz – 26.5 GHz | Jul. 23, 2010 | Radiation (03CH02-HY) |
| Horn Antenna | ETS-LINDGREN | 3117 | 00091920 | 1GHz~18GHz | Oct. 22, 2009 | Radiation (03CH02-HY) |
| RF Cable-R03m | Jye Bao | RG142 | CB021 | 30MHz ~ 1GHz | Feb. 26, 2010 | Radiation (03CH02-HY) |
| RF Cable-HIGH | SUHNER | SUCOFLEX106 | 03CH02-HY | 1GHz~40GHz | Feb. 26, 2010 | Radiation (03CH02-HY) |
| Bilog Antenna | SCHAFFNER | CBL61128 | 2723 | 30 MHz - 2 GHz | Nov. 30, 2009 | Radiation (03CH02-HY) |
| Turn Table | HD | DS 420 | 420/649/00 | 0 - 360 degree | N/A | Radiation (03CH02-HY) |
| Antenna Mast | HD | MA 240 | 240/559/00 | 1 m - 4 m | N/A | Radiation (03CH02-HY) |

Note: Calibration Interval of instruments listed above is one year.

| Instrument | Manufacturer | Model No. | Serial No. | Characteristics | Calibration Date | Remark |
|--------------|--------------|-----------|------------|-----------------|------------------|-----------------------|
| Loop Antenna | R&S | HFH2-Z2 | 860004/001 | 9 kHz - 30 MHz | Jul. 29, 2010* | Radiation (03CH02-HY) |

Note: Calibration Interval of instruments listed above is one year.

5 TEST LOCATION

| | |
|--------|--|
| SHIJR | ADD : 6Fl., No. 106, Sec. 1, Shintai 5th Rd., Shijr City, Taipei, Taiwan 221, R.O.C. TEL : 886-2-2696-2468 FAX : 886-2-2696-2255 |
| HWA YA | ADD : No. 52, Hwa Ya 1st Rd., Kwei-Shan Hsiang, Tao Yuan Hsien, Taiwan, R.O.C. TEL : 886-3-327-3456 FAX : 886-3-318-0055 |
| LINKOU | ADD : No. 30-2, Dingfu Tsuen, Linkou Shiang, Taipei, Taiwan 244, R.O.C TEL : 886-2-2601-1640 FAX : 886-2-2601-1695 |
| DUNGHU | ADD : No. 3, Lane 238, Kangle St., Neihu Chiu, Taipei, Taiwan 114, R.O.C. TEL : 886-2-2631-4739 FAX : 886-2-2631-9740 |
| JUNGHE | ADD : 7Fl., No. 758, Jungjeng Rd., Junghe City, Taipei, Taiwan 235, R.O.C. TEL : 886-2-8227-2020 FAX : 886-2-8227-2626 |
| NEIHU | ADD : 4Fl., No. 339, Hsin Hu 2 nd Rd., Taipei 114, Taiwan, R.O.C. TEL : 886-2-2794-8886 FAX : 886-2-2794-9777 |
| JHUBEI | ADD : No.8, Lane 724, Bo-ai St., Jhubei City, HsinChu County 302, Taiwan, R.O.C. TEL : 886-3-656-9065 FAX : 886-3-656-9085 |

6 TAF CERTIFICATE OF ACCREDITATION



Certificate No. : L1190-100529

財團法人全國認證基金會
Taiwan Accreditation Foundation

Certificate of Accreditation

This is to certify that

Sporton International Inc.
EMC & Wireless Communications Laboratory
No.52, Hwa Ya 1st Rd., Hwa Ya Technology Park, Kwei-Shan Hsiang, Tao Yuan Hsien,
Taiwan, R.O.C.

is accredited in respect of laboratory

| | |
|---------------------------------------|--|
| Accreditation Criteria | : ISO/IEC 17025:2005 |
| Accreditation Number | : 1190 |
| Originally Accredited | : December 15, 2003 |
| Effective Period | : January 10, 2010 to January 09, 2013 |
| Accredited Scope | : Testing Field, see described in the Appendix |
| Specific Accreditation Program | : Accreditation Program for Designated Testing Laboratory for Commodities Inspection Accreditation Program for Telecommunication Equipment Testing Laboratory Accreditation Program for BSMI Mutual Recognition Arrangement with Foreign Authorities |



Jay-San Chen
President, Taiwan Accreditation Foundation
Date : May 29, 2010

P1, total 23 pages

The Appendix forms an integral part of this Certificate, which shall be invalid when use without the Appendix