



Inter**Lab**<sup>®</sup>

FCC Measurement/Technical Report on

GSM/UMTS Module

MO0301

**Report Reference:** MDE\_Opti\_0709\_FCCe

**Test Laboratory:**

7 layers AG  
Borsigstrasse 11  
40880 Ratingen  
Germany  
email: [info@7Layers.de](mailto:info@7Layers.de)



**Note:**

The following test results relate only to the devices specified in this document. This report shall not be reproduced in parts without the written approval of the testing laboratory.

7 layers AG  
Borsigstrasse 11  
40880 Ratingen, Germany  
Phone: +49 (0) 2102 749 0  
Fax: +49 (0) 2102 749 350  
[www.7Layers.com](http://www.7Layers.com)

*Aufsichtsratsvorsitzender •  
Chairman of the Supervisory Board:  
Markus Becker  
Vorstand • Board:  
Dr. Hans-Jürgen Meckelburg  
René Schildknecht*

*Registergericht • registered in:  
Düsseldorf, HRB 44096  
USt-IdNr • VAT Nr:  
DE 203159652*

InterLab<sup>®</sup> is a registered trademark of 7 layers AG



## Table of Contents

<b>0 Summary</b>	<b>3</b>
0.1 Technical Report Summary	3
0.2 Measurement Summary	4
<b>1 Administrative Data</b>	<b>6</b>
1.1 Testing Laboratory	6
1.2 Project Data	6
1.3 Applicant Data	6
1.4 Manufacturer Data	6
<b>2 Testobject Data</b>	<b>7</b>
2.1 General EUT Description	7
2.2 EUT Main components	8
2.3 Ancillary Equipment	8
2.4 EUT Setups	8
2.5 Operating Modes	9
<b>3 Test Results</b>	<b>10</b>
3.1 RF Power Output	10
3.2 Frequency stability	13
3.3 Spurious emissions at antenna terminals	18
3.4 Field strength of spurious radiation	22
3.5 Emission and Occupied Bandwidth	26
3.6 Band edge compliance	29
<b>4 Test Equipment</b>	<b>32</b>
<b>5 Photo Report</b>	<b>35</b>
<b>6 Setup Drawings</b>	<b>38</b>
<b>7 Annex</b>	<b>40</b>
Measurement Plots	



## **0 Summary**

### **0.1 Technical Report Summary**

#### **Type of Authorization**

Certification for a GSM cellular radiotelephone device

#### **Applicable FCC Rules**

Prepared in accordance with the requirements of FCC Rules and Regulations as listed in 47 CFR Ch.1 Parts 0 to 19 and Parts 20 to 69 (10-1-06 Edition). The following subparts are applicable to the results in this test report.

##### Part 2

Subpart J - Equipment Authorization Procedures, Certification

- § 2.1046 Measurement required: RF power output
- § 2.1049 Measurement required: Occupied bandwidth
- § 2.1051 Measurement required: Spurious emissions at antenna terminals
- § 2.1053 Measurement required: Field strength of spurious radiation
- § 2.1055 Measurement required: Frequency stability
- § 2.1057 Frequency spectrum to be investigated

##### Part 24

Subpart E - Broadband PCS

- § 24.232 Power and antenna height limits
- § 24.235 Frequency stability
- § 24.236 Field strength limits
- § 24.238 Emission limitations for Broadband PCS equipment

#### **Summary Test Results:**

**The EUT complied with all performed tests as listed in chapter 0.2 Measurement Summary.**



## 0.2 Measurement Summary

---

### RF Power Output

The measurement was performed according to FCC §2.1046 10-1-06

OP-Mode	Setup	Port	Final Result
op-mode 1	Setup_a02	antenna connector	passed
op-mode 2	Setup_a02	antenna connector	passed
op-mode 3	Setup_a02	antenna connector	passed
op-mode 4	Setup_a02	antenna connector	passed
op-mode 5	Setup_a02	antenna connector	passed
op-mode 6	Setup_a02	antenna connector	passed
op-mode 7	Setup_a02	antenna connector	passed
op-mode 8	Setup_a02	antenna connector	passed
op-mode 9	Setup_a02	antenna connector	passed

---

### Frequency stability

The measurement was performed according to FCC §2.1055 10-1-06

OP-Mode	Setup	Port	Final Result
op-mode 2	Setup_a02	antenna connector	passed
op-mode 4	Setup_a02	antenna connector	passed
op-mode 8	Setup_a02	antenna connector	passed

---

### Spurious emissions at antenna terminals

The measurement was performed according to FCC §2.1051 10-1-06

OP-Mode	Setup	Port	Final Result
op-mode 1	Setup_a01	antenna connector	passed
op-mode 2	Setup_a01	antenna connector	passed
op-mode 3	Setup_a01	antenna connector	passed
op-mode 4	Setup_a01	antenna connector	passed
op-mode 5	Setup_a01	antenna connector	passed
op-mode 6	Setup_a01	antenna connector	passed
op-mode 7	Setup_a01	antenna connector	passed
op-mode 8	Setup_a01	antenna connector	passed
op-mode 9	Setup_a01	antenna connector	passed

---

### Field strength of spurious radiation

The measurement was performed according to FCC §2.1053 10-1-06

OP-Mode	Setup	Port	Final Result
op-mode 1	Setup_a03	Enclosure	passed
op-mode 2	Setup_a03	Enclosure	passed
op-mode 3	Setup_a03	Enclosure	passed
op-mode 4	Setup_a03	Enclosure	passed
op-mode 5	Setup_a03	Enclosure	passed
op-mode 6	Setup_a03	Enclosure	passed
op-mode 7	Setup_a03	Enclosure	passed
op-mode 8	Setup_a03	Enclosure	passed
op-mode 9	Setup_a03	Enclosure	passed

---

**Emission and Occupied Bandwidth**

The measurement was performed according to FCC §2.1049 10-1-06

OP-Mode	Setup	Port	Final Result
op-mode 1	Setup_a01	antenna connector	passed
op-mode 2	Setup_a01	antenna connector	passed
op-mode 3	Setup_a01	antenna connector	passed
op-mode 4	Setup_a01	antenna connector	passed
op-mode 5	Setup_a01	antenna connector	passed
op-mode 6	Setup_a01	antenna connector	passed
op-mode 7	Setup_a01	antenna connector	passed
op-mode 8	Setup_a01	antenna connector	passed
op-mode 9	Setup_a01	antenna connector	passed

---

**Band edge compliance**

The measurement was performed according to FCC §24.238 10-1-06

OP-Mode	Setup	Port	Final Result
op-mode 1	Setup_a01	antenna connector	passed
op-mode 3	Setup_a01	antenna connector	passed
op-mode 4	Setup_a01	antenna connector	passed
op-mode 6	Setup_a01	antenna connector	passed
op-mode 7	Setup_a01	antenna connector	passed
op-mode 9	Setup_a01	antenna connector	passed

This test report replaces the 7 layers test report reference MDE\_Opti\_0709b, dated 2007-08-03.



7 layers AG, Borsigstr. 11  
40880 Ratingen, Germany  
Phone +49 (0)2102 749 0

Responsible for  
Accreditation Scope:

J. Hell

Responsible  
for Test Report:

A. Pez



## 1 Administrative Data

### 1.1 Testing Laboratory

Company Name: 7 Layers AG  
Address Borsigstr. 11  
40880 Ratingen  
Germany

This facility has been fully described in a report submitted to the FCC and accepted under the registration number 96716 .

The test facility is also accredited by the following accreditation organisation:  
- Deutscher Akkreditierungs Rat DAR-Registration no. DAT-P-192/99-01

Responsible for Accreditation Scope: Dipl.-Ing. Bernhard Retka  
Dipl.-Ing. Robert Machulec  
Dipl.-Ing. Thomas Hoell

Report Template Version: 2006-12-18

### 1.2 Project Data

Responsible for testing and report: Dipl.-Ing. Andreas Petz  
Receipt of EUT: 2007-05-16  
Date of Test(s): 2007-06-22 to 2007-07-12  
Date of Report: 2007-08-10

### 1.3 Applicant Data

Company Name: Option NV  
Address: Gaston Geenslaan 14  
3001 Leuven  
Belgium  
Contact Person: Mr. Lodeweyckx

### 1.4 Manufacturer Data

Company Name: please see applicant data  
Address:  
Contact Person:



## 2 Testobject Data

### 2.1 General EUT Description

<b>Equipment under Test:</b>	GSM/UMTS Module
<b>Type Designation:</b>	MO0301
<b>Kind of Device:</b>	GSM 850/900/1800/1900 + UTRA FDD I/II/V
<b>(optional)</b>	including HSDPA
<b>Voltage Type:</b>	DC
<b>Nominal Voltage:</b>	3.6 V
<b>Maximum Voltage:</b>	3.6 V
<b>Minimum Voltage:</b>	3.0V

#### **General product description:**

The Equipment under Test (EUT) is a data card that supports GSM/EDGE 850/900/1800/1900 and FDD I, II and V with HSDPA.

The manufacturer declared that nominal voltage is equal to high voltage.

In PCS1900 mode the EUT operates in blocks A through F from 1850.2 MHz (lowest channel = 512) to 1909.8 MHz (highest channel = 810).

In FDD II mode the EUT operates in channel blocks A through F from 1852.4 MHz (lowest channel = 9262) to 1907.6 MHz (highest channel = 9538).

#### **The EUT provides the following ports:**

##### **Ports**

antenna connector  
enclosure

**The main components of the EUT are listed and described in Chapter 2.2**



## 2.2 EUT Main components

### Type, S/N, Short Descriptions etc. used in this Test Report

Short Description	Equipment under Test	Type Designation	Serial No.	HW Status	SW Status	Date of Receipt
EUT A (Code: 37250a01)	GSM/UMTS Module	MO0301	0044014404 94298	2.0	2.5.0	2007-06-18
Remark: EUT A is equipped with a permanent antenna connector.						
EUT B (Code: 37250b01)	GSM/UMTS Module	MO0301	0044014404 94199	2.0	2.5.0	2007-06-18
Remark: EUT B is equipped with a permanent antenna connector (gain= 2.0 dBi).						

**NOTE:** The short description is used to simplify the identification of the EUT in this test report.

## 2.3 Ancillary Equipment

For the purposes of this test report, ancillary equipment is defined as equipment which is used in conjunction with the EUT to provide operational and control features to the EUT. It is necessary to configure the system in a typical fashion, as a customer would normally use it. But nevertheless Ancillary Equipment can influence the test results.

Short Description	Equipment under Test	Type Designation	HW Status	SW Status	Serial no.	FCC ID
AE1	Test Cradle	Cobra SPQ Cradle	V 1.0	-	-	-
AE2	Test Cradle	Pepijn	V 2.0	-	-	-
AE3	External antenna "omni-directional quadriband"	Telsa T01111916 antenna gain: 2.0 dBi				

## 2.4 EUT Setups

This chapter describes the combination of EUTs and ancillary equipment used for testing.

Setup No.	Combination of EUTs	Description
Setup_a01	EUT A + AE2	setup for conducted tests
Setup_a02	EUT B + AE1	setup for conducted tests
Setup_a03	EUT B + AE1 + AE3	setup for radiated tests





## 2.5 Operating Modes

This chapter describes the operating modes of the EUT's used for testing.

Op. Mode	Description of Operating Modes	Remarks
<b>PCS data call</b>		
op-mode 1	Call established on Traffic Channel (TCH) 512, Carrier Frequency 1850.2 MHz	512 is the lowest channel PCS data call
op-mode 2	Call established on Traffic Channel (TCH) 661, Carrier Frequency 1880 MHz	661 is a mid channel PCS data call
op-mode 3	Call established on Traffic Channel (TCH) 810, Carrier Frequency 1909.8 MHz	810 is the highest channel PCS data call
<b>EDGE data call</b>		
op-mode 4	Call established on Traffic Channel (TCH) 512, Carrier Frequency 1850.2 MHz	512 is the lowest channel EDGE data call
op-mode 5	Call established on Traffic Channel (TCH) 661, Carrier Frequency 1880 MHz	661 is a mid channel EDGE data call
op-mode 6	Call established on Traffic Channel (TCH) 810, Carrier Frequency 1909.8 MHz	810 is the highest channel EDGE data call
<b>FDD II data call CS mode</b>		
op-mode 7	Call established on Traffic Channel (TCH) 9262, Carrier Frequency 1852.4 MHz	9262 is the lowest channel FDD II data call
op-mode 8	Call established on Traffic Channel (TCH) 9400, Carrier Frequency 1880 MHz	9400 is a mid channel FDD II data call
op-mode 9	Call established on Traffic Channel (TCH) 9538, Carrier Frequency 1907.6 MHz	9538 is the highest channel FDD II data call



## 3 Test Results

### 3.1 RF Power Output

**Standard** FCC Part 24, 10-1-06  
Subpart E

The test was performed according to: FCC §2.1046, 10-1-06

#### 3.1.1 Test Description

- 1) The EUT was coupled to the R&S Spectrum Analyser and the R&S CMD55 / CMU200 Digital Communication Tester through a Power Divider. Refer to chapter "Setup Drawings".
- 2) The total insertion losses for RF Path 1 and RF Path 2 were measured. The values were used to correct the readings from the R&S Spectrum Analyser and the R&S CMD55 / CMU200 Digital Communication Tester.
- 3) A call was established between the EUT and the base station simulator (R&S CMU200 Digital Communication Tester). The EUT was set to maximum output power. Other important settings are mentioned in the chapter "operating modes".
- 4) The transmitted power of the EUT was recorded by using an internal measurement function of the CMU200.

#### 3.1.2 Test Requirements / Limits

§2.1046 Measurements Required: RF Power Output

(a) For transmitters other than single sideband, independent sideband and controlled carrier radiotelephone, power output shall be measured at the RF output terminals when the transmitter is adjusted in accordance with the tune-up procedure to give the values of current and voltage on the circuit elements specified in § 2.1033(c)(8). The electrical characteristics of the output terminals when this test is made shall be stated.

§24.232 Power and antenna height limits

(c) Mobile/portable stations are limited to 2 watts EIRP peak power and the equipment must employ means to limit the power to the minimum necessary for successful communications.

(d) Peak transmit power must be measured over any interval of continuous transmission using instrumentation calibrated in terms of an rms-equivalent voltage. The measurement results shall be properly adjusted for any instrument limitations, such as detector response times, limited resolution bandwidth capability when compared to the emission bandwidth, sensitivity, etc., so as to obtain a true peak measurement for the emission in question over the full bandwidth of the channel.



### 3.1.3 Test Protocol

Temperature: 25 °C  
Air Pressure: 1008 hPa  
Humidity: 36 %

---

Op. Mode	Setup	Port
op-mode 1	setup_a02	antenna connector

Power Control Level	Output power Nominal (dBm)	Output power Measured (dBm)	Difference dB
0	30	28.40	-1.60

Remark: none

---

Op. Mode	Setup	Port
op-mode 2	setup_a02	antenna connector

Power Control Level	Output power Nominal (dBm)	Output power Measured (dBm)	Difference dB
0	30	28.60	-1.40

Remark: none

---

Op. Mode	Setup	Port
op-mode 3	setup_a02	antenna connector

Power Control Level	Output power Nominal (dBm)	Output power Measured (dBm)	Difference dB
0	30	28.40	-1.60

Remark: none

---

Op. Mode	Setup	Port
op-mode 4	setup_a02	antenna connector

Power Control Level	Output power Nominal (dBm)	Output power Measured (dBm)	Difference dB
0	30	26.40	-3.60

Remark: none

---

Op. Mode	Setup	Port
op-mode 5	setup_a02	antenna connector

Power Control Level	Output power Nominal (dBm)	Output power Measured (dBm)	Difference dB
0	30	26.70	-3.30

Remark: none



**Op. Mode**      **Setup**                      **Port**

---

op-mode 6      setup\_a02                      antenna connector

Power Control Level	Output power Nominal (dBm)	Output power Measured (dBm)	Difference dB
0	30	26.60	-3.40

Remark: none

**Op. Mode**      **Setup**                      **Port**

---

op-mode 7      setup\_a02                      antenna connector

Power class	Output power Nominal (dBm)	Output power Measured (dBm)	Difference dB
3	24	24.56	0.56

Remark: none

**Op. Mode**      **Setup**                      **Port**

---

op-mode 8      setup\_a02                      antenna connector

Power class	Output power Nominal (dBm)	Output power Measured (dBm)	Difference dB
3	24	25.06	1.06

Remark: none

**Op. Mode**      **Setup**                      **Port**

---

op-mode 9      setup\_a02                      antenna connector

Power class	Output power Nominal (dBm)	Output power Measured (dBm)	Difference dB
3	24	24.85	0.85

Remark: none

### 3.1.4 Test result: RF Power Output

FCC Part 24, Subpart E	Op. Mode	Result
	op-mode 1	passed
	op-mode 2	passed
	op-mode 3	passed
	op-mode 4	passed
	op-mode 5	passed
	op-mode 6	passed
	op-mode 7	passed
	op-mode 8	passed
	op-mode 9	passed



## 3.2 Frequency stability

**Standard** FCC Part 24, 10-1-06  
Subpart E

**The test was performed according to** FCC §2.1055, 10-1-06

### 3.2.1 Test Description

- 1) The EUT was placed inside the climatic chamber.
- 2) The EUT was coupled to the R&S CMD55 / CMU200 Digital Communication Tester. Refer to chapter "Setup Drawings".
- 3) The climatic chamber was cycled down/up to a certain temperature.
- 4) After the temperature was stabilized (at least one hour) the EUT was switched on and a call was established between the EUT and the base station simulator (R&S CMU200 Digital Communication Tester). The EUT was set to maximum output power. Other important settings are mentioned in the chapter "operating modes".
- 5) The frequency error of the EUT were recorded by using an internal measurement function of the CMD55 / CMU200 immediately after the call was established, five minutes after the call was established and ten minutes after the call was established.
- 6) This measurement procedure was performed for all combinations of voltage (low, nominal, high) and temperature (from  $-30^{\circ}\text{C}$  to  $+50^{\circ}\text{C}$  in increments of  $10^{\circ}\text{C}$ ).

### 3.2.2 Test Requirements / Limits

§2.1055 Measurements required: Frequency stability

(a) The frequency stability shall be measured with variation of ambient temperature as follows:

(1) From  $-30^{\circ}$  to  $+50^{\circ}$  centigrade for all equipment except that specified in paragraphs (a) (2) and (3) of this section.

(b) Frequency measurements shall be made at the extremes of the specified temperature range and at intervals of not more than  $10^{\circ}$  centigrade through the range. A period of time sufficient to stabilize all of the components of the oscillator circuit at each temperature level shall be allowed prior to frequency measurement. The short term transient effects on the frequency of the transmitter due to keying (except for broadcast transmitters) and any heating element cycling normally occurring at each ambient temperature level also shall be shown. Only the portion or portions of the transmitter containing the frequency determining and stabilizing circuitry need be subjected to the temperature variation test.



(d) The frequency stability shall be measured with variation of primary supply voltage as follows:

(1) Vary primary supply voltage from 85 to 115 percent of the nominal value for other than hand carried battery equipment.

(2) For hand carried, battery powered equipment, reduce primary supply voltage to the battery operating end point which shall be specified by the manufacturer.

(3) The supply voltage shall be measured at the input to the cable normally provided with the equipment, or at the power supply terminals if cables are not normally provided. Effects on frequency of transmitter keying (except for broadcast transmitters) and any heating element cycling at the nominal supply voltage and at each extreme also shall be shown.

#### §24.235 Frequency stability

The frequency stability shall be sufficient to ensure that the fundamental emission stays within the authorized frequency block.

7Layers interpretation of limit:

To ensure that the frequency stability shall be sufficient to ensure that the fundamental emission stays within the authorized frequency block following limit was used:

+/- 2.5 ppm = 4700 Hz



### 3.2.3 Test Protocol

Temperature: 25 – 27 °C  
 Air Pressure: 995 - 1008 hPa  
 Humidity: 36 - 42 %

Op. Mode	Setup	Port
op-mode 2	setup_a02	antenna connector

		Normal Voltage / V	
		3.6	
Temp. °C	Duration min	Freq. error Average (Hz)	Freq. error Max. (Hz)
+50	0	-11	170
+50	5	-16	-44
+50	10	-19	-60
+40	0	-71	-112
+40	5	-11	175
+40	10	-7	-50
+30	0	-34	-169
+30	5	-31	-141
+30	10	-41	-171
+10	0	-63	-291
+10	5	-58	-303
+10	10	-50	-224
0	0	-33	-45
0	5	-48	-57
0	10	-37	220
-10	0	9	20
-10	5	-47	-59
-10	10	-62	-72
-20	0	21	40
-20	5	-5	-14
-20	10	-20	-30
-30	0	19	84
-30	5	-9	-22
-30	10	-12	-22

		Minimum Voltage / V		Normal Voltage / V		Maximum Voltage / V	
		85% = 3.06		100% = 3.6		3.9	
Temp. °C	Duration min	Freq. error Average (Hz)	Freq. error Max. (Hz)	Freq. error Average (Hz)	Freq. error Max. (Hz)	Freq. error Average (Hz)	Freq. error Max. (Hz)
+20	0	-34	575	-42	-528	-26	-684
+20	5	-6	422	-76	-723	-21	-1161
+20	10	-44	-632	-12	860	-48	-1320

Remark: The EUT did not operate at 115% of normal voltage. Instead the call was established at normal voltage and then increased to 3.9 V.

Op. Mode	Setup	Port
op-mode 5	setup_a02	antenna connector

		Normal Voltage / V	
		3.6	
Temp. °C	Duration min	Freq. error Average (Hz)	Freq. error Max. (Hz)
+50	0	-34	-80
+50	5	-53	-78
+50	10	-46	-82
+40	0	-70	-123
+40	5	-68	-102
+40	10	-55	-100
+30	0	-60	-215
+30	5	-32	-150
+30	10	-49	-159
+10	0	-33	483
+10	5	2	-678
+10	10	13	-419
0	0	-7	-33
0	5	-32	-44
0	10	-62	-74
-10	0	-2	-26
-10	5	-50	-60
-10	10	-60	-71
-20	0	-4	-66
-20	5	-41	-52
-20	10	-14	65
-30	0	18	69
-30	5	-3	-20
-30	10	-32	-45

		Minimum Voltage / V		Normal Voltage / V		Maximum Voltage / V	
		85%=3.06		100%=3.6		3.9	
Temp. °C	Duration min	Freq. error Average (Hz)	Freq. error Max. (Hz)	Freq. error Average (Hz)	Freq. error Max. (Hz)	Freq. error Average (Hz)	Freq. error Max. (Hz)
+20	0	-25	-53	-48	-84	-46	-89
+20	5	-63	-77	-50	-89	-33	-80
+20	10	-59	-70	-61	-75	-25	-83

Remark: The EUT did not operate at 115% of normal voltage. Instead the call was established at normal voltage and then increased to 3.9 V.





Op. Mode	Setup	Port
op-mode 8	setup_a02	antenna connector

		Normal Voltage / V	
		3.6	
Temp. °C	Duration min	Freq. error Average (Hz)	Freq. error Max. (Hz)
+50	0	-2	-98
+50	5	-6	-72
+50	10	0	68
+40	0	5	307
+40	5	0	-240
+40	10	9	404
+30	0	2	477
+30	5	4	500
+30	10	7	-407
+10	0	34	615
+10	5	14	636
+10	10	12	-517
0	0	-2	-29
0	5	1	-46
0	10	-1	-47
-10	0	-1	36
-10	5	0	33
-10	10	-1	-36
-20	0	-1	-24
-20	5	-2	-27
-20	10	-2	-32
-30	0	-2	-83
-30	5	1	-30
-30	10	2	43

		Minimum Voltage / V		Normal Voltage / V		Maximum Voltage / V	
		85%=3.06		100%=3.6		3.95	
Temp. °C	Duration min	Freq. error Average (Hz)	Freq. error Max. (Hz)	Freq. error Average (Hz)	Freq. error Max. (Hz)	Freq. error Average (Hz)	Freq. error Max. (Hz)
+20	0	-1	66	-2	-39	1	-40
+20	5	-5	-55	-2	-56	0	-57
+20	10	1	56	1	65	-1	-46

Remark: The EUT did not operate at 115% of normal voltage. Instead the call was established at normal voltage and then increased to 3.95 V.

### 3.2.4 Test result: Frequency stability

FCC Part 24, Subpart E	Op. Mode	Result
	op-mode 2	passed
	op-mode 5	passed
	op-mode 8	passed

### 3.3 Spurious emissions at antenna terminals

**Standard** FCC Part 24, 10-1-06  
Subpart E

**The test was performed according to** FCC §2.1051, 10-1-06

#### 3.3.1 Test Description

- 1) The EUT was coupled to the R&S Spectrum Analyser and the R&S CMD55 / CMU200 Digital Communication Tester through a Power Divider. Refer to chapter "Setup Drawings".
- 2) The total insertion losses for RF Path 1 and RF Path 2 were measured. The values were used to correct the readings from the R&S Spectrum Analyser and the R&S CMD55 / CMU200 Digital Communication Tester.
- 3) A call was established between the EUT and the base station simulator (R&S CMU200 Digital Communication Tester). The EUT was set to maximum output power. Other important settings are mentioned in the chapter "operating modes".
- 4) Important Analyser Settings
  - [Resolution Bandwidth / Video Bandwidth]:
    - a) [3 kHz / 10 kHz] in the Span of 1 MHz directly below and above the PCS-Band,
    - b) [10 kHz / 30 kHz] in case the curve of the analyser IF-Filter leads to an exceeding of the limit, in this case a worst case correction factor of 20 dB (1 MHz -> 10 kHz) was used
    - c) [1 MHz / 3 MHz] otherwise
  - Sweep Time: Calculated depending on the transmitting signal (technology), the span and the resolution bandwidth
- 5) The spurious emissions (peak) were measured in the frequency range from 9 kHz to 20 GHz (up to the 10th harmonic) during the call is established on the lowest channel

#### 3.3.2 Test Requirements / Limits

§ 2.1051 Spurious emissions at antenna terminals

The radio frequency voltage or power generated within the equipment and appearing on a spurious frequency shall be checked at the equipment output terminals when properly loaded with a suitable artificial antenna. Curves or equivalent data shall show the magnitude of each harmonic and other spurious emission that can be detected when the equipment is operated under the conditions specified in Sec. 2.1049 as appropriate. The magnitude of spurious emissions which are attenuated more than 20 dB below the permissible value need not be specified.



§ 2.1057 Frequency spectrum to be investigated.

(a) In all of the measurements set forth in Secs. 2.1051 and 2.1053, the spectrum shall be investigated from the lowest radio frequency signal generated in the equipment, without going below 9 kHz, up to at least the frequency shown below:

(1) If the equipment operates below 10 GHz: to the tenth harmonic of the highest fundamental frequency or to 40 GHz, whichever is lower.

(b) Particular attention should be paid to harmonics and subharmonics of the carrier frequency as well as to those frequencies removed from the carrier by multiples of the oscillator frequency. Radiation at the frequencies of multiplier stages should also be checked.

(c) The amplitude of spurious emissions which are attenuated more than 20 dB below the permissible value need not be reported.

(d) Unless otherwise specified, measurements above 40 GHz shall be performed using a minimum resolution bandwidth of 1 MHz.

§ 24.238 Emission limitations for Broadband PCS equipment

(a) The power of any emission outside of the authorized operating frequency ranges must be attenuated below the transmitting power (P) by a factor of at least  $43 + 10 \log(P)$  dB.

Remark of the test laboratory: This is calculated to be -13 dBm.

(b) Compliance with these rules is based on the use of measurement instrumentation employing a resolution bandwidth of 1 MHz or greater. However, in the 1 MHz bands immediately outside and adjacent to the frequency block a resolution bandwidth of at least one percent of the emission bandwidth of the fundamental emission of the transmitter may be employed. A narrower resolution bandwidth is permitted in all cases to improve measurement accuracy provided the measured power is integrated over the full required measurement bandwidth (i.e. 1 MHz or 1 percent of emission bandwidth, as specified). The emission bandwidth is defined as the width of the signal between two points, one below the carrier center frequency and one above the carrier center frequency, outside of which all emissions are attenuated at least 26 dB below the transmitter power.

(c) Licensees in this service may establish an alternative out of band emission limit to be used at specified band edge(s) in specified geographical areas [...].

(d) If any emission from a transmitter operating in this service results in interference to users of another radio service, the FCC may require a greater attenuation of that emission than specified in this section.

### 3.3.3 Test Protocol

Temperature: 26 °C  
 Air Pressure: 1005 hPa  
 Humidity: 42 %

Op. Mode	Setup	Port
op-mode 1	setup_a01	antenna connector

Frequency MHz	Bandwidth kHz	Measured Level dBm	Limit dBm
1849	3.0	-14.08	-13.0

Remark: No further spurious emissions were found in the range 20 dB below the limit.

Op. Mode	Setup	Port
op-mode 2	setup_a01	antenna connector

Frequency MHz	Bandwidth kHz	Measured Level dBm	Limit dBm
-	-	-	-13.0

Remark: No spurious emissions were found in the range 20 dB below the limit.

Op. Mode	Setup	Port
op-mode 3	setup_a01	antenna connector

Frequency MHz	Bandwidth kHz	Measured Level dBm	Limit dBm
1910	3.0	-13.70	-13.0

Remark: No further spurious emissions were found in the range 20 dB below the limit.

Op. Mode	Setup	Port
op-mode 4	setup_a01	antenna connector

Frequency MHz	Bandwidth kHz	Measured Level dBm	Limit dBm
1850	3.0	-21.35	-13.0

Remark: No further spurious emissions were found in the range 20 dB below the limit.

Op. Mode	Setup	Port
op-mode 5	setup_a01	antenna connector

Frequency MHz	Bandwidth kHz	Measured Level dBm	Limit dBm
-	-	-	-13.0

Remark: No spurious emissions were found in the range 20 dB below the limit.



Op. Mode	Setup	Port
op-mode 6	setup_a01	antenna connector

Frequency MHz	Bandwidth kHz	Measured Level dBm	Limit dBm
1910	3.0	-21.73	-13.0

Remark: No further spurious emissions were found in the range 20 dB below the limit.

Op. Mode	Setup	Port
op-mode 7	setup_a01	antenna connector

Frequency MHz	Bandwidth kHz	Measured Level dBm	Limit dBm
1849	3.0	-17.95	-13.0

Remark: No further spurious emissions were found in the range 20 dB below the limit.

Op. Mode	Setup	Port
op-mode 8	setup_a01	antenna connector

Frequency MHz	Bandwidth kHz	Measured Level dBm	Limit dBm
3740	1000	-22.57	-13.0

Remark: No further spurious emissions were found in the range 20 dB below the limit.

Op. Mode	Setup	Port
op-mode 9	setup_a01	antenna connector

Frequency MHz	Bandwidth kHz	Measured Level dBm	Limit dBm
1911	3.0	-25.37	-13.0
3809	1000	-19.64	-13.0

Remark: No further spurious emissions were found in the range 20 dB below the limit.

### 3.3.4 Test result: Spurious emissions at antenna terminals

FCC Part 24, Subpart E

Op. Mode	Result
op-mode 1	passed
op-mode 2	passed
op-mode 3	passed
op-mode 4	passed
op-mode 5	passed
op-mode 6	passed
op-mode 7	passed
op-mode 8	passed
op-mode 9	passed

### 3.4 Field strength of spurious radiation

**Standard** FCC Part 24, 10-1-06  
Subpart E

The test was performed according to: FCC §2.1053, 10-1-06

#### 3.4.1 Test Description

1) The EUT was placed inside an anechoic chamber. Refer to chapter "Setup Drawings". The EUT was coupled to the R&S CMD55 / CMU200 Digital Communication Tester which was located outside the chamber via coaxial cable.

2) A call was established between the EUT and the base station simulator (R&S CMU200 Digital Communication Tester). The EUT was set to maximum output power. Other important settings are mentioned in the chapter "operating modes".

3) A pre-calibration procedure is used so that the readings from the spectrum analyser are corrected and represent directly the equivalent radiated power (related to a  $\lambda/2$  dipole).

4) All spurious radiation measurements were made with spectrum analyser and the appropriate calibrated antennas for the frequency range of 30 MHz to 20 GHz (up to the 10th harmonic of the transmit frequency).

5) Important Analyser Settings

- [Resolution Bandwidth / Video Bandwidth]:

a) [3 kHz / 10 kHz] in the Span of 1 MHz directly below and above the GSM-Band,

b) [10 kHz / 30 kHz] in case the curve of the analyser IF-Filter leads to an exceeding of the limit, in this case a worst case correction factor of 20 dB (1 MHz -> 10 kHz) was used

c) [1 MHz / 3 MHz] otherwise

- Sweep Time: Calculated depending on the transmitting signal (technology), the span and the resolution bandwidth

6) The spurious emissions (peak) were measured in both vertical and horizontal antenna polarisation during the call is established on the lowest channel, mid channel and on the highest channel.

#### 3.4.2 Test Requirements / Limits

§ 2.1053 Measurements required: Field strength of spurious radiation.

Measurements shall be made to detect spurious emissions that may be radiated directly from the cabinet, control circuits, power leads, or intermediate circuit elements under normal conditions of installation and operation. Curves or equivalent data shall be supplied showing the magnitude of each harmonic and other spurious emission. For this test, single sideband, independent sideband, and controlled carrier transmitters shall be modulated under the conditions specified in paragraph (c) of Sec. 2.1049, as appropriate. For equipment operating on frequencies below 890 MHz, an open field test is normally required, with the measuring instrument antenna located in the far-field at all test frequencies. In the event it is either impractical or impossible to make open field measurements (e.g. a broadcast transmitter installed in a building) measurements will be accepted of the equipment as installed. Such measurements must be accompanied by a description of the site where the measurements were made showing the location of any



possible source of reflections which might distort the field strength measurements. Information submitted shall include the relative radiated power of each spurious emission with reference to the rated power output of the transmitter, assuming all emissions are radiated from halfwave dipole antennas.

(b) The measurements specified in paragraph (a) of this section shall be made for the following equipment:

(2) All equipment operating on frequencies higher than 25 MHz.

#### § 2.1057 Frequency spectrum to be investigated.

(a) In all of the measurements set forth in Secs. 2.1051 and 2.1053, the spectrum shall be investigated from the lowest radio frequency signal generated in the equipment, without going below 9 kHz, up to at least the frequency shown below:

(1) If the equipment operates below 10 GHz: to the tenth harmonic of the highest fundamental frequency or to 40 GHz, whichever is lower.

(b) Particular attention should be paid to harmonics and subharmonics of the carrier frequency as well as to those frequencies removed from the carrier by multiples of the oscillator frequency. Radiation at the frequencies of multiplier stages should also be checked.

(c) The amplitude of spurious emissions which are attenuated more than 20 dB below the permissible value need not be reported.

(d) Unless otherwise specified, measurements above 40 GHz shall be performed using a minimum resolution bandwidth of 1 MHz.

#### § 24.238 Emission limitations for Broadband PCS equipment

(a) The power of any emission outside of the authorized operating frequency ranges must be attenuated below the transmitting power (P) by a factor of at least  $43 + 10 \log(P)$  dB.

This is calculated to be -13 dBm (effective radiated power) which corresponds to 84.6 dB $\mu$ V/m (field strength) in a distance of 3 m.

(b) Compliance with these rules is based on the use of measurement instrumentation employing a resolution bandwidth of 1 MHz or greater. However, in the 1 MHz bands immediately outside and adjacent to the frequency block a resolution bandwidth of at least one percent of the emission bandwidth of the fundamental emission of the transmitter may be employed. A narrower resolution bandwidth is permitted in all cases to improve measurement accuracy provided the measured power is integrated over the full required measurement bandwidth (i.e. 1 MHz or 1 percent of emission bandwidth, as specified). The emission bandwidth is defined as the width of the signal between two points, one below the carrier center frequency and one above the carrier center frequency, outside of which all emissions are attenuated at least 26 dB below the transmitter power.

(c) Licensees in this service may establish an alternative out of band emission limit to be used at specified band edge(s) in specified geographical areas [...].

(d) If any emission from a transmitter operating in this service results in interference to users of another radio service, the FCC may require a greater attenuation of that emission than specified in this section.

### 3.4.3 Test Protocol

Temperature: 25 - 27 °C  
 Air Pressure: 1004 - 1013 hPa  
 Humidity: 34 - 48 %

Op. Mode	Setup	Port
op-mode 1	setup_a03	enclosure

Frequency MHz	Antenna Polarisation	Bandwidth kHz	Measured Level dBm	Limit dBm
1849	Horizontal	3.0	-15.76	-13.0
11101	Vertical	1000.0	-31.49	-13.0

Remark: No further spurious emissions were found in the range 20 dB below the limit.

Op. Mode	Setup	Port
op-mode 2	setup_a03	enclosure

Frequency MHz	Antenna Polarisation	Bandwidth kHz	Measured Level dBm	Limit dBm
11285	Vertical	1000.0	-25.53	-13.0

Remark: No further spurious emissions were found in the range 20 dB below the limit.

Op. Mode	Setup	Port
op-mode 3	setup_a03	enclosure

Frequency MHz	Antenna Polarisation	Bandwidth kHz	Measured Level dBm	Limit dBm
1910	Horizontal	3.0	-18.44	-13.0
11469	Vertical	1000.0	-23.63	-13.0

Remark: No further spurious emissions were found in the range 20 dB below the limit.

Op. Mode	Setup	Port
op-mode 4	setup_a03	enclosure

Frequency MHz	Antenna Polarisation	Bandwidth kHz	Measured Level dBm	Limit dBm
1849	Horizontal	3.0	-23.99	-13.0

Remark: No further spurious emissions were found in the range 20 dB below the limit.

Op. Mode	Setup	Port
op-mode 5	setup_a03	enclosure

Frequency MHz	Antenna Polarisation	Bandwidth kHz	Measured Level dBm	Limit dBm
11285	Vertical	1000.0	-25.15	-13.0

Remark: No further spurious emissions were found in the range 20 dB below the limit.





Op. Mode	Setup	Port
op-mode 6	setup_a03	enclosure

Frequency MHz	Antenna Polarisation	Bandwidth kHz	Measured Level dBm	Limit dBm
1910	Horizontal	3.0	-24.78	-13.0
11469	Vertical	1000.0	-23.63	-13.0

Remark: No further spurious emissions were found in the range 20 dB below the limit.

Op. Mode	Setup	Port
op-mode 7	setup_a03	enclosure

Frequency MHz	Antenna Polarisation	Bandwidth kHz	Measured Level dBm	Limit dBm
1845	Horizontal	3.0	-28.82	-13.0

Remark: No further spurious emissions were found in the range 20 dB below the limit.

Op. Mode	Setup	Port
op-mode 8	setup_a03	enclosure

Frequency MHz	Antenna Polarisation	Bandwidth kHz	Measured Level dBm	Limit dBm
3742	Horizontal	1000.0	-30.78	-13.0

Remark: No further spurious emissions were found in the range 20 dB below the limit.

Op. Mode	Setup	Port
op-mode 9	setup_a03	enclosure

Frequency MHz	Antenna Polarisation	Bandwidth kHz	Measured Level dBm	Limit dBm
1911	Horizontal	3.0	-28.76	-13.0
3803	Vertical	1000.0	-24.66	-13.0

Remark: No further spurious emissions were found in the range 20 dB below the limit.

### 3.4.4 Test result: Field strength of spurious radiation

FCC Part 24, Subpart E	Op. Mode	Result
	op-mode 1	passed
	op-mode 2	passed
	op-mode 3	passed
	op-mode 4	passed
	op-mode 5	passed
	op-mode 6	passed
	op-mode 7	passed
	op-mode 8	passed
	op-mode 9	passed



### 3.5 Emission and Occupied Bandwidth

**Standard** FCC Part 24, 10-1-06  
Subpart E

The test was performed according to: FCC §2.1049, 10-1-06

#### 3.5.1 Test Description

1) The EUT was coupled to the R&S Spectrum Analyser and the R&S CMD55 / CMU200 Digital Communication Tester through a Power Divider. Refer to chapter "Setup Drawings".

2) The total insertion losses for RF Path 1 and RF Path 2 were measured. The values were used to correct the readings from the R&S Spectrum Analyser and the R&S CMD55 / CMU200 Digital Communication Tester.

3) A call was established between the EUT and the base station simulator (R&S CMU200 Digital Communication Tester). The EUT was set to maximum output power. Other important settings are mentioned in the chapter "operating modes".

4) Important Analyser Settings:

- Resolution Bandwidth: 3 kHz (1% of the manufacturers stated occupied bandwidth)
- Video Bandwidth: 10 kHz (three times the Resolution Bandwidth)
- Sweep Span: 1 MHz ( at least 250% of the emission bandwidth)

5) The maximum spectral level of the modulated signal was recorded as the reference.

6) The emission bandwidth is measured as follows:  
the two furthest frequencies above and below the frequency of the maximum reference level where the spectrum is -26 dB down have to be found.

7) The occupied bandwidth (99% Bandwidth) is measured as follows:  
the occupied bandwidth, that is the frequency bandwidth such that, below its lower and above its upper frequency limits, the mean powers radiated are each equal to 0.5 percent of the total mean power.

#### 3.5.2 Test Requirements / Limits

§ 2.1049 Measurements required: Occupied bandwidth

The occupied bandwidth, that is the frequency bandwidth such that, below its lower and above its upper frequency limits, the mean powers radiated are each equal to 0.5 percent of the total mean power radiated by a given emission shall be measured under the following conditions (as applicable):

(h) Transmitters employing digital modulation techniques - when modulated by an input signal such that its amplitude and symbol rate represent the maximum rated conditions under which the equipment will be operated. The signal shall be applied through any filter networks, pseudo-random generators or other devices required in normal service. Additionally, the occupied bandwidth shall be shown for operation with any devices used for modifying the spectrum when such devices are optional at the discretion of the user.

### 3.5.3 Test Protocol

Temperature: 25 °C  
 Air Pressure: 1004 hPa  
 Humidity: 48 %

Op. Mode	Setup	Port
op-mode 1	setup_a02	antenna connector

Bandwidth kHz	Remarks
318	please see annex

Remark: The given value is the result of the 26dB bandwidth measurement.  
 The 99% Bandwidth is 248 kHz.

Op. Mode	Setup	Port
op-mode 2	setup_a02	antenna connector

Bandwidth kHz	Remarks
316	please see annex

Remark: The given value is the result of the 26dB bandwidth measurement.  
 The 99% Bandwidth is 244 kHz.

Op. Mode	Setup	Port
op-mode 3	setup_a02	antenna connector

Bandwidth kHz	Remarks
302	please see annex

Remark: The given value is the result of the 26dB bandwidth measurement.  
 The 99% Bandwidth is 248 kHz.

Op. Mode	Setup	Port
op-mode 4	setup_a02	antenna connector

Bandwidth kHz	Remarks
298	please see annex

Remark: The given value is the result of the 26dB bandwidth measurement.  
 The 99% Bandwidth is 240 kHz.

Op. Mode	Setup	Port
op-mode 5	setup_a02	antenna connector

Bandwidth kHz	Remarks
290	please see annex

Remark: The given value is the result of the 26dB bandwidth measurement.  
 The 99% Bandwidth is 240 kHz.



Op. Mode	Setup	Port
op-mode 6	setup_a02	antenna connector

Bandwidth kHz	Remarks
290	please see annex

Remark: The given value is the result of the 26dB bandwidth measurement.  
The 99% Bandwidth is 232 kHz.

Op. Mode	Setup	Port
op-mode 7	setup_a02	antenna connector

Bandwidth kHz	Remarks
4720	please see annex

Remark: The given value is the result of the 26dB bandwidth measurement.  
The 99% Bandwidth is 4180 kHz.

Op. Mode	Setup	Port
op-mode 8	setup_a02	antenna connector

Bandwidth kHz	Remarks
4700	please see annex

Remark: The given value is the result of the 26dB bandwidth measurement.  
The 99% Bandwidth is 4180 kHz.

Op. Mode	Setup	Port
op-mode 9	setup_a02	antenna connector

Bandwidth kHz	Remarks
4720	please see annex

Remark: The given value is the result of the 26dB bandwidth measurement.  
The 99% Bandwidth is 4200 kHz.

### 3.5.4 Test result: Emission and Occupied Bandwidth

FCC Part 24, Subpart E	Op. Mode	Result
	op-mode 1	passed
	op-mode 2	passed
	op-mode 3	passed
	op-mode 4	passed
	op-mode 5	passed
	op-mode 6	passed
	op-mode 7	passed
	op-mode 8	passed
	op-mode 9	passed



### **3.6 Band edge compliance**

**Standard** FCC Part 24, 10-1-06  
Subpart E

The test was performed according to: FCC §24.238, 10-1-06

#### **3.6.1 Test Description**

- 1) The EUT was coupled to the R&S CMU200 Digital Communications Tester via a 10 dB attenuator and a 6 dB coupler.
- 2) For the measurement the EUT is connected to the Spectrum Analyser via 30 dB attenuator and 6 dB coupler.
- 3) The spectrum analyser is set to a RBW/VBW of 3 kHz/3 kHz (GSM).  
The spectrum analyser is set to a RBW/VBW of 100 kHz/300 kHz (UMTS).

#### **3.6.2 Test Requirements / Limits**

§ 24.238 Effective radiated power limits

### 3.6.3 Test Protocol

Temperature: 25 °C  
 Air Pressure: 1004 hPa  
 Humidity: 48 %

Op. Mode	Setup	Port
op-mode 1	Setup_a02	antenna connector

Frequency MHz	Measured value dBm	Limit dBm
1850	-16.35	-13

Remark: Please see annex for the measurement plot.

Op. Mode	Setup	Port
op-mode 3	Setup_a02	antenna connector

Frequency MHz	Measured value dBm	Limit dBm
1910	-14.61	-13

Remark: Please see annex for the measurement plot.

Op. Mode	Setup	Port
op-mode 4	Setup_a02	antenna connector

Frequency MHz	Measured value dBm	Limit dBm
1850	-20.51	-13

Remark: Please see annex for the measurement plot.

Op. Mode	Setup	Port
op-mode 6	Setup_a02	antenna connector

Frequency MHz	Measured value dBm	Limit dBm
1910	-21.65	-13

Remark: Please see annex for the measurement plot.

Op. Mode	Setup	Port
op-mode 7	Setup_a02	antenna connector

Frequency MHz	Measured value dBm	Limit dBm
1850	-18.71	-13

Remark: Please see annex for the measurement plot.



<b>Op. Mode</b>	<b>Setup</b>	<b>Port</b>
op-mode 9	Setup_a02	antenna connector

<b>Frequency MHz</b>	<b>Measured value dBm</b>	<b>Limit dBm</b>
1910	-17.12	-13

Remark: Please see annex for the measurement plot.

### 3.6.4 Test result: Band edge compliance

<b>FCC Part 24, Subpart E</b>	<b>Op. Mode</b>	<b>Result</b>
	op-mode 1	passed
	op-mode 3	passed
	op-mode 4	passed
	op-mode 6	passed
	op-mode 7	passed
	op-mode 9	passed

## 4 Test Equipment

### *EUT Digital Signalling System*

<b>Equipment</b>	<b>Type</b>	<b>Serial No.</b>	<b>Manufacturer</b>
Digital Radio Communication Tester	CMD 55	831050/020	Rohde & Schwarz
Signalling Unit for Bluetooth Spurious Emissions	PTW60	100004	Rohde & Schwarz
Universal Radio Communication Tester	CMU 200	102366	Rohde & Schwarz

### *EMI Test System*

<b>Equipment</b>	<b>Type</b>	<b>Serial No.</b>	<b>Manufacturer</b>
Comparison Noise Emitter	CNE III	99/016	York
EMI Analyzer	ESI 26	830482/004	Rohde & Schwarz
Signal Generator	SMR 20	846834/008	Rohde & Schwarz

### *EMI Radiated Auxiliary Equipment*

<b>Equipment</b>	<b>Type</b>	<b>Serial No.</b>	<b>Manufacturer</b>
Antenna mast 4m	MA 240	240/492	HD GmbH H. Deisel
Biconical dipole	VUBA 9117	9117108	Schwarzbeck
Broadband Amplifier 18MHz-26GHz	JS4-18002600-32	849785	Miteq
Broadband Amplifier 30MHz-18GHz	JS4-00101800-35	896037	Miteq
Broadband Amplifier 45MHz-27GHz	JS4-00102600-42	619368	Miteq
Cable "ESI to EMI Antenna"	EcoFlex10	W18.01-2 + W38.01-2	Kabel Kusch
Cable "ESI to Horn Antenna"	UFB311A + UFB293C	W18.02-2 + W38.02-2	Rosenberger-Microcoax
Double-ridged horn	HF 906	357357/002	Rohde & Schwarz
Double-ridged horn	HF 906	357357/001	Rohde & Schwarz
High Pass Filter	5HC3500/12750-1.2-KK	200035008	Trilithic
High Pass Filter	5HC2700/12750-1.5-KK	9942012	Trilithic
High Pass Filter	4HC1600/12750-1.5-KK	9942011	Trilithic
KUEP pre amplifier	Kuep 00304000	001	7layers
Log.-per. Antenna	HL 562 Ultralog	830547/003	Rohde & Schwarz
Loop Antenna	HFH2-Z2	829324/006	Rohde & Schwarz
Pyramidal Horn Antenna 26.5 GHz	Model 3160-09	9910-1184	EMCO





### *EMI Conducted Auxiliary Equipment*

<b>Equipment</b>	<b>Type</b>	<b>Serial No.</b>	<b>Manufacturer</b>
Cable "LISN to ESI"	RG214	W18.03+W48.03	Huber+Suhner
Two-Line V-Network	ESH 3-Z5	828304/029	Rohde & Schwarz
Two-Line V-Network	ESH 3-Z5	829996/002	Rohde & Schwarz

### *Auxiliary Test Equipment*

<b>Equipment</b>	<b>Type</b>	<b>Serial No.</b>	<b>Manufacturer</b>
Broadband Resist. Power Divider N	1506A / 93459	LM390	Weinschel
Broadband Resist. Power Divider SMA	1515 / 93459	LN673	Weinschel
Digital Multimeter 01	Voltcraft M-3860M	IJ096055	Conrad
Digital Multimeter 02	Voltcraft M-3860M	IJ095955	Conrad
Digital Oscilloscope	TDS 784C	B021311	Tektronix
Fibre optic link Satellite	FO RS232 Link	181-018	Pontis
Fibre optic link Transceiver	FO RS232 Link	182-018	Pontis
I/Q Modulation Generator	AMIQ-B1	832085/018	Rohde & Schwarz
Notch Filter ultra stable	WRCA800/960-6E	24	Wainwright
Spectrum Analyzer 9 kHz to 3 GHz	FSP3	838164/004	Rohde & Schwarz
Temperature Chamber	VT 4002	58566002150010	Vötsch
Temperature Chamber	KWP 120/70	59226012190010	Weiss
ThermoHygro Datalogger 03	Opus10 THI (8152.00)	7482	Lufft Mess- und Regeltechnik GmbH

### *Anechoic Chamber*

<b>Equipment</b>	<b>Type</b>	<b>Serial No.</b>	<b>Manufacturer</b>
Air Compressor (pneumatic)			Atlas Copco
Controller	CO 2000	CO2000/328/12470406 /L	Innco innovative constructions GmbH
EMC Camera	CE-CAM/1		CE-SYS
EMC Camera for observation of EUT	CCD-400E	0005033	Mitsubishi
Filter ISDN	B84312-C110-E1		Siemens&Matsushita
Filter telephone systems / modem	B84312-C40-B1		Siemens&Matsushita
Filter Universal 1A	B84312-C30-H3		Siemens&Matsushita
Fully/Semi AE Chamber	10.58x6.38x6		Frankonia
Turntable	DS 420S	420/573/99	HD GmbH, H. Deisel
Valve Control Unit (pneum.)	VE 615P	615/348/99	HD GmbH, H. Deisel

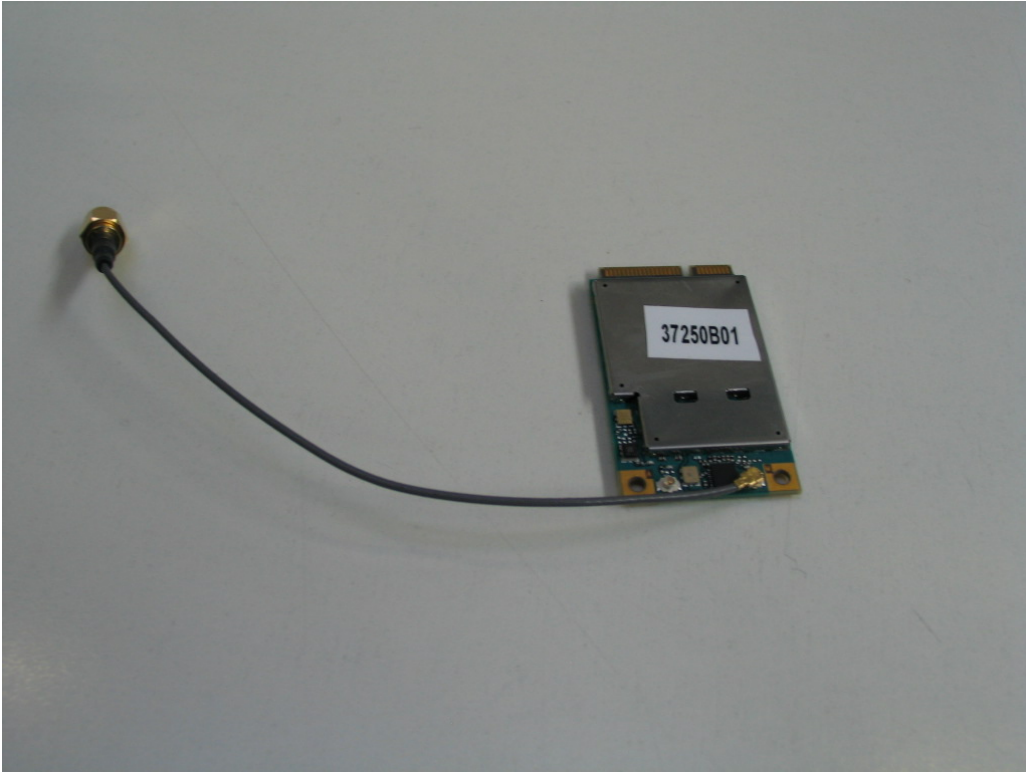


*7 layers Bluetooth™ Full RF Test Solution*

*Bluetooth RF Conformance Test System TS8960*

<b>Equipment</b>	<b>Type</b>	<b>Serial No.</b>	<b>Manufacturer</b>
10 MHz Reference	MFS	5489/001	Efratom
Power Meter 832025/059	NRVD	832025/059	Rohde & Schwarz
Power Sensor A 832279/013	NRV-Z1	832279/013	Rohde & Schwarz
Power Sensor B 832279/015	NRV-Z1	832279/015	Rohde & Schwarz
Power Supply	E3632A	MY40003776	Agilent
Power Supply	PS-2403D	-	Conrad
RF Step Attenuator 833695/001	RSP	833695/001	Rohde & Schwarz
Rubidium Frequency Normal	MFS	002	Efratom
Signal Analyzer FSIQ26 832695/007	FSIQ26	832695/007	Rohde & Schwarz
Signal Generator 833680/003	SMP 03	833680/003	Rohde & Schwarz
Signal Generator A 834344/002	SMIQ03B	834344/002	Rohde & Schwarz
Signal Generator B 832870/017	SMIQ03B	832870/017	Rohde & Schwarz
Signal Switching and Conditioning Unit	SSCU	338826/005	Rohde & Schwarz
Signalling Unit PTW60 838312/014	PTW60 for TS8960	838312/014	Rohde & Schwarz
System Controller 829323/008	PSM12	829323/008	Rohde & Schwarz

## 5 Photo Report



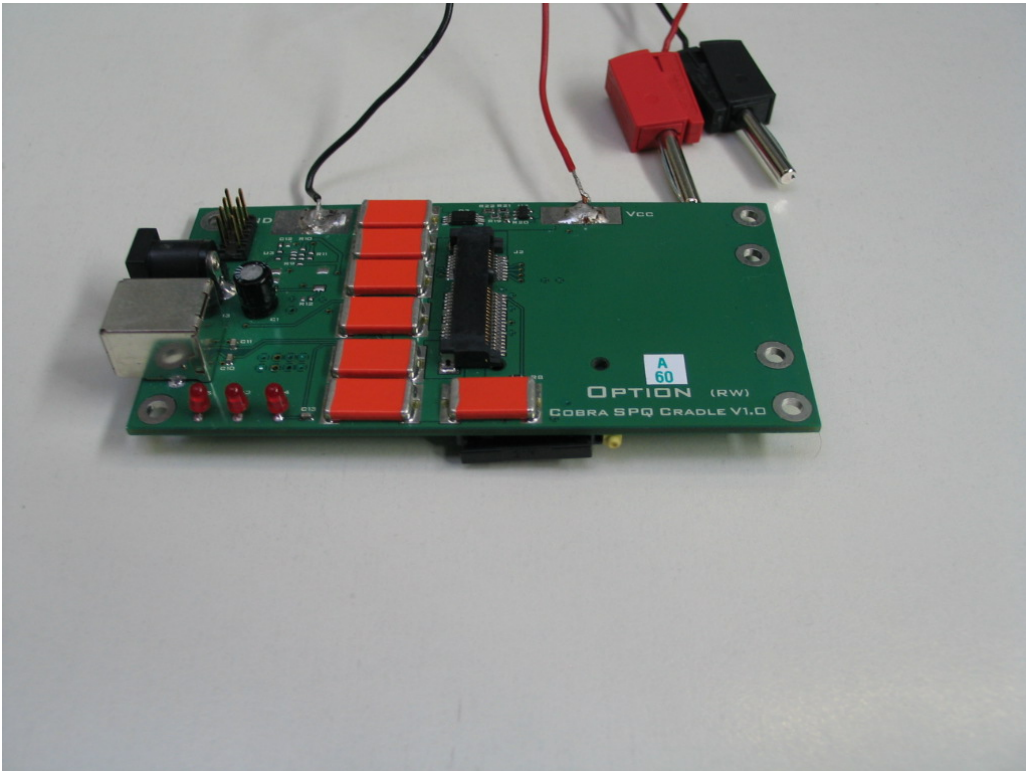
**Photo 1:** EUT (front side)



**Photo 2:** EUT (front side)



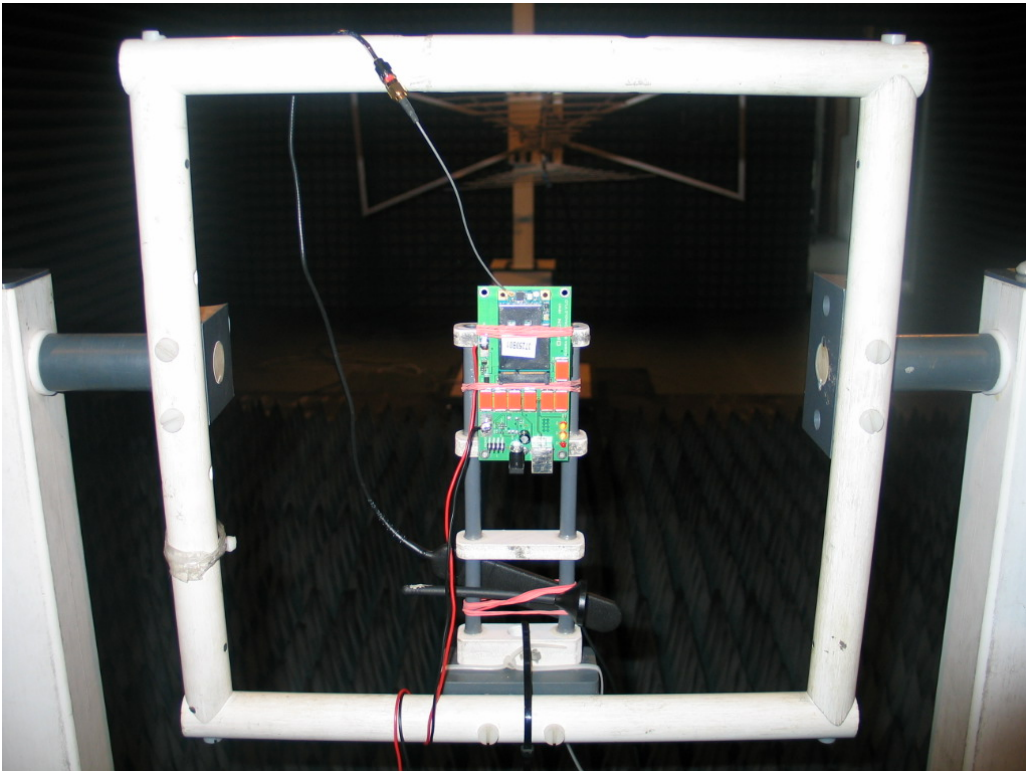
**Photo 3:** EUT (rear side)



**Photo 4:** Test cradle Cobra SPQ

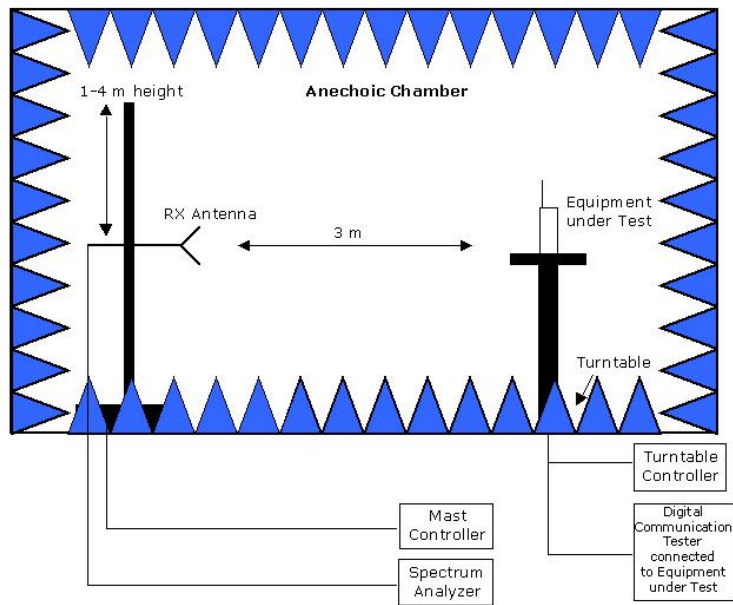


**Photo 5:** Test cradle Pepijn



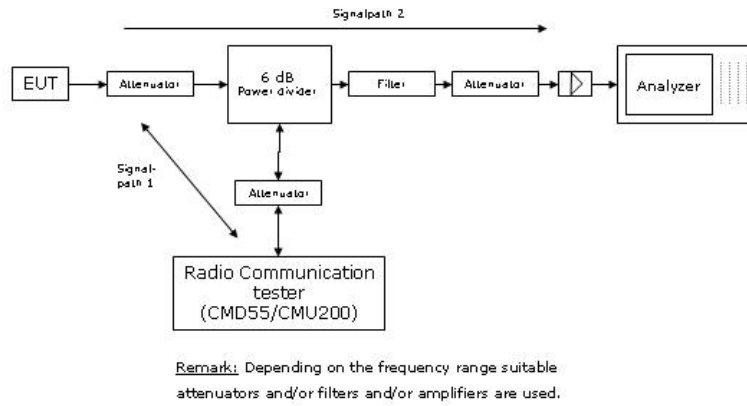
**Photo 6:** Setup for radiated tests

## 6 Setup Drawings

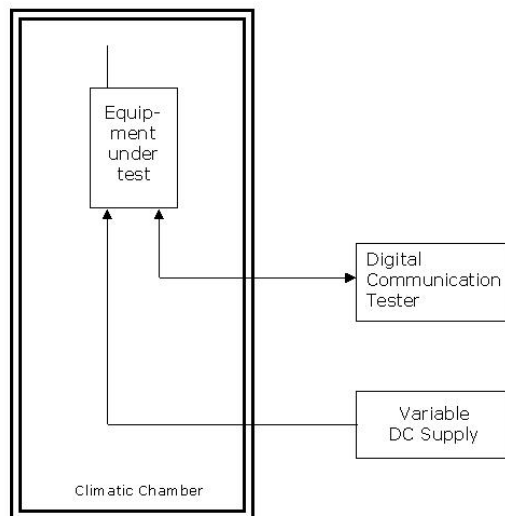


Remark: Depending on the frequency range suitable antenna types, attenuators or preamplifiers are used.

**Drawing 1:** Principle setup for radiated measurements.



**Drawing 2:** Principle setup for conducted measurements under nominal conditions



**Drawing 3:** Principle setup for tests under extreme test conditions

## 7 Annex

### Measurement plots Emission and Occupied Bandwidth

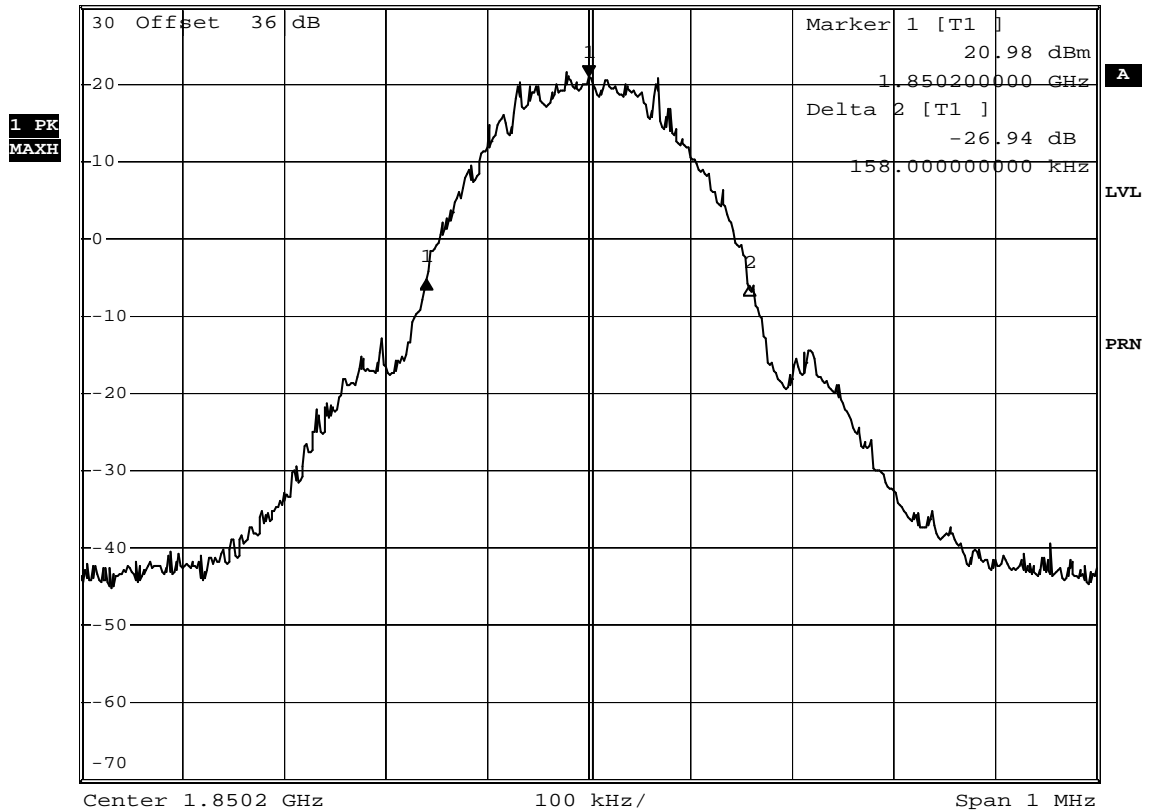
#### Op. Mode

op-mode 1



\*RBW 3 kHz Delta 1 [T1 ]  
 \*VBW 10 kHz -26.33 dB

Ref 30 dBm Att 30 dB SWT 115 ms -160.00000000 kHz



Date: 25.JUN.2007 14:17:55

Test: Emissions bandwidth (26 dB bandwidth), Channel 512 (1850.2 MHz)



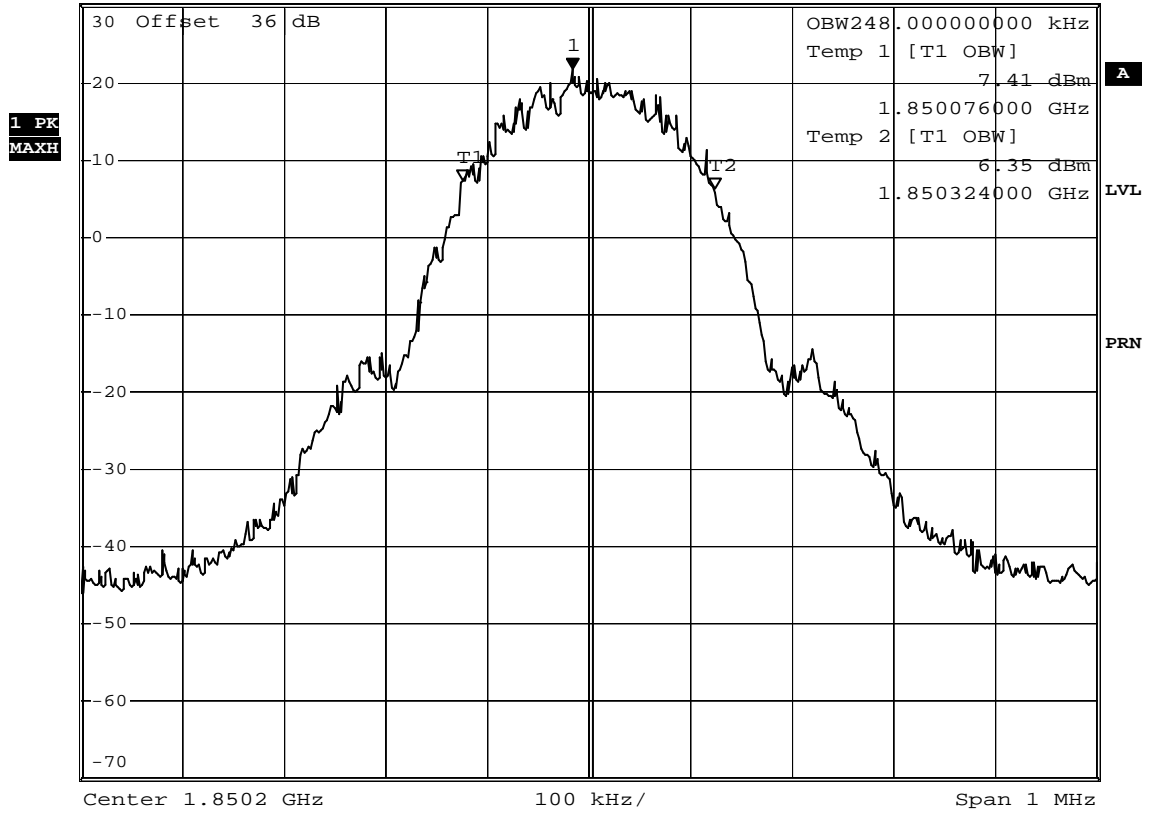


**Op. Mode**

op-mode 1



\*RBW 3 kHz      Marker 1 [T1 ]  
 \*VBW 10 kHz      21.68 dBm  
 Ref 30 dBm      Att 30 dB      SWT 115 ms      1.850184000 GHz



Date: 25.JUN.2007 14:19:23

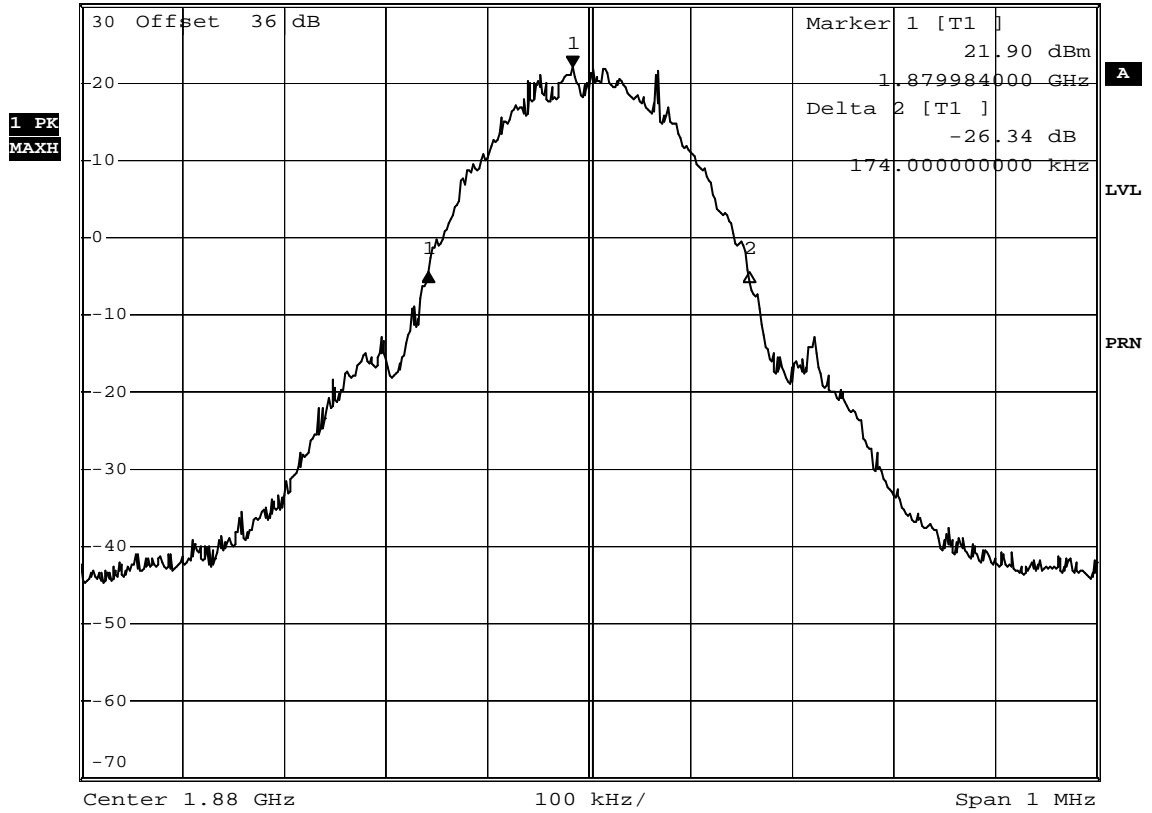
Test: Occupied bandwidth, Channel 512 (1850.2 MHz)

## Op. Mode

op-mode 2



\*RBW 3 kHz      Delta 1 [T1 ]  
 \*VBW 10 kHz      -26.48 dB  
 Ref 30 dBm      Att 30 dB      SWT 115 ms      -142.00000000 kHz



Date: 25.JUN.2007 14:22:08

Test: Emissions bandwidth (26 dB bandwidth), Channel 661 (1880.0 MHz)



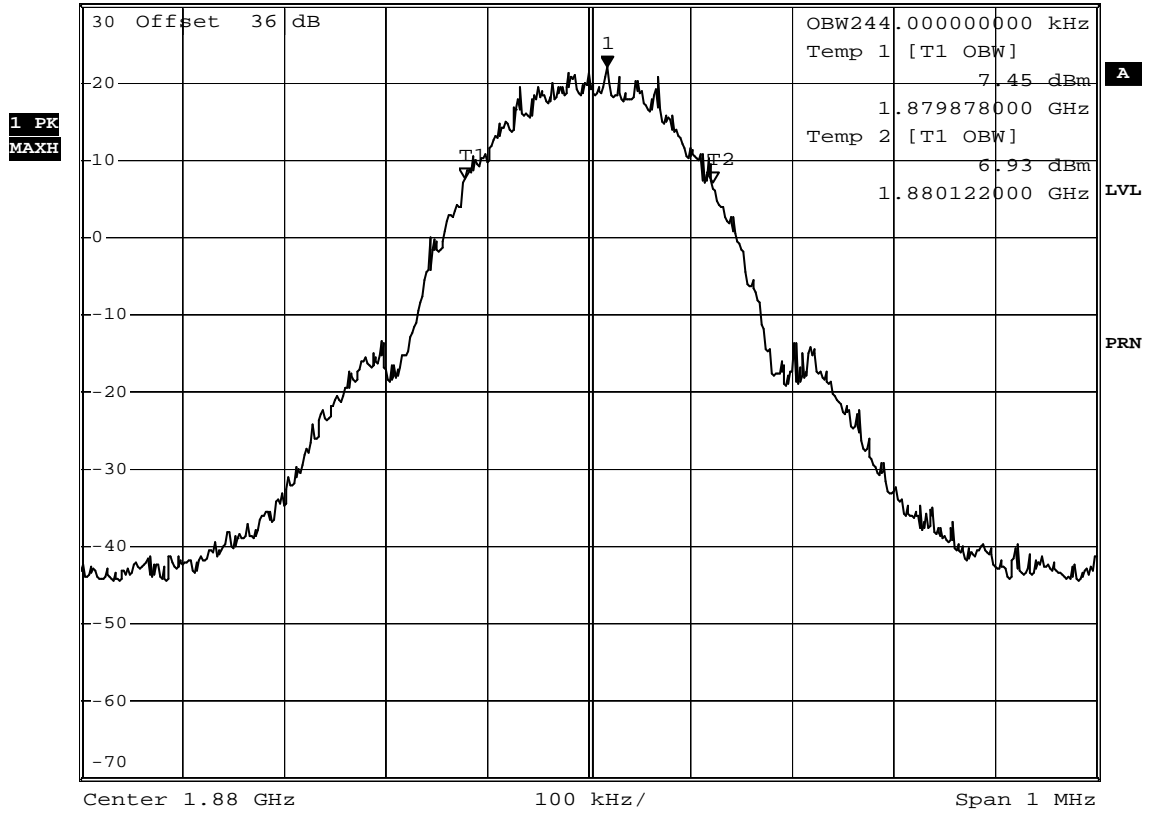
**Op. Mode**

op-mode 2



\*RBW 3 kHz      Marker 1 [T1 ]  
\*VBW 10 kHz      22.09 dBm  
SWT 115 ms      1.880018000 GHz

Ref 30 dBm      Att 30 dB



Date: 25.JUN.2007 14:23:56

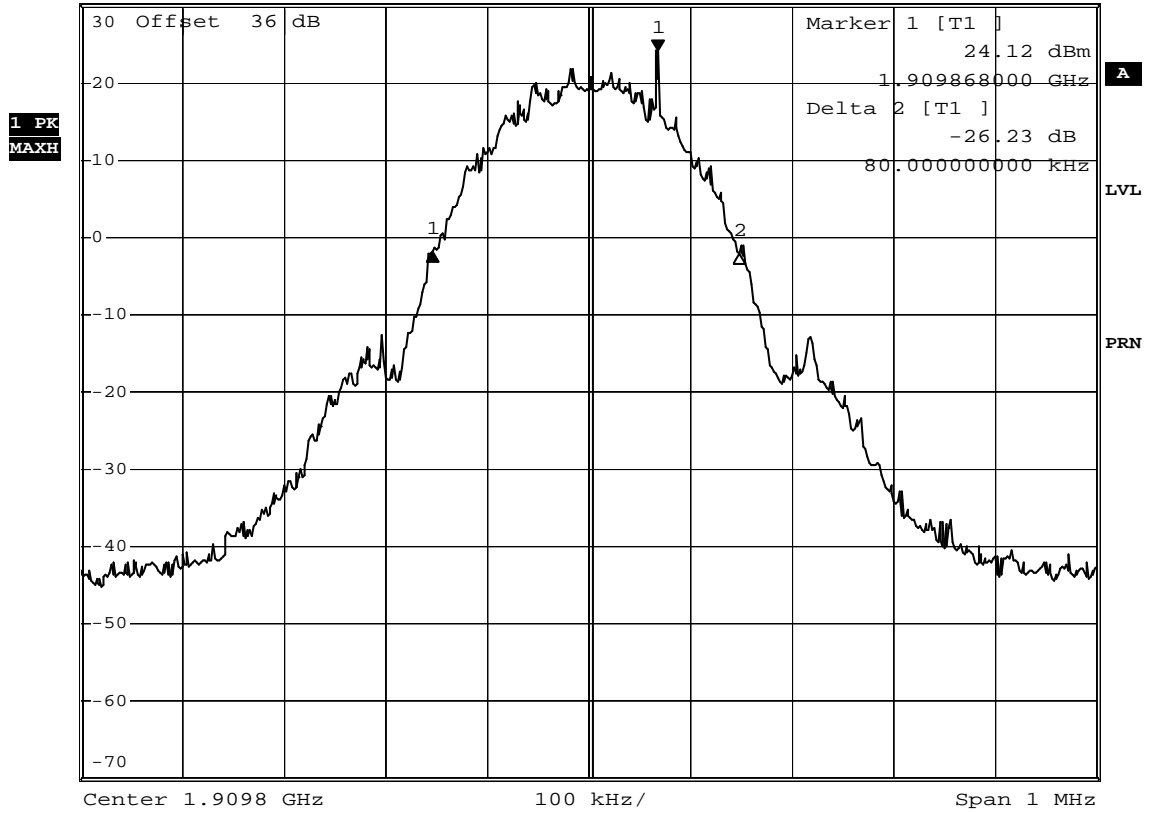
Test: Occupied bandwidth, Channel 661 (1880.0 MHz)

**Op. Mode**

op-mode 3



\*RBW 3 kHz      Delta 1 [T1 ]  
 \*VBW 10 kHz      -26.00 dB  
 Ref 30 dBm      Att 30 dB      SWT 115 ms      -222.000000000 kHz



Date: 25.JUN.2007 14:26:25

Test: Emissions bandwidth (26 dB bandwidth), Channel 810 (1909.8 MHz)



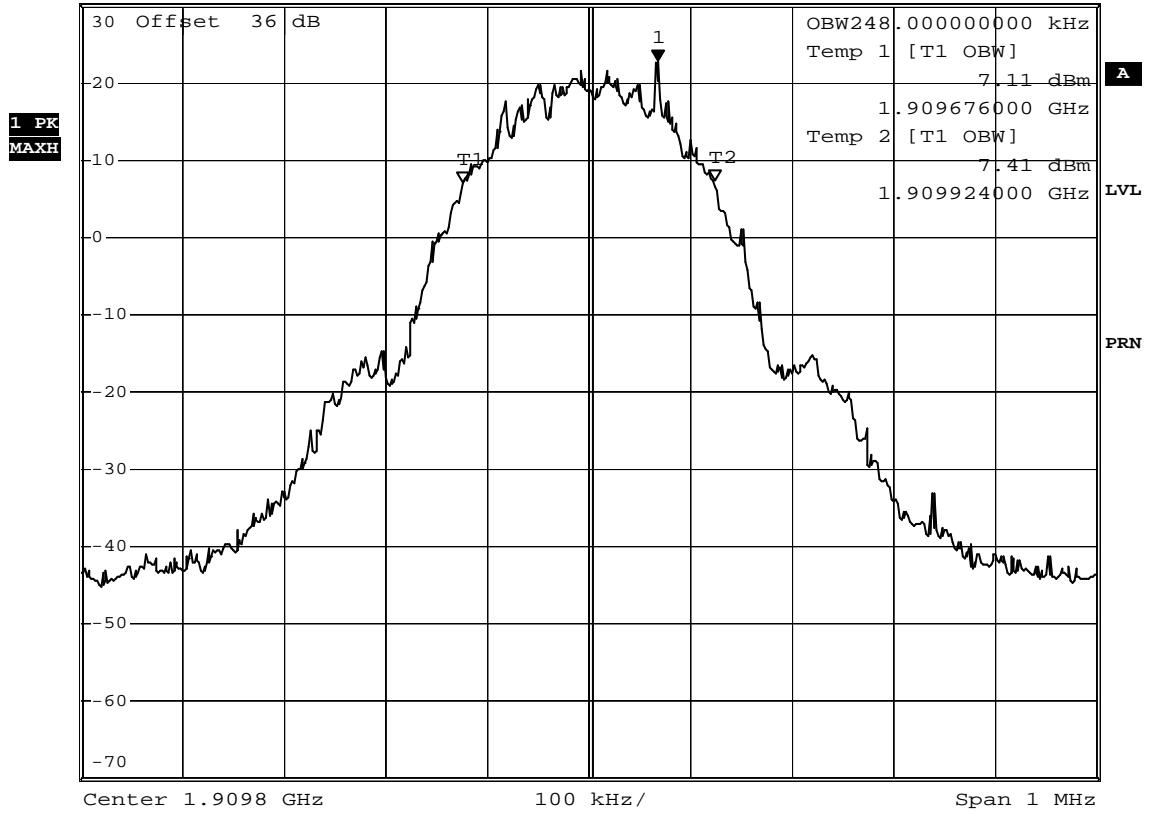
**Op. Mode**

op-mode 3



\*RBW 3 kHz      Marker 1 [T1 ]  
\*VBW 10 kHz      22.71 dBm  
SWT 115 ms      1.909868000 GHz

Ref 30 dBm      Att 30 dB



Date: 25.JUN.2007 14:28:18

Test: Occupied bandwidth, Channel 810 (1909.8 MHz)

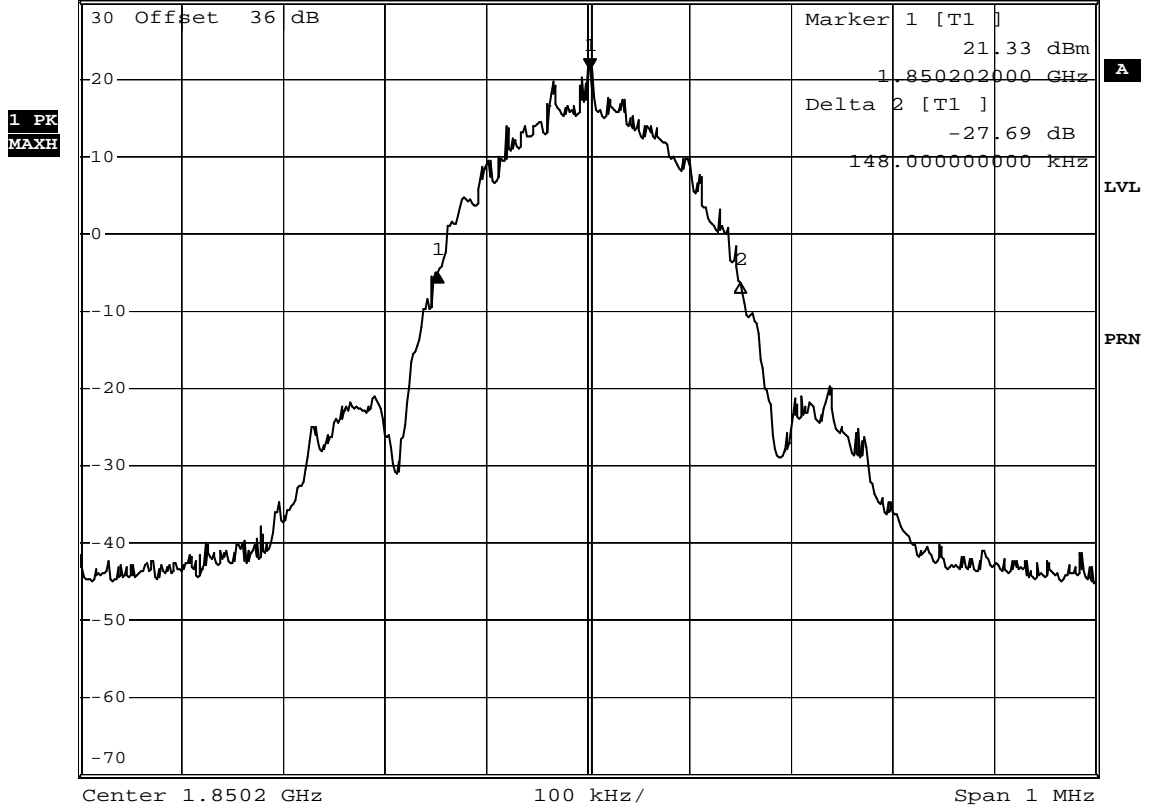
**Op. Mode**

op-mode 4



\*RBW 3 kHz      Delta 1 [T1 ]  
 \*VBW 10 kHz      -26.33 dB  
 SWT 115 ms      -150.000000000 kHz

Ref 30 dBm      Att 30 dB



Date: 25.JUN.2007 13:59:55

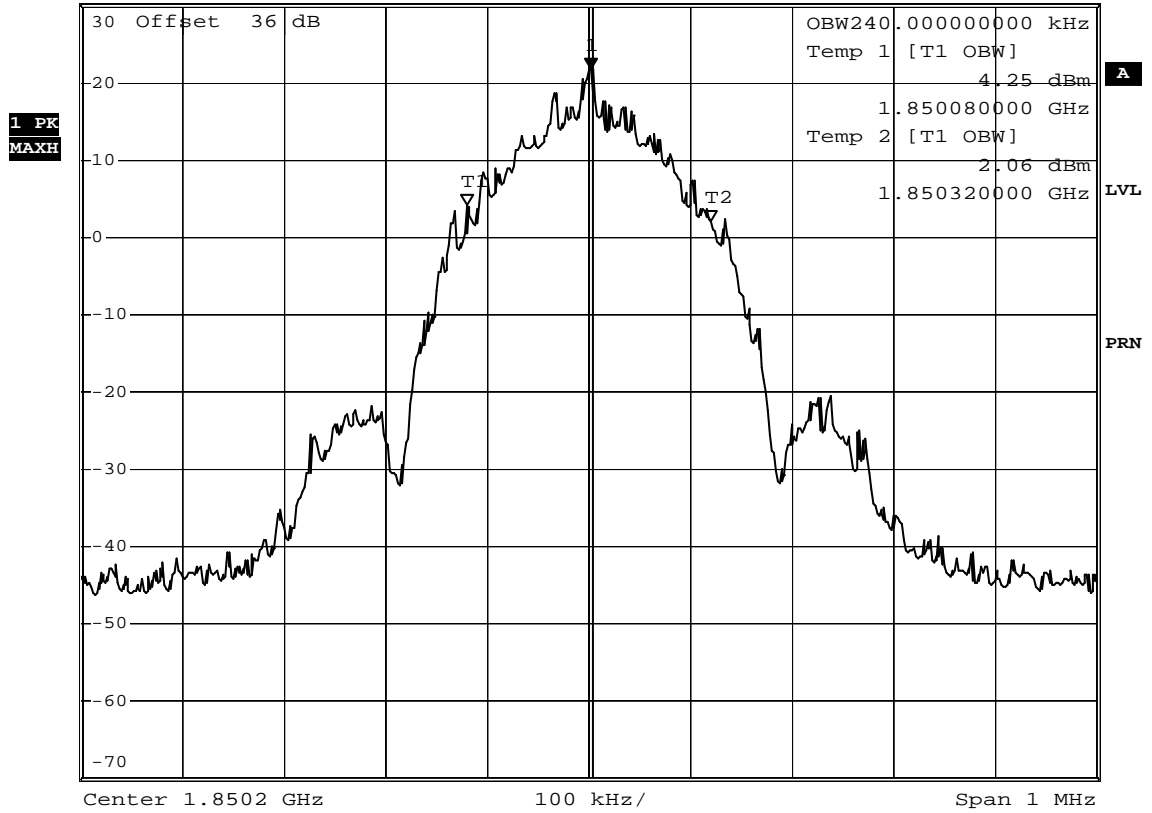
Test: Emissions bandwidth (26 dB bandwidth), Channel 512 (1850.2 MHz)

## Op. Mode

op-mode 4



\*RBW 3 kHz      Marker 1 [T1 ]  
 \*VBW 10 kHz      21.84 dBm  
 Ref 30 dBm      Att 30 dB      SWT 115 ms      1.850202000 GHz



Date: 25.JUN.2007 14:01:07

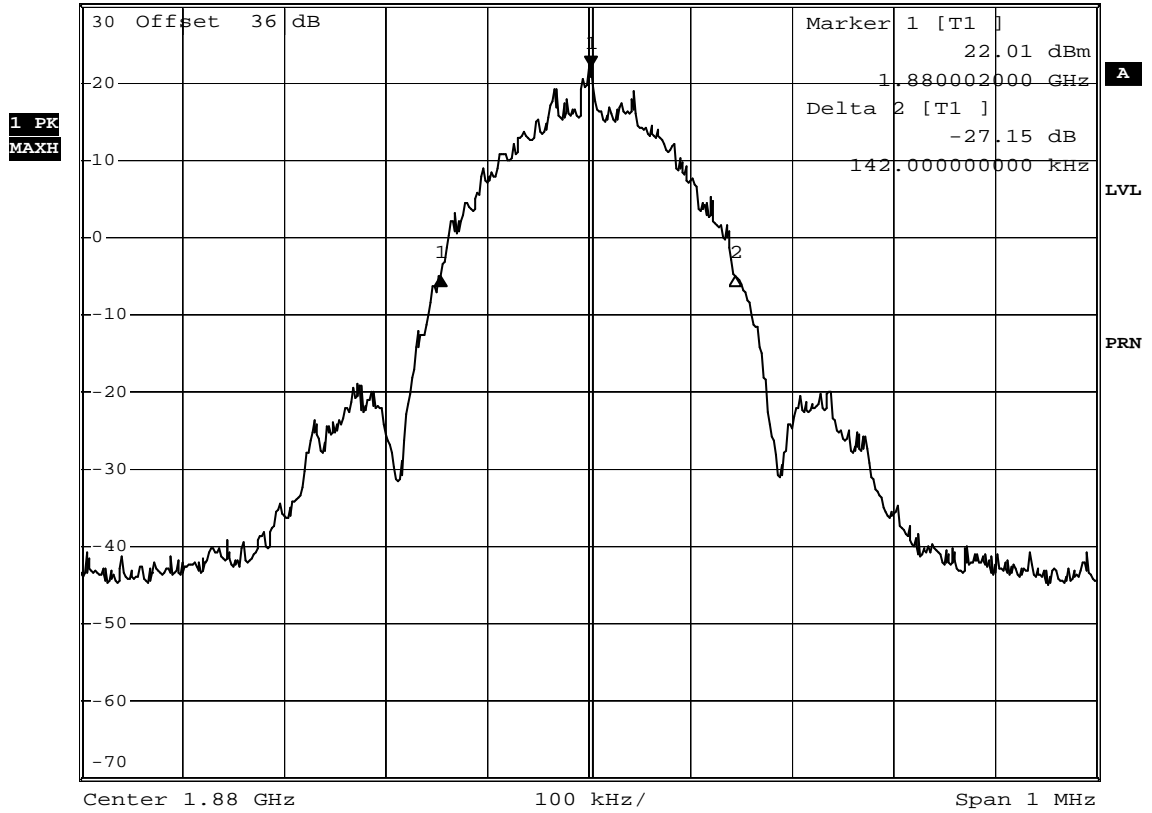
Test: Occupied bandwidth, Channel 512 (1850.2 MHz)

## Op. Mode

op-mode 5



\*RBW 3 kHz      Delta 1 [T1 ]  
 \*VBW 10 kHz      -26.97 dB  
 Ref 30 dBm      Att 30 dB      SWT 115 ms      -148.000000000 kHz



Date: 25.JUN.2007 14:05:09

Test: Emissions bandwidth (26 dB bandwidth), Channel 661 (1880.0 MHz)

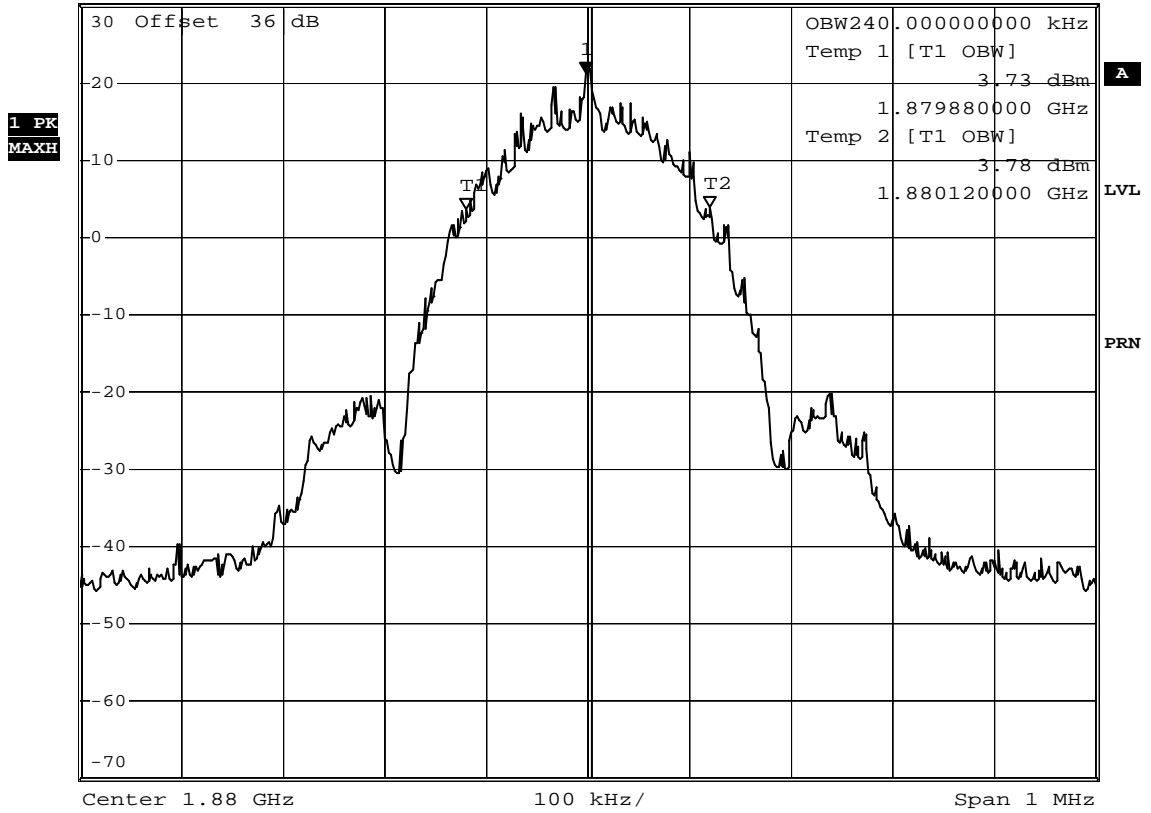


## Op. Mode

op-mode 5



\*RBW 3 kHz      Marker 1 [T1 ]  
 \*VBW 10 kHz      21.11 dBm  
 Ref 30 dBm      Att 30 dB      SWT 115 ms      1.879998000 GHz



Date: 25.JUN.2007 14:06:51

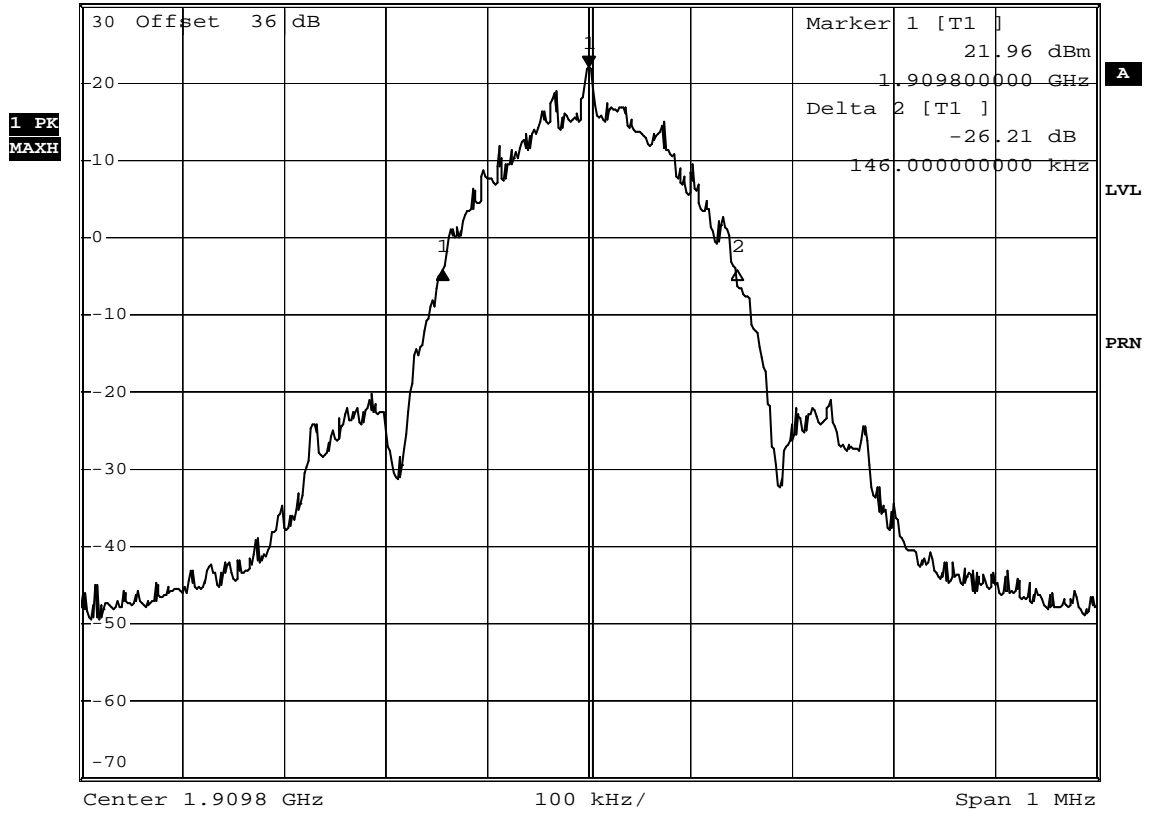
Test: Occupied bandwidth, Channel 661 (1880.0 MHz)

## Op. Mode

op-mode 6



\*RBW 3 kHz      Delta 1 [T1 ]  
 \*VBW 10 kHz      -26.15 dB  
 Ref 30 dBm      Att 10 dB      SWT 115 ms      -144.000000000 kHz



Date: 25.JUN.2007 14:09:56

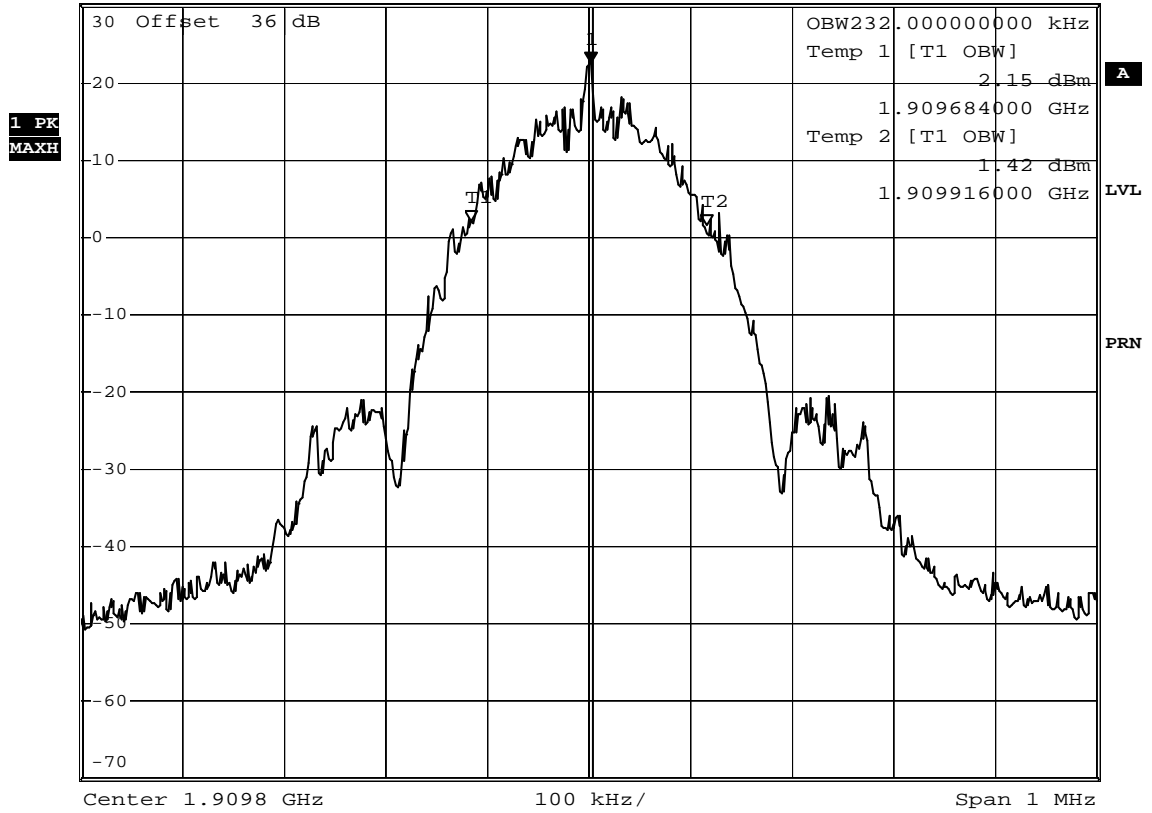
Test: Emissions bandwidth (26 dB bandwidth), Channel 810 (1909.8 MHz)

## Op. Mode

op-mode 6



\*RBW 3 kHz      Marker 1 [T1 ]  
 \*VBW 10 kHz      22.61 dBm  
 Ref 30 dBm      Att 10 dB      SWT 115 ms      1.909802000 GHz



Date: 25.JUN.2007 14:11:03

Test: Occupied bandwidth, Channel 810 (1909.8 MHz)

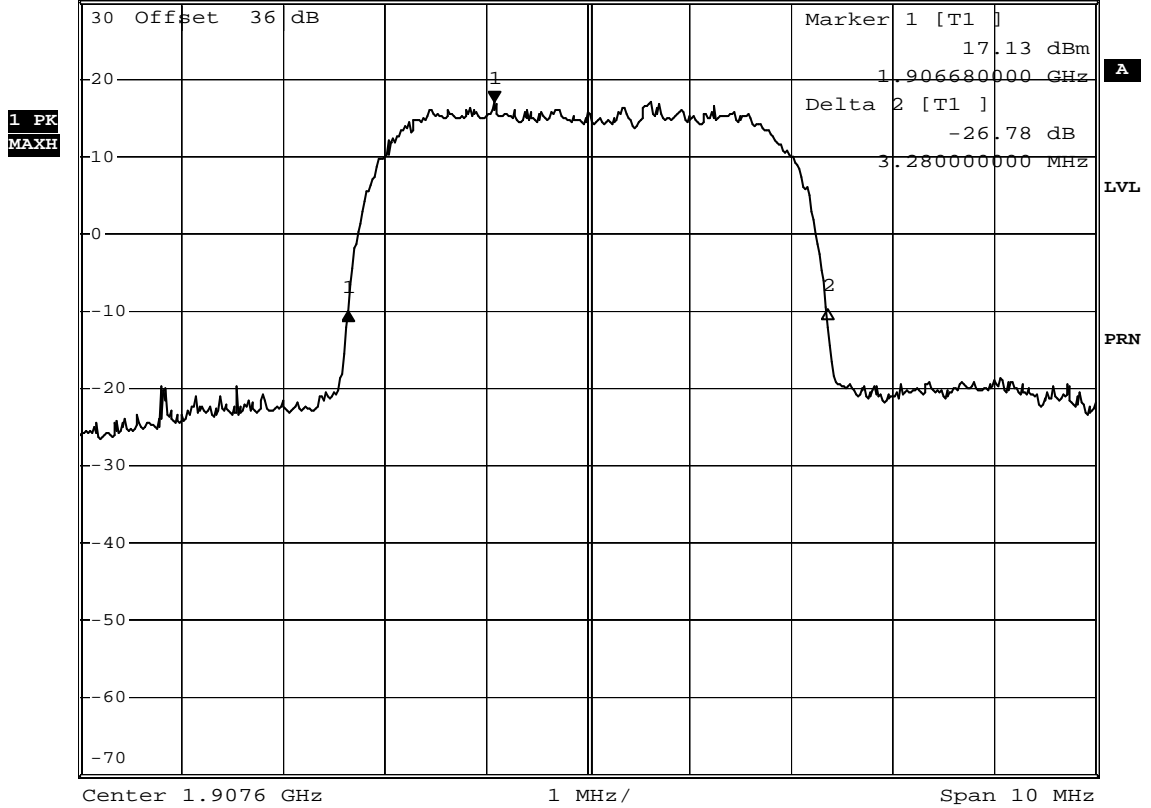
**Op. Mode**

op-mode 7



\*RBW 100 kHz Delta 1 [T1 ]  
 \*VBW 300 kHz -27.21 dB  
 SWT 2.5 ms -1.440000000 MHz

Ref 30 dBm \*Att 30 dB



Date: 27.JUN.2007 08:24:20

Test: Emissions bandwidth (26 dB bandwidth), Channel 9262 (1852.4 MHz)

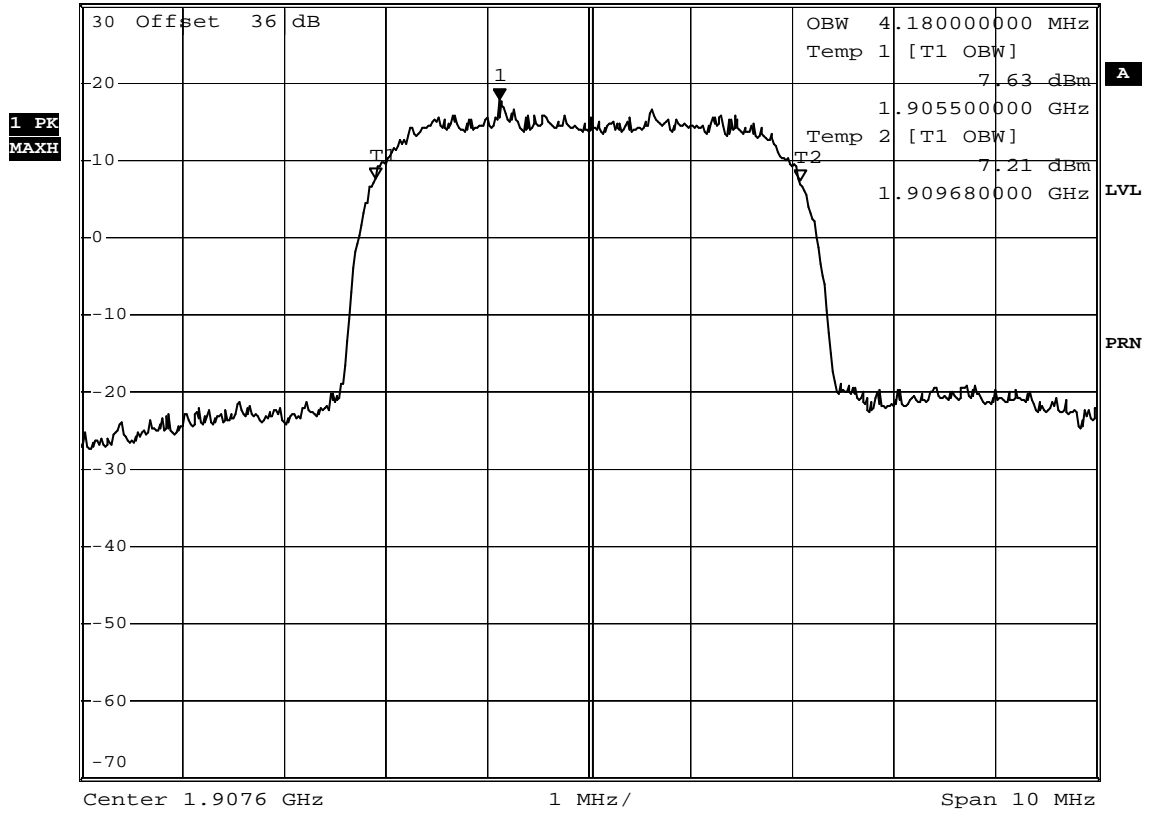
## Op. Mode

op-mode 7



\*RBW 100 kHz Marker 1 [T1 ]  
 \*VBW 300 kHz 17.90 dBm  
 SWT 2.5 ms 1.906720000 GHz

Ref 30 dBm \*Att 30 dB



Date: 27.JUN.2007 08:24:59

Test: Occupied bandwidth, Channel 9262 (1852.4 MHz)

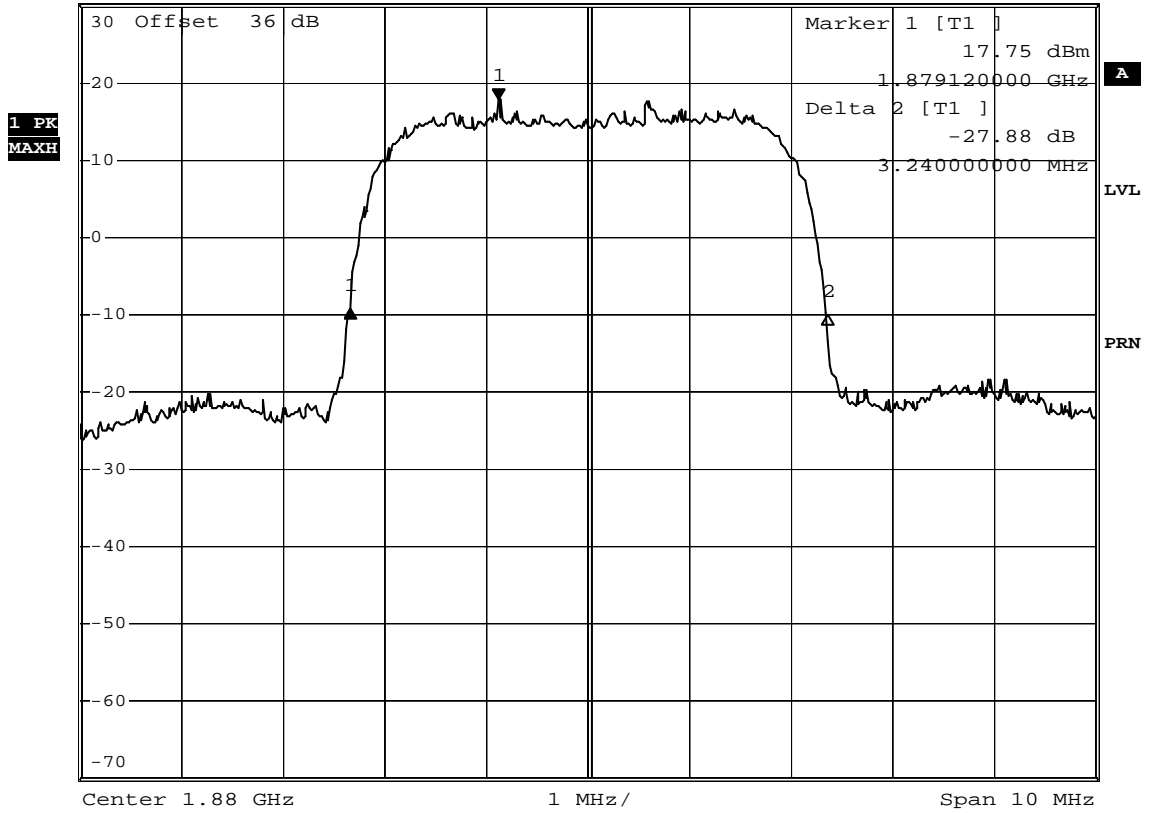
**Op. Mode**

op-mode 8



\*RBW 100 kHz Delta 1 [T1 ]  
 \*VBW 300 kHz -26.90 dB  
 SWT 2.5 ms -1.460000000 MHz

Ref 30 dBm \*Att 30 dB



Date: 27.JUN.2007 08:26:06

Test: Emissions bandwidth (26 dB bandwidth), Channel 9400 (1880.0 MHz)



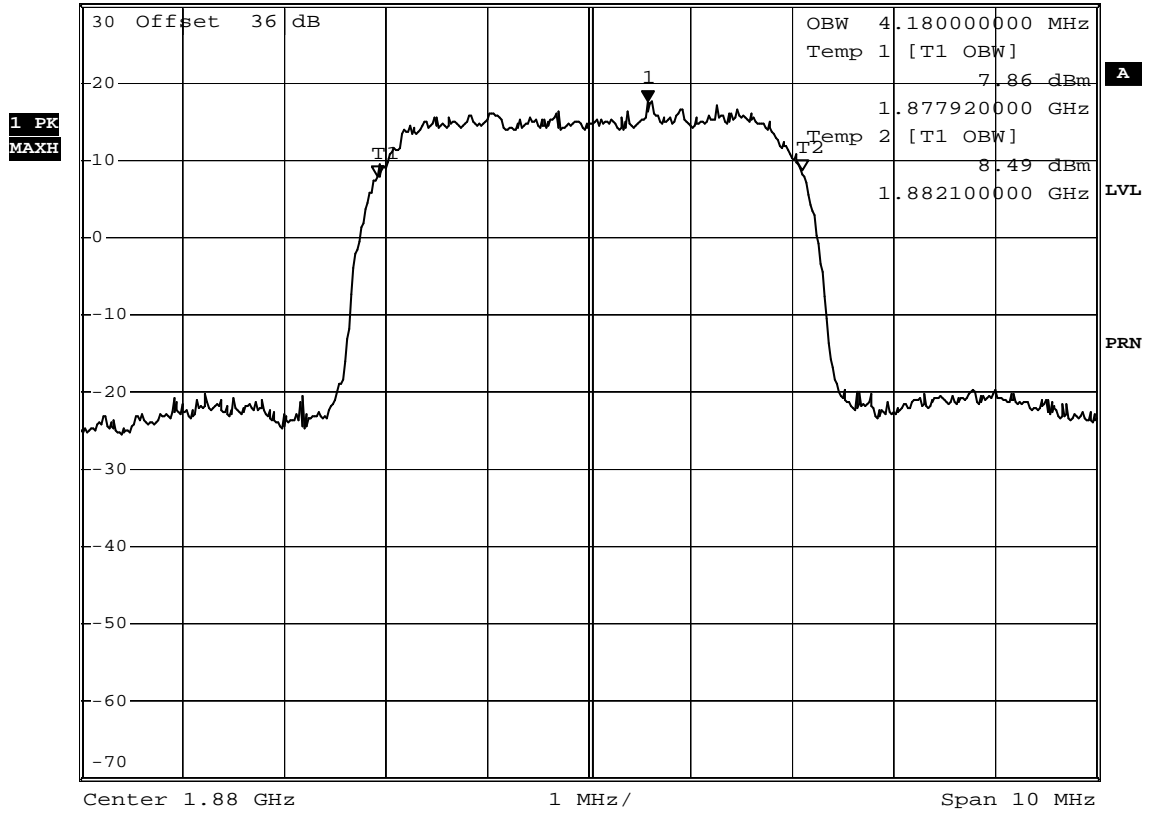
**Op. Mode**

op-mode 8



\*RBW 100 kHz Marker 1 [T1 ]  
 \*VBW 300 kHz 17.59 dBm  
 \*Att 30 dB  
 SWT 2.5 ms 1.880580000 GHz

Ref 30 dBm



Date: 27.JUN.2007 08:27:09

Test: Occupied bandwidth, Channel 9400 (1880.0 MHz)

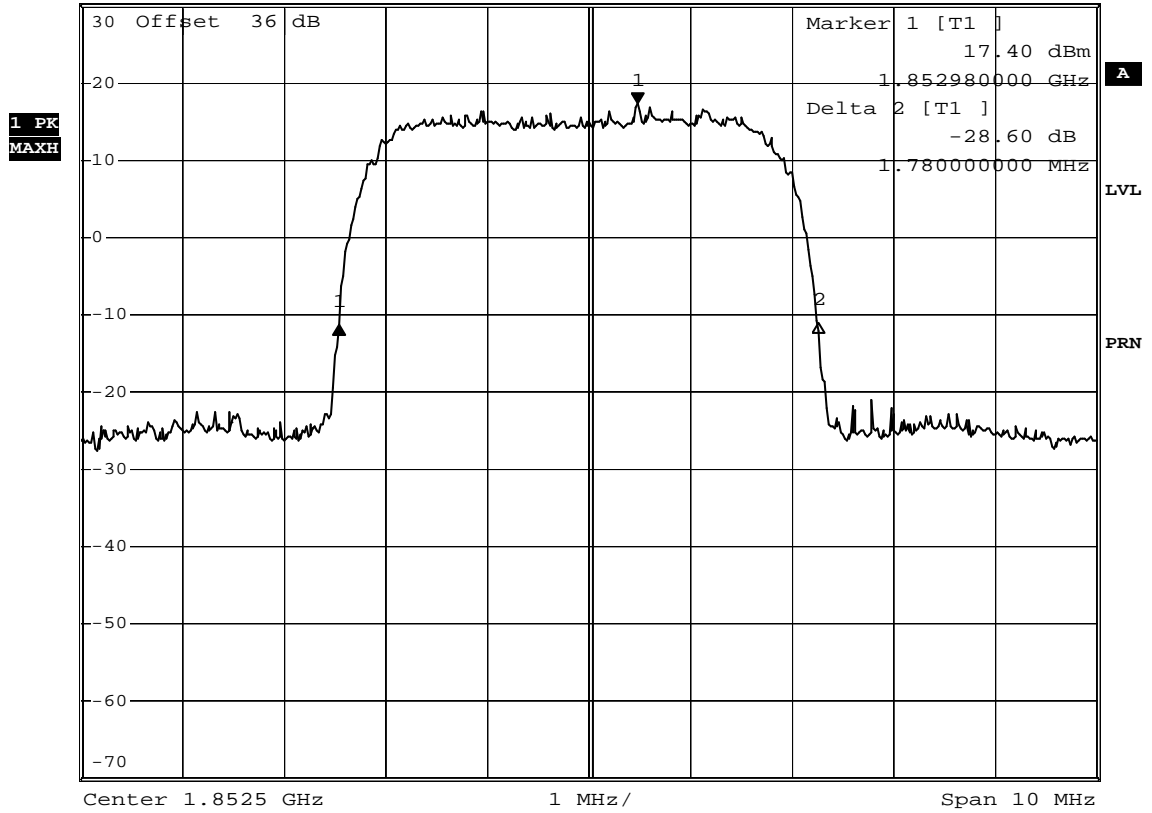
## Op. Mode

op-mode 9



\*RBW 100 kHz Delta 1 [T1 ]  
 \*VBW 300 kHz -28.68 dB  
 SWT 2.5 ms -2.940000000 MHz

Ref 30 dBm \*Att 30 dB



Date: 27.JUN.2007 08:28:27

Test: Emissions bandwidth (26 dB bandwidth), Channel 9538 (1907.6 MHz)



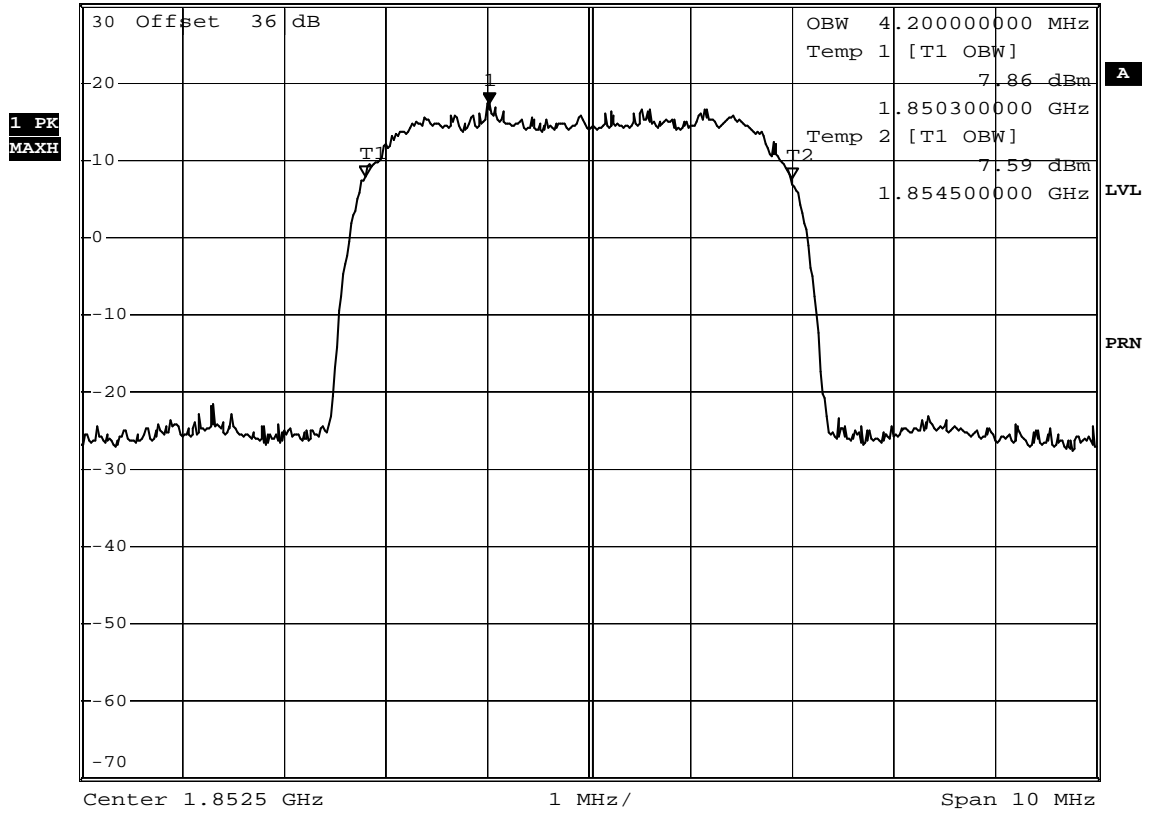
## Op. Mode

op-mode 9



\*RBW 100 kHz Marker 1 [T1 ]  
 \*VBW 300 kHz 17.38 dBm  
 SWT 2.5 ms 1.851520000 GHz

Ref 30 dBm \*Att 30 dB



Date: 27.JUN.2007 08:29:38

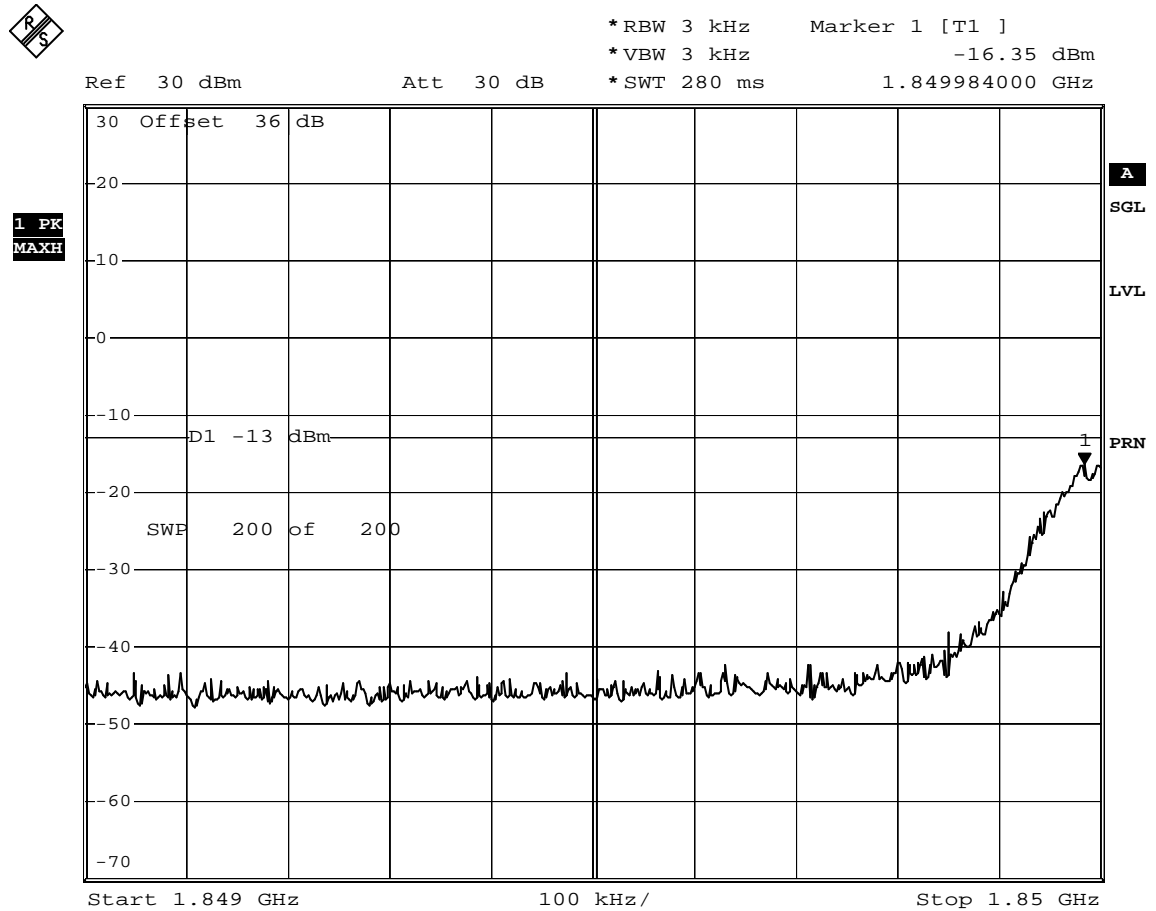
Test: Occupied bandwidth, Channel 9538 (1907.6 MHz)



## Measurement plots Band edge compliance

### Op. Mode

op-mode 1



Date: 25.JUN.2007 13:44:53

Test: band edge compliance , Channel 512, PCS



**Op. Mode**

op-mode 4

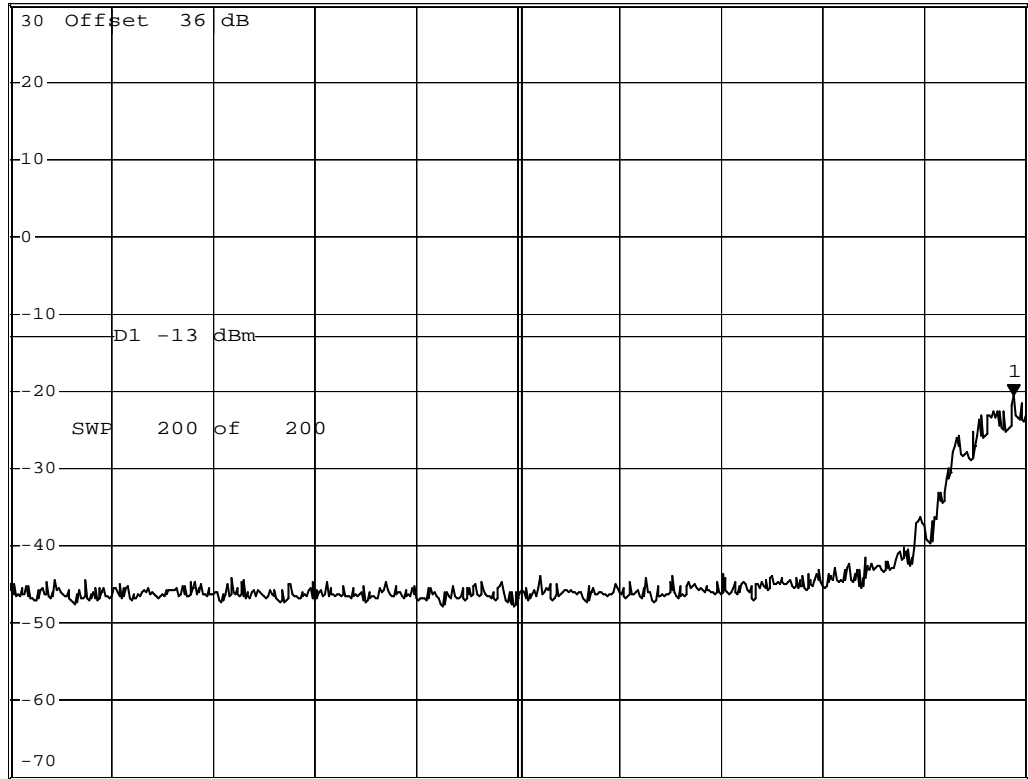


\*RBW 3 kHz      Marker 1 [T1 ]  
\*VBW 3 kHz      -20.51 dBm  
\*SWT 280 ms      1.849988000 GHz

Ref 30 dBm

Att 30 dB

1 PK  
MAXH



Start 1.849 GHz

100 kHz/

Stop 1.85 GHz

Date: 25.JUN.2007 13:53:37

Test: band edge compliance , Channel 512, EDGE

## Op. Mode

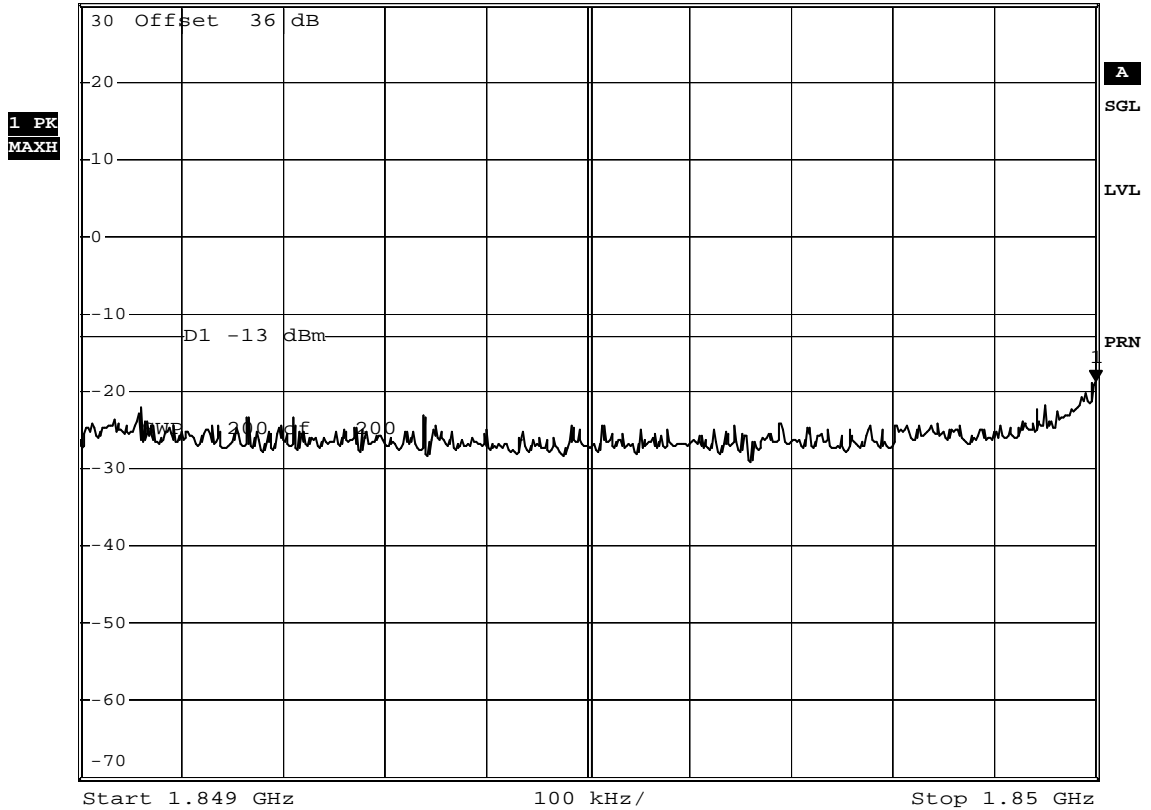
op-mode 7



\*RBW 100 kHz Marker 1 [T1 ]  
 \*VBW 300 kHz -18.71 dBm  
 SWT 2.5 ms 1.85000000 GHz

Ref 30 dBm

\*Att 30 dB



Date: 27.JUN.2007 08:17:53

Test: band edge compliance , Channel 9262, FDD II



**Op. Mode**

op-mode 3

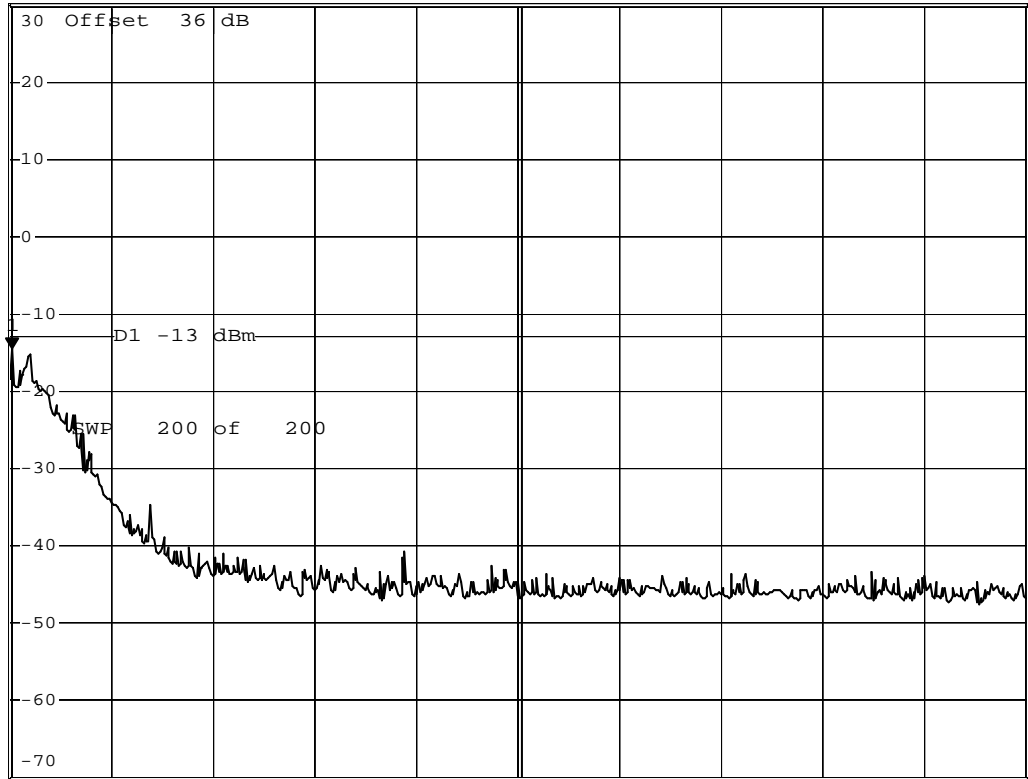


\*RBW 3 kHz      Marker 1 [T1 ]  
\*VBW 3 kHz      -14.61 dBm  
\*SWT 280 ms      1.91002000 GHz

Ref 30 dBm

Att 30 dB

1 PK  
MAXH



Start 1.91 GHz

100 kHz/

Stop 1.911 GHz

Date: 25.JUN.2007 13:47:00

Test: band edge compliance, Channel 810, PCS



**Op. Mode**

op-mode 6

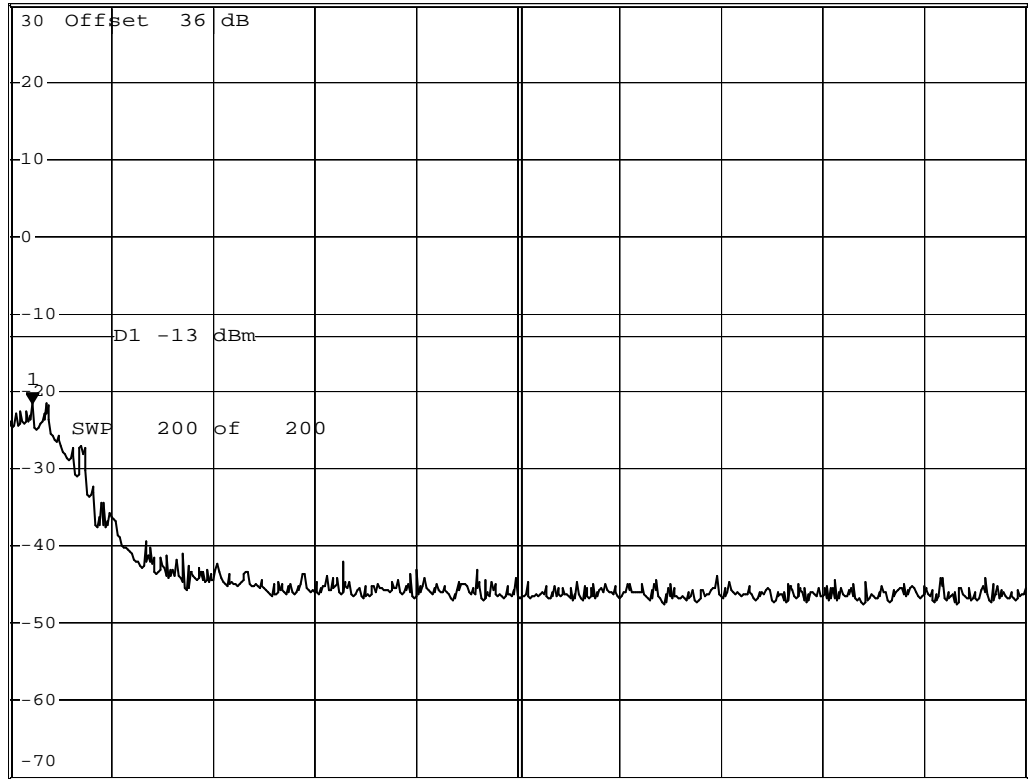


\*RBW 3 kHz      Marker 1 [T1 ]  
\*VBW 3 kHz      -21.65 dBm  
\*SWT 280 ms      1.910022000 GHz

Ref 30 dBm

Att 30 dB

1 PK  
MAXH



A  
SGL  
LVL  
PRN

Date: 25.JUN.2007 13:51:07

Test: band edge compliance, Channel 810, EDGE



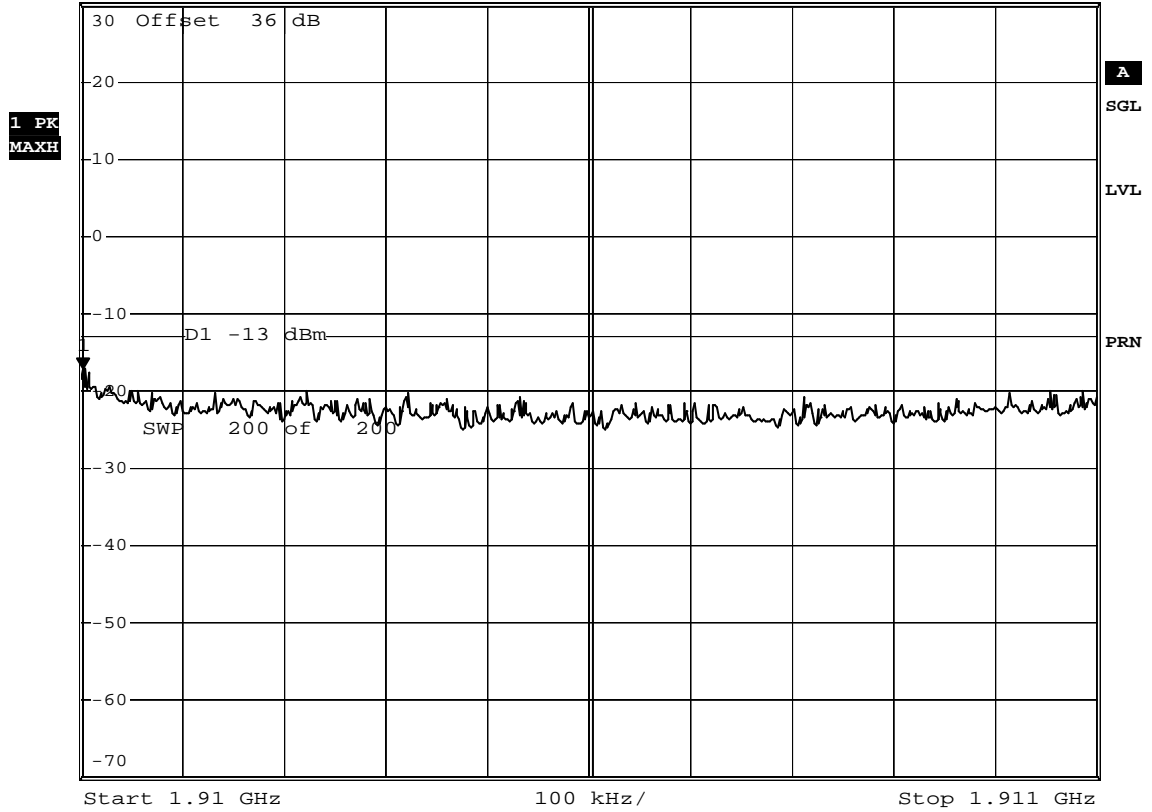
**Op. Mode**

op-mode 9



\*RBW 100 kHz Marker 1 [T1 ]  
\*VBW 300 kHz -17.12 dBm

Ref 30 dBm \*Att 30 dB SWT 2.5 ms 1.910002000 GHz



Date: 27.JUN.2007 08:19:30

Test: band edge compliance, Channel 9538, FDD II