



Inter**Lab**[®]

FCC Measurement/Technical Report on

GSM module
GTM351E

Report Reference: 4_Opti_0405_UMTS_FCCc

Test Laboratory:

7 layers AG
Borsigstrasse 11
40880 Ratingen
Germany
email: info@7Layers.de



DAT-P-192/99-01



Note:

The following test results relate only to the devices specified in this document. This report shall not be reproduced in parts without the written approval of the testing laboratory.

7 layers AG
Borsigstrasse 11
40880 Ratingen, Germany
Phone: +49 (0) 2102 749 0
Fax: +49 (0) 2102 749 350
www.7Layers.com

*Aufsichtsratsvorsitzender •
Chairman of the Supervisory Board:
Markus Becker
Vorstand • Board:
Dr. Hans-Jürgen Meckelburg
René Schildknecht*

*Registergericht • registered in:
Düsseldorf, HRB 44096
USt-IdNr • VAT Nr:
DE 203159652*

InterLab[®] is a registered trademark of 7 layers AG



Table of Contents

| | | |
|----------|--|-----------|
| 0 | Summary | 3 |
| 0.1 | Technical Report Summary | 3 |
| 0.2 | Measurement Summary | 4 |
| 1 | Administrative Data | 6 |
| 1.1 | Testing Laboratory | 6 |
| 1.2 | Project Data | 6 |
| 1.3 | Applicant Data | 6 |
| 1.4 | Manufacturer Data | 6 |
| 2 | Testobject Data | 7 |
| 2.1 | General EUT Description | 7 |
| 2.2 | EUT Main components | 8 |
| 2.3 | Ancillary Equipment | 8 |
| 2.4 | EUT Setups | 8 |
| 2.5 | Operating Modes | 9 |
| 3 | Test Results | 10 |
| 3.1 | RF Power Output | 10 |
| 3.2 | Frequency stability | 14 |
| 3.3 | Spurious emissions at antenna terminals | 18 |
| 3.4 | Field strength of spurious radiation | 22 |
| 3.5 | Emission and Occupied Bandwidth | 26 |
| 3.6 | Mobile emissions in base frequency range | 30 |
| 4 | Test Equipment | 33 |
| 5 | Photo Report | 36 |
| 6 | Setup Drawings | 40 |
| 7 | Annex | 42 |
| | Measurement Plots | |



0 Summary

0.1 Technical Report Summary

Type of Authorization

Certification for a GSM cellular radiotelephone device

Applicable FCC Rules

Prepared in accordance with the requirements of FCC Rules and Regulations as listed in 47 CFR Ch.1 Parts 0 to 19 and Parts 20 to 69 (10-1-04 Edition). The following subparts are applicable to the results in this test report.

Part 2

Subpart J - Equipment Authorization Procedures, Certification

- § 2.1046 Measurement required: RF power output
- § 2.1049 Measurement required: Occupied bandwidth
- § 2.1051 Measurement required: Spurious emissions at antenna terminals
- § 2.1053 Measurement required: Field strength of spurious radiation
- § 2.1055 Measurement required: Frequency stability
- § 2.1057 Frequency spectrum to be investigated

Part 22

Subpart C – Operational and Technical Requirements

- § 22.355 Frequency tolerance

Subpart H – Cellular Radiotelephone Service

- § 22.913 Effective radiated power limits
- § 22.917 Emission limitations for cellular equipment

Summary Test

The EUT complied with all performed tests as listed in chapter 0.2 Measurement Summary.



0.2 Measurement Summary

RF Power Output

| The measurement was performed according to FCC §2.1046 | | | 10-01-2004 |
|--|-----------|-------------------|--------------|
| OP-Mode | Setup | Port | Final Result |
| op-mode 1 | Setup_c01 | antenna connector | passed |
| op-mode 2 | Setup_c01 | antenna connector | passed |
| op-mode 3 | Setup_c01 | antenna connector | passed |
| op-mode 4 | Setup_c01 | antenna connector | passed |
| op-mode 5 | Setup_c01 | antenna connector | passed |
| op-mode 6 | Setup_c01 | antenna connector | passed |

Frequency stability

| The measurement was performed according to FCC §2.1055 | | | 10-01-2004 |
|--|-----------|-------------------|--------------|
| OP-Mode | Setup | Port | Final Result |
| op-mode 2 | Setup_a01 | antenna connector | passed |
| op-mode 5 | Setup_b01 | antenna connector | passed |

Spurious emissions at antenna terminals

| The measurement was performed according to FCC §2.1051 | | | 10-01-2004 |
|--|-----------|-------------------|--------------|
| OP-Mode | Setup | Port | Final Result |
| op-mode 1 | Setup_c01 | antenna connector | passed |
| op-mode 2 | Setup_c01 | antenna connector | passed |
| op-mode 3 | Setup_c01 | antenna connector | passed |
| op-mode 4 | Setup_c01 | antenna connector | passed |
| op-mode 5 | Setup_c01 | antenna connector | passed |
| op-mode 6 | Setup_c01 | antenna connector | passed |

Field strength of spurious radiation

| The measurement was performed according to FCC §2.1053 | | | 10-01-2004 |
|--|-----------|-------------------|--------------|
| OP-Mode | Setup | Port | Final Result |
| op-mode 1 | Setup_a02 | enclosure | passed |
| op-mode 2 | Setup_a02 | enclosure | passed |
| op-mode 3 | Setup_a02 | enclosure | passed |
| op-mode 4 | Setup_a02 | antenna connector | passed |
| op-mode 5 | Setup_a02 | antenna connector | passed |
| op-mode 6 | Setup_a02 | antenna connector | passed |

Emission and Occupied Bandwidth

| The measurement was performed according to FCC §2.1049 | | | 10-01-2004 |
|--|-----------|-------------------|--------------|
| OP-Mode | Setup | Port | Final Result |
| op-mode 1 | Setup_a01 | antenna connector | passed |
| op-mode 2 | Setup_a01 | antenna connector | passed |
| op-mode 3 | Setup_a01 | antenna connector | passed |
| op-mode 4 | Setup_a01 | antenna connector | passed |
| op-mode 5 | Setup_a01 | antenna connector | passed |
| op-mode 6 | Setup_a01 | antenna connector | passed |

Mobile emissions in base frequency range

The measurement was performed according to FCC §22.917 10-01-2004

| OP-Mode | Setup | Port | Final Result |
|----------------|--------------|-------------------|---------------------|
| op-mode 1 | Setup_c01 | antenna connector | passed |
| op-mode 2 | Setup_c01 | antenna connector | passed |
| op-mode 3 | Setup_c01 | antenna connector | passed |
| op-mode 4 | Setup_c01 | antenna connector | passed |
| op-mode 5 | Setup_c01 | antenna connector | passed |
| op-mode 6 | Setup_c01 | antenna connector | passed |

This report replaces the report 4_Opti_0405_UMTS_FCCa.

Responsible for
Accreditation Scope:



Responsible
for Test Report:





1 Administrative Data

1.1 Testing Laboratory

Company Name: 7 Layers AG
Address Borsigstr. 11
40880 Ratingen
Germany

This facility has been fully described in a report submitted to the FCC and accepted under the registration number 96716 .

The test facility is also accredited by the following accreditation organisation:
- DEUT'scher Akkreditierungs Rat DAR-Registration no. DAT-P-192/99-01

Responsible for Accreditation Scope: Dipl.-Ing. Bernhard Retka
Dipl.-Ing. Arndt Stöcker
Dipl.-Ing. Thomas Hoell

Report Template Version: 2005-10-10

1.2 Project Data

Responsible for testing and report: Dipl.-Ing. Robert Machulec
Receipt of EUT: 2005-10-07
Date of Test(s): 2005-10-07 to 2005-11-25
Date of Report: 2005-12-27

1.3 Applicant Data

Company Name: Option International NV SA
Address: Kolonel Begaultlaan 45
3012 Leuven
Belgium
Contact Person: Mr. Stefan Lodeweyckx

1.4 Manufacturer Data

Company Name: please see applicant data

Address:

Contact Person:

2 Testobject Data

2.1 General EUT Description

| | |
|--------------------------|---------------------------------|
| Equipment under | GSM module |
| Type Designation: | GTM351E |
| Kind of Device: | GSM 850/900/1800/1900 with EDGE |
| (optional) | |
| Voltage Type: | DC |
| Nominal Voltage: | 3.0 V |
| Maximum Voltage: | 3.5 V |
| Minimum Voltage: | 3.5 V |

General product description:

The Equipment Under Test (EUT) is a GSM 850/900/1800/1900 with EDGE module.

In GSM 850 mode the EUT operates in channel blocks A and B from 824.2 MHz (lowest channel = 128) to 848.8 MHz (highest channel = 251).

The EUT provides the following ports:

Ports

- antenna connector
- enclosure
- mini PCMCIA slot

The main components of the EUT are listed and described in Chapter 2.2



2.2 EUT Main components

Type, S/N, Short Descriptions etc. used in this Test Report

| Short Description | Equipment under Test | Type Designation | Serial No. | HW Status | SW Status | Date of Receipt |
|--|----------------------|------------------|---------------|-----------|-----------|-----------------|
| EUT A (Code: 37060b01) | GSM module | GTM351 | Test sample 1 | 1.0 | 3.4.0 | 2005-10-07 |
| Remark: EUT A is equipped with an antenna connector. | | | | | | |
| EUT B (Code: 37060c01) | GSM module | GTM351 | Test sample 2 | 1.0 | 3.4.0 | 2005-10-07 |
| Remark: EUT A is equipped with an antenna connector. | | | | | | |

NOTE: The short description is used to simplify the identification of the EUT in this test report.

2.3 Ancillary Equipment

For the purposes of this test report, ancillary equipment is defined as equipment which is used in conjunction with the EUT to provide operational and control features to the EUT. It is necessary to configure the system in a typical fashion, as a customer would normally use it. But nevertheless Ancillary Equipment can influence the test results.

| Short Description | Equipment under Test | Type Designation | HW Status | SW Status | Serial no. | FCC ID |
|-------------------|------------------------|------------------|-----------|-----------|------------|--------|
| AE1 | Cradle | - | - | - | - | - |
| AE2 | Antenna (gain=2dBi) | OI-ANT-EX-3G | - | - | - | - |
| AE3 | Cradle | - | - | - | - | - |
| AE4 | Cradle | - | - | - | - | - |

NOTE: The cradle AE1 was modified with additional capacitors.

2.4 EUT Setups

This chapter describes the combination of EUT's and ancillary equipment used for testing.

| Setup No. | Combination of EUT's | Description |
|-----------|----------------------|---|
| setup_a01 | EUT A + AE1 | setup for conducted tests |
| setup_b01 | EUT A + AE3 | setup for conducted tests |
| setup_c01 | EUT B + AE4 | setup for conducted tests |
| setup_a02 | EUT A + AE3 + AE2 | setup for radiated spurious emissions tests |



2.5 Operating Modes

This chapter describes the operating modes of the EUT's used for testing.

| Op. Mode | Description of Operating Modes | Remarks |
|-----------------------|--|--|
| PCS data call | | |
| op-mode 1 | Call established on Traffic Channel (TCH) 128, Carrier Frequency 824.2 MHz | 128 is the lowest channel PCS data call |
| op-mode 2 | Call established on Traffic Channel (TCH) 190, Carrier Frequency 836.6 MHz | 190 is a mid channel PCS data call |
| op-mode 3 | Call established on Traffic Channel (TCH) 251, Carrier Frequency 848.8 MHz | 251 is the highest channel PCS data call |
| EDGE data call | | |
| op-mode 4 | Call established on Traffic Channel (TCH) 128, Carrier Frequency 824.2 MHz | 128 is the lowest channel EDGE data call |
| op-mode 5 | Call established on Traffic Channel (TCH) 190, Carrier Frequency 836.6 MHz | 190 is a mid channel EDGE data call |
| op-mode 6 | Call established on Traffic Channel (TCH) 251, Carrier Frequency 848.8 MHz | 251 is the highest channel EDGE data call |



3 Test Results

3.1 RF Power Output

Standard FCC Part 22, 10-01-2004
Subpart H

The test was performed according to: FCC §2.1046, 10-01-2004

3.1.1 Test Description

1) The EUT was coupled to the R&S Spectrum Analyser and the R&S CMU200 Digital Communication Tester through a Power Divider. Refer to chapter "Setup Drawings".

2) The total insertion losses for RF Path 1 and RF Path 2 were measured. The values were used to correct the readings from the R&S Spectrum Analyser and the R&S CMU200 Digital Communication Tester.

3) A speech call was established on a Traffic Channel (TCH) between the EUT and the base station simulator (R&S CMU200 Digital Communication Tester).

Important Settings:

- Discontinuous Transmission: OFF
- Modulation Signal: PSR16-1 (Pseudo Random Sequence)
- Output Power: Varied during measurements
- Channel (Frequency): Varied during measurements

4) The transmitted power of the EUT was recorded for all possible power control level by using an internal measurement function of the CMU200.

5) During this test the Spectrum Analyser was only used to check if the results are comprehensible.

3.1.2 Test Requirements / Limits

§2.1046 Measurements Required: RF Power Output

(a) For transmitters other than single sideband, independent sideband and controlled carrier radiotelephone, power output shall be measured at the RF output terminals when the transmitter is adjusted in accordance with the tune-up procedure to give the values of current and voltage on the circuit elements specified in § 2.1033(c)(8). The electrical characteristics of the output terminals when this test is made shall be stated.

§22.913 Effective radiated power limits

(a) Maximum ERP. ... The ERP of mobile transmitters and auxiliary test transmitters must not exceed 7 Watts.

3.1.3 Test Protocol

Temperature: 24 °C
 Air Pressure: 1012 hPa
 Humidity: 37 %

| Op. Mode | Setup | Port |
|-----------|-----------|-------------------|
| op-mode 1 | setup_c01 | antenna connector |

| Power Control Level | Output power Nominal (dBm) | Output power Measured (dBm) | Difference dB |
|---------------------|----------------------------|-----------------------------|---------------|
| 5 | 33 | 32.12 | -0.88 |
| 6 | 31 | 30.49 | -0.51 |
| 7 | 29 | 28.38 | -0.62 |
| 8 | 27 | 26.34 | -0.66 |
| 9 | 25 | 24.38 | -0.62 |
| 10 | 23 | 22.46 | -0.54 |
| 11 | 21 | 20.52 | -0.48 |
| 12 | 19 | 18.36 | -0.64 |
| 13 | 17 | 16.31 | -0.69 |
| 14 | 15 | 14.27 | -0.73 |
| 15 | 13 | 12.21 | -0.79 |
| 16 | 11 | 10.18 | -0.82 |
| 17 | 9 | 8.08 | -0.92 |
| 18 | 7 | 6.01 | -0.99 |
| 19 | 5 | 3.91 | -1.09 |

Remark: The ERP including antenna gain (-0.14 dBD) is 31.98 dBm.

| Op. Mode | Setup | Port |
|-----------|-----------|-------------------|
| op-mode 2 | setup_c01 | antenna connector |

| Power Control Level | Output power Nominal (dBm) | Output power Measured (dBm) | Difference dB |
|---------------------|----------------------------|-----------------------------|---------------|
| 5 | 33 | 32.18 | -0.82 |
| 6 | 31 | 30.54 | -0.46 |
| 7 | 29 | 28.42 | -0.58 |
| 8 | 27 | 26.41 | -0.59 |
| 9 | 25 | 24.45 | -0.55 |
| 10 | 23 | 22.53 | -0.47 |
| 11 | 21 | 20.58 | -0.42 |
| 12 | 19 | 18.43 | -0.57 |
| 13 | 17 | 16.36 | -0.64 |
| 14 | 15 | 14.31 | -0.69 |
| 15 | 13 | 12.25 | -0.75 |
| 16 | 11 | 10.23 | -0.77 |
| 17 | 9 | 8.11 | -0.89 |
| 18 | 7 | 5.99 | -1.01 |
| 19 | 5 | 3.88 | -1.12 |

Remark: The ERP including antenna gain (-0.14 dBD) is 32.04 dBm.



| Op. Mode | Setup | Port |
|-----------|-----------|-------------------|
| op-mode 3 | setup_c01 | antenna connector |

| Power Control Level | Output power Nominal (dBm) | Output power Measured (dBm) | Difference dB |
|---------------------|----------------------------|-----------------------------|---------------|
| 5 | 33 | 32.17 | -0.83 |
| 6 | 31 | 30.56 | -0.44 |
| 7 | 29 | 28.45 | -0.55 |
| 8 | 27 | 26.43 | -0.57 |
| 9 | 25 | 24.46 | -0.54 |
| 10 | 23 | 22.56 | -0.44 |
| 11 | 21 | 20.58 | -0.42 |
| 12 | 19 | 18.44 | -0.56 |
| 13 | 17 | 16.37 | -0.63 |
| 14 | 15 | 14.31 | -0.69 |
| 15 | 13 | 12.23 | -0.77 |
| 16 | 11 | 10.18 | -0.82 |
| 17 | 9 | 8.06 | -0.94 |
| 18 | 7 | 5.97 | -1.03 |
| 19 | 5 | 3.85 | -1.15 |

Remark: The ERP including antenna gain (-0.14 dBD) is 32.03dBm.

| Op. Mode | Setup | Port |
|-----------|-----------|-------------------|
| op-mode 4 | setup_c01 | antenna connector |

| Power Control Level | Output power Nominal (dBm) | Output power Measured (dBm) | Difference dB |
|---------------------|----------------------------|-----------------------------|---------------|
| 5 | 33 | 27.92 | 5.08 |

Remark: The ERP including antenna gain (-0.14 dBD) is 27.78 dBm.

| Op. Mode | Setup | Port |
|-----------|-----------|-------------------|
| op-mode 5 | setup_c01 | antenna connector |

| Power Control Level | Output power Nominal (dBm) | Output power Measured (dBm) | Difference dB |
|---------------------|----------------------------|-----------------------------|---------------|
| 5 | 33 | 27.95 | 5.05 |

Remark: The ERP including antenna gain (-0.14 dBD) is 27.81 dBm.

| Op. Mode | Setup | Port |
|-----------|-----------|-------------------|
| op-mode 6 | setup_c01 | antenna connector |

| Power Control Level | Output power Nominal (dBm) | Output power Measured (dBm) | Difference dB |
|---------------------|----------------------------|-----------------------------|---------------|
| 5 | 33 | 27.93 | 5.07 |

Remark: The ERP including antenna gain (-0.14 dBD) is 27.79 dBm.



3.1.4 Test result: RF Power Output

| FCC Part 22, Subpart H | Op. Mode | Result |
|------------------------|-----------|--------|
| | op-mode 1 | passed |
| | op-mode 2 | passed |
| | op-mode 3 | passed |
| | op-mode 4 | passed |
| | op-mode 5 | passed |
| | op-mode 6 | passed |



3.2 Frequency stability

Standard FCC Part 22, 10-01-2004
Subpart H

The test was performed according to FCC §2.1055, 10-01-2004

3.2.1 Test Description

- 1) The EUT was placed inside the climatic chamber.
- 2) The EUT was coupled to the R&S CMU200 Digital Communication Tester. Refer to chapter "Setup Drawings".
- 3) The climatic chamber was cycled down/up to a certain temperature, starting with -30°C .
- 4) After the temperature was stabilized (at least one hour) the EUT was switched on and a speech call was established on a Traffic Channel (TCH) between the EUT and the base station simulator (R&S CMU200 Digital Communication Tester).
Important Settings:
 - Discontinuous Transmission: OFF
 - Modulation Signal: PSR16-1 (Pseudo Random Sequence)
 - Output Power: Maximum
 - Channel: 190 [836.6 MHz]
- 5) The frequency error of the EUT were recorded by using an internal measurement function of the CMU200 immediately after the call was established, five minutes after the call was established and ten minutes after the call was established.
- 6) This measurement procedure was performed for all combinations of voltage (low, nominal, high) and temperature (from -30°C to $+50^{\circ}\text{C}$ in increments of 10°C).

3.2.2 Test Requirements / Limits

§2.1055 Measurements required: Frequency stability

(a) The frequency stability shall be measured with variation of ambient temperature as follows:

(1) From -30° to $+50^{\circ}$ centigrade for all equipment except that specified in paragraphs (a) (2) and (3) of this section.

(b) Frequency measurements shall be made at the extremes of the specified temperature range and at intervals of not more than 10° centigrade through the range. A period of time sufficient to stabilize all of the components of the oscillator circuit at each temperature level shall be allowed prior to frequency measurement. The short term transient effects on the frequency of the transmitter due to keying (except for broadcast transmitters) and any heating element cycling normally occurring at each ambient temperature level also shall be shown. Only the portion or portions of the transmitter containing the frequency determining and stabilizing circuitry need be subjected to the temperature variation test.



(d) The frequency stability shall be measured with variation of primary supply voltage as follows:

- (1) Vary primary supply voltage from 85 to 115 percent of the nominal value for other than hand carried battery equipment.
- (2) For hand carried, battery powered equipment, reduce primary supply voltage to the battery operating end point which shall be specified by the manufacturer.
- (3) The supply voltage shall be measured at the input to the cable normally provided with the equipment, or at the power supply terminals if cables are not normally provided. Effects on frequency of transmitter keying (except for broadcast transmitters) and any heating element cycling at the nominal supply voltage and at each extreme also shall be shown.

§22.355 Frequency tolerance

...the carrier frequency of each transmitter in the Public Mobile Service must be maintained within the tolerances given in table C-1 of this section.

Table C-1.- Frequency Tolerance for Transmitters in the Public Mobile Services

| Frequency range (ppm) | Base, fixed (ppm) | Mobile up to 3 watts (ppm) | Mobile above 3 watts (ppm) |
|-----------------------|-------------------|----------------------------|----------------------------|
| 25 to 50 | 20.0 | 20.0 | 50.0 |
| 50 to 450 | 5.0 | 5.0 | 50.0 |
| 450 to 512 | 2.5 | 5.0 | 5.0 |
| 821 to 896 | 1.5 | 2.5 | 2.5 |
| 928 to 929 | 5.0 | n/a | n/a |
| 929 to 960 | 1.5 | n/a | n/a |
| 2110 to 2220 | 10.0 | n/a | n/a |

For the mid channel (836.6 MHz) the frequency tolerance is 2.5 ppm (2091.5 Hz).



3.2.3 Test Protocol

Temperature: 24 °C
 Air Pressure: 1012 hPa
 Humidity: 37 %

Op. Mode **Setup** **Port**
 op-mode 2 setup_a01 antenna connector

| | | Minimum Voltage / V | | Normal Voltage / V | | Maximum Voltage / V | |
|----------|--------------|--------------------------|-----------------------|--------------------------|-----------------------|--------------------------|-----------------------|
| | | 3.0 | | 3.5 | | 3.5 | |
| Temp. °C | Duration min | Freq. error Average (Hz) | Freq. error Max. (Hz) | Freq. error Average (Hz) | Freq. error Max. (Hz) | Freq. error Average (Hz) | Freq. error Max. (Hz) |
| -30 | 0 | -46 | -55 | -9 | -17 | | |
| -30 | 5 | -30 | -38 | -7 | -15 | | |
| -30 | 10 | -28 | -34 | -3 | -11 | | |
| -20 | 0 | -43 | -51 | -6 | -12 | | |
| -20 | 5 | -25 | -34 | -4 | -10 | | |
| -20 | 10 | -45 | -52 | -6 | -11 | | |
| -10 | 0 | -41 | -49 | -6 | -12 | | |
| -10 | 5 | -40 | -47 | -2 | -9 | | |
| -10 | 10 | -33 | -40 | 1 | 5 | | |
| 0 | 0 | 1 | 8 | 9 | 16 | | |
| 0 | 5 | -13 | -24 | -10 | -16 | | |
| 0 | 10 | -15 | -23 | -28 | -34 | | |
| 10 | 0 | -45 | -53 | -10 | -18 | | |
| 10 | 5 | -33 | -38 | -8 | -14 | | |
| 10 | 10 | -28 | -34 | -2 | -8 | | |
| 20 | 0 | -41 | -48 | -8 | -13 | | |
| 20 | 5 | -24 | -32 | -5 | -11 | | |
| 20 | 10 | -28 | -37 | -4 | -9 | | |
| 30 | 0 | -40 | -44 | -9 | -14 | | |
| 30 | 5 | -23 | -30 | -6 | -9 | | |
| 30 | 10 | -15 | -29 | -2 | -5 | | |
| 40 | 0 | -38 | -43 | -8 | -16 | | |
| 40 | 5 | -28 | -37 | -9 | -14 | | |
| 40 | 10 | -13 | -22 | -5 | -11 | | |
| 50 | 0 | -40 | -50 | -11 | -19 | | |
| 50 | 5 | -33 | -45 | -10 | -17 | | |
| 50 | 10 | -21 | -29 | -6 | -15 | | |

Remark: The manufacturer declared normal = maximum voltage.

Op. Mode **Setup** **Port**
 op-mode 5 setup_b01 antenna connector

| | | Minimum Voltage / V | | Normal Voltage / V | | Maximum Voltage / V | |
|----------|--------------|--------------------------|-----------------------|--------------------------|-----------------------|--------------------------|-----------------------|
| | | 3.0 | | 3.5 | | 3.5 | |
| Temp. °C | Duration min | Freq. error Average (Hz) | Freq. error Max. (Hz) | Freq. error Average (Hz) | Freq. error Max. (Hz) | Freq. error Average (Hz) | Freq. error Max. (Hz) |
| -30 | 0 | 38 | 47 | 22 | 33 | | |
| -30 | 5 | 32 | 43 | 29 | 39 | | |
| -30 | 10 | 29 | 36 | 25 | 36 | | |
| -20 | 0 | 9 | 17 | 19 | 28 | | |
| -20 | 5 | 21 | 30 | 17 | 28 | | |
| -20 | 10 | -32 | -42 | -6 | -19 | | |
| -10 | 0 | -35 | -48 | -39 | -49 | | |
| -10 | 5 | -34 | -56 | -36 | -47 | | |
| -10 | 10 | -32 | -43 | -37 | -47 | | |



| | | | | | | | |
|----|----|-----|-----|-----|-----|--|--|
| 0 | 0 | -33 | -45 | -40 | -54 | | |
| 0 | 5 | -26 | -35 | -36 | -45 | | |
| 0 | 10 | -30 | -38 | -35 | -42 | | |
| 10 | 0 | -31 | -41 | -35 | -43 | | |
| 10 | 5 | -33 | -43 | -37 | -45 | | |
| 10 | 10 | -25 | -35 | 31 | -38 | | |
| 20 | 0 | 4 | 14 | -24 | -33 | | |
| 20 | 5 | -33 | -41 | -34 | -43 | | |
| 20 | 10 | -26 | -36 | -30 | -38 | | |
| 30 | 0 | -32 | -41 | -25 | -35 | | |
| 30 | 5 | -33 | -43 | -37 | -42 | | |
| 30 | 10 | -27 | -35 | -35 | -43 | | |
| 40 | 0 | -32 | -41 | -35 | -41 | | |
| 40 | 5 | -34 | -40 | -34 | -42 | | |
| 40 | 10 | -21 | -27 | -24 | -31 | | |
| 50 | 0 | 13 | 20 | 29 | 37 | | |
| 50 | 5 | 37 | 43 | 35 | 40 | | |
| 50 | 10 | -38 | -45 | -8 | -15 | | |

Remark: The manufacturer declared normal = maximum voltage.

3.2.4 Test result: Frequency stability

| FCC Part 22, Subpart H | Op. Mode | Result |
|------------------------|-----------|--------|
| | op-mode 2 | passed |
| | op-mode 5 | passed |

3.3 Spurious emissions at antenna terminals

Standard FCC Part 22, 10-01-2004
Subpart H

The test was performed according to FCC §2.1051, 10-01-2004

3.3.1 Test Description

1) The EUT was coupled to the R&S Spectrum Analyser and the R&S CMU200 Digital Communication Tester through a Power Divider. Refer to chapter "Setup Drawings".

2) The total insertion losses for RF Path 1 and RF Path 2 were measured. The values were used to correct the readings from the R&S Spectrum Analyser and the R&S CMU200 Digital Communication Tester.

3) A speech call was established on a Traffic Channel (TCH) between the EUT and the base station simulator (R&S CMU200 Digital Communication Tester).

Important Settings:

- Discontinuous Transmission: OFF
- Modulation Signal: PSR16-1 (Pseudo Random Sequence)
- Output Power: Maximum
- Channel: Varied during measurements
(lowest channel: 128, mid channel: 190 and highest channel: 251)

4) Important Analyser Settings

- [Resolution Bandwidth / Video Bandwidth]:
 - a) [3 kHz / 10 kHz] in the Span of 1 MHz directly below and above the GSM-Band,
 - b) [10 kHz / 30 kHz] in case the curve of the analyser IF-Filter leads to an exceeding of the limit, in this case a worst case correction factor of 20 dB (1 MHz -> 10 kHz) was used
 - c) [1 MHz / 3 MHz] otherwise
- Sweep Time: Calculated by using a formula given in the Product Standard "GSM 11.10-1 edition 4" for spurious emissions measurements (depending on the transmitting signal, the span and the resolution bandwidth)

5) The spurious emissions (peak) were measured in the frequency range from 9 kHz to 10 GHz (up to the 10th harmonic) during the call is established on the lowest channel (128), mid channel (190) and on the highest channel (251).

3.3.2 Test Requirements / Limits

§ 2.1051 Spurious emissions at antenna terminals

The radio frequency voltage or power generated within the equipment and appearing on a spurious frequency shall be checked at the equipment output terminals when properly loaded with a suitable artificial antenna. Curves or equivalent data shall show the magnitude of each harmonic and other spurious emission that can be detected when the equipment is operated under the conditions specified in Sec. 2.1049 as appropriate. The magnitude of spurious emissions which are attenuated more than 20 dB below the permissible value need not be specified.



§ 2.1057 Frequency spectrum to be investigated.

(a) In all of the measurements set forth in Secs. 2.1051 and 2.1053, the spectrum shall be investigated from the lowest radio frequency signal generated in the equipment, without going below 9 kHz, up to at least the frequency shown below:

(1) If the equipment operates below 10 GHz: to the tenth harmonic of the highest fundamental frequency or to 40 GHz, whichever is lower.

(b) Particular attention should be paid to harmonics and subharmonics of the carrier frequency as well as to those frequencies removed from the carrier by multiples of the oscillator frequency. Radiation at the frequencies of multiplier stages should also be checked.

(c) The amplitude of spurious emissions which are attenuated more than 20 dB below the permissible value need not be reported.

(d) Unless otherwise specified, measurements above 40 GHz shall be performed using a minimum resolution bandwidth of 1 MHz.

§ 22.917 Emission limitations for cellular

(e) Out of band emissions. The mean power of emissions must be attenuated below the mean power of the unmodulated carrier (P) on any frequency twice or more than twice the fundamental frequency by: at least $43+10 \log P$ dB.

3.3.3 Test Protocol

Temperature: 22 °C
 Air Pressure: 1030 hPa
 Humidity: 34 %

| Op. Mode | Setup | Port |
|-----------|-----------|-------------------|
| op-mode 1 | setup_c01 | antenna connector |

| Frequency MHz | Bandwidth kHz | Measured Level dBm | Limit dBm |
|---------------|---------------|--------------------|-----------|
| 823 | 3.0 | -14.47 | -13.0 |
| 1647 | 1000 | -34.96 | -13.0 |
| 2474 | 1000 | -36.29 | -13.0 |

Remark: No (further) spurious emissions were found in the range 20 dB below the limit.

| Op. Mode | Setup | Port |
|-----------|-----------|-------------------|
| op-mode 2 | setup_c01 | antenna connector |

| Frequency MHz | Bandwidth kHz | Measured Level dBm | Limit dBm |
|---------------|---------------|--------------------|-----------|
| 879 | 1000 | -26.22 | -13.0 |
| 1673 | 1000 | -37.06 | -13.0 |
| 2511 | 1000 | -34.44 | -13.0 |

Remark: No (further) spurious emissions were found in the range 20 dB below the limit.

| Op. Mode | Setup | Port |
|-----------|-----------|-------------------|
| op-mode 3 | setup_c01 | antenna connector |

| Frequency MHz | Bandwidth kHz | Measured Level dBm | Limit dBm |
|---------------|---------------|--------------------|-----------|
| 849 | 3.0 | -13.45 | -13.0 |
| 1696 | 1000 | -37.20 | -13.0 |
| 2549 | 1000 | -35.17 | -13.0 |

Remark: No (further) spurious emissions were found in the range 20 dB below the limit.

| Op. Mode | Setup | Port |
|-----------|-----------|-------------------|
| op-mode 4 | setup_c01 | antenna connector |

| Frequency MHz | Bandwidth kHz | Measured Level dBm | Limit dBm |
|---------------|---------------|--------------------|-----------|
| 823 | 3.0 | -21.26 | -13.0 |

Remark: No (further) spurious emissions were found in the range 20 dB below the limit.

| Op. Mode | Setup | Port |
|-----------|-----------|-------------------|
| op-mode 5 | setup_a01 | antenna connector |



| Frequency MHZ | Bandwidth kHz | Measured Level dBm | Limit dBm |
|------------------|------------------|-----------------------|--------------|
| | | | -13 |

Remark: No (further) spurious emissions were found in the range 20 dB below the limit.

| Op. Mode | Setup | Port |
|-----------|-----------|-------------------|
| op-mode 6 | setup_c01 | antenna connector |

| Frequency MHZ | Bandwidth kHz | Measured Level dBm | Limit dBm |
|------------------|------------------|-----------------------|--------------|
| 849 | 3.0 | -21.04 | -13.0 |

Remark: No (further) spurious emissions were found in the range 20 dB below the limit.

3.3.4 Test result: Spurious emissions at antenna terminals

| FCC Part 22, Subpart H | Op. Mode | Result |
|------------------------|-----------|--------|
| | op-mode 1 | passed |
| | op-mode 2 | passed |
| | op-mode 3 | passed |
| | op-mode 4 | passed |
| | op-mode 5 | passed |
| | op-mode 6 | passed |

3.4 Field strength of spurious radiation

Standard FCC Part 22, 10-01-2004
Subpart H

The test was performed according to: FCC §2.1053, 10-01-2004

3.4.1 Test Description

1) The EUT was placed inside a anechoic chamber. Refer to chapter "Setup Drawings". The EUT was coupled to the R&S CMU200 Digital Communication Tester which was located outside the chamber via coaxial cable.

2) A speech call was established on a Traffic Channel (TCH) between the EUT and the base station simulator (R&S CMU200 Digital Communication Tester).

Important Settings:

- Discontinuous Transmission: OFF
- Modulation Signal: PSR16-1 (Pseudo Random Sequence)
- Output Power: Maximum
- Channel : Varied during measurements

(lowest channel: 128, mid channel: 190 and highest channel: 251)

3) A pre-calibration procedure is used so that the readings from the spectrum analyser are corrected and represent directly the equivalent radiated power (related to a $\lambda/2$ dipole).

4) All spurious radiation measurements were made with spectrum analyser and the appropriate calibrated antennas for the frequency range of 30 MHz to 10 GHz (up to the 10th harmonic of the transmit frequency).

5) Important Analyser Settings

- [Resolution Bandwidth / Video Bandwidth]:

a) [3 kHz / 10 kHz] in the Span of 1 MHz directly below and above the GSM-Band,

b) [10 kHz / 30 kHz] in case the curve of the analyser IF-Filter leads to an exceeding of the limit, in this case a worst case correction factor of 20 dB (1 MHz \rightarrow 10 kHz) was used

c) [1 MHz / 3 MHz] otherwise

- Sweep Time: Calculated by using a formula given in the Product Standard "GSM 11.10-1 edition 4" for spurious emissions measurements (depending on the transmitting signal, the span and the resolution bandwidth)

6) The spurious emissions (peak) were measured in both vertical and horizontal antenna polarisation during the call is established on the lowest channel (128), mid channel (190) and on the highest channel (251).

3.4.2 Test Requirements / Limits

§ 2.1053 Measurements required: Field strength of spurious radiation.

Measurements shall be made to detect spurious emissions that may be radiated directly from the cabinet, control circuits, power leads, or intermediate circuit elements under normal conditions of installation and operation. Curves or equivalent data shall be supplied showing the magnitude of each harmonic and other spurious emission. For this test, single sideband, independent sideband, and controlled carrier transmitters shall be modulated under the conditions specified in paragraph (c) of Sec. 2.1049, as appropriate.

For equipment operating on frequencies below 890 MHz, an open field test is normally required, with the measuring instrument antenna located in the far-field at all test frequencies. In the event it is either impractical or impossible to make open field measurements (e.g. a broadcast transmitter installed in a building) measurements will be accepted of the equipment as installed. Such measurements must be accompanied by a description of the site where the measurements were made showing the location of any possible source of reflections which might distort the field strength measurements. Information submitted shall include the relative radiated power of each spurious emission with reference to the rated power output of the transmitter, assuming all emissions are radiated from halfwave dipole antennas.

(b) The measurements specified in paragraph (a) of this section shall be made for the following equipment:

(2) All equipment operating on frequencies higher than 25 MHz.

§ 2.1057 Frequency spectrum to be investigated.

(a) In all of the measurements set forth in Secs. 2.1051 and 2.1053, the spectrum shall be investigated from the lowest radio frequency signal generated in the equipment, without going below 9 kHz, up to at least the frequency shown below:

(1) If the equipment operates below 10 GHz: to the tenth harmonic of the highest fundamental frequency or to 40 GHz, whichever is lower.

(b) Particular attention should be paid to harmonics and subharmonics of the carrier frequency as well as to those frequencies removed from the carrier by multiples of the oscillator frequency. Radiation at the frequencies of multiplier stages should also be checked.

(c) The amplitude of spurious emissions which are attenuated more than 20 dB below the permissible value need not be reported.

(d) Unless otherwise specified, measurements above 40 GHz shall be performed using a minimum resolution bandwidth of 1 MHz.

§ 22.917 Emission limitations for cellular

(e) Out of band emissions. The mean power of emissions must be attenuated below the mean power of the unmodulated carrier (P) on any frequency twice or more than twice the fundamental frequency by: at least $43 + 10 \log P$ dB.

This is calculated to be -13 dBm (effective radiated power) which corresponds to 84.6 dB μ V/m (field strength) in a distance of 3 m.

3.4.3 Test Protocol

Temperature: 24 °C
 Air Pressure: 1029 hPa
 Humidity: 35 %

| Op. Mode | Setup | Port |
|-----------|-----------|-----------|
| op-mode 1 | setup_a02 | enclosure |

| Frequency MHz | Antenna Polarisation | Bandwidth kHz | Measured Level dBm | Limit dBm |
|---------------|----------------------|---------------|--------------------|-----------|
| 824 | Vertical | 3.0 | -23.70 | -13.0 |

Remark: No (further) spurious emissions were found in the range 20 dB below the limit.

| Op. Mode | Setup | Port |
|-----------|-----------|-----------|
| op-mode 2 | setup_a02 | enclosure |

| Frequency MHz | Antenna Polarisation | Bandwidth kHz | Measured Level dBm | Limit dBm |
|---------------|----------------------|---------------|--------------------|-----------|
| | | | | -13.0 |

Remark: No (further) spurious emissions were found in the range 20 dB below the limit.

| Op. Mode | Setup | Port |
|-----------|-----------|-----------|
| op-mode 3 | setup_a02 | enclosure |

| Frequency MHz | Antenna Polarisation | Bandwidth kHz | Measured Level dBm | Limit dBm |
|---------------|----------------------|---------------|--------------------|-----------|
| 849 | Vertical | 3.0 | -21.79 | -13.0 |

Remark: No (further) spurious emissions were found in the range 20 dB below the limit.

| Op. Mode | Setup | Port |
|-----------|-----------|-----------|
| op-mode 4 | setup_a02 | enclosure |

| Frequency MHz | Antenna Polarisation | Bandwidth kHz | Measured Level dBm | Limit dBm |
|---------------|----------------------|---------------|--------------------|-----------|
| 824 | Vertical | 3.0 | -32.39 | -13.0 |

Remark: No (further) spurious emissions were found in the range 20 dB below the limit.

| Op. Mode | Setup | Port |
|-----------|-----------|-----------|
| op-mode 5 | setup_a02 | enclosure |

| Frequency MHz | Antenna Polarisation | Bandwidth kHz | Measured Level dBm | Limit dBm |
|---------------|----------------------|---------------|--------------------|-----------|
| | | | | -13.0 |

Remark: No (further) spurious emissions were found in the range 20 dB below the limit.

| Op. Mode | Setup | Port |
|----------|-------|------|
|----------|-------|------|



op-mode 6 setup_a02 enclosure

| Frequency MHz | Antenna Polarisation | Bandwidth kHz | Measured Level dBm | Limit dBm |
|---------------|----------------------|---------------|--------------------|-----------|
| 849 | Vertical | 3.0 | -29.95 | -13.0 |

Remark: No (further) spurious emissions were found in the range 20 dB below the limit.

3.4.4 Test result: Field strength of spurious radiation

| FCC Part 22, Subpart H | Op. Mode | Result |
|------------------------|-----------|--------|
| | op-mode 1 | passed |
| | op-mode 2 | passed |
| | op-mode 3 | passed |
| | op-mode 4 | passed |
| | op-mode 5 | passed |
| | op-mode 6 | passed |



3.5 Emission and Occupied Bandwidth

Standard FCC Part 22, 10-01-2004
Subpart H

The test was performed according to: FCC §2.1049, 10-01-2004

3.5.1 Test Description

1) The EUT was coupled to the R&S Spectrum Analyser and the R&S CMU200 Digital Communication Tester through a Power Divider. Refer to chapter "Setup Drawings".

2) The total insertion losses for RF Path 1 and RF Path 2 were measured. The values were used to correct the readings from the R&S Spectrum Analyser and the R&S CMU200 Digital Communication Tester.

3) A speech call was established on a Traffic Channel (TCH) between the EUT and the base station simulator (R&S CMU200 Digital Communication Tester).

Important Settings:

- Discontinuous Transmission: OFF
- Modulation Signal: PSR16-1 (Pseudo Random Sequence)
- Output Power: Maximum
- Channel : Varied during measurements
(lowest channel: 128, mid channel: 190 and highest channel: 251)

4) Important Analyser Settings:

- Resolution Bandwidth: 3 kHz (1% of the manufacturers stated occupied bandwidth)
- Video Bandwidth: 10 kHz (three times the Resolution Bandwidth)
- Sweep Span: 1 MHz (at least 250% of the emission bandwidth)

5) The maximum spectral level of the modulated signal was recorded as the reference.

6) The emission bandwidth is measured as follows:
the two furthest frequencies above and below the frequency of the maximum reference level where the spectrum is -26 dB down have to be found.

7) The occupied bandwidth (99% Bandwidth) is measured as follows:
the occupied bandwidth, that is the frequency bandwidth such that, below its lower and above its upper frequency limits, the mean powers radiated are each equal to 0.5 percent of the total mean power.



3.5.2 Test Requirements / Limits

§ 2.1049 Measurements required: Occupied bandwidth

The occupied bandwidth, that is the frequency bandwidth such that, below its lower and above its upper frequency limits, the mean powers radiated are each equal to 0.5 percent of the total mean power radiated by a given emission shall be measured under the following conditions (as applicable):

(h) Transmitters employing digital modulation techniques - when modulated by an input signal such that its amplitude and symbol rate represent the maximum rated conditions under which the equipment will be operated. The signal shall be applied through any filter networks, pseudo-random generators or other devices required in normal service. Additionally, the occupied bandwidth shall be shown for operation with any devices used for modifying the spectrum when such devices are optional at the discretion of the user.

(i) Transmitters designed for other types of modulation -

3.5.3 Test Protocol

Temperature: 24 °C
 Air Pressure: 1010 hPa
 Humidity: 38 %

| Op. Mode | Setup | Port |
|-----------|-----------|-------------------|
| op-mode 1 | setup_a01 | antenna connector |

| Bandwidth kHz | Remarks |
|---------------|------------------|
| 313 | please see annex |

Remark: The given value is the result of the 26dB bandwidth measurement.
 The 99% Bandwidth is 246 kHz.

| Op. Mode | Setup | Port |
|-----------|-----------|-------------------|
| op-mode 2 | setup_a01 | antenna connector |

| Bandwidth kHz | Remarks |
|---------------|------------------|
| 315 | please see annex |

Remark: The given value is the result of the 26dB bandwidth measurement.
 The 99% Bandwidth is 244 kHz.

| Op. Mode | Setup | Port |
|-----------|-----------|-------------------|
| op-mode 3 | setup_a01 | antenna connector |

| Bandwidth kHz | Remarks |
|---------------|------------------|
| 311 | please see annex |

Remark: The given value is the result of the 26dB bandwidth measurement.
 The 99% Bandwidth is 244 kHz.

| Op. Mode | Setup | Port |
|-----------|-----------|-------------------|
| op-mode 4 | setup_a01 | antenna connector |

| Bandwidth kHz | Remarks |
|---------------|------------------|
| 281 | please see annex |

Remark: The given value is the result of the 26dB bandwidth measurement.
 The 99% Bandwidth is 238 kHz.

| Op. Mode | Setup | Port |
|-----------|-----------|-------------------|
| op-mode 5 | setup_a01 | antenna connector |

| Bandwidth kHz | Remarks |
|---------------|------------------|
| 283 | please see annex |

Remark: The given value is the result of the 26dB bandwidth measurement.



The 99% Bandwidth is 240.0 kHz.

| Op. Mode | Setup | Port |
|-----------------|--------------|-------------------|
| op-mode 6 | setup_a01 | antenna connector |

| Bandwidth kHz | Remarks |
|--------------------------|------------------|
| 279 | please see annex |

Remark: The given value is the result of the 26dB bandwidth measurement.
The 99% Bandwidth is 240 kHz.

3.5.4 Test result: Emission and Occupied Bandwidth

| FCC Part 22, Subpart H | Op. Mode | Result |
|-------------------------------|-----------------|---------------|
| | op-mode 1 | passed |
| | op-mode 2 | passed |
| | op-mode 3 | passed |
| | op-mode 4 | passed |
| | op-mode 5 | passed |
| | op-mode 6 | passed |



3.6 Mobile emissions in base frequency range

Standard FCC Part 22, 10-01-2004
Subpart H

The test was performed according to: FCC §22.917, 10-01-2004

3.6.1 Test Description

- 1) The EUT was coupled to the R&S CMU200 Digital Communications Tester via a 10 dB attenuator and a 6 dB coupler.
- 2) The 6 dB coupler is connected via a 10 dB attenuator, a notch filter and an amplifier to the R&S Spectrum Analyser.
- 3) A path calibration is done with the notch filter tuned to the tested TCH.
- 4) For the measurement the level of the CMU200 is set to -100 dB at the input of the EUT so it is hardly visible at the Spectrum Analyser.
- 5) The power level of the TCH signal generated by the EUT is set to minimum RF output power and will be blocked by the notch filter.
- 6) The spectrum analyser is set to a RBW/VBW of 200 kHz/200 kHz.
- 7) The EUT's receive band is from 869.2 MHz to 893.8 MHz. The analyser is set to a span from 865 MHz to 895 MHz.

3.6.2 Test Requirements / Limits

§ 22.917 Mobile emissions in base frequency range

The mean power of any emissions appearing in the base station frequency range from cellular mobile transmitters operated must be attenuated to a level not to exceed -80 dBm at the transmit antenna connector.

3.6.3 Test Protocol

Temperature: 23 °C
 Air Pressure: 1031 hPa
 Humidity: 39 %

| Op. Mode | Setup | Port |
|-----------|-----------|-------------------|
| op-mode 1 | setup_c01 | antenna connector |

| Frequency MHZ | Measured Level dBm | Limit dBm |
|---------------|--------------------|-----------|
| 890 | -81.03 | -80.0 |

Remark: No (further) spurious emissions were found.

| Op. Mode | Setup | Port |
|-----------|-----------|-------------------|
| op-mode 2 | setup_c01 | antenna connector |

| Frequency MHZ | Measured Level dBm | Limit dBm |
|---------------|--------------------|-----------|
| 881 | -81.42 | -80.0 |

Remark: No (further) spurious emissions were found.

| Op. Mode | Setup | Port |
|-----------|-----------|-------------------|
| op-mode 3 | setup_c01 | antenna connector |

| Frequency MHZ | Measured Level dBm | Limit dBm |
|---------------|--------------------|-----------|
| 893 | -81.82 | -80.0 |

Remark: No (further) spurious emissions were found.

| Op. Mode | Setup | Port |
|-----------|-----------|-------------------|
| op-mode 4 | setup_c01 | antenna connector |

| Frequency MHZ | Measured Level dBm | Limit dBm |
|---------------|--------------------|-----------|
| 869 | -83.16 | -80.0 |

Remark: No (further) spurious emissions were found.

| Op. Mode | Setup | Port |
|-----------|-----------|-------------------|
| op-mode 5 | setup_c01 | antenna connector |

| Frequency MHZ | Measured Level dBm | Limit dBm |
|---------------|--------------------|-----------|
| 881 | -81.42 | -80.0 |



Remark: No (further) spurious emissions were found.

| Op. Mode | Setup | Port |
|-----------------|--------------|-------------------|
| op-mode 6 | setup_c01 | antenna connector |

| Frequency MHZ | Measured Level dBm | Limit dBm |
|--------------------------|-------------------------------|----------------------|
| 893 | -80.31 | -80.0 |

Remark: No (further) spurious emissions were found.

3.6.4 Test result: Emission and Occupied Bandwidth

| FCC Part 22, Subpart H | Op. Mode | Result |
|-------------------------------|-----------------|---------------|
| | op-mode 1 | passed |
| | op-mode 2 | passed |
| | op-mode 3 | passed |
| | op-mode 4 | passed |
| | op-mode 5 | passed |
| | op-mode 6 | passed |

4 Test Equipment

EUT Digital Signalling System

| Equipment | Type | Serial No. | Manufacturer |
|--|-------------|-------------------|---------------------|
| Digital Radio Communication Tester | CMD 55 | 831050/020 | Rohde & Schwarz |
| Signalling Unit for Bluetooth Spurious Emissions | PTW60 | 100004 | Rohde & Schwarz |
| Universal Radio Communication Tester | CMU 200 | 102366 | Rohde & Schwarz |

EMI Test System

| Equipment | Type | Serial No. | Manufacturer |
|-----------------------------|-------------|-------------------|---------------------|
| Comparison Noise Emitter | CNE III | 99/016 | York |
| EMI Analyzer | ESI 26 | 830482/004 | Rohde & Schwarz |
| Signal Generator | SMR 20 | 846834/008 | Rohde & Schwarz |

EMI Radiated Auxiliary Equipment

| Equipment | Type | Serial No. | Manufacturer |
|------------------------------------|----------------------|---------------------|-----------------------|
| Antenna mast 4m | MA 240 | 240/492 | HD GmbH H. Deisel |
| Biconical dipole | VUBA 9117 | 9117108 | Schwarzbeck |
| Broadband Amplifier 18MHz-26GHz | JS4-18002600-32 | 849785 | Miteq |
| Broadband Amplifier 30MHz-18GHz | JS4-00101800-35 | 896037 | Miteq |
| Broadband Amplifier 45MHz-27GHz | JS4-00102600-42 | 619368 | Miteq |
| Cable "ESI to EMI Antenna" | EcoFlex10 | W18.01-2 + W38.01-2 | Kabel Kusch |
| Cable "ESI to Horn Antenna" | UFB311A + UFB293C | W18.02-2 + W38.02-2 | Rosenberger-Microcoax |
| Double-ridged horn | HF 906 | 357357/002 | Rohde & Schwarz |
| Double-ridged horn | HF 906 | 357357/001 | Rohde & Schwarz |
| High Pass Filter | 5HC3500/12750-1.2-KK | 200035008 | Trilithic |
| High Pass Filter | 5HC2700/12750-1.5-KK | 9942012 | Trilithic |
| High Pass Filter | 4HC1600/12750-1.5-KK | 9942011 | Trilithic |
| KUEP pre amplifier | Kuep 00304000 | 001 | 7layers |
| Log.-per. Antenna | HL 562 Ultralog | 830547/003 | Rohde & Schwarz |
| Loop Antenna | HFH2-Z2 | 829324/006 | Rohde & Schwarz |
| Pyramidal Horn Antenna 26.5 GHz | Model 3160-09 | 9910-1184 | EMCO |

EMI Conducted Auxiliary Equipment

| Equipment | Type | Serial No. | Manufacturer |
|---------------------|----------|---------------|-----------------|
| Cable "LISN to ESI" | RG214 | W18.03+W48.03 | Huber+Suhner |
| Two-Line V-Network | ESH 3-Z5 | 828304/029 | Rohde & Schwarz |
| Two-Line V-Network | ESH 3-Z5 | 829996/002 | Rohde & Schwarz |

Auxiliary Test Equipment

| Equipment | Type | Serial No. | Manufacturer |
|--|----------------------|----------------|--------------------------------------|
| Broadband Resist. Power Divider N | 1506A / 93459 | LM390 | Weinschel |
| Broadband Resist. Power Divider SMA | 1515 / 93459 | LN673 | Weinschel |
| Digital Multimeter 01 | Voltcraft M-3860M | IJ096055 | Conrad |
| Digital Multimeter 02 | Voltcraft M-3860M | IJ095955 | Conrad |
| Digital Oscilloscope | TDS 784C | B021311 | Tektronix |
| Fibre optic link Satellite | FO RS232 Link | 181-018 | Pontis |
| Fibre optic link Transceiver | FO RS232 Link | 182-018 | Pontis |
| I/Q Modulation Generator | AMIQ-B1 | 832085/018 | Rohde & Schwarz |
| Notch Filter ultra stable | WRCA800/960-6E | 24 | Wainwright |
| Spectrum Analyzer 9 kHz to 3 GHz | FSP3 | 838164/004 | Rohde & Schwarz |
| Temperature Chamber | VT 4002 | 58566002150010 | Vötsch |
| Temperature Chamber | KWP 120/70 | 59226012190010 | Weiss |
| ThermoHygro Datalogger 03 | Opus10 THI (8152.00) | 7482 | Lufft Mess- und Regeltechnik GmbH |

Anechoic Chamber

| Equipment | Type | Serial No. | Manufacturer |
|--------------------------------------|----------------|------------|--------------------|
| Air Compressor (pneumatic) | | | Atlas Copco |
| Controller | HD 100 | 100/603 | HD GmbH H. Deisel |
| EMC Camera | CE-CAM/1 | | CE-SYS |
| EMC Camera for observation of EUT | CCD-400E | 0005033 | Mitsubishi |
| Filter ISDN | B84312-C110-E1 | | Siemens&Matsushita |
| Filter telephone systems / modem | B84312-C40-B1 | | Siemens&Matsushita |
| Filter Universal 1A | B84312-C30-H3 | | Siemens&Matsushita |
| Fully/Semi AE Chamber | 10.58x6.38x6 | | Frankonia |
| Turntable | DS 420S | 420/573/99 | HD GmbH, H. Deisel |
| Valve Control Unit (pneum.) | VE 615P | 615/348/99 | HD GmbH, H. Deisel |



7 layers Bluetooth™ Full RF Test Solution

Bluetooth RF Conformance Test System TS8960

| Equipment | Type | Serial No. | Manufacturer |
|---|------------------|-------------------|---------------------|
| 10 MHz Reference | MFS | 5489/001 | Efratom |
| Power Meter 832025/059 | NRVD | 832025/059 | Rohde & Schwarz |
| Power Sensor A 832279/013 | NRV-Z1 | 832279/013 | Rohde & Schwarz |
| Power Sensor B 832279/015 | NRV-Z1 | 832279/015 | Rohde & Schwarz |
| Power Supply | E3632A | MY40003776 | Agilent |
| Power Supply | PS-2403D | - | Conrad |
| RF Step Attenuator 833695/001 | RSP | 833695/001 | Rohde & Schwarz |
| Rubidium Frequency Normal | MFS | 002 | Efratom |
| Signal Analyzer FSIQ26 832695/007 | FSIQ26 | 832695/007 | Rohde & Schwarz |
| Signal Generator 833680/003 | SMP 03 | 833680/003 | Rohde & Schwarz |
| Signal Generator A 834344/002 | SMIQ03B | 834344/002 | Rohde & Schwarz |
| Signal Generator B 832870/017 | SMIQ03B | 832870/017 | Rohde & Schwarz |
| Signal Switching and Conditioning Unit | SSCU | 338826/005 | Rohde & Schwarz |
| Signalling Unit PTW60 838312/014 | PTW60 for TS8960 | 838312/014 | Rohde & Schwarz |
| System Controller 829323/008 | PSM12 | 829323/008 | Rohde & Schwarz |

5 Photo Report

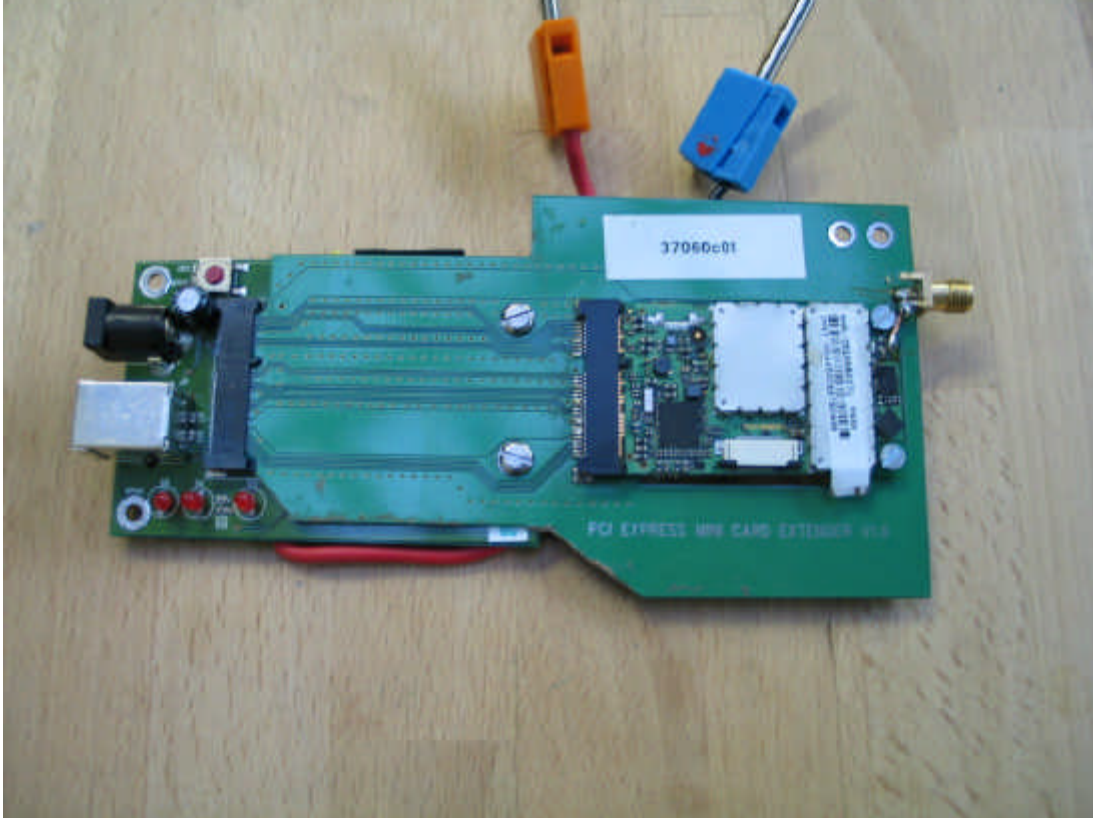

Photo 1: EUT in a cradle (top side)

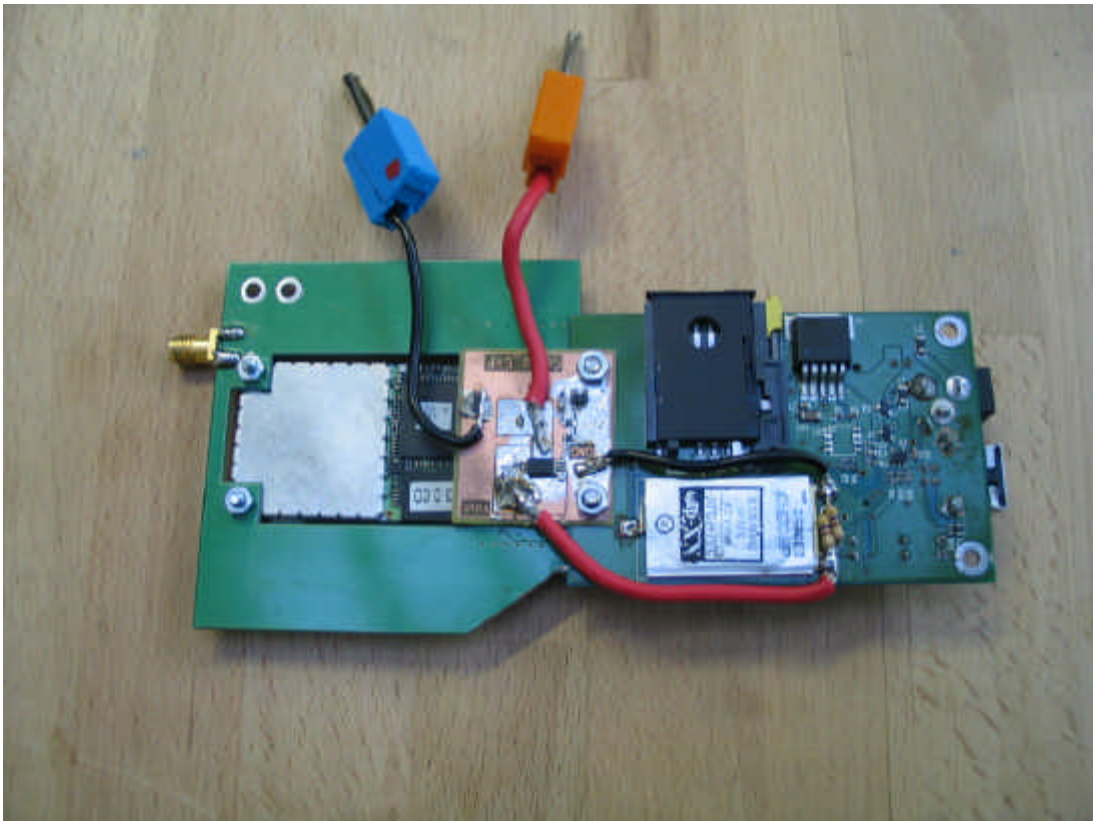

Photo 2: EUT in a cradle (bottom side)

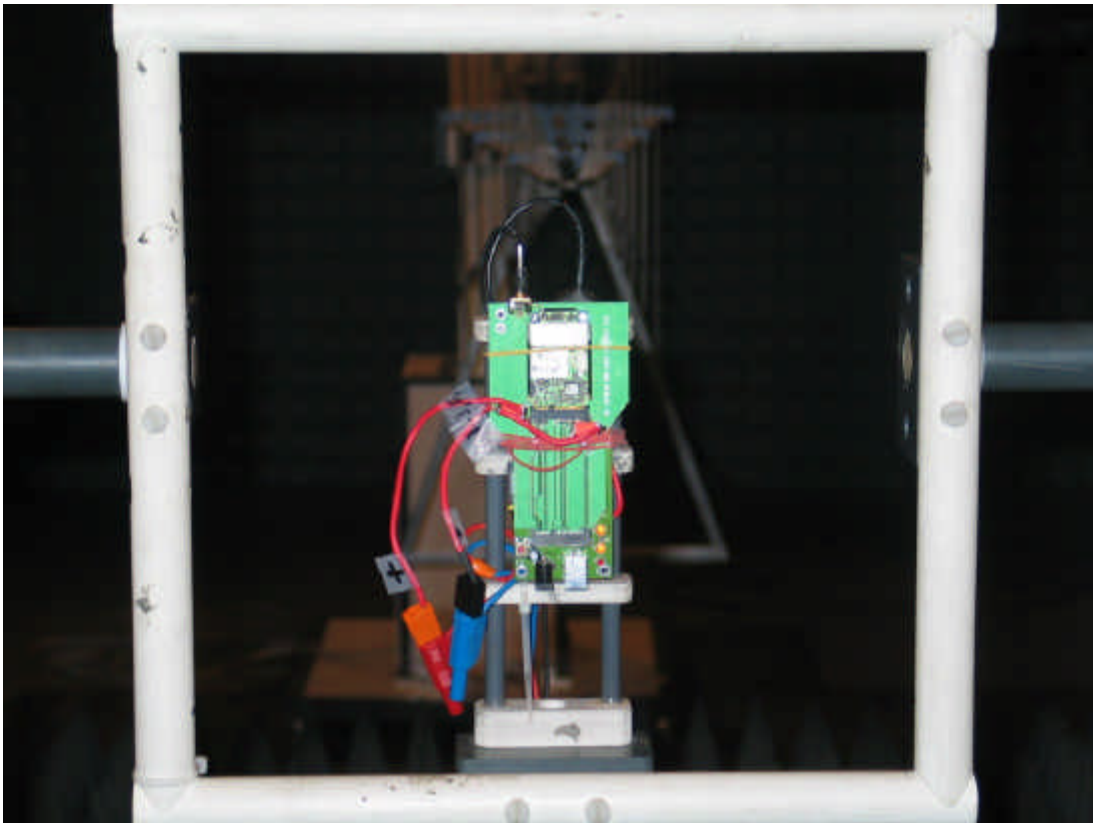
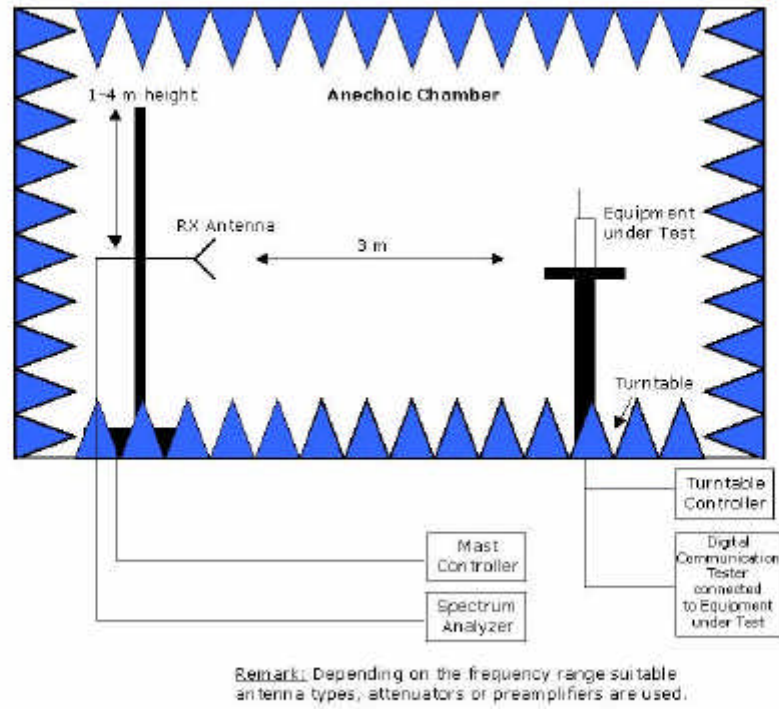

Photo 3: Setup for radiated tests

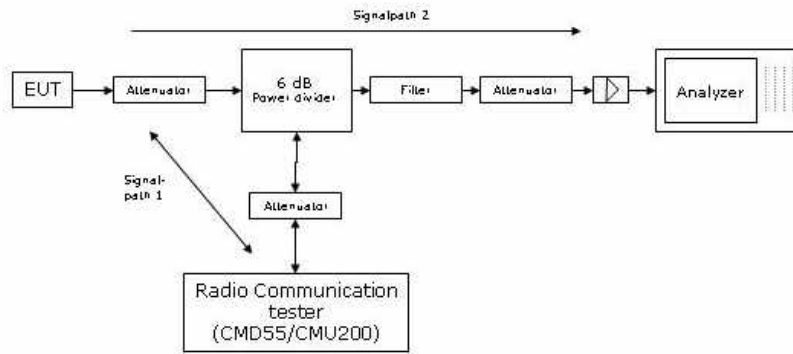

Photo 4: External antenna

6 Setup Drawings



Drawing 1: Principle setup for radiated measurements.



Remark: Depending on the frequency range suitable attenuators and/or filters and/or amplifiers are used.

Drawing 2: Principle setup for conducted measurements under nominal conditions

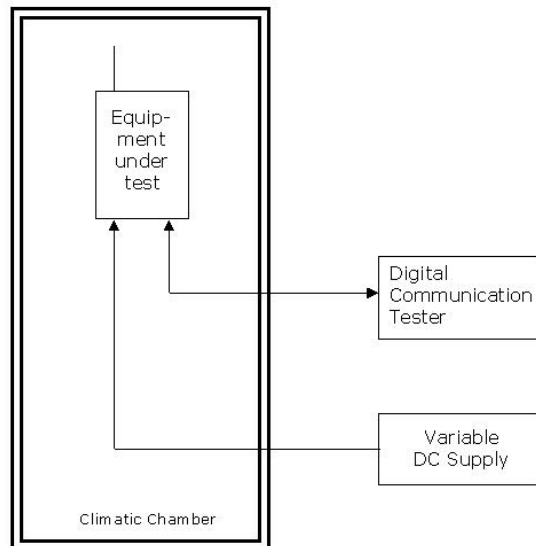

Drawing 3: Principle setup for tests under extreme test conditions

7 Annex

Measurement plots Emission and Occupied Bandwidth

Op. Mode

op-mode 1

| | | | | | |
|---|--------------|-----------------|-------|--------|-------|
|  | Delta 2 [T1] | RBW | 3 kHz | RF Att | 30 dB |
| | Ref Lvl | -24.56 dB | VBW | 10 kHz | |
| | 37 dBm | 86.17234469 kHz | SWT | 280 ms | Unit |

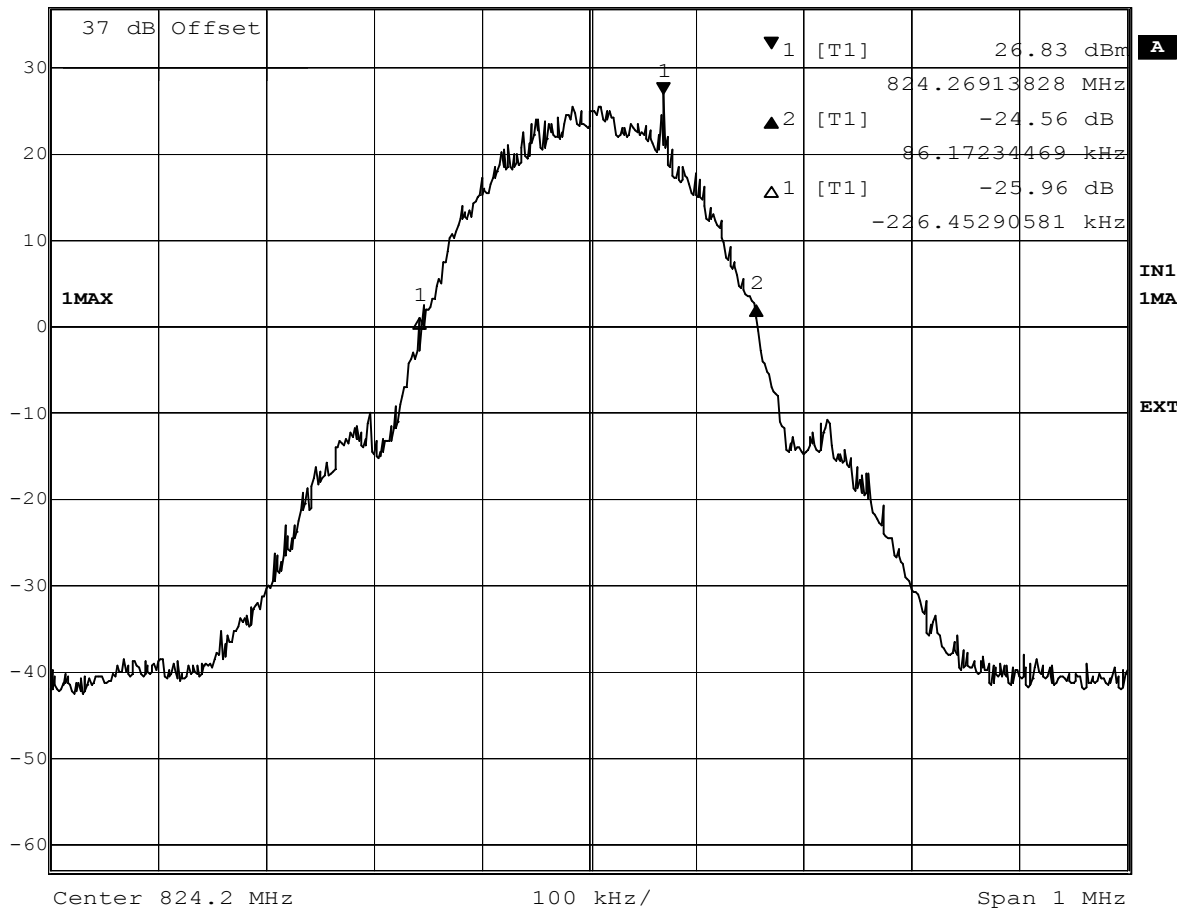

Date: 31.OCT.2005 14:48:07

Test: Emissions bandwidth (26 dB bandwidth), Channel 128 (824.2 MHz)

Op. Mode

op-mode 1

| | | | | | |
|----|---------------|------------------|-------|--------|----------|
| RS | Marker 1 [T1] | RBW | 3 kHz | RF Att | 30 dB |
| | Ref Lvl | 26.83 dBm | VBW | 10 kHz | |
| | 37 dBm | 824.26913828 MHz | SWT | 280 ms | Unit dBm |

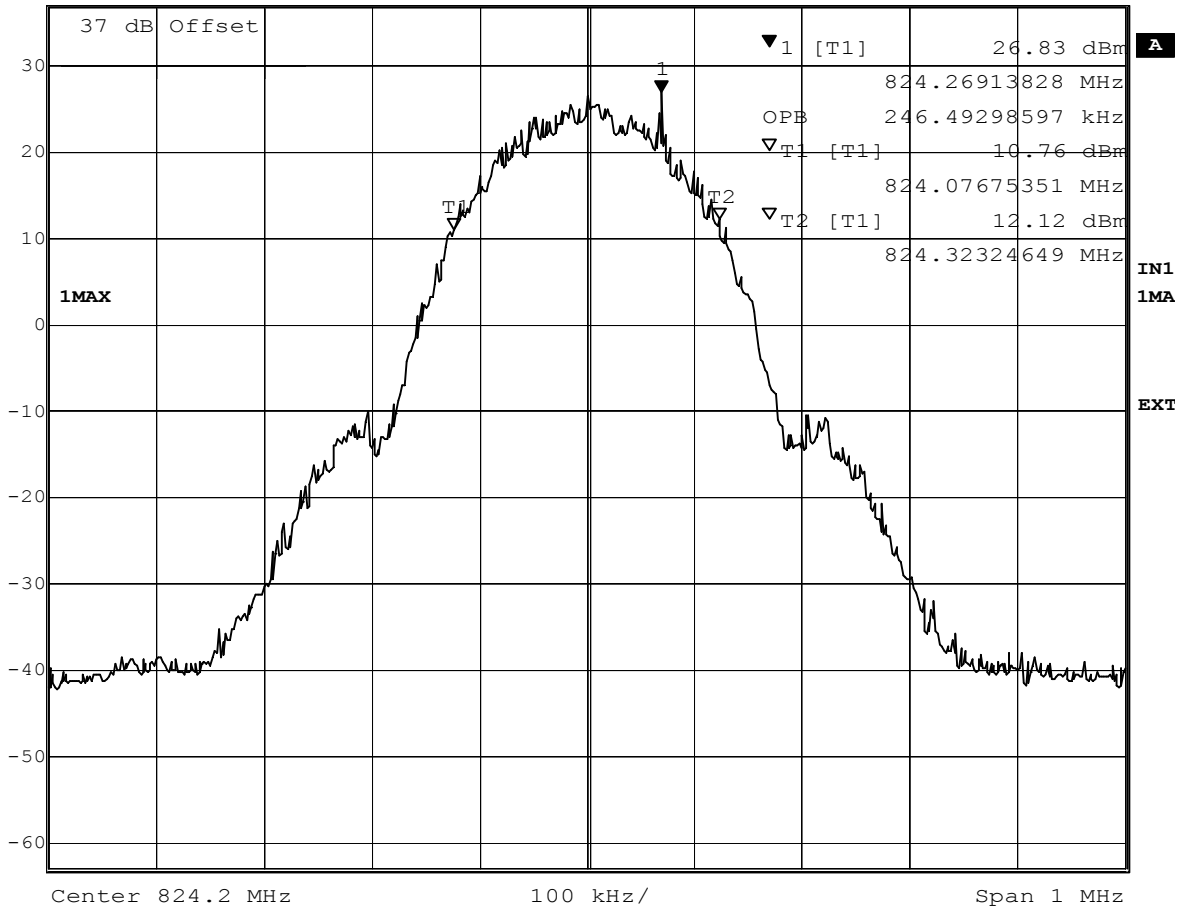

Date: 31.OCT.2005 14:48:37

Test: Occupied bandwidth, Channel 128 (824.2 MHz)

Op. Mode

op-mode 2



| | | | | |
|---------------|------------------|-------|--------|----------|
| Marker 1 [T1] | RBW | 3 kHz | RF Att | 30 dB |
| Ref Lvl | 26.31 dBm | VBW | 10 kHz | |
| 37 dBm | 836.66713427 MHz | SWT | 280 ms | Unit dBm |

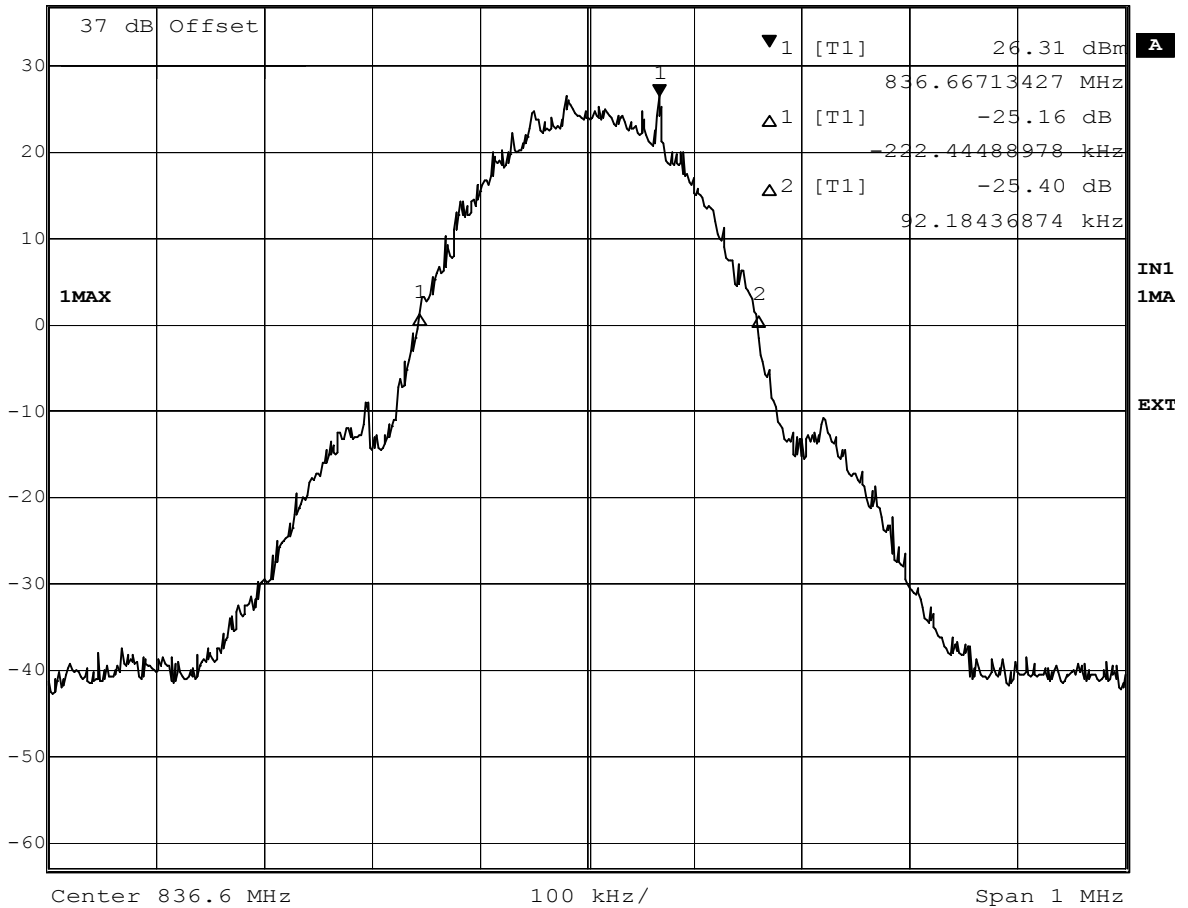

Date: 31.OCT.2005 14:51:17

Test: Emissions bandwidth (26 dB bandwidth), Channel 190 (836.6 MHz)



Op. Mode

op-mode 2

| | | | | | |
|----|---------------|------------------|-------|--------|----------|
| RS | Marker 1 [T1] | RBW | 3 kHz | RF Att | 30 dB |
| | Ref Lvl | 26.31 dBm | VBW | 10 kHz | |
| | 37 dBm | 836.66713427 MHz | SWT | 280 ms | Unit dBm |

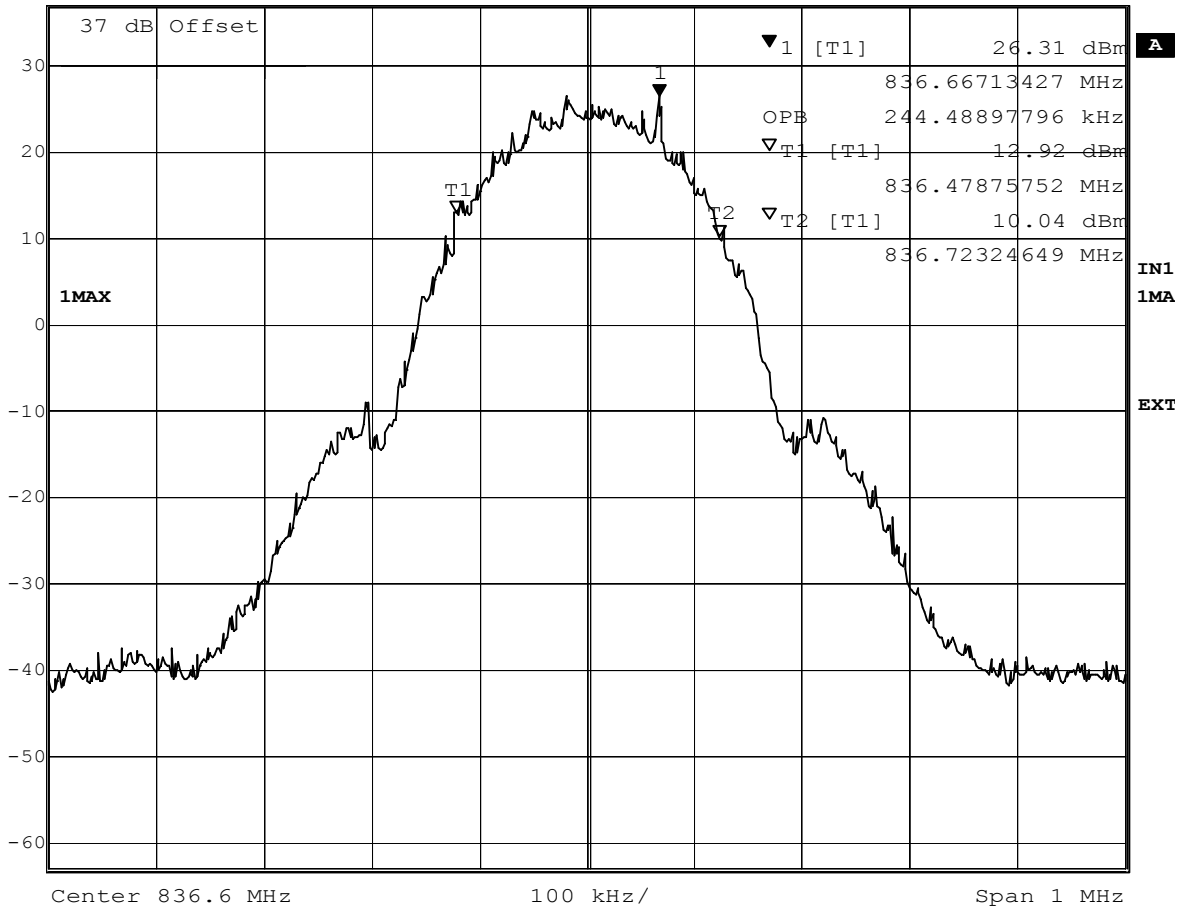

Date: 31.OCT.2005 14:51:48

Test: Occupied bandwidth, Channel 190 (836.6 MHz)

Op. Mode

op-mode 3



| | | | | | |
|---------|------------------|-----|--------|--------|-------|
| Ref Lvl | Marker 1 [T1] | RBW | 3 kHz | RF Att | 30 dB |
| 37 dBm | 27.35 dBm | VBW | 10 kHz | | |
| | 848.86913828 MHz | SWT | 280 ms | Unit | dBm |

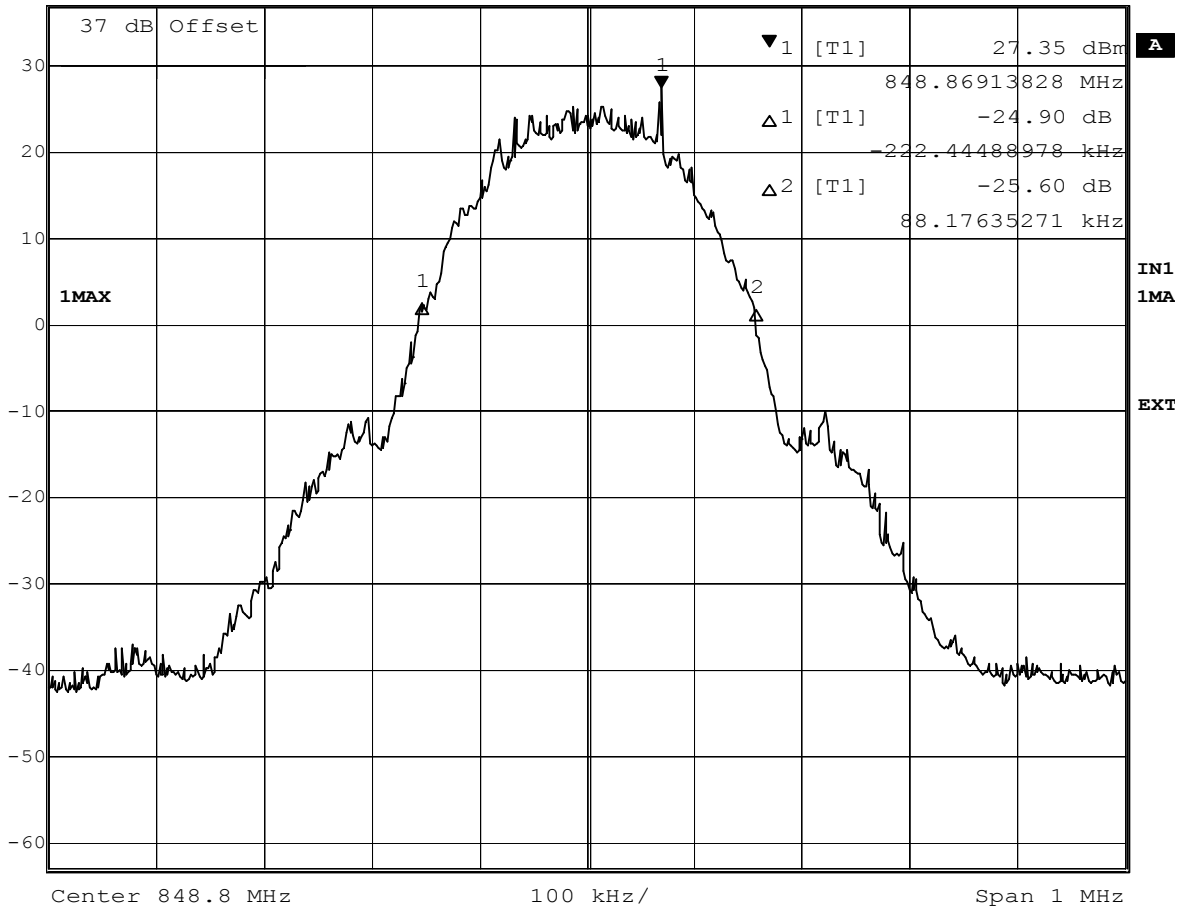

Date: 31.OCT.2005 14:54:07

Test: Emissions bandwidth (26 dB bandwidth), Channel 251 (848.8 MHz)

Op. Mode

op-mode 3

| | | | | | |
|----|---------------|------------------|-------|--------|----------|
| RS | Marker 1 [T1] | RBW | 3 kHz | RF Att | 30 dB |
| | Ref Lvl | 27.35 dBm | VBW | 10 kHz | |
| | 37 dBm | 848.86913828 MHz | SWT | 280 ms | Unit dBm |

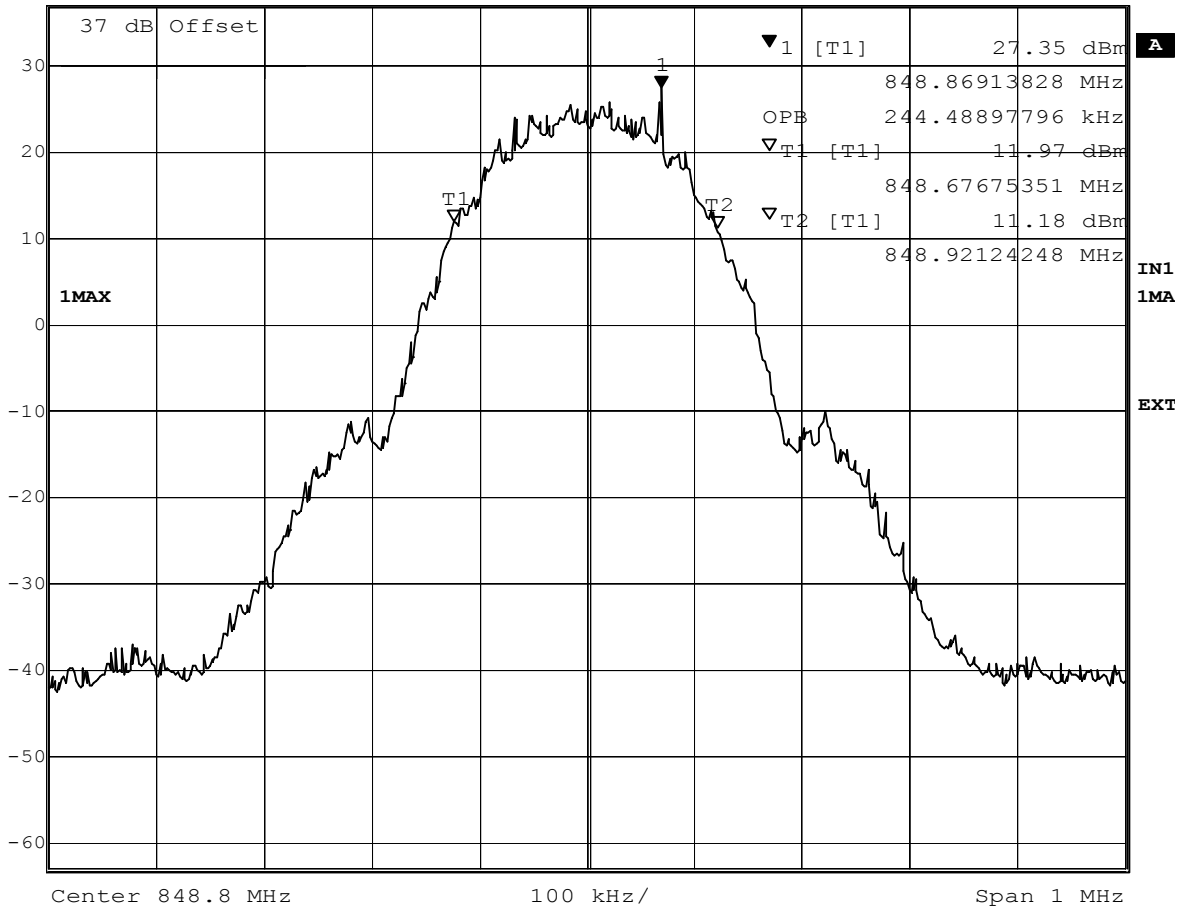

Date: 31.OCT.2005 14:54:34

Test: Occupied bandwidth, Channel 251 (848.8 MHz)



Op. Mode

op-mode 4

| | | | | | |
|----|--------------|-------------------|-------|--------|----------|
| RS | Delta 1 [T1] | RBW | 3 kHz | RF Att | 30 dB |
| | Ref Lvl | -24.61 dB | VBW | 10 kHz | |
| | 37 dBm | -138.27655311 kHz | SWT | 280 ms | Unit dBm |

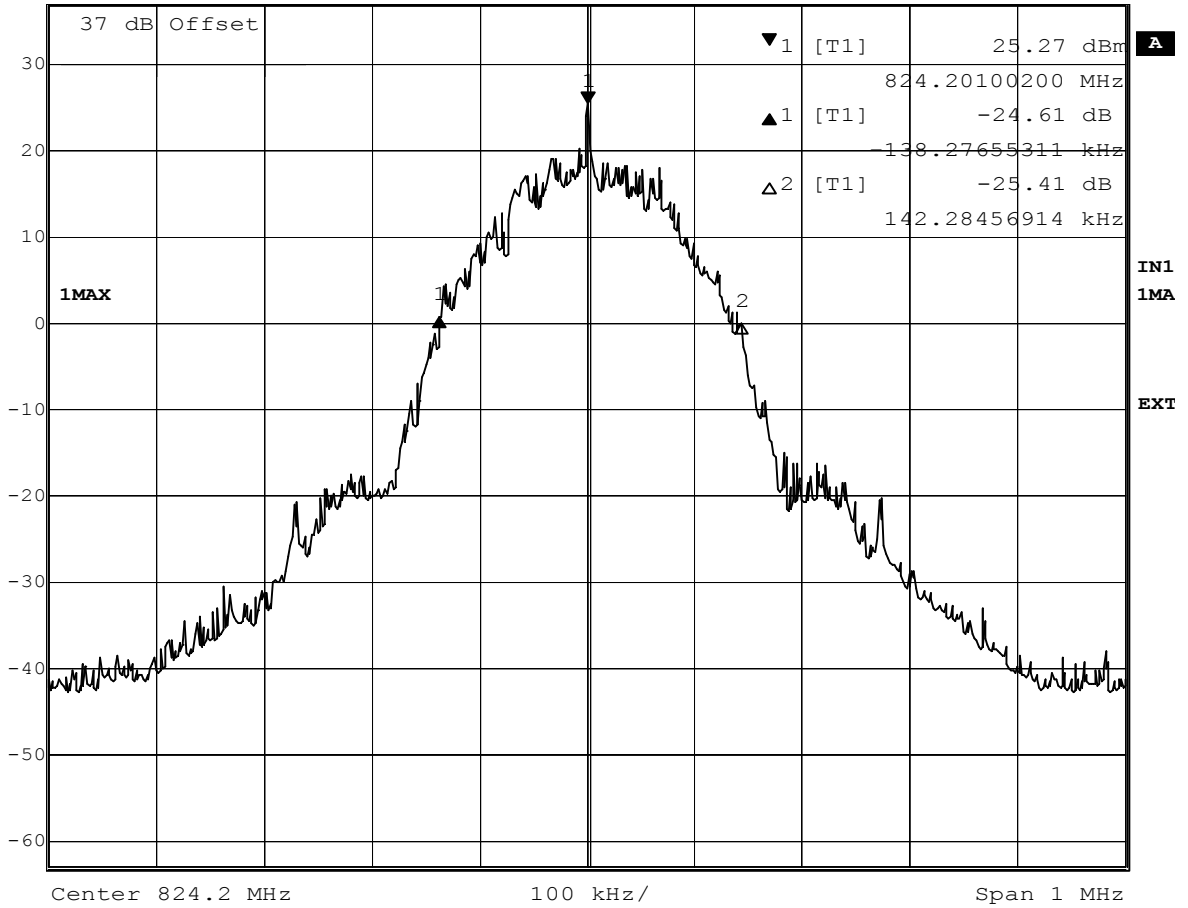

Date: 31.OCT.2005 15:03:58

Test: Emissions bandwidth (26 dB bandwidth), Channel 128 (824.2 MHz)

Op. Mode

op-mode 4

| | | | | | |
|----|---------------|------------------|-------|--------|----------|
| RS | Marker 1 [T1] | RBW | 3 kHz | RF Att | 30 dB |
| | Ref Lvl | 25.27 dBm | VBW | 10 kHz | |
| | 37 dBm | 824.20100200 MHz | SWT | 280 ms | Unit dBm |

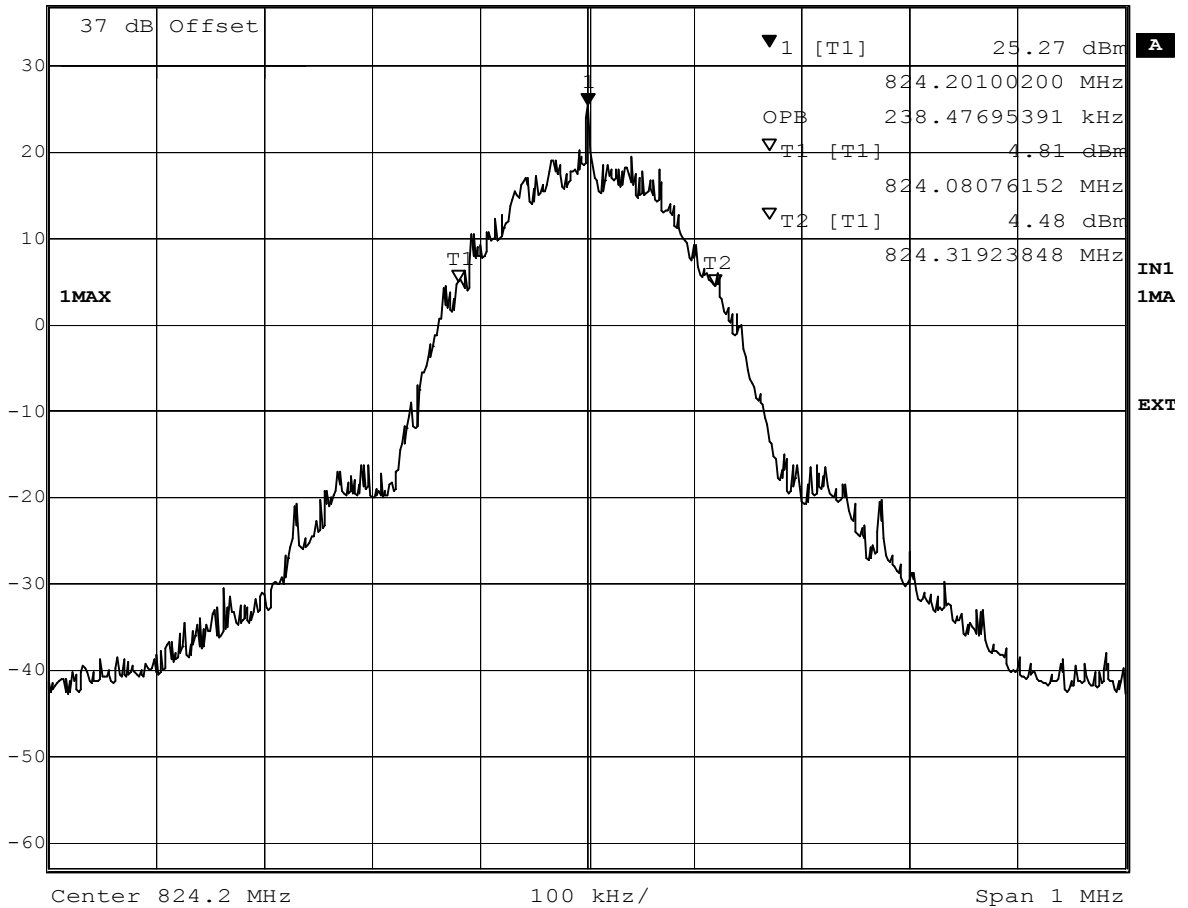

Date: 31.OCT.2005 15:04:31

Test: Occupied bandwidth, Channel 128 (824.2 MHz)

Op. Mode

op-mode 5

| | | | | | |
|----|--------------|------------------|-------|--------|----------|
| RS | Delta 2 [T1] | RBW | 3 kHz | RF Att | 30 dB |
| | Ref Lvl | -24.96 dB | VBW | 10 kHz | |
| | 37 dBm | 144.28857715 kHz | SWT | 280 ms | Unit dBm |

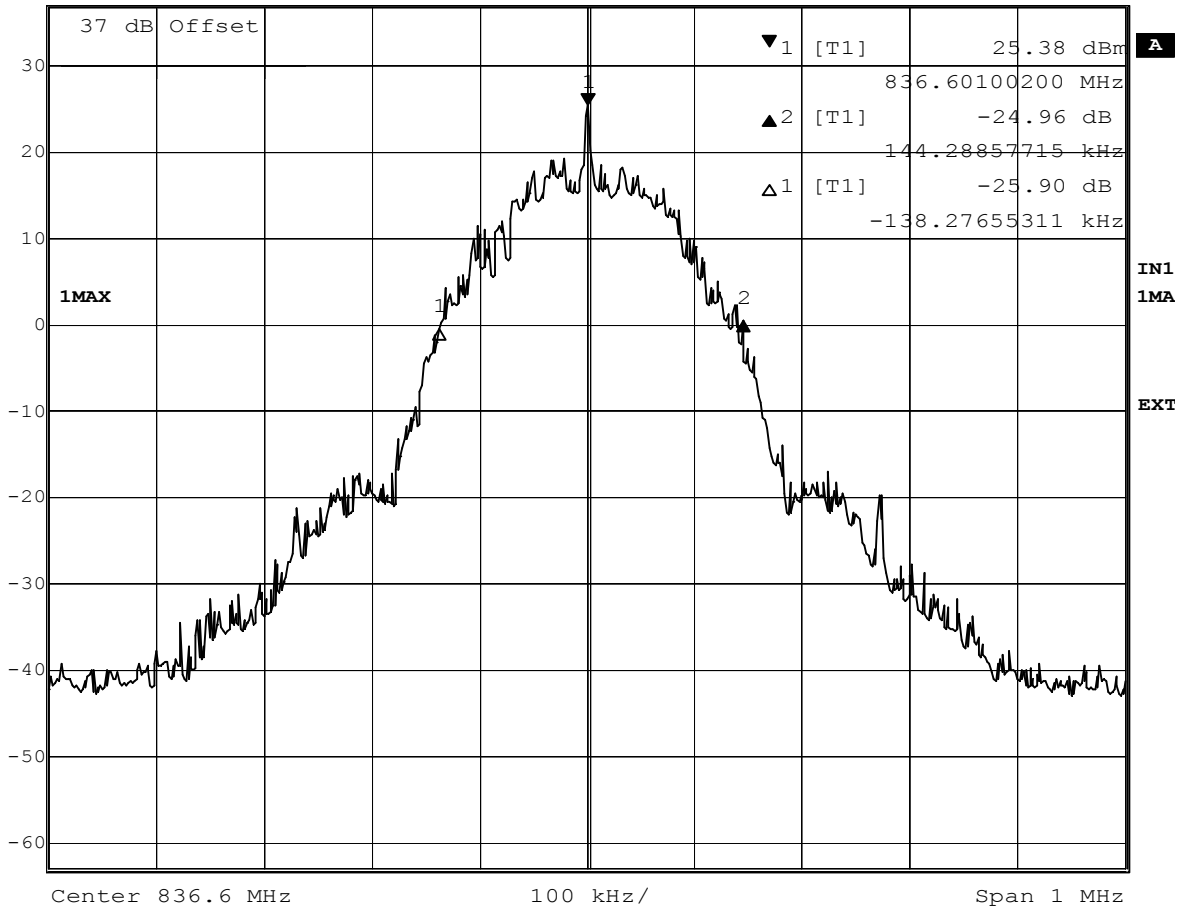

Date: 31.OCT.2005 15:01:58

Test: Emissions bandwidth (26 dB bandwidth), Channel 190 (836.6 MHz)

Op. Mode

op-mode 5

| | | | | | |
|----|---------------|------------------|-------|--------|----------|
| RS | Marker 1 [T1] | RBW | 3 kHz | RF Att | 30 dB |
| | Ref Lvl | 25.38 dBm | VBW | 10 kHz | |
| | 37 dBm | 836.60100200 MHz | SWT | 280 ms | Unit dBm |

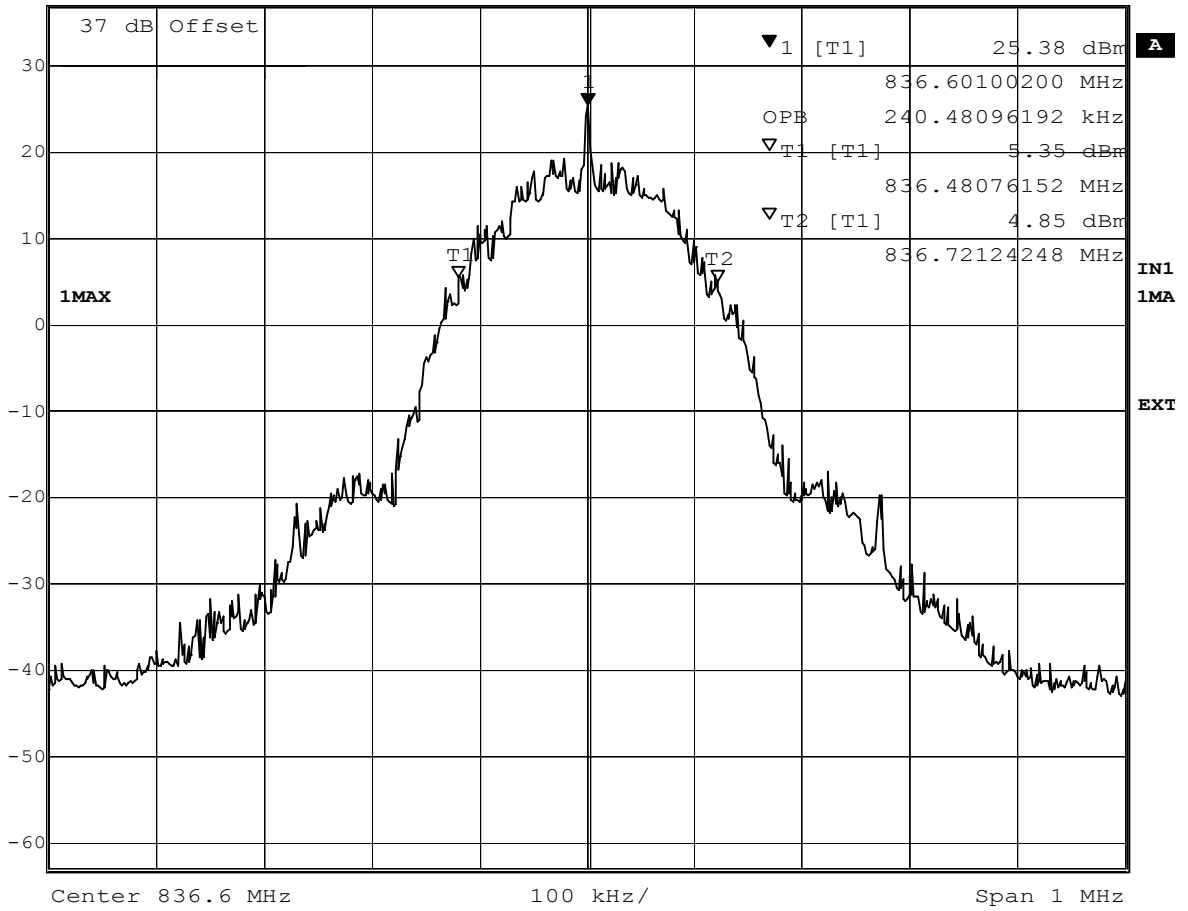

Date: 31.OCT.2005 15:02:19

Test: Occupied bandwidth, Channel 190 (836.6 MHz)

Op. Mode

op-mode 6

| | | | | | |
|---------|------------------|-----|--------|--------|-------|
| | Delta 2 [T1] | RBW | 3 kHz | RF Att | 30 dB |
| Ref Lvl | -23.13 dB | VBW | 10 kHz | | |
| 37 dBm | 138.27655311 kHz | SWT | 280 ms | Unit | dBm |

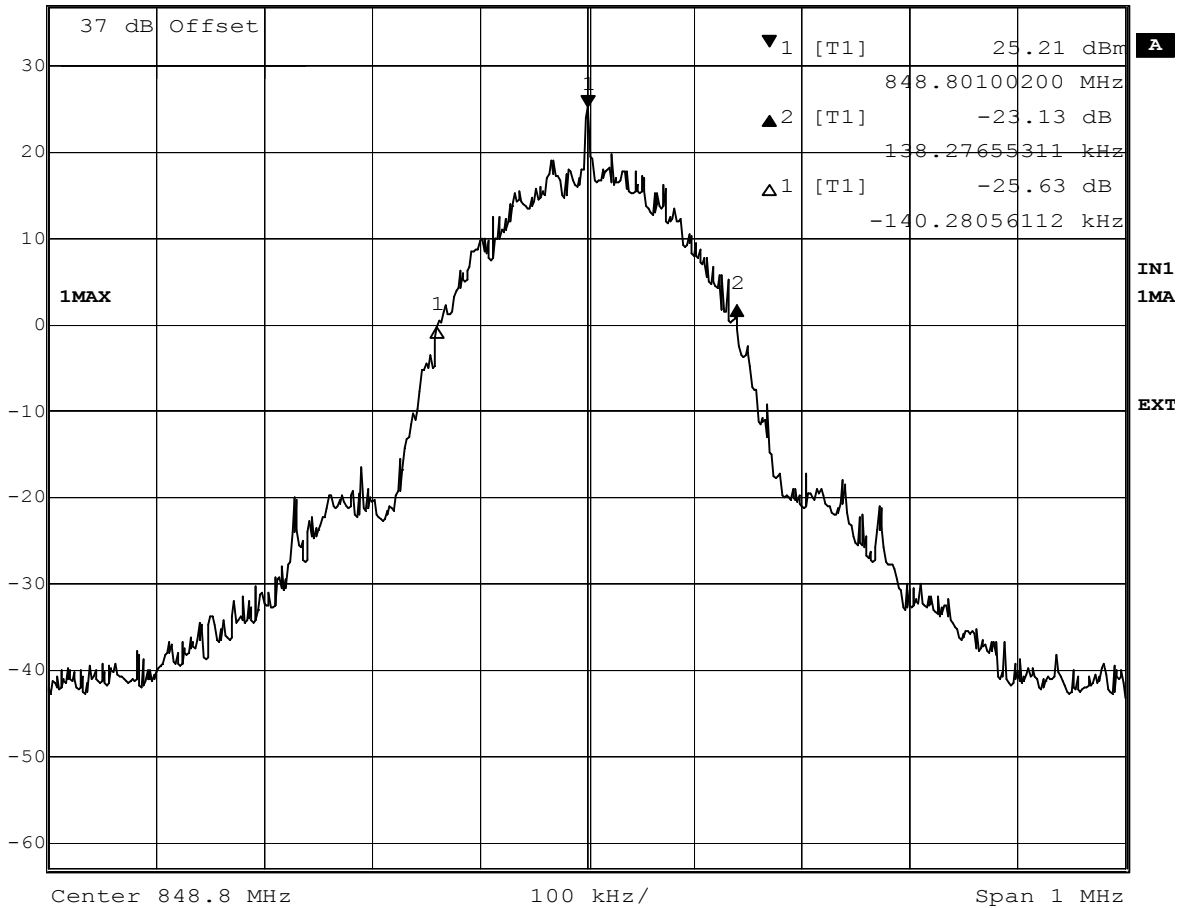

Date: 31.OCT.2005 15:06:53

Test: Emissions bandwidth (26 dB bandwidth), Channel 251 (848.8 MHz)

Op. Mode

op-mode 6

| | | | | | |
|----|---------------|------------------|-------|--------|----------|
| RS | Marker 1 [T1] | RBW | 3 kHz | RF Att | 30 dB |
| | Ref Lvl | 25.24 dBm | VBW | 10 kHz | |
| | 37 dBm | 848.80100200 MHz | SWT | 280 ms | Unit dBm |

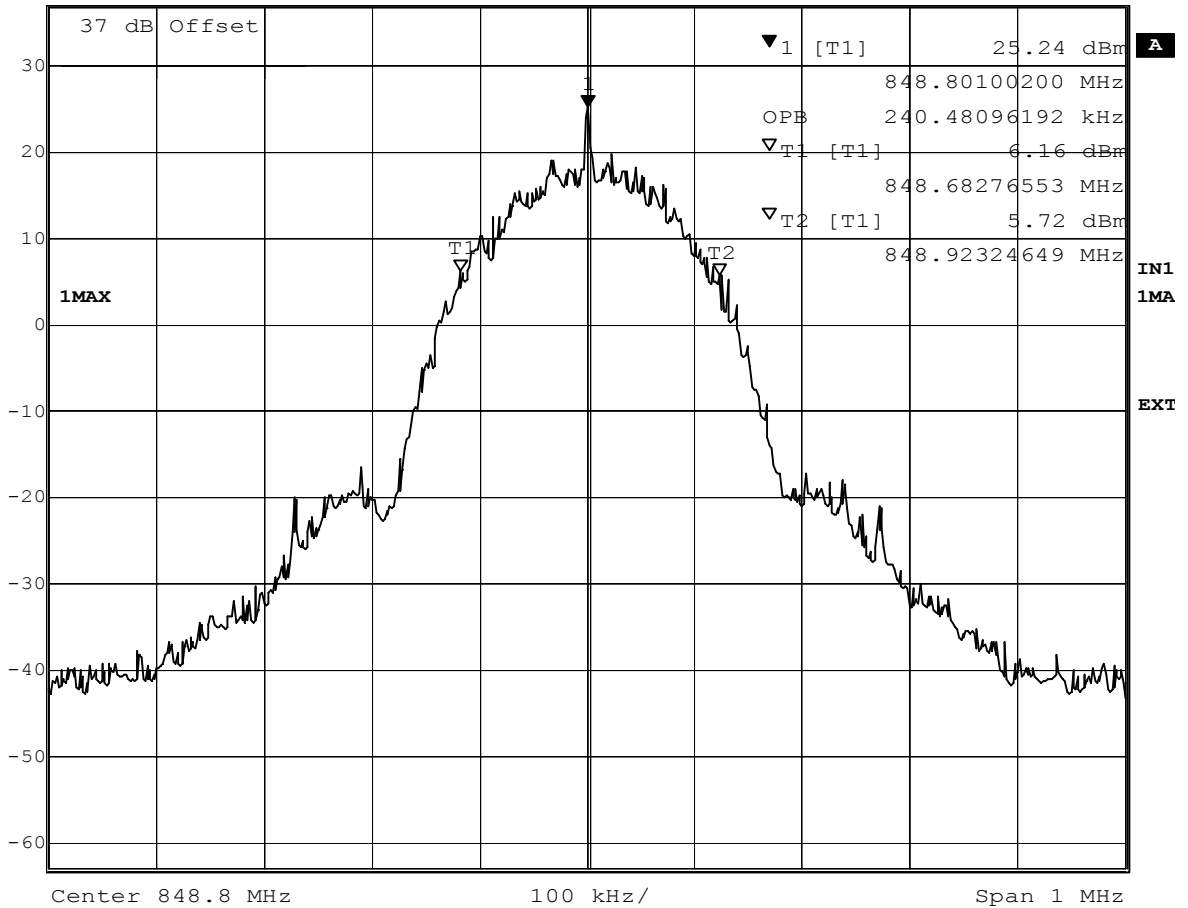

Date: 31.OCT.2005 15:07:13

Test: Occupied bandwidth, Channel 251 (848.8 MHz)