



Inter**Lab**<sup>®</sup>

# FCC Measurement/Technical Report on GSM/UMTS Module MO0402

**Report Reference:** MDE\_Opti\_0811\_FCCa

**Test Laboratory:**

7 layers AG  
Borsigstrasse 11  
40880 Ratingen  
Germany  
email: [info@7Layers.de](mailto:info@7Layers.de)



**Note:**

The following test results relate only to the devices specified in this document. This report shall not be reproduced in parts without the written approval of the testing laboratory.

7 layers AG  
Borsigstrasse 11  
40880 Ratingen, Germany  
Phone: +49 (0) 2102 749 0  
Fax: +49 (0) 2102 749 350  
[www.7Layers.com](http://www.7Layers.com)

*Aufsichtsratsvorsitzender •  
Chairman of the Supervisory Board:  
Markus Becker  
Vorstand • Board:  
Dr. Hans-Jürgen Meckelburg  
René Schildknecht*

*Registergericht • registered in:  
Düsseldorf, HRB 44096  
USt-IdNr • VAT Nr:  
DE 203159652  
TAX No. 147/5869/0385*



## Table of Contents

<b>0</b>	<b>Summary</b>	<b>3</b>
0.1	Technical Report Summary	3
0.2	Measurement Summary	4
<b>1</b>	<b>Administrative Data</b>	<b>4</b>
1.1	Testing Laboratory	6
1.2	Project Data	6
1.3	Applicant Data	6
1.4	Manufacturer Data	6
<b>2</b>	<b>Testobject Data</b>	<b>7</b>
2.1	General EUT Description	7
2.2	EUT Main components	7
2.3	Ancillary Equipment	8
2.4	EUT Setups	8
2.5	Operating Modes	9
<b>3</b>	<b>Test Results</b>	<b>7</b>
3.1	RF Power Output	11
3.2	Frequency stability	15
3.3	Spurious emissions at antenna terminals	20
3.4	Field strength of spurious radiation	25
3.5	Emission and Occupied Bandwidth	30
3.6	Band edge compliance	34
<b>4</b>	<b>Test Equipment</b>	<b>37</b>
<b>5</b>	<b>Photo Report</b>	<b>40</b>
<b>6</b>	<b>Setup Drawings</b>	<b>44</b>
<b>7</b>	<b>Annex</b>	<b>46</b>
	Measurement Plots	



## **0 Summary**

### **0.1 Technical Report Summary**

#### **Type of Authorization**

Certification for a GSM cellular radiotelephone device

#### **Applicable FCC Rules**

Prepared in accordance with the requirements of FCC Rules and Regulations as listed in 47 CFR Ch.1 Parts 0 to 19 and Parts 20 to 69 (10-1-07 Edition). The following subparts are applicable to the results in this test report.

Part 2

Subpart J - Equipment Authorization Procedures, Certification

§ 2.1046 Measurement required: RF power output

§ 2.1049 Measurement required: Occupied bandwidth

§ 2.1051 Measurement required: Spurious emissions at antenna terminals

§ 2.1053 Measurement required: Field strength of spurious radiation

§ 2.1055 Measurement required: Frequency stability

§ 2.1057 Frequency spectrum to be investigated

Part 22

Subpart C – Operational and Technical Requirements

§ 22.355 Frequency tolerance

Subpart H – Cellular Radiotelephone Service

§ 22.913 Effective radiated power limits

§ 22.917 Emission limitations for cellular equipment

#### **Summary Test**

**The EUT complied with all performed tests as listed in chapter 0.2 Measurement Summary.**



## 0.2 Measurement Summary

---

### RF Power Output

The measurement was performed according to FCC §2.1046 10-1-07

<b>OP-Mode</b>	<b>Setup</b>	<b>Port</b>	<b>Final Result</b>
op-mode 1	Setup_e03	antenna connector	passed
op-mode 2	Setup_e03	antenna connector	passed
op-mode 3	Setup_e03	antenna connector	passed
op-mode 4	Setup_e03	antenna connector	passed
op-mode 5	Setup_e03	antenna connector	passed
op-mode 6	Setup_e03	antenna connector	passed
op-mode 7	Setup_d01	antenna connector	passed
op-mode 8	Setup_d01	antenna connector	passed
op-mode 9	Setup_d01	antenna connector	passed
op-mode 10	Setup_d02	antenna connector	passed
op-mode 11	Setup_d02	antenna connector	passed
op-mode 12	Setup_d02	antenna connector	passed
op-mode 13	Setup_d02	antenna connector	passed
op-mode 14	Setup_d02	antenna connector	passed
op-mode 15	Setup_d02	antenna connector	passed

---

### Frequency stability

The measurement was performed according to FCC §2.1055 10-1-07

<b>OP-Mode</b>	<b>Setup</b>	<b>Port</b>	<b>Final Result</b>
op-mode 2	Setup_b01	antenna connector	passed
op-mode 5	Setup_b01	antenna connector	passed
op-mode 8	Setup_b01	antenna connector	passed

---

### Spurious emissions at antenna terminals

The measurement was performed according to FCC §2.1051 10-1-07

<b>OP-Mode</b>	<b>Setup</b>	<b>Port</b>	<b>Final Result</b>
op-mode 1	Setup_d01	antenna connector	passed
op-mode 2	Setup_d01	antenna connector	passed
op-mode 3	Setup_d01	antenna connector	passed
op-mode 4	Setup_d01	antenna connector	passed
op-mode 5	Setup_d01	antenna connector	passed
op-mode 6	Setup_d01	antenna connector	passed
op-mode 7	Setup_d01	antenna connector	passed
op-mode 8	Setup_d01	antenna connector	passed
op-mode 9	Setup_d01	antenna connector	passed

---

### Field strength of spurious radiation

The measurement was performed according to FCC §2.1053 10-1-07

<b>OP-Mode</b>	<b>Setup</b>	<b>Port</b>	<b>Final Result</b>
op-mode 1	Setup_e03	enclosure	passed
op-mode 2	Setup_e03	enclosure	passed
op-mode 3	Setup_e03	enclosure	passed
op-mode 4	Setup_e03	enclosure	passed
op-mode 5	Setup_e03	enclosure	passed
op-mode 6	Setup_e03	enclosure	passed
op-mode 7	Setup_c01	enclosure	passed
op-mode 8	Setup_c01	enclosure	passed
op-mode 9	Setup_c01	enclosure	passed

**Emission and Occupied Bandwidth**

The measurement was performed according to FCC §2.1049 10-1-07

OP-Mode	Setup	Port	Final Result
op-mode 1	Setup_d01	antenna connector	passed
op-mode 2	Setup_d01	antenna connector	passed
op-mode 3	Setup_d01	antenna connector	passed
op-mode 4	Setup_d01	antenna connector	passed
op-mode 5	Setup_d01	antenna connector	passed
op-mode 6	Setup_d01	antenna connector	passed
op-mode 7	Setup_d01	antenna connector	passed
op-mode 8	Setup_d01	antenna connector	passed
op-mode 9	Setup_d01	antenna connector	passed

**Band edge compliance**

The measurement was performed according to FCC §2.1053 10-1-07

OP-Mode	Setup	Port	Final Result
op-mode 1	Setup_e03	antenna connector	passed
op-mode 3	Setup_e03	antenna connector	passed
op-mode 4	Setup_e03	antenna connector	passed
op-mode 6	Setup_e03	antenna connector	passed
op-mode 7	Setup_d01	antenna connector	passed
op-mode 9	Setup_d01	antenna connector	passed



7 layers AG, Borsigstr. 11  
 40880 Ratingen, Germany  
 ☎ +49 (0)2102 749 0

Responsible for Accreditation Scope:

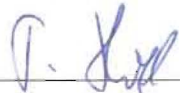

Responsible for Test Report:

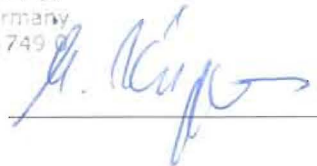



## **1 Administrative Data**

### **1.1 Testing Laboratory**

Company Name: 7 layers AG  
Address Borsigstr. 11  
40880 Ratingen  
Germany

This facility has been fully described in a report submitted to the FCC and accepted under the registration number 96716 .

The test facility is also accredited by the following accreditation organisation:  
- Deutscher Akkreditierungs Rat DAR-Registration no. DAT-P-192/99-01

Responsible for Accreditation Scope: Dipl.-Ing. Bernhard Retka  
Dipl.-Ing. Robert Machulec  
Dipl.-Ing. Thomas Hoell

Report Template Version: 2007-08-29

### **1.2 Project Data**

Responsible for testing and report: Dr.-Ing. Michael Küppers  
Receipt of EUT: 2008-05-05  
Date of Test(s): 2008-05-06 to 2008-06-30  
Date of Report: 2008-07-01

### **1.3 Applicant Data**

Company Name: Option NV  
Address: Gaston Geenslaan 14  
3001 Leuven  
Belgium  
Contact Person: Mr. Gulinck

### **1.4 Manufacturer Data**

Company Name: Please see applicant data

Address:

Contact Person:

## 2 Test object Data

### 2.1 General EUT Description

<b>Equipment under Test:</b>	GSM/UMTS Module
<b>Type Designation:</b>	MO0402
<b>Kind of Device:</b>	GSM/EDGE 850/900/1800/1900
<b>(optional)</b>	UTRA FDD I, FDD II and FDD V, HSUPA/HSDPA
<b>Voltage Type:</b>	DC
<b>Nominal Voltage:</b>	3.6 V
<b>Maximum Voltage:</b>	3.6 V
<b>Minimum Voltage:</b>	3.0 V

#### General product description:

The Equipment Under Test (EUT) is a GSM/EDGE 850/900/1800/1900 module and supports FDD I, FDD II and FDD V, HSUPA/HSDPA.

The manufacturer declared that nominal voltage is equal to high voltage.

In GSM 850 mode the EUT operates in channel blocks A and B from 824.2 MHz (lowest channel = 128) to 848.8 MHz (highest channel = 251).

In FDD V mode the EUT operates in channel blocks A and B from 826.4 MHz (lowest channel = 4132) to 846.6 MHz (highest channel = 4233).

#### The EUT provides the following ports:

##### Ports

Enclosure  
Antenna connector  
Module to cradle connector

The main components of the EUT are listed and described in Chapter 2.2.

### 2.2 EUT Main components

#### Type, S/N, Short Descriptions etc. used in this Test Report

Short Description	Equipment under Test	Type Designation	Serial No.	HW Status	SW Status	Date of Receipt
EUT A (Code: 37410b01)	GSM/UMTS module	MO0402	PR148430AM	HW 1.A	1.2.0.0Hd	2008-05-05
Remark: EUT A is equipped with an antenna connector.						
EUT B (Code: 37410c01)	GSM/UMTS module	MO0402	PR148430BS	HW 1.A	1.2.0.0Hd	2008-05-05
Remark: EUT B is equipped with an antenna connector.						
EUT C (Code: 37410d01)	GSM/UMTS module	MO0402	PR14843071	HW 1.A	1.2.0.0Hd	2008-05-05
Remark: EUT C is equipped with an antenna connector.						
EUT D (Code: 37410h02)	GSM/UMTS module	MO0402	PR2486D02N	HW 2.1	1.2.4.0Hd	2008-06-24
Remark: EUT C is equipped with an antenna connector.						



**NOTE: The short description is used to simplify the identification of the EUT in this test report.**

### 2.3 Ancillary Equipment

For the purposes of this test report, ancillary equipment is defined as equipment which is used in conjunction with the EUT to provide operational and control features to the EUT. It is necessary to configure the system in a typical fashion, as a customer would normally use it. But nevertheless Ancillary Equipment can influence the test results.

Short Description	Equipment under Test	Type Designation	HW Status	SW Status	Serial no.	FCC ID
AE0007	Test Cradle	SPQ-CRA-MO-0007	V2.0			–
AE0008	Test Cradle	SPQ-CRA-MO-0008	V2.0			–
AE0010	Test Cradle	SPQ-CRA-MO-0010	V2.0			–
AE0027	Test Cradle	SPQ-CRA-MO-0027	V1.0			–

### 2.4 EUT Setups

This chapter describes the combination of EUT's and ancillary equipment used for testing.

Setup No.	Combination of EUTs	Description
setup_b01	EUT A + AE0007	setup for frequency stability test
setup_c01	EUT B + AE0008	setup for radiated spurious emissions tests
setup_d01	EUT C + AE0010	setup for conducted tests
setup_d02	EUT C + AE0027	setup for conducted HSPA tests
setup_e03	EUT D + AE0027	setup for conducted and radiated spurious emissions tests





## 2.5 Operating Modes

This chapter describes the operating modes of the EUT's used for testing.

<b>Op. Mode</b>	<b>Description of Operating Modes</b>	<b>Remarks</b>
<b>PCS data call</b>		
op-mode 1	Call established on Traffic Channel (TCH) 128, Carrier Frequency 824.2 MHz	128 is the lowest channel PCS data call
op-mode 2	Call established on Traffic Channel (TCH) 190, Carrier Frequency 836.6 MHz	190 is a mid channel PCS data call
op-mode 3	Call established on Traffic Channel (TCH) 251, Carrier Frequency 848.8 MHz	251 is the highest channel PCS data call
<b>EDGE data call</b>		
op-mode 4	Call established on Traffic Channel (TCH) 128, Carrier Frequency 824.2 MHz	128 is the lowest channel EDGE data call
op-mode 5	Call established on Traffic Channel (TCH) 190, Carrier Frequency 836.6 MHz	190 is a mid channel EDGE data call
op-mode 6	Call established on Traffic Channel (TCH) 251, Carrier Frequency 848.8 MHz	251 is the highest channel EDGE data call
<b>FDD V data call</b>		
op-mode 7	Call established on Traffic Channel (TCH) 4132, Carrier Frequency 826.4 MHz	4132 is the lowest channel FDD V data call
op-mode 8	Call established on Traffic Channel (TCH) 4183, Carrier Frequency 836.6 MHz	4183 is a mid channel FDD V data call
op-mode 9	Call established on Traffic Channel (TCH) 4233, Carrier Frequency 846.6 MHz	4233 is the highest channel FDD V data call
<b>FDD V HSDPA data call</b>		
op-mode 10	Call established on Traffic Channel (TCH) 4132, Carrier Frequency 826.4 MHz	4132 is the lowest channel FDD V data call
op-mode 11	Call established on Traffic Channel (TCH) 4183, Carrier Frequency 836.6 MHz	4183 is a mid channel FDD V data call
op-mode 12	Call established on Traffic Channel (TCH) 4233, Carrier Frequency 846.6 MHz	4233 is the highest channel FDD V data call
<b>FDD V HSUPA data call</b>		
op-mode 13	Call established on Traffic Channel (TCH) 4132, Carrier Frequency 826.4 MHz	4132 is the lowest channel FDD V data call
op-mode 14	Call established on Traffic Channel (TCH) 4183, Carrier Frequency 836.6 MHz	4183 is a mid channel FDD V data call
op-mode 15	Call established on Traffic Channel (TCH) 4233, Carrier Frequency 846.6 MHz	4233 is the highest channel FDD V data call

Subtests HSDPA:

Sub-test	$\beta_c$	$\beta_d$	$\beta_d$ (SF)	$\beta_c/\beta_d$	$\beta_{HS}$ (Note1, Note 2)	CM (dB) (Note 3)	MPR (dB) (Note 3)
1	2/15	15/15	64	2/15	4/15	0.0	0.0
2	12/15 (Note 4)	15/15 (Note 4)	64	12/15 (Note 4)	24/15	1.0	0.0
3	15/15	8/15	64	15/8	30/15	1.5	0.5
4	15/15	4/15	64	15/4	30/15	1.5	0.5

Note 1:  $\Delta_{ACK}$ ,  $\Delta_{NACK}$  and  $\Delta_{CQI} = 30/15$  with  $\beta_{hs} = 30/15 * \beta_c$ .

Note 2: For the HS-DPCCH power mask requirement test in clause 5.2C, 5.7A, and the Error Vector Magnitude (EVM) with HS-DPCCH test in clause 5.13.1A, and HSDPA EVM with phase discontinuity in clause 5.13.1AA,  $\Delta_{ACK}$  and  $\Delta_{NACK} = 30/15$  with  $\beta_{hs} = 30/15 * \beta_c$ , and  $\Delta_{CQI} = 24/15$  with  $\beta_{hs} = 24/15 * \beta_c$ .

Note 3: CM = 1 for  $\beta_c/\beta_d = 12/15$ ,  $\beta_{hs}/\beta_c = 24/15$ . For all other combinations of DPDCH, DPCCH and HS-DPCCH the MPR is based on the relative CM difference. This is applicable for only UEs that support HSDPA in release 6 and later releases.

Note 4: For subtest 2 the  $\beta_c/\beta_d$  ratio of 12/15 for the TFC during the measurement period (TF1, TF0) is achieved by setting the signalled gain factors for the reference TFC (TF1, TF1) to  $\beta_c = 11/15$  and  $\beta_d = 15/15$ .

Subtests HSUPA:

Subtest	Mode	Loopback Mode	Rel99 RMC	HSDPA FRC	HSUPA Test	Number of E-DPDCH Channels
1	Rel6 HSUPA	Test Mode 1	12.2kbps RMC	H-Set1	HSUPA Loopback	1
2	Rel6 HSUPA	Test Mode 1	12.2kbps RMC	H-Set1	HSUPA Loopback	1
3	Rel6 HSUPA	Test Mode 1	12.2kbps RMC	H-Set1	HSUPA Loopback	2
4	Rel6 HSUPA	Test Mode 1	12.2kbps RMC	H-Set1	HSUPA Loopback	1
5	Rel6 HSUPA	Test Mode 1	12.2kbps RMC	H-Set1	HSUPA Loopback	1

Subtest	Max UL Data Rate (kb/s)	$\beta_c/\beta_d$	$\beta_{hs}$	$\beta_{ed}$	CM	Power Class 3 limit
1	242.1	11/15	22/15	1309/225	1	24 (+1.7/-3.7 dB)
2	161.3	6/15	12/15	94/75	3	22 (+3.7/-3.7 dB)
3	524.7	15/9	30/15	47/15	2	23 (+2.7/-3.7 dB)
4	197.6	2/15	4/15	56/75	3	22 (+3.7/-3.7 dB)
5	299.6	15/15	30/15	134/15	1	24 (+1.7/-3.7 dB)



## 3 Test Results

### 3.1 RF Power Output

**Standard** FCC Part 22, 10-1-07  
Subpart H

The test was performed according to: FCC §2.1046, 10-1-07

#### 3.1.1 Test Description

- 1) The EUT was coupled to the R&S Spectrum Analyser and the R&S CMU200 Digital Communication Tester through a Power Divider. Refer to chapter "Setup Drawings".
- 2) The total insertion losses for RF Path 1 and RF Path 2 were measured. The values were used to correct the readings from the R&S Spectrum Analyser and the R&S CMU200 Digital Communication Tester.
- 3) A call was established on a Traffic Channel (TCH) between the EUT and the base station simulator (R&S CMU200 Digital Communication Tester).  
Important Settings:
  - Output Power: Varied during measurements
  - Channel (Frequency): Varied during measurements
- 4) The transmitted power of the EUT was measured by using a spectrum analyser.

#### 3.1.2 Test Requirements / Limits

§2.1046 Measurements Required: RF Power Output

(a) For transmitters other than single sideband, independent sideband and controlled carrier radiotelephone, power output shall be measured at the RF output terminals when the transmitter is adjusted in accordance with the tune-up procedure to give the values of current and voltage on the circuit elements specified in § 2.1033(c)(8). The electrical characteristics of the output terminals when this test is made shall be stated.

§22.913 Effective radiated power limits

(a) Maximum ERP. ... The ERP of mobile transmitters and auxiliary test transmitters must not exceed 7 Watts.



### 3.1.3 Test Protocol

Temperature: 27°C  
Air Pressure: 1014 hPa  
Humidity: 51%

<b>Op. Mode</b>	<b>Setup</b>	<b>Port</b>
op-mode 1	setup_e03	antenna connector

<b>Output power Measured (dBm)</b>
32.3

<b>Op. Mode</b>	<b>Setup</b>	<b>Port</b>
op-mode 2	setup_e03	antenna connector

<b>Output power Measured (dBm)</b>
32.3

<b>Op. Mode</b>	<b>Setup</b>	<b>Port</b>
op-mode 3	setup_e03	antenna connector

<b>Output power Measured (dBm)</b>
32.1

<b>Op. Mode</b>	<b>Setup</b>	<b>Port</b>
op-mode 4	setup_e03	antenna connector

<b>Output power Measured (dBm)</b>
30.1

<b>Op. Mode</b>	<b>Setup</b>	<b>Port</b>
op-mode 5	setup_e03	antenna connector

<b>Output power Measured (dBm)</b>
30.1

<b>Op. Mode</b>	<b>Setup</b>	<b>Port</b>
op-mode 6	setup_e03	antenna connector

<b>Output power Measured (dBm)</b>
30.0



Op. Mode	Setup	Port
op-mode 7	setup_d01	antenna connector

Output power Measured (dBm)
25.2

Op. Mode	Setup	Port
op-mode 8	setup_d01	antenna connector

Output power Measured (dBm)
25.0

Op. Mode	Setup	Port
op-mode 9	setup_d01	antenna connector

Output power Measured (dBm)
25.3

Op. Mode	Setup	Port
op-mode 10	setup_d02	antenna connector

HSDPA Subtest	Output power Measured (dBm)
1	25.15
2	26.25
3	25.97
4	25.70

Op. Mode	Setup	Port
op-mode 11	setup_d02	Antenna connector

HSDPA Subtest	Output power Measured (dBm)
1	24.97
2	25.61
3	25.61
4	25.12

Op. Mode	Setup	Port
op-mode 12	setup_d02	antenna connector

HSDPA Subtest	Output power Measured (dBm)
1	25.03
2	26.07
3	25.88
4	25.55



<b>Op. Mode</b>	<b>Setup</b>	<b>Port</b>
op-mode 13	setup_d02	antenna connector

<b>HSUPA Subtest</b>	<b>Output power Measured (dBm)</b>
1	26.13
2	25.88
3	26.22
4	25.27
5	26.31

<b>Op. Mode</b>	<b>Setup</b>	<b>Port</b>
op-mode 14	setup_d02	antenna connector

<b>HSUPA Subtest</b>	<b>Output power Measured (dBm)</b>
1	25.58
2	25.52
3	25.70
4	24.88
5	25.79

<b>Op. Mode</b>	<b>Setup</b>	<b>Port</b>
op-mode 15	setup_d02	antenna connector

<b>HSUPA Subtest</b>	<b>Output power Measured (dBm)</b>
1	25.85
2	25.79
3	25.97
4	25.36
5	26.00

### 3.1.4 Test result: RF Power Output

<b>FCC Part 22, Subpart H</b>	<b>Op. Mode</b>	<b>Result</b>
	op-mode 1	passed
	op-mode 2	passed
	op-mode 3	passed
	op-mode 4	passed
	op-mode 5	passed
	op-mode 6	passed
	op-mode 7	passed
	op-mode 8	passed
	op-mode 9	passed
	op-mode 10	passed
	op-mode 11	passed
	op-mode 12	passed
	op-mode 13	passed
	op-mode 14	passed
	op-mode 15	passed



## 3.2 Frequency stability

**Standard** FCC Part 22, 10-1-07  
Subpart H

**The test was performed according to** FCC §2.1055, 10-1-07

### 3.2.1 Test Description

- 1) The EUT was placed inside the climatic chamber.
- 2) The EUT was coupled to the R&S CMU200 Digital Communication Tester. Refer to chapter "Setup Drawings".
- 3) The climatic chamber was cycled down/up to a certain temperature, starting with  $-30^{\circ}\text{C}$ .
- 4) After the temperature was stabilized (at least one hour) the EUT was switched on and a call was established on a Traffic Channel (TCH) between the EUT and the base station simulator (R&S CMU200 Digital Communication Tester).  
Important Settings:
  - Output Power: Maximum
  - Mid Channel
- 5) The frequency error of the EUT were recorded by using an internal measurement function of the CMU200 immediately after the call was established, five minutes after the call was established and ten minutes after the call was established.
- 6) This measurement procedure was performed for all combinations of voltage (low, nominal, high) and temperature (from  $-30^{\circ}\text{C}$  to  $+50^{\circ}\text{C}$  in increments of  $10^{\circ}\text{C}$ ).

### 3.2.2 Test Requirements / Limits

§2.1055 Measurements required: Frequency stability

(a) The frequency stability shall be measured with variation of ambient temperature as follows:

(1) From  $-30^{\circ}$  to  $+50^{\circ}$  centigrade for all equipment except that specified in paragraphs (a) (2) and (3) of this section.

(b) Frequency measurements shall be made at the extremes of the specified temperature range and at intervals of not more than  $10^{\circ}$  centigrade through the range. A period of time sufficient to stabilize all of the components of the oscillator circuit at each temperature level shall be allowed prior to frequency measurement. The short term transient effects on the frequency of the transmitter due to keying (except for broadcast transmitters) and any heating element cycling normally occurring at each ambient temperature level also shall be shown. Only the portion or portions of the transmitter containing the frequency determining and stabilizing circuitry need be subjected to the temperature variation test.



(d) The frequency stability shall be measured with variation of primary supply voltage as follows:

- (1) Vary primary supply voltage from 85 to 115 percent of the nominal value for other than hand carried battery equipment.
- (2) For hand carried, battery powered equipment, reduce primary supply voltage to the battery operating end point which shall be specified by the manufacturer.
- (3) The supply voltage shall be measured at the input to the cable normally provided with the equipment, or at the power supply terminals if cables are not normally provided. Effects on frequency of transmitter keying (except for broadcast transmitters) and any heating element cycling at the nominal supply voltage and at each extreme also shall be shown.

§22.355 Frequency tolerance

...the carrier frequency of each transmitter in the Public Mobile Service must be maintained within the tolerances given in table C-1 of this section.

Table C-1.- Frequency Tolerance for Transmitters in the Public Mobile Services

Frequency range (ppm)	Base, fixed (ppm)	Mobile up to 3 watts (ppm)	Mobile above 3 watts (ppm)
25 to 50	20.0	20.0	50.0
50 to 450	5.0	5.0	50.0
450 to 512	2.5	5.0	5.0
821 to 896	1.5	<b>2.5</b>	2.5
928 to 929	5.0	n/a	n/a
929 to 960	1.5	n/a	n/a
2110 to 2220	10.0	n/a	n/a

For the mid channel (836.6 MHz) the frequency tolerance is 2.5 ppm (2091.5 Hz).



### 3.2.3 Test Protocol

Temperature: 28°C  
 Air Pressure: 1023 hPa  
 Humidity: 30%

Op. Mode	Setup	Port
op-mode 2	setup_b01	antenna connector

		Normal Voltage / V	
		3.6	
Temp. °C	Duration min	Freq. error Average (Hz)	Freq. error Max. (Hz)
+50	0	-56	-1199
+50	5	-51	1064
+50	10	-71	1350
+40	0	-6	-418
+40	5	-7	536
+40	10	-10	-448
+30	0	-32	310
+30	5	-11	-309
+30	10	-25	491
+10	0	-43	-724
+10	5	-13	-852
+10	10	-26	-1104
0	0	-24	-1119
0	5	-16	-734
0	10	-21	764
-10	0	-8	938
-10	5	-7	-423
-10	10	-41	-571
-20	0		
-20	5		
-20	10		
-30	0		
-30	5		
-30	10		

Remark: The OUT did not operate at -30 °C and -20 °C.

		Minimum Voltage / V		Normal Voltage / V		Maximum Voltage / V	
		3.0		3.6		3.6	
Temp. °C	Duration min	Freq. error Average (Hz)	Freq. error Max. (Hz)	Freq. error Average (Hz)	Freq. error Max. (Hz)	Freq. error Average (Hz)	Freq. error Max. (Hz)
+20	0	-10	-530	-22	420		
+20	5	-3	346	-20	-1364		
+20	10	-17	368	6	-1203		

Remark: The manufacturer declared normal = maximum voltage.

Op. Mode	Setup	Port
op-mode 5	setup_b01	antenna connector

		Normal Voltage / V	
		3.6	
Temp. °C	Duration min	Freq. error Average (Hz)	Freq. error Max. (Hz)
+50	0	27	1068
+50	5	-10	792
+50	10	17	1019
+40	0	24	625
+40	5	25	824
+40	10	-15	-793
+30	0	7	505
+30	5	-21	674
+30	10	-32	-591
+10	0	18	950
+10	5	20	-832
+10	10	17	-840
0	0	1	-949
0	5	25	627
0	10	23	807
-10	0	-52	-1903
-10	5	-34	1339
-10	10	-45	-1089
-20	0		
-20	5		
-20	10		
-30	0		
-30	5		
-30	10		

Remark: The OUT did not operate at -30 °C and -20 °C.

		Minimum Voltage / V		Normal Voltage / V		Maximum Voltage / V	
		3.0		3.6		3.6	
Temp. °C	Duration min	Freq. error Average (Hz)	Freq. error Max. (Hz)	Freq. error Average (Hz)	Freq. error Max. (Hz)	Freq. error Average (Hz)	Freq. error Max. (Hz)
+20	0	6	434	-40	-1156		
+20	5	0	517	-52	-1090		
+20	10	-28	-408	-23	1308		

Remark: The manufacturer declared normal = maximum voltage.



**Op. Mode**      **Setup**      **Port**  
 op-mode 8      setup\_b01      antenna connector

		Normal Voltage / V	
		3.6	
Temp. °C	Duration min	Freq. error Average (Hz)	Freq. error Max. (Hz)
+50	0	11	1957
+50	5	16	1611
+50	10	-103	2031
+40	0	-57	-2021
+40	5	73	1673
+40	10	-44	1682
+30	0	-51	-1328
+30	5	-49	-1202
+30	10	-10	887
+10	0	-49	1719
+10	5	27	949
+10	10	-61	1564
0	0	-27	-1824
0	5	-19	1396
0	10	23	1332
-10	0	89	1942
-10	5	-11	-1696
-10	10	-41	1566
-20	0		
-20	5		
-20	10		
-30	0		
-30	5		
-30	10		

Remark: The OUT did not operate at -30 °C and -20 °C.

		Minimum Voltage / V		Normal Voltage / V		Maximum Voltage / V	
		3.0		3.6		3.6	
Temp. °C	Duration min	Freq. error Average (Hz)	Freq. error Max. (Hz)	Freq. error Average (Hz)	Freq. error Max. (Hz)	Freq. error Average (Hz)	Freq. error Max. (Hz)
+20	0	-45	1032	1	1610		
+20	5	-73	-1499	-33	-1721		
+20	10	-32	-1031	78	993		

Remark: The manufacturer declared normal = maximum voltage.

### 3.2.4 Test result: Frequency stability

FCC Part 22, Subpart H	Op. Mode	Result
	op-mode 2	passed
	op-mode 5	passed
	op-mode 8	passed



### 3.3 Spurious emissions at antenna terminals

**Standard**     FCC Part 22, 10-1-07  
                      Subpart H

**The test was performed according to** FCC §2.1051, 10-1-07

#### 3.3.1 Test Description

- 1) The EUT was coupled to the R&S Spectrum Analyser and the R&S CMU200 Digital Communication Tester through a Power Divider. Refer to chapter "Setup Drawings".
- 2) The total insertion losses for RF Path 1 and RF Path 2 were measured. The values were used to correct the readings from the R&S Spectrum Analyser and the R&S CMU200 Digital Communication Tester.
- 3) A call was established on a Traffic Channel (TCH) between the EUT and the base station simulator (R&S CMU200 Digital Communication Tester).  
Important Settings:
  - Output Power: Maximum
  - Channel: Varied during measurements
- 4) Important Analyser Settings
  - Resolution Bandwidth:
    - a) greater than 100 kHz
    - b) reduced resolution in case the curve of the analyser IF-Filter leads to an exceeding of the limit, in this case a correction factor was used
    - c) reduced resolution bandwidth in the Span of 1 MHz directly below and above the Band
- 5) The spurious emissions (peak) were measured in the frequency range from 9 kHz to 10 GHz (up to the 10th harmonic) during the call is established on the lowest channel

#### 3.3.2 Test Requirements / Limits

§ 2.1051 Spurious emissions at antenna terminals

The radio frequency voltage or power generated within the equipment and appearing on a spurious frequency shall be checked at the equipment output terminals when properly loaded with a suitable artificial antenna. Curves or equivalent data shall show the magnitude of each harmonic and other spurious emission that can be detected when the equipment is operated under the conditions specified in Sec. 2.1049 as appropriate. The magnitude of spurious emissions which are attenuated more than 20 dB below the permissible value need not be specified.



§ 2.1057 Frequency spectrum to be investigated.

(a) In all of the measurements set forth in Secs. 2.1051 and 2.1053, the spectrum shall be investigated from the lowest radio frequency signal generated in the equipment, without going below 9 kHz, up to at least the frequency shown below:

(1) If the equipment operates below 10 GHz: to the tenth harmonic of the highest fundamental frequency or to 40 GHz, whichever is lower.

(b) Particular attention should be paid to harmonics and subharmonics of the carrier frequency as well as to those frequencies removed from the carrier by multiples of the oscillator frequency. Radiation at the frequencies of multiplier stages should also be checked.

(c) The amplitude of spurious emissions which are attenuated more than 20 dB below the permissible value need not be reported.

(d) Unless otherwise specified, measurements above 40 GHz shall be performed using a minimum resolution bandwidth of 1 MHz.

§ 22.917 Emission limitations for cellular equipment

(a) The power of any emission outside of the authorized operating frequency ranges must be attenuated below the transmitting power (P) by a factor of at least  $43 + 10 \log(P)$  dB.

Remark of the test laboratory: This is calculated to be -13 dBm.

(b) Compliance with these rules is based on the use of measurement instrumentation employing a resolution bandwidth of 100 kHz or greater. In the 1 MHz bands immediately outside and adjacent to the frequency block a resolution bandwidth of at least one percent of the emission bandwidth of the fundamental emission of the transmitter may be employed. A narrower resolution bandwidth is permitted in all cases to improve measurement accuracy provided the measured power is integrated over the full required measurement bandwidth (*i.e.* 100 kHz or 1 percent of emission bandwidth, as specified). The emission bandwidth is defined as the width of the signal between two points, one below the carrier center frequency and one above the carrier center frequency, outside of which all emissions are attenuated at least 26 dB below the transmitter power.

(c) Licensees in this service may establish an alternative out of band emission limit to be used at specified band edge(s) in specified geographical areas [...].

(d) If any emission from a transmitter operating in this service results in interference to users of another radio service, the FCC may require a greater attenuation of that emission than specified in this section.

### 3.3.3 Test Protocol

Temperature: 28°C  
 Air Pressure: 1023 hPa  
 Humidity: 30%

Op. Mode	Setup	Port
op-mode 1	setup_d01	antenna connector

Frequency MHz	Bandwidth kHz	Measured Level dBm	Limit dBm
823.98	3.0	-14.71	-13.0

Remark: No (further) spurious emissions were found in the range 20 dB below the limit.

Op. Mode	Setup	Port
op-mode 2	setup_d01	antenna connector

Frequency MHz	Bandwidth kHz	Measured Level dBm	Limit dBm
-	-	-	-13.0

Remark: No (further) spurious emissions were found in the range 20 dB below the limit.

Op. Mode	Setup	Port
op-mode 3	setup_d01	antenna connector

Frequency MHz	Bandwidth kHz	Measured Level dBm	Limit dBm
849.02	3.0	-13.47	-13.0

Remark: No (further) spurious emissions were found in the range 20 dB below the limit.

Op. Mode	Setup	Port
op-mode 4	setup_d01	antenna connector

Frequency MHz	Bandwidth kHz	Measured Level dBm	Limit dBm
824.0	3.0	-20.99	-13.0

Remark: No (further) spurious emissions were found in the range 20 dB below the limit.



---

<b>Op. Mode</b>	<b>Setup</b>	<b>Port</b>
op-mode 5	setup_d01	antenna connector

Frequency MHz	Bandwidth kHz	Measured Level dBm	Limit dBm
855.7	1000.0	-31.55	-13.0

Remark: No (further) spurious emissions were found in the range 20 dB below the limit.

---

<b>Op. Mode</b>	<b>Setup</b>	<b>Port</b>
op-mode 6	setup_d01	antenna connector

Frequency MHz	Bandwidth kHz	Measured Level dBm	Limit dBm
849.0	3.0	-21.77	-13.0

Remark: No (further) spurious emissions were found in the range 20 dB below the limit.

---

<b>Op. Mode</b>	<b>Setup</b>	<b>Port</b>
op-mode 7	setup_d01	antenna connector

Frequency MHz	Bandwidth kHz	Measured Level dBm	Limit dBm
-	-	-	-13.0

Remark: No (further) spurious emissions were found in the range 20 dB below the limit.

---

<b>Op. Mode</b>	<b>Setup</b>	<b>Port</b>
op-mode 8	setup_d01	antenna connector

Frequency MHz	Bandwidth kHz	Measured Level dBm	Limit dBm
-	-	-	-13.0

Remark: No (further) spurious emissions were found in the range 20 dB below the limit.

---

<b>Op. Mode</b>	<b>Setup</b>	<b>Port</b>
op-mode 9	setup_d01	antenna connector

Frequency MHz	Bandwidth kHz	Measured Level dBm	Limit dBm
850.6	100.0	-18.71	-13.0

Remark: No (further) spurious emissions were found in the range 20 dB below the limit.



### 3.3.4 Test result: Spurious emissions at antenna terminals

FCC Part 22, Subpart H	Op. Mode	Result
	op-mode 1	passed
	op-mode 2	passed
	op-mode 3	passed
	op-mode 4	passed
	op-mode 5	passed
	op-mode 6	passed
	op-mode 7	passed
	op-mode 8	passed
	op-mode 9	passed



### 3.4 Field strength of spurious radiation

**Standard** FCC Part 22, 10-1-07  
Subpart H

The test was performed according to: FCC §2.1053, 10-1-07

#### 3.4.1 Test Description

1) The EUT was placed inside an anechoic chamber. Refer to chapter "Setup Drawings". The EUT was coupled to the R&S CMU200 Digital Communication Tester which was located outside the chamber via coaxial cable.

2) A call was established on a Traffic Channel (TCH) between the EUT and the base station simulator (R&S CMU200 Digital Communication Tester).

Important Settings:

- Output Power: Maximum
- Channel : Varied during measurements

3) A pre-calibration procedure is used so that the readings from the spectrum analyser are corrected and represent directly the equivalent radiated power (related to a  $\lambda/2$  dipole).

4) All spurious radiation measurements were made with spectrum analyser and the appropriate calibrated antennas for the frequency range of 30 MHz to 10 GHz (up to the 10th harmonic of the transmit frequency).

5) Important Analyser Settings

- [Resolution Bandwidth / Video Bandwidth]:

a) [3 kHz / 10 kHz] in the Span of 1 MHz directly below and above the GSM-Band,

b) [10 kHz / 30 kHz] in case the curve of the analyser IF-Filter leads to an exceeding of the limit, in this case a worst case correction factor of 20 dB (1 MHz  $\rightarrow$  10 kHz) was used

c) [1 MHz / 3 MHz] otherwise

- Sweep Time: Calculated by using a formula given in the Product Standard "GSM 11.10-1 edition 4" for spurious emissions measurements (depending on the transmitting signal, the span and the resolution bandwidth)

6) The spurious emissions (peak) were measured in both vertical and horizontal antenna polarisation during the call is established on the lowest channel, mid channel and on the highest channel.

#### 3.4.2 Test Requirements / Limits

§ 2.1053 Measurements required: Field strength of spurious radiation.

Measurements shall be made to detect spurious emissions that may be radiated directly from the cabinet, control circuits, power leads, or intermediate circuit elements under normal conditions of installation and operation. Curves or equivalent data shall be supplied showing the magnitude of each harmonic and other spurious emission. For this test, single sideband, independent sideband, and controlled carrier transmitters shall be modulated under the conditions specified in paragraph (c) of Sec. 2.1049, as appropriate. For equipment operating on frequencies below 890 MHz, an open field test is normally required, with the measuring instrument antenna located in the far-field at all test frequencies. In the event it is either impractical or impossible to make open field



measurements (e.g. a broadcast transmitter installed in a building) measurements will be accepted of the equipment as installed. Such measurements must be accompanied by a description of the site where the measurements were made showing the location of any possible source of reflections which might distort the field strength measurements. Information submitted shall include the relative radiated power of each spurious emission with reference to the rated power output of the transmitter, assuming all emissions are radiated from halfwave dipole antennas.

(b) The measurements specified in paragraph (a) of this section shall be made for the following equipment:

(2) All equipment operating on frequencies higher than 25 MHz.

§ 2.1057 Frequency spectrum to be investigated.

(a) In all of the measurements set forth in Secs. 2.1051 and 2.1053, the spectrum shall be investigated from the lowest radio frequency signal generated in the equipment, without going below 9 kHz, up to at least the frequency shown below:

(1) If the equipment operates below 10 GHz: to the tenth harmonic of the highest fundamental frequency or to 40 GHz, whichever is lower.

(b) Particular attention should be paid to harmonics and subharmonics of the carrier frequency as well as to those frequencies removed from the carrier by multiples of the oscillator frequency. Radiation at the frequencies of multiplier stages should also be checked.

(c) The amplitude of spurious emissions which are attenuated more than 20 dB below the permissible value need not be reported.

(d) Unless otherwise specified, measurements above 40 GHz shall be performed using a minimum resolution bandwidth of 1 MHz.

§ 22.917 Emission limitations for cellular equipment

(a) The power of any emission outside of the authorized operating frequency ranges must be attenuated below the transmitting power (P) by a factor of at least  $43 + 10 \log(P)$  dB.

This is calculated to be -13 dBm (effective radiated power) which corresponds to 84.6 dB $\mu$ V/m (field strength) in a distance of 3 m.

(b) Compliance with these rules is based on the use of measurement instrumentation employing a resolution bandwidth of 100 kHz or greater. In the 1 MHz bands immediately outside and adjacent to the frequency block a resolution bandwidth of at least one percent of the emission bandwidth of the fundamental emission of the transmitter may be employed. A narrower resolution bandwidth is permitted in all cases to improve measurement accuracy provided the measured power is integrated over the full required measurement bandwidth (*i.e.* 100 kHz or 1 percent of emission bandwidth, as specified). The emission bandwidth is defined as the width of the signal between two points, one below the carrier center frequency and one above the carrier center frequency, outside of which all emissions are attenuated at least 26 dB below the transmitter power.

(c) Licensees in this service may establish an alternative out of band emission limit to be used at specified band edge(s) in specified geographical areas [...].

(d) If any emission from a transmitter operating in this service results in interference to users of another radio service, the FCC may require a greater attenuation of that emission than specified in this section.

### 3.4.3 Test Protocol

Temperature: 26°C  
 Air Pressure: 1018 hPa  
 Humidity: 45%

Op. Mode	Setup	Port
op-mode 1	setup_e03	enclosure

Frequency MHz	Antenna Polarisation	Bandwidth kHz	Measured Level dBm	Limit dBm
824.0	Horizontal	3	-18.70	-13.0
1634.0	Horizontal	1000	-22.62	-13.0
2459.0	Horizontal	1000	-31.53	-13.0

Remark: No (further) spurious emissions were found in the range 20 dB below the limit.

Op. Mode	Setup	Port
op-mode 2	setup_e03	enclosure

Frequency MHz	Antenna Polarisation	Bandwidth kHz	Measured Level dBm	Limit dBm
1667.0	Horizontal	1000	-21.88	-13.0
2509.0	Horizontal	1000	-32.28	-13.0

Remark: No (further) spurious emissions were found in the range 20 dB below the limit.

Op. Mode	Setup	Port
op-mode 3	setup_e03	enclosure

Frequency MHz	Antenna Polarisation	Bandwidth kHz	Measured Level dBm	Limit dBm
849.0	Horizontal	3	-16.66	-13.0
1684.0	Horizontal	1000	-21.39	-13.0

Remark: No (further) spurious emissions were found in the range 20 dB below the limit.

Op. Mode	Setup	Port
op-mode 4	setup_e03	enclosure

Frequency MHz	Antenna Polarisation	Bandwidth kHz	Measured Level dBm	Limit dBm
824.0	Horizontal	3	-23.58	-13.0

Remark: No (further) spurious emissions were found in the range 20 dB below the limit.

Op. Mode	Setup	Port
op-mode 5	setup_e03	enclosure

Frequency MHz	Antenna Polarisation	Bandwidth kHz	Measured Level dBm	Limit dBm
-	-	-	-	-13.0

Remark: No (further) spurious emissions were found in the range 20 dB below the limit.



---

<b>Op. Mode</b>	<b>Setup</b>	<b>Port</b>
op-mode 6	setup_e03	enclosure

Frequency MHz	Antenna Polarisation	Bandwidth kHz	Measured Level dBm	Limit dBm
849.0	horizontal	3.0	-26.74	-13.0

Remark: No (further) spurious emissions were found in the range 20 dB below the limit.

---

<b>Op. Mode</b>	<b>Setup</b>	<b>Port</b>
op-mode 7	setup_c01	enclosure

Frequency MHz	Antenna Polarisation	Bandwidth kHz	Measured Level dBm	Limit dBm
-	-	-	-	-13.0

Remark: No (further) spurious emissions were found in the range 20 dB below the limit.



<b>Op. Mode</b>	<b>Setup</b>	<b>Port</b>
op-mode 8	setup_c01	enclosure

<b>Frequency MHz</b>	<b>Antenna Polarisation</b>	<b>Bandwidth kHz</b>	<b>Measured Level dBm</b>	<b>Limit dBm</b>
-	-	-	-	-13.0

Remark: No (further) spurious emissions were found in the range 20 dB below the limit.

<b>Op. Mode</b>	<b>Setup</b>	<b>Port</b>
op-mode 9	setup_c01	enclosure

<b>Frequency MHz</b>	<b>Antenna Polarisation</b>	<b>Bandwidth kHz</b>	<b>Measured Level dBm</b>	<b>Limit dBm</b>
1684.2	horizontal	1000.0	-32.3	-13.0

Remark: No (further) spurious emissions were found in the range 20 dB below the limit.

### 3.4.4 Test result: Field strength of spurious radiation

<b>FCC Part 22, Subpart H</b>	<b>Op. Mode</b>	<b>Result</b>
	op-mode 1	passed
	op-mode 2	passed
	op-mode 3	passed
	op-mode 4	passed
	op-mode 5	passed
	op-mode 6	passed
	op-mode 7	passed
	op-mode 8	passed
	op-mode 9	passed



### 3.5 Emission and Occupied Bandwidth

**Standard** FCC Part 22, 10-1-07  
Subpart H

The test was performed according to: FCC §2.1049, 10-1-07

#### 3.5.1 Test Description

1) The EUT was coupled to the R&S Spectrum Analyser and the R&S CMU200 Digital Communication Tester through a Power Divider. Refer to chapter "Setup Drawings".

2) The total insertion losses for RF Path 1 and RF Path 2 were measured. The values were used to correct the readings from the R&S Spectrum Analyser and the R&S CMU200 Digital Communication Tester.

3) A call was established on a Traffic Channel (TCH) between the EUT and the base station simulator (R&S CMU200 Digital Communication Tester).

Important Settings:

- Output Power: Maximum
- Channel: Varied during measurements

4) Important Analyser Settings:

- Resolution Bandwidth: 1% of the manufacturers stated occupied bandwidth
- Sweep Span: 1 MHz (at least 250% of the emission bandwidth)

5) The maximum spectral level of the modulated signal was recorded as the reference.

6) The emission bandwidth is measured as follows:

the two furthest frequencies above and below the frequency of the maximum reference level where the spectrum is  $-26$  dB down have to be found.

7) The occupied bandwidth (99% Bandwidth) is measured as follows:

the occupied bandwidth, that is the frequency bandwidth such that, below its lower and above its upper frequency limits, the mean powers radiated are each equal to 0.5 percent of the total mean power.



### **3.5.2 Test Requirements / Limits**

§ 2.1049 Measurements required: Occupied bandwidth

The occupied bandwidth, that is the frequency bandwidth such that, below its lower and above its upper frequency limits, the mean powers radiated are each equal to 0.5 percent of the total mean power radiated by a given emission shall be measured under the following conditions (as applicable):

(h) Transmitters employing digital modulation techniques - when modulated by an input signal such that its amplitude and symbol rate represent the maximum rated conditions under which the equipment will be operated. The signal shall be applied through any filter networks, pseudo-random generators or other devices required in normal service. Additionally, the occupied bandwidth shall be shown for operation with any devices used for modifying the spectrum when such devices are optional at the discretion of the user.

### 3.5.3 Test Protocol

Temperature: 28°C  
 Air Pressure: 1023 hPa  
 Humidity: 30%

Op. Mode	Setup	Port
op-mode 1	setup_d01	antenna connector

Bandwidth kHz	Remarks
312	please see annex

Remark: The given value is the result of the 26dB bandwidth measurement.  
 The 99% Bandwidth is 248.0 kHz.

Op. Mode	Setup	Port
op-mode 2	setup_d01	antenna connector

Bandwidth kHz	Remarks
314	please see annex

Remark: The given value is the result of the 26dB bandwidth measurement.  
 The 99% Bandwidth is 248.0 kHz.

Op. Mode	Setup	Port
op-mode 3	setup_d01	antenna connector

Bandwidth kHz	Remarks
314	please see annex

Remark: The given value is the result of the 26dB bandwidth measurement.  
 The 99% Bandwidth is 248.0 kHz.

Op. Mode	Setup	Port
op-mode 4	setup_d01	antenna connector

Bandwidth kHz	Remarks
306	please see annex

Remark: The given value is the result of the 26dB bandwidth measurement.  
 The 99% Bandwidth is 242.0 kHz.

Op. Mode	Setup	Port
op-mode 5	setup_d01	antenna connector

Bandwidth kHz	Remarks
306	please see annex

Remark: The given value is the result of the 26dB bandwidth measurement.  
 The 99% Bandwidth is 246.0 kHz.





Op. Mode	Setup	Port
op-mode 6	setup_d01	antenna connector

Bandwidth kHz	Remarks
318	please see annex

Remark: The given value is the result of the 26dB bandwidth measurement.  
The 99% Bandwidth is 248.0 kHz.

Op. Mode	Setup	Port
op-mode 7	setup_d01	antenna connector

Bandwidth kHz	Remarks
4689	please see annex

Remark: The given value is the result of the 26dB bandwidth measurement.  
The 99% Bandwidth is 4188.0 kHz.

Op. Mode	Setup	Port
op-mode 8	setup_d01	antenna connector

Bandwidth kHz	Remarks
4689	please see annex

Remark: The given value is the result of the 26dB bandwidth measurement.  
The 99% Bandwidth is 4168.0 kHz.

Op. Mode	Setup	Port
op-mode 9	setup_d01	antenna connector

Bandwidth kHz	Remarks
4689	please see annex

Remark: The given value is the result of the 26dB bandwidth measurement.  
The 99% Bandwidth is 4188.0 kHz.

### 3.5.4 Test result: Emission and Occupied Bandwidth

FCC Part 22, Subpart H	Op. Mode	Result
	op-mode 1	passed
	op-mode 2	passed
	op-mode 3	passed
	op-mode 4	passed
	op-mode 5	passed
	op-mode 6	passed
	op-mode 7	passed
	op-mode 8	passed
	op-mode 9	passed



### **3.6 Band edge compliance**

**Standard** FCC Part 22, 10-1-07  
Subpart H

The test was performed according to: FCC §22.913, 10-1-07

#### **3.6.1 Test Description**

- 1) The EUT was coupled to the R&S CMU200 Digital Communications Tester via a 10 dB attenuator and a 6 dB coupler.
- 2) For the measurement the EUT is connected to the Spectrum Analyser via 30 dB attenuator and 6 dB coupler.
- 3) The spectrum analyser is set to a RBW/VBW of
  - 3 kHz / 3 kHz for GSM and EDGE mode.
  - 100 kHz / 100 kHz for FDD mode.

#### **3.6.2 Test Requirements / Limits**

§ 22.917 Emission limitations for cellular equipment

### 3.6.3 Test Protocol

Temperature: 27°C  
 Air Pressure: 1014 hPa  
 Humidity: 51%

Op. Mode	Setup	Port
op-mode 1	setup_e03	Temp.ant.connector

Frequency MHz	Measured value dBm	Limit dBm
824.0	-14.66	-13

Remark: Please see annex for the measurement plot.

Op. Mode	Setup	Port
op-mode 3	setup_e03	Temp.ant.connector

Frequency MHz	Measured value dBm	Limit dBm
849.0	-15.00	-13

Remark: Please see annex for the measurement plot.

Op. Mode	Setup	Port
op-mode 4	setup_e03	Temp.ant.connector

Frequency MHz	Measured value dBm	Limit dBm
824.0	-22.79	-13

Remark: Please see annex for the measurement plot.

Op. Mode	Setup	Port
op-mode 6	setup_e03	Temp.ant.connector

Frequency MHz	Measured value dBm	Limit dBm
849.0	-22.03	-13

Remark: Please see annex for the measurement plot.

Op. Mode	Setup	Port
op-mode 7	setup_d01	Temp.ant.connector

Frequency MHz	Measured value dBm	Limit dBm
824.0	-17.94	-13

Remark: Please see annex for the measurement plot.



<b>Op. Mode</b>	<b>Setup</b>	<b>Port</b>
op-mode 9	setup_d01	Temp.ant.connector

<b>Frequency MHz</b>	<b>Measured value dBm</b>	<b>Limit dBm</b>
849.0	-16.65	-13

Remark: Please see annex for the measurement plot.

### 3.6.4 Test result: Band edge compliance

<b>FCC Part 22, Subpart H</b>	<b>Op. Mode</b>	<b>Result</b>
	op-mode 1	passed
	op-mode 3	passed
	op-mode 4	passed
	op-mode 6	passed
	op-mode 7	passed
	op-mode 9	passed

## 4 Test Equipment

### *EUT Digital Signalling System*

<b>Equipment</b>	<b>Type</b>	<b>Serial No.</b>	<b>Manufacturer</b>
Digital Radio Communication Tester	CMD 55	831050/020	Rohde & Schwarz
Signalling Unit for Bluetooth Spurious Emissions	PTW60	100004	Rohde & Schwarz
Universal Radio Communication Tester	CMU 200	102366	Rohde & Schwarz

### *EMI Test System*

<b>Equipment</b>	<b>Type</b>	<b>Serial No.</b>	<b>Manufacturer</b>
Comparison Noise Emitter	CNE III	99/016	York
EMI Analyzer	ESI 26	830482/004	Rohde & Schwarz
Signal Generator	SMR 20	846834/008	Rohde & Schwarz

### *EMI Radiated Auxiliary Equipment*

<b>Equipment</b>	<b>Type</b>	<b>Serial No.</b>	<b>Manufacturer</b>
Antenna mast 4m	MA 240	240/492	HD GmbH H. Deisel
Biconical dipole	VUBA 9117	9117108	Schwarzbeck
Broadband Amplifier 18MHz-26GHz	JS4-18002600-32	849785	Miteq
Broadband Amplifier 30MHz-18GHz	JS4-00101800-35	896037	Miteq
Broadband Amplifier 45MHz-27GHz	JS4-00102600-42	619368	Miteq
Cable "ESI to EMI Antenna"	EcoFlex10	W18.01-2 + W38.01-2	Kabel Kusch
Cable "ESI to Horn Antenna"	UFB311A + UFB293C	W18.02-2 + W38.02-2	Rosenberger-Microcoax
Double-ridged horn	HF 906	357357/002	Rohde & Schwarz
Double-ridged horn	HF 906	357357/001	Rohde & Schwarz
High Pass Filter	5HC3500/12750-1.2-KK	200035008	Trilithic
High Pass Filter	5HC2700/12750-1.5-KK	9942012	Trilithic
High Pass Filter	4HC1600/12750-1.5-KK	9942011	Trilithic
KUEP pre amplifier	Kuep 00304000	001	7layers
Log.-per. Antenna	HL 562 Ultralog	830547/003	Rohde & Schwarz
Loop Antenna	HFH2-Z2	829324/006	Rohde & Schwarz
Pyramidal Horn Antenna 26.5 GHz	Model 3160-09	9910-1184	EMCO

### *EMI Conducted Auxiliary Equipment*

<b>Equipment</b>	<b>Type</b>	<b>Serial No.</b>	<b>Manufacturer</b>
Cable "LISN to ESI"	RG214	W18.03+W48.03	Huber+Suhner
Two-Line V-Network	ESH 3-Z5	828304/029	Rohde & Schwarz
Two-Line V-Network	ESH 3-Z5	829996/002	Rohde & Schwarz

### *Auxiliary Test Equipment*

<b>Equipment</b>	<b>Type</b>	<b>Serial No.</b>	<b>Manufacturer</b>
Broadband Resist. Power Divider N	1506A / 93459	LM390	Weinschel
Broadband Resist. Power Divider SMA	1515 / 93459	LN673	Weinschel
Digital Multimeter 01	Voltcraft M-3860M	IJ096055	Conrad
Digital Multimeter 02	Voltcraft M-3860M	IJ095955	Conrad
Digital Oscilloscope	TDS 784C	B021311	Tektronix
Fibre optic link Satellite	FO RS232 Link	181-018	Pontis
Fibre optic link Transceiver	FO RS232 Link	182-018	Pontis
I/Q Modulation Generator	AMIQ-B1	832085/018	Rohde & Schwarz
Notch Filter ultra stable	WRCA800/960-6E	24	Wainwright
Spectrum Analyzer 9 kHz to 3 GHz	FSP3	838164/004	Rohde & Schwarz
Temperature Chamber	VT 4002	58566002150010	Vötsch
Temperature Chamber	KWP 120/70	59226012190010	Weiss
ThermoHygro Datalogger 03	Opus10 THI (8152.00)	7482	Lufft Mess- und Regeltechnik GmbH

### *Anechoic Chamber*

<b>Equipment</b>	<b>Type</b>	<b>Serial No.</b>	<b>Manufacturer</b>
Air Compressor (pneumatic)			Atlas Copco
Controller	CO 2000	CO2000/328/12470406 /L	Innco innovative constructions GmbH
EMC Camera	CE-CAM/1		CE-SYS
EMC Camera for observation of EUT	CCD-400E	0005033	Mitsubishi
Filter ISDN	B84312-C110-E1		Siemens&Matsushita
Filter telephone systems / modem	B84312-C40-B1		Siemens&Matsushita
Filter Universal 1A	B84312-C30-H3		Siemens&Matsushita
Fully/Semi AE Chamber	10.58x6.38x6		Frankonia
Turntable	DS 420S	420/573/99	HD GmbH, H. Deisel
Valve Control Unit (pneum.)	VaE 615P	615/348/99	HD GmbH, H. Deisel



*7 layers Bluetooth™ Full RF Test Solution*

*Bluetooth RF Conformance Test System TS8960*

<b>Equipment</b>	<b>Type</b>	<b>Serial No.</b>	<b>Manufacturer</b>
10 MHz Reference	MFS	5489/001	Efratom
Power Meter 832025/059	NRVD	832025/059	Rohde & Schwarz
Power Sensor A 832279/013	NRV-Z1	832279/013	Rohde & Schwarz
Power Sensor B 832279/015	NRV-Z1	832279/015	Rohde & Schwarz
Power Supply	E3632A	MY40003776	Agilent
Power Supply	PS-2403D	-	Conrad
RF Step Attenuator 833695/001	RSP	833695/001	Rohde & Schwarz
Rubidium Frequency Normal	MFS	002	Efratom
Signal Analyzer FSIQ26 832695/007	FSIQ26	832695/007	Rohde & Schwarz
Signal Generator 833680/003	SMP 03	833680/003	Rohde & Schwarz
Signal Generator A 834344/002	SMIQ03B	834344/002	Rohde & Schwarz
Signal Generator B 832870/017	SMIQ03B	832870/017	Rohde & Schwarz
Signal Switching and Conditioning Unit	SSCU	338826/005	Rohde & Schwarz
Signalling Unit PTW60 838312/014	PTW60 for TS8960	838312/014	Rohde & Schwarz
System Controller 829323/008	PSM12	829323/008	Rohde & Schwarz

## 5 Photo Report

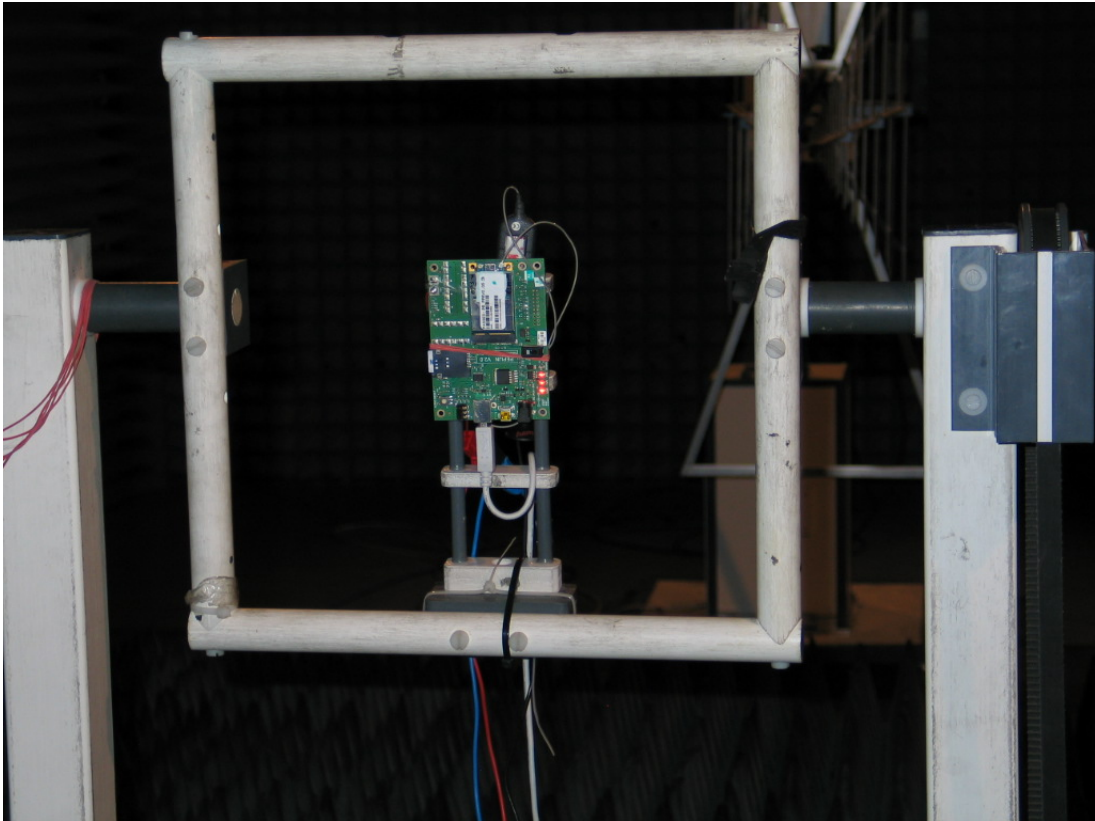

**Photo 1:** EUT (front side)

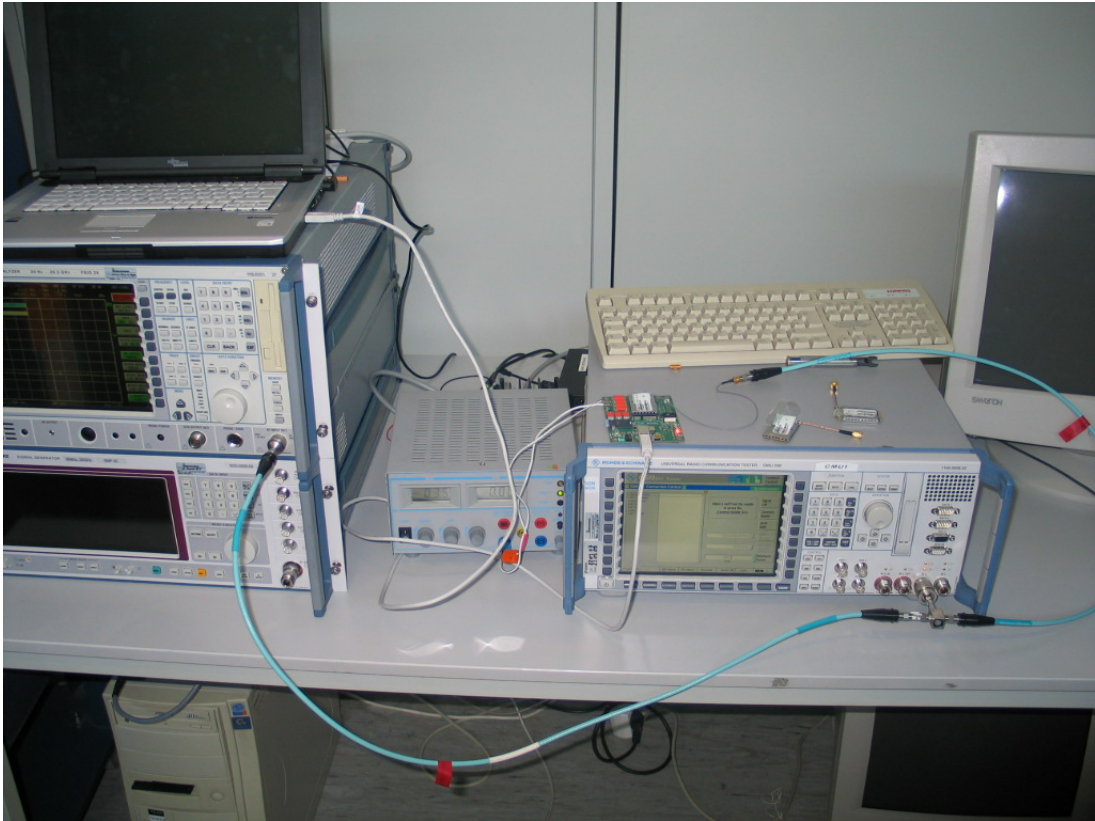



**Photo 2:** EUT (rear side)

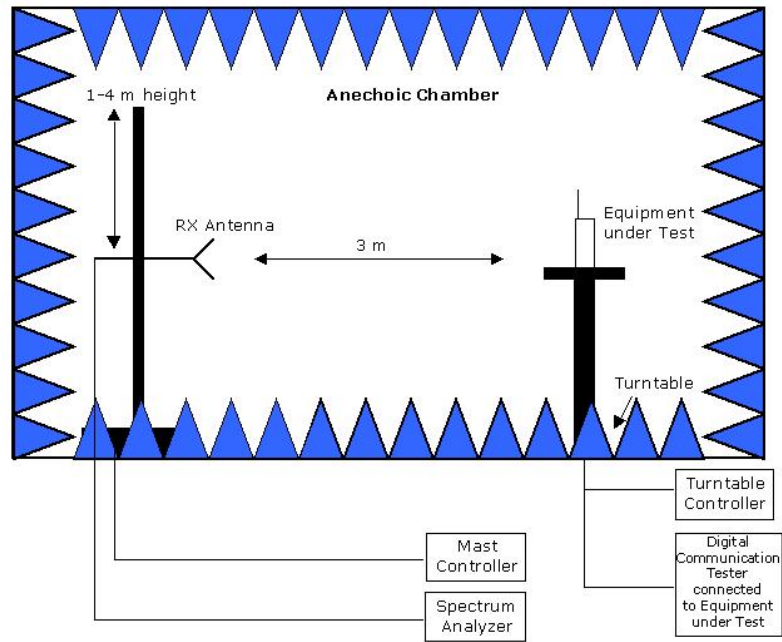

**Photo 3:** Setup for radiated tests



**Photo 4:** Setup for conducted tests

## 6 Setup Drawings



Remark: Depending on the frequency range suitable antenna types, attenuators or preamplifiers are used.

**Drawing 1:** Principle setup for radiated measurements.

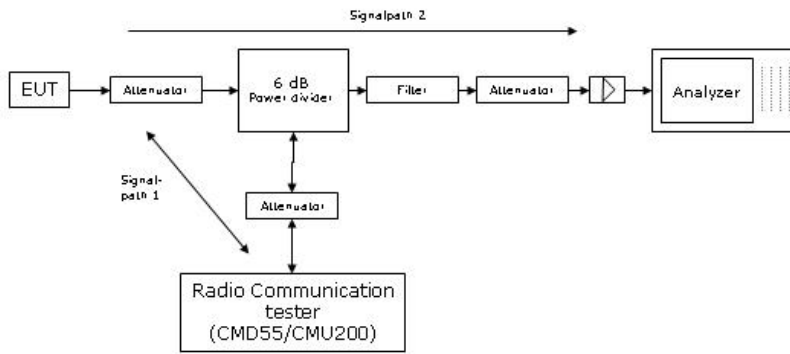

**Remark:** Depending on the frequency range suitable attenuators and/or filters and/or amplifiers are used.

**Drawing 2:** Principle setup for conducted measurements under nominal conditions

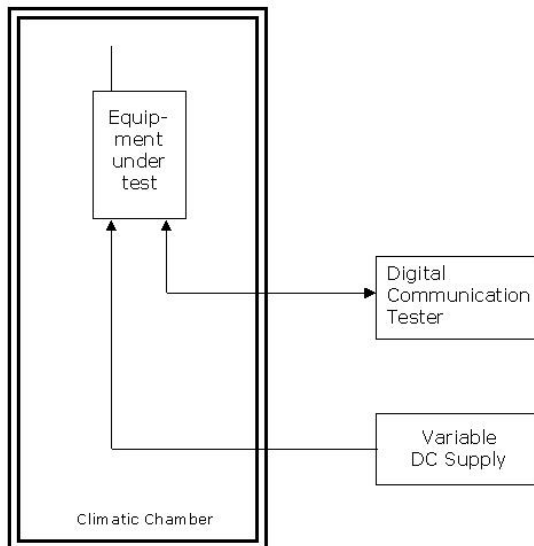

**Drawing 3:** Principle setup for tests under extreme test conditions

## 7 Annex

### Measurement plots Emission and Occupied Bandwidth

#### Op. Mode

op-mode 1

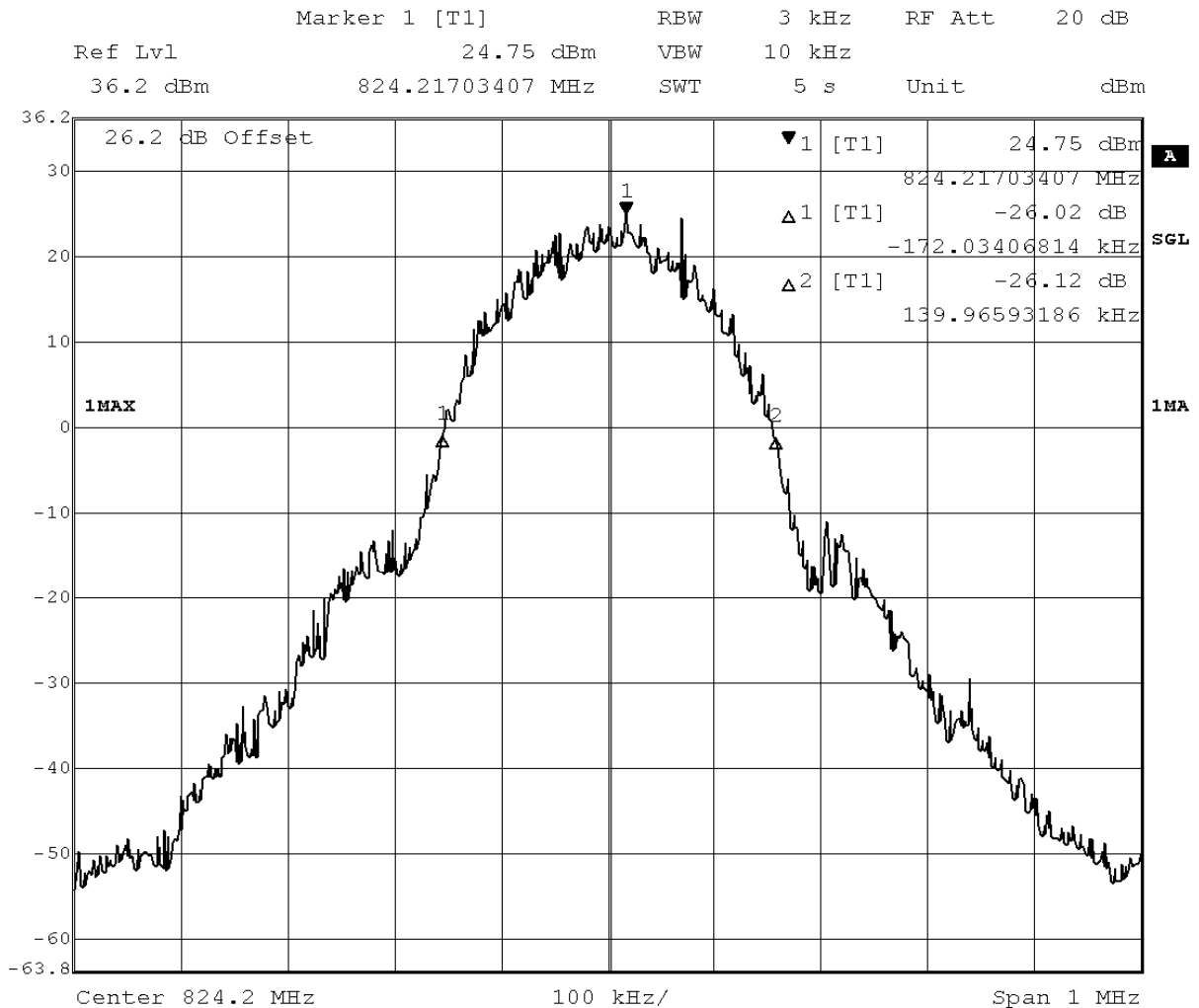

Title: EUT CODE 37410d01

Comment A: GSM data call, 26dB bandwidth, op-mode 1, channel 128 (824.2MHz)

Date: 6.MAY.2008 16:09:26

Test: Emissions bandwidth (26 dB bandwidth), Channel 128 (824.2 MHz)



**Op. Mode**

op-mode 1

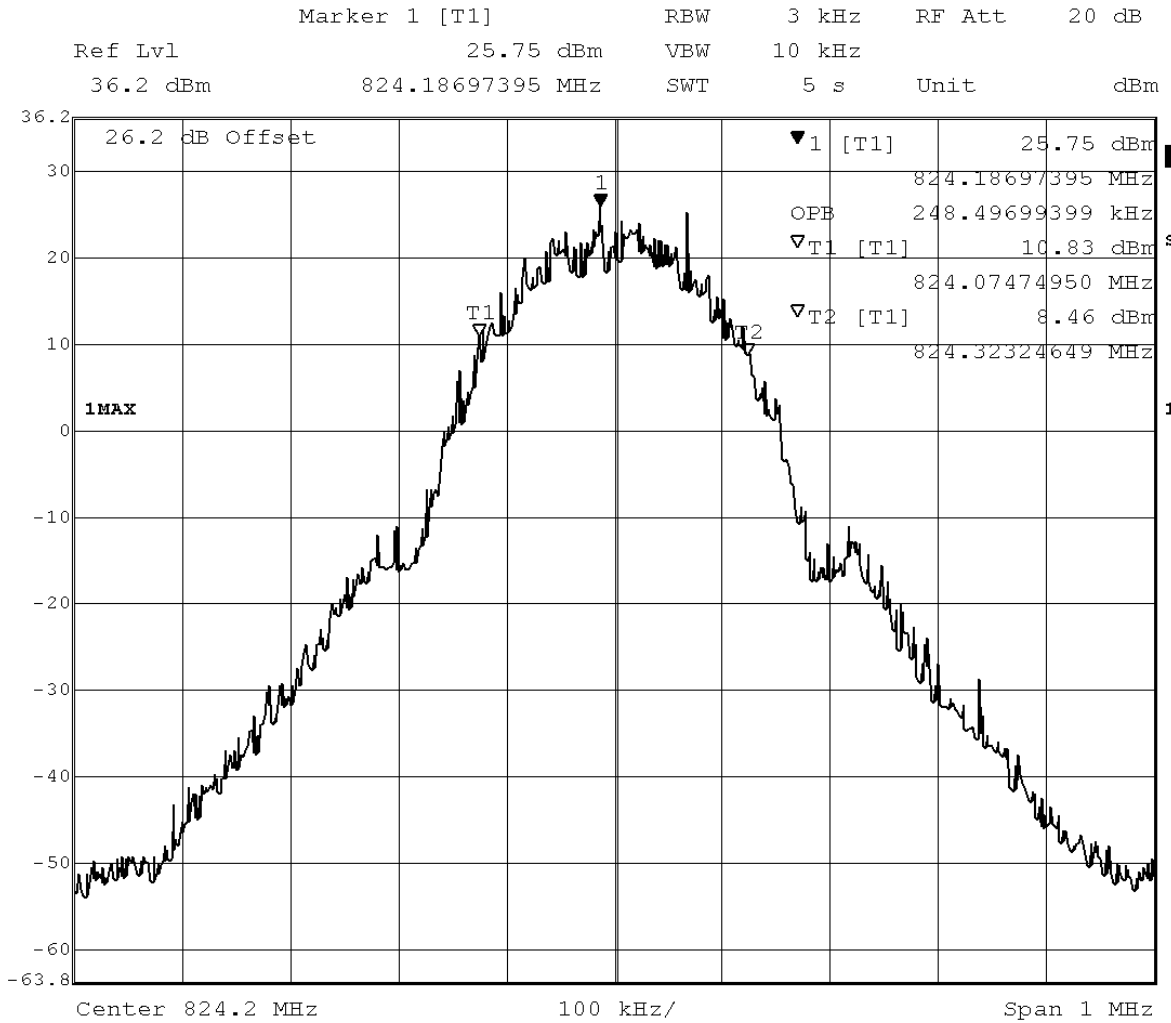

Title: EUT CODE 37410d01  
 Comment A: GSM data call, occupied bandwidth (99%), op-mode 1, channel 128 (824.2MHz)  
 Date: 6.MAY.2008 16:09:48

Test: Occupied bandwidth, Channel 128 (824.2 MHz)

**Op. Mode**

op-mode 2

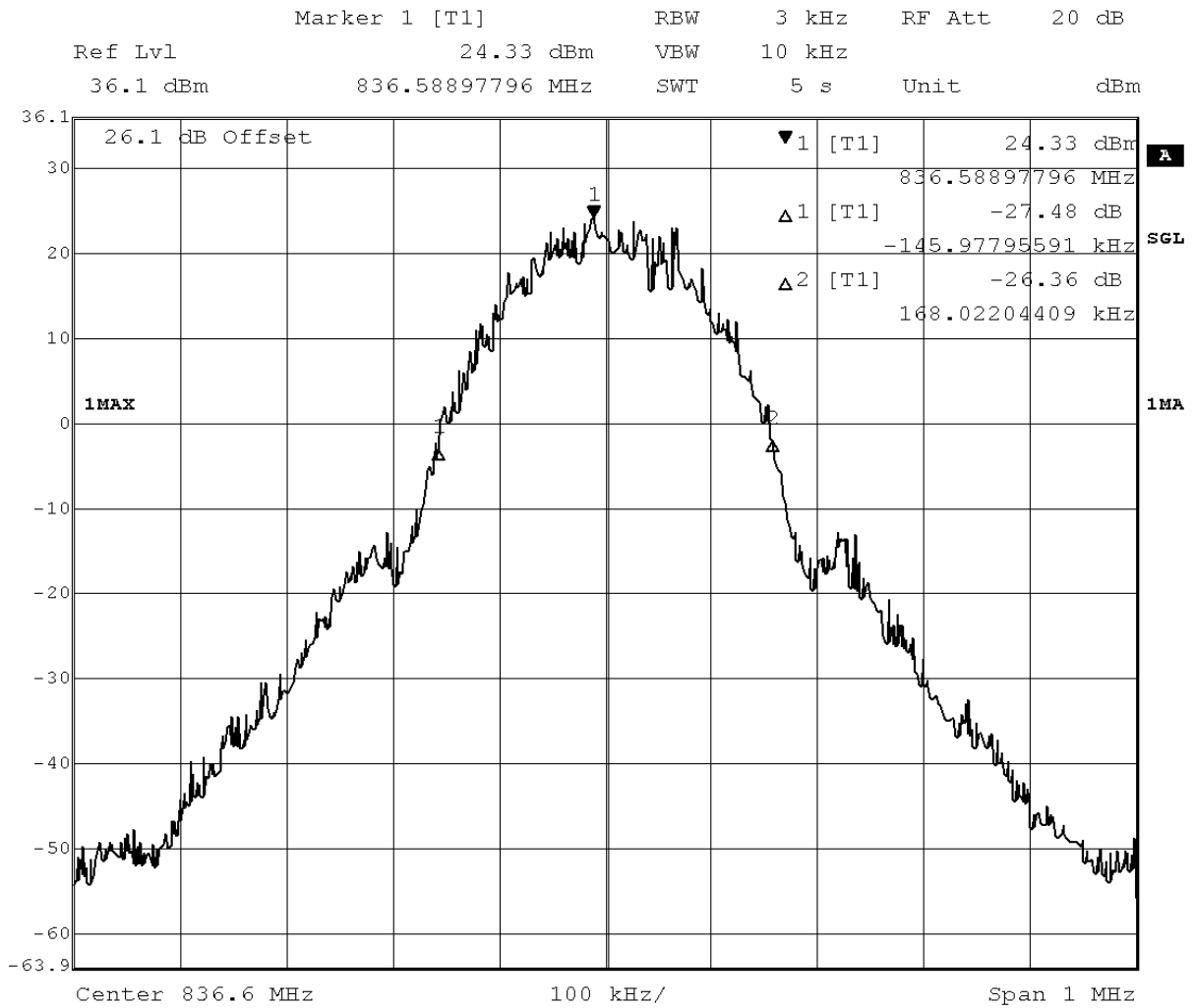

Title: EUT CODE 37410d01  
 Comment A: GSM data call, 26dB bandwidth, op-mode 2, channel 190 (836.6MHz)  
 Date: 6.MAY.2008 16:43:57

Test: Emissions bandwidth (26 dB bandwidth), Channel 190 (836.6 MHz)



## Op. Mode

op-mode 2

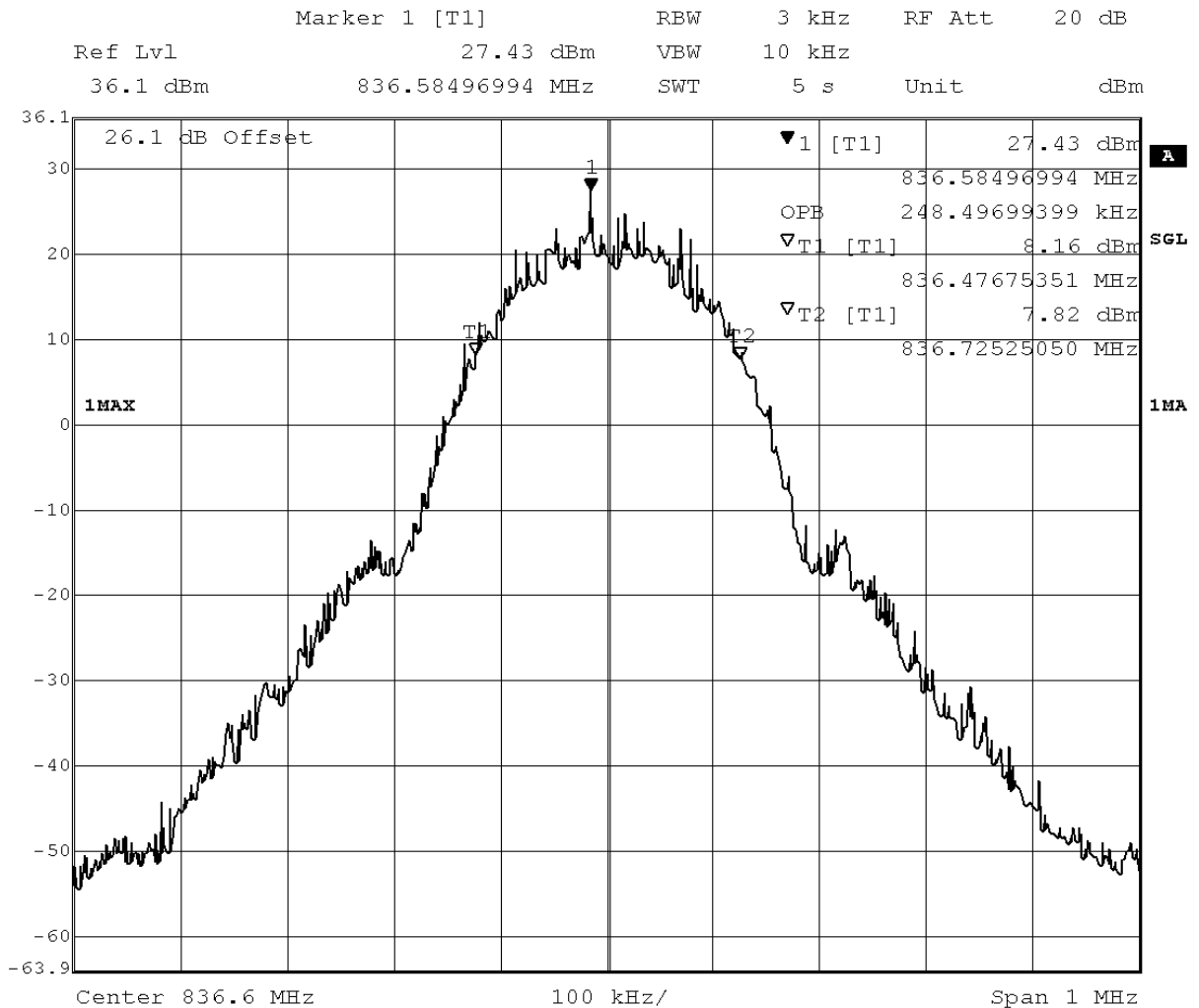

Title: EUT CODE 37410d01

Comment A: GSM data call, occupied bandwidth (99%), op-mode 2, channel 190 (836.6MHz)

Date: 6.MAY.2008 16:44:19

Test: Occupied bandwidth, Channel 190 (836.6 MHz)

### Op. Mode

op-mode 3

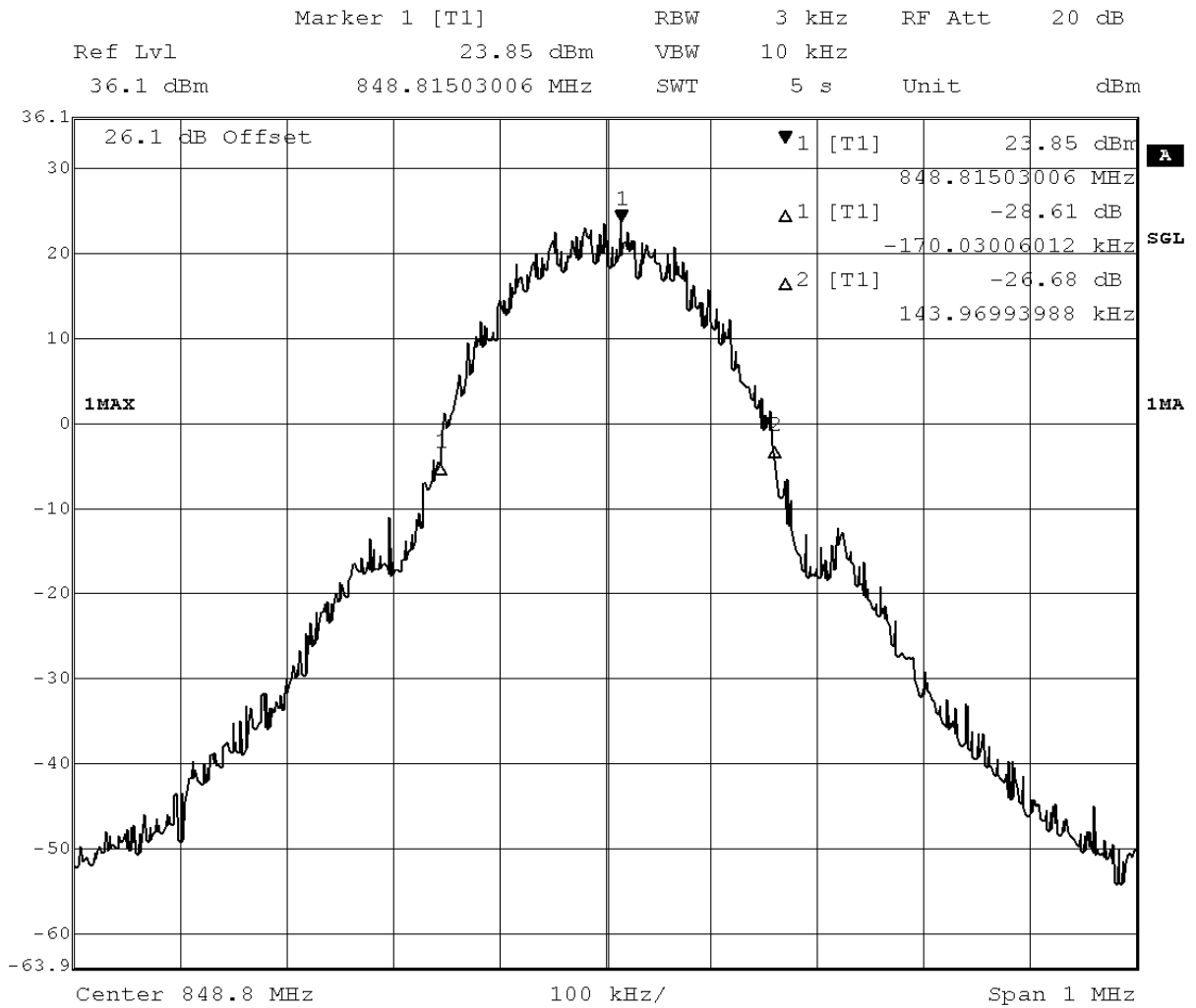

Title: EUT CODE 37410d01  
 Comment A: GSM data call, 26dB bandwidth, op-mode 3, channel 251 (848.8MHz)  
 Date: 6.MAY.2008 16:58:49

Test: Emissions bandwidth (26 dB bandwidth), Channel 251 (848.8 MHz)

**Op. Mode**

op-mode 3

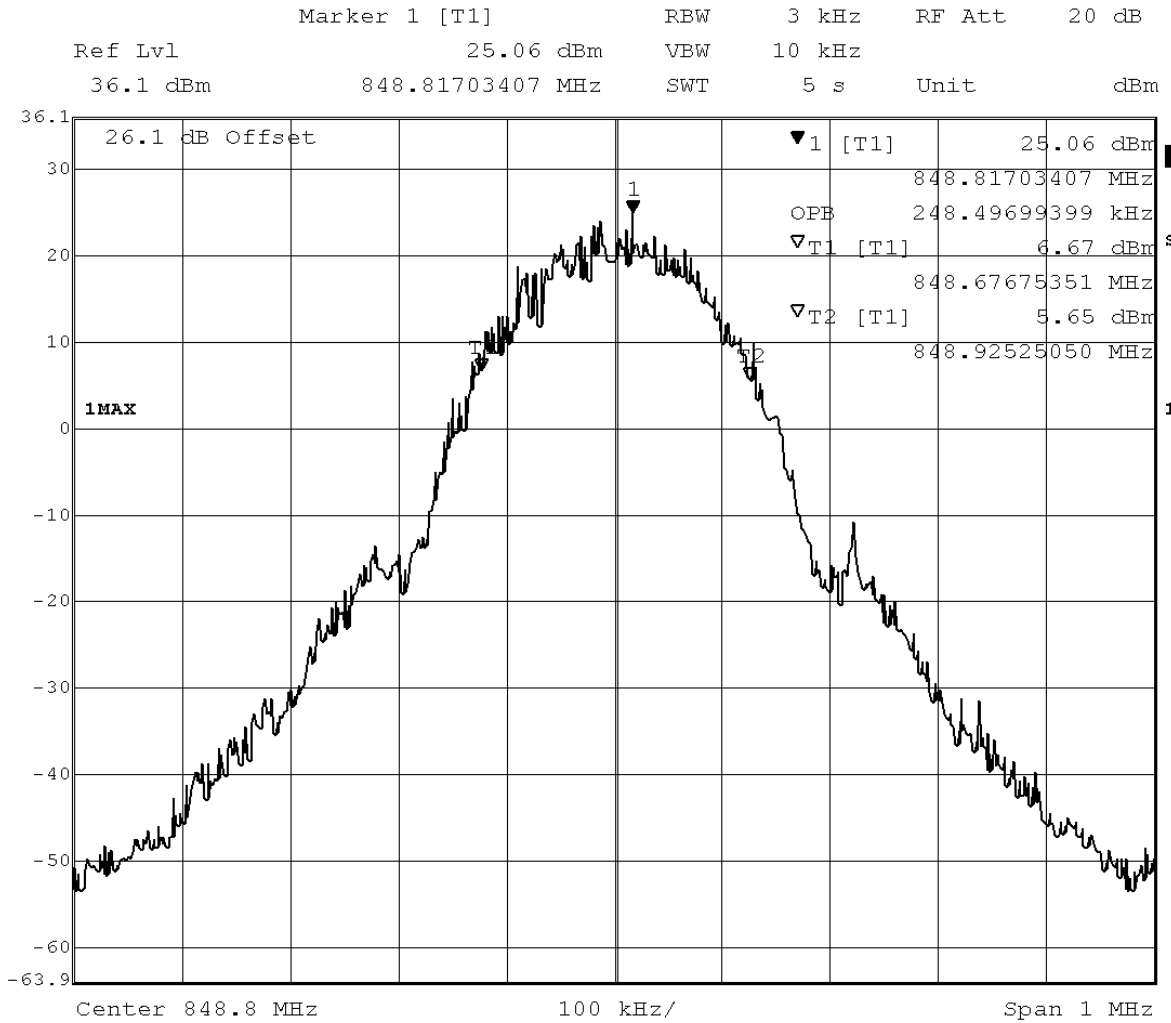

Title: EUT CODE 37410d01  
 Comment A: GSM data call, occupied bandwidth (99%), op-mode 3, channel 251 (848.8MHz)  
 Date: 6.MAY.2008 16:59:10

Test: Occupied bandwidth, Channel 251 (848.8 MHz)



**Op. Mode**

op-mode 4

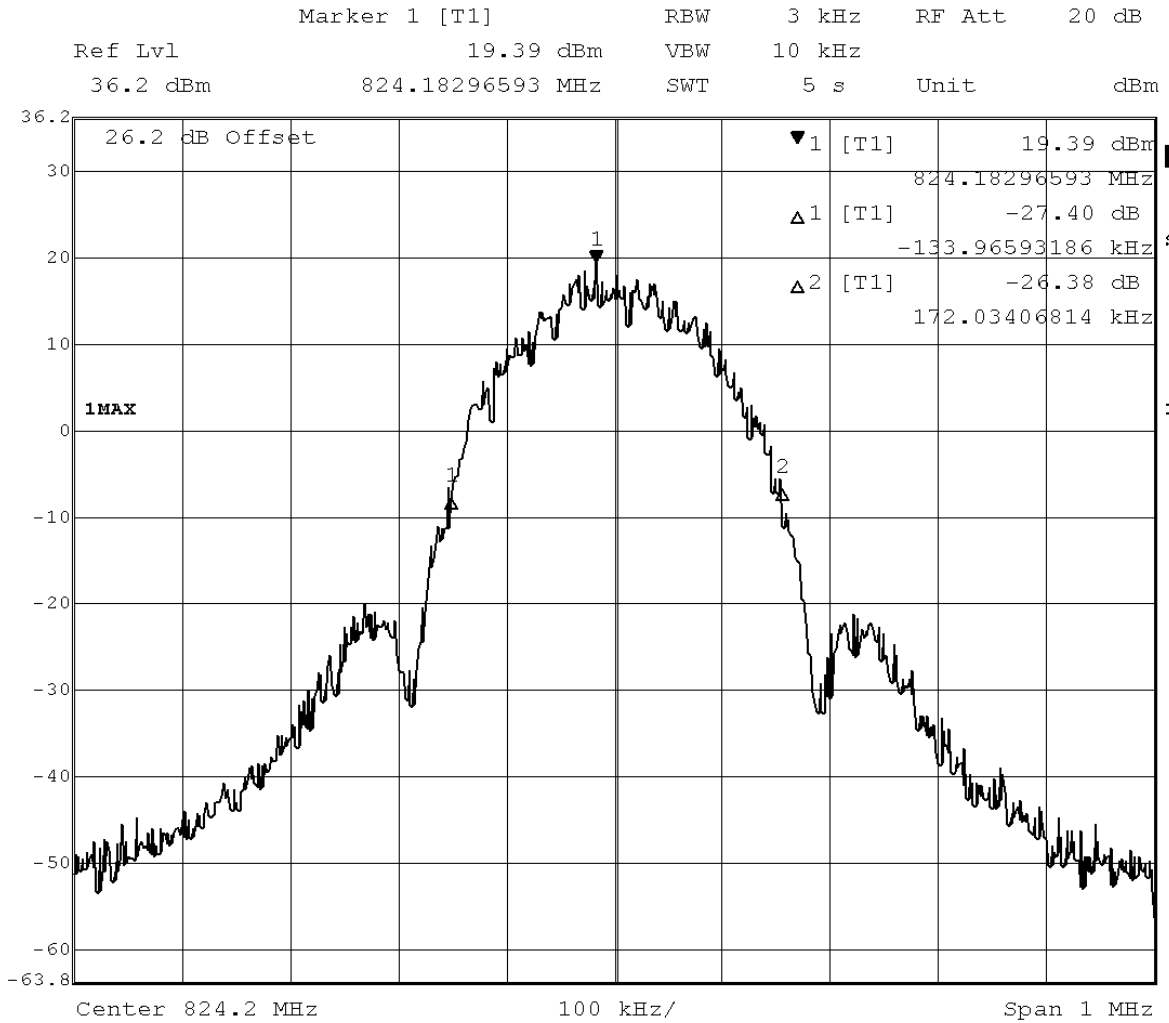

Title: EUT CODE 37410d01  
 Comment A: EDGE data call, 26dB bandwidth, op-mode 4,  
 channel 128 (824.2MHz)  
 Date: 6.MAY.2008 17:39:26

Test: Emissions bandwidth (26 dB bandwidth), Channel 128 (824.2 MHz)

### Op. Mode

op-mode 4

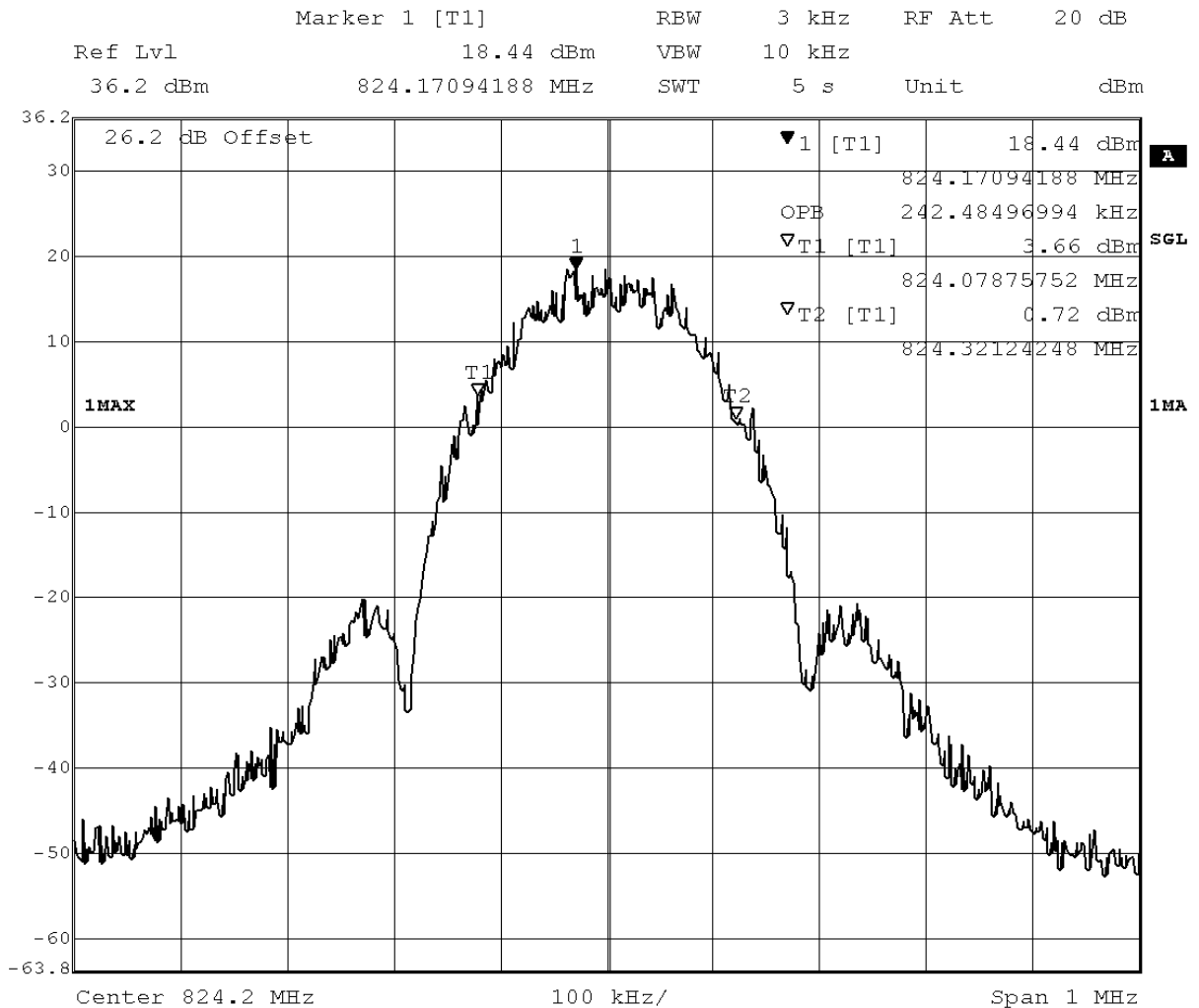

Title: EUT CODE 37410d01  
 Comment A: EDGE data call, occupied bandwidth (99%), op-mode 4,  
 channel 128 (824.2MHz)  
 Date: 6.MAY.2008 17:39:47

Test: Occupied bandwidth, Channel 128 (824.2 MHz)

### Op. Mode

op-mode 5

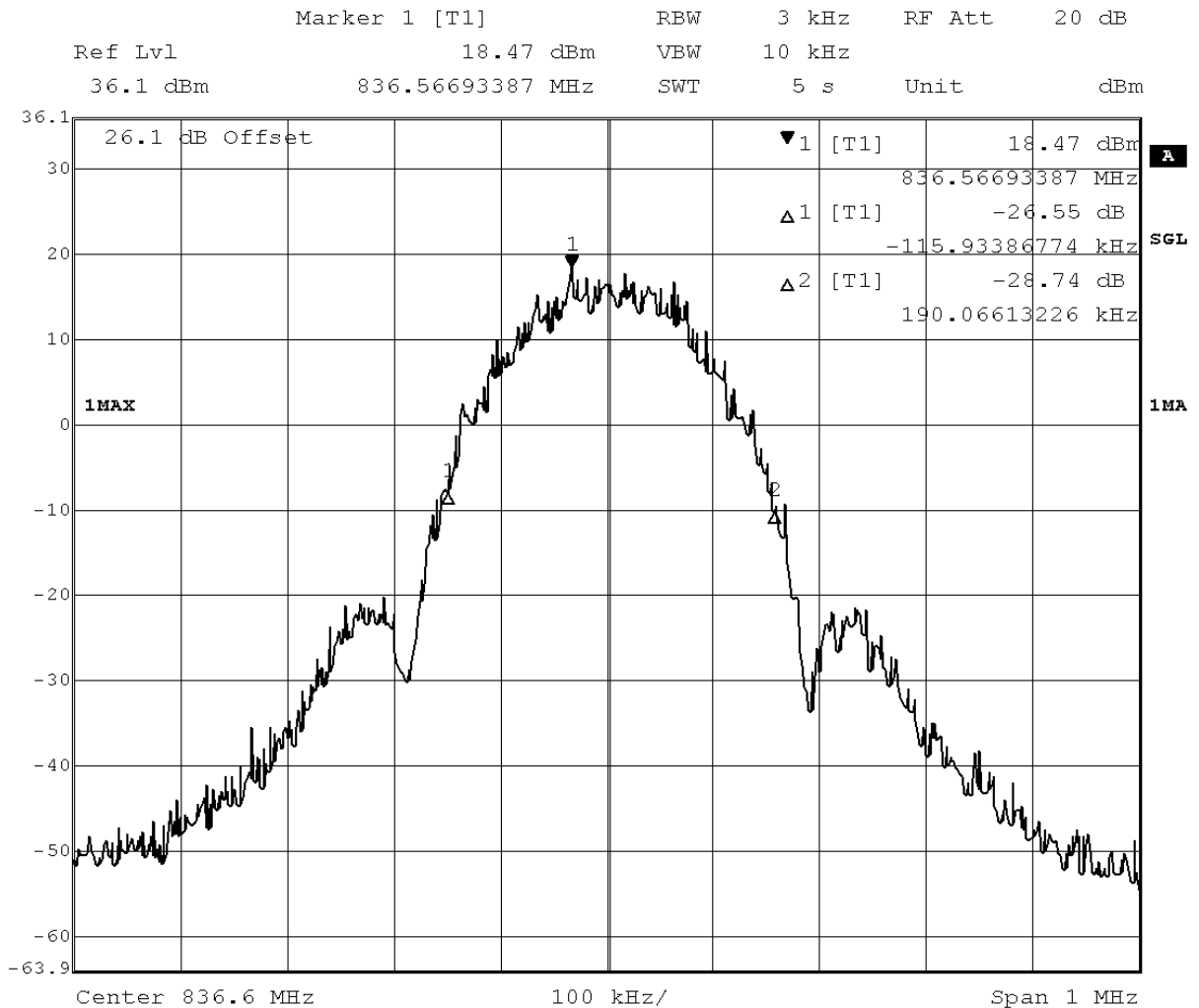

Title: EUT CODE 37410d01  
 Comment A: EDGE data call, 26dB bandwidth, op-mode 2,  
 channel 190 (836.6MHz)  
 Date: 6.MAY.2008 17:56:51

Test: Emissions bandwidth (26 dB bandwidth), Channel 190 (836.6 MHz)



**Op. Mode**

op-mode 5

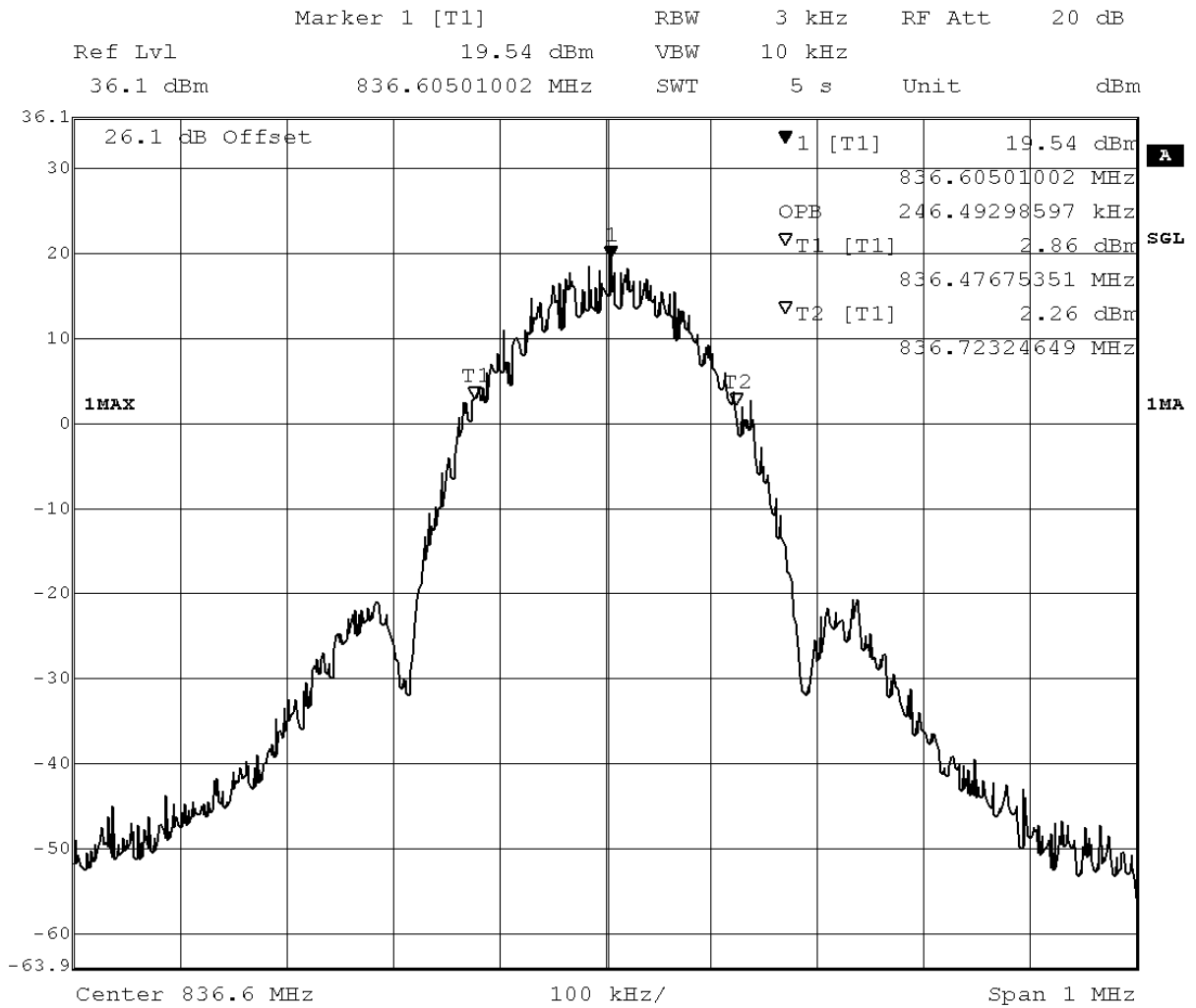

Title: EUT CODE 37410d01  
 Comment A: EDGE data call, occupied bandwidth (99%), op-mode 2,  
 channel 190 (836.6MHz)  
 Date: 6.MAY.2008 17:57:12

Test: Occupied bandwidth, Channel 190 (836.6 MHz)



**Op. Mode**

op-mode 6

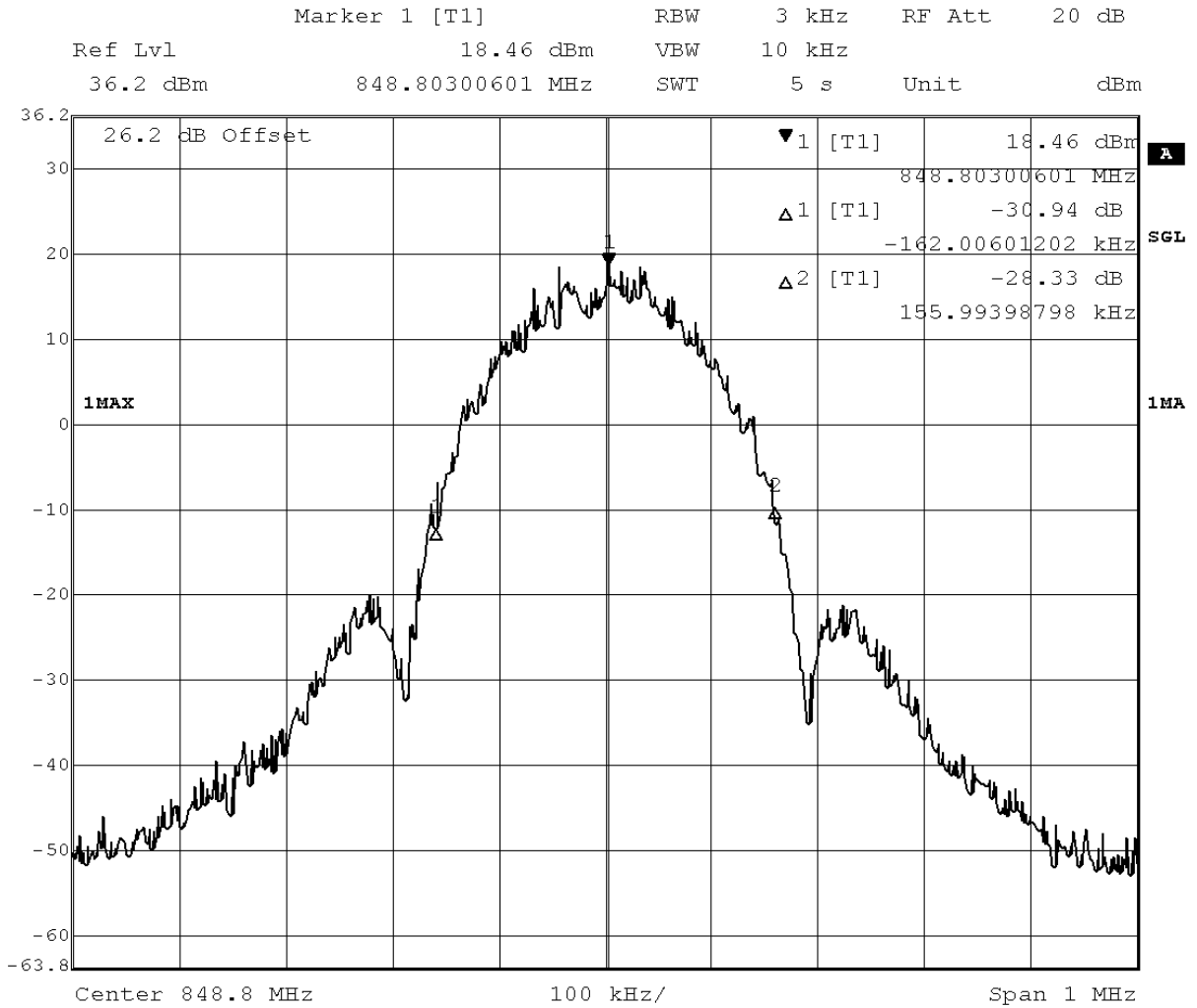

Title: EUT CODE 37410d01  
 Comment A: EDGE data call, 26dB bandwidth, op-mode 6, channel 251 (848.8MHz)  
 Date: 6.MAY.2008 18:12:25

Test: Emissions bandwidth (26 dB bandwidth), Channel 251 (848.8 MHz)





**Op. Mode**

op-mode 6

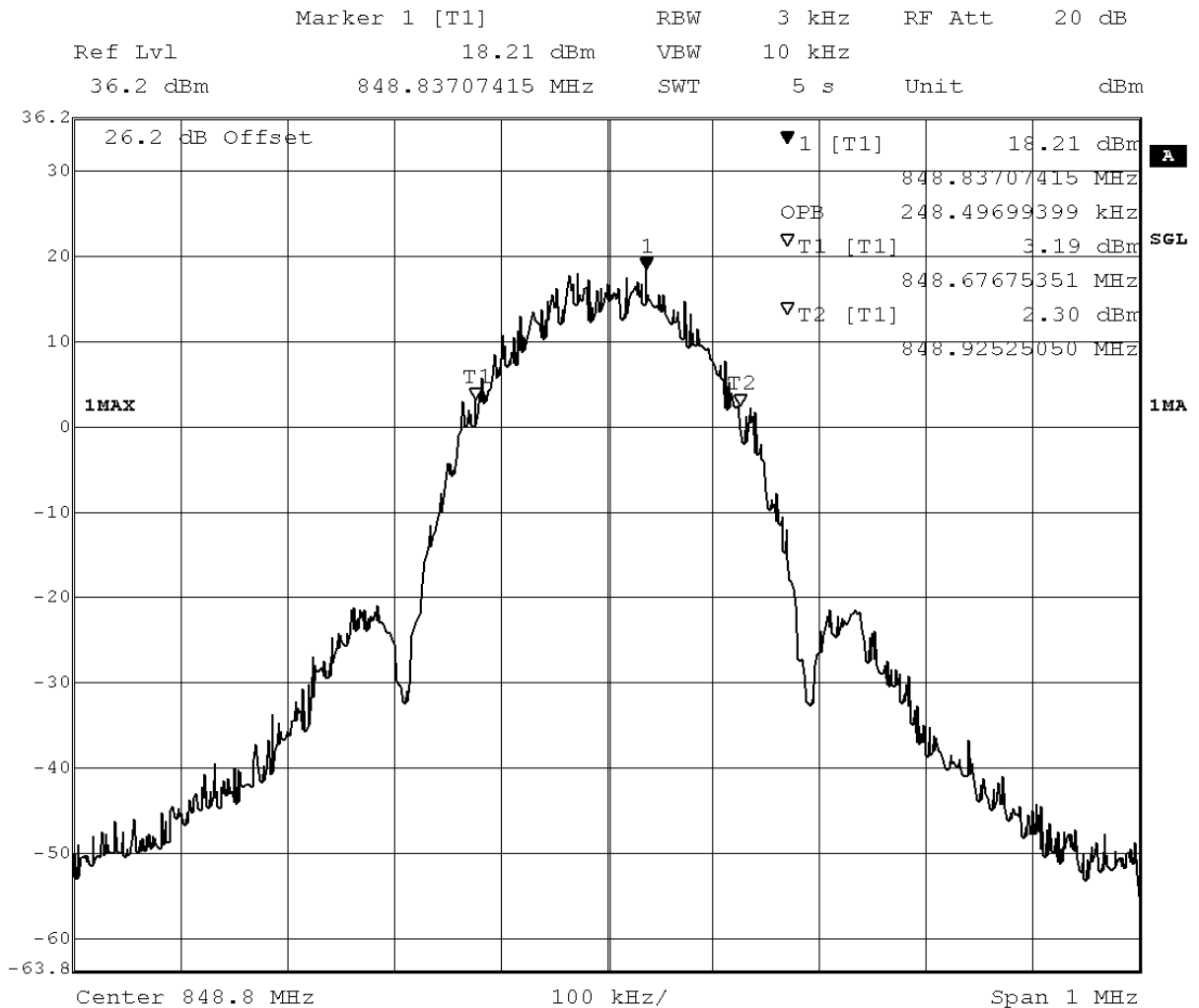

Title: EUT CODE 37410d01  
 Comment A: EDGE data call, occupied bandwidth (99%), op-mode 6, channel 251 (848.8MHz)  
 Date: 6.MAY.2008 18:12:46

Test: Occupied bandwidth, Channel 251 (848.8 MHz)



**Op. Mode**

op-mode 7

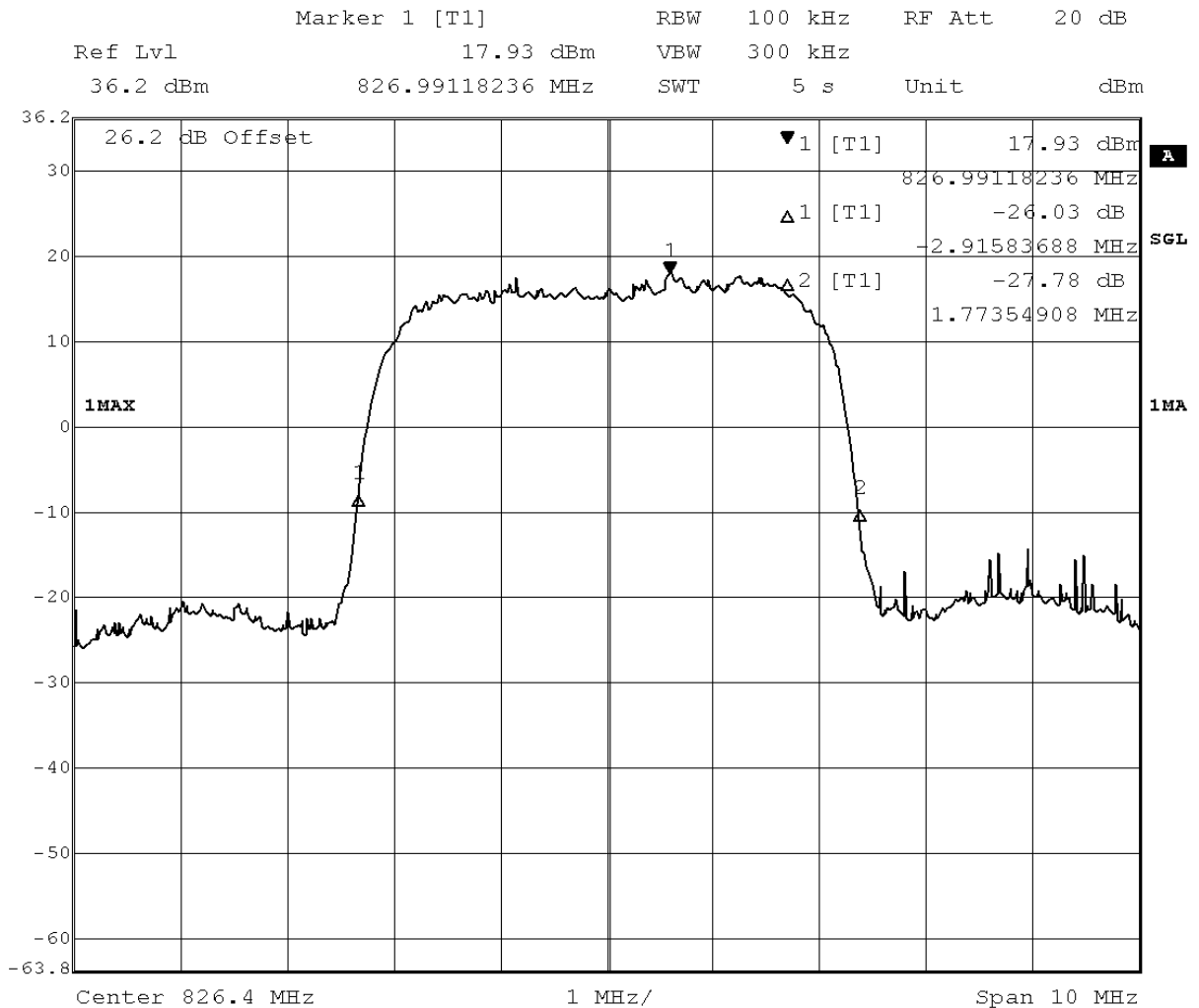

Title: EUT CODE 37410d01  
 Comment A: FDD V data call, 26dB bandwidth, op-mode 7, channel 4132 (826.4MHz)  
 Date: 6.MAY.2008 18:59:47

Test: Emissions bandwidth (26 dB bandwidth), Channel 4132 (826.4 MHz)



**Op. Mode**

op-mode 7

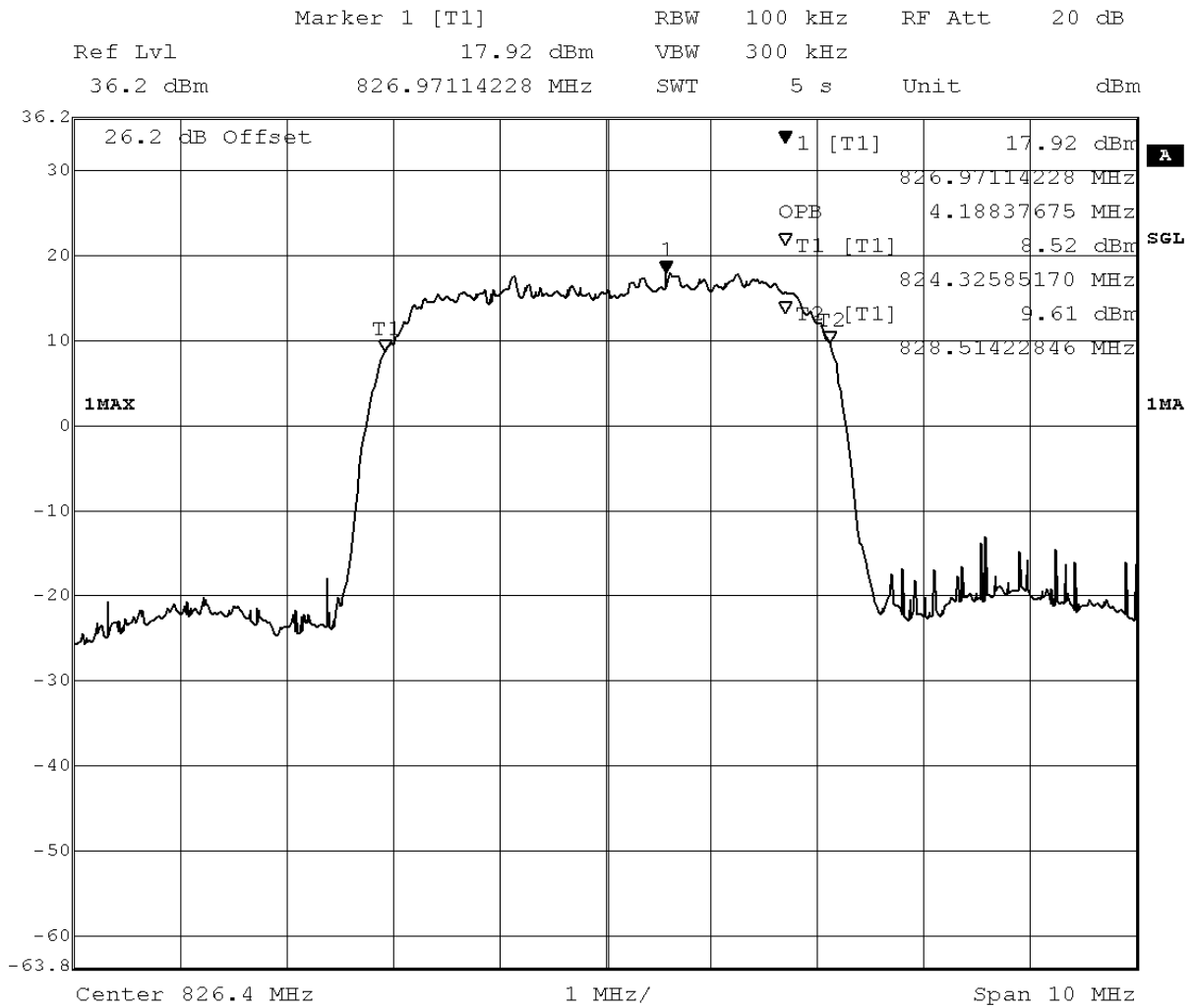

Title: EUT CODE 37410d01  
 Comment A: FDD V data call, occupied bandwidth (99%), op-mode 7, channel 4132 (826.4MHz)  
 Date: 6.MAY.2008 19:00:08

Test: Occupied bandwidth, Channel 4132 (826.4 MHz)



**Op. Mode**

op-mode 8

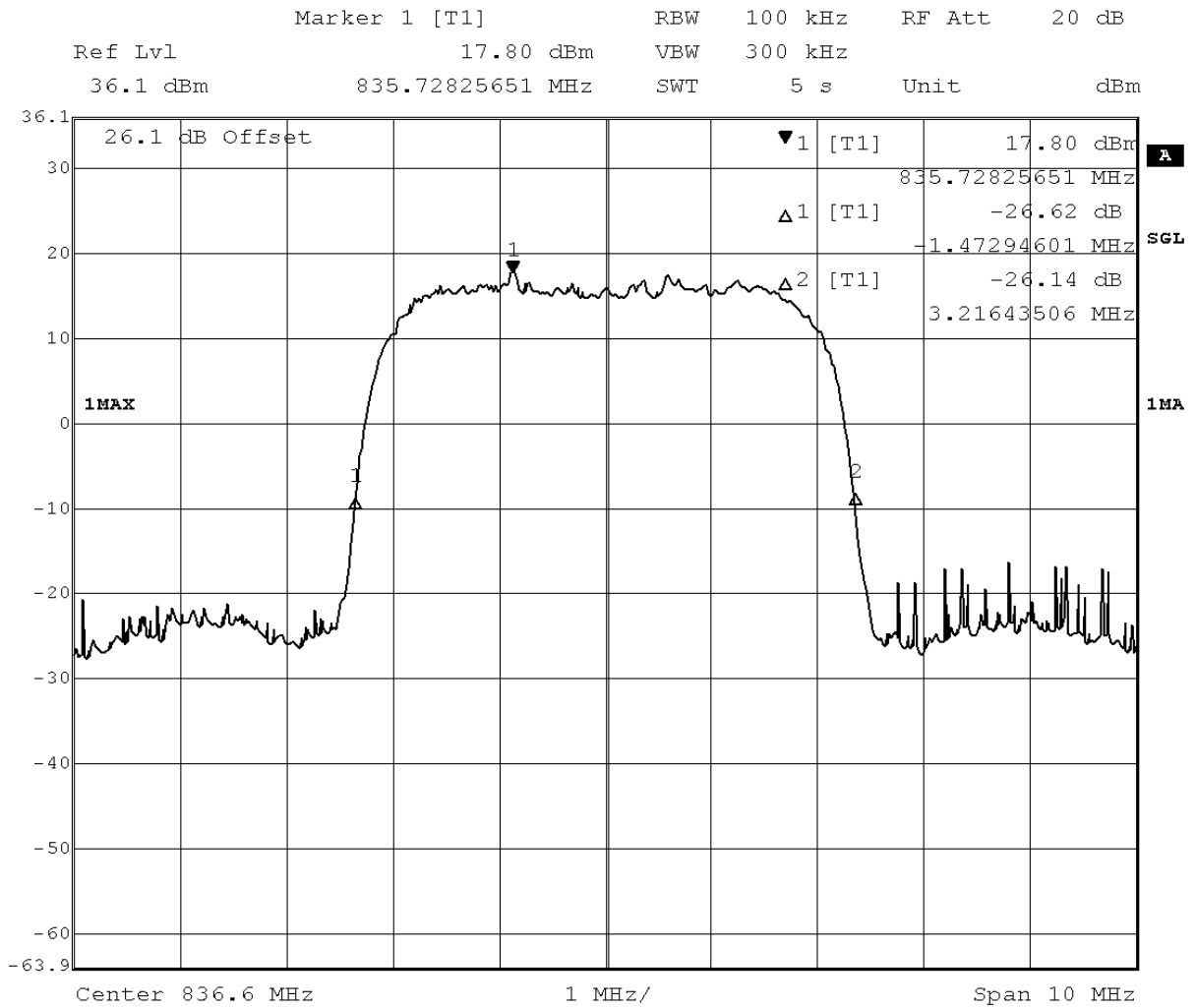

Title: EUT CODE 37410d01  
 Comment A: FDD V data call, 26dB bandwidth, op-mode 8,  
 channel 4183 (836.6MHz)  
 Date: 6.MAY.2008 19:28:48

Test: Emissions bandwidth (26 dB bandwidth), Channel 4183 (836.6 MHz)



**Op. Mode**

op-mode 8

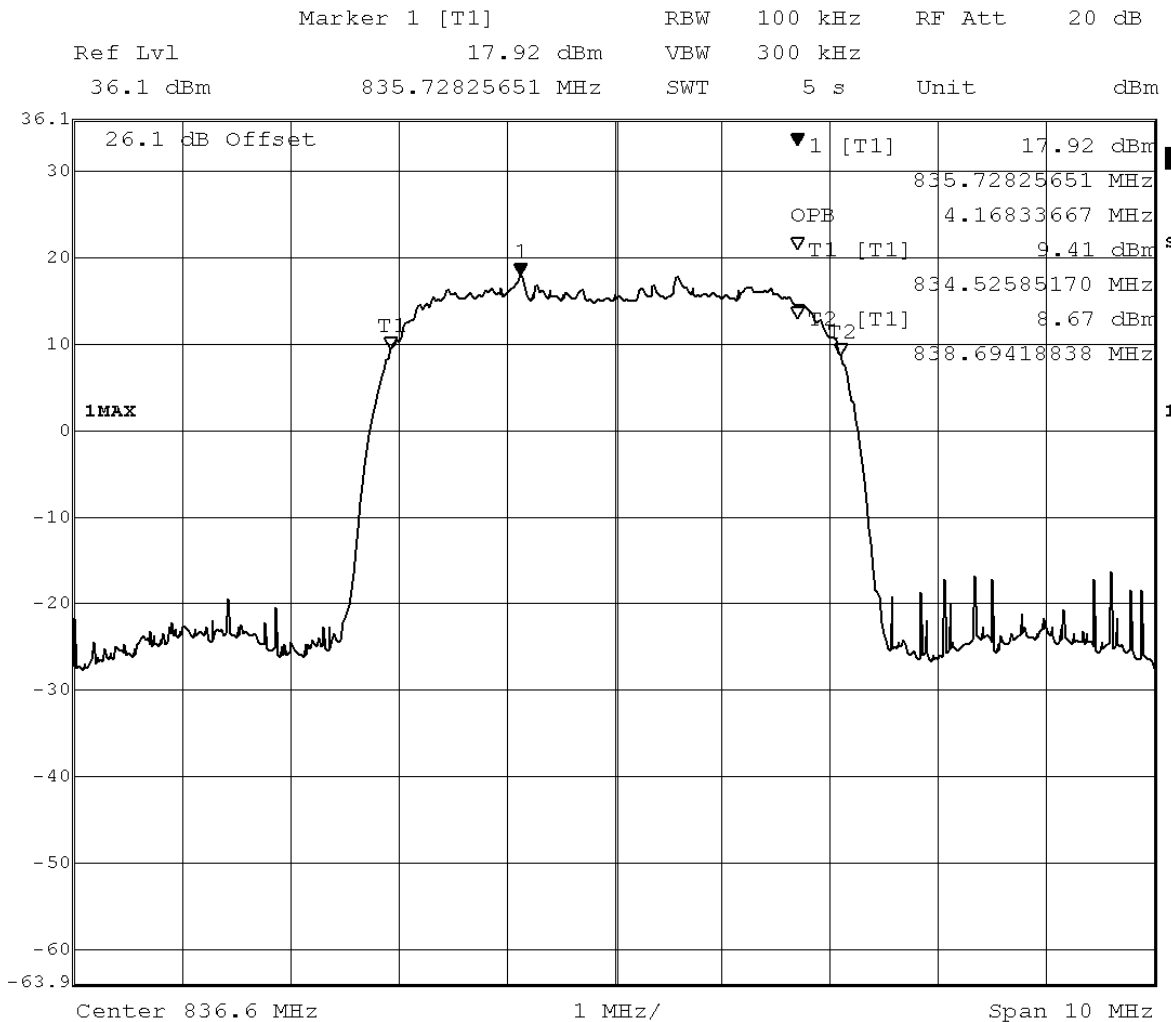

Title: EUT CODE 37410d01  
 Comment A: FDD V data call, occupied bandwidth (99%), op-mode 8, channel 4183 (836.6MHz)  
 Date: 6.MAY.2008 19:29:09

Test: Occupied bandwidth, Channel 4183 (836.6 MHz)



**Op. Mode**

op-mode 9

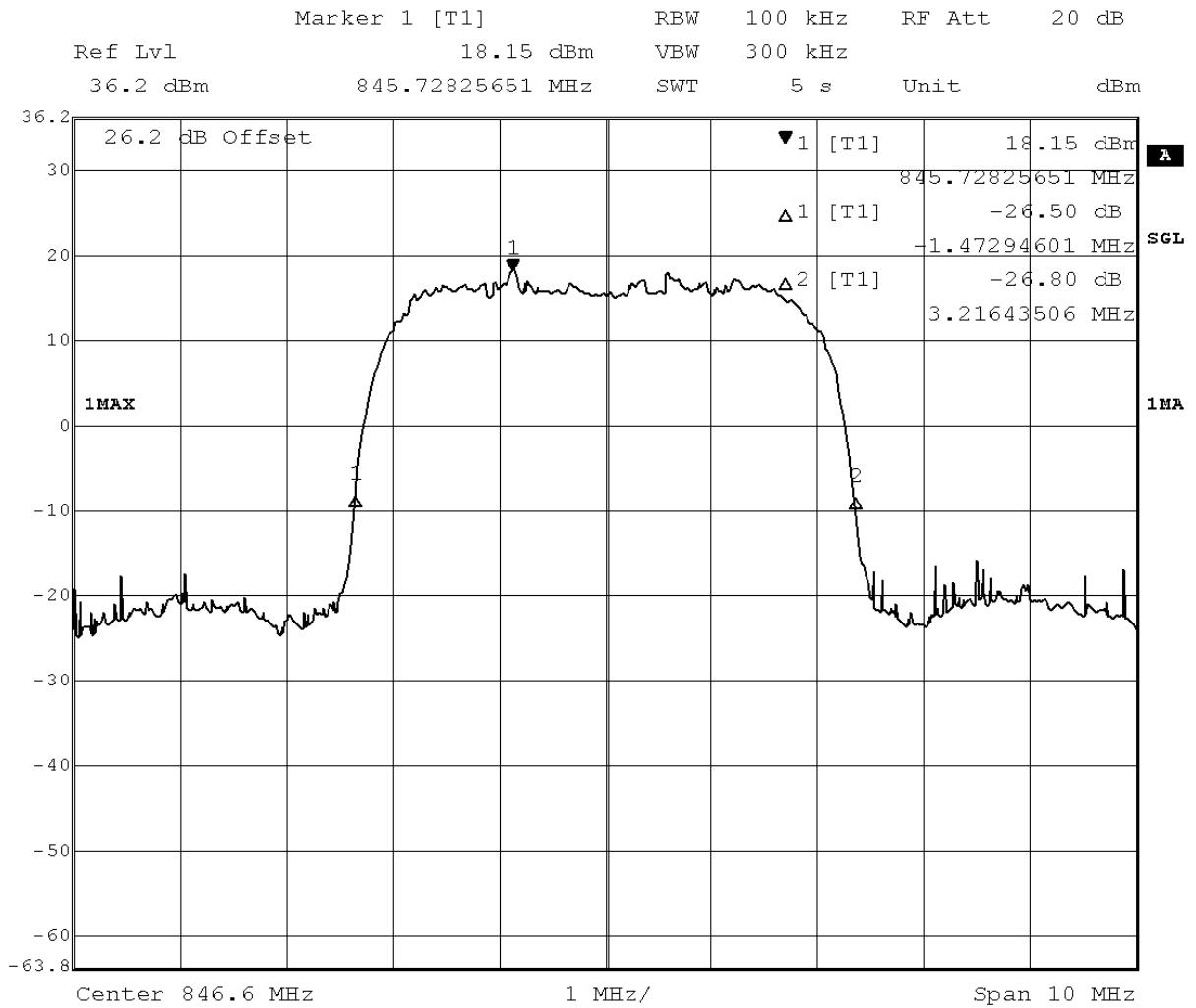

Title: EUT CODE 37410d01  
 Comment A: FDD V data call, 26dB bandwidth, op-mode 9, channel 4233 (846.6MHz)  
 Date: 6.MAY.2008 19:40:52

Test: Emissions bandwidth (26 dB bandwidth), Channel 4233 (846.6 MHz)



**Op. Mode**

op-mode 9

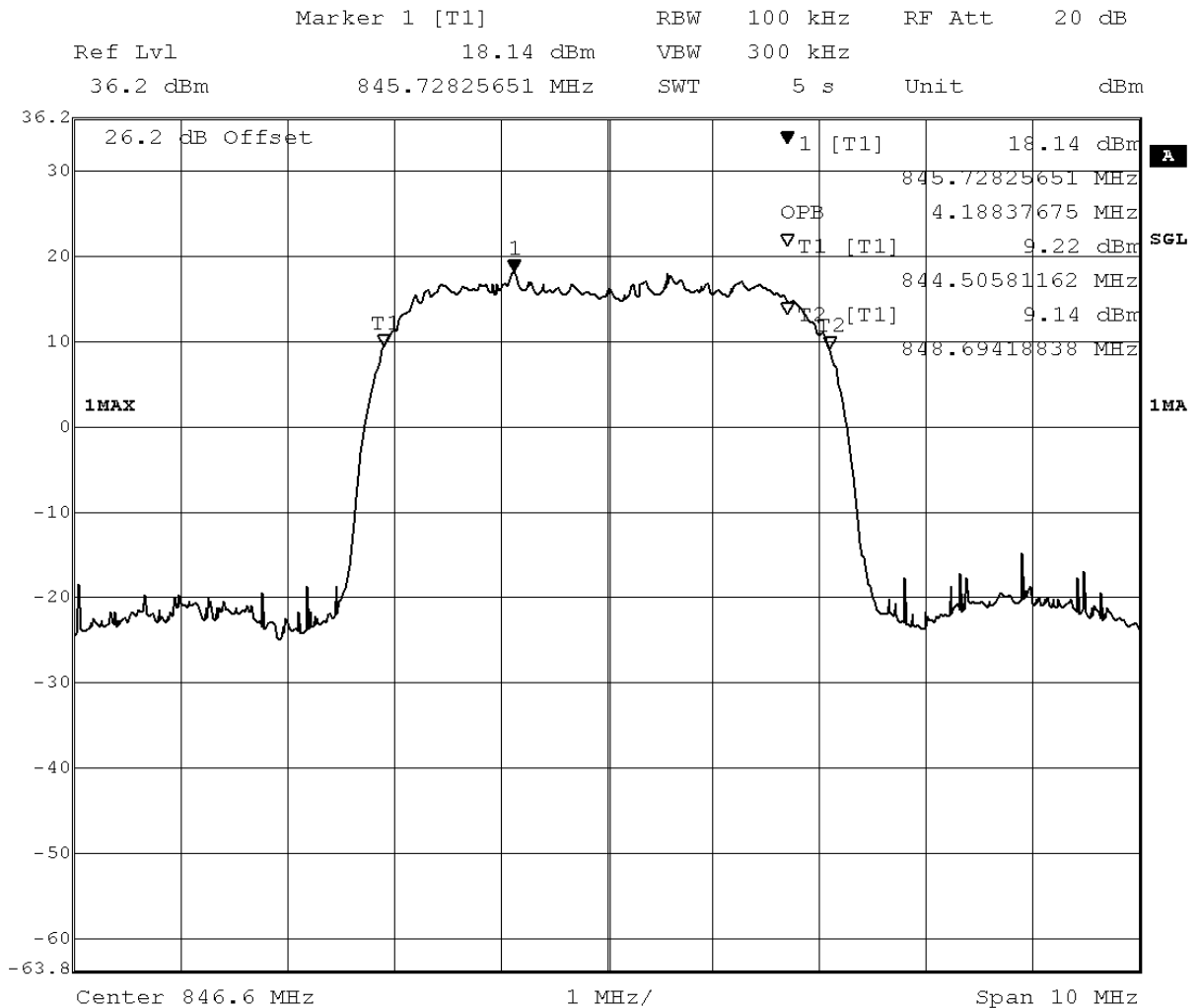

Title: EUT CODE 37410d01  
 Comment A: FDD V data call, occupied bandwidth (99%), op-mode 9, channel 4233 (846.6MHz)  
 Date: 6.MAY.2008 19:41:13

Test: Occupied bandwidth, Channel 4233 (846.6 MHz)

## Measurement plots Band edge compliance

### Op. Mode

op-mode 1

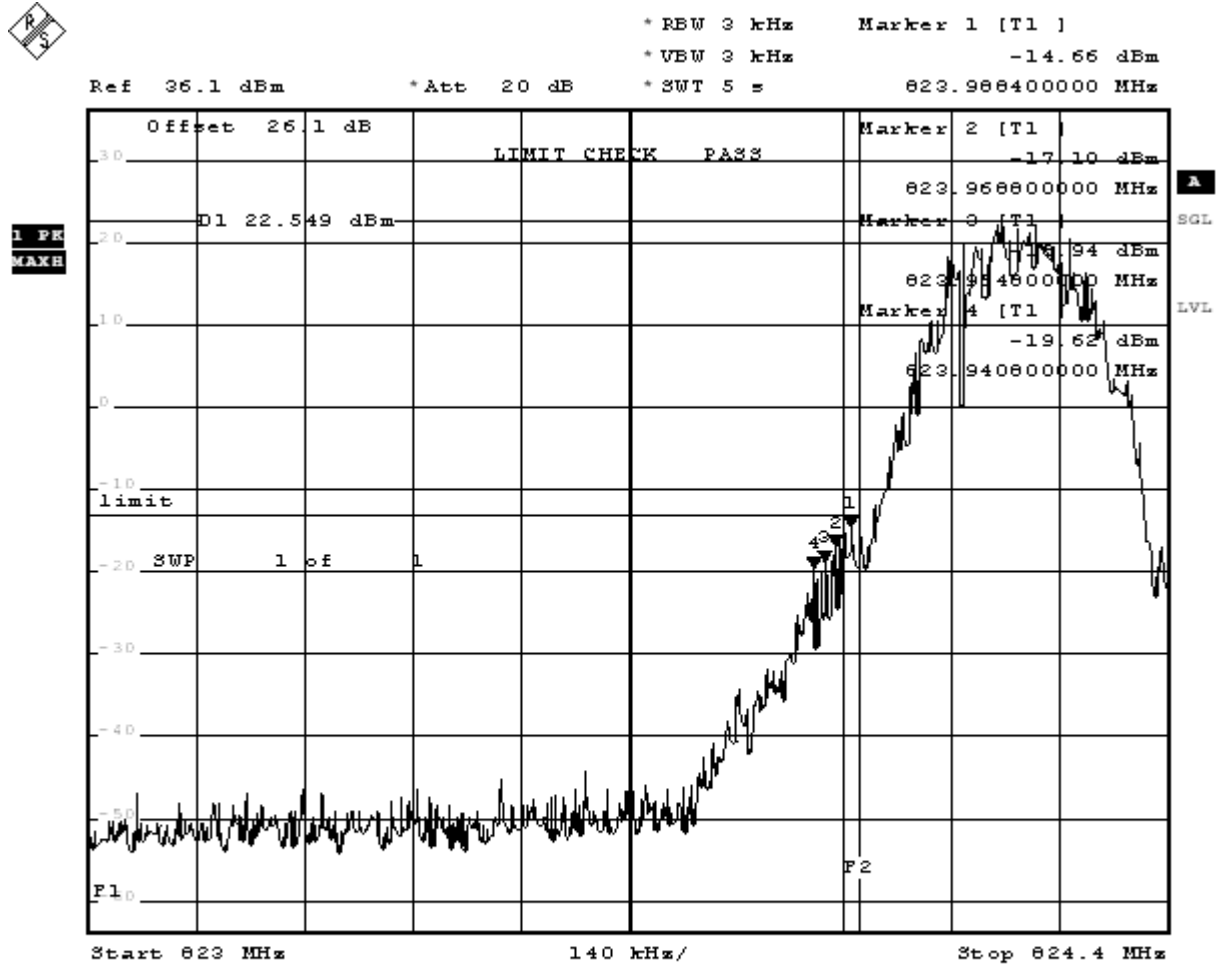

Comment: EUT code 37410h02, GSM call, band edge compliance, op-mode

Comment: channel 128 (824.2MHz)

Date: 25.JUN.2006 12:41:07

Test: band edge compliance , Channel 128, GSM



**Op. Mode**

op-mode 4

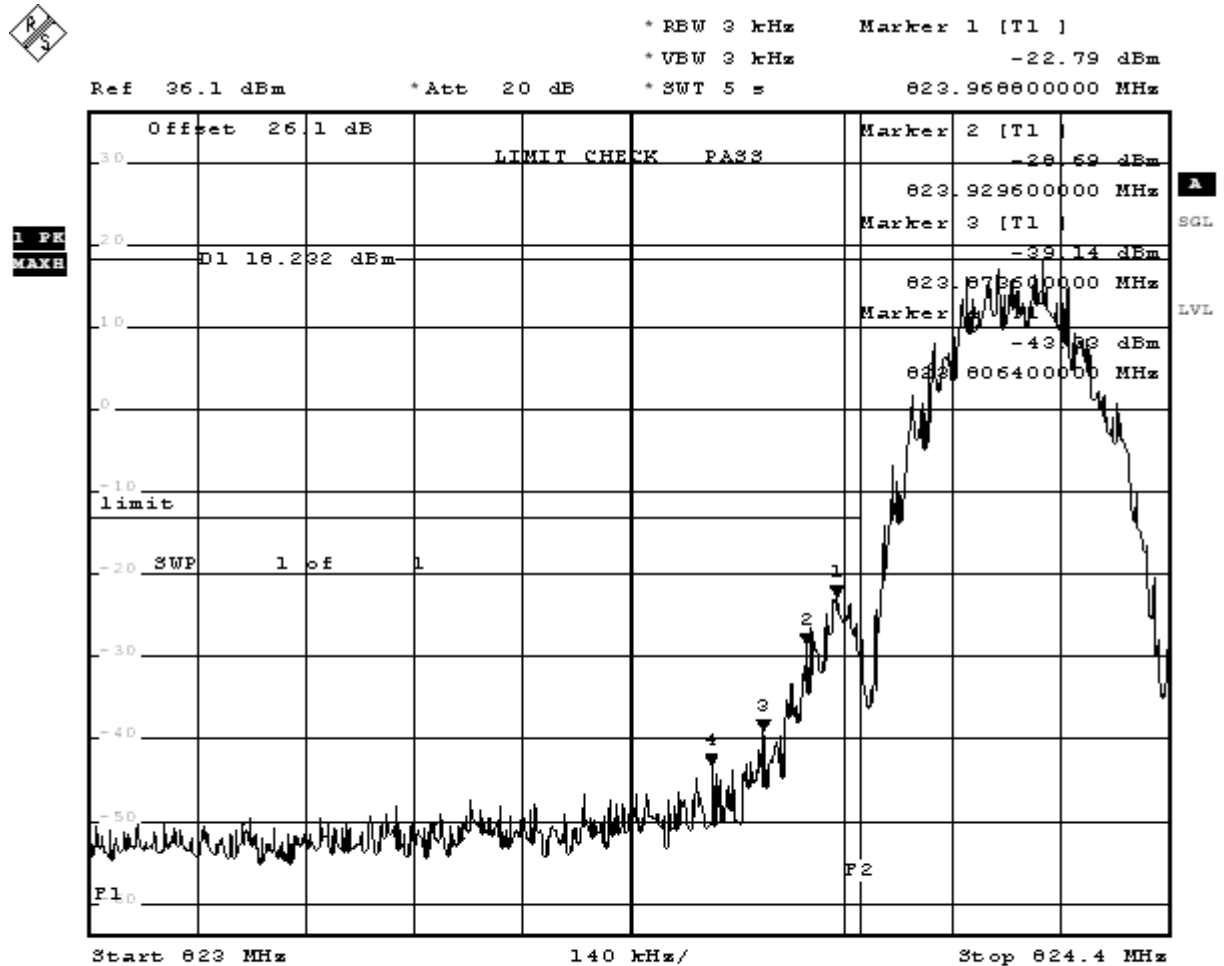

Comment: EUT code 37410h02, EDGE data call, band edge compliance, op  
 Comment: channel 128 (824.2MHz)  
 Date: 25.JUN.2008 12:50:00

Test: band edge compliance , Channel 128, EDGE



**Op. Mode**

op-mode 7

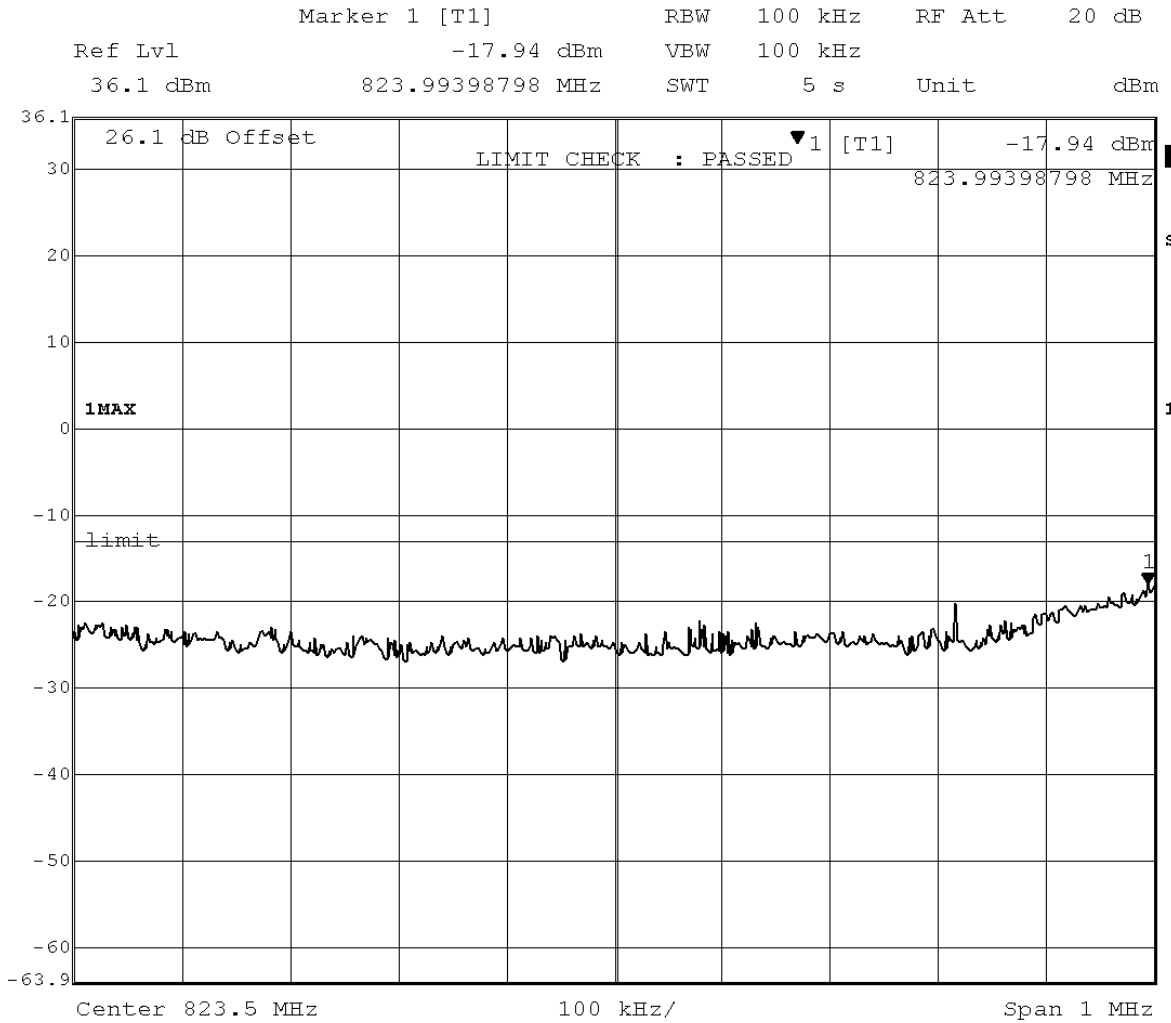

Title: EUT CODE 37410d01  
 Comment A: FDD V data call, band edge compliance, op-mode 7, channel 4132 (826.4MHz)  
 Date: 6.MAY.2008 19:00:36

Test: band edge compliance , Channel 4132, FDD V

### Op. Mode

op-mode 3

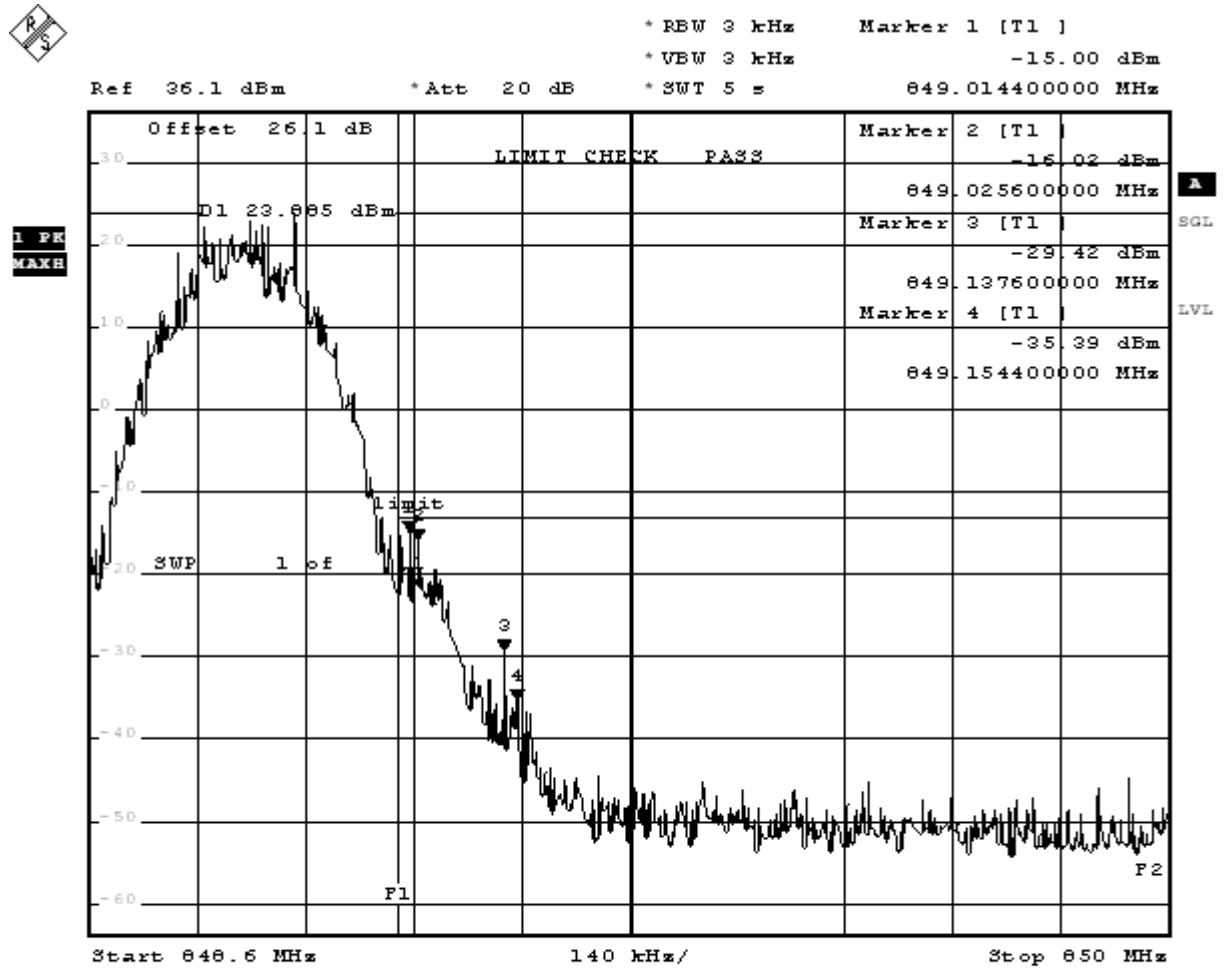

Comment: EUT code 37410h02, GSM call, band edge compliance, op-mode  
 Comment: channel 251 (848.6MHz)  
 Date: 25.JUN.2008 12:42:50

Test: band edge compliance , Channel 251, GSM

### Op. Mode

op-mode 6

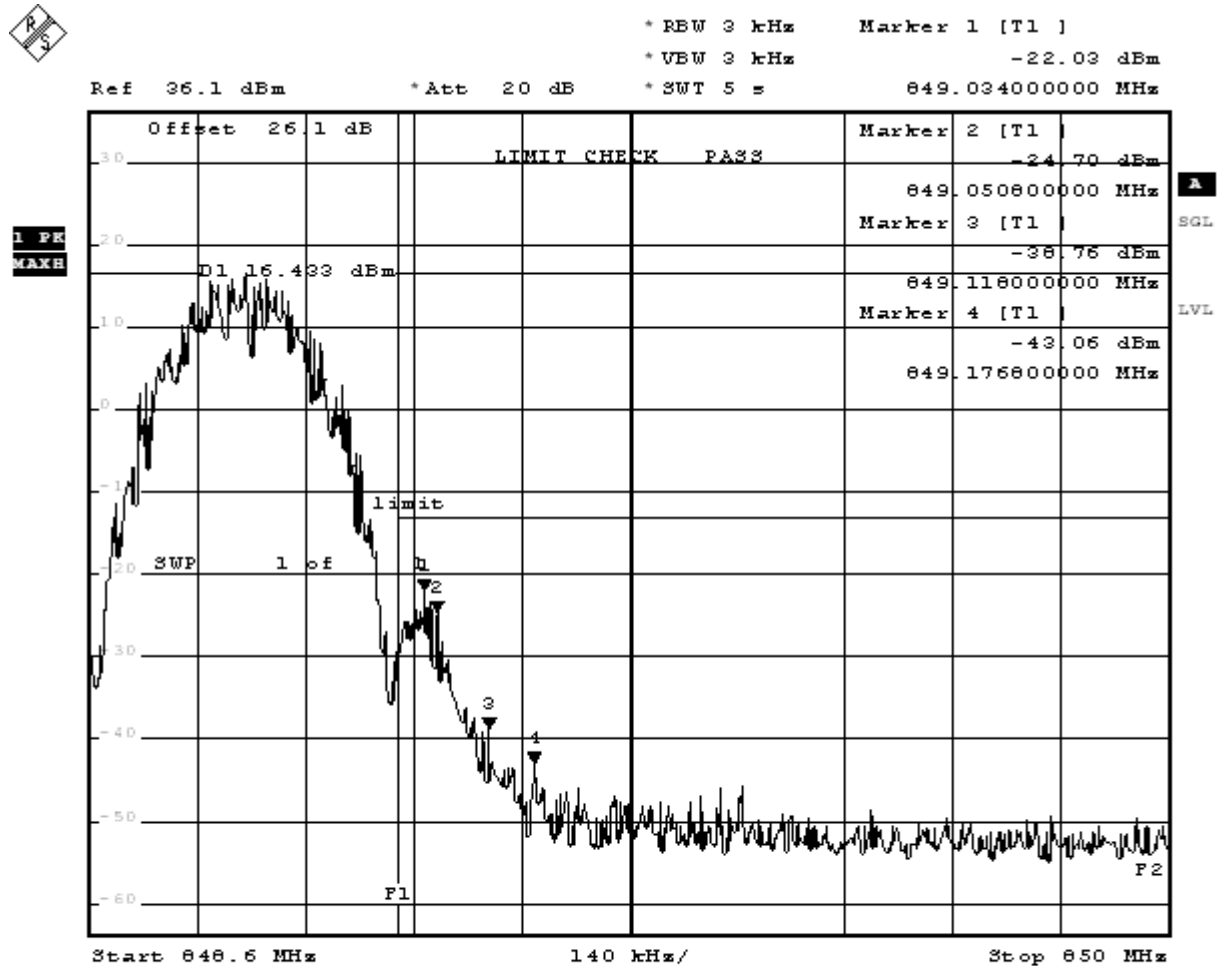

Comment: EUT code 37410h02, EDGE data call, band edge compliance, op  
 Comment: channel 251 (848.6MHz)  
 Date: 25.JUN.2008 12:52:31

Test: band edge compliance, Channel 251, EDGE



**Op. Mode**

op-mode 9

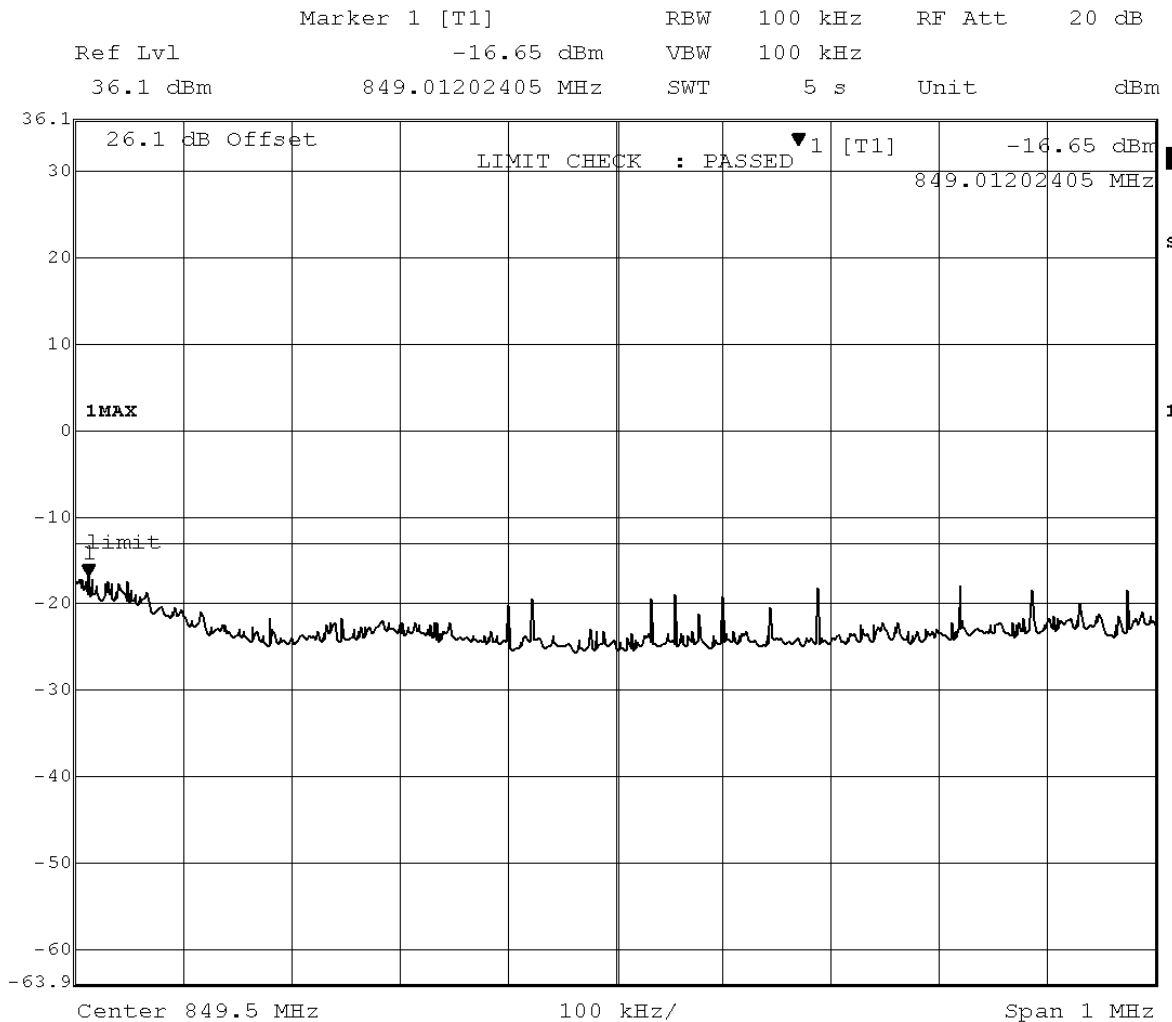

Title: EUT CODE 37410d01  
Comment A: FDD V data call, band edge compliance, op-mode 9,  
channel 4233 (846.6MHz)  
Date: 6.MAY.2008 19:41:41

Test: band edge compliance, Channel 4233, FDD V