



Inter**Lab**[®]

FCC Measurement/Technical Report on PCMCIA card GT Fusion+ EMEA

Report Reference: 4_Opti_0605_UMTS_FCCg

Test Laboratory:

7 layers AG
Borsigstrasse 11
40880 Ratingen
Germany
email: info@7Layers.de



Note:

The following test results relate only to the devices specified in this document. This report shall not be reproduced in parts without the written approval of the testing laboratory.

7 layers AG
Borsigstrasse 11
40880 Ratingen, Germany
Phone: +49 (0) 2102 749 0
Fax: +49 (0) 2102 749 350
www.7Layers.com

*Aufsichtsratsvorsitzender •
Chairman of the Supervisory Board:
Markus Becker
Vorstand • Board:
Dr. Hans-Jürgen Meckelburg
René Schildknecht*

*Registergericht • registered in:
Düsseldorf, HRB 44096
USt-IdNr • VAT Nr:
DE 203159652*



Table of Contents

0 Summary	3
0.1 Technical Report Summary	3
0.2 Measurement Summary	4
1 Administrative Data	5
1.1 Testing Laboratory	5
1.2 Project Data	5
1.3 Applicant Data	5
1.4 Manufacturer Data	5
2 Testobject Data	6
2.1 General EUT Description	6
2.2 EUT Main components	7
2.3 Ancillary Equipment	7
2.4 EUT Setups	7
2.5 Operating Modes	8
3 Test Results	9
3.1 RF Power Output	9
3.2 Frequency stability	13
3.3 Spurious emissions at antenna terminals	17
3.4 Field strength of spurious radiation	21
3.5 Emission and Occupied Bandwidth	25
4 Test Equipment	29
5 Photo Report	32
6 Setup Drawings	35
7 Annex	37
Measurement Plots	



0 Summary

0.1 Technical Report Summary

Type of Authorization

Certification for a GSM cellular radiotelephone device

Applicable FCC Rules

Prepared in accordance with the requirements of FCC Rules and Regulations as listed in 47 CFR Ch.1 Parts 0 to 19 and Parts 20 to 69 (10-1-01 Edition). The following subparts are applicable to the results in this test report.

Part 2

Subpart J - Equipment Authorization Procedures, Certification

- § 2.1046 Measurement required: RF power output
- § 2.1049 Measurement required: Occupied bandwidth
- § 2.1051 Measurement required: Spurious emissions at antenna terminals
- § 2.1053 Measurement required: Field strength of spurious emission
- § 2.1055 Measurement required: Frequency stability
- § 2.1057 Frequency spectrum to be investigated

Part 24

Subpart E - Broadband PCS

- § 24.232 Power and antenna height limits
- § 24.235 Frequency stability
- § 24.238 Emission limits

Summary Test Results:

The EUT complied with all performed tests as listed in chapter 0.2 Measurement Summary.

0.2 Measurement Summary

RF Power Output

The measurement was performed according to FCC §2.1046 10-01-2001

OP-Mode	Setup	Port	Final Result
op-mode 1	Setup_a01	antenna connector	passed
op-mode 2	Setup_a01	antenna connector	passed
op-mode 3	Setup_a01	antenna connector	passed

Frequency stability

The measurement was performed according to FCC §2.1055 10-01-2001

OP-Mode	Setup	Port	Final Result
op-mode 2	Setup_a01	antenna connector	passed

Spurious emissions at antenna terminals

The measurement was performed according to FCC §2.1051 10-01-2001

OP-Mode	Setup	Port	Final Result
op-mode 1	Setup_a01	antenna connector	passed
op-mode 2	Setup_a01	antenna connector	passed
op-mode 3	Setup_a01	antenna connector	passed

Field strength of spurious radiation

The measurement was performed according to FCC §2.1053 10-01-2001

OP-Mode	Setup	Port	Final Result
op-mode 1	Setup_a02	enclosure	passed
op-mode 2	Setup_a02	enclosure	passed
op-mode 3	Setup_a02	enclosure	passed

Emission and Occupied Bandwidth

The measurement was performed according to FCC §2.1049 10-01-2001

OP-Mode	Setup	Port	Final Result
op-mode 1	Setup_a01	antenna connector	passed
op-mode 2	Setup_a01	antenna connector	passed
op-mode 3	Setup_a01	antenna connector	passed

This report replaces the report 4_Opti_0605_UMTS_FCCb.

Responsible for
Accreditation Scope:

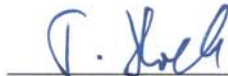

Responsible
for Test Report:





1 Administrative Data

1.1 Testing Laboratory

Company Name: 7 Layers AG
Address Borsigstr. 11
40880 Ratingen
Germany

This facility has been fully described in a report submitted to the FCC and accepted under the registration number 96716 .

The test facility is also accredited by the following accreditation organisation:
- Deutscher Akkreditierungs Rat DAR-Registration no. DAT-P-192/99-01

Responsible for Accreditation Scope: Dipl.-Ing. Bernhard Retka
Dipl.-Ing. Arndt Stöcker
Dipl.-Ing. Thomas Hoell

Report Template Version: 2005-09-21

1.2 Project Data

Responsible for testing and report: Dipl.-Ing. Robert Machulec
Receipt of EUT: 08.09.2005
Date of Test(s): 08.09.2005 - 22.09.2005
Date of Report: 04.11.2005

1.3 Applicant Data

Company Name: Option International NV SA
Address: Kolonel Begaultlaan 45
3012 Leuven
Belgium
Contact Person: Mr. Stefan Lodeweyckx

1.4 Manufacturer Data

Company Name: please see applicant data

Address:

Contact Person:

2 Testobject Data

2.1 General EUT Description

Equipment under	PCMCIA card
Type Designation:	GT Fusion+ EMEA
Kind of Device:	GSM-EDGE 850/900/1800/1900, FDDI-HSDPA
(optional)	WLAN
Voltage Type:	DC
Nominal Voltage:	3.5 V
Maximum Voltage:	3.5 V
Minimum Voltage:	3.15 V

General product description:

The Equipment Under Test (EUT) is a PCMCIA card which supports GSM/EDGE in the bands 850/900/1800/1900 MHz, UMTS/HSDPA in FDDI band and WLAN in 2400 MHz band.

In PCS1900 mode the EUT operates in blocks A through F from 1850,2 MHz (lowest channel = 512) to 1909,8 MHz (highest channel = 810).

The EUT provides the following ports:

Ports

antenna connector
enclosure
PCMCIA slot

The main components of the EUT are listed and described in Chapter 2.2



2.2 EUT Main components

Type, S/N, Short Descriptions etc. used in this Test Report

Short Description	Equipment under Test	Type Designation	Serial No.	HW Status	SW Status	Date of Receipt
EUT A (Code: 37070b01)	PCMCIA card	Globe	NB2B57S01K	2.0	3.1.0d	08.09.2005

Remark: EUT is equipped with an antenna connector and an integral antenna (gain= -4dBi -2.14dB).

NOTE: The short description is used to simplify the identification of the EUT in this test report.

2.3 Ancillary Equipment

For the purposes of this test report, ancillary equipment is defined as equipment which is used in conjunction with the EUT to provide operational and control features to the EUT. It is necessary to configure the system in a typical fashion, as a customer would normally use it. But nevertheless Ancillary Equipment can influence the test results.

Short Description	Equipment under Test	Type Designation	HW Status	SW Status	Serial no.	FCC ID
AE1	Laptop	Packerd Bell	-	-	S/N:281701 750122	-

2.4 EUT Setups

This chapter describes the combination of EUT's and ancillary equipment used for testing.

Setup No.	Combination of EUTs	Description
setup_a01	EUT A + AE1	



2.5 Operating Modes

This chapter describes the operating modes of the EUT's used for testing.

Op. Mode	Description of Operating Modes	Remarks
PCS data call		
op-mode 1	Call established on Traffic Channel (TCH) 512, Carrier Frequency 1850.2 MHz	512 is the lowest channel PCS data call
op-mode 2	Call established on Traffic Channel (TCH) 661, Carrier Frequency 1880 MHz	661 is a mid channel PCS data call
op-mode 3	Call established on Traffic Channel (TCH) 810, Carrier Frequency 1909.8 MHz	810 is the highest channel PCS data call
EDGE data call		
op-mode 4	Call established on Traffic Channel (TCH) 512, Carrier Frequency 1850.2 MHz	512 is the lowest channel EDGE data call
op-mode 5	Call established on Traffic Channel (TCH) 661, Carrier Frequency 1880 MHz	661 is a mid channel EDGE data call
op-mode 6	Call established on Traffic Channel (TCH) 810, Carrier Frequency 1909.8 MHz	810 is the highest channel EDGE data call



3 Test Results

3.1 RF Power Output

Standard FCC Part 24, 10-01-2001
Subpart H

The test was performed according to: FCC §2.1046, 10-01-2001

3.1.1 Test Description

1) The EUT was coupled to the R&S Spectrum Analyser and the R&S CMD55 / CMU200 Digital Communication Tester through a Power Divider. Refer to chapter "Setup Drawings".

2) The total insertion losses for RF Path 1 and RF Path 2 were measured. The values were used to correct the readings from the R&S Spectrum Analyser and the R&S CMD55 / CMU200 Digital Communication Tester.

3) A speech call was established on a Traffic Channel (TCH) between the EUT and the base station simulator (R&S CMD55 / CMU200 Digital Communication Tester).

Important Settings:

- Discontinuous Transmission: OFF
- Modulation Signal: PSR16-1 (Pseudo Random Sequence)
- Output Power: Varied during measurements
- Channel (Frequency): Varied during measurements

4) The transmitted power of the EUT was recorded for all possible power control level by using an internal measurement function of the CMD55 / CMU200.

5) During this test the Spectrum Analyser was only used to check if the results are comprehensible.

3.1.2 Test Requirements / Limits

§2.1046 Measurements Required: RF Power Output

(a) For transmitters other than single sideband, independent sideband and controlled carrier radiotelephone, power output shall be measured at the RF output terminals when the transmitter is adjusted in accordance with the tune-up procedure to give the values of current and voltage on the circuit elements specified in § 2.1033(c)(8). The electrical characteristics of the output terminals when this test is made shall be stated.

§24.232 Power and antenna height limits

(a) For transmitters other than single sideband, independent sideband and controlled carrier radiotelephone, power output shall be measured at the RF output terminals when the transmitter is adjusted in accordance with the tune-up procedure to give the values of current and voltage on the circuit elements specified in § 2.1033(c)(8). The electrical characteristics of the output terminals when this test is made shall be stated.

(c) Peak transmit power must be measured over any interval of continuous transmission using instrumentation calibrated in terms of an rms-equivalent voltage. The



measurement results shall be properly adjusted for any instrument limitations, such as detector response times, limited resolution bandwidth capability when compared to the emission bandwidth, sensitivity, etc., so as to obtain a true peak measurement for the emission in question over the full bandwidth of the channel.

3.1.3 Test Protocol

Temperature: 24 °C
 Air Pressure: 1022 hPa
 Humidity: 36 %

Op. Mode	Setup	Port
op-mode 1	setup_a01	antenna connector

Power Control Level	Output power Nominal (dBm)	Output power Measured (dBm)	Difference dB
0	30	28.5	-1.5
1	28	26.5	-1.5
2	26	24.5	-1.5
3	24	22.5	-1.5
4	22	20.5	-1.5
5	20	18.5	-1.5
6	18	16.5	-1.5
7	16	14.4	-1.6
8	14	12.4	-1.6
9	12	10.4	-1.6
10	10	8.3	-1.7
11	8	6.2	-1.8
12	6	4.2	-1.8
13	4	2.1	-1.9
14	2	0.1	-1.9
15	0	-2	-2

Remark: The EIRP including antenna gain (-4 dBi) is 24.5 dBm.

Op. Mode	Setup	Port
op-mode 2	setup_a01	antenna connector

Power Control Level	Output power Nominal (dBm)	Output power Measured (dBm)	Difference dB
0	30	28.7	-1.3
1	28	26.7	-1.3
2	26	24.7	-1.3
3	24	22.6	-1.4
4	22	20.6	-1.4
5	20	18.6	-1.4
6	18	16.6	-1.4
7	16	14.6	-1.4
8	14	12.5	-1.5
9	12	10.5	-1.5
10	10	8.4	-1.6
11	8	6.4	-1.6
12	6	4.4	-1.6
13	4	2.3	-1.7
14	2	0.2	-1.8
15	0	-1.9	-1.9

Remark: The EIRP including antenna gain (-4 dBi) is 24.7 dBm.

Op. Mode	Setup	Port
op-mode 3	setup_a01	antenna connector

Power Control Level	Output power Nominal (dBm)	Output power Measured (dBm)	Difference dB
0	30	28.8	-1.2
1	28	26.8	-1.2
2	26	24.8	-1.2
3	24	22.8	-1.2
4	22	20.7	-1.3
5	20	18.7	-1.3
6	18	16.7	-1.3
7	16	14.7	-1.3
8	14	12.6	-1.4
9	12	10.6	-1.4
10	10	8.5	-1.5
11	8	6.5	-1.5
12	6	4.5	-1.5
13	4	2.4	-1.6
14	2	0.3	-1.7
15	0	-1.7	-1.7

Remark: The EIRP including antenna gain (-4 dBi) is 24.8 dBm.

Op. Mode	Setup	Port
op-mode 4	setup_a01	antenna connector

Power Control Level	Output power Nominal (dBm)	Output power Measured (dBm)	Difference dB
0	30	25.90	-4.10

Remark: The EIRP including antenna gain (-4 dBi) is 21.9 dBm.

Op. Mode	Setup	Port
op-mode 5	setup_a01	antenna connector

Power Control Level	Output power Nominal (dBm)	Output power Measured (dBm)	Difference dB
0	30	26.10	-3.90

Remark: The EIRP including antenna gain (-4 dBi) is 22.1 dBm.

Op. Mode	Setup	Port
op-mode 6	setup_a01	antenna connector

Power Control Level	Output power Nominal (dBm)	Output power Measured (dBm)	Difference dB
0	30	25.90	-4.10

Remark: The EIRP including antenna gain (-4 dBi) is 21.9 dBm.



3.1.4 Test result: RF Power Output

FCC Part 24, Subpart E	Op. Mode	Result
	op-mode 1	passed
	op-mode 2	passed
	op-mode 3	passed
	op-mode 4	passed
	op-mode 5	passed
	op-mode 6	passed

3.2 Frequency stability

Standard FCC Part 24, 10-01-2001
Subpart H

The test was performed according to FCC §2.1055, 10-01-2001

3.2.1 Test Description

- 1) The EUT was placed inside the climatic chamber.
- 2) The EUT was coupled to the R&S CMD55 / CMU200 Digital Communication Tester. Refer to chapter "Setup Drawings".
- 3) The climatic chamber was cycled down/up to a certain temperature, starting with -30°C .
- 4) After the temperature was stabilized (at least one hour) the EUT was switched on and a speech call was established on a Traffic Channel (TCH) between the EUT and the base station simulator (R&S CMD55 / CMU200 Digital Communication Tester).
Important Settings:
 - Discontinuous Transmission: OFF
 - Modulation Signal: PSR16-1 (Pseudo Random Sequence)
 - Output Power: Maximum
 - Channel : 661 [1880.0 MHz]
- 5) The frequency error of the EUT were recorded by using an internal measurement function of the CMD55 / CMU200 immediately after the call was established, five minutes after the call was established and ten minutes after the call was established.
- 6) This measurement procedure was performed for all combinations of voltage (low, nominal, high) and temperature (from -30°C to $+50^{\circ}\text{C}$ in increments of 10°C).

3.2.2 Test Requirements / Limits

§2.1055 Measurements required: Frequency stability

(a) The frequency stability shall be measured with variation of ambient temperature as follows:

(1) From -30° to $+50^{\circ}$ centigrade for all equipment except that specified in paragraphs (a) (2) and (3) of this section.

(b) Frequency measurements shall be made at the extremes of the specified temperature range and at intervals of not more than 10° centigrade through the range. A period of time sufficient to stabilize all of the components of the oscillator circuit at each temperature level shall be allowed prior to frequency measurement. The short term transient effects on the frequency of the transmitter due to keying (except for broadcast transmitters) and any heating element cycling normally occurring at each ambient temperature level also shall be shown. Only the portion or portions of the transmitter containing the frequency determining and stabilizing circuitry need be subjected to the temperature variation test.



(d) The frequency stability shall be measured with variation of primary supply voltage as follows:

(1) Vary primary supply voltage from 85 to 115 percent of the nominal value for other than hand carried battery equipment.

(2) For hand carried, battery powered equipment, reduce primary supply voltage to the battery operating end point which shall be specified by the manufacturer.

(3) The supply voltage shall be measured at the input to the cable normally provided with the equipment, or at the power supply terminals if cables are not normally provided. Effects on frequency of transmitter keying (except for broadcast transmitters) and any heating element cycling at the nominal supply voltage and at each extreme also shall be shown.

§24.235 Frequency stability

The frequency stability shall be sufficient to ensure that the fundamental emission stays within the authorized frequency block.



3.2.3 Test Protocol

Temperature: 24 °C
 Air Pressure: 1021 hPa
 Humidity: 38 %

Op. Mode **Setup** **Port**
 op-mode 2 setup_a01 antenna connector

Temp. °C	Duration min	Minimum Voltage / V		Normal Voltage / V		Maximum Voltage / V	
		3.15		3.5		3.5	
		Freq. error Average (Hz)	Freq. error Max. (Hz)	Freq. error Average (Hz)	Freq. error Max. (Hz)	Freq. error Average (Hz)	Freq. error Max. (Hz)
-30	0	29	50	28	49	-	-
-30	5	5	16	6	20	-	-
-30	10	-13	-29	-17	-33	-	-
-20	0	-21	-38	-29	-43	-	-
-20	5	3	18	4	20	-	-
-20	10	1	16	2	18	-	-
-10	0	-36	-54	-39	-60	-	-
-10	5	-28	-40	-24	-42	-	-
-10	10	-22	-35	-23	-34	-	-
0	0	17	30	16	31	-	-
0	5	-9	-25	-7	-21	-	-
0	10	-5	-19	-6	-7	-	-
10	0	17	29	5	26	-	-
10	5	4	19	8	26	-	-
10	10	-4	-18	-2	-16	-	-
20	0	-19	-35	4	15	-	-
20	5	5	19	4	18	-	-
20	10	6	20	6	25	-	-
30	0	-20	-31	-23	-35	-	-
30	5	-16	-28	-15	-27	-	-
30	10	-7	-20	-6	-22	-	-
40	0	14	26	15	28	-	-
40	5	-2	-14	-2	-19	-	-
40	10	-9	-22	-9	-20	-	-
50	0	-31	-47	-19	-34	-	-
50	5	-30	-42	-17	-30	-	-
50	10	-15	-33	-16	-27	-	-

Remark: The manufacturer declared normal = maximum voltage and the temperature range.



Op. Mode **Setup** **Port**
 op-mode 5 setup_a01 antenna connector

		Minimum Voltage / V		Normal Voltage / V		Maximum Voltage / V	
		3.15		3.5		3.5	
Temp. °C	Duration min	Freq. error Average (Hz)	Freq. error Max. (Hz)	Freq. error Average (Hz)	Freq. error Max. (Hz)	Freq. error Average (Hz)	Freq. error Max. (Hz)
-30	0	27	46	29	48	-	-
-30	5	6	14	9	21	-	-
-30	10	-12	-22	-14	-28	-	-
-20	0	-24	-41	-26	-42	-	-
-20	5	3	15	4	18	-	-
-20	10	2	14	2	17	-	-
-10	0	-38	-57	-35	-54	-	-
-10	5	-25	-39	-27	-41	-	-
-10	10	-19	-33	-24	-38	-	-
0	0	19	31	14	29	-	-
0	5	-11	-27	-9	-20	-	-
0	10	-4	-17	-3	-13	-	-
10	0	13	28	7	24	-	-
10	5	5	24	9	28	-	-
10	10	-6	-21	-6	-19	-	-
20	0	-20	-39	8	28	-	-
20	5	7	23	6	19	-	-
20	10	5	21	4	19	-	-
30	0	-15	-31	-18	-36	-	-
30	5	-11	-24	-13	-23	-	-
30	10	-6	-18	-7	-21	-	-
40	0	16	31	16	34	-	-
40	5	-1	-10	-2	-15	-	-
40	10	-3	-12	-4	-19	-	-
50	0	-19	-39	-17	-34	-	-
50	5	-20	-40	-22	-38	-	-
50	10	-18	-37	-19	-32	-	-

Remark: The manufacturer declared normal = maximum voltage and the temperature range.

3.2.4 Test result: Frequency stability

FCC Part 24, Subpart E	Op. Mode	Result
	op-mode 2	passed
	op-mode 5	passed

3.3 Spurious emissions at antenna terminals

Standard FCC Part 24, 10-01-2001
Subpart H

The test was performed according to FCC §2.1051, 10-01-2001

3.3.1 Test Description

1) The EUT was coupled to the R&S Spectrum Analyser and the R&S CMD55 / CMU200 Digital Communication Tester through a Power Divider. Refer to chapter "Setup Drawings".

2) The total insertion losses for RF Path 1 and RF Path 2 were measured. The values were used to correct the readings from the R&S Spectrum Analyser and the R&S CMD55 / CMU200 Digital Communication Tester.

3) A speech call was established on a Traffic Channel (TCH) between the EUT and the base station simulator (R&S CMD55 / CMU200 Digital Communication Tester).

Important Settings:

- Discontinuous Transmission: OFF
- Modulation Signal: PSR16-1 (Pseudo Random Sequence)
- Output Power: Maximum
- Channel: Varied during measurements
(lowest channel: 512, mid channel: 661 and highest channel: 810)

4) Important Analyser Settings

- [Resolution Bandwidth / Video Bandwidth]:
 - a) [3 kHz / 10 kHz] in the Span of 1 MHz directly below and above the PCS-Band,
 - b) [10 kHz / 30 kHz] in case the curve of the analyser IF-Filter leads to an exceeding of the limit, in this case a worst case correction factor of 20 dB (1 MHz -> 10 kHz) was used
 - c) [1 MHz / 3 MHz] otherwise
- Sweep Time: Calculated by using a formula given in the Product Standard "PCS 11.10-1 edition 4" for spurious emissions measurements (depending on the transmitting signal, the span and the resolution bandwidth)

5) The spurious emissions (peak) were measured in the frequency range from 9 kHz to 20 GHz (up to the 10th harmonic) during the call is established on the lowest channel (512), mid channel (661) and on the highest channel (810).

3.3.2 Test Requirements / Limits

§ 2.1051 Spurious emissions at antenna terminals

The radio frequency voltage or power generated within the equipment and appearing on a spurious frequency shall be checked at the equipment output terminals when properly loaded with a suitable artificial antenna. Curves or equivalent data shall show the magnitude of each harmonic and other spurious emission that can be detected when the equipment is operated under the conditions specified in Sec. 2.1049 as appropriate. The magnitude of spurious emissions which are attenuated more than 20 dB below the permissible value need not be specified.



§ 2.1057 Frequency spectrum to be investigated.

(a) In all of the measurements set forth in Secs. 2.1051 and 2.1053, the spectrum shall be investigated from the lowest radio frequency signal generated in the equipment, without going below 9 kHz, up to at least the frequency shown below:

(1) If the equipment operates below 10 GHz: to the tenth harmonic of the highest fundamental frequency or to 40 GHz, whichever is lower.

(b) Particular attention should be paid to harmonics and subharmonics of the carrier frequency as well as to those frequencies removed from the carrier by multiples of the oscillator frequency. Radiation at the frequencies of multiplier stages should also be checked.

(c) The amplitude of spurious emissions which are attenuated more than 20 dB below the permissible value need not be reported.

(d) Unless otherwise specified, measurements above 40 GHz shall be performed using a minimum resolution bandwidth of 1 MHz.

§ 24.238 Emission Limits

(a) On any frequency outside a licensee's frequency block, the power of any emission shall be attenuated below the transmitter power (P) by at least $43 + 10 \log (P)$ dB. Remark of the test laboratory: This is calculated to be -13 dBm.

(b) Compliance with these provisions is based on the use of measurement instrumentation employing a resolution bandwidth of 1 MHz or greater. However, in the 1 MHz bands immediately outside and adjacent to the frequency block a resolution bandwidth of at least one percent of the emission bandwidth of the fundamental emission of the transmitter may be employed. The emission bandwidth is defined as the width of the signal between two points, one below the carrier center frequency and one above the carrier center frequency, outside of which all emissions are attenuated at least 26 dB below the transmitter power.

(c) When measuring the emission limits, the nominal carrier frequency shall be adjusted as close to the licensee's frequency block edges, both upper and lower, as the design permits.

(d) The measurements of emission power can be expressed in peak or average values, provided they are expressed in the same parameters as the transmitter power.

(e) When an emission outside of the authorized bandwidth causes harmful interference, the Commission may, at its discretion, require greater attenuation than specified in this section.

3.3.3 Test Protocol

Temperature: 24 °C
 Air Pressure: 1022 hPa
 Humidity: 36 %

Op. Mode	Setup	Port
op-mode 1	setup_a01	antenna connector

Frequency MHz	Bandwidth kHz	Measured Level dBm	Limit dBm
1.8500	3	-15.53	-13.0
3.6707	1000	-43.04	-13.0
5.5429	1000	-45.41	-13.0
6.5483	1000	-45.39	-13.0
18.3021	1000	-41.68	-13.0

Remark: No (further) spurious emissions were found in the range 20 dB below the limit.

Op. Mode	Setup	Port
op-mode 2	setup_a01	antenna connector

Frequency MHz	Bandwidth kHz	Measured Level dBm	Limit dBm
3.7400	1000	-42.11	-13.0
5.6122	1000	-45.21	-13.0
6.6176	1000	-44.86	-13.0
18.2665	1000	-42.98	-13.0

Remark: No (further) spurious emissions were found in the range 20 dB below the limit.

Op. Mode	Setup	Port
op-mode 3	setup_a01	antenna connector

Frequency MHz	Bandwidth kHz	Measured Level dBm	Limit dBm
1.9100	3	-16.32	-13.0
3.8041	1000	-42.77	-13.0
5.7162	1000	-44.63	-13.0
6.5830	1000	-45.19	-13.0
18.2665	1000	-42.89	-13.0

Remark: No (further) spurious emissions were found in the range 20 dB below the limit.

Op. Mode	Setup	Port
op-mode 4	setup_a01	antenna connector

Frequency MHz	Bandwidth kHz	Measured Level dBm	Limit dBm
1.8500	3	-20.22	-13.0
1.9569	10	-21.19	-13.0
3.6707	1000	-43.99	-13.0
5.5429	1000	-45.5	-13.0



6.9297	1000	-45.4	-13.0
18.3012	1000	-42.98	-13.0

Remark: No (further) spurious emissions were found in the range 20 dB below the limit.

Op. Mode	Setup	Port
op-mode 5	setup_a01	antenna connector

Frequency MHz	Bandwidth kHz	Measured Level dBm	Limit dBm
1.9569	10	-21.41	-13.0
3.7400	1000	-44.14	-13.0
6.5830	1000	-45.96	-13.0
18.3705	1000	-43.36	-13.0

Remark: No (further) spurious emissions were found in the range 20 dB below the limit.

Op. Mode	Setup	Port
op-mode 6	setup_a01	antenna connector

Frequency MHz	Bandwidth kHz	Measured Level dBm	Limit dBm
1.9100	3	-20.87	-13.0
1.9575	10	-21.12	-13.0
3.8094	1000	-45.08	-13.0
5.7162	1000	-45.18	-13.0
6.5483	1000	-45.3	-13.0
18.2665	1000	-43.21	-13.0

Remark: No (further) spurious emissions were found in the range 20 dB below the limit.

3.3.4 Test result: Spurious emissions at antenna terminals

FCC Part 24, Subpart E	Op. Mode	Result
	op-mode 1	passed
	op-mode 2	passed
	op-mode 3	passed
	op-mode 4	passed
	op-mode 5	passed
	op-mode 6	passed

3.4 Field strength of spurious radiation

Standard FCC Part 24, 10-01-2001
Subpart H

The test was performed according to: FCC §2.1053, 10-01-2001

3.4.1 Test Description

1) The EUT was placed inside an anechoic chamber. Refer to chapter "Setup Drawings". The EUT was coupled to the R&S CMD55 / CMU200 Digital Communication Tester which was located outside the chamber via coaxial cable.

2) A speech call was established on a Traffic Channel (TCH) between the EUT and the base station simulator (R&S CMD55 / CMU200 Digital Communication Tester).

Important Settings:

- Discontinuous Transmission: OFF
- Modulation Signal: PSR16-1 (Pseudo Random Sequence)
- Output Power: Maximum
- Channel : Varied during measurements

(lowest channel: 512, mid channel: 661 and highest channel: 810)

3) A pre-calibration procedure is used so that the readings from the spectrum analyser are corrected and represent directly the equivalent radiated power (related to a $\lambda/2$ dipole).

4) All spurious radiation measurements were made with spectrum analyser and the appropriate calibrated antennas for the frequency range of 30 MHz to 20 GHz (up to the 10th harmonic of the transmit frequency).

5) Important Analyser Settings

- [Resolution Bandwidth / Video Bandwidth]:

a) [3 kHz / 10 kHz] in the Span of 1 MHz directly below and above the GSM-Band,

b) [10 kHz / 30 kHz] in case the curve of the analyser IF-Filter leads to an exceeding of the limit, in this case a worst case correction factor of 20 dB (1 MHz -> 10 kHz) was used

c) [1 MHz / 3 MHz] otherwise

- Sweep Time: Calculated by using a formula given in the Product Standard "GSM 11.10-1 edition 4" for spurious emissions measurements (depending on the transmitting signal, the span and the resolution bandwidth)

6) The spurious emissions (peak) were measured in both vertical and horizontal antenna polarisation during the call is established on the lowest channel (512), mid channel (661) and on the highest channel (810).

3.4.2 Test Requirements / Limits

§ 2.1053 Measurements required: Field strength of spurious radiation.

Measurements shall be made to detect spurious emissions that may be radiated directly from the cabinet, control circuits, power leads, or intermediate circuit elements under normal conditions of installation and operation. Curves or equivalent data shall be supplied showing the magnitude of each harmonic and other spurious emission. For this test, single sideband, independent sideband, and controlled carrier transmitters shall be modulated under the conditions specified in paragraph (c) of Sec. 2.1049, as appropriate.

For equipment operating on frequencies below 890 MHz, an open field test is normally required, with the measuring instrument antenna located in the far-field at all test frequencies. In the event it is either impractical or impossible to make open field measurements (e.g. a broadcast transmitter installed in a building) measurements will be accepted of the equipment as installed. Such measurements must be accompanied by a description of the site where the measurements were made showing the location of any possible source of reflections which might distort the field strength measurements. Information submitted shall include the relative radiated power of each spurious emission with reference to the rated power output of the transmitter, assuming all emissions are radiated from halfwave dipole antennas.

(b) The measurements specified in paragraph (a) of this section shall be made for the following equipment:

(2) All equipment operating on frequencies higher than 25 MHz.

§ 2.1057 Frequency spectrum to be investigated.

(a) In all of the measurements set forth in Secs. 2.1051 and 2.1053, the spectrum shall be investigated from the lowest radio frequency signal generated in the equipment, without going below 9 kHz, up to at least the frequency shown below:

(1) If the equipment operates below 10 GHz: to the tenth harmonic of the highest fundamental frequency or to 40 GHz, whichever is lower.

(b) Particular attention should be paid to harmonics and subharmonics of the carrier frequency as well as to those frequencies removed from the carrier by multiples of the oscillator frequency. Radiation at the frequencies of multiplier stages should also be checked.

(c) The amplitude of spurious emissions which are attenuated more than 20 dB below the permissible value need not be reported.

(d) Unless otherwise specified, measurements above 40 GHz shall be performed using a minimum resolution bandwidth of 1 MHz.

§ 24.238 Emission limits

(a) On any frequency outside a licensee's frequency block, the power of any emission shall be attenuated below the transmitter power (P) by at least $43 + 10 \log (P)$ dB.

This is calculated to be -13 dBm (effective radiated power) which corresponds to 84.6 dBµV/m (field strength) in a distance of 3 m.

3.4.3 Test Protocol

Temperature: 24 °C
 Air Pressure: 1022 hPa
 Humidity: 36 %

Op. Mode	Setup	Port
op-mode 1	setup_a02	enclosure

Frequency MHz	Antenna Polarisation	Bandwidth kHz	Measured Level dBm	Limit dBm
1.8500	Vertical	3	-13.98	-13.0
5.5515	Horizontal	1000	-29.90	-13.0
9.2615	Horizontal	1000	-15.93	-13.0
11.1012	Horizontal	1000	-26.92	-13.0
12.9715	Vertical	1000	-26.05	-13.0
14.8112	Horizontal	1000	-35.18	-13.0
16.6509	Horizontal	1000	-33.40	-13.0

Remark: No (further) spurious emissions were found in the range 20 dB below the limit.

Op. Mode	Setup	Port
op-mode 2	setup_a02	enclosure

Frequency MHz	Antenna Polarisation	Bandwidth kHz	Measured Level dBm	Limit dBm
3.7425	Horizontal	1000	-39.42	-13.0
7.5138	Horizontal	1000	-34.44	-13.0
9.3842	Horizontal	1000	-20.56	-13.0
11.2852	Horizontal	1000	-28.4	-13.0
13.1555	Horizontal	1000	-28.47	-13.0
15.0565	Horizontal	1000	-35.98	-13.0
16.9268	Horizontal	1000	-28.78	-13.0

Remark: No (further) spurious emissions were found in the range 20 dB below the limit.

Op. Mode	Setup	Port
op-mode 3	setup_a02	enclosure

Frequency MHz	Antenna Polarisation	Bandwidth kHz	Measured Level dBm	Limit dBm
1.9100	Vertical	3	-15.7	-13.0
9.5375	Horizontal	1000	-23.28	-13.0
11.4691	Horizontal	1000	-27.72	-13.0
13.3701	Vertical	1000	-31.54	-13.0
17.2028	Horizontal	1000	-15.7	-13.0

Remark: No (further) spurious emissions were found in the range 20 dB below the limit.

Op. Mode	Setup	Port
op-mode 4	setup_a02	enclosure

Frequency MHz	Antenna Polarisation	Bandwidth kHz	Measured Level dBm	Limit dBm
1.8500	Vertical	3	-18.63	-13.0
9.2615	Horizontal	1000	-16.85	-13.0
11.1012	Horizontal	1000	-28.71	-13.0



12.9715	Vertical	1000	-29.48	-13.0
16.6509	Horizontal	1000	-32.16	-13.0

Remark: No (further) spurious emissions were found in the range 20 dB below the limit.

Op. Mode	Setup	Port
op-mode 5	setup_a02	enclosure

Frequency MHz	Antenna Polarisation	Bandwidth kHz	Measured Level dBm	Limit dBm
9.3842	Horizontal	1000	-19.75	-13.0
11.2852	Horizontal	1000	-31.29	-13.0
13.1555	Horizontal	1000	-30.81	-13.0
16.9268	Horizontal	1000	-31.42	-13.0

Remark: No (further) spurious emissions were found in the range 20 dB below the limit.

Op. Mode	Setup	Port
op-mode 6	setup_a02	enclosure

Frequency MHz	Antenna Polarisation	Bandwidth kHz	Measured Level dBm	Limit dBm
1.9100	Horizontal	3	-22	-13.0
9.5375	Horizontal	1000	-23.15	-13.0
11.4691	Horizontal	1000	-31.01	-13.0
17.2028	Horizontal	1000	-29.94	-13.0

Remark: No (further) spurious emissions were found in the range 20 dB below the limit.

3.4.4 Test result: Field strength of spurious radiation

FCC Part 24, Subpart E	Op. Mode	Result
	op-mode 1	passed
	op-mode 2	passed
	op-mode 3	passed
	op-mode 4	passed
	op-mode 5	passed
	op-mode 6	passed



3.5 Emission and Occupied Bandwidth

Standard FCC Part 24, 10-01-2001
Subpart H

The test was performed according to: FCC §2.1049, 10-01-2001

3.5.1 Test Description

1) The EUT was coupled to the R&S Spectrum Analyser and the R&S CMD55 / CMU200 Digital Communication Tester through a Power Divider. Refer to chapter "Setup Drawings".

2) The total insertion losses for RF Path 1 and RF Path 2 were measured. The values were used to correct the readings from the R&S Spectrum Analyser and the R&S CMD55 / CMU200 Digital Communication Tester.

3) A speech call was established on a Traffic Channel (TCH) between the EUT and the base station simulator (R&S CMD55 / CMU200 Digital Communication Tester).

Important Settings:

- Discontinuous Transmission: OFF
- Modulation Signal: PSR16-1 (Pseudo Random Sequence)
- Output Power: Maximum
- Channel : Varied during measurements
(lowest channel: 512, mid channel: 661 and highest channel: 810)

4) Important Analyser Settings:

- Resolution Bandwidth: 3 kHz (1% of the manufacturers stated occupied bandwidth)
- Video Bandwidth: 10 kHz (three times the Resolution Bandwidth)
- Sweep Span: 1 MHz (at least 250% of the emission bandwidth)

5) The maximum spectral level of the modulated signal was recorded as the reference.

6) The emission bandwidth is measured as follows:
the two furthest frequencies above and below the frequency of the maximum reference level where the spectrum is -26 dB down have to be found.

7) The occupied bandwidth (99% Bandwidth) is measured as follows:
the occupied bandwidth, that is the frequency bandwidth such that, below its lower and above its upper frequency limits, the mean powers radiated are each equal to 0.5 percent of the total mean power.

3.5.2 Test Requirements / Limits

§ 2.1049 Measurements required: Occupied bandwidth

The occupied bandwidth, that is the frequency bandwidth such that, below its lower and above its upper frequency limits, the mean powers radiated are each equal to 0.5 percent of the total mean power radiated by a given emission shall be measured under the following conditions (as applicable):

(h) Transmitters employing digital modulation techniques - when modulated by an input signal such that its amplitude and symbol rate represent the maximum rated conditions under which the equipment will be operated. The signal shall be applied through any filter networks, pseudo-random generators or other devices required in normal service. Additionally, the occupied bandwidth shall be shown for operation with any devices used for modifying the spectrum when such devices are optional at the discretion of the user.

(i) Transmitters designed for other types of modulation -

3.5.3 Test Protocol

Temperature: 24 °C
 Air Pressure: 1022 hPa
 Humidity: 36 %

Op. Mode	Setup	Port
op-mode 1	setup_a01	antenna connector

Bandwidth kHz	Remarks
320.64	please see annex

Remark: The given value is the result of the 26dB bandwidth measurement.
 The 99% Bandwidth is 248.50 kHz.

Op. Mode	Setup	Port
op-mode 2	setup_a01	antenna connector

Bandwidth kHz	Remarks
316.63	please see annex

Remark: The given value is the result of the 26dB bandwidth measurement.
 The 99% Bandwidth is 244.49 kHz.

Op. Mode	Setup	Port
op-mode 3	setup_a01	antenna connector

Bandwidth kHz	Remarks
316.64	please see annex

Remark: The given value is the result of the 26dB bandwidth measurement.
 The 99% Bandwidth is 244.49 kHz.

Op. Mode	Setup	Port
op-mode 4	setup_a01	antenna connector

Bandwidth kHz	Remarks
314.63	please see annex

Remark: The given value is the result of the 26dB bandwidth measurement.
 The 99% Bandwidth is 246.49 kHz.

Op. Mode	Setup	Port
op-mode 5	setup_a01	antenna connector

Bandwidth kHz	Remarks
294.59	please see annex

Remark: The given value is the result of the 26dB bandwidth measurement.



The 99% Bandwidth is 240.48 kHz.

Op. Mode	Setup	Port
op-mode 6	setup_a01	antenna connector

Bandwidth kHz	Remarks
304.61	please see annex

Remark: The given value is the result of the 26dB bandwidth measurement.
The 99% Bandwidth is 242.48 kHz.

3.5.4 Test result: Emission and Occupied Bandwidth

FCC Part 24, Subpart E	Op. Mode	Result
	op-mode 1	passed
	op-mode 2	passed
	op-mode 3	passed
	op-mode 4	passed
	op-mode 5	passed
	op-mode 6	passed

4 Test Equipment

EUT Digital Signalling System

Equipment	Type	Serial No.	Manufacturer
Digital Radio Communication Tester	CMD 55	831050/020	Rohde & Schwarz
Signalling Unit for Bluetooth Spurious Emissions	PTW60	100004	Rohde & Schwarz
Universal Radio Communication Tester	CMU 200	102366	Rohde & Schwarz

EMI Test System

Equipment	Type	Serial No.	Manufacturer
Comparison Noise Emitter	CNE III	99/016	York
EMI Analyzer	ESI 26	830482/004	Rohde & Schwarz
Signal Generator	SMR 20	846834/008	Rohde & Schwarz

EMI Radiated Auxiliary Equipment

Equipment	Type	Serial No.	Manufacturer
Antenna mast 4m	MA 240	240/492	HD GmbH H. Deisel
Biconical dipole	VUBA 9117	9117108	Schwarzbeck
Broadband Amplifier 18MHz-26GHz	JS4-18002600-32	849785	Miteq
Broadband Amplifier 30MHz-18GHz	JS4-00101800-35	896037	Miteq
Broadband Amplifier 45MHz-27GHz	JS4-00102600-42	619368	Miteq
Cable "ESI to EMI Antenna"	EcoFlex10	W18.01-2 + W38.01-2	Kabel Kusch
Cable "ESI to Horn Antenna"	UFB311A + UFB293C	W18.02-2 + W38.02-2	Rosenberger-Microcoax
Double-ridged horn	HF 906	357357/002	Rohde & Schwarz
Double-ridged horn	HF 906	357357/001	Rohde & Schwarz
High Pass Filter	5HC3500/12750-1.2-KK	200035008	Trilithic
High Pass Filter	5HC2700/12750-1.5-KK	9942012	Trilithic
High Pass Filter	4HC1600/12750-1.5-KK	9942011	Trilithic
KUEP pre amplifier	Kuep 00304000	001	7layers
Log.-per. Antenna	HL 562 Ultralog	830547/003	Rohde & Schwarz
Loop Antenna	HFH2-Z2	829324/006	Rohde & Schwarz
Pyramidal Horn Antenna 26.5 GHz	Model 3160-09	9910-1184	EMCO

EMI Conducted Auxiliary Equipment

Equipment	Type	Serial No.	Manufacturer
Cable "LISN to ESI"	RG214	W18.03+W48.03	Huber+Suhner
Two-Line V-Network	ESH 3-Z5	828304/029	Rohde & Schwarz
Two-Line V-Network	ESH 3-Z5	829996/002	Rohde & Schwarz

Auxiliary Test Equipment

Equipment	Type	Serial No.	Manufacturer
Broadband Resist. Power Divider N	1506A / 93459	LM390	Weinschel
Broadband Resist. Power Divider SMA	1515 / 93459	LN673	Weinschel
Digital Multimeter 01	Voltcraft M-3860M	IJ096055	Conrad
Digital Multimeter 02	Voltcraft M-3860M	IJ095955	Conrad
Digital Oscilloscope	TDS 784C	B021311	Tektronix
Fibre optic link Satellite	FO RS232 Link	181-018	Pontis
Fibre optic link Transceiver	FO RS232 Link	182-018	Pontis
I/Q Modulation Generator	AMIQ-B1	832085/018	Rohde & Schwarz
Notch Filter ultra stable	WRCA800/960-6E	24	Wainwright
Spectrum Analyzer 9 kHz to 3 GHz	FSP3	838164/004	Rohde & Schwarz
Temperature Chamber	VT 4002	58566002150010	Vötsch
Temperature Chamber	KWP 120/70	59226012190010	Weiss
ThermoHygro Datalogger 03	Opus10 THI (8152.00)	7482	Lufft Mess- und Regeltechnik GmbH

Anechoic Chamber

Equipment	Type	Serial No.	Manufacturer
Air Compressor (pneumatic)			Atlas Copco
Controller	HD 100	100/603	HD GmbH H. Deisel
EMC Camera	CE-CAM/1		CE-SYS
EMC Camera for observation of EUT	CCD-400E	0005033	Mitsubishi
Filter ISDN	B84312-C110-E1		Siemens&Matsushita
Filter telephone systems / modem	B84312-C40-B1		Siemens&Matsushita
Filter Universal 1A	B84312-C30-H3		Siemens&Matsushita
Fully/Semi AE Chamber	10.58x6.38x6		Frankonia
Turntable	DS 420S	420/573/99	HD GmbH, H. Deisel
Valve Control Unit (pneum.)	VE 615P	615/348/99	HD GmbH, H. Deisel



7 layers Bluetooth™ Full RF Test Solution

Bluetooth RF Conformance Test System TS8960

Equipment	Type	Serial No.	Manufacturer
10 MHz Reference	MFS	5489/001	Efratom
Power Meter 832025/059	NRVD	832025/059	Rohde & Schwarz
Power Sensor A 832279/013	NRV-Z1	832279/013	Rohde & Schwarz
Power Sensor B 832279/015	NRV-Z1	832279/015	Rohde & Schwarz
Power Supply	E3632A	MY40003776	Agilent
Power Supply	PS-2403D	-	Conrad
RF Step Attenuator 833695/001	RSP	833695/001	Rohde & Schwarz
Rubidium Frequency Normal	MFS	002	Efratom
Signal Analyzer FSIQ26 832695/007	FSIQ26	832695/007	Rohde & Schwarz
Signal Generator 833680/003	SMP 03	833680/003	Rohde & Schwarz
Signal Generator A 834344/002	SMIQ03B	834344/002	Rohde & Schwarz
Signal Generator B 832870/017	SMIQ03B	832870/017	Rohde & Schwarz
Signal Switching and Conditioning Unit	SSCU	338826/005	Rohde & Schwarz
Signalling Unit PTW60 838312/014	PTW60 for TS8960	838312/014	Rohde & Schwarz
System Controller 829323/008	PSM12	829323/008	Rohde & Schwarz

5 Photo Report



Photo 1: EUT (front side)

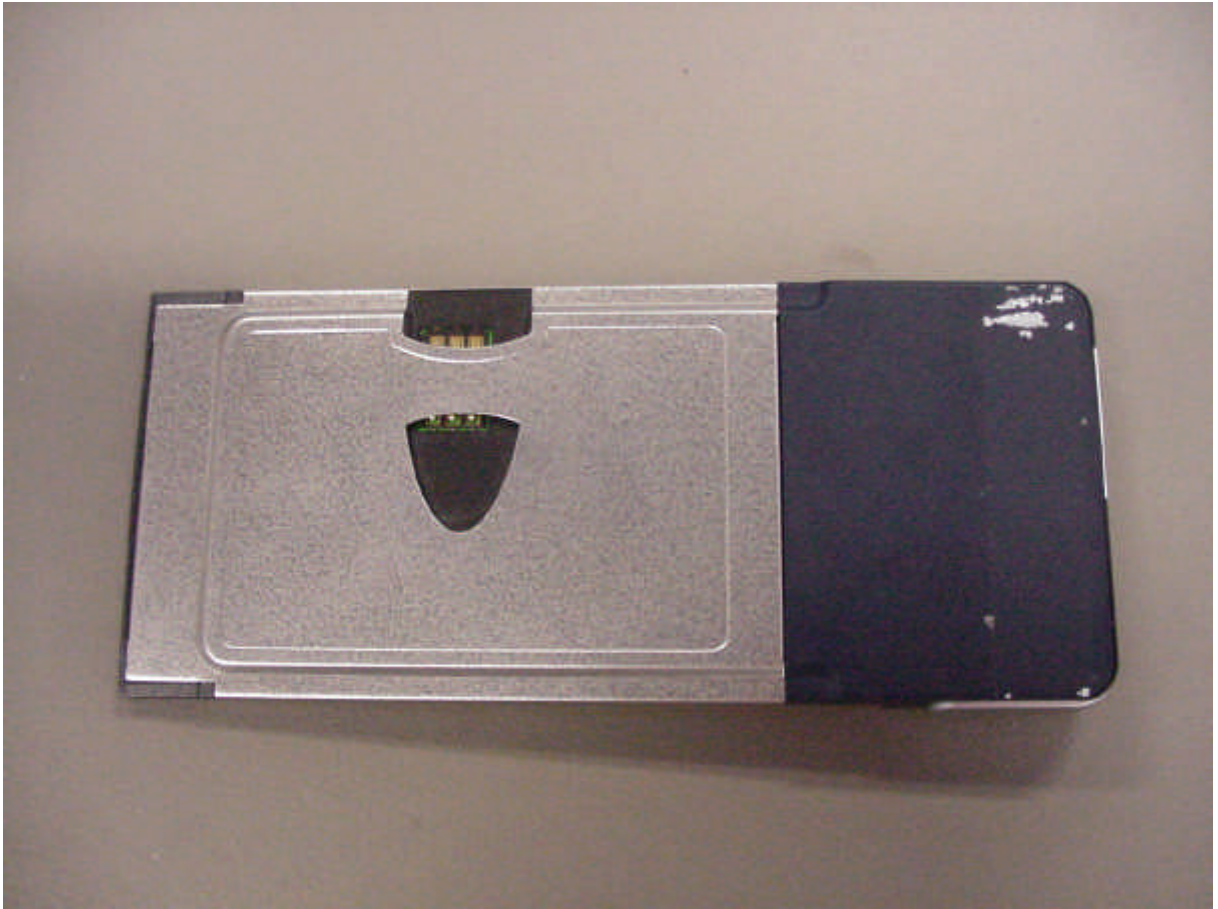

Photo 2: EUT (rear side)

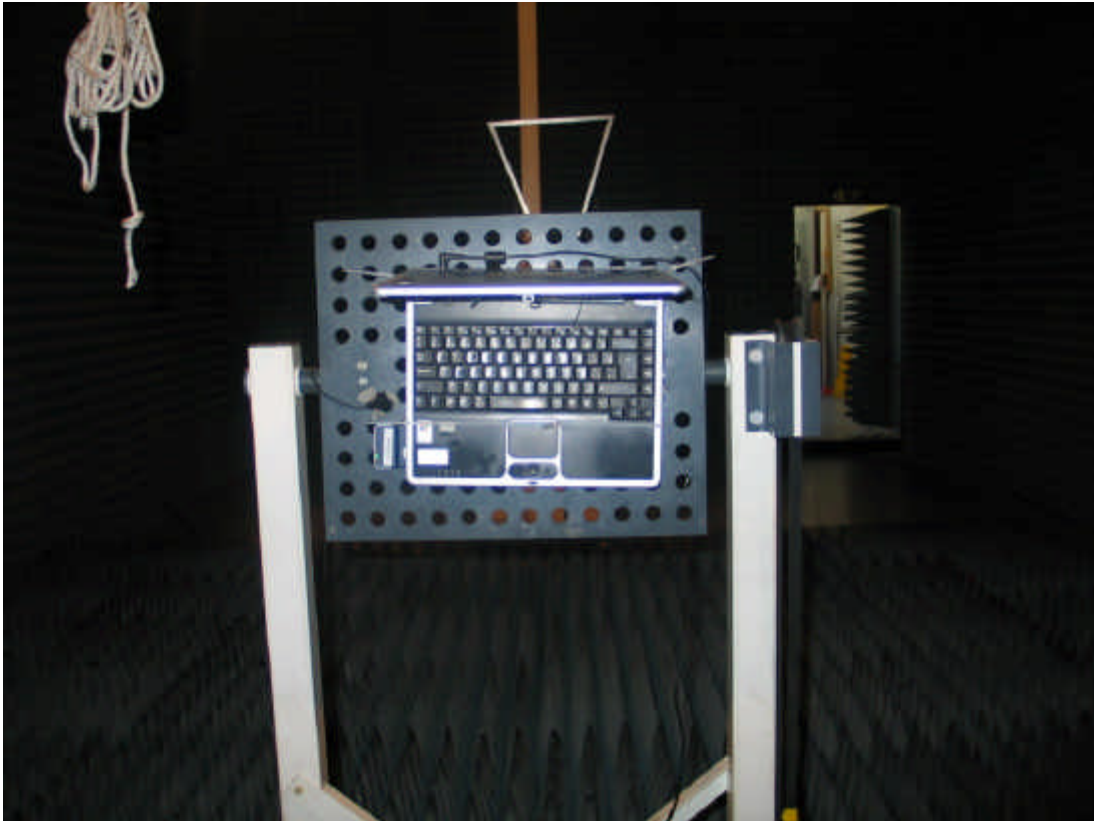
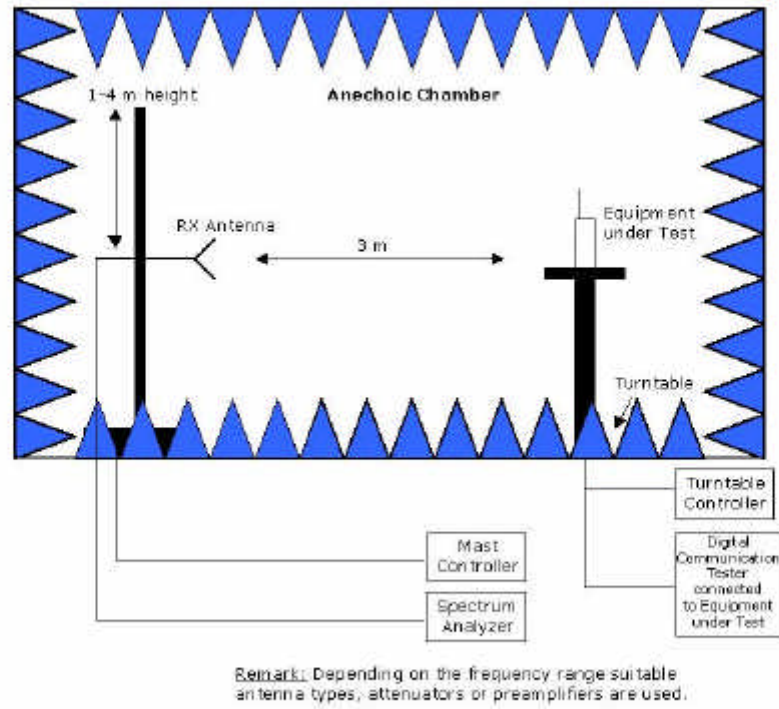
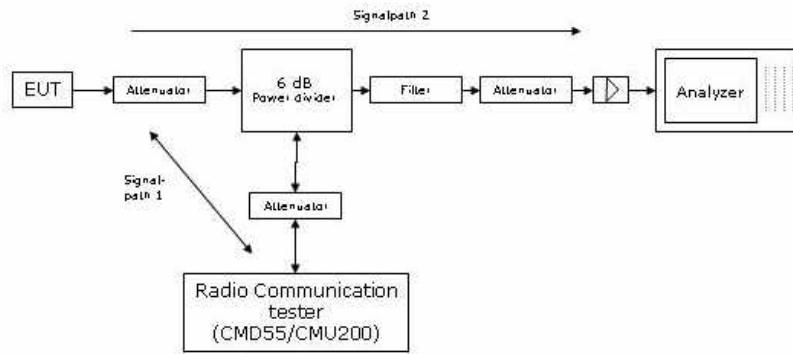

Photo 3: Setup for radiated tests. PCMCIA card in the Laptop (left)

6 Setup Drawings



Drawing 1: Principle setup for radiated measurements.



Remark: Depending on the frequency range suitable attenuators and/or filters and/or amplifiers are used.

Drawing 2: Principle setup for conducted measurements under nominal conditions

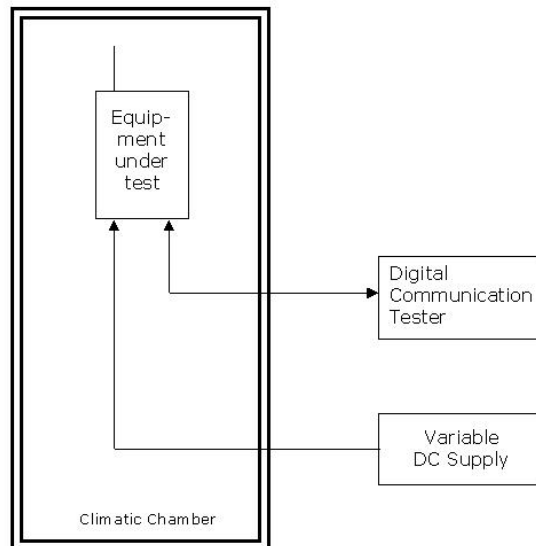

Drawing 3: Principle setup for tests under extreme test conditions

7 Annex

Measurement plots Emission and Occupied Bandwidth

Op. Mode

op-mode 1

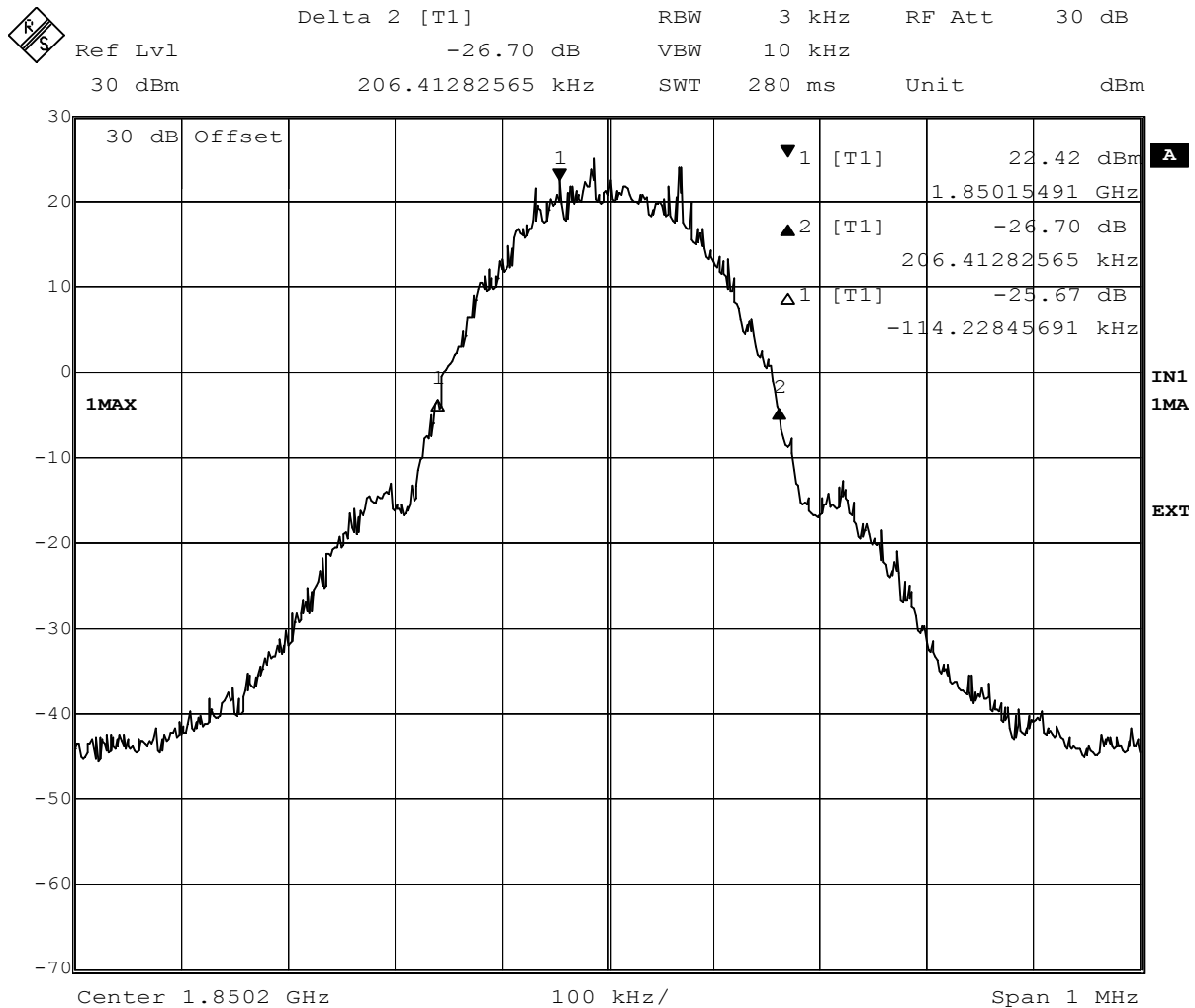

Date: 20.SEP.2005 14:43:49

Test: Emissions bandwidth (26 dB bandwidth), Channel 512 (1850.2 MHz)

Op. Mode

op-mode 1

	Ref Lvl	Marker 1 [T1]	RBW	3 kHz	RF Att	30 dB
	30 dBm	22.83 dBm	VBW	10 kHz		
		1.85022906 GHz	SWT	280 ms	Unit	dBm

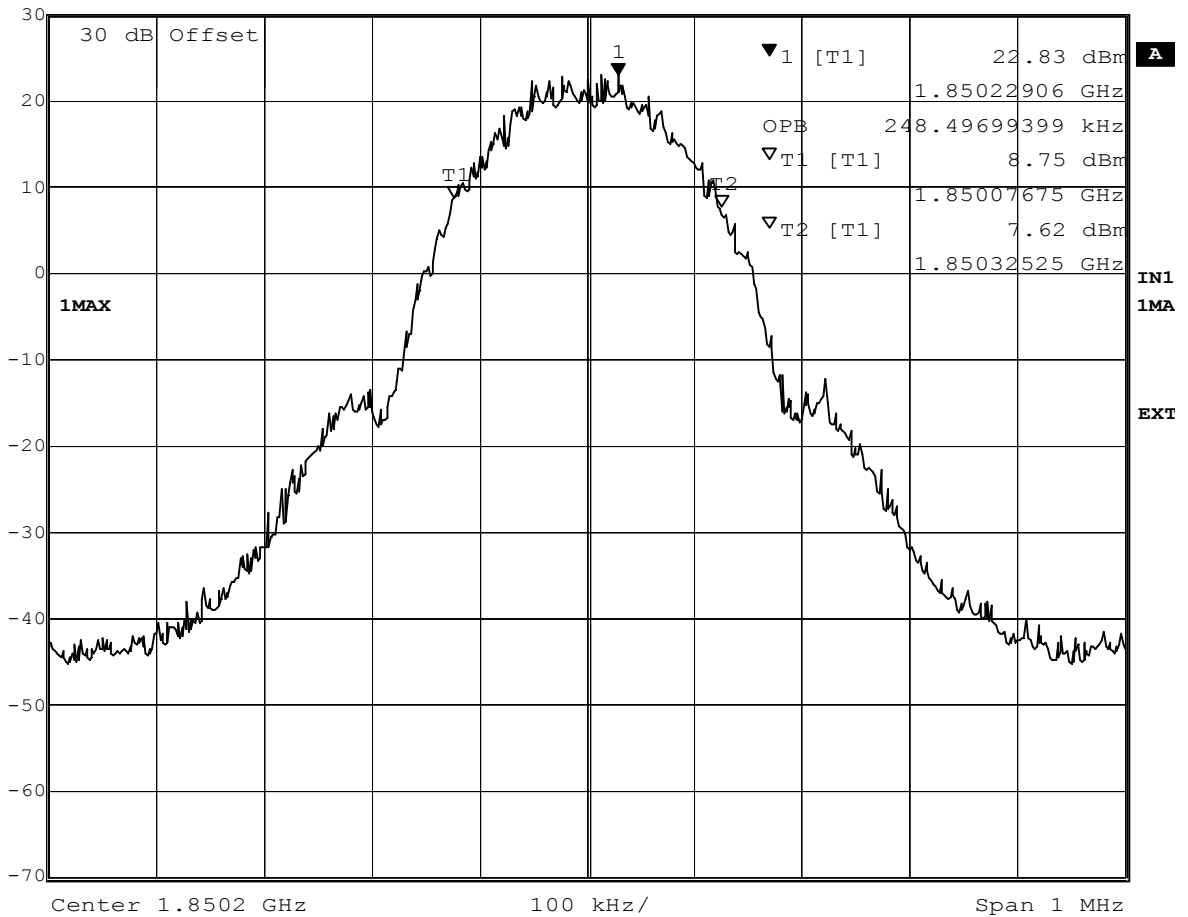

Date: 20.SEP.2005 15:02:06

Test: Occupied bandwidth, Channel 512 (1850.2 MHz)

Op. Mode

op-mode 2

	Delta 2 [T1]	RBW	3 kHz	RF Att	30 dB
Ref Lvl	-26.45 dB	VBW	10 kHz		
30 dBm	90.18036072 kHz	SWT	280 ms	Unit	dBm

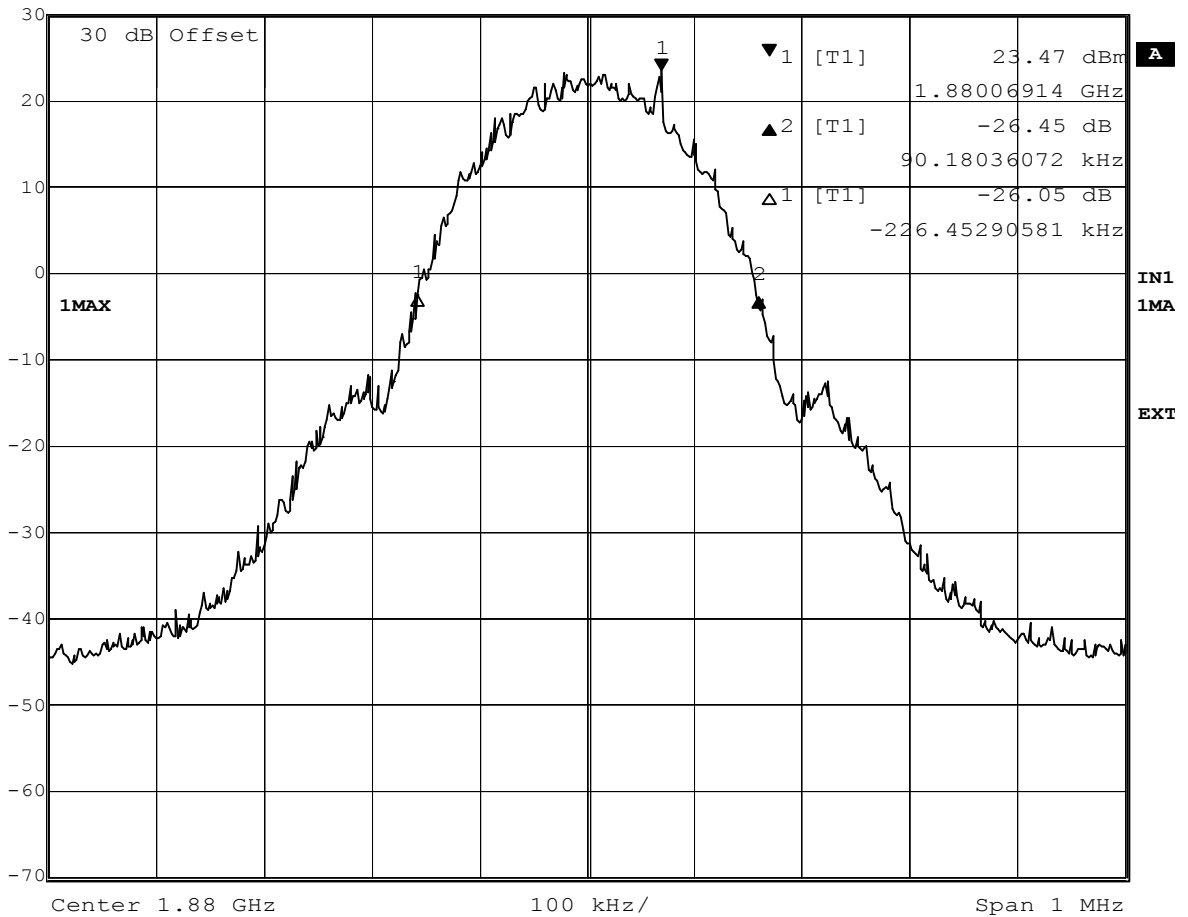

Date: 20.SEP.2005 14:55:52

Test: Emissions bandwidth (26 dB bandwidth), Channel 661 (1880.0 MHz)

Op. Mode

op-mode 2

	Marker 1 [T1]	RBW	3 kHz	RF Att	30 dB
Ref Lvl	24.01 dBm	VBW	10 kHz		
30 dBm	1.88006713 GHz	SWT	280 ms	Unit	dBm

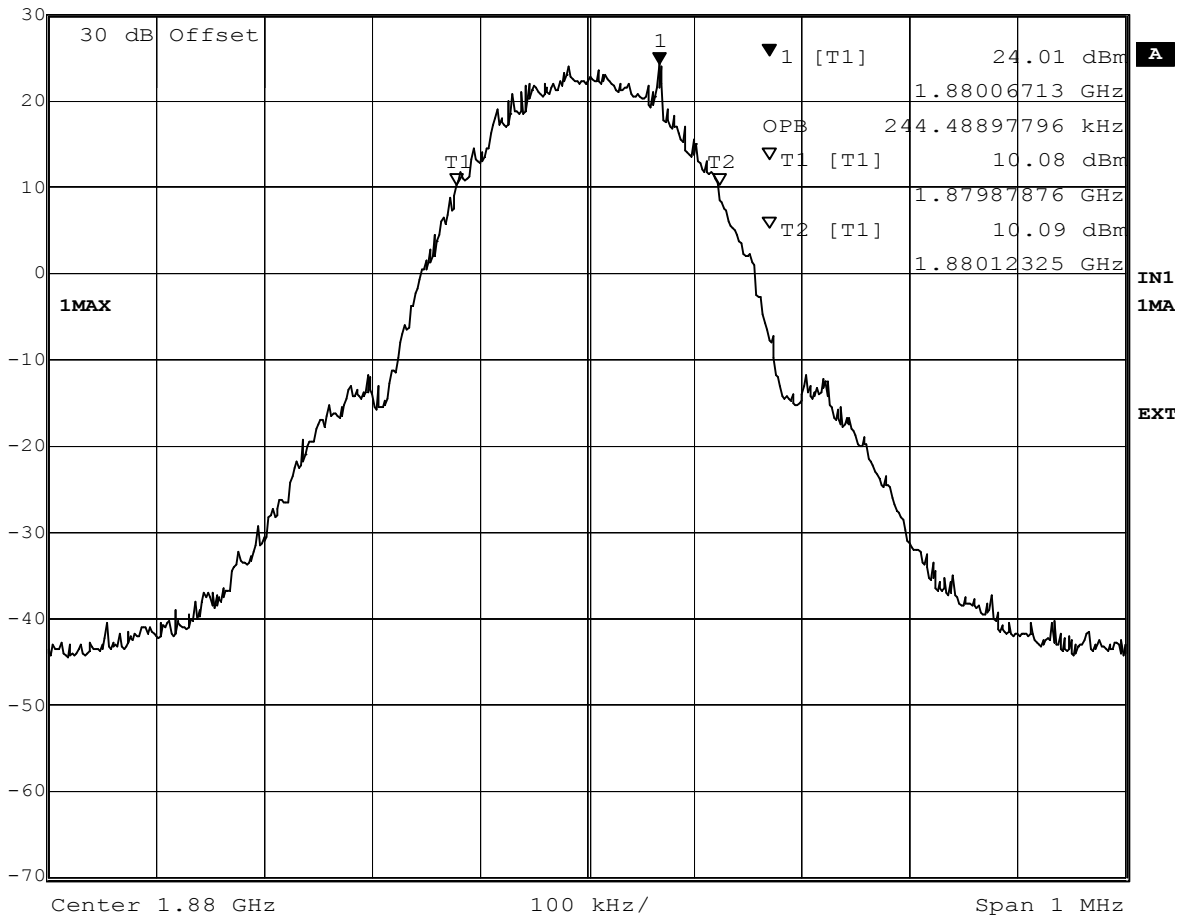

Date: 20.SEP.2005 15:00:02

Test: Occupied bandwidth, Channel 661 (1880.0 MHz)



Op. Mode

op-mode 3

	Delta 2 [T1]	RBW	3 kHz	RF Att	30 dB
Ref Lvl	-27.96 dB	VBW	10 kHz		
30 dBm	90.18036072 kHz	SWT	280 ms	Unit	dBm

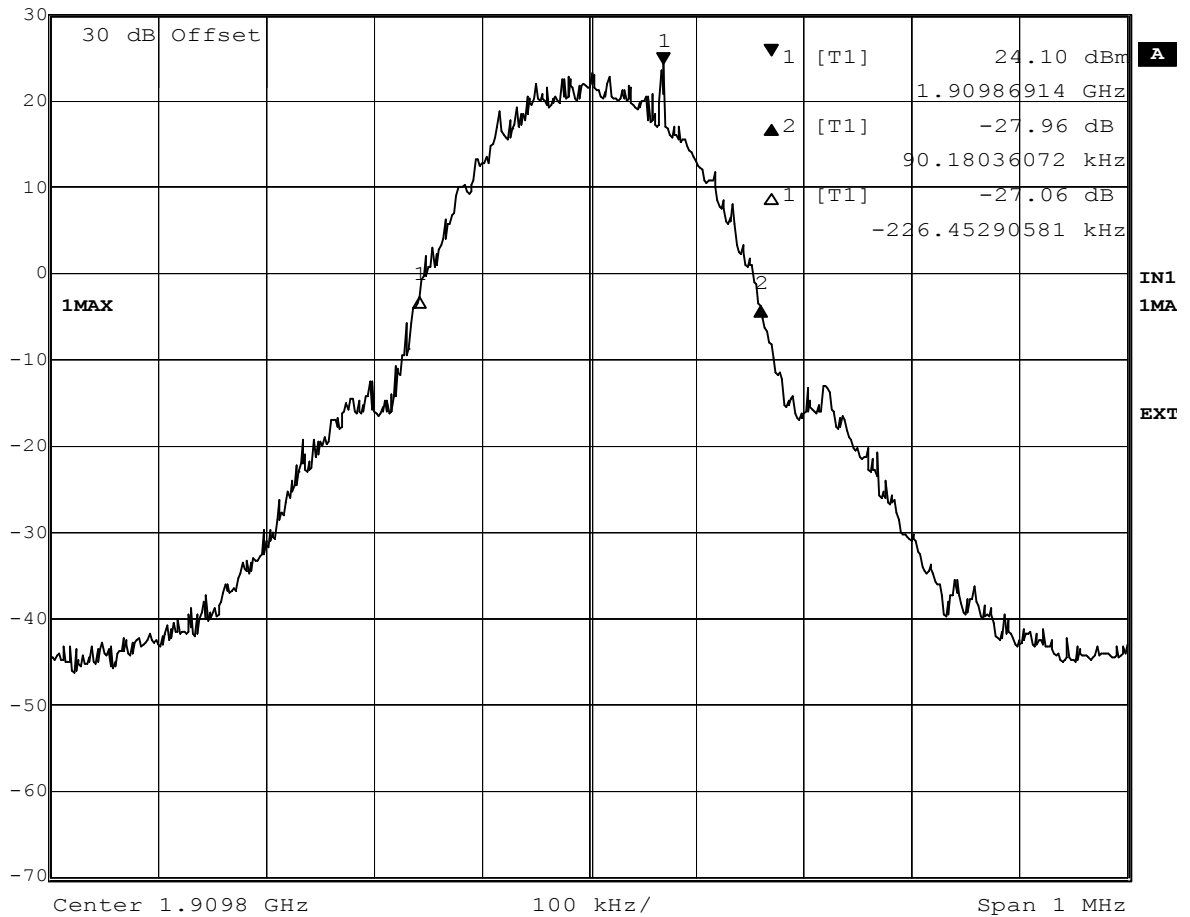

Date: 20.SEP.2005 14:52:49

Test: Emissions bandwidth (26 dB bandwidth), Channel 810 (1909.8 MHz)

Op. Mode

op-mode 3

	Marker 1 [T1]	RBW	3 kHz	RF Att	30 dB
Ref Lvl	24.35 dBm	VBW	10 kHz		
30 dBm	1.90986914 GHz	SWT	280 ms	Unit	dBm

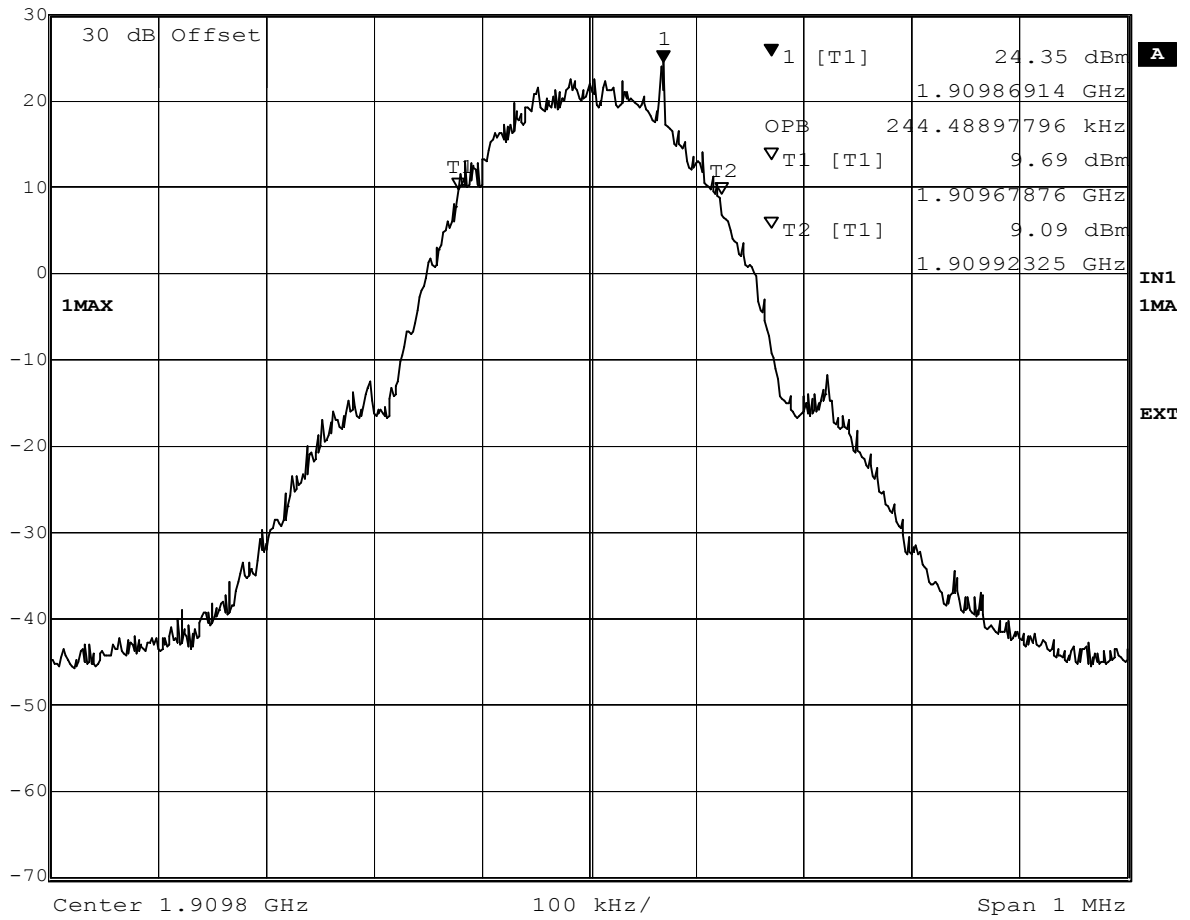

Date: 20.SEP.2005 15:04:33

Test: Occupied bandwidth, Channel 810 (1909.8 MHz)

Op. Mode

op-mode 4

RS	Delta 2 [T1]	RBW	3 kHz	RF Att	30 dB
	Ref Lvl	-27.54 dB	VBW	10 kHz	
	30 dBm	158.31663327 kHz	SWT	280 ms	Unit dBm

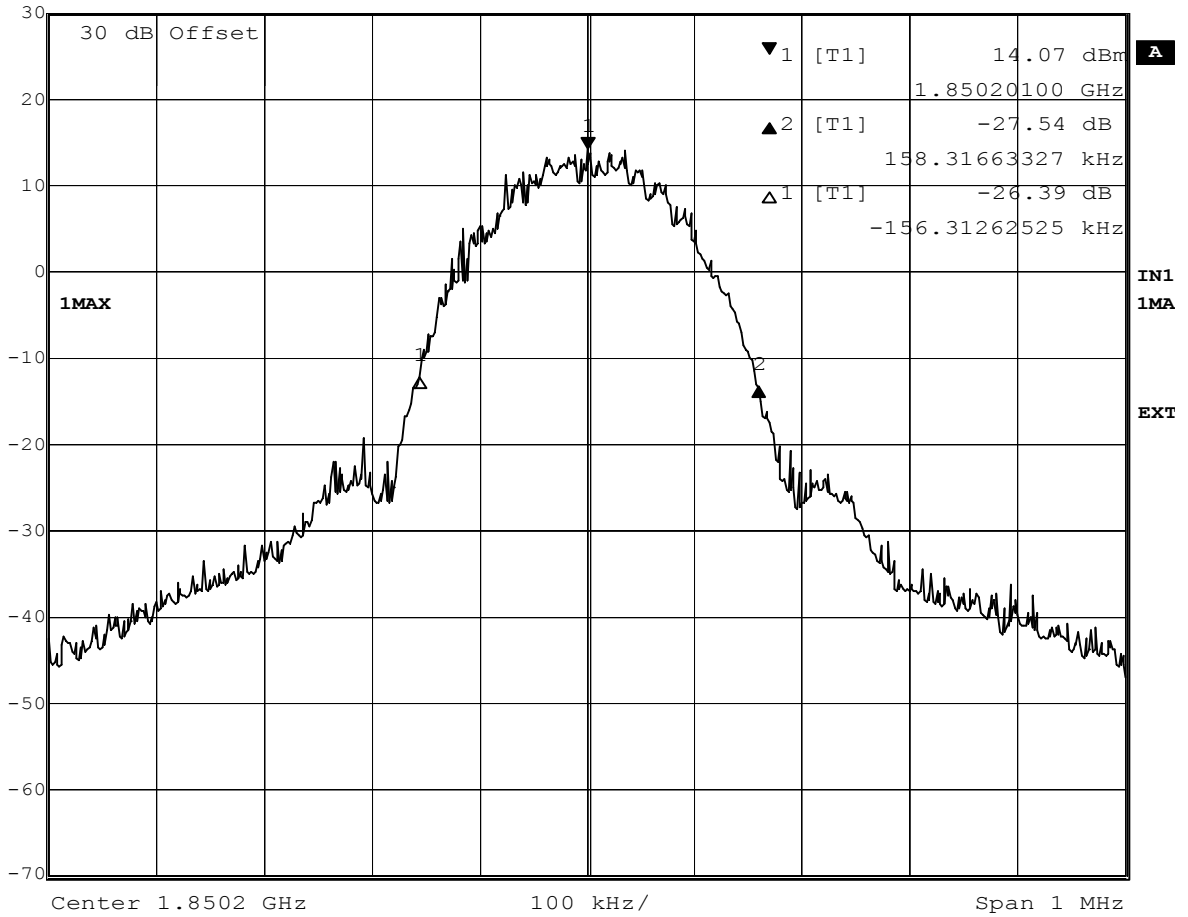

Date: 20.SEP.2005 19:59:24

Test: Emissions bandwidth (26 dB bandwidth), Channel 512 (1850.2 MHz)

Op. Mode

op-mode 4

RS	Marker 1 [T1]	RBW	3 kHz	RF Att	30 dB
	Ref Lvl	14.07 dBm	VBW	10 kHz	
	30 dBm	1.85020100 GHz	SWT	280 ms	Unit dBm

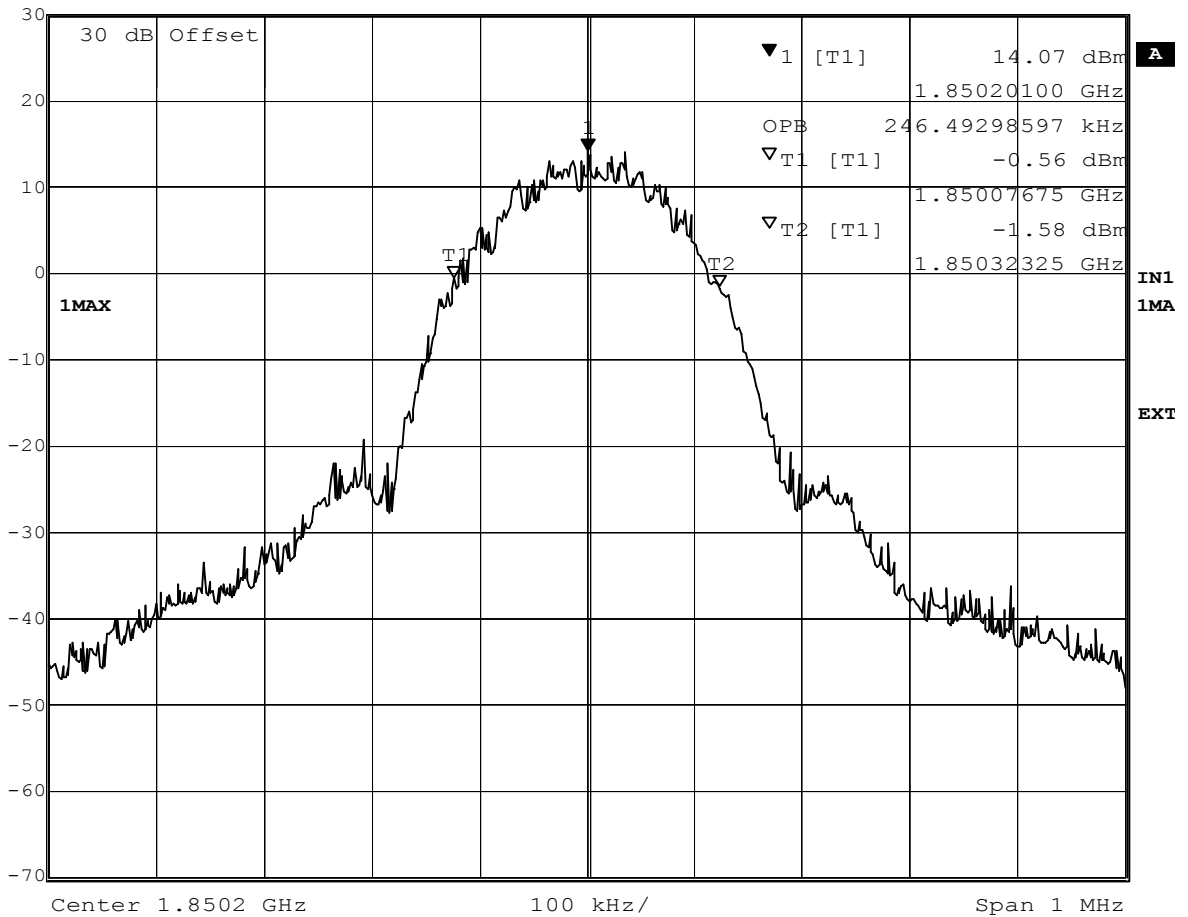

Date: 20.SEP.2005 19:58:24

Test: Occupied bandwidth, Channel 512 (1850.2 MHz)

Op. Mode

op-mode 5

	Delta 2 [T1]	RBW	3 kHz	RF Att	30 dB
Ref Lvl	-27.11 dB	VBW	10 kHz		
30 dBm	196.39278557 kHz	SWT	280 ms	Unit	dBm

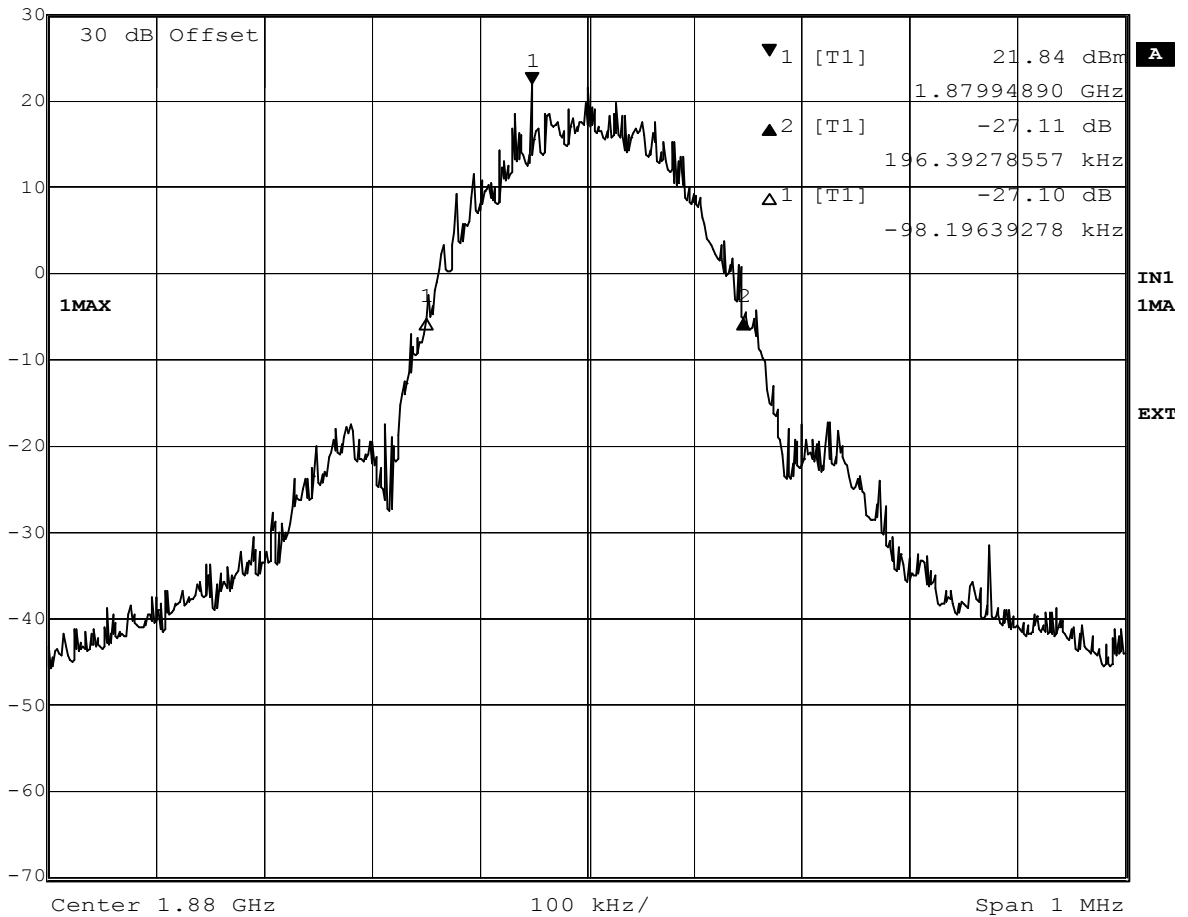

Date: 20.SEP.2005 20:11:27

Test: Emissions bandwidth (26 dB bandwidth), Channel 661 (1880.0 MHz)

Op. Mode

op-mode 5

	Marker 1 [T1]	RBW	3 kHz	RF Att	30 dB
Ref Lvl	21.84 dBm	VBW	10 kHz		
30 dBm	1.87994890 GHz	SWT	280 ms	Unit	dBm

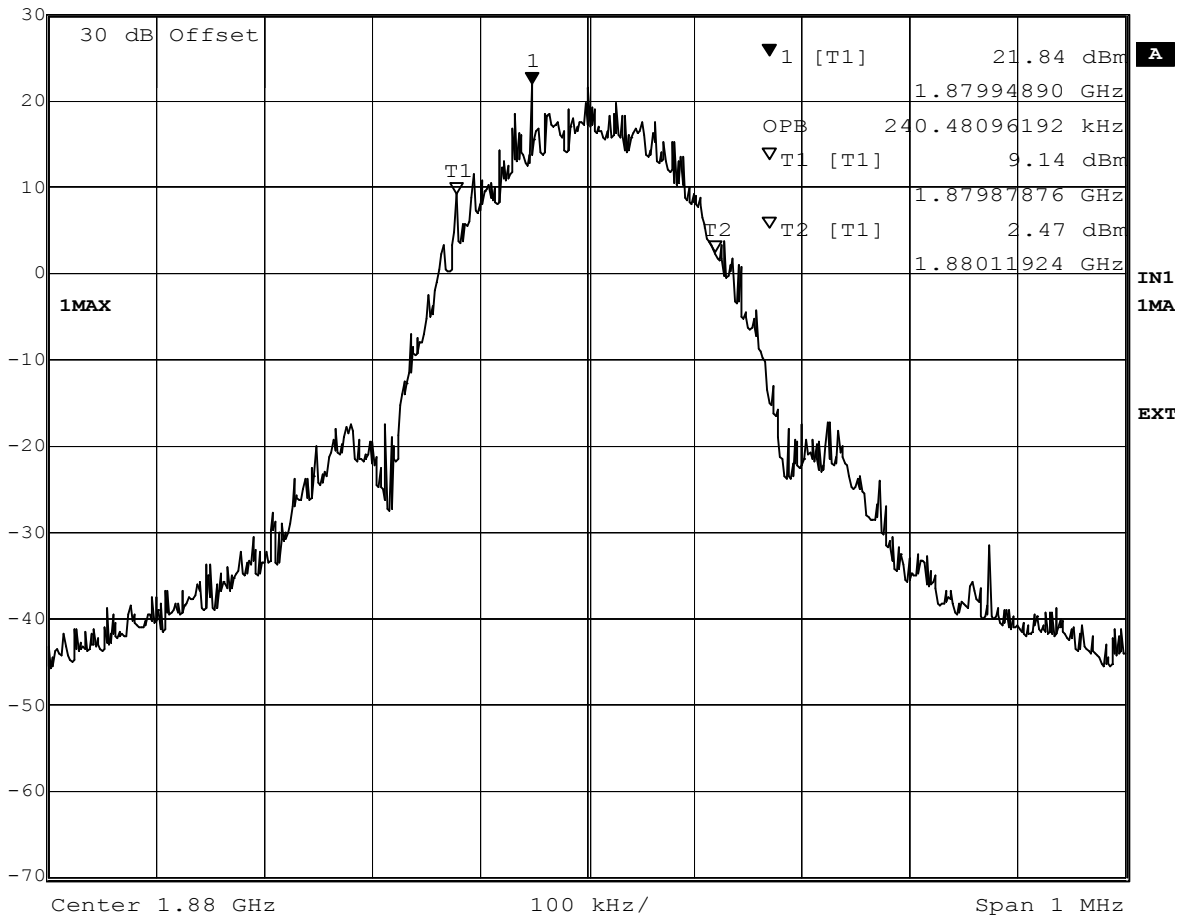

Date: 20.SEP.2005 20:10:28

Test: Occupied bandwidth, Channel 661 (1880.0 MHz)



Op. Mode

op-mode 6

RS	Marker 1 [T1]	RBW	3 kHz	RF Att	30 dB
	Ref Lvl	22.35 dBm	VBW	10 kHz	
	30 dBm	1.90978297 GHz	SWT	280 ms	Unit dBm

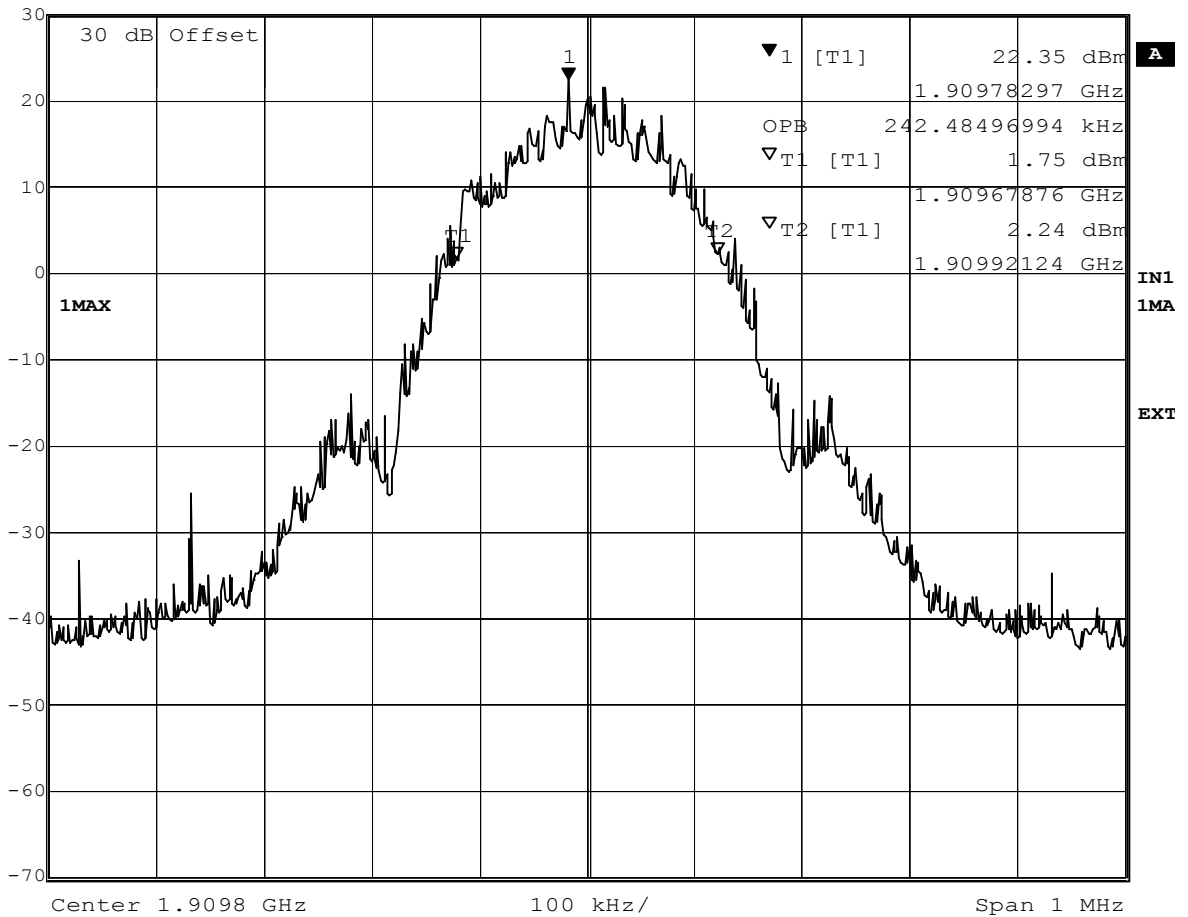

Date: 20.SEP.2005 20:15:41

Test: Occupied bandwidth, Channel 810 (1909.8 MHz)