

DATE : 2006/01/23

CUSTOMER : CLEVO CO.

# APPROVAL SHEET

<b>MODEL</b>	M590K
<b>DESCRIPTION</b>	PIFA For Bluetooth Antenna 2.4~2.5GHZ / 4.9~5.875GHZ
<b>SUPPLIER P/N</b>	K05007001501
<b>CUSTOMER P/N</b>	6-23-7M59K-021
<b>FILE P/N</b>	

FAVORTRON			CUSTOMER	
<b>Manager</b>	<b>Supervisor</b>	<b>Engineer</b>		
Nick	James	James		



**惠貿電子股份有限公司**  
**FAVORTRON CO., LTD**

台北縣新店市民權路 108-1 號 4F  
4F, No. 108-1, Minchziuan Rd., SHzindian City,  
Taipei HZsien 231, Taiwan. R.O.C

TEL: (02) 2218-2189  
FAX: (02) 2218-5420  
[URL: www.fvc.com.tw](http://www.fvc.com.tw)

# 1. DRAWING ASSEMBLY

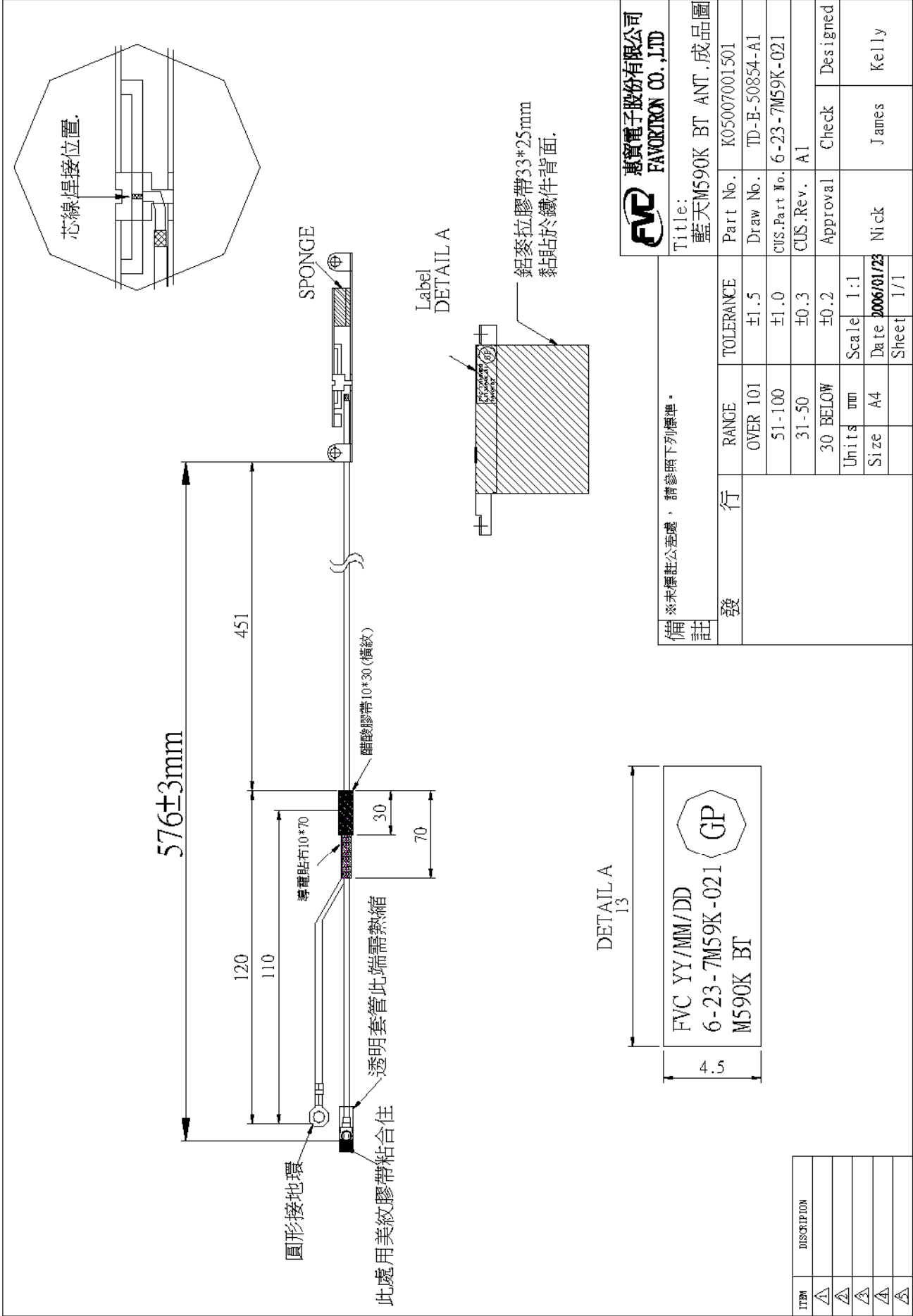

# BOM

## B O M

ITEM	COMPONENT	Q'TY	DESCRIPTION	FAVORTRON P/N	VENDER
1	同軸線(含接頭)	1	OD1.13mm/單頭I-PEX/595mm/灰色	M04007085001	FVC
2	SPONGE	1	8mm*3mm*t=3.5mm	M01009001002	東鋒
3	M540G-LEFT-PIFA 鐵件	1	進口馬口鐵t=0.4mm/H	M02007003001	品欣
4	TUBE	1	2.5*0.2t*20mm(透明)	B02018002094	漢保
5	鋁麥拉膠帶	1	30mm*25mm t=0.1 (鋁箔面導電膠3.2mm*5mm)	M01005001002	隆揚
6	美紋膠帶	1	10寬*10長(mm)/整卷型	M01016001002	聯達
7	圓形接地環	1	OD4.7/ID2.6/19.3 26#PTC電子線總長110(銅線長度20mm)	L05001006002	信盛
8	醋酸膠帶	1	10*30mm	G01002086002	鴻城
9	導電貼布	1	導電貼布 10*70mm	G01001162002	嘉得隆
10					
11					
12					

### SUB BOM (L05001006002)

16	UL1571 AWG#32電子線	1	UL1571 AWG#32電子線(黑色101mm)	M04002012001	樂庭
17	圓盤端子	1	圓盤端子 STM 125BS-2	B05001012001	信盛

### SUB BOM (M04007069001)

ITEM	COMPONENT	Q'TY	DESCRIPTION	FAVORTRON P/N	VENDER
1	Connector	1	接頭 MHF PLUG(I-PEX)鍍金(20278-111R-13)	L07001001001	I-PEX
2	同軸線	1	同軸線OD1.13*594mm(灰色)	G04005033001	日立信電



Title: 藍天MS90K BT BOM 表

Part No.	K05007001501
Draw No.	TD-E-50854-A1
CUS.Part No.	6-23-7MS9K-021
CUS.Rev.	A1
Approval	Check
Designed	James Kelly
Nick	James Kelly

發 行 備 註

機 密

廠內專用

ITEM	DESCRIPTION
△	
△	
△	
△	
△	

Date 2005/12/13 Sheet 1/1

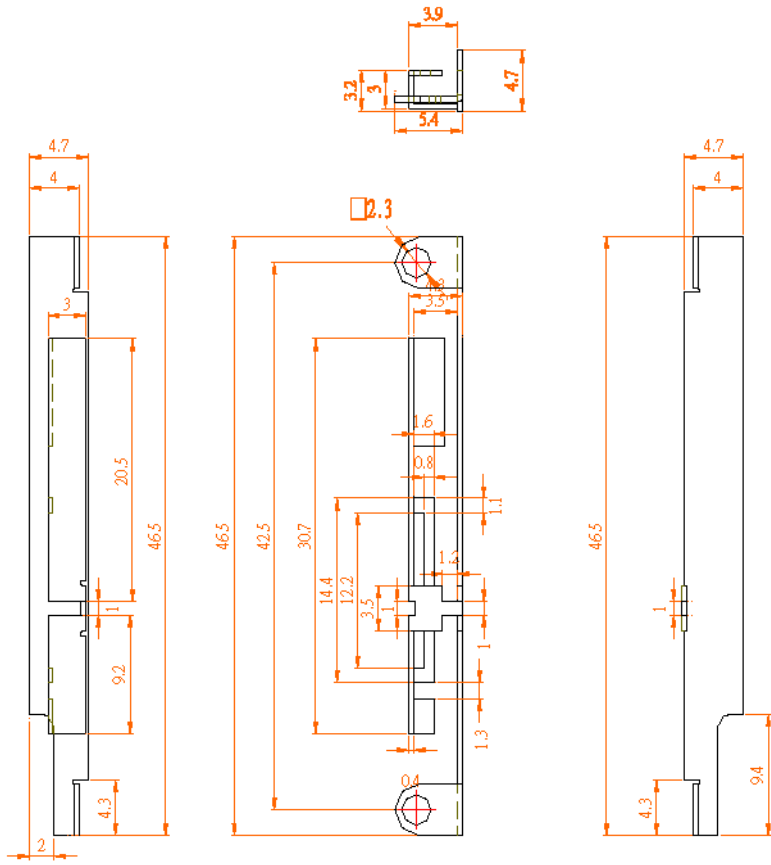

Remark:

1. MATERIAL : 馬口鐵
2. t = 0.4mm ±0.05
3. 表面不得有毛邊
4. 外觀不得有壓傷油污刮傷手紋
5. 未標示公差範圍者請詳公差欄標示值。



惠質電子股份有限公司  
FAVORTRON CO., LTD.

TITLE:

藍天M540G-LEFT-PIFA

PART NO. M02007003001

DRAW NO. TD-E-50657-A1

Customer No.

Customer REV.

APPROVAL

CHECKED

DRAWN

備註  
※未標註公差處，請參照下列標準。

發行		RANGE	TOLERANCE
Over 101		±1.5	
51-100		±1.0	
31-50		±0.3	
30 Below		±0.2	
Units	MM	Rev.	A0
Size	A4	Scale	1:1
Sheet	PAGE		

James

Nick

Kelly

# 天線測試方法

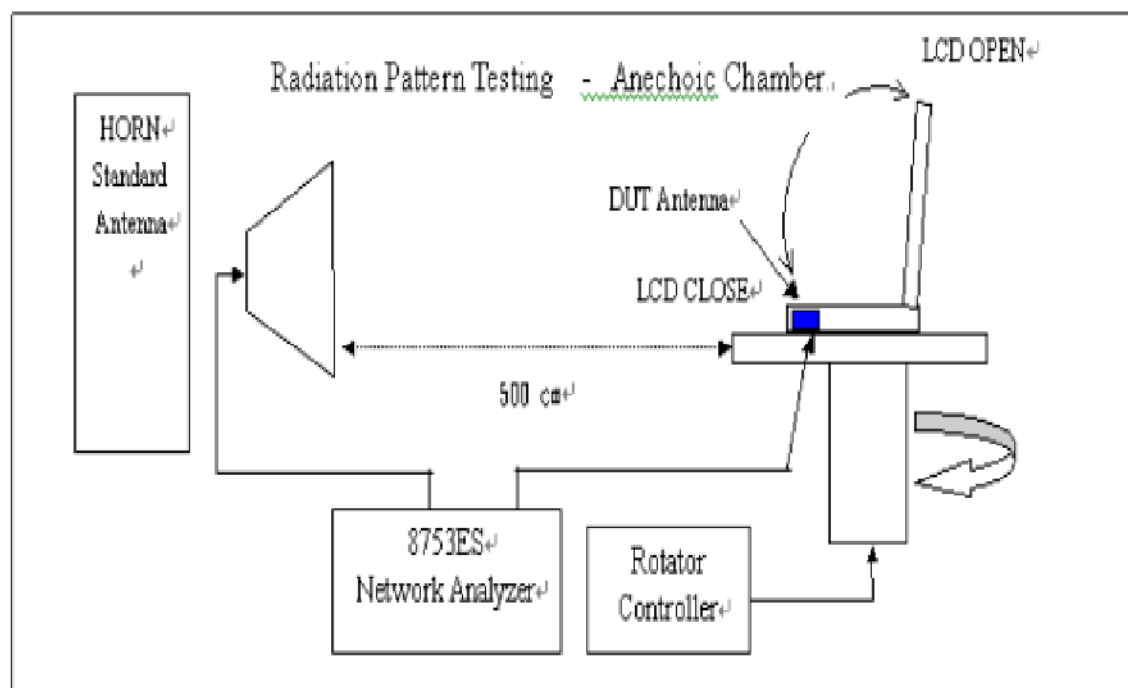

## Coordinate Definition

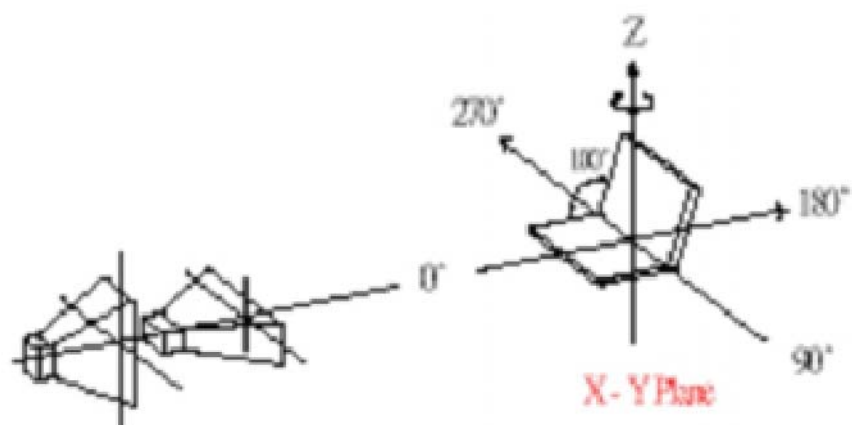
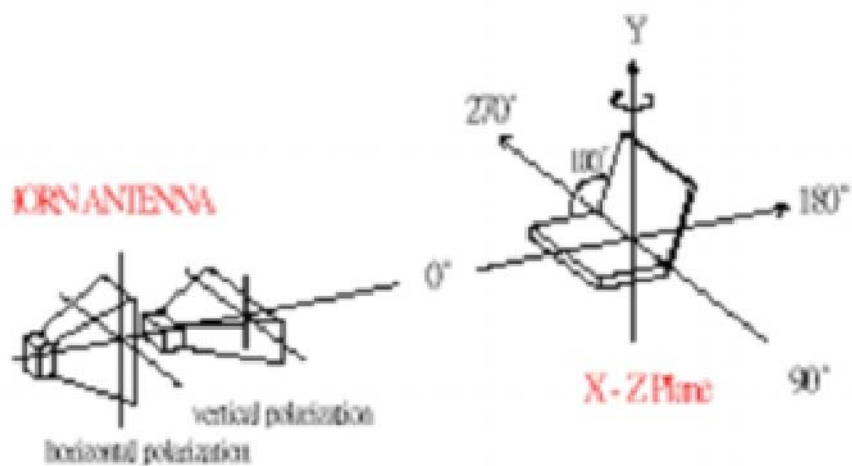
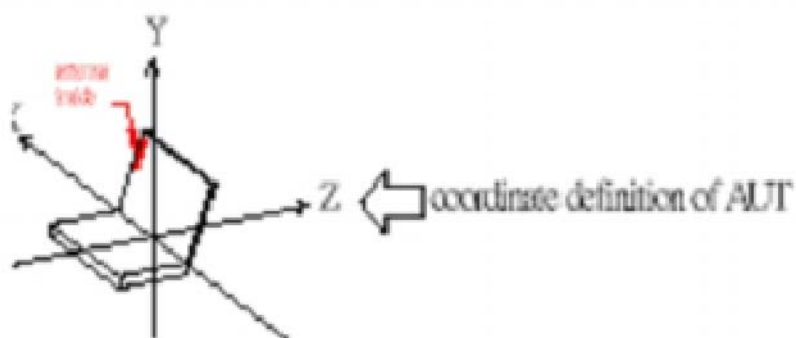

## 2. Wireless LAN Ant./ (Left )

### 2.4~2.5GHZ / Return Loss

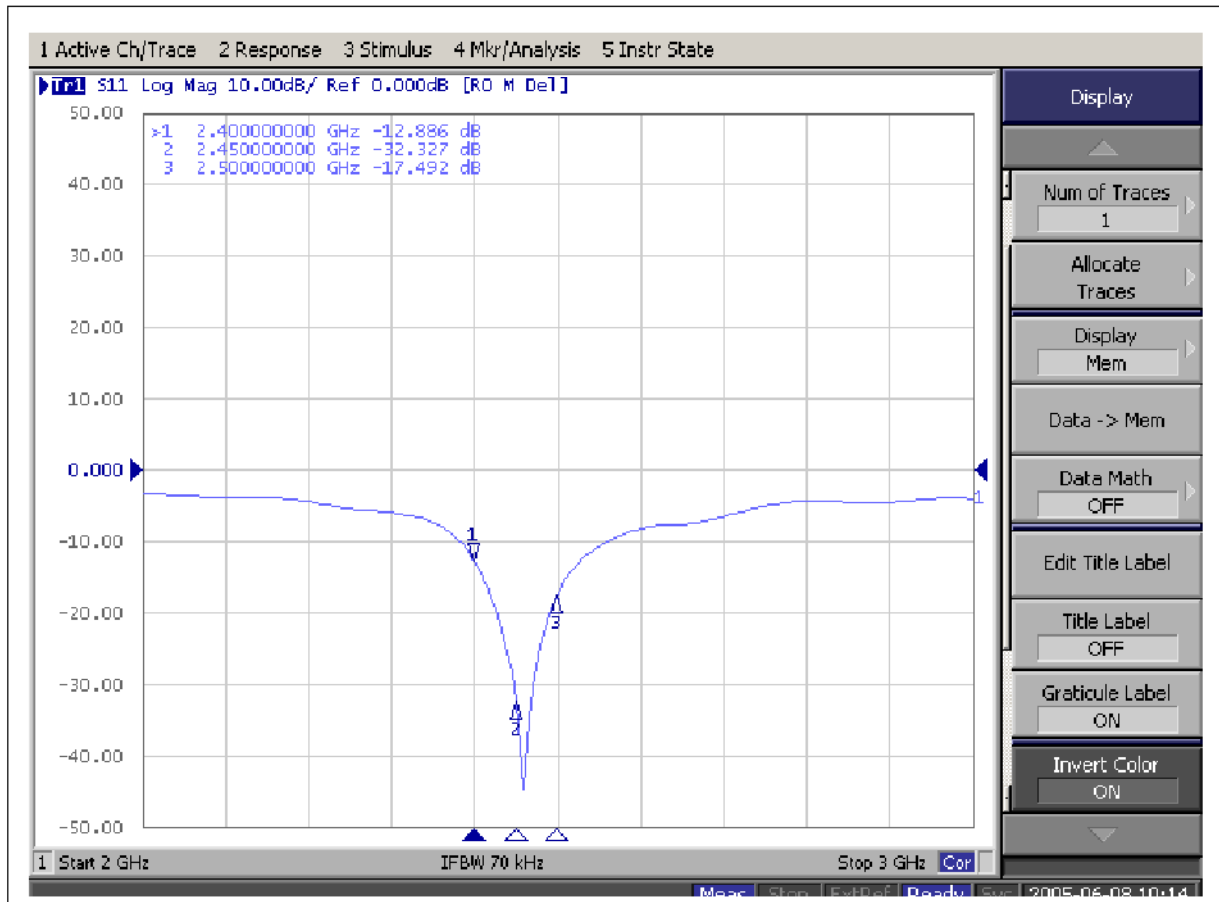

### 2.4~2.5GHZ / VSWR

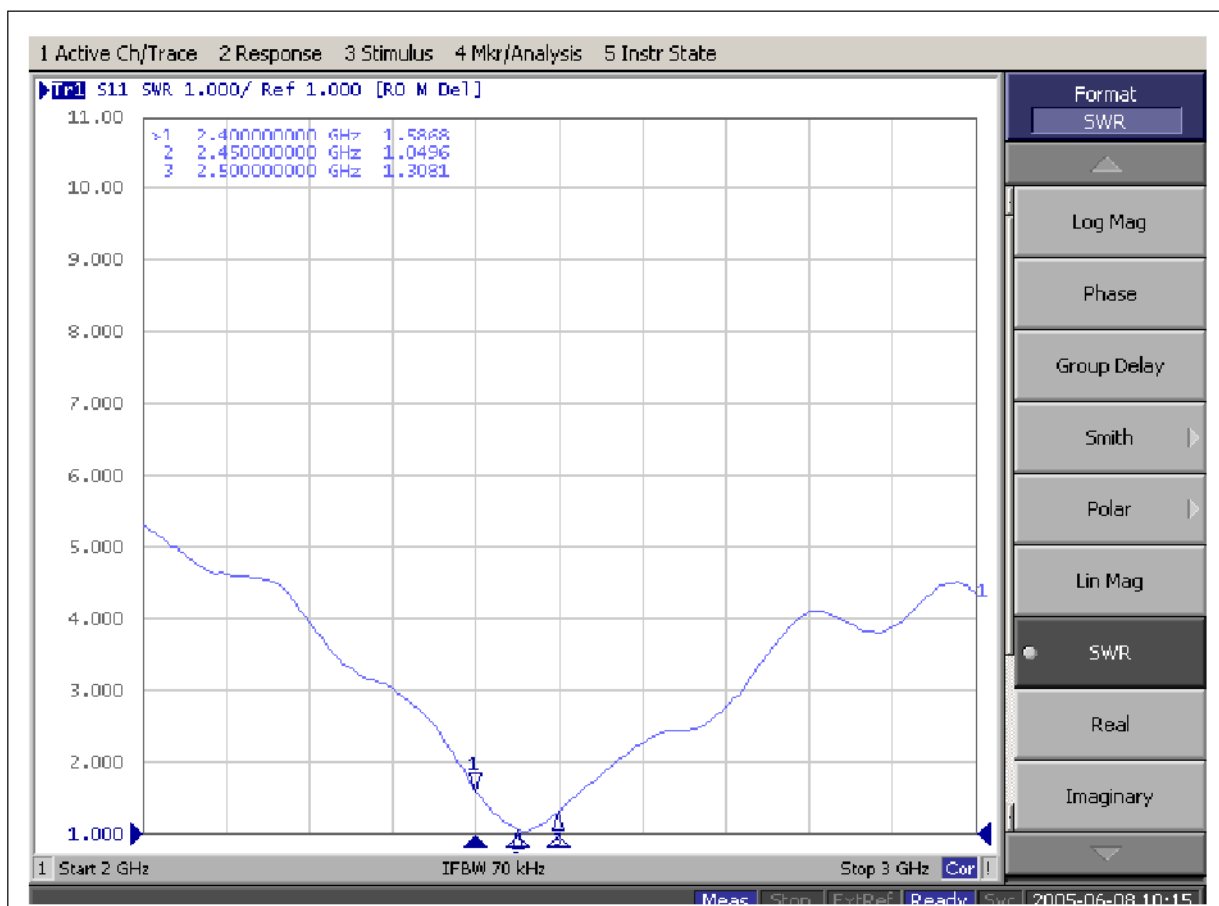

# Wireless LAN Ant./ (Left)

## 5.15~5.875GHZ/Return Loss

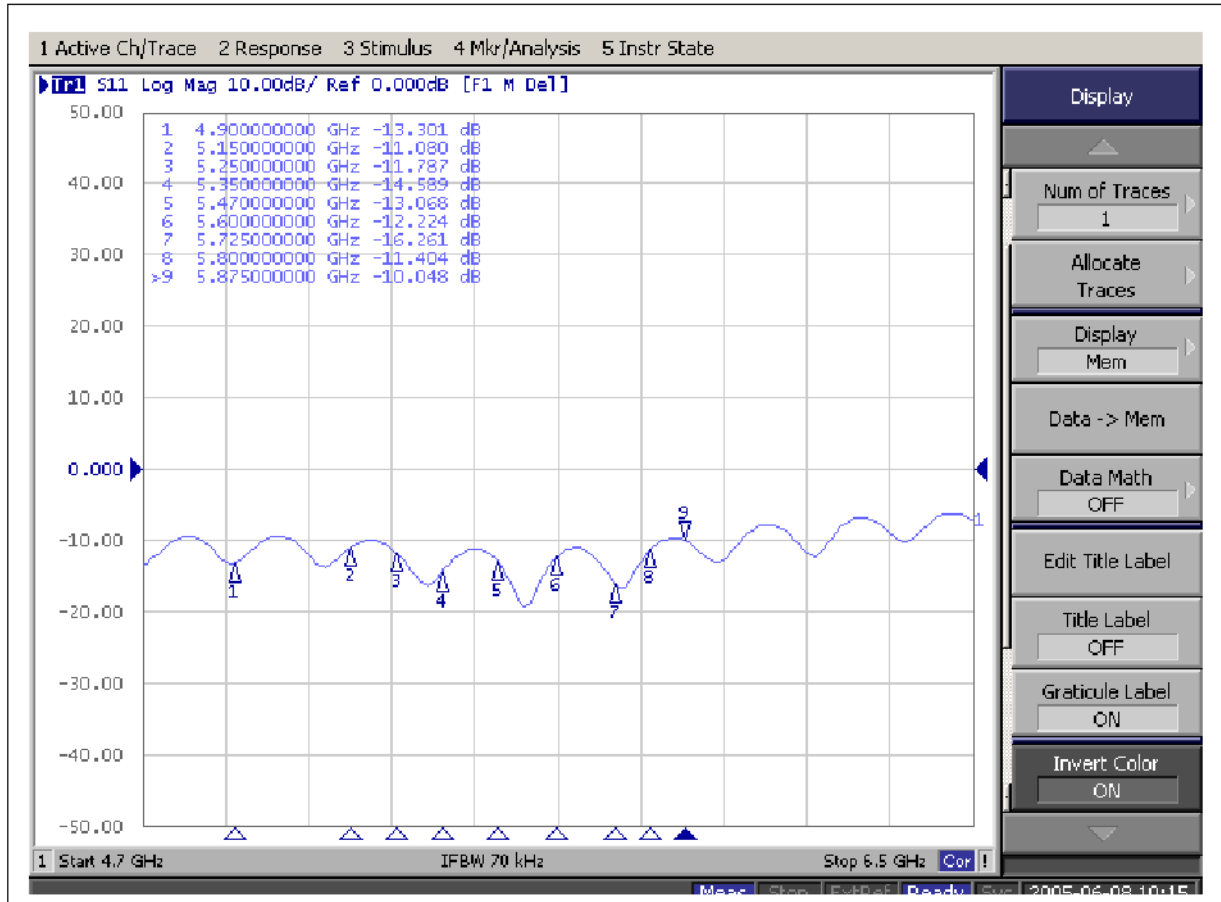

## 5.15~5.875GHZ/NSWR

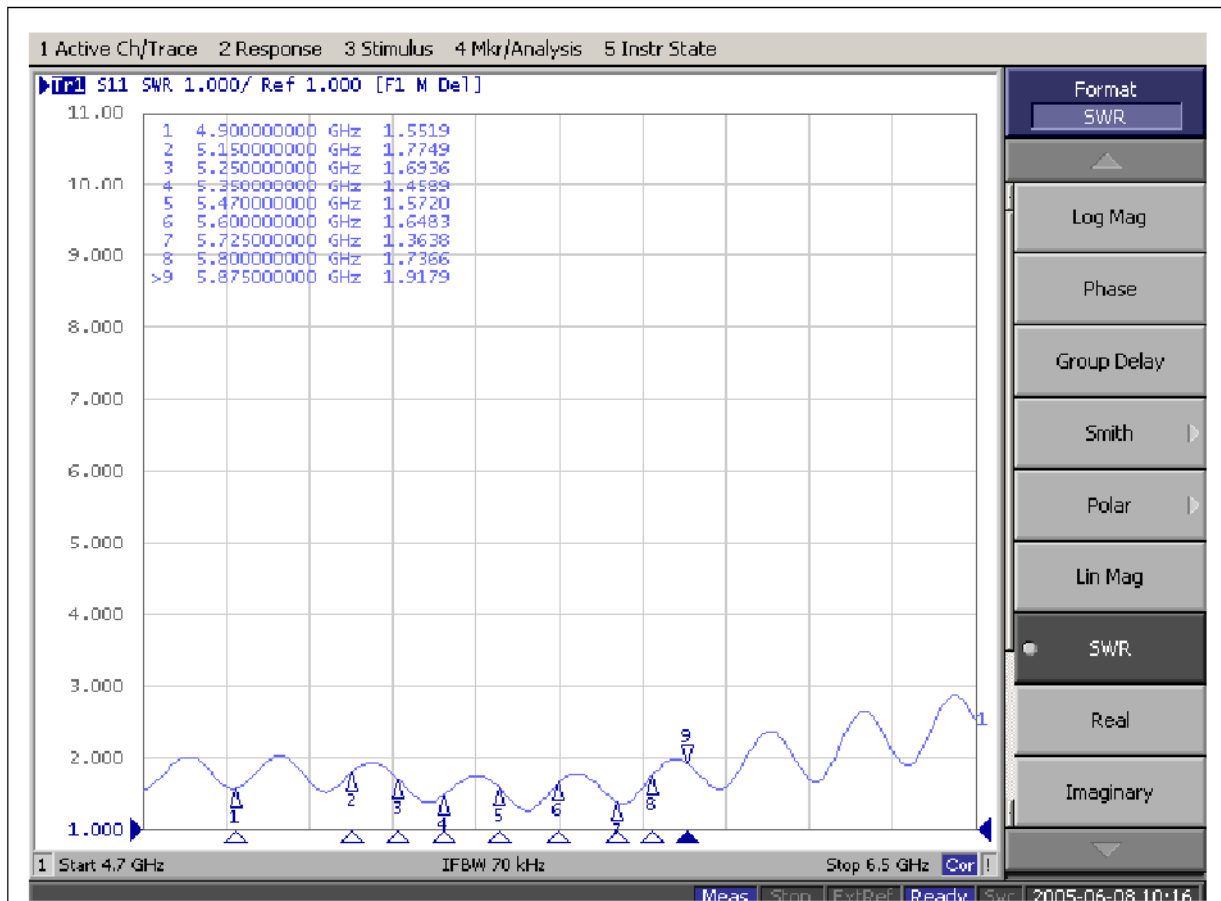



# Wireless LAN Ant./ (Left )

## 2.4~2.5GHZ & 5.15~5.875GHZ / Return Loss

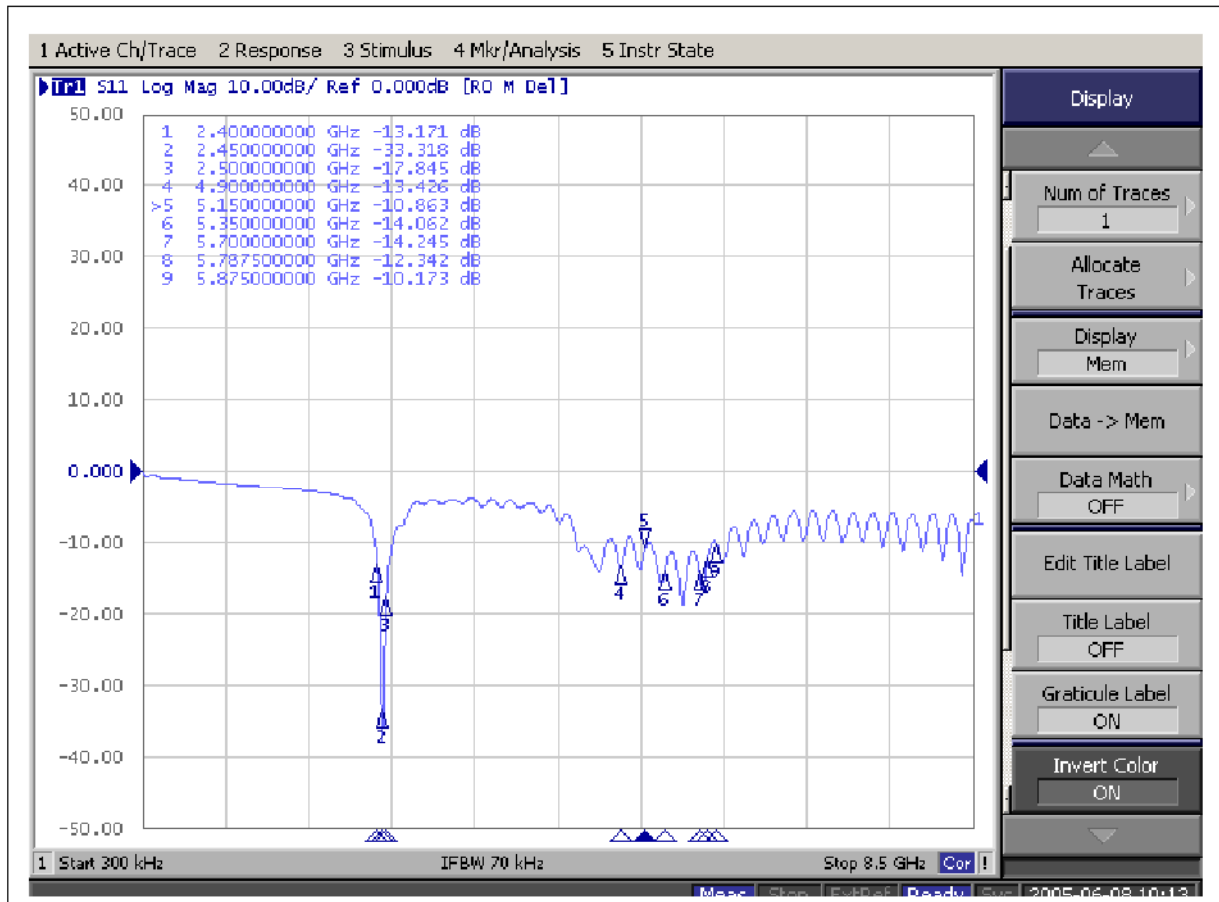

## 2.4~2.5GHZ & 5.15~5.875GHZ/VSWR

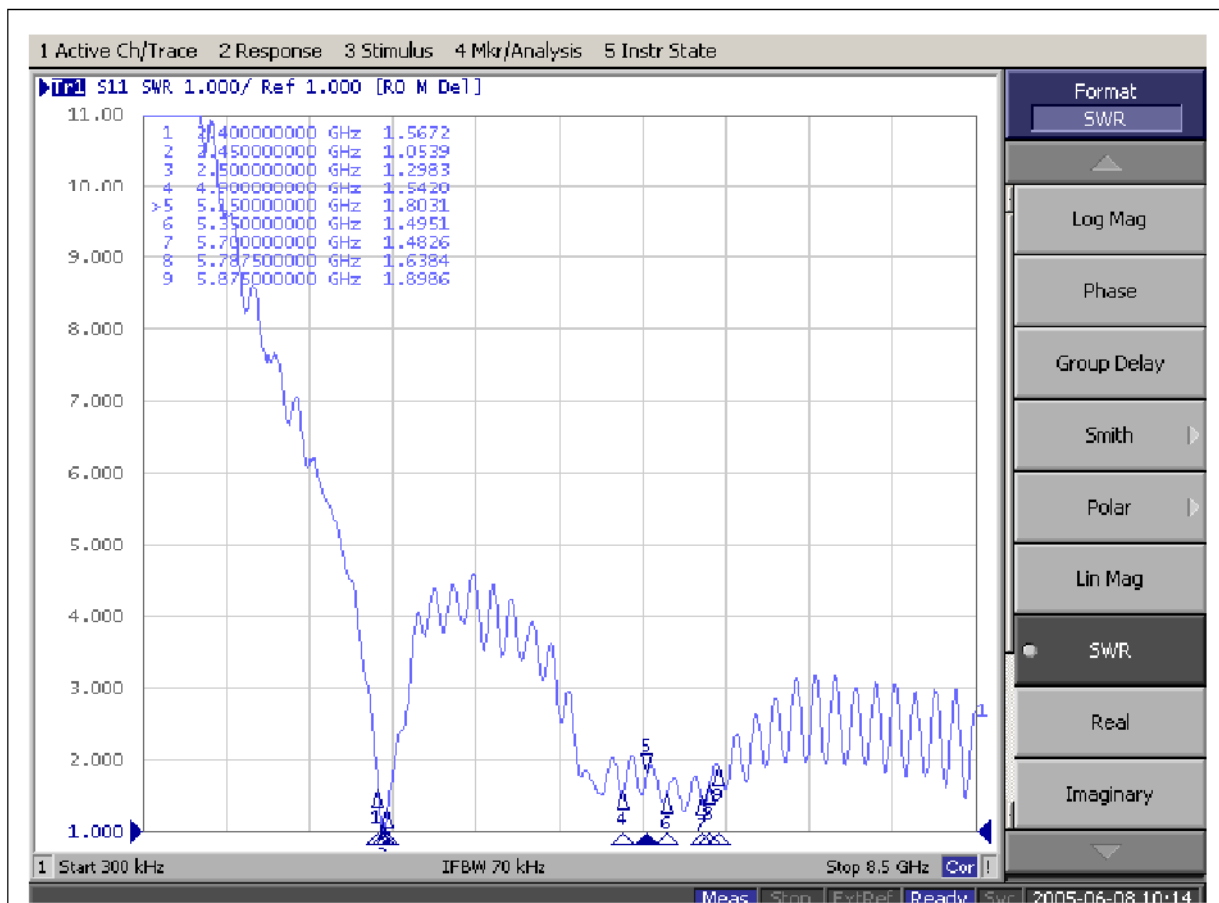

### 3. Gain & Pattern –Wireless LAN

#### a. 2.4GHz



## FAVORTRON Co. Ltd

### Antenna Pattern Measurement

4F, No. 108-1, Min Chuan Rd., Hsin-Tien City, Taipei, Taiwan, R.O.C. Tel:886-2-2218-2189, Fax:886-2-2218-5760

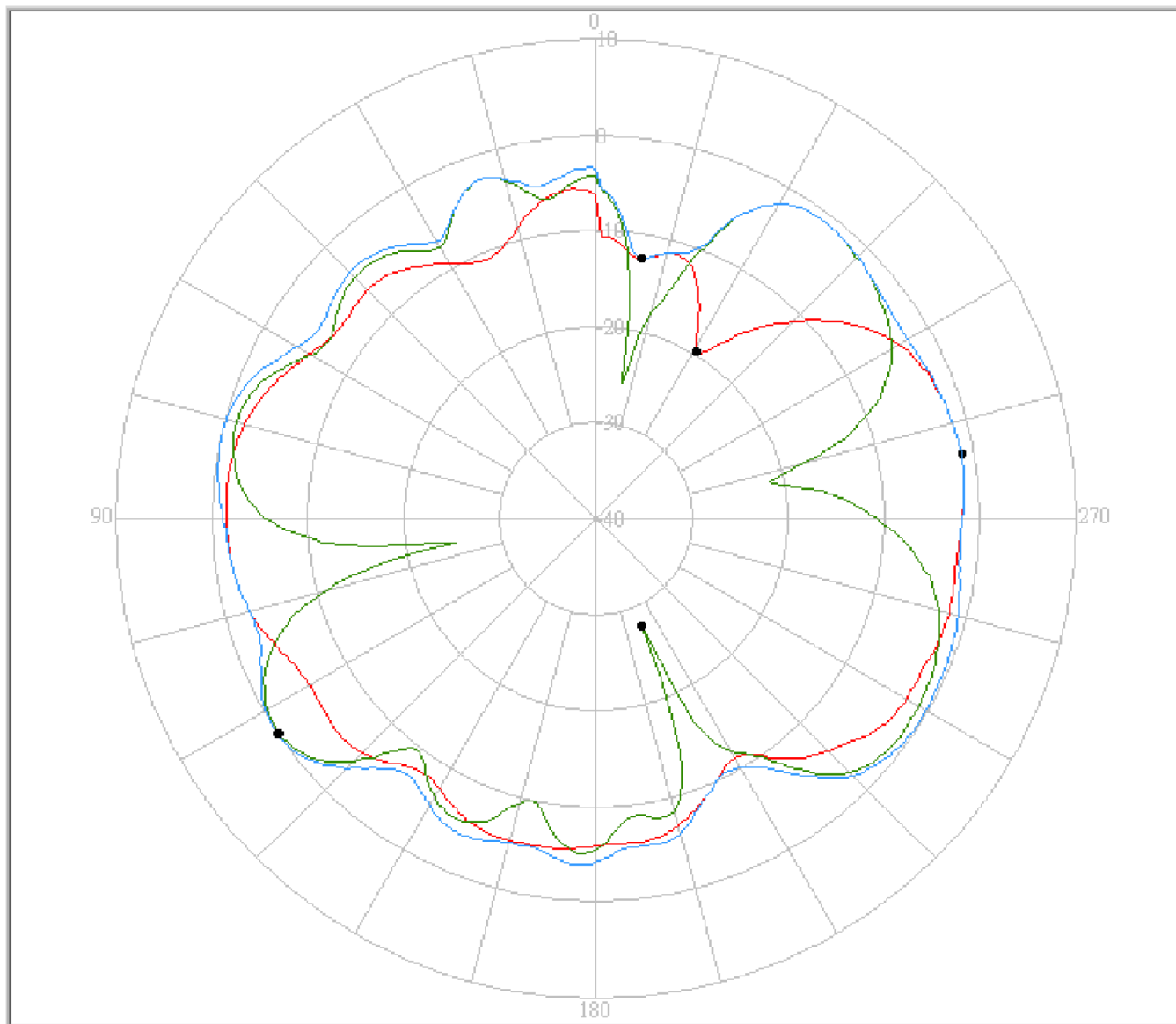

Pattern	Model No.	Test Mode	Freq(MHz)	Max Gain(dBi)	Min Gain(dBi)	Avg. Gain(dBi)	Source Polar.	Date
1	M590K	LEFT	2400.00	-1.39 / 280.00	-19.68 / 329.00	-4.92	Ver.	2006/1/20
2	M590K	LEFT	2400.00	-0.19 / 124.00	-27.89 / 203.00	-4.69	Hor.	2006/1/20
3	M590K	LEFT	2400.00	-0.01 / 124.00	-12.53 / 350.00	-2.89	Y+H	2006/1/20

## b. 2.45GHz



eService for Customer Satisfaction

**FAVORTRON**

# FAVORTRON Co. Ltd

## Antenna Pattern Measurement

4F, No. 108-1, Min Chuan Rd., Hsin-Tien City, Taipei, Taiwan, R.O.C. Tel:886-2-2218-2189,  
Fax:886-2-2218-5760

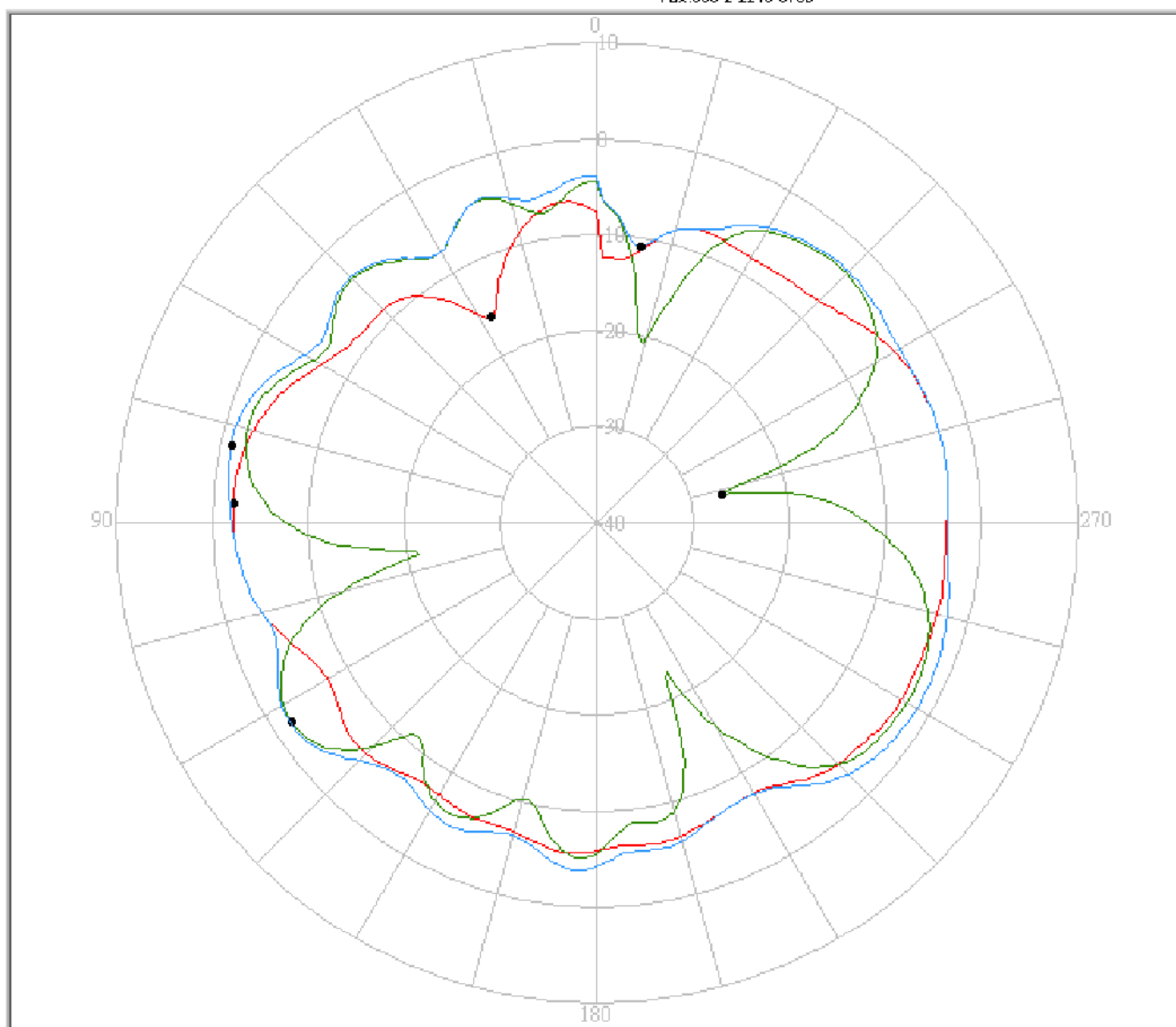

Pattern	Model No.	Test Mode	Freq(MHz)	Max Gain(dBi)	Min Gain(dBi)	Avg. Gain(dBi)	Source Polar.	Date
1	M590K	LEFT	2450.00	-2.17 / 87.00	-15.89 / 27.00	-5.58	Ver.	2006/1/20
2	M590K	LEFT	2450.00	-2.11 / 123.00	-26.61 / 283.00	-6.04	Hor.	2006/1/20
3	M590K	LEFT	2450.00	-1.15 / 78.00	-10.89 / 351.00	-3.95	Y+H	2006/1/20

c. 2.5GHz



Service for Customer Satisfaction

**FAVORTRON**

**FAVORTRON Co. Ltd**

**Antenna Pattern Measurement**

4F, No. 108-1, Min Chuan Rd., Hsin-Tien City, Taipei, Taiwan, R.O.C. Tel:886-2-2218-2189,  
Fax:886-2-2218-5760

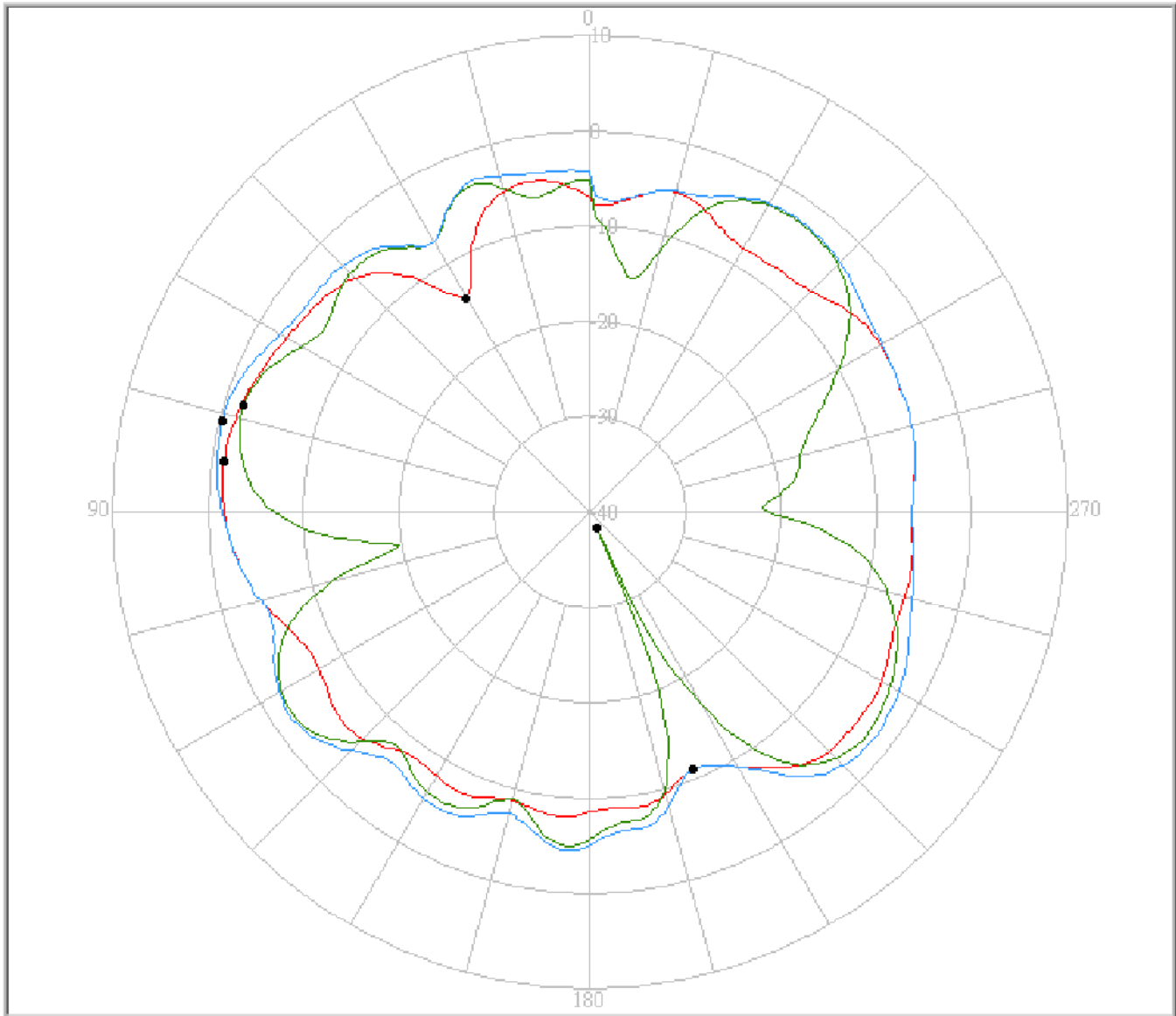

Pattern	Model No.	Test Mode	Freq(MHz)	Max Gain(dBi)	Min Gain(dBi)	Avg. Gain(dBi)	Source Polar.	Date
1	M590K	LEFT	2500.00	-1.33 / 82.00	-14.15 / 30.00	-5.64	Ver.	2006/1/20
2	M590K	LEFT	2500.00	-2.05 / 73.00	-38.18 / 204.00	-5.94	Hor.	2006/1/20
3	M590K	LEFT	2500.00	-0.39 / 76.00	-10.99 / 202.00	-3.98	Y+H	2006/1/20

d. 4.9GHz



# FAVORTRON Co. Ltd

## Antenna Pattern Measurement

4F, No. 108-1, Min Chuan Rd., Hsin-Tien City, Taipei, Taiwan, R.O.C. Tel:886-2-2218-2189, Fax:886-2-2218-5760

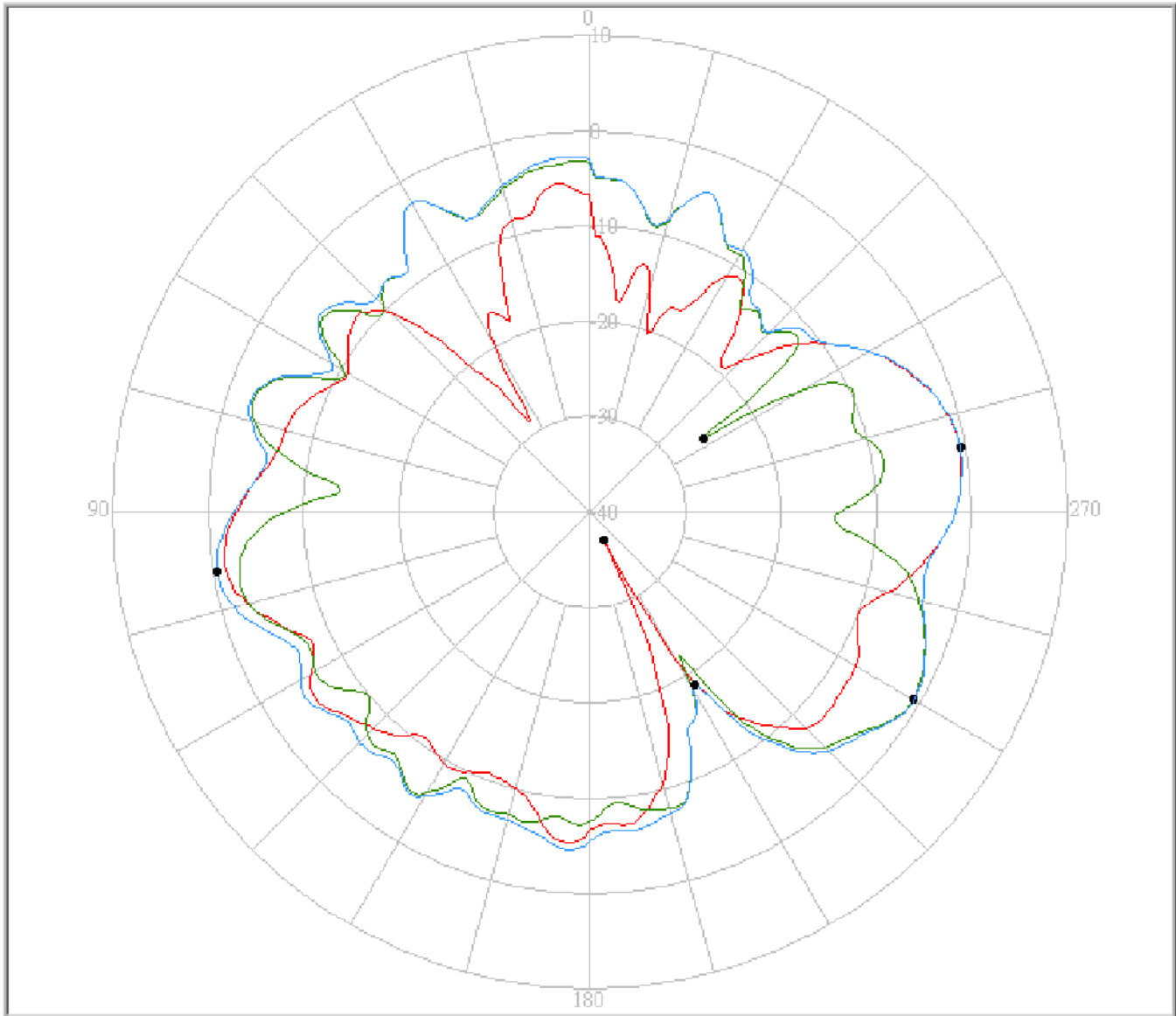

Pattern	Model No.	Test Mode	Freq(MHz)	Max Gain(dBi)	Min Gain(dBi)	Avg. Gain(dBi)	Source Polar.	Date
1	M590K	LEFT	4900.00	-0.65 / 280.00	-36.78 / 207.00	-6.93	Ver.	2006/1/20
2	M590K	LEFT	4900.00	-0.80 / 240.00	-25.89 / 303.00	-6.38	Hor.	2006/1/20
3	M590K	LEFT	4900.00	-0.53 / 99.00	-18.84 / 211.00	-4.62	Y+H	2006/1/20

e. 5.075GHz



# FAVORTRON Co. Ltd

## Antenna Pattern Measurement

4F, No. 108-1, Min Chuan Rd., Hsin-Tien City, Taipei, Taiwan, R.O.C. Tel:886-2-2218-2189, Fax:886-2-2218-5760

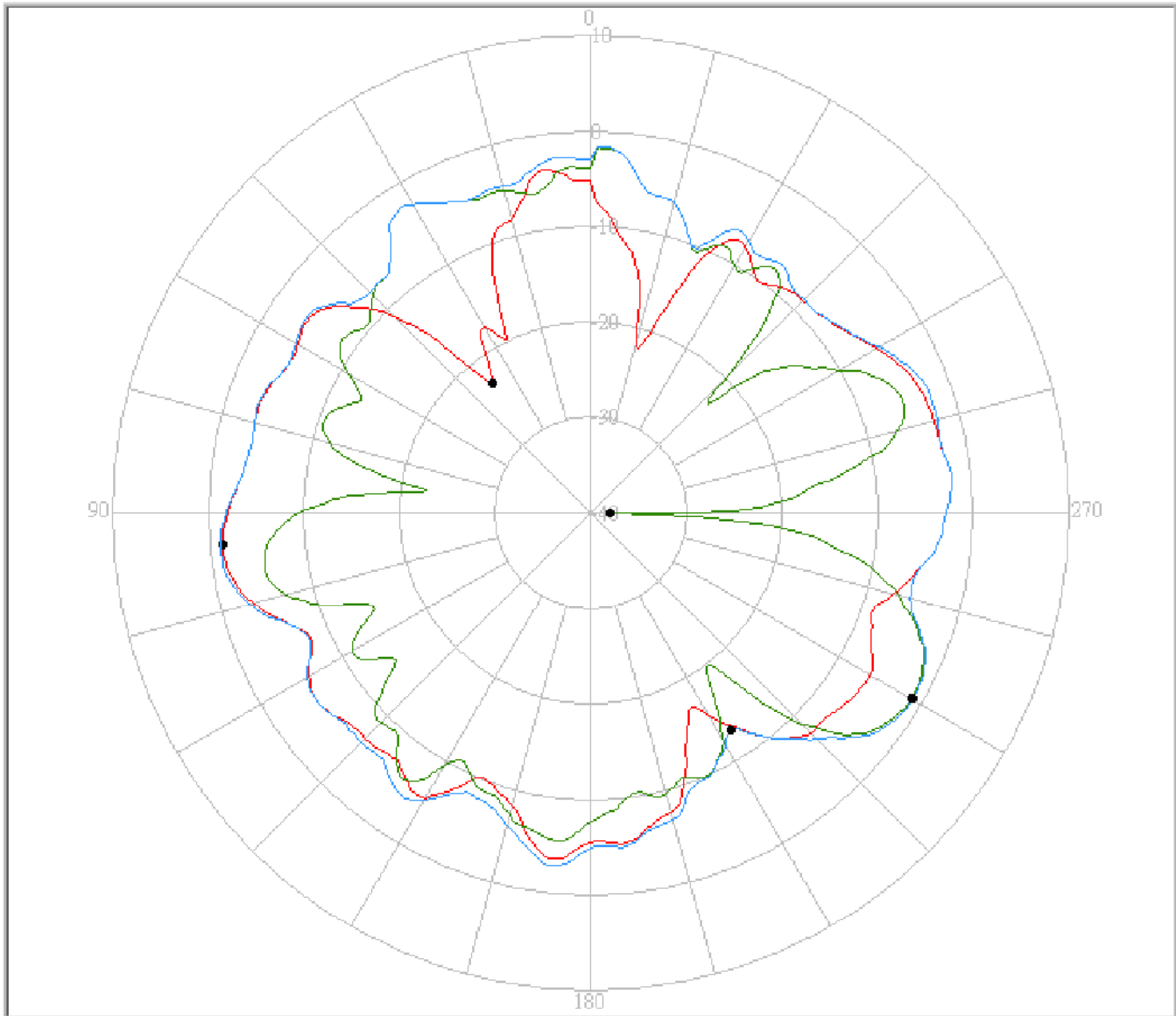

Pattern	Model No.	Test Mode	Freq(MHz)	Max Gain(dBi)	Min Gain(dBi)	Avg. Gain(dBi)	Source Polar.	Date
1	M590K	LEFT	5075.00	-1.38 / 95.00	-23.01 / 37.00	-6.03	Ver.	2006/1/20
2	M590K	LEFT	5075.00	-1.20 / 240.00	-38.07 / 269.00	-7.27	Hor.	2006/1/20
3	M590K	LEFT	5075.00	-1.00 / 240.00	-12.98 / 213.00	-4.53	Y+H	2006/1/20

# f. 5.15GHZ



## FAVORTRON Co. Ltd Antenna Pattern Measurement

4F, No. 108-1, Min Chuan Rd., Hsin-Tien City, Taipei, Taiwan, R.O.C. Tel:886-2-2218-2189,  
Fax:886-2-2218-5760

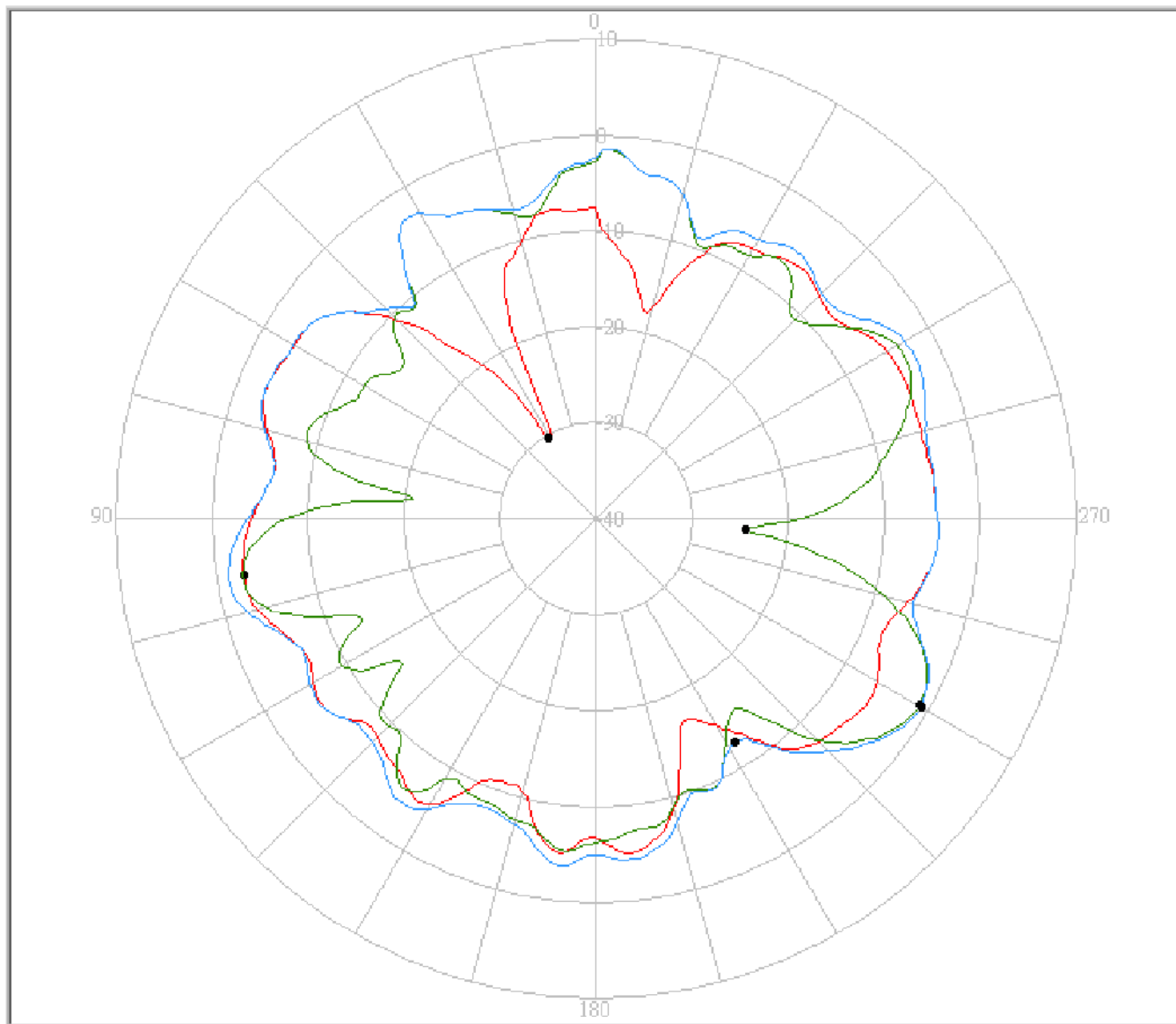

Pattern	Model No.	Test Mode	Freq(MHz)	Max Gain(dBi)	Min Gain(dBi)	Avg. Gain(dBi)	Source Polar.	Date
1	M590K	LEFT	5150.00	-2.88 / 99.00	-30.25 / 30.00	-6.65	Ver.	2006/1/20
2	M590K	LEFT	5150.00	-1.16 / 240.00	-24.32 / 266.00	-6.75	Hor.	2006/1/20
3	M590K	LEFT	5150.00	-0.96 / 240.00	-12.64 / 212.00	-4.75	Y+H	2006/1/20

g. 5.25GHz



# FAVORTRON Co. Ltd

## Antenna Pattern Measurement

4F, No. 108-1, Min Chuan Rd., Hsin-Tien City, Taipei, Taiwan, R.O.C. Tel:886-2-2218-2189, Fax:886-2-2218-5760

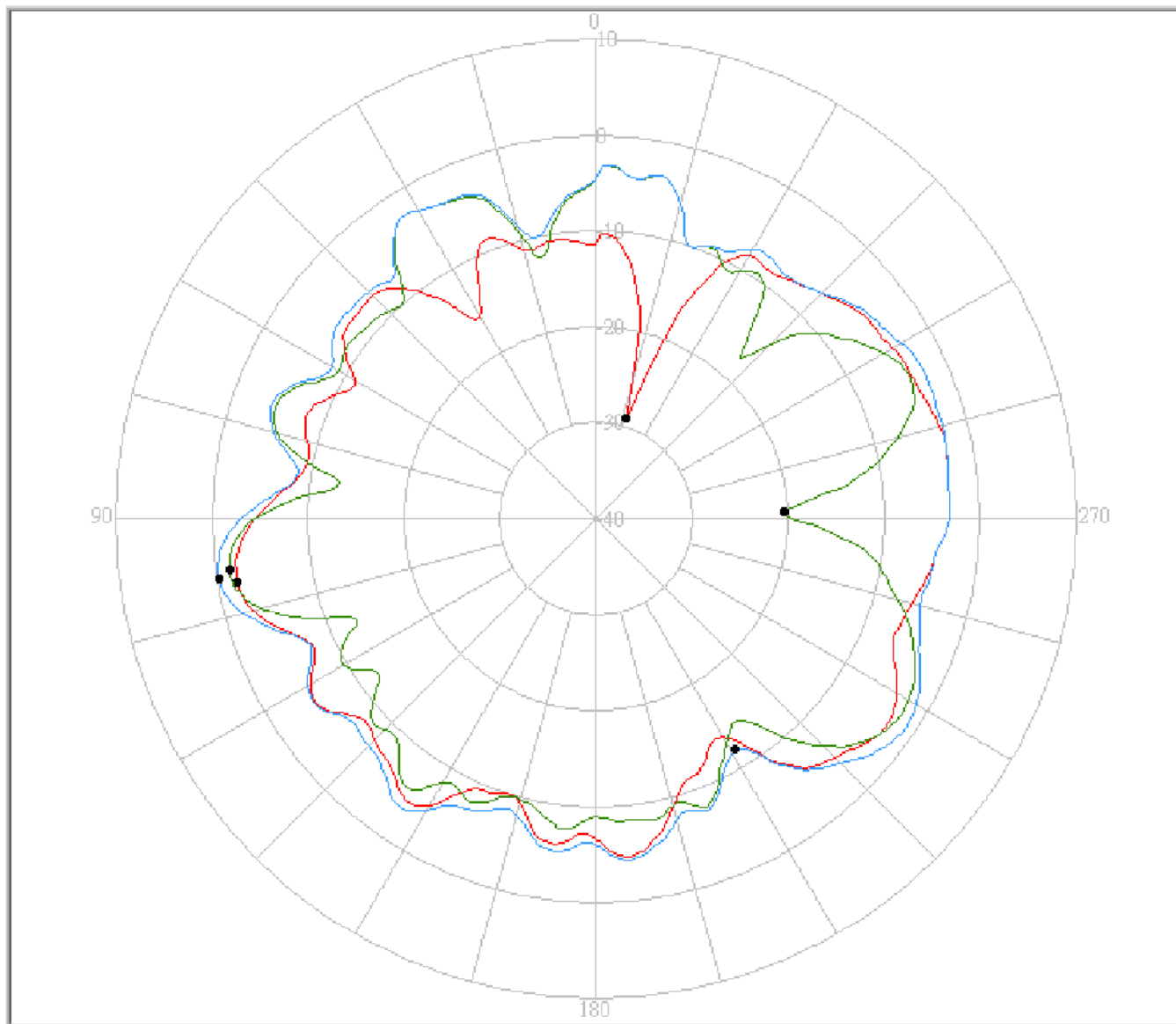

Pattern	Model No.	Test Mode	Freq(MHz)	Max Gain(dBi)	Min Gain(dBi)	Avg. Gain(dBi)	Source Polar.	Date
1	M590K	LEFT	5250.00	-2.10 / 100.00	-29.06 / 343.00	-6.45	Ver.	2006/1/20
2	M590K	LEFT	5250.00	-1.46 / 98.00	-20.31 / 272.00	-6.79	Hor.	2006/1/20
3	M590K	LEFT	5250.00	-0.28 / 99.00	-11.90 / 211.00	-4.79	Y+H	2006/1/20



## h. 5.35GHz



# FAVORTRON Co. Ltd

## Antenna Pattern Measurement

4F, No. 108-1, Min Chuan Rd., Hsin-Tien City, Taipei, Taiwan, R.O.C. Tel:886-2-2218-2189,  
Fax:886-2-2218-5760

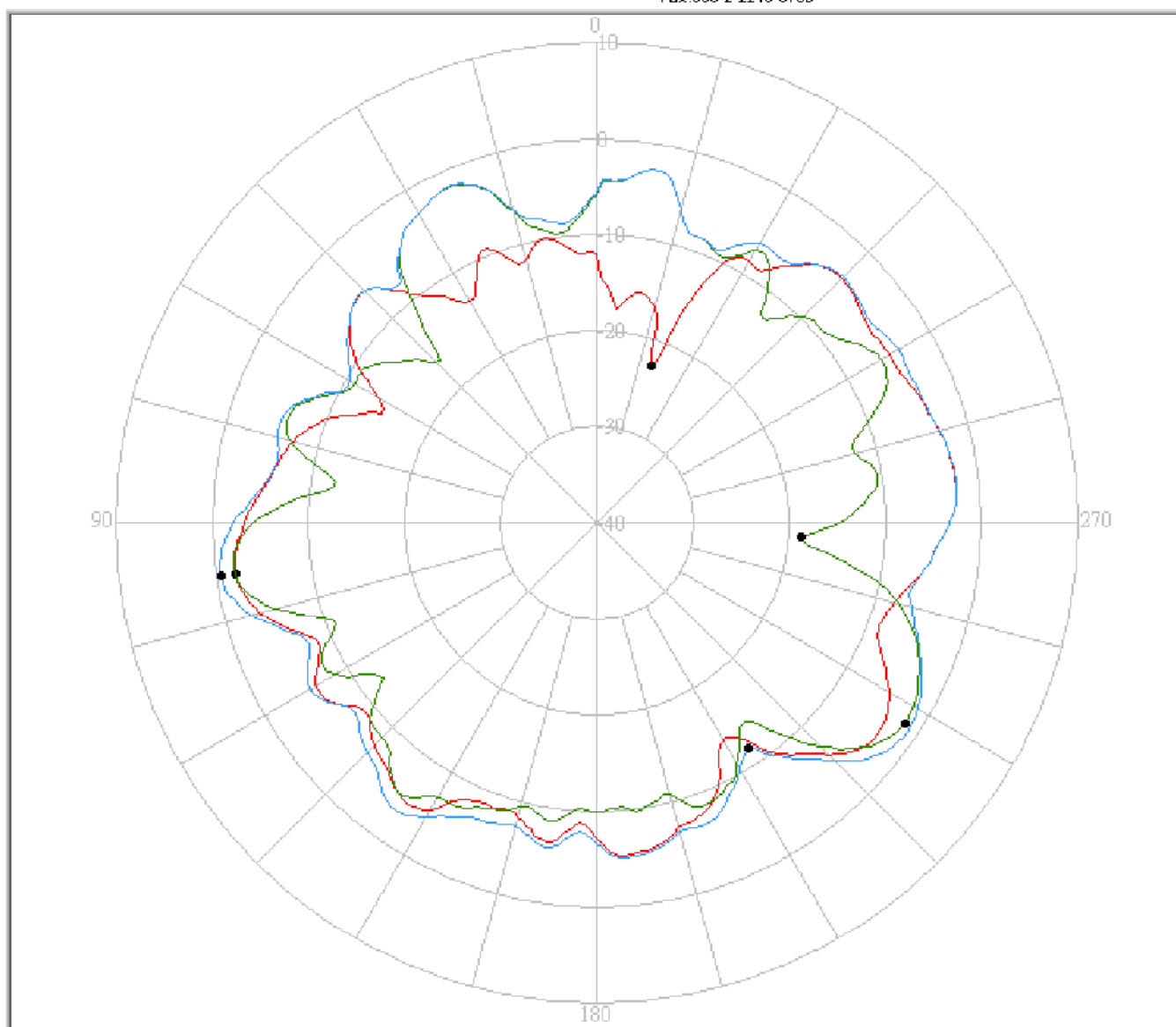

Pattern	Model No.	Test Mode	Freq(MHz)	Max Gain(dBi)	Min Gain(dBi)	Avg. Gain(dBi)	Source Polar.	Date
1	M590K	LEFT	5350.00	-2.05 / 98.00	-22.82 / 341.00	-6.53	Ver.	2006/1/20
2	M590K	LEFT	5350.00	-1.75 / 237.00	-18.63 / 266.00	-6.93	Hor.	2006/1/20
3	M590K	LEFT	5350.00	-0.56 / 98.00	-11.69 / 214.00	-4.80	Y+H	2006/1/20

# i. 5.47GHz



## FAVORTRON Co. Ltd

### Antenna Pattern Measurement

4F, No. 108-1, Min Chuan Rd., Hsin-Tien City, Taipei, Taiwan, R.O.C. Tel:886-2-2218-2189, Fax:886-2-2218-5760

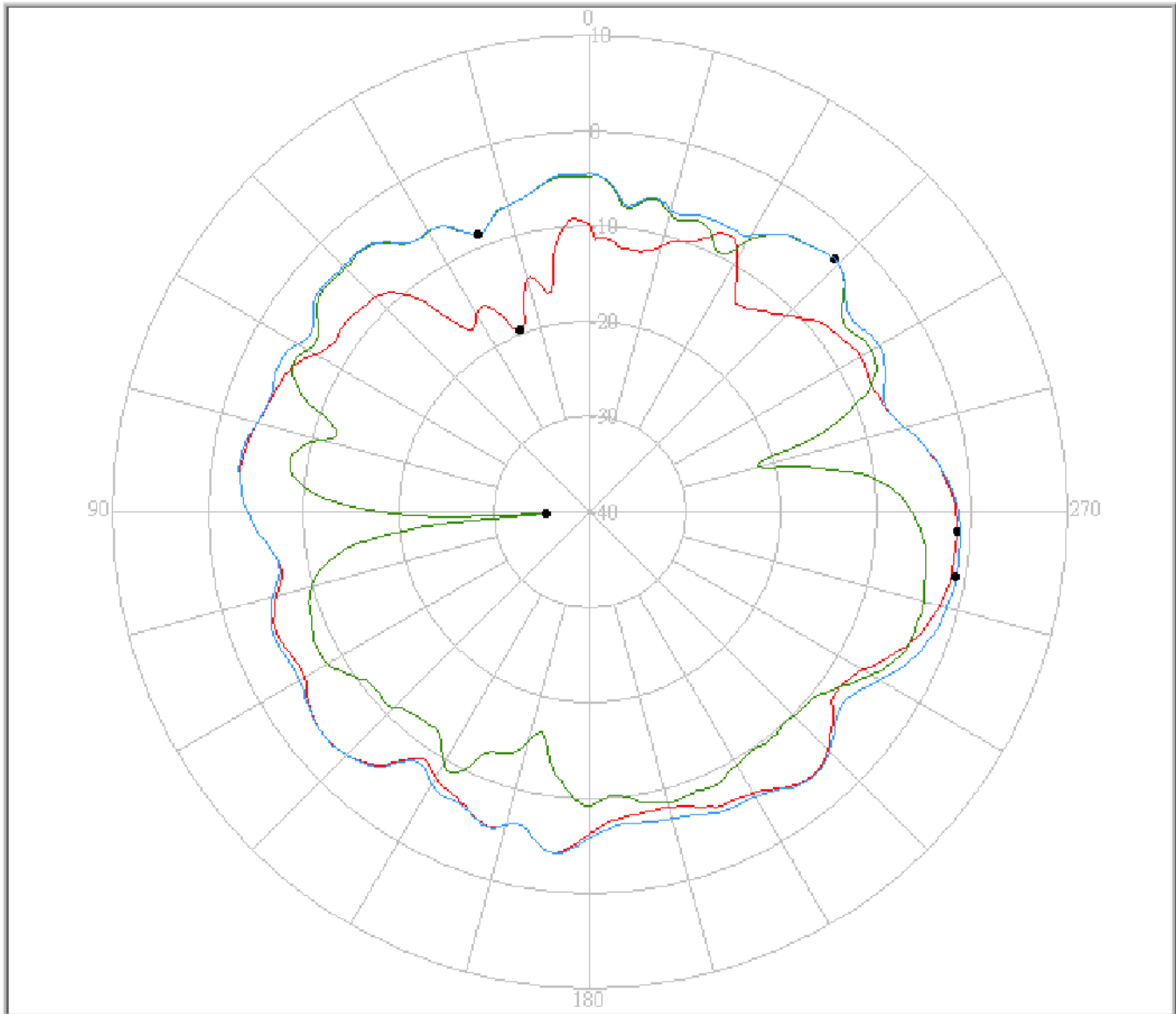

Pattern	Model No.	Test Mode	Freq(MHz)	Max Gain(dBi)	Min Gain(dBi)	Avg. Gain(dBi)	Source Polar.	Date
1	M590K	LEFT	5470.00	-1.49 / 267.00	-19.64 / 21.00	-6.09	Ver.	2006/1/20
2	M590K	LEFT	5470.00	-3.19 / 316.00	-35.33 / 93.00	-7.34	Hor.	2006/1/20
3	M590K	LEFT	5470.00	-1.05 / 260.00	-8.68 / 22.00	-4.68	Y+H	2006/1/20

j. 5.597GHz



# FAVORTRON Co. Ltd

## Antenna Pattern Measurement

4F, No. 108-1, Min Chuan Rd., Hsin-Tien City, Taipei, Taiwan, R.O.C. Tel:886-2-2218-2189, Fax:886-2-2218-5760

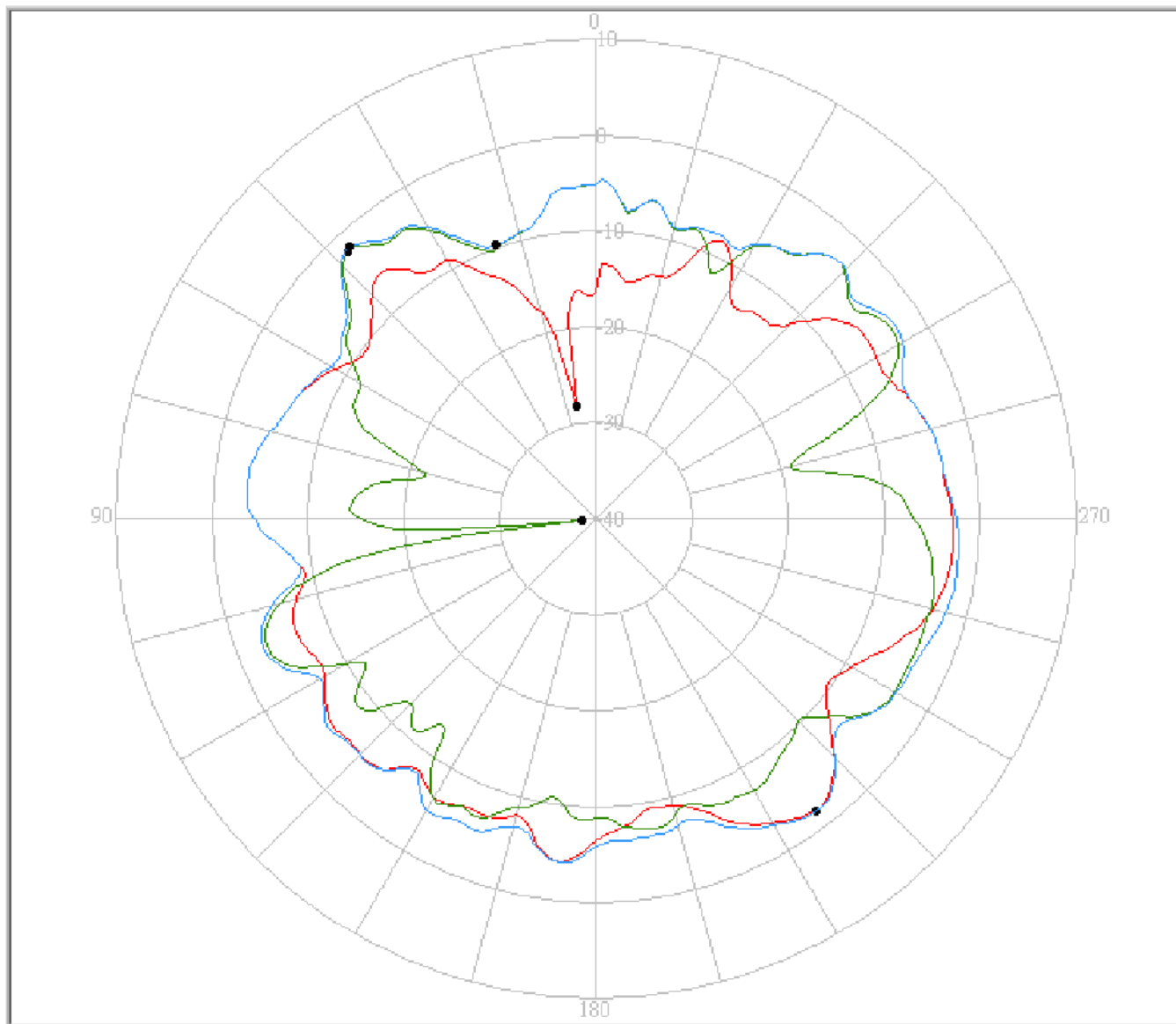

Pattern	Model No.	Test Mode	Freq(MHz)	Max Gain(dBi)	Min Gain(dBi)	Avg. Gain(dBi)	Source Polar.	Date
1	M590K	LEFT	5597.50	-1.97 / 217.00	-28.06 / 10.00	-6.54	Ver.	2006/1/20
2	M590K	LEFT	5597.50	-2.06 / 43.00	-38.54 / 96.00	-7.02	Hor.	2006/1/20
3	M590K	LEFT	5597.50	-1.76 / 42.00	-9.67 / 20.00	-4.80	Y+H	2006/1/20

k. 5.725GHz



Service for Customer Satisfaction

**FAVORTRON**

**FAVORTRON Co. Ltd**

**Antenna Pattern Measurement**

4F, No. 108-1, Min Chuan Rd., Hsin-Tien City, Taipei, Taiwan, R.O.C. Tel:886-2-2218-2189,  
Fax:886-2-2218-5760

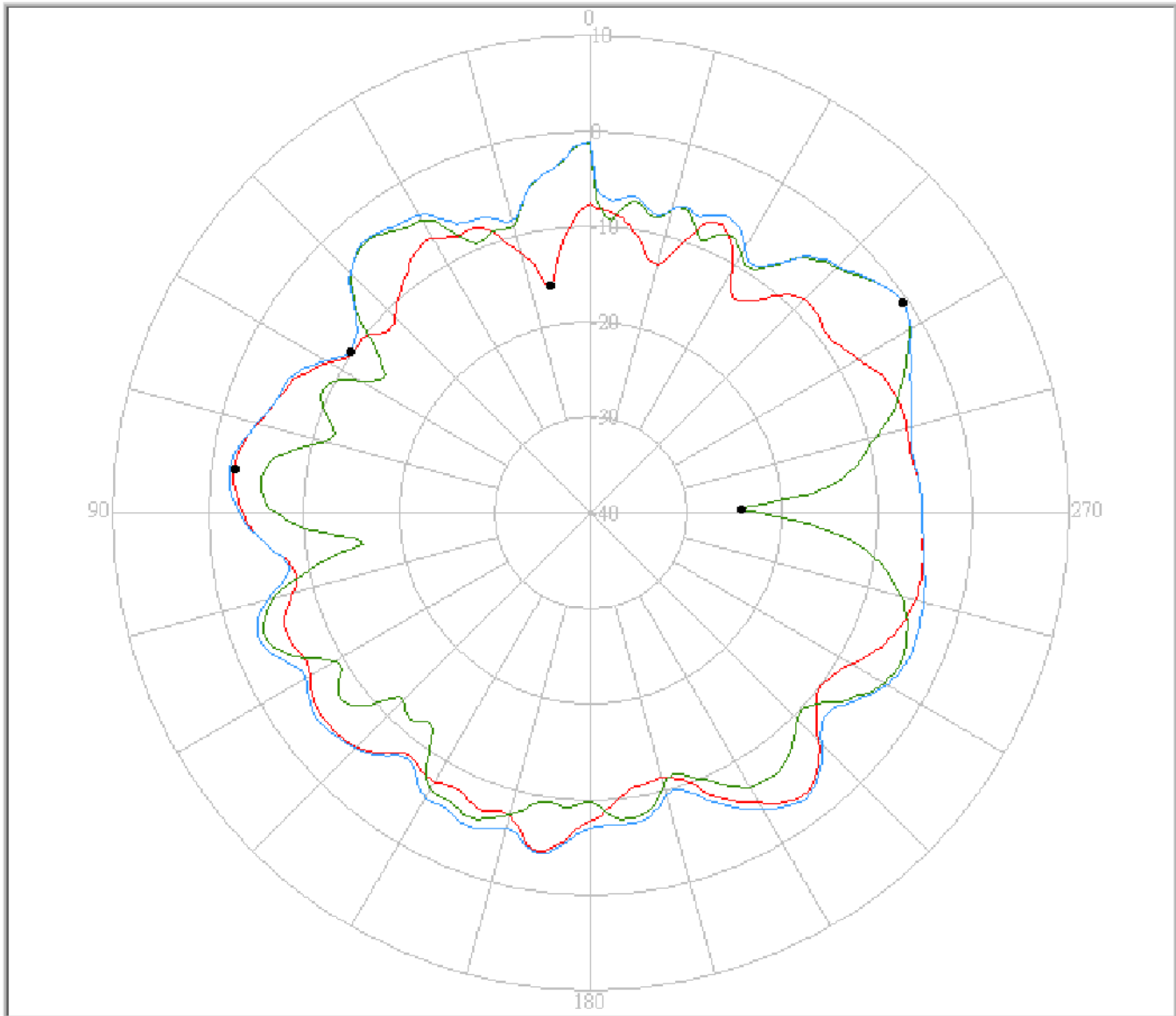

Pattern	Model No.	Test Mode	Freq(MHz)	Max Gain(dBi)	Min Gain(dBi)	Avg. Gain(dBi)	Source Polar.	Date
1	M590K	LEFT	5725.00	-2.50 / 83.00	-15.90 / 10.00	-6.81	Ver.	2006/1/20
2	M590K	LEFT	5725.00	-0.65 / 304.00	-24.23 / 271.00	-6.64	Hor.	2006/1/20
3	M590K	LEFT	5725.00	-0.59 / 304.00	-9.73 / 56.00	-4.84	Y+H	2006/1/20

# 1. 5.785GHz



## FAVORTRON Co. Ltd Antenna Pattern Measurement

4F, No. 108-1, Min Chuan Rd., Hsin-Tien City, Taipei, Taiwan, R.O.C. Tel:886-2-2218-2189,  
Fax:886-2-2218-5760

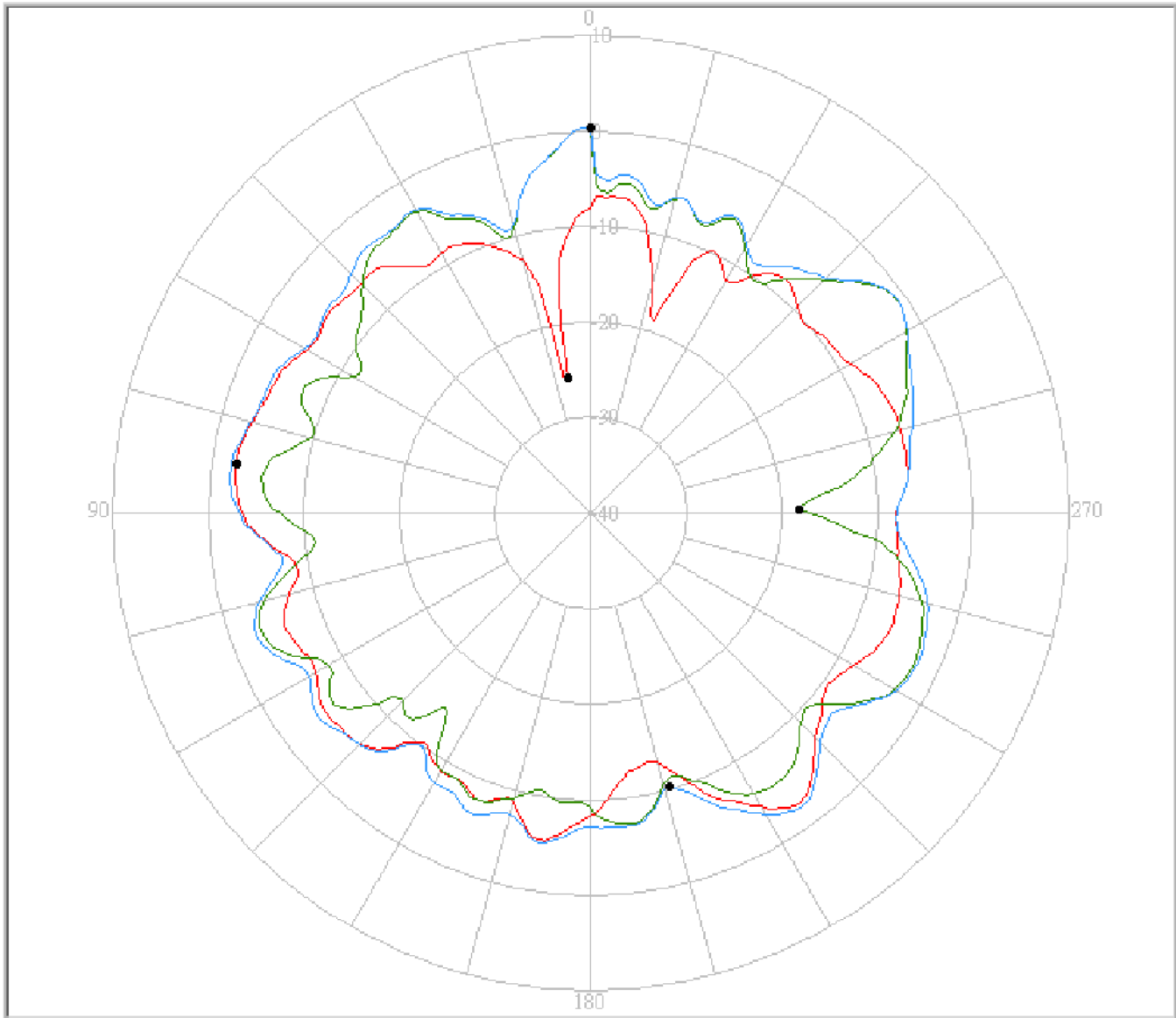

Pattern	Model No.	Test Mode	Freq(MHz)	Max Gain(dBi)	Min Gain(dBi)	Avg. Gain(dBi)	Source Polar.	Date
1	M590K	LEFT	5785.00	-2.57 / 82.00	-25.77 / 10.00	-7.04	Ver.	2006/1/20
2	M590K	LEFT	5785.00	0.29 / 0.00	-18.21 / 271.00	-6.21	Hor.	2006/1/20
3	M590K	LEFT	5785.00	0.33 / 0.00	-10.22 / 196.00	-4.72	Y+H	2006/1/20

m. 5.85GHz



Service for Customer Satisfaction

**FAVORTRON**

**FAVORTRON Co. Ltd**

**Antenna Pattern Measurement**

4F, No. 108-1, Min Chuan Rd., Hsin-Tien City, Taipei, Taiwan, R.O.C. Tel:886-2-2218-2189,  
Fax:886-2-2218-5760

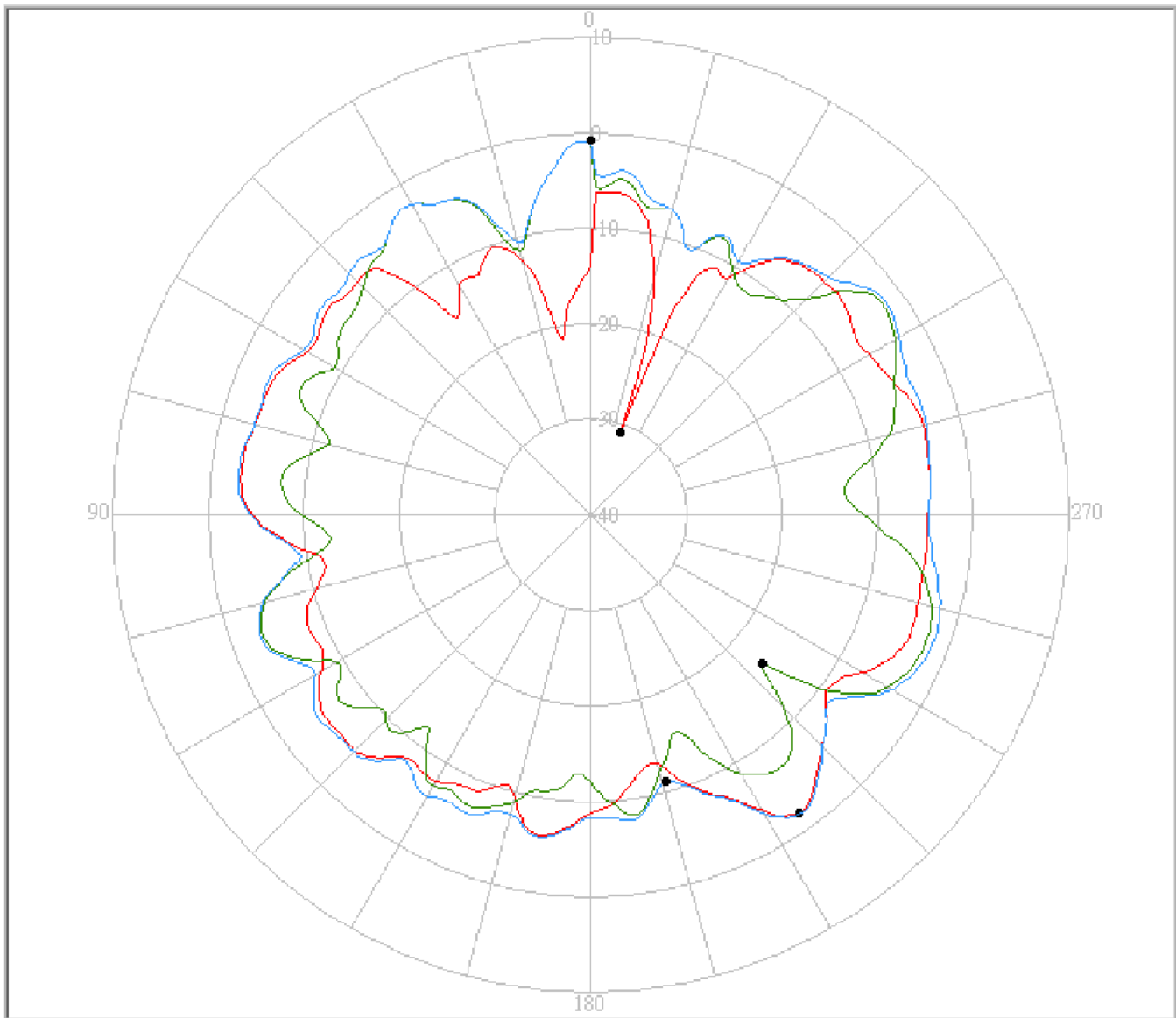

Pattern	Model No.	Test Mode	Freq(MHz)	Max Gain(dBi)	Min Gain(dBi)	Avg. Gain(dBi)	Source Polar.	Date
1	M590K	LEFT	5850.00	-2.04 / 215.00	-30.77 / 340.00	-6.56	Ver.	2006/1/20
2	M590K	LEFT	5850.00	-0.89 / 0.00	-16.27 / 229.00	-6.73	Hor.	2006/1/20
3	M590K	LEFT	5850.00	-0.89 / 0.00	-11.10 / 196.00	-4.74	Y+H	2006/1/20

n. 5.875GHz



Service for Customer Satisfaction

**FAVORTRON**

**FAVORTRON Co. Ltd**

**Antenna Pattern Measurement**

4F, No. 108-1, Min Chuan Rd., Hsin-Tien City, Taipei, Taiwan, R.O.C. Tel:886-2-2218-2189,  
Fax:886-2-2218-5760

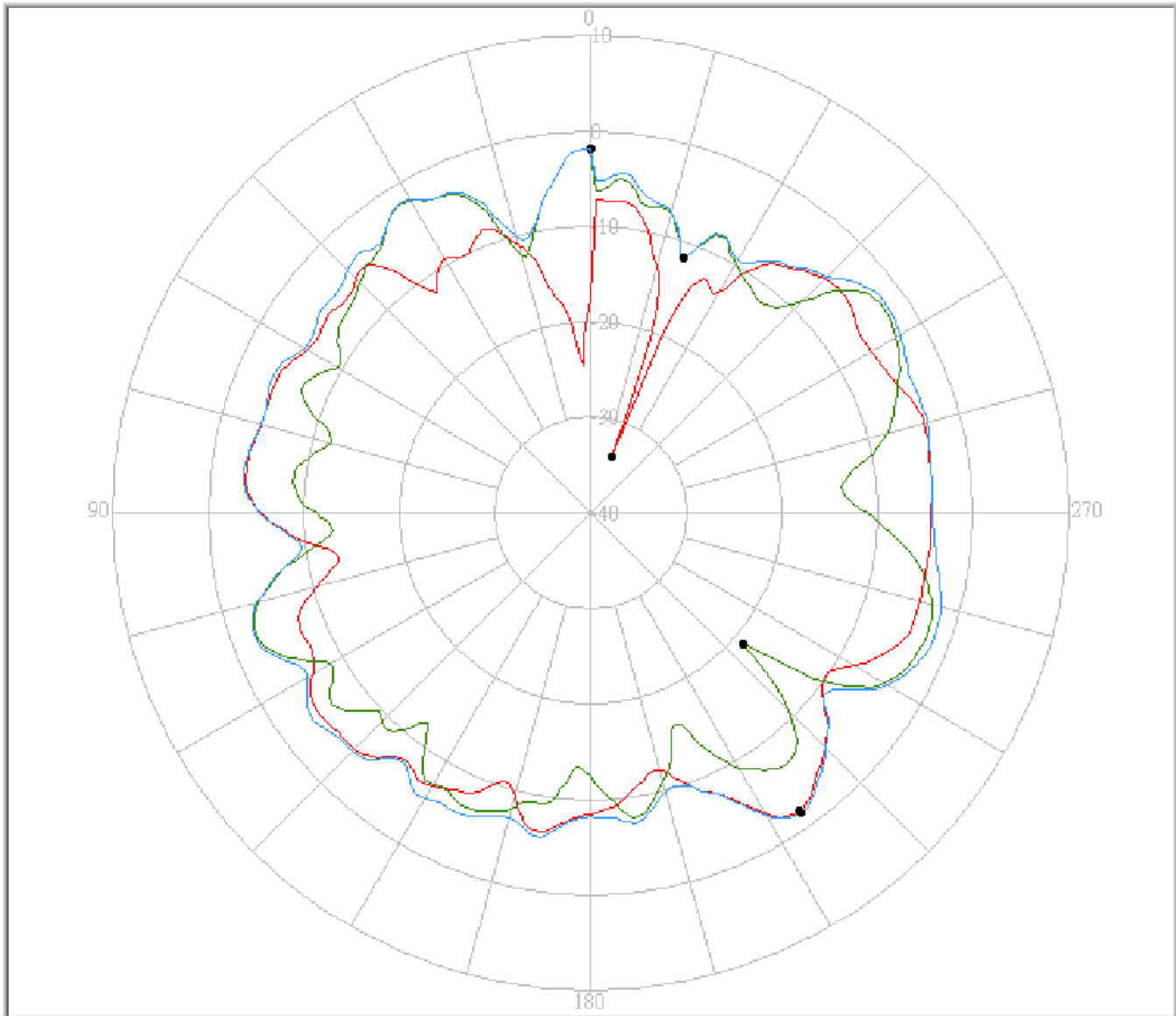

Pattern	Model No.	Test Mode	Freq(MHz)	Max Gain(dBi)	Min Gain(dBi)	Avg. Gain(dBi)	Source Polar.	Date
1	M590K	LEFT	5875.00	-1.92 / 215.00	-33.70 / 339.00	-6.51	Ver.	2006/1/20
2	M590K	LEFT	5875.00	-1.86 / 0.00	-18.96 / 229.00	-6.72	Hor.	2006/1/20
3	M590K	LEFT	5875.00	-1.75 / 215.00	-11.47 / 340.00	-4.73	Y+H	2006/1/20