



FCC TEST REPORT

REPORT NO.: RF950210H01A

MODEL NO.: VNT6656G6A40

RECEIVED: Feb. 10, 2006

TESTED: Feb. 15 to 24, 2006

ISSUED: March 27, 2006

APPLICANT: VIA Technologies, Inc.

ADDRESS: 8F, 533, Chung-Cheng Rd. Hsin-Tien, Taipei 231

ISSUED BY: Advance Data Technology Corporation

LAB LOCATION: No. 81-1, Lu Liao Keng, 9 Ling, Wu Lung Tsuen,
Chiung Lin Hsiang, Hsin Chu Hsien,
Taiwan, R.O.C.

This test report consists of 80 pages in total. It may be duplicated completely for legal use with the approval of the applicant. It should not be reproduced except in full, without the written approval of our laboratory. The client should not use it to claim product endorsement by CNLA, A2LA or any government agencies. The test results in the report only apply to the tested sample. The test results in this report are traceable to the national or international standards.





Table of Contents

1	CERTIFICATION.....	4
2	SUMMARY OF TEST RESULTS.....	5
3	GENERAL INFORMATION	6
3.1	GENERAL DESCRIPTION OF EUT.....	6
3.2	DESCRIPTION OF TEST MODES.....	7
3.3	TEST MODE APPLICABILITY AND TESTED CHANNEL DETAIL:.....	8
3.4	GENERAL DESCRIPTION OF APPLIED STANDARDS	10
3.5	DESCRIPTION OF SUPPORT UNITS.....	11
3.6	CONFIGURATION OF SYSTEM UNDER TEST	12
4	TEST TYPES AND RESULTS.....	13
4.1	CONDUCTED EMISSION MEASUREMENT	13
4.1.1	LIMITS OF CONDUCTED EMISSION MEASUREMENT	13
4.1.2	TEST INSTRUMENTS	13
4.1.3	TEST PROCEDURES.....	14
4.1.4	TEST SETUP	14
4.1.5	EUT OPERATING CONDITIONS.....	15
4.1.6	TEST RESULTS.....	16
4.2	RADIATED EMISSION MEASUREMENT	18
4.2.1	LIMITS OF RADIATED EMISSION MEASUREMENT	18
4.2.2	TEST INSTRUMENTS	19
4.2.3	TEST PROCEDURES.....	20
4.2.4	TEST SETUP.....	21
4.2.5	EUT OPERATING CONDITIONS.....	21
4.2.6	TEST RESULTS (MODE 1).....	22
4.2.7	TEST RESULTS –DSSS (MODE 1).....	23
4.2.8	TEST RESULTS – OFDM (MODE 1)	26
4.2.9	TEST RESULTS –DSSS (MODE 2).....	29
4.2.10	TEST RESULTS – OFDM (MODE 2)	32
4.2.11	TEST RESULTS –DSSS (MODE 3).....	35
4.2.12	TEST RESULTS – OFDM (MODE 3)	38
4.3	6dB BANDWIDTH MEASUREMENT	41
4.3.1	LIMITS OF 6dB BANDWIDTH MEASUREMENT	41
4.3.2	TEST INSTRUMENTS	41
4.3.3	TEST PROCEDURE	42
4.3.4	TEST SETUP.....	42
4.3.5	EUT OPERATING CONDITIONS.....	42
4.3.6	TEST RESULTS –DSSS	43
4.3.7	TEST RESULTS-OFDM.....	46
4.4	MAXIMUM PEAK OUTPUT POWER	49



4.4.1	LIMITS OF MAXIMUM PEAK OUTPUT POWER MEASUREMENT	49
4.4.2	TEST INSTRUMENTS	49
4.4.3	TEST PROCEDURES	50
4.4.4	TEST SETUP	50
4.4.5	EUT OPERATING CONDITIONS	50
4.4.6	TEST RESULTS – DSSS	51
4.4.7	TEST RESULTS –OFDM	52
4.5	POWER SPECTRAL DENSITY MEASUREMENT	53
4.5.1	LIMITS OF POWER SPECTRAL DENSITY MEASUREMENT	53
4.5.2	TEST INSTRUMENTS	53
4.5.3	TEST PROCEDURE	54
4.5.4	TEST SETUP	54
4.5.5	EUT OPERATING CONDITIONS	54
4.5.6	TEST RESULTS –DSSS	55
4.5.7	TEST RESULTS –OFDM	58
4.6	BAND EDGES MEASUREMENT	61
4.6.1	LIMITS OF BAND EDGES MEASUREMENT	61
4.6.2	TEST INSTRUMENTS	61
4.6.3	TEST PROCEDURE	61
4.6.4	EUT OPERATING CONDITION	61
4.6.5	TEST RESULTS – DSSS (MODE 1)	62
4.6.6	TEST RESULTS -OFDM (MODE 1)	63
4.6.7	TEST RESULTS – DSSS (MODE 2)	64
4.6.8	TEST RESULTS -OFDM (MODE 2)	65
4.6.9	TEST RESULTS – DSSS (MODE 3)	66
4.6.10	TEST RESULTS -OFDM (MODE 3)	67
4.7	ANTENNA REQUIREMENT	74
4.7.1	STANDARD APPLICABLE	74
4.7.2	ANTENNA CONNECTED CONSTRUCTION	74
5	PHOTOGRAPHS OF THE TEST CONFIGURATION	75
6	INFORMATION ON THE TESTING LABORATORIES	79
	APPENDIX-A	A-1



1 CERTIFICATION

PRODUCT : USB Embedded Module
BRAND NAME : VIA
MODEL NO. : VNT6656G6A40
TESTED: Feb. 15 to 24, 2006
APPLICANT : VIA Technologies, Inc.
TEST ITEM: MASS-PRODUCTION
STANDARDS : 47 CFR Part 15, Subpart C (Section 15.247),
ANSI C63.4-2003

The above equipment (Model: VNT6656G6A40) has been tested by **Advance Data Technology Corporation**, and found compliance with the requirement of the above standards. The test record, data evaluation & Equipment Under Test (EUT) configurations represented herein are true and accurate accounts of the measurements of the sample's EMC characteristics under the conditions specified in this report.

PREPARED BY :  , **DATE:** March 27, 2006
(Midoli Peng)

TECHNICAL ACCEPTANCE :  , **DATE:** March 27, 2006
Responsible for RF (Hank Chung)

APPROVED BY :  , **DATE:** March 27, 2006
(May Chen, Deputy Manager)

2 SUMMARY OF TEST RESULTS

The EUT has been tested according to the following specifications:

APPLIED STANDARD: 47 CFR Part 15, Subpart C			
Standard Section	Test Type and Limit	Result	REMARK
15.207	AC Power Conducted Emission	PASS	Meet the requirement of limit Minimum passing margin is -13.81 dB at 0.365 MHz
15.247(a)(2)	Spectrum Bandwidth of a Direct Sequence Spread Spectrum System Limit: min. 500kHz	PASS	Meet the requirement of limit
15.247(b)	Maximum Peak Output Power Limit: max. 30dBm	PASS	Meet the requirement of limit
15.247(c)	Transmitter Radiated Emissions Limit: Table 15.209	PASS	Meet the requirement of limit Minimum passing margin is -0.2 dB at 2483.5 MHz
15.247(d)	Power Spectral Density Limit: max. 8dBm	PASS	Meet the requirement of limit
15.247(c)	Band Edge Measurement Limit: 20 dB less than the peak value of fundamental frequency	PASS	Meet the requirement of limit

3 GENERAL INFORMATION

3.1 GENERAL DESCRIPTION OF EUT

PRODUCT	USB Embedded Module
MODEL NO.	VNT6656G6A40
FCC ID	NCI-VNT6656G6A4X
POWER SUPPLY	DC 5V from host equipment
MODULATION TYPE	CCK, DQPSK, DBPSK for DSSS 64QAM, 16QAM, QPSK, BPSK for OFDM
RADIO TECHNOLOGY	DSSS, OFDM
TRANSFER RATE	802.11b: 11/5.5/2/1Mbps 802.11g: 54/48/36/24/18/12/9/6Mbps
FREQUENCY RANGE	2412MHz ~ 2462MHz
NUMBER OF CHANNEL	11
CHANNEL SPACING	5MHz
OUTPUT POWER	802.11b: 64.863mW 802.11g: 67.608mW
ANTENNA TYPE	Please see note 1
DATA CABLE	NA
ASSOCIATED DEVICES	NA

NOTE:

1. The EUT can be equipped with following antennas:

No.	Brand Name	Model No.	Gain (dBi)	Antenna Type	Antenna Connector
1	High-tek	T700(PEN)	0.05	PIFA	I-PEX
2	ARISTOTLE	PCB013	1	PCB	I-PEX
3	ARISTOTLE	C2H Series	2.5	Monopole	I-PEX
4	Own design	MN003	1.29	PCB	I-PEX

Note:

1. From above antennas, the different type of antennas was chosen for final test and its data were recorded in this report.
2. Antenna 2 and 4 are the same type of antenna. The antenna 5 was selected as representative antenna for the test.

2. The EUT, operates in the 2.4GHz frequency range, lets you connect IEEE 802.11g or IEEE 802.11b devices to the network. With its high-speed data transmissions of up to 54Mbps.
3. The above EUT information was declared by the manufacturer and for more detailed features description, please refer to the manufacturer's specifications or User's Manual.

3.2 DESCRIPTION OF TEST MODES

Operated in 2400 ~ 2483.5MHz band:

For 802.11b/g normal mode: Eleven channels are provided to this EUT.

Channel	Frequency	Channel	Frequency
1	2412 MHz	7	2442 MHz
2	2417 MHz	8	2447 MHz
3	2422 MHz	9	2452 MHz
4	2427 MHz	10	2457 MHz
5	2432 MHz	11	2462 MHz
6	2437 MHz		

For Conducted & Radiation Emission Test: The EUT was tested under the following test modes, and its data were recorded in this report:

Conducted & Radiation Emission(Below 1 GHz)		
Test Mode	Model Name	Description
Mode 1	VNT6656G6A40	Monopole & Monopole
Radiation Emission(Above 1 GHz)		
Test Mode	Model Name	Description
Mode 1	VNT6656G6A40	Monopole & Monopole
Mode 2	VNT6656G6A40	PIFA & PIFA
Mode 3	VNT6656G6A40	PCB & PCB

3.3 TEST MODE APPLICABILITY AND TESTED CHANNEL DETAIL:

EUT configure mode	Applicable to				Description
	PLC	RE<1G	RE≥1G	APCM	
-	X	X	X	X	NA

Where PLC: Power Line Conducted Emission RE<1G RE: Radiated Emission below 1GHz
 RE≥1G: Radiated Emission above 1GHz APCM: Antenna Port Conducted Measurement

Power Line Conducted Emission Test:

- Pre-Scan has been conducted to determine the worst-case mode from all possible combinations between available modulations, data rates and antenna ports (if EUT with antenna diversity architecture).
- Following channel(s) was (were) selected for the final test as listed below.

Mode	Available Channel	Tested Channel	Modulation Technology	Modulation Type	Data Rate (Mbps)
802.11g	1 to 11	11	OFDM	BPSK	6

Radiated Emission Test (Below 1 GHz):

- Pre-Scan has been conducted to determine the worst-case mode from all possible combinations between available modulations, data rates and antenna ports (if EUT with antenna diversity architecture).
- Following channel(s) was (were) selected for the final test as listed below.

Mode	Available Channel	Tested Channel	Modulation Technology	Modulation Type	Data Rate (Mbps)
802.11b	1 to 11	1	DSSS	CCK	11

Radiated Emission Test (Above 1 GHz):

- Pre-Scan has been conducted to determine the worst-case mode from all possible combinations between available modulations, data rates and antenna ports (if EUT with antenna diversity architecture).
- Following channel(s) was (were) selected for the final test as listed below.

Mode	Available Channel	Tested Channel	Modulation Technology	Modulation Type	Data Rate (Mbps)
802.11b	1 to 11	1, 6, 11	DSSS	CCK	11
802.11g	1 to 11	1, 6, 11	OFDM	BPSK	6

Bandedge Measurement:

- Pre-Scan has been conducted to determine the worst-case mode from all possible combinations between available modulations, data rates and antenna ports (if EUT with antenna diversity architecture).
- Following channel(s) was (were) selected for the final test as listed below.

Mode	Available Channel	Tested Channel	Modulation Technology	Modulation Type	Data Rate (Mbps)
802.11b	1 to 11	1, 11	DSSS	CCK	11
802.11g	1 to 11	1, 11	OFDM	BPSK	6

Antenna Port Conducted Measurement:

- Pre-Scan has been conducted to determine the worst-case mode from all possible combinations between available modulations, data rates and antenna ports (if EUT with antenna diversity architecture).
- Following channel(s) was (were) selected for the final test as listed below.

Mode	Available Channel	Tested Channel	Modulation Technology	Modulation Type	Data Rate (Mbps)
802.11b	1 to 11	1, 6, 11	DSSS	CCK	11
802.11g	1 to 11	1, 6, 11	OFDM	BPSK	6



3.4 GENERAL DESCRIPTION OF APPLIED STANDARDS

The EUT is an USB Embedded Module. According to the specifications of the manufacturer, it must comply with the requirements of the following standards:

47 CFR Part 15, Subpart C. (15.247)
ANSI C63.4 : 2003

All tests have been performed and recorded as per the above standards.



3.5 DESCRIPTION OF SUPPORT UNITS

The EUT has been tested as an independent unit together with other necessary accessories or support units. The following support units or accessories were used to form a representative test configuration during the tests.

For Conducted test					
No.	Product	Brand	Model No.	Serial No.	FCC ID
1	NOTEBOOK COMPUTER	DELL	PP05L	CN-04Y212-48643-38E-0145	NA
2	PRINTER	HP	C2642A	MY79J1D00G	B94C2642X
3	MODEM	ACEEX	1414	0206026776	IFAXDM1414
For Radiation test					
No.	Product	Brand	Model No.	Serial No.	FCC ID
1	NOTEBOOK COMPUTER	ASUS	A2400H	49NG038481	NA
2	PRINTER	HP	C2642A	MY79F1C3MZ	B94C2642X

For Conducted test	
No.	Signal cable description
1	NA
2	1.8 m braid shielded wire, terminated with DB25 connector via metallic frame, w/o core.
3	1.3 m braid shielded wire, terminated with DB25 and DB9 connector via metallic frame, w/o core.
For Radiation test	
No.	Signal cable description
1	NA
2	1.8 m braid shielded wire, terminated with DB25 connector via metallic frame, w/o core.

Note: 1. All power cords of the above support units are unshielded (1.8m).

3.6 CONFIGURATION OF SYSTEM UNDER TEST

For Conducted test :

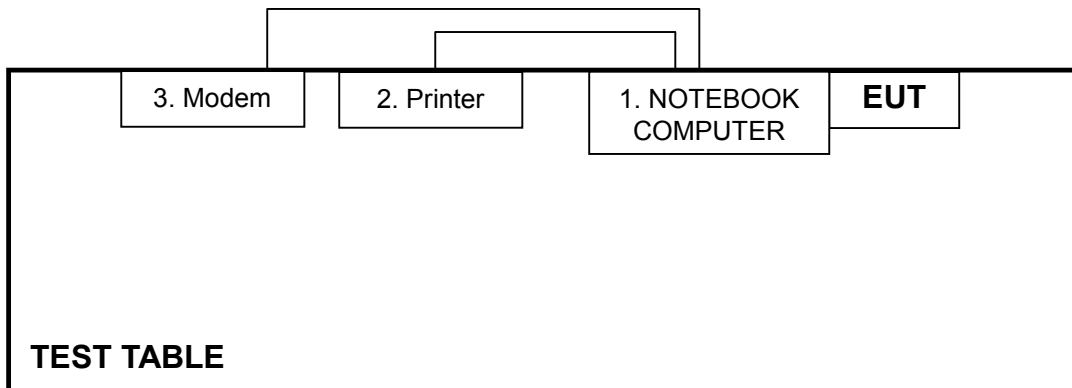

For Radiation test :

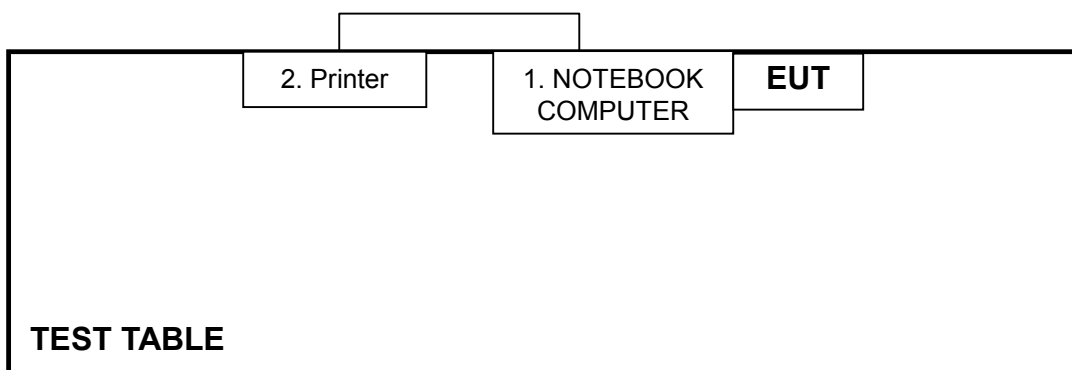

NOTE: 1. Please refer to the photos of test configuration in Item 5 also.



4 TEST TYPES AND RESULTS

4.1 CONDUCTED EMISSION MEASUREMENT

4.1.1 LIMITS OF CONDUCTED EMISSION MEASUREMENT

FREQUENCY OF EMISSION (MHz)	CONDUCTED LIMIT (dB μ V)	
	Quasi-peak	Average
0.15-0.5	66 to 56	56 to 46
0.5-5	56	46
5-30	60	50

NOTE:

1. The lower limit shall apply at the transition frequencies.
2. All emanations from a class B digital device or system, including any network of conductors and apparatus connected thereto, shall not exceed the level of field strengths specified above.

4.1.2 TEST INSTRUMENTS

DESCRIPTION & MANUFACTURER	MODEL NO.	SERIAL NO.	CALIBRATED UNTIL
Test Receiver	ESCS 30	100375	Sep. 19, 2006
Line-Impedance Stabilization Network(for EUT)	ENV-216	100071	Nov. 10, 2006
ROHDE & SCHWARZ LISN	KNW-407	8/1395/12	Jul. 19, 2006
RF Signal Cable	RG233/U	Cable_CA_02	Dec. 10, 2006
Terminator(for KYORITSU)	50	2	Oct. 08, 2006
Software	ADT_Cond_V7.3.2	NA	NA

- NOTE: 1. The calibration interval of the above test instruments is 12 months and the calibrations are traceable to NML/ROC and NIST/USA.
 2. The test was performed in ADT Shielded Room No. B.
 3. The VCCI Con B Registration No. is C-2193.

4.1.3 TEST PROCEDURES

- a. The EUT/HOST was placed 0.4 meters from the conducting wall of the shielded room with EUT/HOST being connected to the power mains through a line impedance stabilization network (LISN). Other support units were connected to the power mains through another LISN. The two LISNs provide 50 ohm/ 50uH of coupling impedance for the measuring instrument.
- b. Both lines of the power mains connected to the EUT/HOST were checked for maximum conducted interference.
- c. The frequency range from 150 kHz to 30 MHz was searched. Emission levels over 10dB under the prescribed limits could not be reported

4.1.4 TEST SETUP

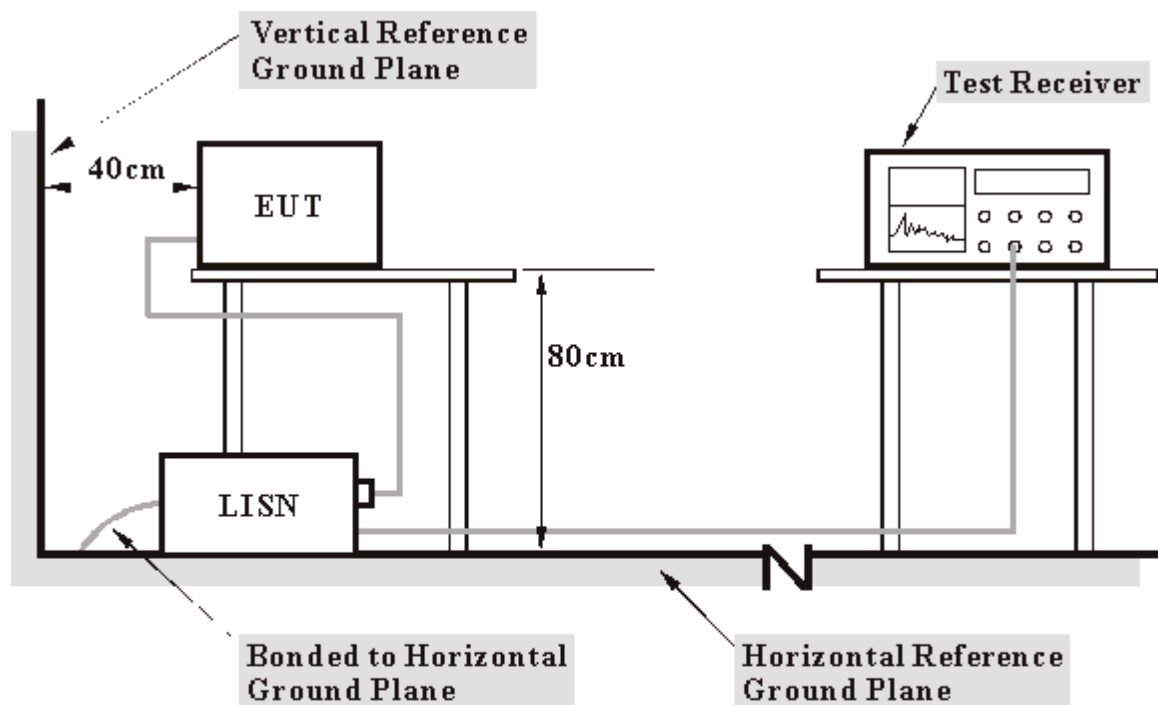

- Note:**
1. Support units were connected to second LISN.
 2. Both of LISNs (AMN) 80 cm from EUT and at the least 80 cm from other units and other metal planes support units.

For the actual test configuration, please refer to the related item – Photographs of the Test Configuration.

4.1.5 EUT OPERATING CONDITIONS

- a. Plug the EUT into the support unit 1 (Notebook computer) and placed it on the testing table.
- b. The support unit 1 (Notebook computer) ran a test program “MV tool” to enable EUT under transmission condition continuously at specific channel frequency.
- c. Notebook computer sends "H" messages to printer, and the printer prints them on paper.
- d. Notebook computer sends "H" messages to modem.(only for Conducted test)

4.1.6 TEST RESULTS

TEST MODE	Mode 1		
MODULATION TYPE	BPSK	CHANNEL	Channel 11
INPUT POWER (SYSTEM)	120Vac, 60 Hz	6dB BANDWIDTH	9 kHz
ENVIRONMENTAL CONDITIONS	22deg. C, 66%RH, 972hPa	TRANSFER RATE	6Mbps
TESTED BY	Eric Lee	PHASE	Line (L)

No	Freq. [MHz]	Corr. Factor (dB)	Reading Value		Emission Level		Limit		Margin	
			[dB (uV)]		[dB (uV)]		[dB (uV)]		(dB)	
			Q.P.	AV.	Q.P.	AV.	Q.P.	AV.	Q.P.	AV.
1	0.291	0.26	42.58	-	42.84	-	60.51	50.51	-17.67	-
2	0.365	0.27	44.54	-	44.81	-	58.62	48.62	-13.81	-
3	0.948	0.39	40.37	-	40.76	-	56.00	46.00	-15.24	-
4	0.951	0.39	40.43	-	40.82	-	56.00	46.00	-15.18	-
5	1.017	0.40	37.57	-	37.97	-	56.00	46.00	-18.03	-
6	10.797	1.09	34.64	-	35.73	-	60.00	50.00	-24.27	-

- REMARKS:**
1. Q.P. and AV. are abbreviations of quasi-peak and average individually.
 2. "-": The Quasi-peak reading value also meets average limit and measurement with the average detector is unnecessary.
 3. The emission levels of other frequencies were very low against the limit.
 4. Margin value = Emission level - Limit value
 5. Correction factor = Insertion loss + Cable loss
 6. Emission Level = Correction Factor + Reading Value.

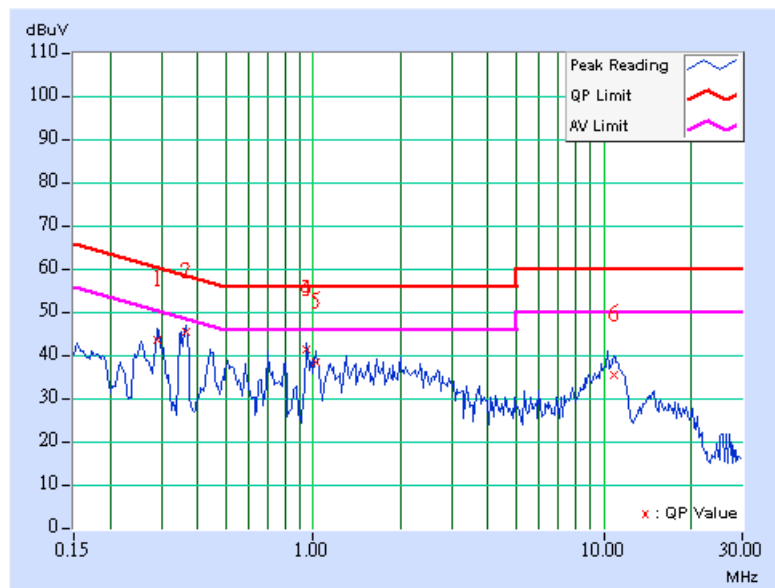

TEST MODE	Mode 1		
MODULATION TYPE	BPSK	CHANNEL	Channel 11
INPUT POWER (SYSTEM)	120Vac, 60 Hz	6dB BANDWIDTH	9 kHz
ENVIRONMENTAL CONDITIONS	22deg. C, 66%RH, 972hPa	TRANSFER RATE	6Mbps
TESTED BY	Eric Lee	PHASE	Neutral (N)

No	Freq. [MHz]	Corr. Factor (dB)	Reading Value		Emission Level		Limit		Margin	
			[dB (uV)]		[dB (uV)]		[dB (uV)]		(dB)	
			Q.P.	AV.	Q.P.	AV.	Q.P.	AV.	Q.P.	AV.
1	0.255	0.26	40.34	-	40.60	-	61.58	51.58	-20.98	-
2	0.291	0.26	43.59	-	43.85	-	60.51	50.51	-16.66	-
3	0.357	0.27	38.09	-	38.36	-	58.81	48.81	-20.45	-
4	0.946	0.39	40.35	-	40.74	-	56.00	46.00	-15.26	-
5	1.017	0.40	37.37	-	37.77	-	56.00	46.00	-18.23	-
6	10.250	1.06	35.05	-	36.11	-	60.00	50.00	-23.89	-

- REMARKS:**
1. Q.P. and AV. are abbreviations of quasi-peak and average individually.
 2. "-": The Quasi-peak reading value also meets average limit and measurement with the average detector is unnecessary.
 3. The emission levels of other frequencies were very low against the limit.
 4. Margin value = Emission level - Limit value
 5. Correction factor = Insertion loss + Cable loss
 6. Emission Level = Correction Factor + Reading Value.

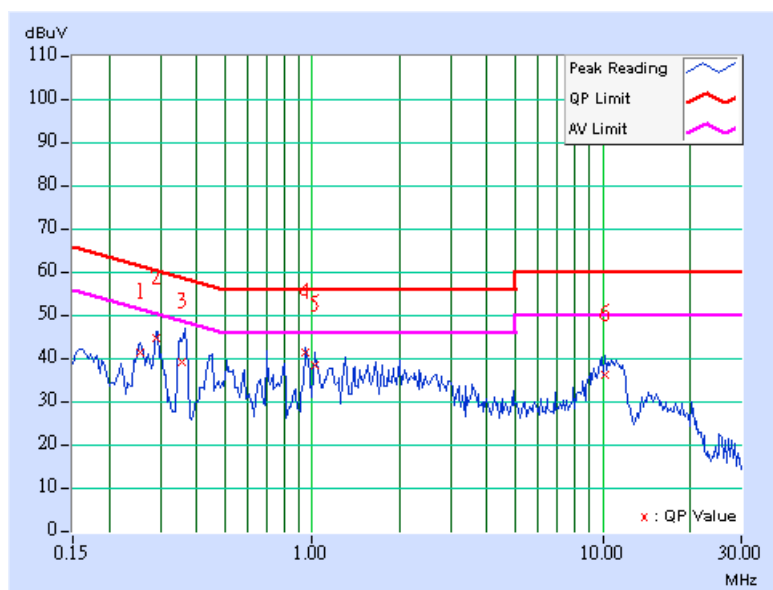

4.2 RADIATED EMISSION MEASUREMENT

4.2.1 LIMITS OF RADIATED EMISSION MEASUREMENT

Emissions radiated outside of the specified bands, shall be according to the general radiated limits in 15.209 as following:

Frequencies (MHz)	Field strength (microvolts/meter)	Measurement distance (meters)
0.009-0.490	2400/F(kHz)	300
0.490-1.705	24000/F(kHz)	30
1.705-30.0	30	30
30-88	100	3
88-216	150	3
216-960	200	3
Above 960	500	3

NOTE:

1. The lower limit shall apply at the transition frequencies.
2. Emission level (dBuV/m) = 20 log Emission level (uV/m).
3. As shown in 15.35(b), for frequencies above 1000MHz, the field strength limits are based on average detector, however, the peak field strength of any emission shall not exceed the maximum permitted average limits, specified above by more than 20dB under any condition of modulation.

4.2.2 TEST INSTRUMENTS

DESCRIPTION & MANUFACTURER	MODEL NO.	SERIAL NO.	CALIBRATED UNTIL
ADVANTEST Spectrum Analyzer	R3271A	85060311	July 07, 2006
HP Pre_Amplifier	8449B	3008A01922	Oct. 02, 2006
ROHDE & SCHWARZ Test Receiver	ESCS30	100287	Dec. 08, 2006
CHASE Broadband Antenna	VULB9168	138	Dec. 21, 2006
Schwarzbeck Horn_Antenna	BBHA9120	D124	Dec. 11, 2006
Schwarzbeck Horn_Antenna	BBHA 9170	BBHA9170153	Jan. 05, 2007
SCHWARZBECK Biconical Antenna	VHBA9123	459	Jun. 26, 2006
SCHWARZBECK Periodic Antenna	UPA6108	1148	Jun. 26, 2006
RF Switches (ARNITSU)	CS-201	1565157	NA
RF CABLE (Chaintek) 1GHz-20GHz	SF102	22054-2	Nov. 16. 2006
RF Cable(RICHTEC)	9913-30M	STCCAB-30M- 1GHz-021	Jul. 16, 2006
Software	ADT_Radiated_V 5.14	NA	NA
CHANCE MOST Antenna Tower	AT-100	0203	NA
CHANCE MOST Turn Table	TT-100	0203	NA

Note: 1. The calibration interval of the above test instruments is 12 months (36 months for Periodic Antenna) and the calibrations are traceable to NML/ROC and NIST/USA.

2. The horn antenna and HP preamplifier (model: 8449B) are used only for the measurement of emission frequency above 1GHz if tested.
3. The test was performed in ADT Open Site No. C.
4. The FCC Site Registration No. is 656396.
5. The VCCI Site Registration No. is R-1626.
6. The CANADA Site Registration No. is IC 4824-3.
7. The following table is for the measurement uncertainty, which is calculated as per the document CISPR 16-4. This uncertainty represents an expanded uncertainty expressed at approximately the 95% confidence level using a coverage factor of k=2.

Measurement	Value
Radiated emissions (30MHz-1GHz)	2.98 dB
Radiated emissions (1GHz ~18GHz)	2.21 dB
Radiated emissions (18GHz ~20GHz)	1.88 dB

4.2.3 TEST PROCEDURES

- a. The EUT was placed on the top of a rotating table 0.8 meters above the ground at a 10 meter open area test site. The table was rotated 360 degrees to determine the position of the highest radiation.
- b. The EUT was set 3 meters away from the interference-receiving antenna, which was mounted on the top of a variable-height antenna tower.
- c. The antenna is a broadband antenna, and its height is varied from one meter to four meters above the ground to determine the maximum value of the field strength. Both horizontal and vertical polarizations of the antenna are set to make the measurement.
- d. For each suspected emission, the EUT was arranged to its worst case and then the antenna was tuned to heights from 1 meter to 4 meters and the rotatable table was turned from 0 degrees to 360 degrees to find the maximum reading.
- e. The test-receiver system was set to Peak Detect Function and Specified Bandwidth with Maximum Hold Mode.
- f. If the emission level of the EUT in peak mode was 10 dB lower than the limit specified, then testing could be stopped and the peak values of the EUT would be reported. Otherwise the emissions that did not have 10 dB margin would be re-tested one by one using peak, quasi-peak or average method as specified and then reported in a data sheet.

NOTE:

1. The resolution bandwidth and video bandwidth of test receiver/spectrum analyzer is 120kHz for Peak detection (PK) and Quasi-peak detection (QP) at frequency below 1GHz.
2. The resolution bandwidth and video bandwidth of test receiver/spectrum analyzer is 1 MHz for Peak detection at frequency above 1GHz.
3. The resolution bandwidth of test receiver/spectrum analyzer is 1 MHz and the video bandwidth is 10 Hz for Average detection (AV) at frequency above 1GHz.

4.2.4 TEST SETUP

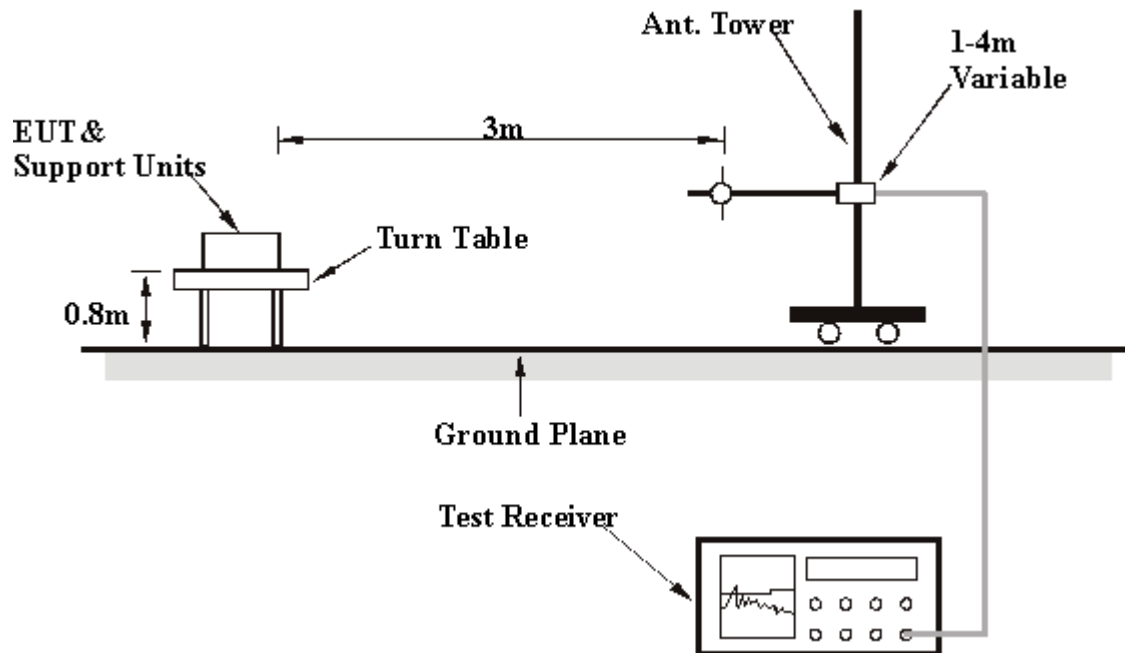

For the actual test configuration, please refer to the related item – Photographs of the Test Configuration.

4.2.5 EUT OPERATING CONDITIONS

Same as 4.1.5



4.2.6 TEST RESULTS (MODE 1)

Below 1GHz Worst-Case Data

TEST MODE	Mode 1		
MODULATION TYPE	CCK	CHANNEL	Channel 1
INPUT POWER (SYSTEM)	120Vac, 60 Hz	FREQUENCY RANGE	30-1000 MHz
ENVIRONMENTAL CONDITIONS	20deg. C, 62%RH, 972hPa	TRANSFER RATE	11Mbps
TESTED BY	Moris Lin	DETECTOR FUNCTION	Quasi-Peak, 120kHz

ANTENNA POLARITY & TEST DISTANCE: HORIZONTAL AT 3 M								
No.	Freq. (MHz)	Emission Level (dBuV/m)	Limit (dBuV/m)	Margin (dB)	Antenna Height (m)	Table Angle (Degree)	Raw Value (dBuV)	Correction Factor (dB/m)
1	159.75	39.50 QP	43.50	-4.00	2.00 H	266	25.40	14.10
2	172.03	32.10 QP	43.50	-11.40	1.74 H	72	18.70	13.40
3	239.99	39.80 QP	46.00	-6.20	1.30 H	235	26.50	13.30
4	344.06	32.60 QP	46.00	-13.40	2.62 H	303	15.30	17.30
5	456.02	29.90 QP	46.00	-16.10	1.78 H	220	9.30	20.60
6	479.99	40.90 QP	46.00	-5.10	2.82 H	200	19.70	21.20
7	719.98	35.50 QP	46.00	-10.50	1.20 H	300	9.10	26.40
8	860.15	29.70 QP	46.00	-16.30	1.53 H	7	1.20	28.50
9	960.00	25.90 QP	46.00	-20.10	1.15 H	1	-3.90	29.90

ANTENNA POLARITY & TEST DISTANCE: VERTICAL AT 3 M								
No.	Freq. (MHz)	Emission Level (dBuV/m)	Limit (dBuV/m)	Margin (dB)	Antenna Height (m)	Table Angle (Degree)	Raw Value (dBuV)	Correction Factor (dB/m)
1	130.30	23.60 QP	43.50	-19.90	1.38 V	43	10.90	12.60
2	172.04	28.60 QP	43.50	-14.90	1.04 V	286	15.10	13.40
3	240.00	30.30 QP	46.00	-15.70	2.12 V	95	16.90	13.30
4	325.00	28.80 QP	46.00	-17.20	1.73 V	21	11.70	17.10
5	344.06	33.50 QP	46.00	-12.50	1.57 V	292	16.20	17.30
6	479.98	35.50 QP	46.00	-10.50	2.47 V	37	14.30	21.20
7	719.97	27.20 QP	46.00	-18.80	2.11 V	210	0.70	26.40
8	960.00	24.80 QP	46.00	-21.20	2.61 V	54	-5.10	29.90

- REMARKS:**
1. Emission level(dBuV/m)=Raw Value(dBuV) + Correction Factor(dB/m)
 2. Correction Factor(dB/m) = Antenna Factor (dB/m) + Cable Factor (dB)
 3. The other emission levels were very low against the limit.
 4. Margin value = Emission level – Limit value.



4.2.7 TEST RESULTS –DSSS (MODE 1)
802.11b DSSS modulation

TEST MODE	Mode 1		
MODE	Channel 1	FREQUENCY RANGE	1000~25000MHz
INPUT POWER (SYSTEM)	120Vac, 60 Hz	DETECTOR FUNCTION & BANDWIDTH	Peak (PK) Average (AV) 1 MHz
ENVIRONMENTAL CONDITIONS	21 deg. C, 57%RH, 972hPa	TESTED BY	Tony Chen

ANTENNA POLARITY & TEST DISTANCE: HORIZONTAL AT 3 M

No.	Freq. (MHz)	Emission Level (dBuV/m)	Limit (dBuV/m)	Margin (dB)	Antenna Height (m)	Table Angle (Degree)	Raw Value (dBuV)	Correction Factor (dB/m)
1	2390.00	57.00 PK	74.00	-17.00	1.19 H	10	23.40	33.70
1	2390.00	48.00 AV	54.00	-6.00	1.19 H	10	14.30	33.70
2	*2412.00	111.40 PK			1.19 H	10	81.60	29.80
2	*2412.00	104.50 AV			1.19 H	10	74.70	29.80
3	4824.00	52.80 PK	74.00	-21.20	1.11 H	282	17.70	35.10
3	4824.00	50.60 AV	54.00	-3.40	1.11 H	282	15.50	35.10
4	7236.00	47.40 PK	74.00	-26.60	1.09 H	12	6.90	40.50
4	7236.00	36.20 AV	54.00	-17.80	1.09 H	12	-4.30	40.50

ANTENNA POLARITY & TEST DISTANCE: VERTICAL AT 3 M

No.	Freq. (MHz)	Emission Level (dBuV/m)	Limit (dBuV/m)	Margin (dB)	Antenna Height (m)	Table Angle (Degree)	Raw Value (dBuV)	Correction Factor (dB/m)
1	2390.00	47.80 PK	74.00	-26.20	1.38 V	133	14.10	33.70
1	2390.00	38.60 AV	54.00	-15.40	1.38 V	133	4.90	33.70
2	*2412.00	101.80 PK			1.38 V	133	72.00	29.80
2	*2412.00	95.10 AV			1.38 V	133	65.20	29.80
3	4824.00	52.80 PK	74.00	-21.20	1.31 V	10	17.70	35.10
3	4824.00	50.70 AV	54.00	-3.30	1.31 V	10	15.60	35.10
4	7236.00	47.30 PK	74.00	-26.70	1.27 V	113	6.80	40.50
4	7236.00	36.20 AV	54.00	-17.80	1.27 V	113	-4.30	40.50

- REMARKS:**
1. Emission level(dBuV/m)=Raw Value(dBuV) + Correction Factor(dB/m)
 2. Correction Factor(dB/m) = Antenna Factor (dB/m) + Cable Factor (dB)
 3. The other emission levels were very low against the limit.
 4. Margin value = Emission level – Limit value.
 5. The limit value is defined as per 15.247
 6. “ * “ : Fundamental frequency

TEST MODE	Mode 1		
MODE	Channel 6	FREQUENCY RANGE	1000~25000MHz
INPUT POWER (SYSTEM)	120Vac, 60 Hz	DETECTOR FUNCTION & BANDWIDTH	Peak (PK) Average (AV) 1 MHz
ENVIRONMENTAL CONDITIONS	21 deg. C, 57%RH, 972hPa	TESTED BY	Tony Chen

ANTENNA POLARITY & TEST DISTANCE: HORIZONTAL AT 3 M

No.	Freq. (MHz)	Emission Level (dBuV/m)	Limit (dBuV/m)	Margin (dB)	Antenna Height (m)	Table Angle (Degree)	Raw Value (dBuV)	Correction Factor (dB/m)
1	*2437.00	111.90 PK			1.16 H	6	82.00	29.90
1	*2437.00	104.80 AV			1.16 H	6	74.80	29.90
2	4874.00	52.40 PK	74.00	-21.60	1.09 H	270	17.00	35.30
2	4874.00	49.80 AV	54.00	-4.20	1.09 H	270	14.50	35.30
3	7311.00	47.40 PK	74.00	-26.60	1.11 H	29	6.70	40.70
3	7311.00	36.40 AV	54.00	-17.60	1.11 H	29	-4.20	40.70

ANTENNA POLARITY & TEST DISTANCE: VERTICAL AT 3 M

No.	Freq. (MHz)	Emission Level (dBuV/m)	Limit (dBuV/m)	Margin (dB)	Antenna Height (m)	Table Angle (Degree)	Raw Value (dBuV)	Correction Factor (dB/m)
1	*2437.00	102.90 PK			1.31 V	134	73.00	29.90
1	*2437.00	97.00 AV			1.31 V	134	67.10	29.90
2	4874.00	53.30 PK	74.00	-20.70	1.30 V	254	17.90	35.30
2	4874.00	50.90 AV	54.00	-3.10	1.30 V	254	15.60	35.30
3	7311.00	47.80 PK	74.00	-26.20	1.22 V	357	7.10	40.70
3	7311.00	36.50 AV	54.00	-17.50	1.22 V	357	-4.20	40.70

- REMARKS:**
1. Emission level(dBuV/m)=Raw Value(dBuV) + Correction Factor(dB/m)
 2. Correction Factor(dB/m) = Antenna Factor (dB/m) + Cable Factor (dB)
 3. The other emission levels were very low against the limit.
 4. Margin value = Emission level – Limit value.
 5. The limit value is defined as per 15.247
 6. “ * ” : Fundamental frequency



TEST MODE	Mode 1		
MODE	Channel 11	FREQUENCY RANGE	1000~25000MHz
INPUT POWER (SYSTEM)	120Vac, 60 Hz	DETECTOR FUNCTION & BANDWIDTH	Peak (PK) Average (AV) 1 MHz
ENVIRONMENTAL CONDITIONS	21 deg. C, 57%RH, 972hPa	TESTED BY	Tony Chen

ANTENNA POLARITY & TEST DISTANCE: HORIZONTAL AT 3 M

No.	Freq. (MHz)	Emission Level (dBuV/m)	Limit (dBuV/m)	Margin (dB)	Antenna Height (m)	Table Angle (Degree)	Raw Value (dBuV)	Correction Factor (dB/m)
1	*2462.00	110.30 PK			1.50 H	98	80.20	30.00
1	*2462.00	104.00 AV			1.50 H	98	74.00	30.00
2	2483.50	55.90 PK	74.00	-18.10	1.50 H	98	25.80	30.10
2	2483.50	49.60 AV	54.00	-4.40	1.50 H	98	19.50	30.10
3	4924.00	53.10 PK	74.00	-20.90	1.13 H	3	17.60	35.50
3	4924.00	49.50 AV	54.00	-4.50	1.13 H	3	14.00	35.50
4	7386.00	47.70 PK	74.00	-26.30	1.08 H	315	6.90	40.80
4	7386.00	37.10 AV	54.00	-16.90	1.08 H	315	-3.70	40.80

ANTENNA POLARITY & TEST DISTANCE: VERTICAL AT 3 M

No.	Freq. (MHz)	Emission Level (dBuV/m)	Limit (dBuV/m)	Margin (dB)	Antenna Height (m)	Table Angle (Degree)	Raw Value (dBuV)	Correction Factor (dB/m)
1	*2462.00	103.50 PK			1.33 V	129	73.50	30.00
1	*2462.00	96.70 AV			1.33 V	129	66.70	30.00
2	2483.50	50.90 PK	74.00	-23.10	1.33 V	129	20.70	30.10
2	2483.50	42.30 AV	54.00	-11.70	1.33 V	129	12.20	30.10
3	4924.00	53.80 PK	74.00	-20.20	1.16 V	256	18.20	35.50
3	4924.00	50.90 AV	54.00	-3.10	1.16 V	256	15.40	35.50
4	7386.00	48.40 PK	74.00	-25.60	1.20 V	294	7.60	40.80
4	7386.00	37.00 AV	54.00	-17.00	1.20 V	294	-3.80	40.80

- REMARKS:**
1. Emission level(dBuV/m)=Raw Value(dBuV) + Correction Factor(dB/m)
 2. Correction Factor(dB/m) = Antenna Factor (dB/m) + Cable Factor (dB)
 3. The other emission levels were very low against the limit.
 4. Margin value = Emission level – Limit value.
 5. The limit value is defined as per 15.247
 6. “ * ” : Fundamental frequency



4.2.8 TEST RESULTS – OFDM (MODE 1)

802.11g Normal OFDM modulation

TEST MODE	Mode 1		
MODE	Channel 1	FREQUENCY RANGE	1000~25000MHz
INPUT POWER (SYSTEM)	120Vac, 60 Hz	DETECTOR FUNCTION & BANDWIDTH	Peak (PK) Average (AV) 1 MHz
ENVIRONMENTAL CONDITIONS	21 deg. C, 57%RH, 972hPa	TESTED BY	Tony Chen

ANTENNA POLARITY & TEST DISTANCE: HORIZONTAL AT 3 M

No.	Freq. (MHz)	Emission Level (dBuV/m)	Limit (dBuV/m)	Margin (dB)	Antenna Height (m)	Table Angle (Degree)	Raw Value (dBuV)	Correction Factor (dB/m)
1	2390.00	69.90 PK	74.00	-4.10	1.18 H	28	36.20	33.70
1	2390.00	48.80 AV	54.00	-5.20	1.18 H	28	15.10	33.70
2	*2412.00	108.60 PK			1.18 H	28	78.80	29.80
2	*2412.00	99.20 AV			1.18 H	28	69.40	29.80
3	4824.00	51.70 PK	74.00	-22.30	1.10 H	278	16.60	35.10
3	4824.00	50.00 AV	54.00	-4.00	1.10 H	278	14.90	35.10
4	7236.00	47.80 PK	74.00	-26.20	1.11 H	305	7.30	40.50
4	7236.00	36.40 AV	54.00	-17.60	1.11 H	305	-4.10	40.50

ANTENNA POLARITY & TEST DISTANCE: VERTICAL AT 3 M

No.	Freq. (MHz)	Emission Level (dBuV/m)	Limit (dBuV/m)	Margin (dB)	Antenna Height (m)	Table Angle (Degree)	Raw Value (dBuV)	Correction Factor (dB/m)
1	2390.00	60.10 PK	74.00	-13.90	1.38 V	130	26.40	33.70
1	2390.00	39.10 AV	54.00	-14.90	1.38 V	130	5.50	33.70
2	*2412.00	98.80 PK			1.38 V	130	69.00	29.80
2	*2412.00	89.50 AV			1.38 V	130	59.70	29.80
3	4824.00	52.50 PK	74.00	-21.50	1.00 V	9	17.40	35.10
3	4824.00	50.70 AV	54.00	-3.30	1.00 V	9	15.60	35.10
4	7236.00	47.20 PK	74.00	-26.80	1.13 V	313	6.70	40.50
4	7236.00	36.30 AV	54.00	-17.70	1.13 V	313	-4.20	40.50

- REMARKS:**
1. Emission level(dBuV/m)=Raw Value(dBuV) + Correction Factor(dB/m)
 2. Correction Factor(dB/m) = Antenna Factor (dB/m) + Cable Factor (dB)
 3. The other emission levels were very low against the limit.
 4. Margin value = Emission level – Limit value.
 5. The limit value is defined as per 15.247
 6. “ * “ : Fundamental frequency



TEST MODE	Mode 1		
MODE	Channel 6	FREQUENCY RANGE	1000~25000MHz
INPUT POWER (SYSTEM)	120Vac, 60 Hz	DETECTOR FUNCTION & BANDWIDTH	Peak (PK) Average (AV) 1 MHz
ENVIRONMENTAL CONDITIONS	21 deg. C, 57%RH, 972hPa	TESTED BY	Tony Chen

ANTENNA POLARITY & TEST DISTANCE: HORIZONTAL AT 3 M

No.	Freq. (MHz)	Emission Level (dBuV/m)	Limit (dBuV/m)	Margin (dB)	Antenna Height (m)	Table Angle (Degree)	Raw Value (dBuV)	Correction Factor (dB/m)
1	*2437.00	107.90 PK			1.16 H	34	78.00	29.90
1	*2437.00	98.10 AV			1.16 H	34	68.20	29.90
2	4874.00	52.20 PK	74.00	-21.80	1.09 H	274	16.90	35.30
2	4874.00	49.80 AV	54.00	-4.20	1.09 H	274	14.40	35.30
3	7311.00	47.70 PK	74.00	-26.30	1.03 H	353	7.10	40.70
3	7311.00	36.50 AV	54.00	-17.50	1.03 H	353	-4.10	40.70

ANTENNA POLARITY & TEST DISTANCE: VERTICAL AT 3 M

No.	Freq. (MHz)	Emission Level (dBuV/m)	Limit (dBuV/m)	Margin (dB)	Antenna Height (m)	Table Angle (Degree)	Raw Value (dBuV)	Correction Factor (dB/m)
1	*2437.00	99.80 PK			1.32 V	135	69.90	29.90
1	*2437.00	90.40 AV			1.32 V	135	60.40	29.90
2	4874.00	53.10 PK	74.00	-20.90	1.01 V	259	17.80	35.30
2	4874.00	51.20 AV	54.00	-2.80	1.01 V	259	15.90	35.30
3	7311.00	47.70 PK	74.00	-26.30	1.15 V	211	7.00	40.70
3	7311.00	36.60 AV	54.00	-17.40	1.15 V	211	-4.00	40.70

- REMARKS:**
1. Emission level(dBuV/m)=Raw Value(dBuV) + Correction Factor(dB/m)
 2. Correction Factor(dB/m) = Antenna Factor (dB/m) + Cable Factor (dB)
 3. The other emission levels were very low against the limit.
 4. Margin value = Emission level – Limit value.
 5. The limit value is defined as per 15.247
 6. " * " : Fundamental frequency



TEST MODE	Mode 1		
MODE	Channel 11	FREQUENCY RANGE	1000~25000MHz
INPUT POWER (SYSTEM)	120Vac, 60 Hz	DETECTOR FUNCTION & BANDWIDTH	Peak (PK) Average (AV) 1 MHz
ENVIRONMENTAL CONDITIONS	21 deg. C, 57%RH, 972hPa	TESTED BY	Tony Chen

ANTENNA POLARITY & TEST DISTANCE: HORIZONTAL AT 3 M

No.	Freq. (MHz)	Emission Level (dBuV/m)	Limit (dBuV/m)	Margin (dB)	Antenna Height (m)	Table Angle (Degree)	Raw Value (dBuV)	Correction Factor (dB/m)
1	*2462.00	108.30 PK			1.18 H	33	78.30	30.00
1	*2462.00	99.20 AV			1.18 H	33	69.10	30.00
2	2483.50	73.80 PK	74.00	-0.20	1.18 H	33	43.70	30.10
2	2483.50	51.90 AV	54.00	-2.10	1.18 H	33	21.80	30.10
3	4924.00	52.20 PK	74.00	-21.80	1.02 H	2	16.70	35.50
3	4924.00	50.80 AV	54.00	-3.20	1.02 H	2	15.30	35.50
4	7386.00	48.60 PK	74.00	-25.40	1.16 H	214	7.80	40.80
4	7386.00	37.40 AV	54.00	-16.60	1.16 H	214	-3.40	40.80

ANTENNA POLARITY & TEST DISTANCE: VERTICAL AT 3 M

No.	Freq. (MHz)	Emission Level (dBuV/m)	Limit (dBuV/m)	Margin (dB)	Antenna Height (m)	Table Angle (Degree)	Raw Value (dBuV)	Correction Factor (dB/m)
1	*2462.00	100.80 PK			1.32 V	130	70.80	30.00
1	*2462.00	91.10 AV			1.32 V	130	61.10	30.00
2	2483.50	66.20 PK	74.00	-7.80	1.32 V	130	36.10	30.10
2	2483.50	43.90 AV	54.00	-10.10	1.32 V	130	13.70	30.10
3	4924.00	53.90 PK	74.00	-20.10	1.13 V	264	18.40	35.50
3	4924.00	52.00 AV	54.00	-2.00	1.13 V	264	16.40	35.50
4	7386.00	48.30 PK	74.00	-25.70	1.35 V	326	7.40	40.80
4	7386.00	37.60 AV	54.00	-16.40	1.35 V	326	-3.20	40.80

- REMARKS:**
1. Emission level(dBuV/m)=Raw Value(dBuV) + Correction Factor(dB/m)
 2. Correction Factor(dB/m) = Antenna Factor (dB/m) + Cable Factor (dB)
 3. The other emission levels were very low against the limit.
 4. Margin value = Emission level – Limit value.
 5. The limit value is defined as per 15.247
 6. “ * “ : Fundamental frequency



4.2.9 TEST RESULTS –DSSS (MODE 2)
802.11b DSSS modulation

TEST MODE	Mode 2		
MODE	Channel 1	FREQUENCY RANGE	1000~25000MHz
INPUT POWER (SYSTEM)	120Vac, 60 Hz	DETECTOR FUNCTION & BANDWIDTH	Peak (PK) Average (AV) 1 MHz
ENVIRONMENTAL CONDITIONS	21 deg. C, 59%RH, 972hPa	TESTED BY	Tony Chen

ANTENNA POLARITY & TEST DISTANCE: HORIZONTAL AT 3 M

No.	Freq. (MHz)	Emission Level (dBuV/m)	Limit (dBuV/m)	Margin (dB)	Antenna Height (m)	Table Angle (Degree)	Raw Value (dBuV)	Correction Factor (dB/m)
1	2390.00	43.00 PK	74.00	-31.00	1.01 H	68	9.30	33.70
1	2390.00	34.40 AV	54.00	-19.60	1.01 H	68	0.70	33.70
2	*2412.00	97.40 PK			1.01 H	68	67.60	29.80
2	*2412.00	90.90 AV			1.01 H	68	61.10	29.80
3	4824.00	47.60 PK	74.00	-26.40	1.52 H	62	12.50	35.10
3	4824.00	42.40 AV	54.00	-11.60	1.52 H	62	7.30	35.10
4	7236.00	47.10 PK	74.00	-26.90	1.26 H	325	6.60	40.50
4	7236.00	36.20 AV	54.00	-17.80	1.26 H	325	-4.30	40.50

ANTENNA POLARITY & TEST DISTANCE: VERTICAL AT 3 M

No.	Freq. (MHz)	Emission Level (dBuV/m)	Limit (dBuV/m)	Margin (dB)	Antenna Height (m)	Table Angle (Degree)	Raw Value (dBuV)	Correction Factor (dB/m)
1	2390.00	54.70 PK	74.00	-19.30	1.96 V	226	21.00	33.70
1	2390.00	45.60 AV	54.00	-8.40	1.96 V	226	11.90	33.70
2	*2412.00	109.10 PK			1.96 V	226	79.30	29.80
2	*2412.00	102.10 AV			1.96 V	226	72.30	29.80
3	4824.00	50.50 PK	74.00	-23.50	1.29 V	277	15.40	35.10
3	4824.00	48.70 AV	54.00	-5.30	1.29 V	277	13.60	35.10
4	7236.00	47.30 PK	74.00	-26.70	1.17 V	254	6.80	40.50
4	7236.00	36.20 AV	54.00	-17.80	1.17 V	254	-4.30	40.50

- REMARKS:**
1. Emission level(dBuV/m)=Raw Value(dBuV) + Correction Factor(dB/m)
 2. Correction Factor(dB/m) = Antenna Factor (dB/m) + Cable Factor (dB)
 3. The other emission levels were very low against the limit.
 4. Margin value = Emission level – Limit value.
 5. The limit value is defined as per 15.247
 6. “ * “ : Fundamental frequency



TEST MODE	Mode 2		
MODE	Channel 6	FREQUENCY RANGE	1000~25000MHz
INPUT POWER (SYSTEM)	120Vac, 60 Hz	DETECTOR FUNCTION & BANDWIDTH	Peak (PK) Average (AV) 1 MHz
ENVIRONMENTAL CONDITIONS	21 deg. C, 59%RH, 972hPa	TESTED BY	Tony Chen

ANTENNA POLARITY & TEST DISTANCE: HORIZONTAL AT 3 M

No.	Freq. (MHz)	Emission Level (dBuV/m)	Limit (dBuV/m)	Margin (dB)	Antenna Height (m)	Table Angle (Degree)	Raw Value (dBuV)	Correction Factor (dB/m)
1	*2437.00	99.20 PK			1.00 H	158	69.30	29.90
1	*2437.00	92.40 AV			1.00 H	158	62.40	29.90
2	4874.00	49.40 PK	74.00	-24.60	1.02 H	62	14.10	35.30
2	4874.00	45.30 AV	54.00	-8.70	1.02 H	62	10.00	35.30
3	7311.00	47.40 PK	74.00	-26.60	1.13 H	243	6.70	40.70
3	7311.00	36.40 AV	54.00	-17.60	1.13 H	243	-4.20	40.70

ANTENNA POLARITY & TEST DISTANCE: VERTICAL AT 3 M

No.	Freq. (MHz)	Emission Level (dBuV/m)	Limit (dBuV/m)	Margin (dB)	Antenna Height (m)	Table Angle (Degree)	Raw Value (dBuV)	Correction Factor (dB/m)
1	*2437.00	110.10 PK			1.45 V	101	80.20	29.90
1	*2437.00	103.70 AV			1.45 V	101	73.80	29.90
2	4874.00	50.30 PK	74.00	-23.70	1.31 V	128	15.00	35.30
2	4874.00	47.40 AV	54.00	-6.60	1.31 V	128	12.10	35.30
3	7311.00	47.70 PK	74.00	-26.30	1.18 V	279	7.00	40.70
3	7311.00	36.40 AV	54.00	-17.60	1.18 V	279	-4.30	40.70

- REMARKS:**
1. Emission level(dBuV/m)=Raw Value(dBuV) + Correction Factor(dB/m)
 2. Correction Factor(dB/m) = Antenna Factor (dB/m) + Cable Factor (dB)
 3. The other emission levels were very low against the limit.
 4. Margin value = Emission level – Limit value.
 5. The limit value is defined as per 15.247
 6. “ * “ : Fundamental frequency



TEST MODE	Mode 2		
MODE	Channel 11	FREQUENCY RANGE	1000~25000MHz
INPUT POWER (SYSTEM)	120Vac, 60 Hz	DETECTOR FUNCTION & BANDWIDTH	Peak (PK) Average (AV) 1 MHz
ENVIRONMENTAL CONDITIONS	21 deg. C, 59%RH, 972hPa	TESTED BY	Tony Chen

ANTENNA POLARITY & TEST DISTANCE: HORIZONTAL AT 3 M

No.	Freq. (MHz)	Emission Level (dBuV/m)	Limit (dBuV/m)	Margin (dB)	Antenna Height (m)	Table Angle (Degree)	Raw Value (dBuV)	Correction Factor (dB/m)
1	*2462.00	98.90 PK			1.00 H	159	68.90	30.00
1	*2462.00	92.00 AV			1.00 H	159	62.00	30.00
2	2483.50	46.30 PK	74.00	-27.70	1.00 H	159	16.20	30.10
2	2483.50	37.60 AV	54.00	-16.40	1.00 H	159	7.50	30.10
3	4924.00	48.90 PK	74.00	-25.10	1.16 H	13	13.40	35.50
3	4924.00	44.90 AV	54.00	-9.10	1.16 H	13	9.40	35.50
4	7386.00	48.50 PK	74.00	-25.50	1.18 H	21	7.70	40.80
4	7386.00	36.90 AV	54.00	-17.10	1.18 H	21	-3.90	40.80

ANTENNA POLARITY & TEST DISTANCE: VERTICAL AT 3 M

No.	Freq. (MHz)	Emission Level (dBuV/m)	Limit (dBuV/m)	Margin (dB)	Antenna Height (m)	Table Angle (Degree)	Raw Value (dBuV)	Correction Factor (dB/m)
1	*2462.00	110.50 PK			1.41 V	104	80.40	30.00
1	*2462.00	103.80 AV			1.41 V	104	73.80	30.00
2	2483.50	57.80 PK	74.00	-16.20	1.41 V	104	27.70	30.10
2	2483.50	49.40 AV	54.00	-4.60	1.41 V	104	19.20	30.10
3	4924.00	49.70 PK	74.00	-24.30	1.48 V	248	14.20	35.50
3	4924.00	46.90 AV	54.00	-7.10	1.48 V	248	11.40	35.50
4	7386.00	48.00 PK	74.00	-26.00	1.38 V	272	7.20	40.80
4	7386.00	36.90 AV	54.00	-17.10	1.38 V	272	-3.90	40.80

- REMARKS:**
1. Emission level(dBuV/m)=Raw Value(dBuV) + Correction Factor(dB/m)
 2. Correction Factor(dB/m) = Antenna Factor (dB/m) + Cable Factor (dB)
 3. The other emission levels were very low against the limit.
 4. Margin value = Emission level – Limit value.
 5. The limit value is defined as per 15.247
 6. “ * ” : Fundamental frequency



4.2.10 TEST RESULTS – OFDM (MODE 2)

802.11g Normal OFDM modulation

TEST MODE	Mode 2		
MODE	Channel 1	FREQUENCY RANGE	1000~25000MHz
INPUT POWER (SYSTEM)	120Vac, 60 Hz	DETECTOR FUNCTION & BANDWIDTH	Peak (PK) Average (AV) 1 MHz
ENVIRONMENTAL CONDITIONS	21 deg. C, 59%RH, 972hPa	TESTED BY	Tony Chen

ANTENNA POLARITY & TEST DISTANCE: HORIZONTAL AT 3 M

No.	Freq. (MHz)	Emission Level (dBuV/m)	Limit (dBuV/m)	Margin (dB)	Antenna Height (m)	Table Angle (Degree)	Raw Value (dBuV)	Correction Factor (dB/m)
1	2390.00	59.60 PK	74.00	-14.40	1.78 H	119	25.90	33.70
1	2390.00	38.20 AV	54.00	-15.80	1.78 H	119	4.50	33.70
2	*2412.00	98.30 PK			1.78 H	119	68.50	29.80
2	*2412.00	88.60 AV			1.78 H	119	58.80	29.80
3	4824.00	47.70 PK	74.00	-26.30	1.54 H	64	12.60	35.10
3	4824.00	42.50 AV	54.00	-11.50	1.54 H	64	7.30	35.10
4	7236.00	47.80 PK	74.00	-26.20	1.59 H	184	7.30	40.50
4	7236.00	36.20 AV	54.00	-17.80	1.59 H	184	-4.30	40.50

ANTENNA POLARITY & TEST DISTANCE: VERTICAL AT 3 M

No.	Freq. (MHz)	Emission Level (dBuV/m)	Limit (dBuV/m)	Margin (dB)	Antenna Height (m)	Table Angle (Degree)	Raw Value (dBuV)	Correction Factor (dB/m)
1	2390.00	69.70 PK	74.00	-4.30	1.45 V	104	36.00	33.70
1	2390.00	48.30 AV	54.00	-5.70	1.45 V	104	14.60	33.70
2	*2412.00	108.50 PK			1.45 V	104	78.70	29.80
2	*2412.00	98.70 AV			1.45 V	104	68.90	29.80
3	4824.00	50.30 PK	74.00	-23.70	1.17 V	271	15.20	35.10
3	4824.00	48.00 AV	54.00	-6.00	1.17 V	271	12.90	35.10
4	7236.00	47.80 PK	74.00	-26.20	1.41 V	73	7.30	40.50
4	7236.00	36.40 AV	54.00	-17.60	1.41 V	73	-4.10	40.50

- REMARKS:**
1. Emission level(dBuV/m)=Raw Value(dBuV) + Correction Factor(dB/m)
 2. Correction Factor(dB/m) = Antenna Factor (dB/m) + Cable Factor (dB)
 3. The other emission levels were very low against the limit.
 4. Margin value = Emission level – Limit value.
 5. The limit value is defined as per 15.247
 6. “ * “ : Fundamental frequency

TEST MODE	Mode 2		
MODE	Channel 6	FREQUENCY RANGE	1000~25000MHz
INPUT POWER (SYSTEM)	120Vac, 60 Hz	DETECTOR FUNCTION & BANDWIDTH	Peak (PK) Average (AV) 1 MHz
ENVIRONMENTAL CONDITIONS	21 deg. C, 59%RH, 972hPa	TESTED BY	Tony Chen

ANTENNA POLARITY & TEST DISTANCE: HORIZONTAL AT 3 M

No.	Freq. (MHz)	Emission Level (dBuV/m)	Limit (dBuV/m)	Margin (dB)	Antenna Height (m)	Table Angle (Degree)	Raw Value (dBuV)	Correction Factor (dB/m)
1	*2437.00	97.30 PK			1.79 H	130	67.30	29.90
1	*2437.00	88.80 AV			1.79 H	130	58.80	29.90
2	4874.00	46.80 PK	74.00	-27.20	1.45 H	125	11.50	35.30
2	4874.00	43.40 AV	54.00	-10.60	1.45 H	125	8.10	35.30
3	7311.00	47.70 PK	74.00	-26.30	1.04 H	21	7.10	40.70
3	7311.00	36.40 AV	54.00	-17.60	1.04 H	21	-4.20	40.70

ANTENNA POLARITY & TEST DISTANCE: VERTICAL AT 3 M

No.	Freq. (MHz)	Emission Level (dBuV/m)	Limit (dBuV/m)	Margin (dB)	Antenna Height (m)	Table Angle (Degree)	Raw Value (dBuV)	Correction Factor (dB/m)
1	*2437.00	107.90 PK			1.44 V	105	78.00	29.90
1	*2437.00	98.10 AV			1.44 V	105	68.20	29.90
2	4874.00	50.60 PK	74.00	-23.40	1.34 V	256	15.30	35.30
2	4874.00	48.10 AV	54.00	-5.90	1.34 V	256	12.80	35.30
3	7311.00	47.30 PK	74.00	-26.70	1.18 V	308	6.60	40.70
3	7311.00	36.50 AV	54.00	-17.50	1.18 V	308	-4.20	40.70

- REMARKS:**
1. Emission level(dBuV/m)=Raw Value(dBuV) + Correction Factor(dB/m)
 2. Correction Factor(dB/m) = Antenna Factor (dB/m) + Cable Factor (dB)
 3. The other emission levels were very low against the limit.
 4. Margin value = Emission level – Limit value.
 5. The limit value is defined as per 15.247
 6. " * " : Fundamental frequency



TEST MODE	Mode 2		
MODE	Channel 11	FREQUENCY RANGE	1000~25000MHz
INPUT POWER (SYSTEM)	120Vac, 60 Hz	DETECTOR FUNCTION & BANDWIDTH	Peak (PK) Average (AV) 1 MHz
ENVIRONMENTAL CONDITIONS	21 deg. C, 59%RH, 972hPa	TESTED BY	Tony Chen

ANTENNA POLARITY & TEST DISTANCE: HORIZONTAL AT 3 M

No.	Freq. (MHz)	Emission Level (dBuV/m)	Limit (dBuV/m)	Margin (dB)	Antenna Height (m)	Table Angle (Degree)	Raw Value (dBuV)	Correction Factor (dB/m)
1	*2462.00	96.20 PK			1.68 H	129	66.20	30.00
1	*2462.00	87.50 AV			1.68 H	129	57.40	30.00
2	2483.50	61.60 PK	74.00	-12.40	1.68 H	129	31.50	30.10
2	2483.50	40.20 AV	54.00	-13.80	1.68 H	129	10.10	30.10
3	4924.00	47.90 PK	74.00	-26.10	1.44 H	60	12.40	35.50
3	4924.00	43.70 AV	54.00	-10.30	1.44 H	60	8.20	35.50
4	7386.00	48.60 PK	74.00	-25.40	1.36 H	12	7.80	40.80
4	7386.00	37.20 AV	54.00	-16.80	1.36 H	12	-3.60	40.80

ANTENNA POLARITY & TEST DISTANCE: VERTICAL AT 3 M

No.	Freq. (MHz)	Emission Level (dBuV/m)	Limit (dBuV/m)	Margin (dB)	Antenna Height (m)	Table Angle (Degree)	Raw Value (dBuV)	Correction Factor (dB/m)
1	*2462.00	107.20 PK			1.41 V	106	77.20	30.00
1	*2462.00	97.80 AV			1.41 V	106	67.80	30.00
2	2483.50	72.70 PK	74.00	-1.30	1.41 V	106	42.50	30.10
2	2483.50	50.60 AV	54.00	-3.40	1.41 V	106	20.50	30.10
3	4924.00	48.80 PK	74.00	-25.20	1.51 V	248	13.30	35.50
3	4924.00	46.20 AV	54.00	-7.80	1.51 V	248	10.70	35.50
4	7386.00	48.10 PK	74.00	-25.90	1.21 V	59	7.20	40.80
4	7386.00	37.30 AV	54.00	-16.70	1.21 V	59	-3.50	40.80

- REMARKS:**
1. Emission level(dBuV/m)=Raw Value(dBuV) + Correction Factor(dB/m)
 2. Correction Factor(dB/m) = Antenna Factor (dB/m) + Cable Factor (dB)
 3. The other emission levels were very low against the limit.
 4. Margin value = Emission level – Limit value.
 5. The limit value is defined as per 15.247
 6. “ * “ : Fundamental frequency



4.2.11 TEST RESULTS –DSSS (MODE 3)

802.11b DSSS modulation

TEST MODE	Mode 3		
MODE	Channel 1	FREQUENCY RANGE	1000~25000MHz
INPUT POWER (SYSTEM)	120Vac, 60 Hz	DETECTOR FUNCTION & BANDWIDTH	Peak (PK) Average (AV) 1 MHz
ENVIRONMENTAL CONDITIONS	21 deg. C, 59%RH, 972hPa	TESTED BY	Tony Chen

ANTENNA POLARITY & TEST DISTANCE: HORIZONTAL AT 3 M								
No.	Freq. (MHz)	Emission Level (dBuV/m)	Limit (dBuV/m)	Margin (dB)	Antenna Height (m)	Table Angle (Degree)	Raw Value (dBuV)	Correction Factor (dB/m)
1	2390.00	48.60 PK	74.00	-25.40	1.13 H	77	14.90	33.70
1	2390.00	39.80 AV	54.00	-14.20	1.13 H	77	6.10	33.70
2	*2412.00	103.00 PK			1.13 H	77	73.20	29.80
2	*2412.00	96.30 AV			1.13 H	77	66.50	29.80
3	4824.00	52.20 PK	74.00	-21.80	1.29 H	356	17.10	35.10
3	4824.00	48.20 AV	54.00	-5.80	1.29 H	356	13.10	35.10
4	7236.00	47.70 PK	74.00	-26.30	1.15 H	35	7.20	40.50
4	7236.00	36.80 AV	54.00	-17.20	1.15 H	35	-3.70	40.50

ANTENNA POLARITY & TEST DISTANCE: VERTICAL AT 3 M								
No.	Freq. (MHz)	Emission Level (dBuV/m)	Limit (dBuV/m)	Margin (dB)	Antenna Height (m)	Table Angle (Degree)	Raw Value (dBuV)	Correction Factor (dB/m)
1	2390.00	57.10 PK	74.00	-16.90	1.06 V	47	23.40	33.70
1	2390.00	48.10 AV	54.00	-5.90	1.06 V	47	14.40	33.70
2	*2412.00	111.50 PK			1.06 V	47	81.70	29.80
2	*2412.00	104.60 AV			1.06 V	47	74.80	29.80
3	4824.00	53.90 PK	74.00	-20.10	1.34 V	253	18.80	35.10
3	4824.00	49.70 AV	54.00	-4.30	1.34 V	253	14.60	35.10
4	7236.00	47.80 PK	74.00	-26.20	1.00 V	360	7.30	40.50
4	7236.00	36.50 AV	54.00	-17.50	1.00 V	360	-4.00	40.50

- REMARKS:**
1. Emission level(dBuV/m)=Raw Value(dBuV) + Correction Factor(dB/m)
 2. Correction Factor(dB/m) = Antenna Factor (dB/m) + Cable Factor (dB)
 3. The other emission levels were very low against the limit.
 4. Margin value = Emission level – Limit value.
 5. The limit value is defined as per 15.247
 6. “ * “ : Fundamental frequency



TEST MODE	Mode 3		
MODE	Channel 6	FREQUENCY RANGE	1000~25000MHz
INPUT POWER (SYSTEM)	120Vac, 60 Hz	DETECTOR FUNCTION & BANDWIDTH	Peak (PK) Average (AV) 1 MHz
ENVIRONMENTAL CONDITIONS	21 deg. C, 59%RH, 972hPa	TESTED BY	Tony Chen

ANTENNA POLARITY & TEST DISTANCE: HORIZONTAL AT 3 M

No.	Freq. (MHz)	Emission Level (dBuV/m)	Limit (dBuV/m)	Margin (dB)	Antenna Height (m)	Table Angle (Degree)	Raw Value (dBuV)	Correction Factor (dB/m)
1	*2437.00	102.00 PK			1.13 H	79	72.10	29.90
1	*2437.00	95.30 AV			1.13 H	79	65.30	29.90
2	4874.00	49.90 PK	74.00	-24.10	1.38 H	3	14.60	35.30
2	4874.00	45.60 AV	54.00	-8.40	1.38 H	3	10.30	35.30
3	7311.00	49.00 PK	74.00	-25.00	1.14 H	344	8.30	40.70
3	7311.00	36.80 AV	54.00	-17.20	1.14 H	344	-3.90	40.70

ANTENNA POLARITY & TEST DISTANCE: VERTICAL AT 3 M

No.	Freq. (MHz)	Emission Level (dBuV/m)	Limit (dBuV/m)	Margin (dB)	Antenna Height (m)	Table Angle (Degree)	Raw Value (dBuV)	Correction Factor (dB/m)
1	*2437.00	112.60 PK			1.23 V	46	82.70	29.90
1	*2437.00	105.60 AV			1.23 V	46	75.70	29.90
2	4874.00	51.20 PK	74.00	-22.80	1.23 V	342	15.90	35.30
2	4874.00	47.10 AV	54.00	-6.90	1.23 V	342	11.80	35.30
3	7311.00	47.90 PK	74.00	-26.10	1.26 V	290	7.20	40.70
3	7311.00	36.80 AV	54.00	-17.20	1.26 V	290	-3.80	40.70

- REMARKS:**
1. Emission level(dBuV/m)=Raw Value(dBuV) + Correction Factor(dB/m)
 2. Correction Factor(dB/m) = Antenna Factor (dB/m) + Cable Factor (dB)
 3. The other emission levels were very low against the limit.
 4. Margin value = Emission level – Limit value.
 5. The limit value is defined as per 15.247
 6. “ * “ : Fundamental frequency



TEST MODE	Mode 3		
MODE	Channel 11	FREQUENCY RANGE	1000~25000MHz
INPUT POWER (SYSTEM)	120Vac, 60 Hz	DETECTOR FUNCTION & BANDWIDTH	Peak (PK) Average (AV) 1 MHz
ENVIRONMENTAL CONDITIONS	21 deg. C, 59%RH, 972hPa	TESTED BY	Tony Chen

ANTENNA POLARITY & TEST DISTANCE: HORIZONTAL AT 3 M

No.	Freq. (MHz)	Emission Level (dBuV/m)	Limit (dBuV/m)	Margin (dB)	Antenna Height (m)	Table Angle (Degree)	Raw Value (dBuV)	Correction Factor (dB/m)
1	*2462.00	103.10 PK			1.12 H	316	73.10	30.00
1	*2462.00	96.00 AV			1.12 H	316	66.00	30.00
2	2483.50	50.50 PK	74.00	-23.50	1.12 H	316	20.40	30.10
2	2483.50	41.60 AV	54.00	-12.40	1.12 H	316	11.50	30.10
3	4924.00	50.80 PK	74.00	-23.20	1.39 H	354	15.30	35.50
3	4924.00	47.20 AV	54.00	-6.80	1.39 H	354	11.70	35.50
4	7386.00	48.40 PK	74.00	-25.60	1.26 H	2	7.60	40.80
4	7386.00	37.20 AV	54.00	-16.80	1.26 H	2	-3.60	40.80

ANTENNA POLARITY & TEST DISTANCE: VERTICAL AT 3 M

No.	Freq. (MHz)	Emission Level (dBuV/m)	Limit (dBuV/m)	Margin (dB)	Antenna Height (m)	Table Angle (Degree)	Raw Value (dBuV)	Correction Factor (dB/m)
1	*2462.00	111.00 PK			1.05 V	47	81.00	30.00
1	*2462.00	104.10 AV			1.05 V	47	74.00	30.00
2	2483.50	58.40 PK	74.00	-15.60	1.05 V	47	28.20	30.10
2	2483.50	49.60 AV	54.00	-4.40	1.05 V	47	19.50	30.10
3	4924.00	50.90 PK	74.00	-23.10	1.21 V	168	15.40	35.50
3	4924.00	48.50 AV	54.00	-5.50	1.21 V	168	12.90	35.50
4	7386.00	48.00 PK	74.00	-26.00	1.04 V	341	7.10	40.80
4	7386.00	37.30 AV	54.00	-16.70	1.04 V	341	-3.60	40.80

- REMARKS:**
1. Emission level(dBuV/m)=Raw Value(dBuV) + Correction Factor(dB/m)
 2. Correction Factor(dB/m) = Antenna Factor (dB/m) + Cable Factor (dB)
 3. The other emission levels were very low against the limit.
 4. Margin value = Emission level – Limit value.
 5. The limit value is defined as per 15.247
 6. “ * “ : Fundamental frequency



4.2.12 TEST RESULTS – OFDM (MODE 3)

802.11g Normal OFDM modulation

TEST MODE	Mode 3		
MODE	Channel 1	FREQUENCY RANGE	1000~25000MHz
INPUT POWER (SYSTEM)	120Vac, 60 Hz	DETECTOR FUNCTION & BANDWIDTH	Peak (PK) Average (AV) 1 MHz
ENVIRONMENTAL CONDITIONS	21 deg. C, 59%RH, 972hPa	TESTED BY	Tony Chen

ANTENNA POLARITY & TEST DISTANCE: HORIZONTAL AT 3 M

No.	Freq. (MHz)	Emission Level (dBuV/m)	Limit (dBuV/m)	Margin (dB)	Antenna Height (m)	Table Angle (Degree)	Raw Value (dBuV)	Correction Factor (dB/m)
1	2390.00	60.10 PK	74.00	-13.90	1.52 H	316	26.40	33.70
1	2390.00	38.70 AV	54.00	-15.30	1.52 H	316	5.00	33.70
2	*2412.00	98.80 PK			1.52 H	316	69.00	29.80
2	*2412.00	89.10 AV			1.52 H	316	59.20	29.80
3	4824.00	49.60 PK	74.00	-24.40	1.06 H	61	14.50	35.10
3	4824.00	47.00 AV	54.00	-7.00	1.06 H	61	11.80	35.10
4	7236.00	47.70 PK	74.00	-26.30	1.35 H	346	7.20	40.50
4	7236.00	36.30 AV	54.00	-17.70	1.35 H	346	-4.20	40.50

ANTENNA POLARITY & TEST DISTANCE: VERTICAL AT 3 M

No.	Freq. (MHz)	Emission Level (dBuV/m)	Limit (dBuV/m)	Margin (dB)	Antenna Height (m)	Table Angle (Degree)	Raw Value (dBuV)	Correction Factor (dB/m)
1	2390.00	69.50 PK	74.00	-4.50	1.42 V	93	35.80	33.70
1	2390.00	51.40 AV	54.00	-2.60	1.42 V	93	17.70	33.70
2	*2412.00	108.30 PK			1.42 V	93	78.50	29.80
2	*2412.00	98.60 AV			1.42 V	93	68.80	29.80
3	4824.00	48.90 PK	74.00	-25.10	1.42 V	292	13.80	35.10
3	4824.00	48.50 AV	54.00	-5.50	1.42 V	292	13.40	35.10
4	7236.00	47.50 PK	74.00	-26.50	1.31 V	309	7.00	40.50
4	7236.00	36.40 AV	54.00	-17.60	1.31 V	309	-4.10	40.50

- REMARKS:**
1. Emission level(dBuV/m)=Raw Value(dBuV) + Correction Factor(dB/m)
 2. Correction Factor(dB/m) = Antenna Factor (dB/m) + Cable Factor (dB)
 3. The other emission levels were very low against the limit.
 4. Margin value = Emission level – Limit value.
 5. The limit value is defined as per 15.247
 6. “ * “ : Fundamental frequency



TEST MODE	Mode 3		
MODE	Channel 6	FREQUENCY RANGE	1000~25000MHz
INPUT POWER (SYSTEM)	120Vac, 60 Hz	DETECTOR FUNCTION & BANDWIDTH	Peak (PK) Average (AV) 1 MHz
ENVIRONMENTAL CONDITIONS	21 deg. C, 59%RH, 972hPa	TESTED BY	Tony Chen

ANTENNA POLARITY & TEST DISTANCE: HORIZONTAL AT 3 M

No.	Freq. (MHz)	Emission Level (dBuV/m)	Limit (dBuV/m)	Margin (dB)	Antenna Height (m)	Table Angle (Degree)	Raw Value (dBuV)	Correction Factor (dB/m)
1	*2437.00	97.90 PK			1.11 H	326	68.00	29.90
1	*2437.00	88.50 AV			1.11 H	326	58.60	29.90
2	4874.00	48.30 PK	74.00	-25.70	1.20 H	356	13.00	35.30
2	4874.00	45.40 AV	54.00	-8.60	1.20 H	356	10.10	35.30
3	7311.00	47.70 PK	74.00	-26.30	1.12 H	124	7.10	40.70
3	7311.00	36.50 AV	54.00	-17.50	1.12 H	124	-4.20	40.70

ANTENNA POLARITY & TEST DISTANCE: VERTICAL AT 3 M

No.	Freq. (MHz)	Emission Level (dBuV/m)	Limit (dBuV/m)	Margin (dB)	Antenna Height (m)	Table Angle (Degree)	Raw Value (dBuV)	Correction Factor (dB/m)
1	*2437.00	108.60 PK			1.29 V	49	78.70	29.90
1	*2437.00	98.70 AV			1.29 V	49	68.80	29.90
2	4874.00	50.00 PK	74.00	-24.00	1.50 V	253	14.70	35.30
2	4874.00	47.40 AV	54.00	-6.60	1.50 V	253	12.10	35.30
3	7311.00	48.20 PK	74.00	-25.80	1.11 V	1	7.60	40.70
3	7311.00	36.50 AV	54.00	-17.50	1.11 V	1	-4.10	40.70

- REMARKS:**
1. Emission level(dBuV/m)=Raw Value(dBuV) + Correction Factor(dB/m)
 2. Correction Factor(dB/m) = Antenna Factor (dB/m) + Cable Factor (dB)
 3. The other emission levels were very low against the limit.
 4. Margin value = Emission level – Limit value.
 5. The limit value is defined as per 15.247
 6. " * " : Fundamental frequency



TEST MODE	Mode 3		
MODE	Channel 11	FREQUENCY RANGE	1000~25000MHz
INPUT POWER (SYSTEM)	120Vac, 60 Hz	DETECTOR FUNCTION & BANDWIDTH	Peak (PK) Average (AV) 1 MHz
ENVIRONMENTAL CONDITIONS	21 deg. C, 59%RH, 972hPa	TESTED BY	Tony Chen

ANTENNA POLARITY & TEST DISTANCE: HORIZONTAL AT 3 M

No.	Freq. (MHz)	Emission Level (dBuV/m)	Limit (dBuV/m)	Margin (dB)	Antenna Height (m)	Table Angle (Degree)	Raw Value (dBuV)	Correction Factor (dB/m)
1	*2462.00	100.20 PK			1.12 H	317	70.20	30.00
1	*2462.00	90.50 AV			1.12 H	317	60.50	30.00
2	2483.50	65.60 PK	74.00	-8.40	1.12 H	317	35.50	30.10
2	2483.50	43.30 AV	54.00	-10.70	1.12 H	317	13.20	30.10
3	4924.00	49.80 PK	74.00	-24.20	1.59 H	230	14.30	35.50
3	4924.00	45.50 AV	54.00	-8.50	1.59 H	230	9.90	35.50
4	7386.00	49.00 PK	74.00	-25.00	1.08 H	294	8.20	40.80
4	7386.00	37.10 AV	54.00	-16.90	1.08 H	294	-3.80	40.80

ANTENNA POLARITY & TEST DISTANCE: VERTICAL AT 3 M

No.	Freq. (MHz)	Emission Level (dBuV/m)	Limit (dBuV/m)	Margin (dB)	Antenna Height (m)	Table Angle (Degree)	Raw Value (dBuV)	Correction Factor (dB/m)
1	*2462.00	108.00 PK			1.04 V	45	78.00	30.00
1	*2462.00	97.90 AV			1.04 V	45	67.90	30.00
2	2483.50	73.50 PK	74.00	-0.50	1.04 V	45	43.30	30.10
2	2483.50	50.70 AV	54.00	-3.30	1.04 V	45	20.60	30.10
3	4924.00	51.20 PK	74.00	-22.80	1.18 V	255	15.70	35.50
3	4924.00	48.30 AV	54.00	-5.70	1.18 V	255	12.80	35.50
4	7386.00	48.10 PK	74.00	-25.90	1.07 V	269	7.30	40.80
4	7386.00	37.00 AV	54.00	-17.00	1.07 V	269	-3.80	40.80

- REMARKS:**
1. Emission level(dBuV/m)=Raw Value(dBuV) + Correction Factor(dB/m)
 2. Correction Factor(dB/m) = Antenna Factor (dB/m) + Cable Factor (dB)
 3. The other emission levels were very low against the limit.
 4. Margin value = Emission level – Limit value.
 5. The limit value is defined as per 15.247
 6. “ * “ : Fundamental frequency



4.3 6dB BANDWIDTH MEASUREMENT

4.3.1 LIMITS OF 6dB BANDWIDTH MEASUREMENT

The minimum of 6dB Bandwidth Measurement is 0.5 MHz.

4.3.2 TEST INSTRUMENTS

Description & Manufacturer	Model No.	Serial No.	Calibrated Until
R&S SPECTRUM ANALYZER	FSP40	100036	Nov. 23, 2006

NOTE:

- 1.The measurement uncertainty is less than +/- 2.6dB, which is calculated as per the NAMAS document NIS81.
- 2.The calibration interval of the above test instruments is 12 months and the calibrations are traceable to NML/ROC and NIST/USA.

4.3.3 TEST PROCEDURE

The transmitter output was connected to the spectrum analyzer through an attenuator. The bandwidth of the fundamental frequency was measured by spectrum analyzer with 100 kHz RBW and 100 kHz VBW. The 6 dB bandwidth is defined as the total spectrum the power of which is higher than peak power minus 6 dB.

4.3.4 TEST SETUP



For the actual test configuration, please refer to the related Item – Photographs of the Test Configuration.

4.3.5 EUT OPERATING CONDITIONS

The software provided by client to enable the EUT under transmission condition continuously at lowest, middle and highest channel frequencies individually.



4.3.6 TEST RESULTS –DSSS

802.11b DSSS modulation

MODULATION TYPE	CCK	TRANSFER RATE	11Mbps
INPUT POWER (SYSTEM)	120Vac, 60 Hz	ENVIRONMENTAL CONDITIONS	20deg. C, 60%RH, 972hPa
TESTED BY	Tony Chen		

CHANNEL	CHANNEL FREQUENCY (MHz)	6 dB BANDWIDTH (MHz)	MINIMUM LIMIT (MHz)	PASS/FAIL
1	2412	11.2	0.5	PASS
6	2437	11.9	0.5	PASS
11	2462	11.83	0.5	PASS

CH1

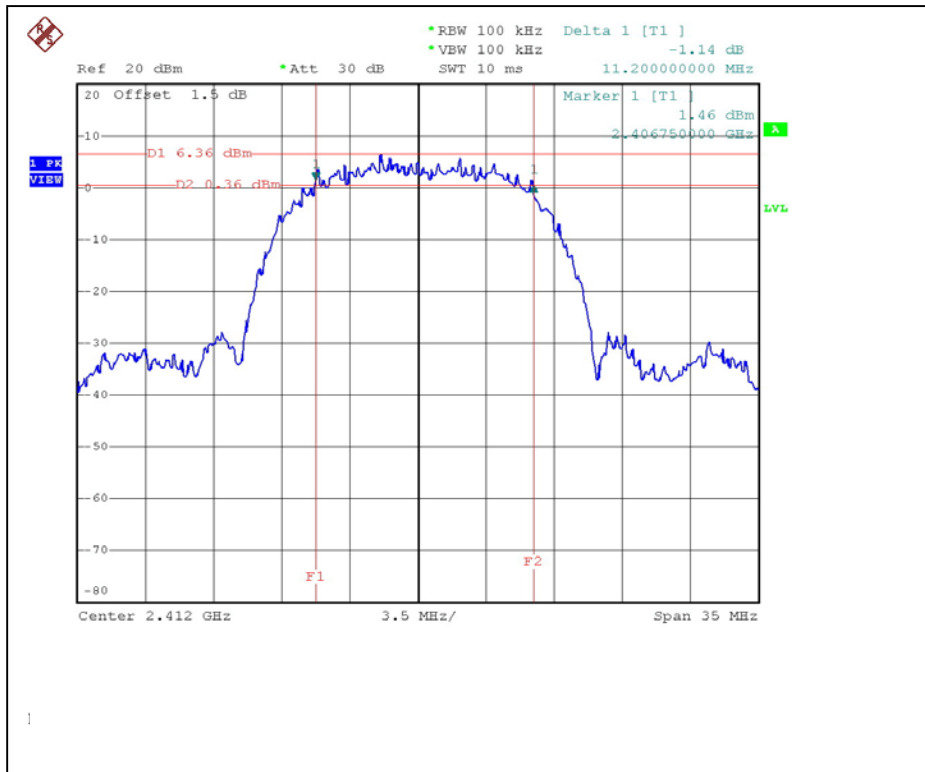

CH6

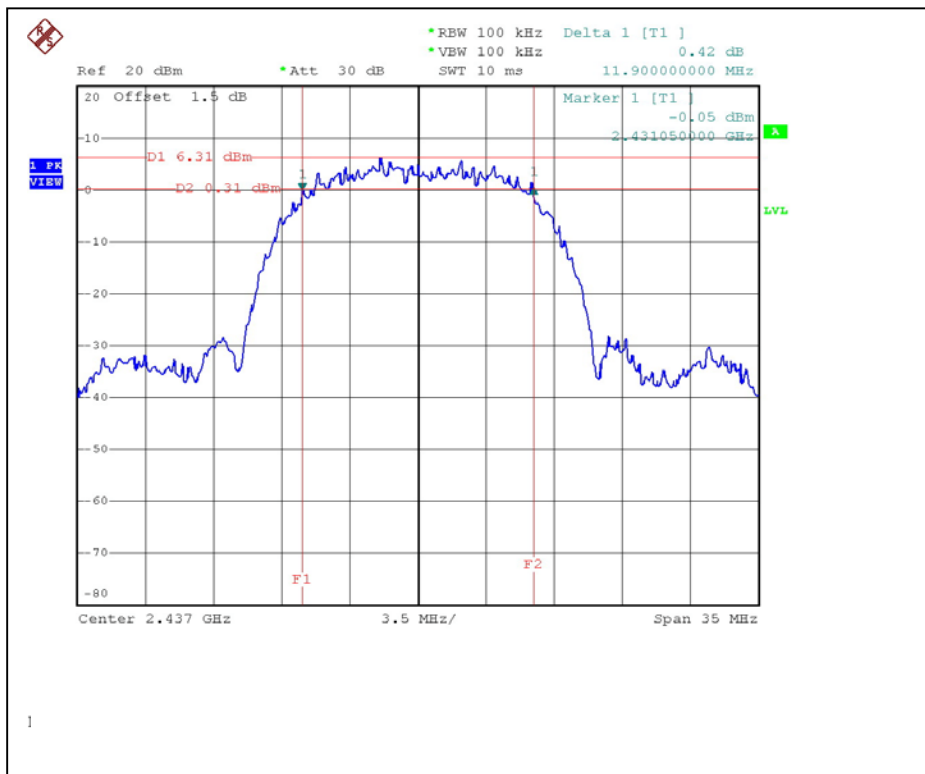

CH11

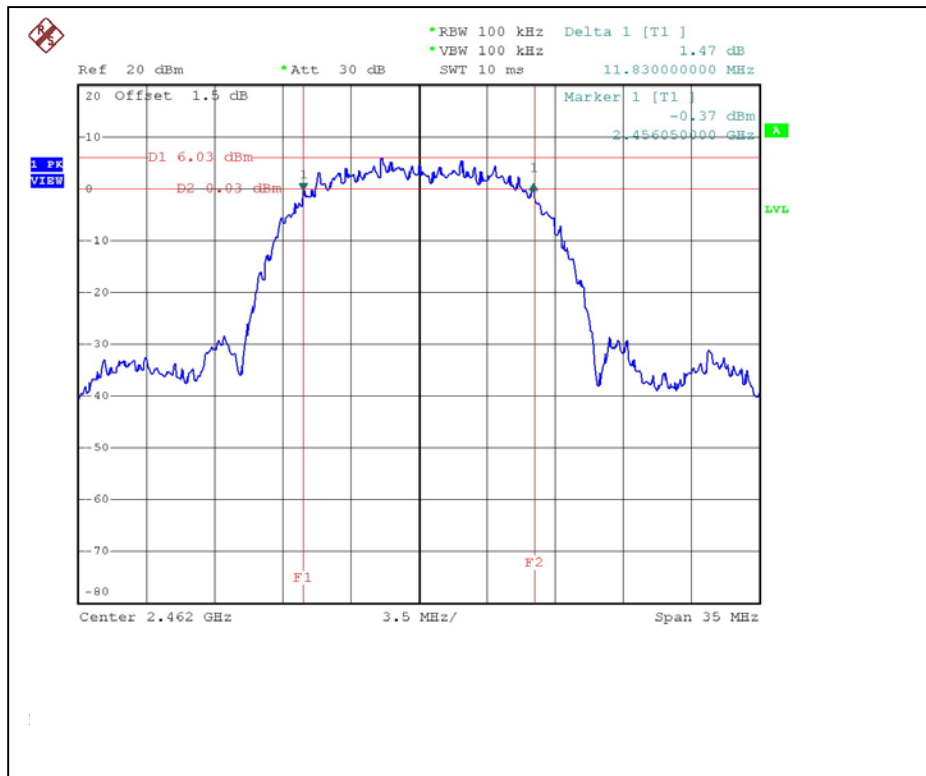



4.3.7 TEST RESULTS-OFDM

802.11g OFDM modulation

MODULATION TYPE	BPSK	TRANSFER RATE	6Mbps
INPUT POWER (SYSTEM)	120Vac, 60 Hz	ENVIRONMENTAL CONDITIONS	20deg. C, 60%RH, 972hPa
TESTED BY	Wen Yu		

CHANNEL	CHANNEL FREQUENCY (MHz)	6 dB BANDWIDTH (MHz)	MINIMUM LIMIT (MHz)	PASS/FAIL
1	2412	16.38	0.5	PASS
6	2437	16.31	0.5	PASS
11	2462	16.38	0.5	PASS

CH1

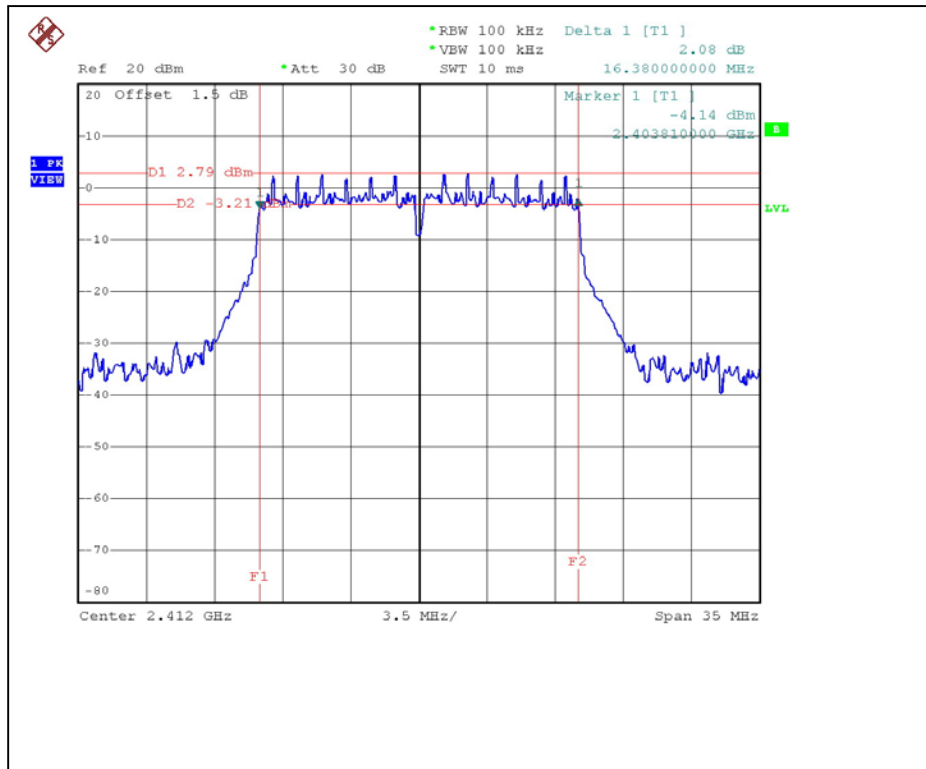

CH6

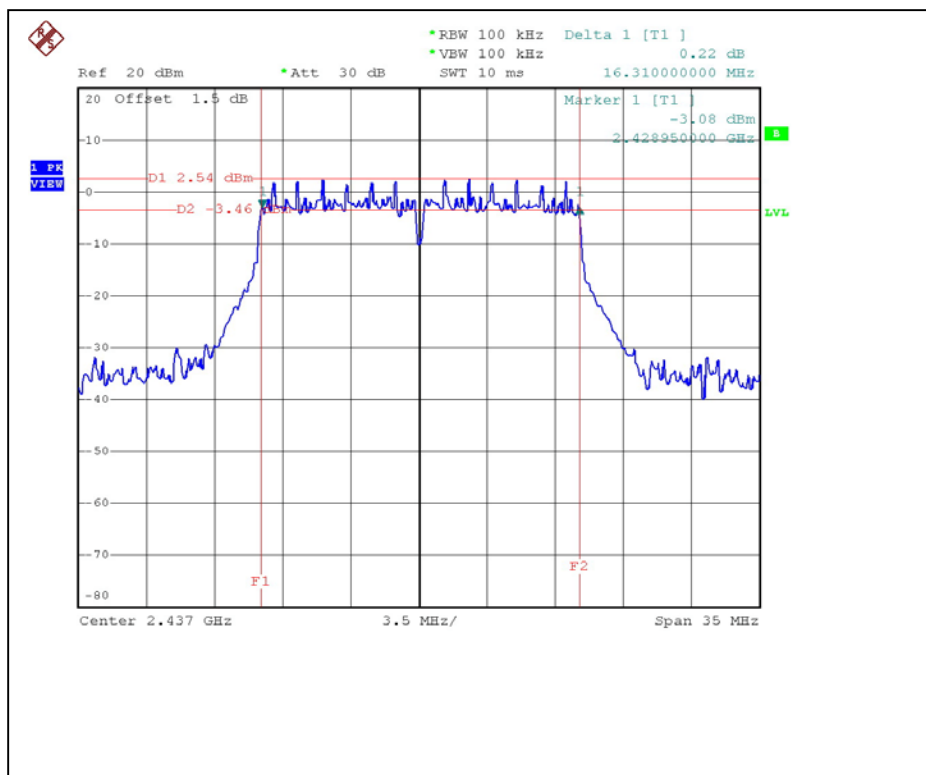

CH11

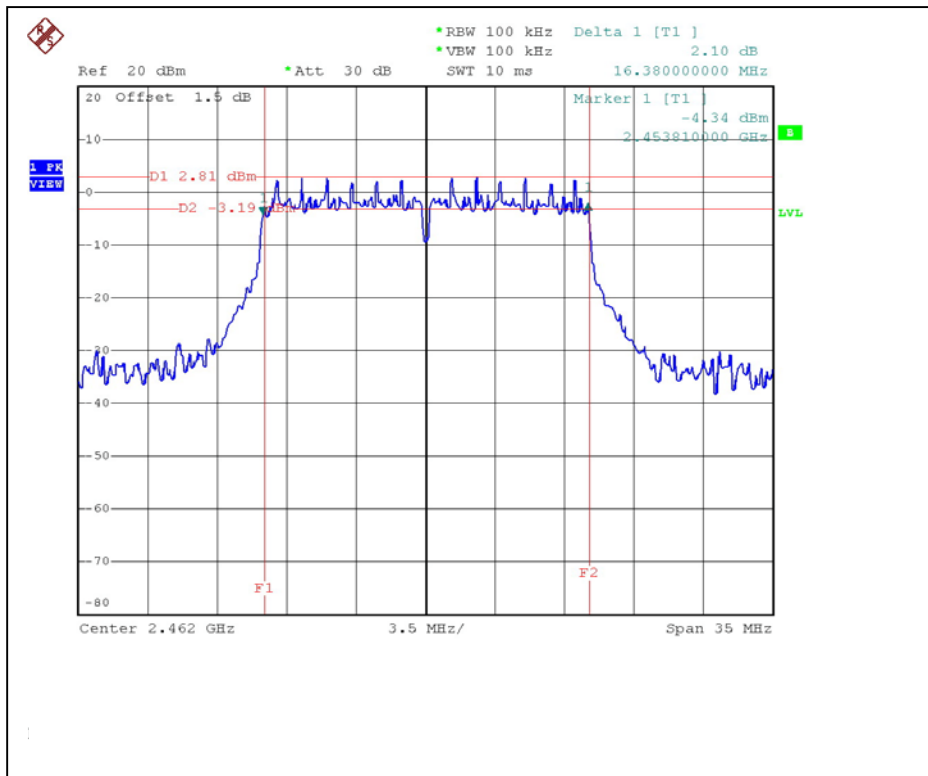



4.4 MAXIMUM PEAK OUTPUT POWER

4.4.1 LIMITS OF MAXIMUM PEAK OUTPUT POWER MEASUREMENT

The Maximum Peak Output Power Measurement is 30dBm.

4.4.2 TEST INSTRUMENTS

Description & Manufacturer	Model No.	Serial No.	Calibrated Until
R&S SPECTRUM ANALYZER	FSP40	100036	Nov. 23, 2006
Agilent SIGNAL GENERATOR	E8257C	MY43320668	Dec. 07, 2006
TEKTRONIX OSCILLOSCOPE	TDS380	B016335	Jun. 22, 2006
NARDA DETECTOR	4503A	FSCM99899	NA

NOTE:

The calibration interval of the above test instruments is 12 months and the calibrations are traceable to NML/ROC and NIST/USA.

4.4.3 TEST PROCEDURES

1. A detector was used on the output port of the EUT. An oscilloscope was used to read the peak response of the detector.
2. Replaced the EUT by the signal generator. The center frequency of the S.G was adjusted to the center frequency of the measured channel.
3. Adjusted the power to have the same peak reading on oscilloscope. Record the power level.

4.4.4 TEST SETUP

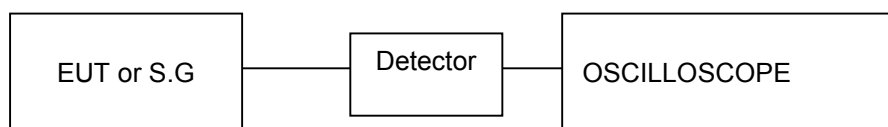

4.4.5 EUT OPERATING CONDITIONS

Same as Item 4.3.5



4.4.6 TEST RESULTS – DSSS

802.11b DSSS modulation

MODULATION TYPE	CCK	TRANSFER RATE	11Mbps
INPUT POWER (SYSTEM)	120Vac, 60Hz	ENVIRONMENTAL CONDITIONS	20deg. C, 60%RH, 972hPa
TESTED BY	Tony Chen		

CHANNEL	CHANNEL FREQUENCY (MHz)	PEAK POWER OUTPUT (mW)	PEAK POWER OUTPUT (dBm)	PEAK POWER LIMIT (dBm)	PASS/FAIL
1	2412	63.241	18.01	30	PASS
6	2437	64.863	18.12	30	PASS
11	2462	64.565	18.10	30	PASS



4.4.7 TEST RESULTS –OFDM

802.11g OFDM modulation

MODULATION TYPE	BPSK	TRANSFER RATE	6Mbps
INPUT POWER (SYSTEM)	120Vac, 60Hz	ENVIRONMENTAL CONDITIONS	20deg. C, 60%RH, 972hPa
TESTED BY	Tony Chen		

CHANNEL	CHANNEL FREQUENCY (MHz)	PEAK POWER OUTPUT (mW)	PEAK POWER OUTPUT (dBm)	PEAK POWER LIMIT (dBm)	PASS/FAIL
1	2412	64.863	18.12	30	PASS
6	2437	66.681	18.24	30	PASS
11	2462	67.608	18.30	30	PASS



4.5 POWER SPECTRAL DENSITY MEASUREMENT

4.5.1 LIMITS OF POWER SPECTRAL DENSITY MEASUREMENT

The Maximum of Power Spectral Density Measurement is 8dBm.

4.5.2 TEST INSTRUMENTS

Description & Manufacturer	Model No.	Serial No.	Calibrated Until
R&S SPECTRUM ANALYZER	FSP40	100036	Nov. 23, 2006

NOTE:

- 1.The measurement uncertainty is less than +/- 2.6dB, which is calculated as per the NAMAS document NIS81.
- 2.The calibration interval of the above test instruments is 12 months and the calibrations are traceable to NML/ROC and NIST/USA.

4.5.3 TEST PROCEDURE

The transmitter output was connected to the spectrum analyzer through an attenuator, the bandwidth of the fundamental frequency was measured with the spectrum analyzer using 3 kHz RBW and 30 kHz VBW, set sweep time=span/3kHz. The power spectral density was measured and recorded. The sweep time is allowed to be longer than span/3KHz for a full response of the mixer in the spectrum analyzer.

4.5.4 TEST SETUP

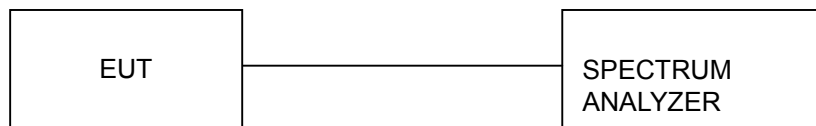

4.5.5 EUT OPERATING CONDITIONS

Same as 4.3.5



4.5.6 TEST RESULTS –DSSS

802.11b DSSS modulation

MODULATION TYPE	CCK	TRANSFER RATE	11Mbps
INPUT POWER (SYSTEM)	120Vac, 60Hz	ENVIRONMENTAL CONDITIONS	20deg. C, 60%RH, 972hPa
TESTED BY	Tony Chen		

CHANNEL NUMBER	CHANNEL FREQUENCY (MHz)	RF POWER LEVEL IN 3 KHz BW (dBm)	MAXIMUM LIMIT (dBm)	PASS/FAIL
1	2412	-6.63	8	PASS
6	2437	-6.84	8	PASS
11	2462	-7.03	8	PASS

CH1

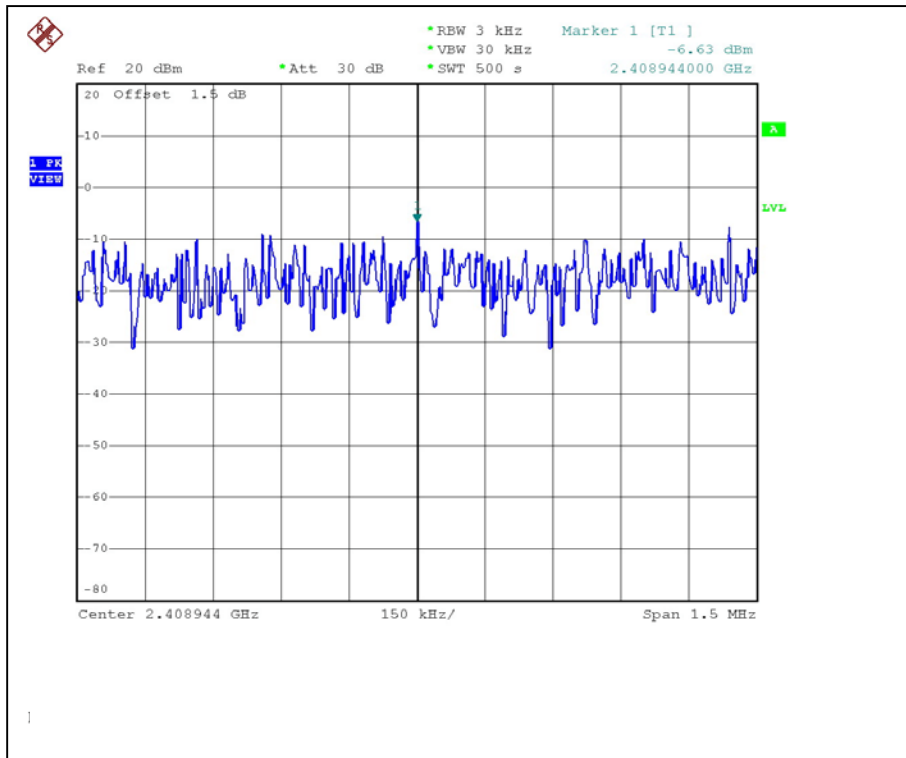

CH6

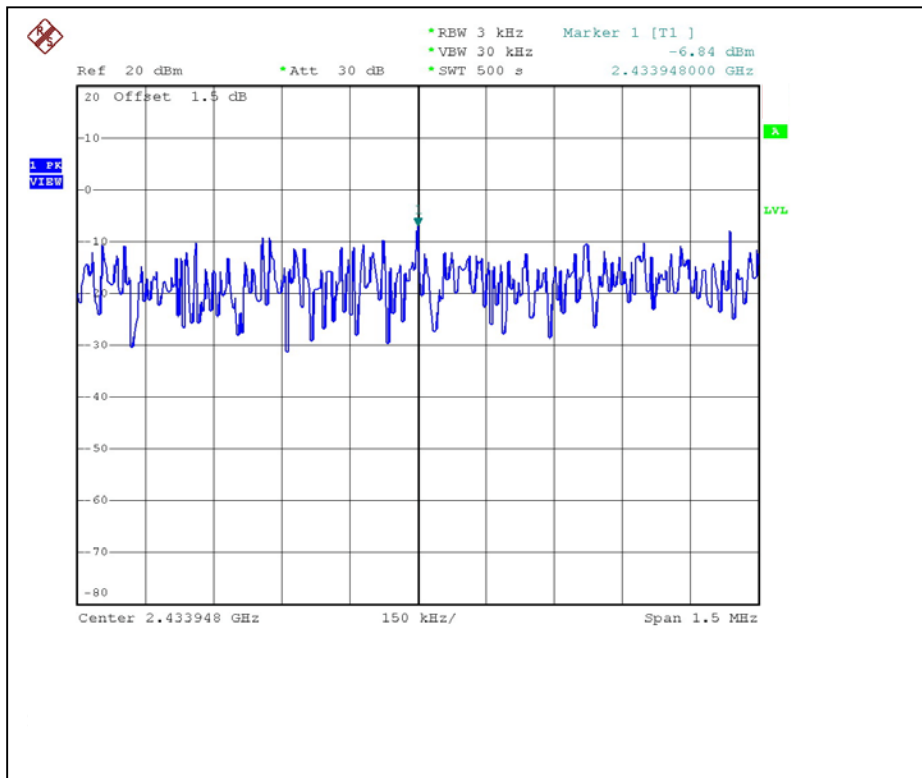

CH11

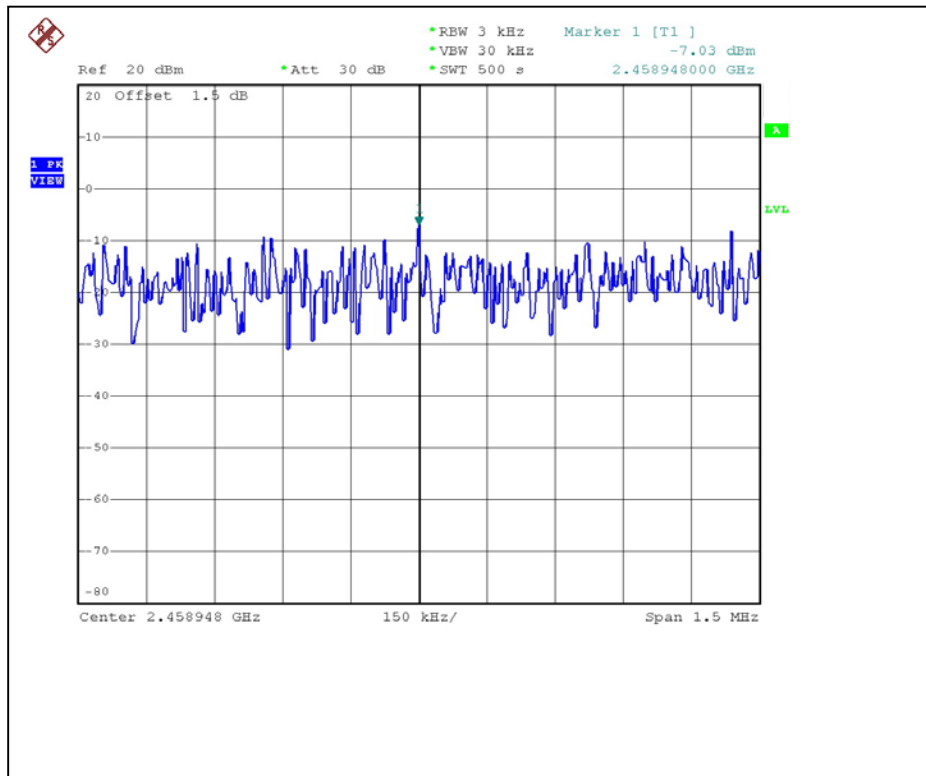



4.5.7 TEST RESULTS –OFDM

802.11g OFDM modulation

MODULATION TYPE	BPSK	TRANSFER RATE	6Mbps
INPUT POWER (SYSTEM)	120Vac, 60Hz	ENVIRONMENTAL CONDITIONS	20deg. C, 60%RH, 972hPa
TESTED BY	Tony Chen		

CHANNEL NUMBER	CHANNEL FREQUENCY (MHz)	RF POWER LEVEL IN 3 KHz BW (dBm)	MAXIMUM LIMIT (dBm)	PASS/FAIL
1	2412	-10.53	8	PASS
6	2437	-10.65	8	PASS
11	2462	-10.40	8	PASS

CH11

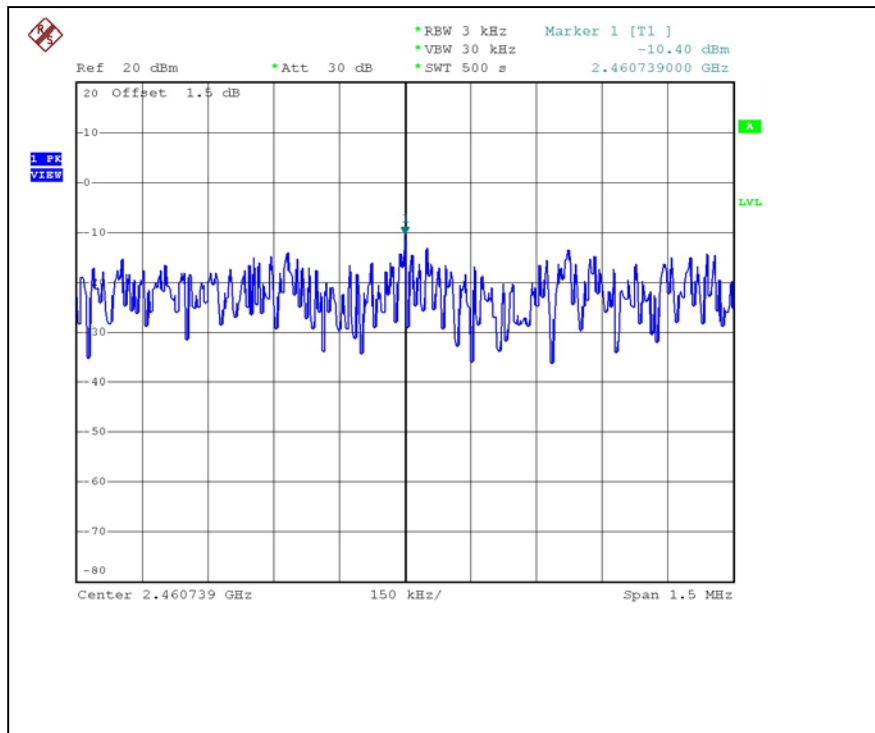

4.6 BAND EDGES MEASUREMENT

4.6.1 LIMITS OF BAND EDGES MEASUREMENT

Below -20dB of the highest emission level of operating band (in 1MHz Resolution Bandwidth).

4.6.2 TEST INSTRUMENTS

Description & Manufacturer	Model No.	Serial No.	Calibrated Until
R&S SPECTRUM ANALYZER	FSP40	100036	Nov. 23, 2006

NOTE:

- 1.The measurement uncertainty is less than $\pm 2.6\text{dB}$, which is calculated as per the NAMAS document NIS81.
- 2.The calibration interval of the above test instruments is 12 months and the calibrations are traceable to NML/ROC and NIST/USA.

4.6.3 TEST PROCEDURE

The transmitter output was connected to the spectrum analyzer via a low lose cable. Set RBW spectrum analyzer to 1 MHz and set VBW spectrum analyzer to 10 Hz with suitable frequency span including 1 MHz bandwidth from band edge. The band edges was measured and recorded.

The spectrum plots (Peak RBW=VBW=1MHz ; Average RBW=1MHz, VBW=10Hz) are attached on the following pages.

4.6.4 EUT OPERATING CONDITION

Same as Item 4.3.5

4.6.5 TEST RESULTS – DSSS (MODE 1)

The spectrum plots are attached on the following page. D1 line indicates the highest level, D2 line indicates the 20dB offset below D1. It shows compliance with the requirement in part 15.247(C).

Note - The delta method is only used up to 2 MHz away from the restricted bandage, The radiated emissions which located in other restricted frequency band, the result, please refer to 4.2.

NOTE (Peak):

The band edge emission plot of DSSS technique on the following page 68 show 54.38dB delta between carrier maximum power and local maximum emission in restrict band (2.3900GHz). The emission of carrier strength list in the test result of channel 1 at the item 4.2 is 111.4dBuV/m, so the maximum field strength in restrict band is $111.4-54.38=57.02$ dBuV/m which is under 74 dBuV/m limit.

The band edge emission plot of DSSS technique on the following page 68 shows 52.61dB delta between carrier maximum power and local maximum emission in restrict band (2.4835GHz). The emission of carrier strength list in the test result of channel 11 at the item 4.2 is 110.3dBuV/m, so the maximum field strength in restrict band is $110.3-52.61=57.69$ dBuV/m which is under 74 dBuV/m limit.

NOTE (Average):

The band edge emission plot of DSSS technique on the following page 69 shows 56.5dB delta between carrier maximum power and local maximum emission in restrict band (2.3900GHz). The emission of carrier strength list in the test result of channel 1 at the item 4.2 is 104.5dBuV/m, so the maximum field strength in restrict band is $104.5-56.5=48.00$ dBuV/m which is under 54 dBuV/m limit.

The band edge emission plot of DSSS technique on the following page 69 shows 54.42dB delta between carrier maximum power and local maximum emission in restrict band (2.4835GHz). The emission of carrier strength list in the test result of channel 11 at the item 4.2 is 104.0dBuV/m, so the maximum field strength in restrict band is $104.0-54.42=49.58$ dBuV/m which is under 54 dBuV/m limit.

4.6.6 TEST RESULTS -OFDM (MODE 1)

The spectrum plots are attached on the following page. D1 line indicates the highest level, D2 line indicates the 20dB offset below D1. It shows compliance with the requirement in part 15.247(C).

Note - The delta method is only used up to 2 MHz away from the restricted bandage, The radiated emissions which located in other restricted frequency band, the result, please refer to 4.2.

NOTE (Peak):

The band edge emission plot of OFDM technique on the following page 71 show 38.75dB delta between carrier maximum power and local maximum emission in restrict band (2.3900GHz). The emission of carrier strength list in the test result of channel 1 at the item 4.2 is 108.6dBuV/m, so the maximum field strength in restrict band is $108.6-38.75=69.85$ dBuV/m which is under 74 dBuV/m limit.

The band edge emission plot of OFDM technique on the following page 71 shows 34.55dB delta between carrier maximum power and local maximum emission in restrict band (2.4835GHz). The emission of carrier strength list in the test result of channel 11 at the item 4.2 is 108.3dBuV/m, so the maximum field strength in restrict band is $108.3-34.55=73.75$ dBuV/m which is under 74 dBuV/m limit.

NOTE (Average):

The band edge emission plot of OFDM technique on the following page 72 shows 50.33dB delta between carrier maximum power and local maximum emission in restrict band (2.3900GHz). The emission of carrier strength list in the test result of channel 1 at the item 4.2 is 99.2dBuV/m, so the maximum field strength in restrict band is $99.2-50.33=48.87$ dBuV/m which is under 54 dBuV/m limit.

The band edge emission plot of OFDM technique on the following page 72 shows 47.2dB delta between carrier maximum power and local maximum emission in restrict band (2.4835GHz). The emission of carrier strength list in the test result of channel 11 at the item 4.2 is 99.2dBuV/m, so the maximum field strength in restrict band is $99.2-47.2=52.0$ dBuV/m which is under 54 dBuV/m limit.

4.6.7 TEST RESULTS – DSSS (MODE 2)

The spectrum plots are attached on the following page. D1 line indicates the highest level, D2 line indicates the 20dB offset below D1. It shows compliance with the requirement in part 15.247(C).

Note - The delta method is only used up to 2 MHz away from the restricted bandage, The radiated emissions which located in other restricted frequency band, the result, please refer to 4.2.

NOTE (Peak):

The band edge emission plot of DSSS technique on the following page 68 show 54.38dB delta between carrier maximum power and local maximum emission in restrict band (2.3900GHz). The emission of carrier strength list in the test result of channel 1 at the item 4.2 is 109.1dBuV/m, so the maximum field strength in restrict band is $109.1-54.38=54.72$ dBuV/m which is under 74 dBuV/m limit.

The band edge emission plot of DSSS technique on the following page 68 shows 52.61dB delta between carrier maximum power and local maximum emission in restrict band (2.4835GHz). The emission of carrier strength list in the test result of channel 11 at the item 4.2 is 110.5dBuV/m, so the maximum field strength in restrict band is $110.5-52.61=57.89$ dBuV/m which is under 74 dBuV/m limit.

NOTE (Average):

The band edge emission plot of DSSS technique on the following page 69 shows 56.5dB delta between carrier maximum power and local maximum emission in restrict band (2.3900GHz). The emission of carrier strength list in the test result of channel 1 at the item 4.2 is 102.1dBuV/m, so the maximum field strength in restrict band is $102.1-56.5=45.6$ dBuV/m which is under 54 dBuV/m limit.

The band edge emission plot of DSSS technique on the following page 69 shows 54.42dB delta between carrier maximum power and local maximum emission in restrict band (2.4835GHz). The emission of carrier strength list in the test result of channel 11 at the item 4.2 is 103.8dBuV/m, so the maximum field strength in restrict band is $103.8-54.42=49.38$ dBuV/m which is under 54 dBuV/m limit.

4.6.8 TEST RESULTS -OFDM (MODE 2)

The spectrum plots are attached on the following page. D1 line indicates the highest level, D2 line indicates the 20dB offset below D1. It shows compliance with the requirement in part 15.247(C).

Note - The delta method is only used up to 2 MHz away from the restricted bandage, The radiated emissions which located in other restricted frequency band, the result, please refer to 4.2.

NOTE (Peak):

The band edge emission plot of OFDM technique on the following page 71 show 38.75dB delta between carrier maximum power and local maximum emission in restrict band (2.3900GHz). The emission of carrier strength list in the test result of channel 1 at the item 4.2 is 108.5dBuV/m, so the maximum field strength in restrict band is $108.5-38.75=69.75$ dBuV/m which is under 74 dBuV/m limit.

The band edge emission plot of OFDM technique on the following page 71 shows 34.55dB delta between carrier maximum power and local maximum emission in restrict band (2.4835GHz). The emission of carrier strength list in the test result of channel 11 at the item 4.2 is 107.2dBuV/m, so the maximum field strength in restrict band is $107.2-34.55=72.65$ dBuV/m which is under 74 dBuV/m limit.

NOTE (Average):

The band edge emission plot of OFDM technique on the following page 72 shows 50.33dB delta between carrier maximum power and local maximum emission in restrict band (2.3900GHz). The emission of carrier strength list in the test result of channel 1 at the item 4.2 is 98.7dBuV/m, so the maximum field strength in restrict band is $98.7-50.33=48.37$ dBuV/m which is under 54 dBuV/m limit.

The band edge emission plot of OFDM technique on the following page 72 shows 47.2dB delta between carrier maximum power and local maximum emission in restrict band (2.4835GHz). The emission of carrier strength list in the test result of channel 11 at the item 4.2 is 97.8dBuV/m, so the maximum field strength in restrict band is $97.8-47.2=50.6$ dBuV/m which is under 54 dBuV/m limit.

4.6.9 TEST RESULTS – DSSS (MODE 3)

The spectrum plots are attached on the following page. D1 line indicates the highest level, D2 line indicates the 20dB offset below D1. It shows compliance with the requirement in part 15.247(C).

Note - The delta method is only used up to 2 MHz away from the restricted bandage, The radiated emissions which located in other restricted frequency band, the result, please refer to 4.2.

NOTE (Peak):

The band edge emission plot of DSSS technique on the following page 68 show 54.38dB delta between carrier maximum power and local maximum emission in restrict band (2.3900GHz). The emission of carrier strength list in the test result of channel 1 at the item 4.2 is 111.5dBuV/m, so the maximum field strength in restrict band is $111.5-54.38=57.12$ dBuV/m which is under 74 dBuV/m limit.

The band edge emission plot of DSSS technique on the following page 68 shows 52.61dB delta between carrier maximum power and local maximum emission in restrict band (2.4835GHz). The emission of carrier strength list in the test result of channel 11 at the item 4.2 is 111.0dBuV/m, so the maximum field strength in restrict band is $111.0-52.61=58.39$ dBuV/m which is under 74 dBuV/m limit.

NOTE (Average):

The band edge emission plot of DSSS technique on the following page 69 shows 56.5dB delta between carrier maximum power and local maximum emission in restrict band (2.3900GHz). The emission of carrier strength list in the test result of channel 1 at the item 4.2 is 104.6dBuV/m, so the maximum field strength in restrict band is $104.6-56.5=48.1$ dBuV/m which is under 54 dBuV/m limit.

The band edge emission plot of DSSS technique on the following page 69 shows 54.42dB delta between carrier maximum power and local maximum emission in restrict band (2.4835GHz). The emission of carrier strength list in the test result of channel 11 at the item 4.2 is 104.1dBuV/m, so the maximum field strength in restrict band is $104.1-54.42=49.68$ dBuV/m which is under 54 dBuV/m limit.

4.6.10 TEST RESULTS -OFDM (MODE 3)

The spectrum plots are attached on the following page. D1 line indicates the highest level, D2 line indicates the 20dB offset below D1. It shows compliance with the requirement in part 15.247(C).

Note - The delta method is only used up to 2 MHz away from the restricted bandage, The radiated emissions which located in other restricted frequency band, the result, please refer to 4.2.

NOTE (Peak):

The band edge emission plot of OFDM technique on the following page 71 show 38.75dB delta between carrier maximum power and local maximum emission in restrict band (2.3900GHz). The emission of carrier strength list in the test result of channel 1 at the item 4.2 is 108.3dBuV/m, so the maximum field strength in restrict band is $108.3-38.75=69.55$ dBuV/m which is under 74 dBuV/m limit.

The band edge emission plot of OFDM technique on the following page 71 shows 34.55dB delta between carrier maximum power and local maximum emission in restrict band (2.4835GHz). The emission of carrier strength list in the test result of channel 11 at the item 4.2 is 108.0dBuV/m, so the maximum field strength in restrict band is $108.0-34.55=73.45$ dBuV/m which is under 74 dBuV/m limit.

NOTE (Average):

The band edge emission plot of OFDM technique on the following page 72 shows 50.33dB delta between carrier maximum power and local maximum emission in restrict band (2.3900GHz). The emission of carrier strength list in the test result of channel 1 at the item 4.2 is 98.6dBuV/m, so the maximum field strength in restrict band is $98.6-50.33=48.27$ dBuV/m which is under 54 dBuV/m limit.

The band edge emission plot of OFDM technique on the following page 72 shows 47.2dB delta between carrier maximum power and local maximum emission in restrict band (2.4835GHz). The emission of carrier strength list in the test result of channel 11 at the item 4.2 is 97.9dBuV/m, so the maximum field strength in restrict band is $97.9-47.2=50.7$ dBuV/m which is under 54 dBuV/m limit.

For DSSS test:
CH1

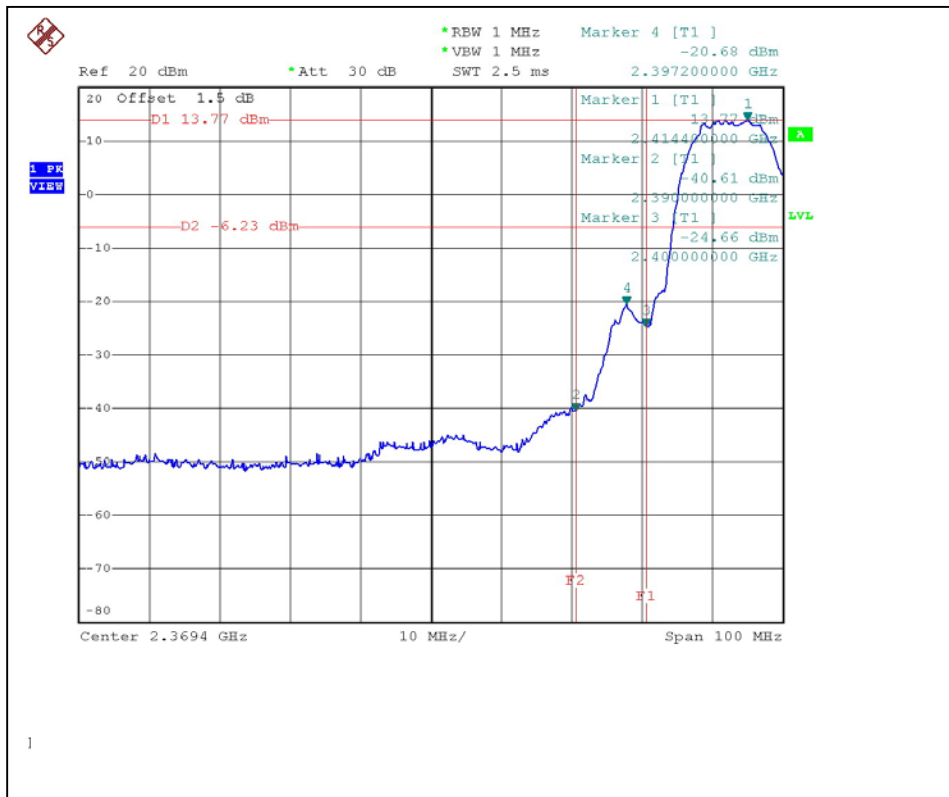

CH11

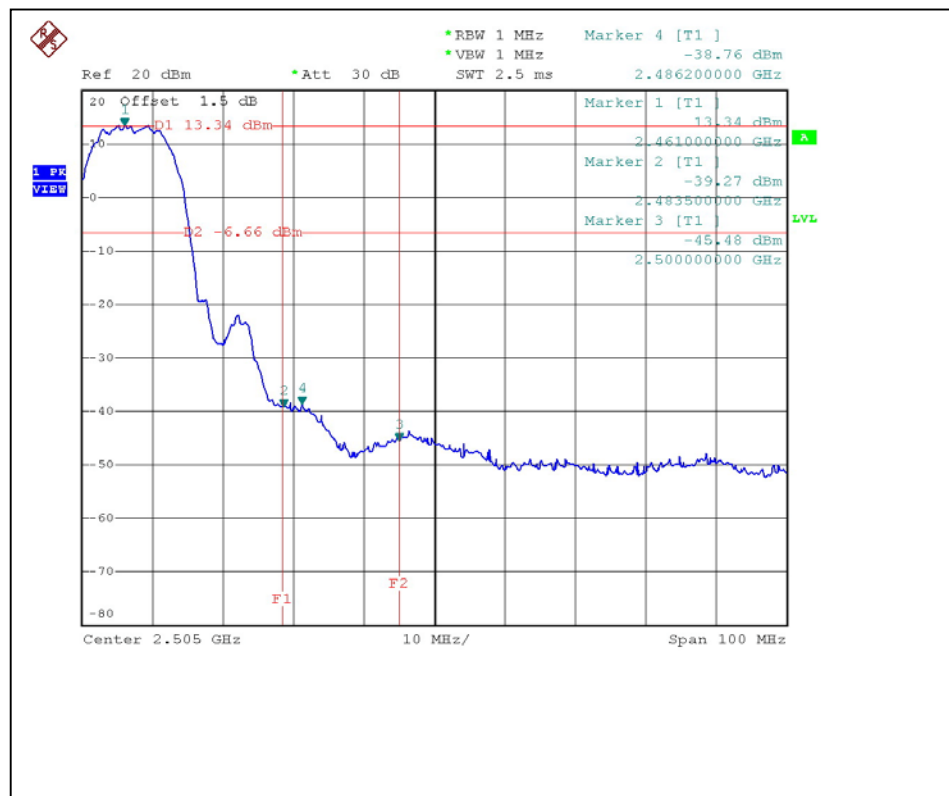

CH1

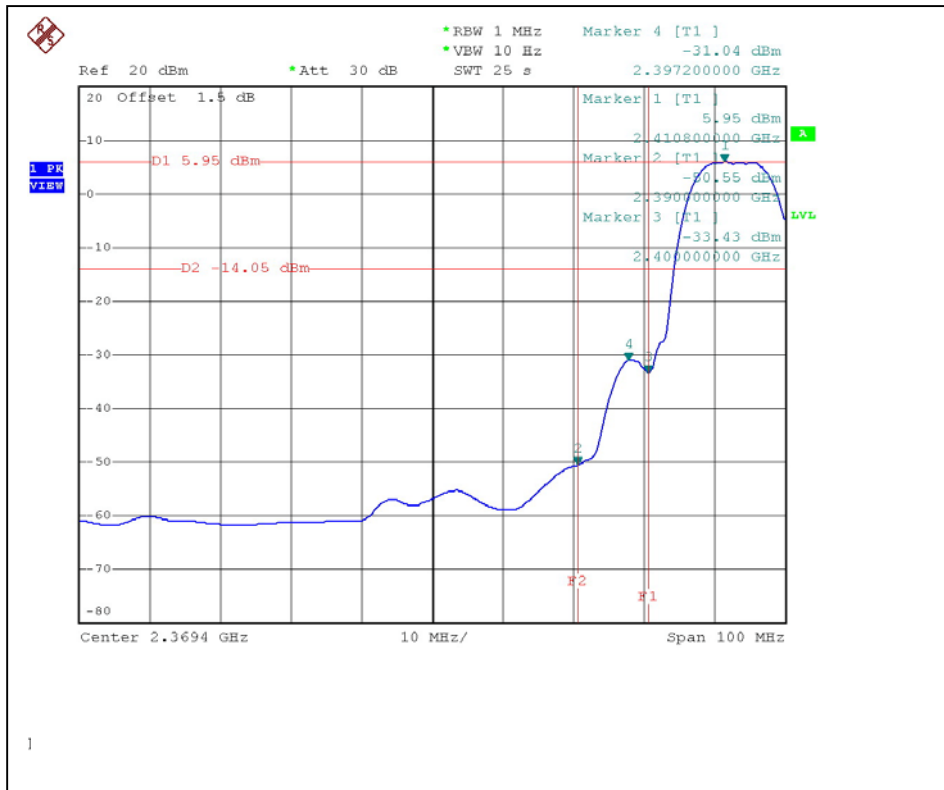

CH11

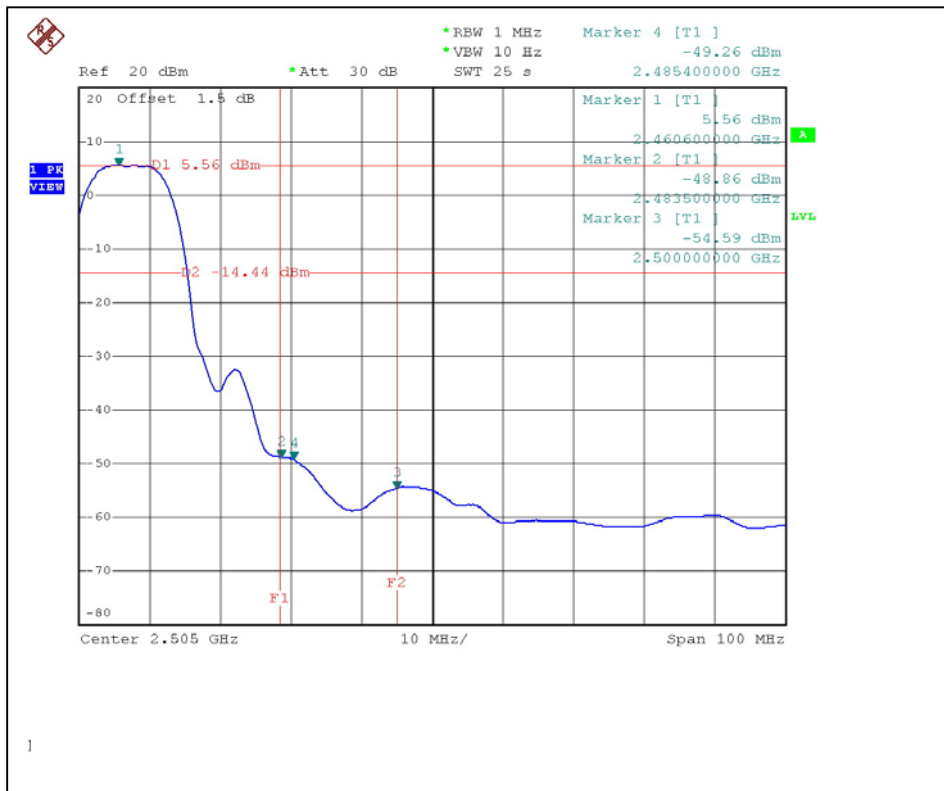

CH1

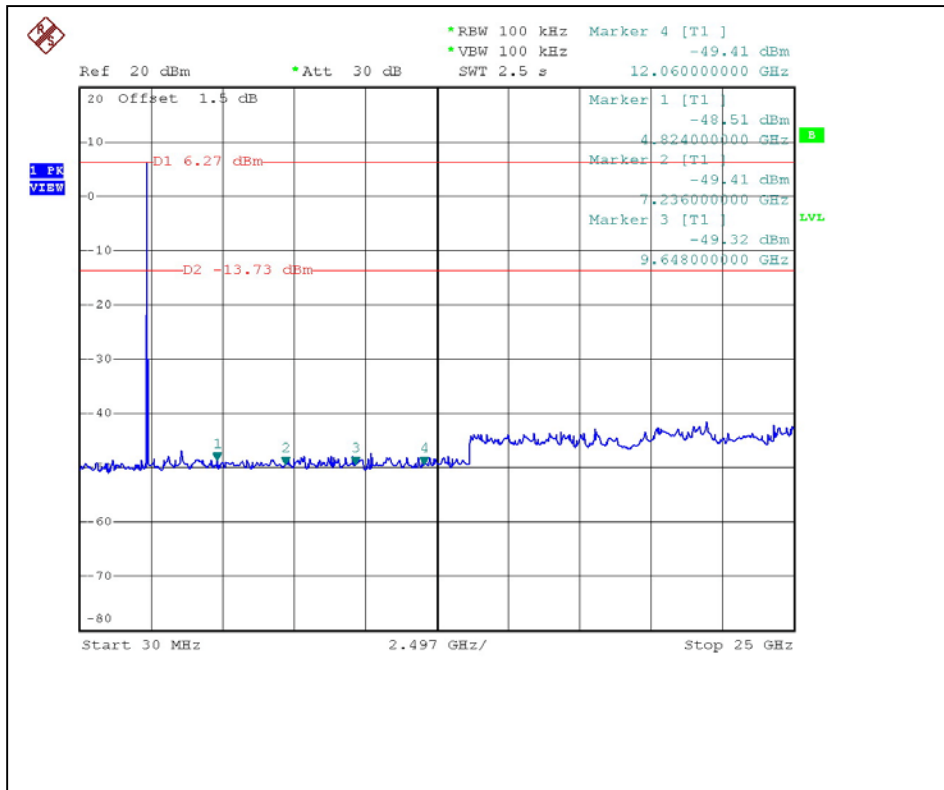

CH11

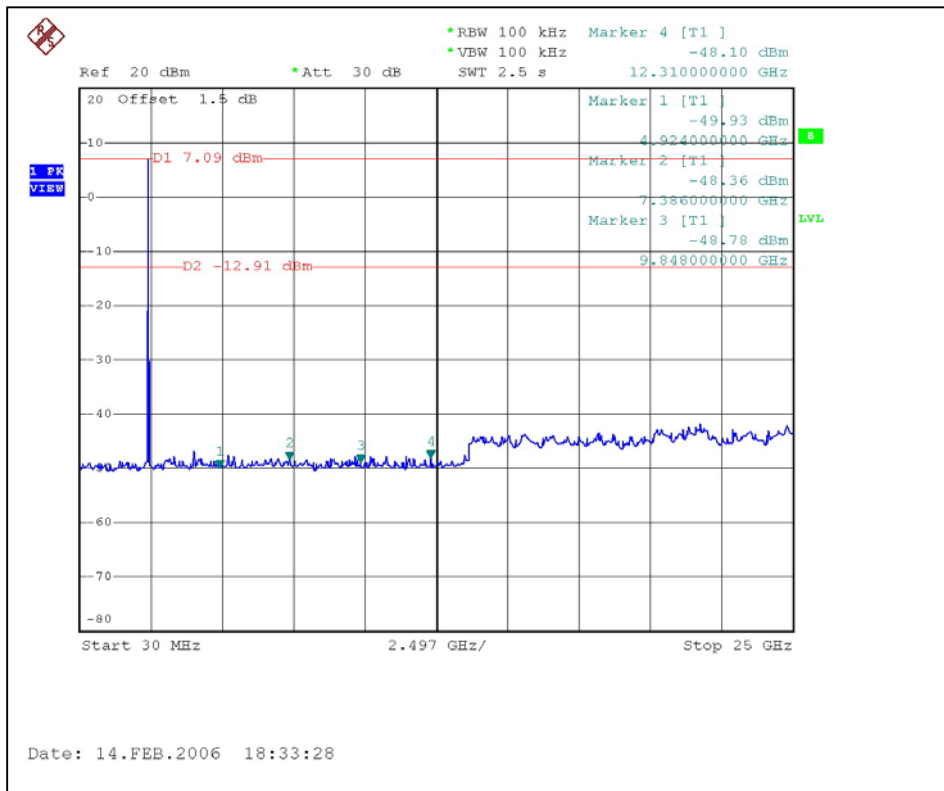

For OFDM test:
CH1

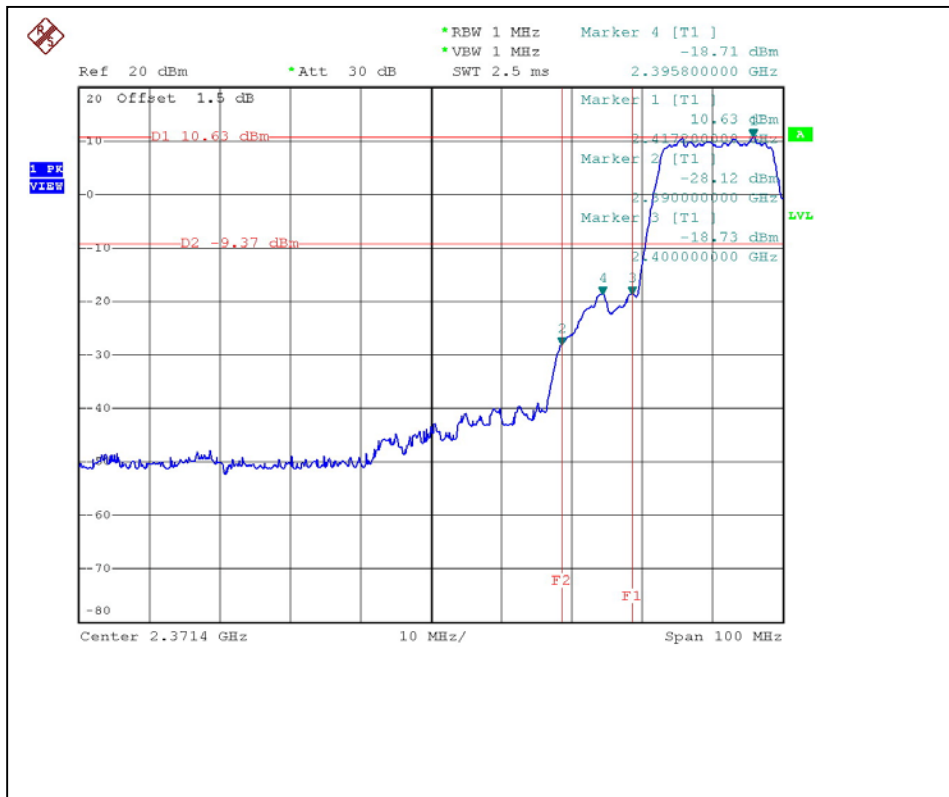

CH11

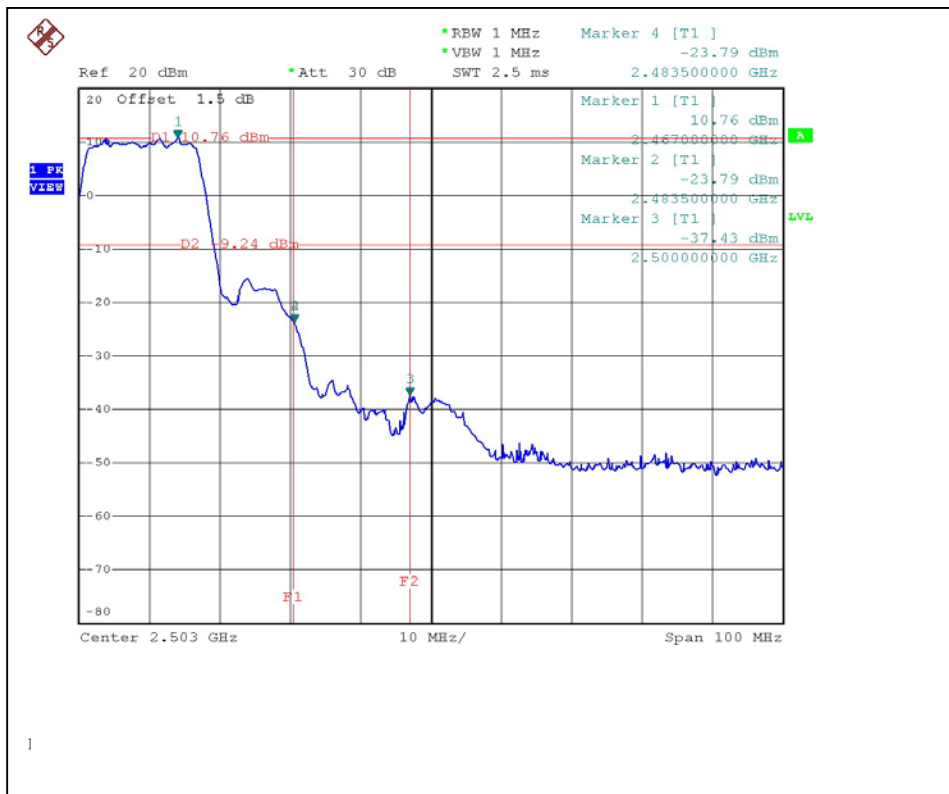

CH1

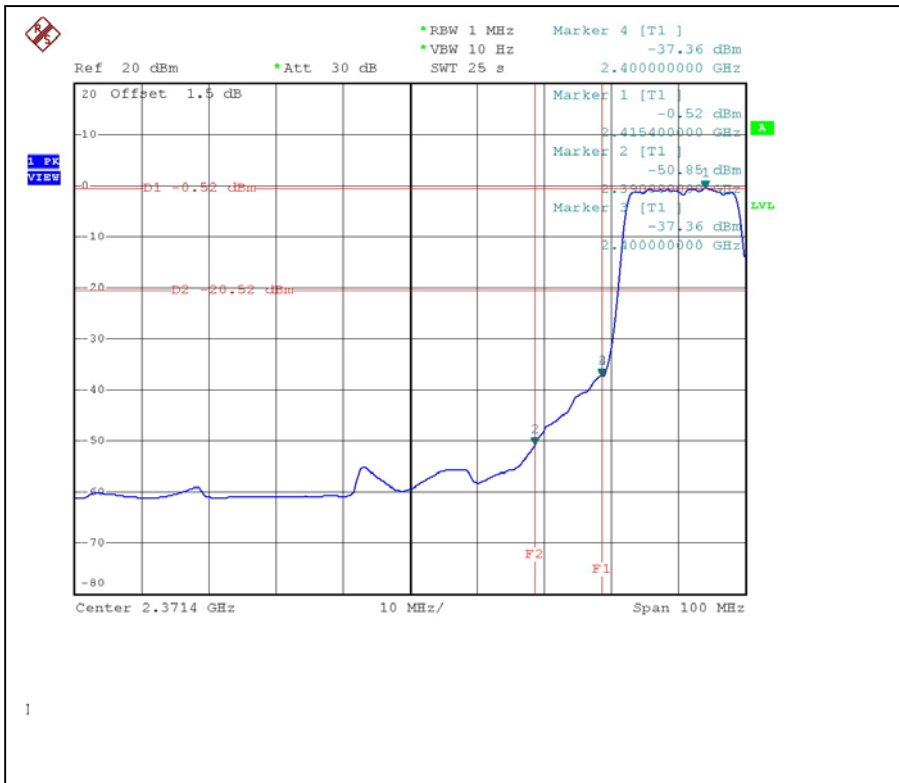

CH11

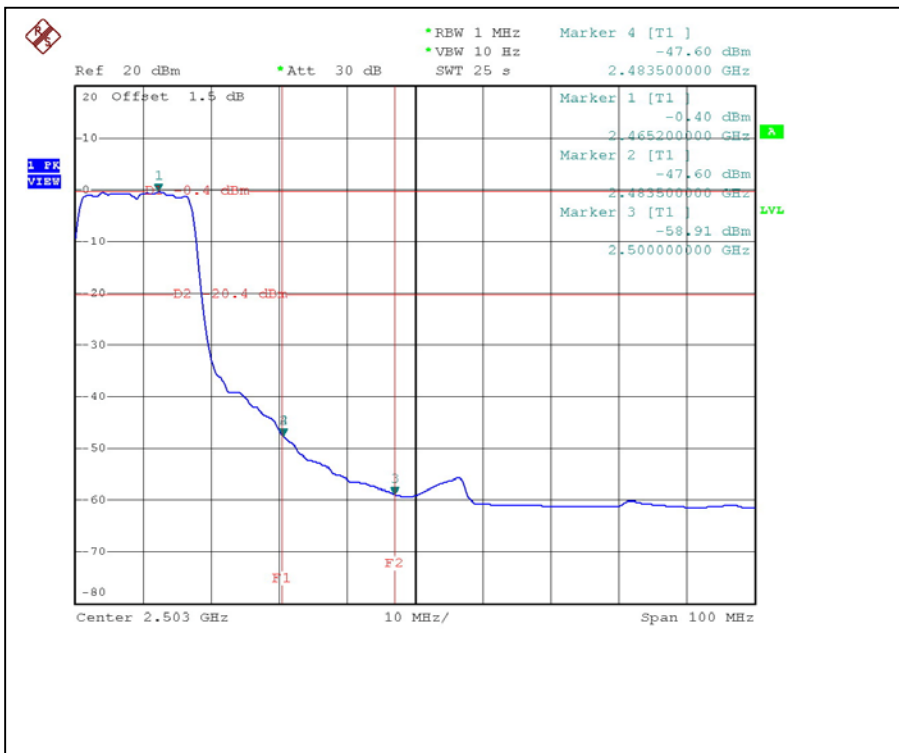

CH1

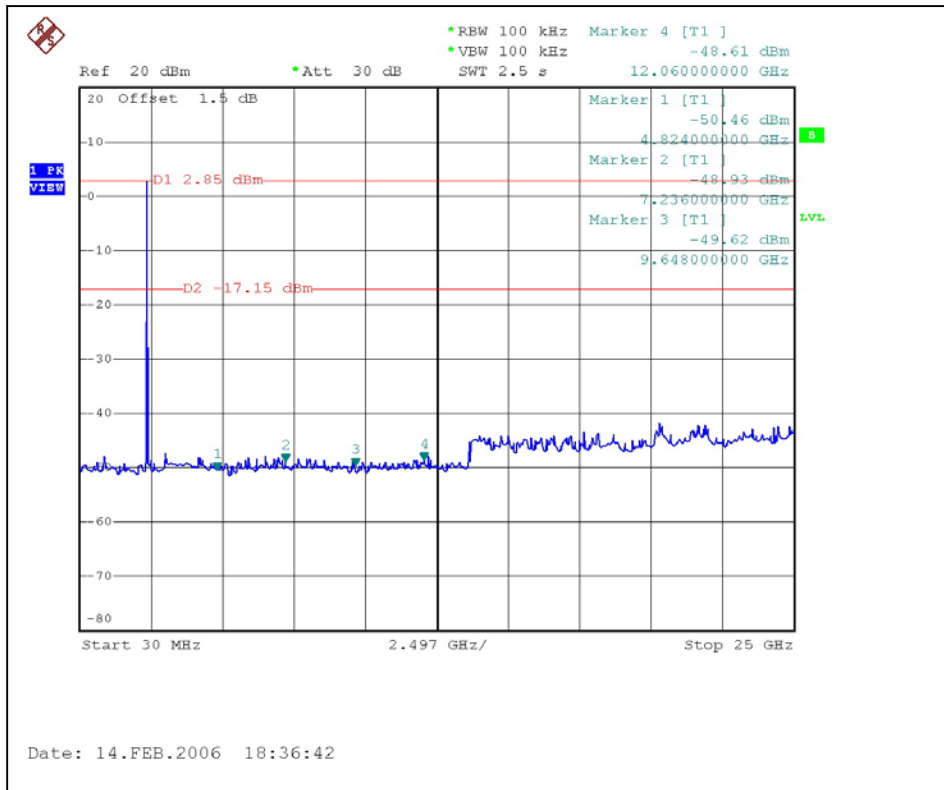

CH11

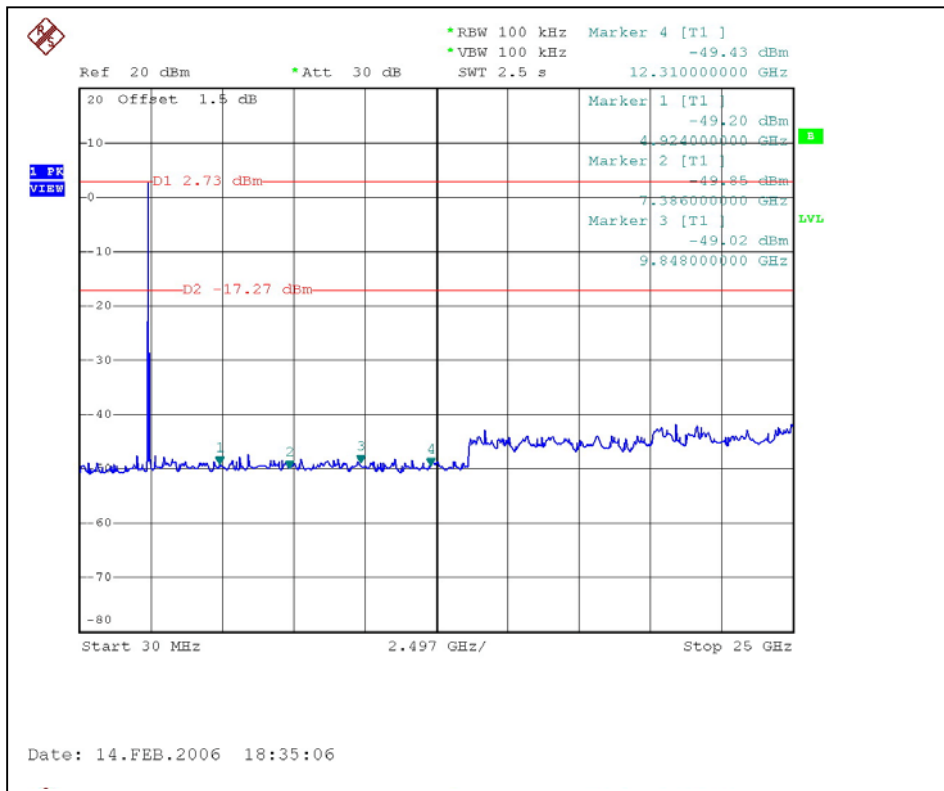



4.7 ANTENNA REQUIREMENT

4.7.1 STANDARD APPLICABLE

For intentional device, according to FCC 47 CFR Section 15.203, an intentional radiator shall be designed to ensure that no antenna other than that furnished by the responsible party shall be used with the device.

And according to FCC 47 CFR Section 15.247 (b), if transmitting antennas of directional gain greater than 6dBi are used, the power shall be reduced by the amount in dB that the directional gain of the antenna exceeds 6dBi.

4.7.2 ANTENNA CONNECTED CONSTRUCTION

The antennas used in this product are as following:

Brand Name	Model No.	Gain (dBi)	Antenna Type	Antenna Connector
High-tek	T700(PEN)	0.05	PIFA	I-PEX
ARISTOTLE	C2H Series	2.5	Monopole	I-PEX
Own design	MN003	1.29	PCB	I-PEX

5 PHOTOGRAPHS OF THE TEST CONFIGURATION CONDUCTED EMISSION TEST



RADIATED EMISSION TEST(Antenna: PIFA & PIFA)



RADIATED EMISSION TEST(Antenna: PCB & PCB)



RADIATED EMISSION TEST(Antenna: Monopole & Monopole)





6 INFORMATION ON THE TESTING LABORATORIES

We, ADT Corp., were founded in 1988 to provide our best service in EMC, Radio, Telecom and Safety consultation. Our laboratories are accredited and approved by the following approval agencies according to ISO/IEC 17025:

USA	FCC, UL, A2LA
Germany	TUV Rheinland
Japan	VCCI
Norway	NEMKO
Canada	INDUSTRY CANADA, CSA
R.O.C.	CNLA, BSMI, DGT
Netherlands	Telefication
Singapore	PSB, GOST-ASIA (MOU)
Russia	CERTIS (MOU)

Copies of accreditation certificates of our laboratories obtained from approval agencies can be downloaded from our web site: www.adt.com.tw/index.5/phtml.

If you have any comments, please feel free to contact us at the following:

Linko EMC/RF Lab:

Tel: 886-2-26052180

Fax: 886-2-26052943

Hsin Chu EMC/RF Lab:

Tel: 886-3-5935343

Fax: 886-3-5935342

Hwa Ya EMC/RF/Safety/Telecom Lab:

Tel: 886-3-3183232

Fax: 886-3-3185050

Email: service@adt.com.tw

Web Site: www.adt.com.tw

The address and road map of all our labs can be found in our web site also.



APPENDIX-A

MODIFICATIONS RECORDERS FOR ENGINEERING CHANGES TO THE EUT BY THE LAB

No any modifications are made to the EUT by the lab during the test.