



FCC SAR TEST REPORT

Report No.: SET2018-04105

Product: Full HD Battery IP Camera

FCC ID: NCI-VH810-M01

Model No.: VH810 M01

Listed Model: VH810 MXX(XX represent 01, 02,.....99)

Applicant: VIA Technologies, Inc.

Address: 8F,533 Zhongzheng Rd, Xindian Dist, New Taipei City Taiwan

Issued by: CCIC-SET

Lab Location: Building 28/29, East of Shigu, Xili Industrial Zone, Xili Road, Nanshan District, Shenzhen, Guangdong, China

Tel: 86 755 26627338 **Fax:** 86 755 26627238

Mail: manager@ccic-set.com **Website:** <http://www.ccic-set.com>

This test report consists of **47** pages in total. It may be duplicated completely for legal use with the approval of the applicant. It should not be reproduced except in full, without the written approval of our laboratory. The client should not use it to claim product endorsement by CCIC-SET. The test results in the report only apply to the tested sample. The test report shall be invalid without all the signatures of testing engineers, reviewer and approver. Any objections must be raised to CCIC-SET within 15 days since the date when the report is received. It will not be taken into consideration beyond this limit.



Test Report

Product: Full HD Battery IP Camera
Model No.: VH810 M01
Trade Name.....: VIA
Brand Name.....: Weikan
FCC ID.....: NCI-VH810-M01
Applicant.....: VIA Technologies, Inc.
Applicant Address.....: 8F,533 Zhongzheng Rd, Xindian Dist, New Taipei City Taiwan
Manufacturer.....: VIA Technologies(Shenzhen)Co.,Ltd.
Manufacturer Address: 4F, VIA Building, NO. 9966, Shennan Avenue,Nanshan District, Shenzhen,China

Test Standards.....: **47CFR § 2.1093-** Radiofrequency Radiation Exposure Evaluation: Portable Devices;
ANSI C95.1–1992: Safety Levels with Respect to Human Exposure to Radio Frequency Electromagnetic Fields, 3 kHz – 300 GHz.(IEEE Std C95.1-1991)
IEEE 1528–2013: IEEE Recommended Practice for Determining the Peak Spatial-Average Specific Absorption Rate (SAR) in the Human Head from Wireless Communications Devices: Measurement Techniques

Test Result.....: Pass

Test by: Mei Chun 2018-04-12
 Mei Chun, Test Engineer

Reviewed by.....: Zhu Qi 2018-04-12
 Zhu Qi, Senior EGINEER

Approved by.....: Smart Li 2018-04-12
 Smart Li, Manager



Contents

Test Report.....	2
1. Administrative Data.....	4
1.1 Testing Laboratory	4
2. Equipment Under Test (EUT).....	5
3. SAR Summary.....	6
4. Specific Absorption Rate (SAR).....	6
5. Tissue check and recommend Dielectric Parameters	9
5.1 Tissue Dielectric Parameters for Head and Body Phantoms	9
5.2 Simulate liquid.....	10
6. SAR System validation	11
7. SAR measurement procedure	13
8. Characteristics of The Test.....	14
8.1 Applicable Limit Regulations.....	14
8.2 Applicable Measurement Standards.....	14
9. Conducted RF Output Power	15
WLAN 2.4GHz Band Conducted Power	15
10. SAR test Exclusion and estimate SAR calculation:	16
11. Scaling Factor calculation	17
12. Test Results	17
13. Simultaneous Transmissions Analysis	18
14. Measurement Uncertainty.....	19
15. Equipment List.....	22
ANNEX A: SAR Test Setup.....	23
ANNEX B: System Check Plots.....	24
ANNEX C: SAR Test Plots(Worst-Case)	26



1. Administrative Data

1.1 Testing Laboratory

Test Site: CCIC Southern Electronic Product Testing (Shenzhen) Co., Ltd

Address: Electronic Testing Building, No. 43 Shahe Road, Xili Jiedao, Nanshan District, Shenzhen, Guangdong, China

CNAS Lab Code: CCIC-SET is a third party testing organization accredited by China National Accreditation Service for Conformity Assessment (CNAS) according to ISO/IEC 17025. The accreditation certificate number is L1659.

NVLAP Lab Code: CCIC-SET is a third party testing organization accredited by NVLAP according to ISO/IEC 17025. The accreditation certificate number is 201008-0.

FCC Registration: CCIC Southern Electronic Product Testing (Shenzhen) Co., Ltd. EMC Laboratory has been registered and fully described in a report filed with the FCC (Federal Communications Commission). The acceptance letter from the FCC is maintained in our files. Designation Number: CN5031, valid time is until December 31, 2018.

ISED Registration: CCIC Southern Electronic Product Testing (Shenzhen) Co., Ltd. EMC Laboratory has been registered by Certification and Engineering Bureau of Industry Canada for the performance of radiated measurements with Registration No. 11185A-1 on Aug. 04, 2016, valid time is until Aug. 03, 2019.

Test Environment Temperature (°C): 21 °C

Condition: Relative Humidity (%): 60%

Atmospheric Pressure (kPa): 86KPa-106KPa



2. Equipment Under Test (EUT)

Identification of the Equipment under Test

Sample Name: Full HD Battery IP Camera

Model Name: VH810 M01

S/N: VH810 MXX(XX represent 01,02.....99)

Brand Name: Weikan

General description:	Support Band	WIFI 2.4G(802.11b/g/n20/n40)
	Test Band	WIFI 802.11b
	Antenna type	Inner Antenna
	Operation mode	WIFI
	Modulation mode	WIFI(OFDM/DSSS)
	Hardware Version	VTS8707C
	Software Version	V0.1.1
	Battery	Model No. :302745 Capacitance:4020mAh Rated Voltage: 3.8V Charge Limit:4.35V
	Max. RF Power	16.27dBm
	Max. SAR Value	Body: 0.266W/kg(Limit:1.6W/Kg, 0mm distance)

NOTE:

- The above EUT's information was declared by manufacturer. Please refer to the specifications or user's manual for more detailed description.

3. SAR Summary

Highest Standalone SAR Summary

Frequency Band	Scaled 1g-SAR(W/kg)	Highest Scaled 1g-SAR(W/kg)
WIFI	0.266	0.266

4. Specific Absorption Rate (SAR)

4.1 Introduction

SAR is related to the rate at which energy is absorbed per unit mass in an object exposed to a radio field. The SAR distribution in a biological body is complicated and is usually carried out by experimental techniques or numerical modeling. The standard recommends limits for two tiers of groups, occupational/controlled and general population/uncontrolled, based on a person's awareness and ability to exercise control over his or her exposure. In general, occupational/controlled exposure limits are higher than the limits for general population/uncontrolled.

The SAR definition is the time derivative (rate) of the incremental energy (dW) absorbed by (dissipated in) an incremental mass (dm) contained in a volume element (dv) of a given density (ρ). The equation description is as below:

$$\text{SAR} = \frac{d}{dt} \left(\frac{dW}{dm} \right) = \frac{d}{dt} \left(\frac{dW}{\rho dv} \right)$$

SAR is expressed in units of Watts per kilogram (W/kg)

SAR measurement can be either related to the temperature elevation in tissue by

$$\text{SAR} = C \frac{\delta T}{\delta t}$$

where C is the specific heat capacity, δT is the temperature rise and δt the exposure duration, or related to the electrical field in the tissue by

$$\text{SAR} = \frac{\sigma |E|^2}{\rho}$$

where σ is the conductivity of the tissue, ρ is the mass density of the tissue and E is the rms electrical field strength.

However for evaluating SAR of low power transmitter, electrical field measurement is typically applied.

4.2 Phantoms

The phantom used for all tests i.e. for both system checks and device testing, was the twin-headed "SAM Phantom", manufactured by SATIMO. The SAM twin phantom is a fiberglass shell phantom with 2mm shell thickness (except the ear region, where shell thickness increases to 6mm).

System checking was performed using the flat section, whilst Head SAR tests used the left and right head profile sections. Body SAR testing also used the flat section between the head profiles.



SAM Twin Phantom

4.3 Device Holder

The device was placed in the device holder (illustrated below) that is supplied by SATIMO as an integral part of the COMOSAR test system.

The device holder is designed to cope with the different positions given in the standard. It has two scales for device rotation (with respect to the body axis) and device inclination (with respect to the line between the ear reference points). The rotation centers for both scales is the ear reference point (ERP). Thus the device needs no repositioning when changing the angles.

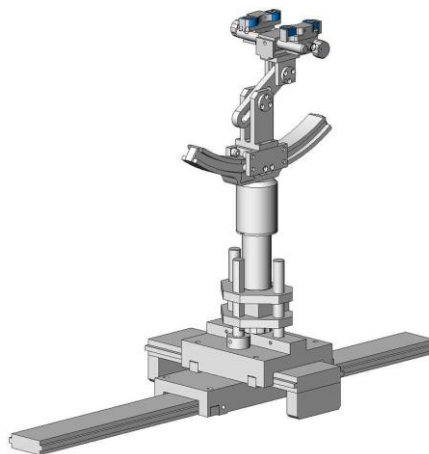

Device holder

4.4 Probe Specification



Construction	Symmetrical design with triangular core Interleaved sensors Built-in shielding against static charges PEEK enclosure material (resistant to organic solvents, e.g., DGBE)
Calibration	ISO/IEC 17025 calibration service available.
Frequency	700 MHz to 3 GHz; Linearity: ± 0.5 dB (700 MHz to 3 GHz)
Directivity	± 0.25 dB in HSL (rotation around probe axis) ± 0.5 dB in tissue material (rotation normal to probe axis)
Dynamic Range	1.5 μ W/g to 100 mW/g; Linearity: ± 0.5 dB
Dimensions	Overall length: 330 mm (Tip: 20 mm) Tip diameter: 5 mm Distance from probe tip to dipole centers: <2.7 mm
Application	General dosimetry up to 3 GHz Dosimetry in strong gradient fields Compliance tests of VH810 M01 LTE USB Modems
Compatibility	COMOSAR

Isotropic E-Field Probe

The isotropic E-Field probe has been fully calibrated and assessed for isotropicity, and boundary effect within a controlled environment. Depending on the frequency for which the probe is calibrated the method utilized for calibration will change.

The E-Field probe utilizes a triangular sensor arrangement as detailed in the diagram below:

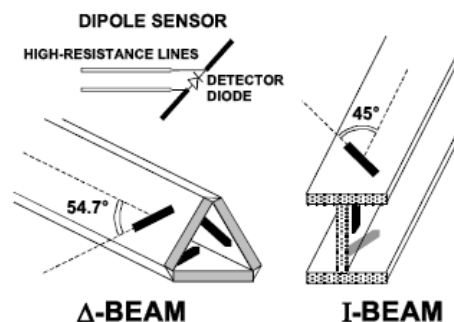



5. Tissue check and recommend Dielectric Parameters

5.1 Tissue Dielectric Parameters for Head and Body Phantoms

The head tissue dielectric parameters recommended by the IEEE SCC-34/SC-2 in P1528 have been incorporated in the following table. These head parameters are derived from planar layer models simulating the highest expected SAR for the dielectric properties and tissue thickness Power drifts in a human head. Other head and body tissue parameters that have not been specified in P1528 are derived from the tissue dielectric parameters computed from the 4-Cole-Cole equations described in Reference [12] and extrapolated according to the head parameters specified in P1528.

Table 1: Recommended Dielectric Performance of Tissue

Ingredients (% by weight)	Frequency (MHz)											
	450		835		915		1900		2450		2600	
Tissue Type	Head	Body	Head	Body	Head	Body	Head	Body	Head	Body	Head	Body
Water	38.56	51.16	41.46	52.4	41.05	56.0	54.9	40.4	62.7	73.2	55.24	64.49
Salt (Nacl)	3.95	1.49	1.45	1.4	1.35	0.76	0.18	0.5	0.5	0.04	0.5	0.024
Sugar	56.32	46.78	56.0	45.0	56.5	41.76	0.0	58.0	0.0	0.0	0.0	0.0
HEC	0.98	0.52	1.0	1.0	1.0	1.21	0.0	1.0	0.0	0.0	0.0	0.0
Bactericide	0.19	0.05	0.1	0.1	0.1	0.27	0.0	0.1	0.0	0.0	0.0	0.0
Triton x-100	0.0	0.0	0.0	0.0	0.0	0.0	0.0	0.0	36.8	0.0	44.45	32.25
DGBE	0.0	0.0	0.0	0.0	0.0	0.0	44.92	0.0	0.0	26.7	0.0	26.7
Dielectric Constant	43.42	58.0	42.54	56.1	42.0	56.8	39.9	54.0	39.8	52.5	39.0	52.5
Conductivity (s/m)	0.85	0.83	0.91	0.95	1.0	1.07	1.42	1.45	1.88	1.78	1.96	2.16

MSL/HSL750 (Body and Head liquid for 650 – 850 MHz)

Item	Head Tissue Simulation Liquid HSL750 Muscle(body)Tissue Simulation Liquid MSL750			
H2O	Water, 35 – 58%			
Sucrose	Sugar, white, refined, 40-60%			
NaCl	Sodium Chloride, 0-6%			
Hydroxyethyl-cellulose	Medium Viscosity (CAS# 9004-62-0), <0.3%			
Preventol-D7	Preservative: aqueous preparation, (CAS# 55965-84-9), containing 5-chloro-2-methyl-3(2H)-isothiazolone and 2-methyl-3(2H)-isothiazolone, 0.1-0.7%			
Frequency (MHz)	Head ϵ_r	Head σ (S/m)	Body ϵ_r	Body σ (S/m)
750	41.9	0.89	55.2	0.97

Note: The liquid of 700MHz&2600MHz typical liquid composition is provided by SATIMO.

Table 2 Recommended Tissue Dielectric Parameters

Frequency (MHz)	Head Tissue		Body Tissue	
	ϵ_r	σ (S/m)	ϵ_r	σ (S/m)
150	52.3	0.76	61.9	0.80
300	45.3	0.87	58.2	0.92
450	43.5	0.87	56.7	0.94
835	41.5	0.90	55.2	0.97
900	41.5	0.97	55.0	1.05
915	41.5	0.98	55.0	1.06
1450	40.5	1.20	54.0	1.30
1610	40.3	1.29	53.8	1.40
1800-2000	40.0	1.40	53.3	1.52
2450	39.2	1.80	52.7	1.95
3000	38.5	2.40	52.0	2.73
5800	35.3	5.27	48.2	6.00

5.2 Simulate liquid

Liquid check results:

Table 3: Dielectric Performance of Body Tissue Simulating Liquid

Temperature: 23.2°C; Humidity: 64%;			
/	Frequency	Permittivity ϵ	Conductivity σ (S/m)
Target value	2450MHz	$52.7 \pm 5\%$	$1.95 \pm 5\%$
Validation value (April. 12th, 2018)	2450MHz	52.73	1.96

6. SAR System validation

Prior to the assessment, the system validation kit was used to test whether the system was operating within its specifications of $\pm 10\%$. The validation results are tabulated below. And also the corresponding SAR plot is attached as well in the SAR plots files.

The following procedure, recommended for performing validation tests using box phantoms is based on the procedures described in the IEEE standard P1528. Setup according to the setup diagram below:

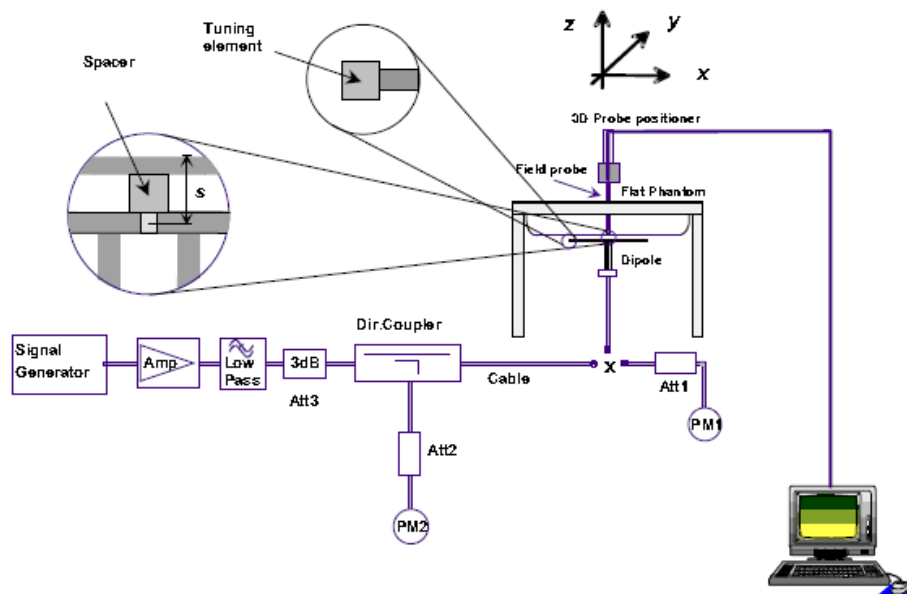

With the SG and Amp and with directional coupler in place, set up the source signal at the relevant frequency and use a power meter to measure the power at the end of the SMA cable that you intend to connect to the balanced dipole. Adjust the SG to make this, say, 0.01W (10 dBm). If this level is too high to read directly with the power meter sensor, insert a calibrated attenuator (e.g. 10 or 20 dB) and make a suitable correction to the power meter reading.

Note 1: In this method, the directional coupler is used for monitoring rather than setting the exact feed power level. If, however, the directional coupler is used for power measurement, you should check the frequency range and power rating of the coupler and measure the coupling factor (referred to output) at the test frequency using a VNA.

Note 2: Remember that the use of a 3dB attenuator (as shown in Figure 8.1 of P1528) means that you need an RF amplifier of 2 times greater power for the same feed power. The other issue is the cable length. You might get up to 1dB of loss per meter of cable, so the cable length after the coupler needs to be quite short.

Note 3: For the validation testing done using CW signals, most power meters are suitable. However, if you are measuring the output of a modulated signal from either a signal generator or a handset, you must ensure that the power meter correctly reads the modulated signals.

The measured 1-gram averaged SAR values of the device against the phantom are provided in Tables 5 and Table 6. The humidity and ambient temperature of test facility were 64% and 23.2°C respectively. The body phantom were full of the body tissue simulating liquid. The EUT was supplied with full-charged battery for each measurement.

The distance between the back of the EUT and the bottom of the flat phantom is 10 mm (taking into account of the IEEE 1528 and the place of the antenna).

Table 4: Body SAR system validation (1g)

Frequency	Duty cycle	Target value (W/kg)	Test value (W/kg)	
			10mW	1W
2450MHz(April. 12th, 2018)	1:1	51.42 ± 10%	0.5202	52.02

* Note: Target value was referring to the measured value in the calibration certificate of reference dipole.

Note: All SAR values are normalized to 1W forward power.

7. SAR measurement procedure

The SAR test against the head phantom was carried out as follow:

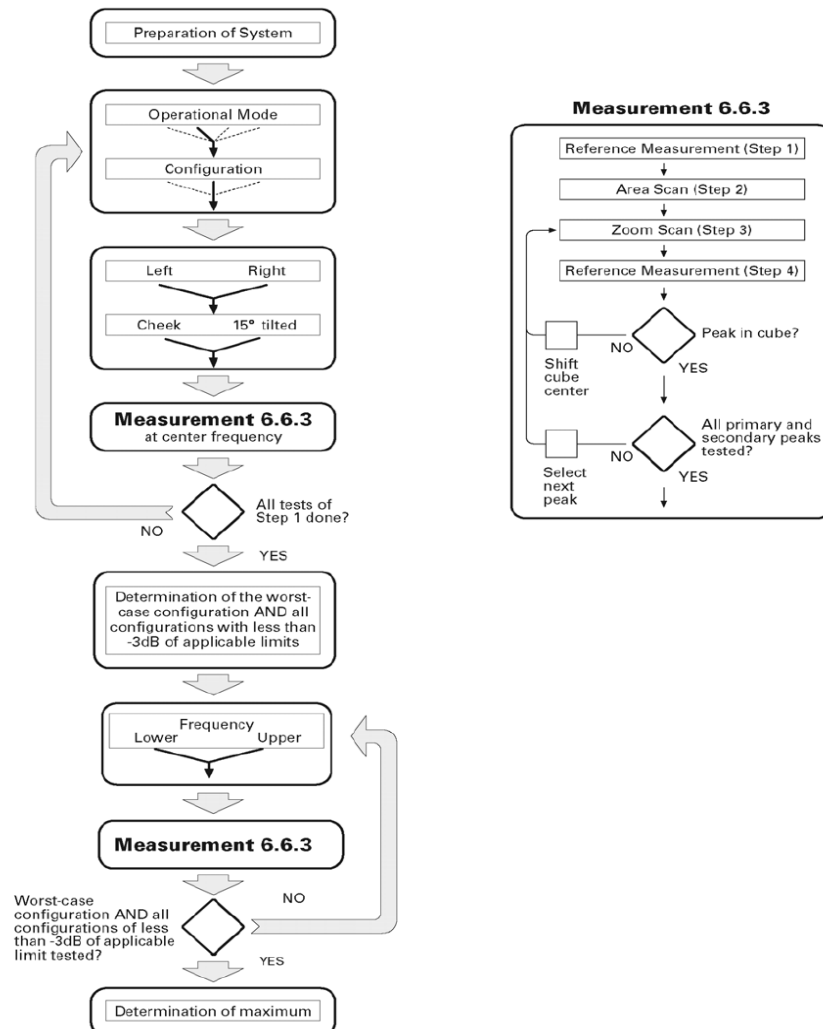

Establish a call with the maximum output power with a base station simulator, the connection between the EUT and the base station simulator is established via air interface.

After an area scan has been done at a fixed distance of 2mm from the surface of the phantom on the source side, a 3D scan is set up around the location of the maximum spot SAR. First, a point within the scan area is visited by the probe and a SAR reading taken at the start of testing. At the end of testing, the probe is returned to the same point and a second reading is taken. Comparison between these start and end readings enables the power drift during measurement to be assessed.

Above is the scanning procedure flow chart and table from the IEEE p1528 standard. This is the procedure for which all compliant testing should be carried out to ensure that all variations of the device position and transmission behavior are tested.



8. Characteristics of The Test

8.1 Applicable Limit Regulations

47CFR § 2.1093- Radiofrequency Radiation Exposure Evaluation: Portable Devices;

ANSI C95.1–1999: Safety Levels with Respect to Human Exposure to Radio Frequency Electromagnetic Fields, 3 kHz – 300 GHz.(IEEE Std C95.1-1991)

IEEE 1528–2013: IEEE Recommended Practice for Determining the Peak Spatial-Average Specific Absorption Rate (SAR) in the Human Head from Wireless Communications Devices: Measurement Techniques

It specifies the maximum exposure limit of **1.6 W/kg** as averaged over any 1 gram of tissue for portable devices being used within 20 cm of the user in the uncontrolled environment.

8.2 Applicable Measurement Standards

The Specific Absorption Rate (SAR) testing specification, method, and procedure for this is in accordance with the following standards:

FCC 47 CFR Part2 (2.1093)

ANSI/IEEE C95.1-1999

IEEE 1528-2013

FCC KDB 248227 D01 802.11 Wi-Fi SAR v02r02

FCC KDB 447498 D01 v06 General RF Exposure Guidance

FCC KDB 865664 D01 v01r04 SAR Measurement 100MHz to 6GHz

FCC KDB 865664 D02 v01r02 SAR Exposure Reporting

9. Conducted RF Output Power

WLAN 2.4GHz Band Conducted Power

Channel/Freq.(MHz)	Maximum Conducted Out Power (dBm)		
	802.11b	802.11g	802.11n(HT20)
1(2412)	16.27	15.43	14.04
6(2437)	16.27	15.77	14.41
11(2462)	16.20	15.51	14.22
Channel/Freq.(MHz)	Maximum Conducted Out Power (dBm) Peak		
	802.11n40		
3(2422)	13.13		
6(2437)	13.41		
9(2452)	13.30		

Note:

1. Per KDB248227 D01 v02r02, choose the highest output power channel to test SAR and determine further SAR exclusion
2. For each frequency band, testing at higher data rates and higher order modulations is not required when the maximum average output power for each of these configurations is less than 1/4dB higher than those measured at lowest data rate
3. Per KDB248227 D01 v02r02, 802.11g /11n-HT20/11n-HT40 is not required. . When the highest reported SAR for DSSS is adjusted by the ratio of OFDM to DSSS specified maximum output power and the adjusted SAR is $\leq 1.2\text{W/Kg}$. Thus the SAR can be excluded.

10. SAR test Exclusion and estimate SAR calculation:

Antenna Location:

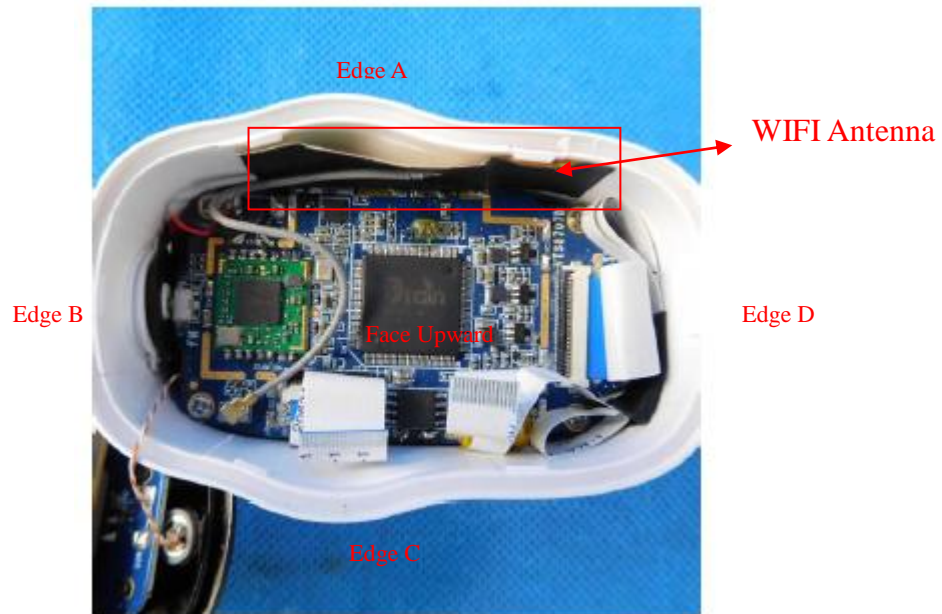

Antenna-to-User (Edge Side) distance (mm):

Antenna	Front	Back	Edge A	Edge B	Edge C	Edge D
WWAN Main Antenna	13	53	3	17	40	20
Test(Y/N)	Y	N	Y	Y	N	Y

Note: SAR is not required when the Antenna-to-User > 2.5cm according to KDB 447498.

11. Scaling Factor calculation

Operation Mode	Channel	Output Power(dBm)	Tune up Power in tolerance(dBm)	Scaling Factor
WIFI 802.11b	1	16.27	16 ± 1.0	1.183
	6	16.27	16 ± 1.0	1.183
	11	16.20	16 ± 1.0	1.202

12. Test Results

SAR Values of Wi-Fi 802.11b

Test Positions		Channel /Frequency (MHz)	SAR(W/Kg), 1.6 (1g average)			Plot No.
			SAR(W/Kg) 1g	Scaled Factor	Scaled SAR(W/Kg) ,1g	
Body	Face Upward	6/2437	0.032	1.183	0.038	--
	Edge A	6/2437	0.225	1.183	0.266	1
	Edge B	6/2437	0.028	1.183	0.033	--
	Edge D	6/2437	0.025	1.183	0.030	--

Note:

Per KDB941225 D06 v02r01, When the antenna-to-edge distance is greater than 2.5cm, such position does not need to be tested. As the manufacture requirement the separation distance use 5mm for Hotspot mode.

Per KDB Publication 941225 D01v03r01. RMC 12.2kbps was as primary mode SAR, when the primary mode SAR less than 1.2W/kg, secondary SAR (HSPA) was not requires.

When the 1-g SAR for the mid-band channel or the channel with the highest output power satisfy the following conditions, testing of the other channels in the band is not required. (Per KDB 447498 D01 General RF Exposure Guidance v06)

- ≤ 0.8 W/kg, when the transmission band is ≤ 100 MHz
- ≤ 0.6 W/kg, when the transmission band is between 100 MHz and 200 MHz
- ≤ 0.4 W/kg, when the transmission band is ≥ 200 MHz



13. Simultaneous Transmissions Analysis

Localized Specific Absorption Rate (SAR) of this portable wireless device has been measured in all cases requested by the relevant standards cited in Clause 6 of this report. Maximum localized SAR is **below** exposure limits specified in the relevant standards.

Note: No Simultaneous SAR was required

14. Measurement Uncertainty

No.	Uncertainty Component	Type	Uncertainty Value (%)	Probability Distribution	k	ci	Standard Uncertainty (%) $u_i(\%)$	Degree of freedom ν_{eff} or ν_i
Measurement System								
1	- Probe Calibration	B	5.8	N	1	1	5.8	∞
2	- Axial isotropy	B	3.5	R	$\sqrt{3}$	0.5	1.43	∞
3	- Hemispherical Isotropy	B	5.9	R	$\sqrt{3}$	0.5	2.41	∞
4	- Boundary Effect	B	1	R	$\sqrt{3}$	1	0.58	∞
5	- Linearity	B	4.7	R	$\sqrt{3}$	1	2.71	∞
6	- System Detection Limits	B	1.0	R	$\sqrt{3}$	1	0.58	∞
7	Modulation response	B	3	N	1	1	3.00	
8	- Readout Electronics	B	0.5	N	1	1	0.50	∞
9	- Response Time	B	1.4	R	$\sqrt{3}$	1	0.81	∞
10	- Integration Time	B	3.0	R	$\sqrt{3}$	1	1.73	∞
11	- RF Ambient Conditions	B	3.0	R	$\sqrt{3}$	1	1.73	∞
12	- Probe Position Mechanical tolerance	B	1.4	R	$\sqrt{3}$	1	0.81	∞
13	- Probe Position with respect to Phantom Shell	B	1.4	R	$\sqrt{3}$	1	0.81	∞
14	- Extrapolation, Interpolation and Integration Algorithms for Max. SAR evaluation	B	2.3	R	$\sqrt{3}$	1	1.33	∞
Uncertainties of the DUT								
15	- Position of the DUT	A	2.6	N	$\sqrt{3}$	1	2.6	5
16	- Holder of the DUT	A	3	N	$\sqrt{3}$	1	3.0	5



17	- Output Power Variation -SAR drift measurement	B	5.0	R	$\sqrt{3}$	1	2.89	∞
Phantom and Tissue Parameters								
18	- Phantom Uncertainty(shape and thickness tolerances)	B	4	R	$\sqrt{3}$	1	2.31	∞
19	Uncertainty in SAR correction for deviation(in permittivity and conductivity)	B	2	N	1	1	2.00	
20	- Liquid Conductivity Target -tolerance	B	2.5	R	$\sqrt{3}$	0.6	1.95	∞
21	- Liquid Conductivity -measurement Uncertainty)	B	4	N	$\sqrt{3}$	1	0.92	9
22	- Liquid Permittivity Target tolerance	B	2.5	R	$\sqrt{3}$	0.6	1.95	∞
23	- Liquid Permittivity -measurement uncertainty	B	5	N	$\sqrt{3}$	1	1.15	∞
Combined Standard Uncertainty				RSS			10.63	
Expanded uncertainty (Confidence interval of 95 %)				K=2			21.26	

System Check Uncertainty

No.	Uncertainty Component	Type	Uncertainty Value (%)	Probability Distribution	k	ci	Standard Uncertainty (%) $u_i(\%)$	Degree of freedom v_{eff} or v_i
Measurement System								
1	- Probe Calibration	B	5.8	N	1	1	5.8	∞
2	- Axial isotropy	B	3.5	R	$\sqrt{3}$	0.5	1.43	∞
3	- Hemispherical Isotropy	B	5.9	R	$\sqrt{3}$	0.5	2.41	∞
4	- Boundary Effect	B	1	R	$\sqrt{3}$	1	0.58	∞
5	- Linearity	B	4.7	R	$\sqrt{3}$	1	2.71	∞
6	- System Detection Limits	B	1	R	$\sqrt{3}$	1	0.58	∞
7	Modulation response	B	0	N	1	1	0.00	



8	- Readout Electronics	B	0.5	N	1	1	0.50	∞
9	- Response Time	B	0.00	R	$\sqrt{3}$	1	0.00	∞
10	- Integration Time	B	1.4	R	$\sqrt{3}$	1	0.81	∞
11	- RF Ambient Conditions	B	3.0	R	$\sqrt{3}$	1	1.73	∞
12	- Probe Position Mechanical tolerance	B	1.4	R	$\sqrt{3}$	1	0.81	∞
13	- Probe Position with respect to Phantom Shell	B	1.4	R	$\sqrt{3}$	1	0.81	∞
14	- Extrapolation, Interpolation and Integration Algorithms for Max. SAR evaluation	B	2.3	R	$\sqrt{3}$	1	1.33	∞
Uncertainties of the DUT								
15	Deviation of experimental source from numerical source	A	4	N	1	1	4.00	5
16	Input Power and SAR drift measurement	A	5	R	$\sqrt{3}$	1	2.89	5
17	Dipole Axis to Liquid Distance	B	2	R	$\sqrt{3}$	1	1.2	∞
Phantom and Tissue Parameters								
18	- Phantom Uncertainty(shape and thickness tolerances)	B	4	R	$\sqrt{3}$	1	2.31	∞
19	Uncertainty in SAR correction for deviation(in permittivity and conductivity)	B	2	N	1	1	2.00	
20	- Liquid Conductivity Target -tolerance	B	2.5	R	$\sqrt{3}$	0.6	1.95	∞
21	- Liquid Conductivity -measurement Uncertainty)	B	4	N	$\sqrt{3}$	1	0.92	9
22	- Liquid Permittivity Target tolerance	B	2.5	R	$\sqrt{3}$	0.6	1.95	∞
23	- Liquid Permittivity -measurement uncertainty	B	5	N	$\sqrt{3}$	1	1.15	∞
Combined Standard Uncertainty				RSS			10.15	
Expanded uncertainty (Confidence interval of 95 %)				K=2			20.29	



15. Equipment List

EQUIPMENT	TYPE	Series No.	Calibration Date	calibration period
SAR Probe	SATIMO	SN43/15 EP276	2017/11/27	1 Year
Dipole	SID2450	SN09/13 DIP2G450-220	2017/11/27	1 Year
Vector Network Analyzer(R&S)	ZVB8	A0802530	2017/05/04	1 Year
Dielectric Probe Kit	SCLMP	SN 09/13 OCPG51	2017/11/27	1 Year
Signal Generator	SMU200A	A140801889	2017/05/04	1 Year
Amplifier	Nucletudes	143060	2018/03/27	1 Year
Directional Coupler	DC6180A	305827	2018/03/27	1 Year
Power Meter	NRP2	A140401673	2018/03/27	1 Year
Power Sensor	NPR-Z11	1138.3004.02-114072-nq	2018/03/27	1 Year
Power Meter	NRVS	A0802531	2018/03/27	1 Year
Power Sensor	NRV-Z4	100069	2018/03/27	1 Year

ANNEX A: SAR Test Setup

Photo 1: Measurement System SATIMO



Photo 2: Face Upward 0mm



Photo 3: Edge A 0mm



Photo 4: Edge B 0mm



Photo 5: Edge D 0mm

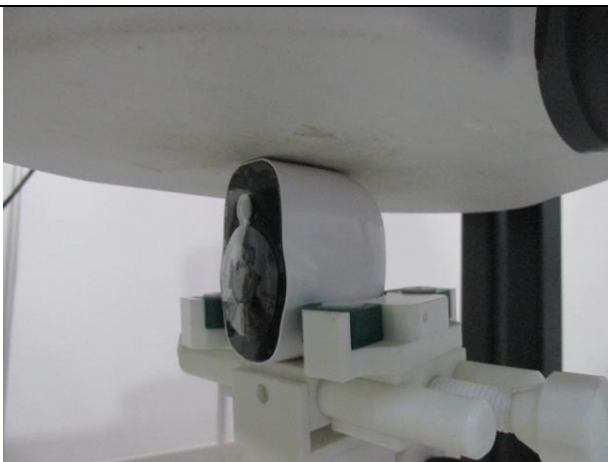

ANNEX B: System Check Plots

System Performance Check (Body, 2450MHz)

Type: Phone measurement

Area scan resolution: dx=8mm,dy=8mm

Zoom scan resolution: dx=5mm, dy=5mm, dz=4mm

Date of measurement: 12/04/2018

Measurement duration: 22 minutes 26 seconds

A. Experimental conditions.

Phantom File	dx=8mm dy=8mm
Phantom	7x7x8,dx=5mm dy=5mm dz=4mm
Device Position	Dipole
Band	2450MHz
Channels	
Signal	CW

B. SAR Measurement Results

Band SAR

E-Field Probe	SATIMO SN_43/15_EP276
Frequency (MHz)	2450
Relative permittivity (real part)	52.73
Relative permittivity	14.22
Conductivity (S/m)	1.96
Power Drift (%)	-0.09
Duty factor:	1:1
ConvF:	4.61

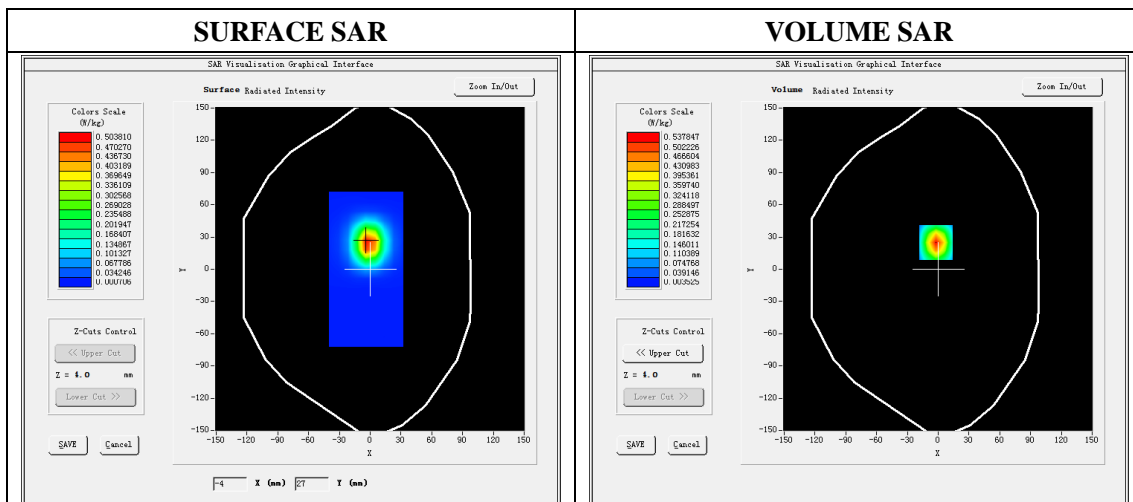

Maximum location: X=-2.00, Y=25.00

SAR 10g (W/Kg)	0.238439
SAR 1g (W/Kg)	0.520272

Z (mm)	0.00	4.00	9.00	14.00	19.00
SAR (W/Kg)	0.9267	0.5378	0.2580	0.1225	0.0625

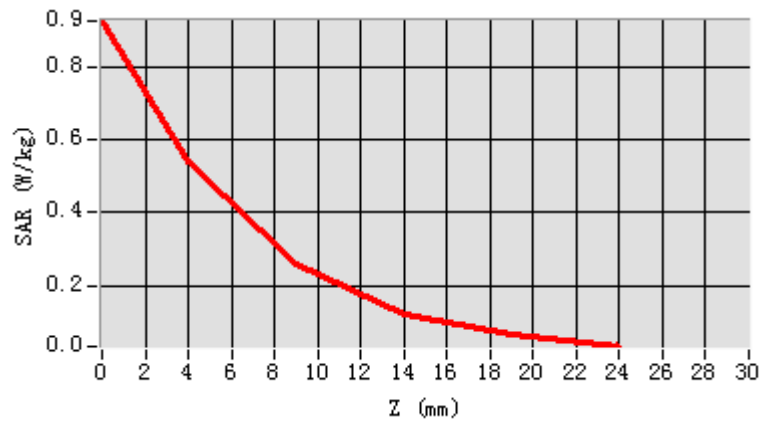

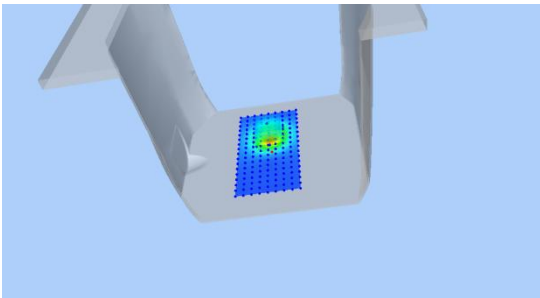
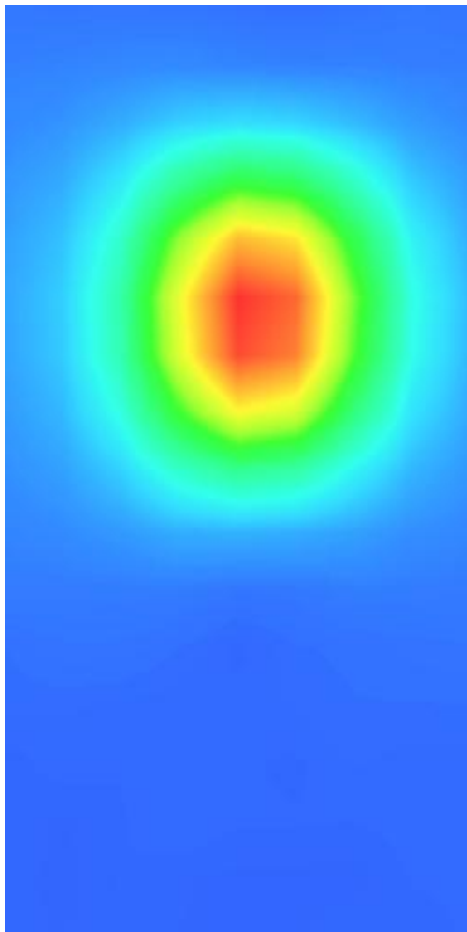
3D screen shot	Hot spot position
	

ANNEX C: SAR Test Plots(Worst-Case)

Plot 1: WIFI 802.11b, Body-Support, Middle, Edge A position

Type: Phone measurement

Date of measurement: 12/04/2018

Measurement duration: 21 minutes 21 seconds

Mobile Phone IMEI number: --

A. Experimental conditions.

Area Scan	dx=8mm dy=8mm
ZoomScan	7x7x8,dx=5mm dy=5mm dz=4mm
Phantom	Validation plane
Device Position	Back
Band	IEEE 802.11b
Channels	6
Signal	DSSS (Crest factor: 1:1)

B. SAR Measurement Results

E-Field Probe	SATIMO SN_43/15_EP276
Frequency (MHz)	2437
Relative permittivity (real part)	52.73
Relative permittivity (imaginary part)	14.22
Conductivity (S/m)	1.96
Variation (%)	-1.31
ConvF:	4.61

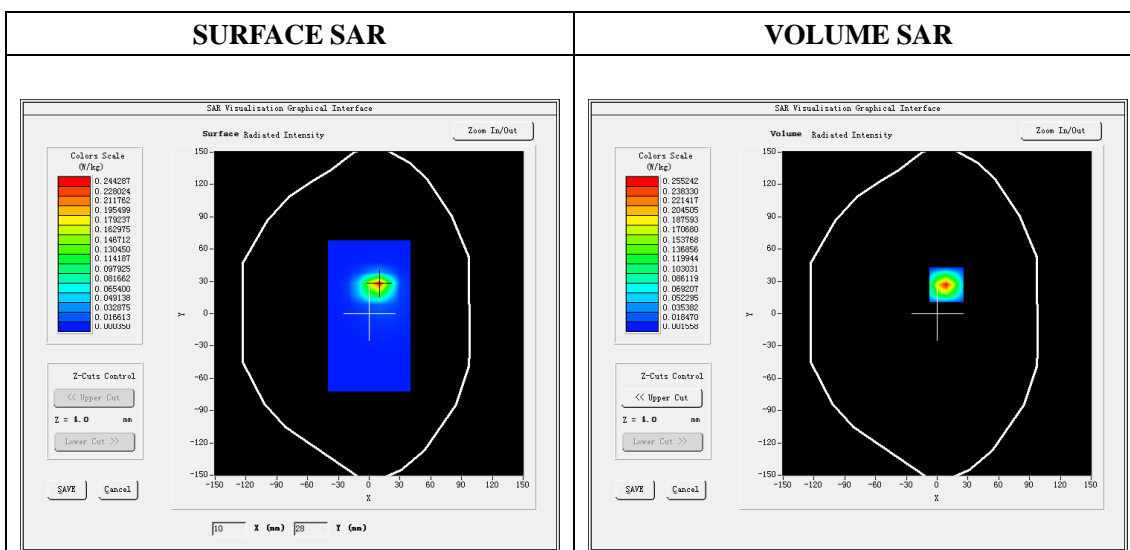

Maximum location: X=9.00, Y=27.00

SAR Peak: 0.45 W/kg

SAR 10g (W/Kg)	0.091407
SAR 1g (W/Kg)	0.224677

Z (mm)	0.00	4.00	9.00	14.00	19.00
SAR (W/Kg)	0.4434	0.2552	0.1206	0.0559	0.0277

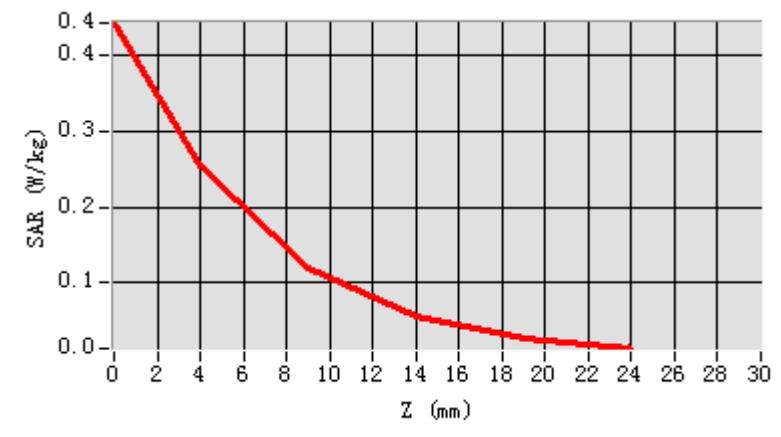

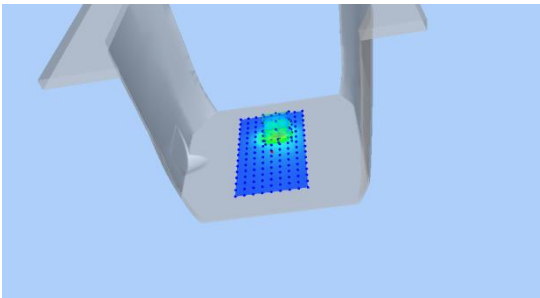
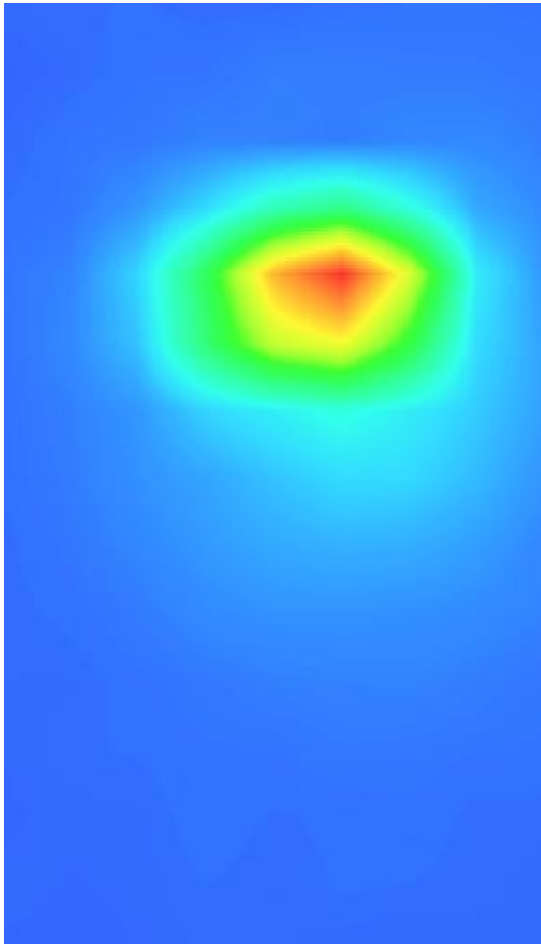
3D screen shot	Hot spot position
	

ANNEX D: Calibration Certificate



COMOSAR E-Field Probe Calibration Report

Ref : ACR.332.1.17.SATU.A

**CCIC SOUTHERN ELECTRONIC PRODUCT
TESTING (SHENZHEN) CO., LTD**
ELECTRONIC TESTING BUILDING, NO. 43 SHAHE ROAD,
XILI JIEDAO, NANSHAN DISTRICT
SHENZHEN, GUANGDONG, CHINA
MVG COMOSAR DOSIMETRIC E-FIELD PROBE
SERIAL NO.: SN 43/15 EP276

Calibrated at MVG US
2105 Barrett Park Dr. - Kennesaw, GA 30144



Calibration Date: 11/27/17

Summary:

This document presents the method and results from an accredited COMOSAR Dosimetric E-Field Probe calibration performed in MVG USA using the CALISAR / CALIBAIR test bench, for use with a COMOSAR system only. All calibration results are traceable to national metrology institutions.



COMOSAR E-FIELD PROBE CALIBRATION REPORT

Ref: ACR.332.1.17.SATU.A

	<i>Name</i>	<i>Function</i>	<i>Date</i>	<i>Signature</i>
<i>Prepared by :</i>	Jérôme LUC	Product Manager	11/28/2017	<i>JS</i>
<i>Checked by :</i>	Jérôme LUC	Product Manager	11/28/2017	<i>JS</i>
<i>Approved by :</i>	Kim RUTKOWSKI	Quality Manager	11/28/2017	<i>Kim Rutkowski</i>

	<i>Customer Name</i>
<i>Distribution :</i>	CCIC SOUTHERN ELECTRONIC PRODUCT TESTING (SHENZHEN) Co., Ltd

<i>Issue</i>	<i>Date</i>	<i>Modifications</i>
A	11/28/2017	Initial release

*This document shall not be reproduced, except in full or in part, without the written approval of MVG.
The information contained herein is to be used only for the purpose for which it is submitted and is not to be released in whole or part without written approval of MVG.*



TABLE OF CONTENTS

1	Device Under Test	4
2	Product Description	4
2.1	General Information	4
3	Measurement Method	4
3.1	Linearity	4
3.2	Sensitivity	5
3.3	Lower Detection Limit	5
3.4	Isotropy	5
3.5	Boundary Effect	5
4	Measurement Uncertainty	5
5	Calibration Measurement Results	6
5.1	Sensitivity in air	6
5.2	Linearity	7
5.3	Sensitivity in liquid	7
5.4	Isotropy	8
6	List of Equipment	9

Page: 3/9

*This document shall not be reproduced, except in full or in part, without the written approval of MVG.
The information contained herein is to be used only for the purpose for which it is submitted and is not to
be released in whole or part without written approval of MVG.*



1 DEVICE UNDER TEST

Device Under Test	
Device Type	COMOSAR DOSIMETRIC E FIELD PROBE
Manufacturer	MVG
Model	SSE5
Serial Number	SN 43/15 EP276
Product Condition (new / used)	Used
Frequency Range of Probe	0.7 GHz-3GHz
Resistance of Three Dipoles at Connector	Dipole 1: $R1=0.213 \text{ M}\Omega$ Dipole 2: $R2=0.208 \text{ M}\Omega$ Dipole 3: $R3=0.213 \text{ M}\Omega$

A yearly calibration interval is recommended.

2 PRODUCT DESCRIPTION

2.1 GENERAL INFORMATION

MVG's COMOSAR E field Probes are built in accordance to the IEEE 1528, OET 65 Bulletin C and CEI/IEC 62209 standards.



Figure 1 – MVG COMOSAR Dosimetric E field Dipole

Probe Length	330 mm
Length of Individual Dipoles	4.5 mm
Maximum external diameter	8 mm
Probe Tip External Diameter	5 mm
Distance between dipoles / probe extremity	2.7 mm

3 MEASUREMENT METHOD

The IEEE 1528, OET 65 Bulletin C, CENELEC EN50361 and CEI/IEC 62209 standards provide recommended practices for the probe calibrations, including the performance characteristics of interest and methods by which to assess their affect. All calibrations / measurements performed meet the fore mentioned standards.

3.1 LINEARITY

The evaluation of the linearity was done in free space using the waveguide, performing a power sweep to cover the SAR range 0.01W/kg to 100W/kg.

Page: 4/9

*This document shall not be reproduced, except in full or in part, without the written approval of MVG.
The information contained herein is to be used only for the purpose for which it is submitted and is not to be released in whole or part without written approval of MVG.*



3.2 SENSITIVITY

The sensitivity factors of the three dipoles were determined using a two step calibration method (air and tissue simulating liquid) using waveguides as outlined in the standards.

3.3 LOWER DETECTION LIMIT

The lower detection limit was assessed using the same measurement set up as used for the linearity measurement. The required lower detection limit is 10 mW/kg.

3.4 ISOTROPY

The axial isotropy was evaluated by exposing the probe to a reference wave from a standard dipole with the dipole mounted under the flat phantom in the test configuration suggested for system validations and checks. The probe was rotated along its main axis from 0 - 360 degrees in 15 degree steps. The hemispherical isotropy is determined by inserting the probe in a thin plastic box filled with tissue-equivalent liquid, with the plastic box illuminated with the fields from a half wave dipole. The dipole is rotated about its axis (0°–180°) in 15° increments. At each step the probe is rotated about its axis (0°–360°).

3.5 BOUNDARY EFFECT

The boundary effect is defined as the deviation between the SAR measured data and the expected exponential decay in the liquid when the probe is oriented normal to the interface. To evaluate this effect, the liquid filled flat phantom is exposed to fields from either a reference dipole or waveguide. With the probe normal to the phantom surface, the peak spatial average SAR is measured and compared to the analytical value at the surface.

4 MEASUREMENT UNCERTAINTY

The guidelines outlined in the IEEE 1528, OET 65 Bulletin C, CENELEC EN50361 and CEI/IEC 62209 standards were followed to generate the measurement uncertainty associated with an E-field probe calibration using the waveguide technique. All uncertainties listed below represent an expanded uncertainty expressed at approximately the 95% confidence level using a coverage factor of $k=2$, traceable to the Internationally Accepted Guides to Measurement Uncertainty.

Uncertainty analysis of the probe calibration in waveguide					
ERROR SOURCES	Uncertainty value (%)	Probability Distribution	Divisor	ci	Standard Uncertainty (%)
Incident or forward power	3.00%	Rectangular	$\sqrt{3}$	1	1.732%
Reflected power	3.00%	Rectangular	$\sqrt{3}$	1	1.732%
Liquid conductivity	5.00%	Rectangular	$\sqrt{3}$	1	2.887%
Liquid permittivity	4.00%	Rectangular	$\sqrt{3}$	1	2.309%
Field homogeneity	3.00%	Rectangular	$\sqrt{3}$	1	1.732%
Field probe positioning	5.00%	Rectangular	$\sqrt{3}$	1	2.887%

Page: 5/9

*This document shall not be reproduced, except in full or in part, without the written approval of MVG.
The information contained herein is to be used only for the purpose for which it is submitted and is not to be released in whole or part without written approval of MVG.*



COMOSAR E-FIELD PROBE CALIBRATION REPORT

Ref: ACR.332.1.17.SATU.A

Field probe linearity	3.00%	Rectangular	$\sqrt{3}$	1	1.732%
Combined standard uncertainty					5.831%
Expanded uncertainty 95 % confidence level k = 2					12.0%

5 CALIBRATION MEASUREMENT RESULTS

Calibration Parameters	
Liquid Temperature	21 °C
Lab Temperature	21 °C
Lab Humidity	45 %

5.1 SENSITIVITY IN AIR

Normx dipole 1 ($\mu\text{V}/(\text{V}/\text{m})^2$)	Normy dipole 2 ($\mu\text{V}/(\text{V}/\text{m})^2$)	Normz dipole 3 ($\mu\text{V}/(\text{V}/\text{m})^2$)
5.51	5.53	6.41

DCP dipole 1 (mV)	DCP dipole 2 (mV)	DCP dipole 3 (mV)
95	95	95

Calibration curves $e_i=f(V)$ ($i=1,2,3$) allow to obtain H-field value using the formula:

$$E = \sqrt{E_1^2 + E_2^2 + E_3^2}$$

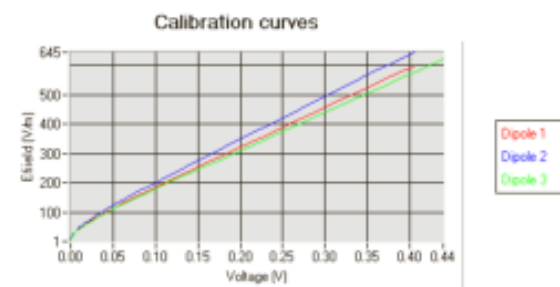

Page: 6/9

*This document shall not be reproduced, except in full or in part, without the written approval of MVG.
The information contained herein is to be used only for the purpose for which it is submitted and is not to be released in whole or part without written approval of MVG.*



5.2 LINEARITY

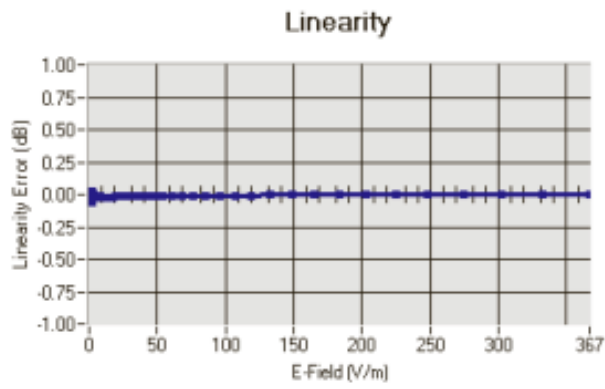

Linearity $\pm 1.50\%$ ($\pm 0.07\text{dB}$)

5.3 SENSITIVITY IN LIQUID

Liquid	Frequency (MHz +/- 100MHz)	Permittivity	Epsilon (S/m)	ConvF
HL750	750	42.09	0.91	4.80
BL750	750	55.69	0.95	4.94
HL850	835	42.71	0.89	4.99
BL850	835	57.52	1.03	5.18
HL900	900	41.94	0.93	4.95
BL900	900	52.87	1.09	5.14
HL1800	1800	40.62	1.39	4.29
BL1800	1800	53.22	1.47	4.43
HL1900	1900	41.22	1.37	4.73
BL1900	1900	50.99	1.52	4.83
HL2000	2000	40.39	1.36	4.56
BL2000	2000	54.39	1.54	4.69
HL2300	2300	38.10	1.74	4.59
BL2300	2300	53.33	1.86	4.77
HL2450	2450	40.46	1.87	4.46
BL2450	2450	54.62	1.95	4.61
HL2600	2600	38.46	2.01	4.16
BL2600	2600	51.98	2.16	4.28

LOWER DETECTION LIMIT: 7mW/kg

Page: 7/9

This document shall not be reproduced, except in full or in part, without the written approval of MVG. The information contained herein is to be used only for the purpose for which it is submitted and is not to be released in whole or part without written approval of MVG.



5.4 ISOTROPY

HL900 MHz

- Axial isotropy: 0.04 dB
- Hemispherical isotropy: 0.07 dB

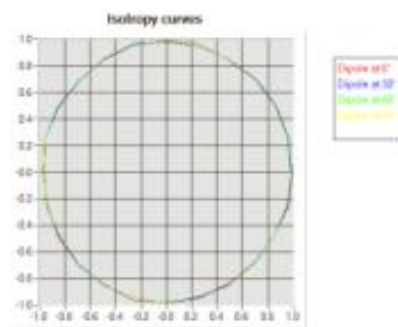

HL1800 MHz

- Axial isotropy: 0.04 dB
- Hemispherical isotropy: 0.08 dB

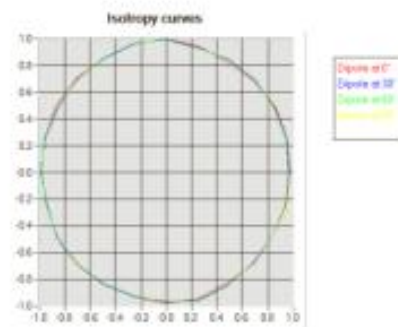

Page: 8/9

*This document shall not be reproduced, except in full or in part, without the written approval of MYG.
The information contained herein is to be used only for the purpose for which it is submitted and is not to be released in whole or part without written approval of MYG.*



6 LIST OF EQUIPMENT

Equipment Summary Sheet				
Equipment Description	Manufacturer / Model	Identification No.	Current Calibration Date	Next Calibration Date
Flat Phantom	MVG	SN-20/09-SAM71	Validated. No cal required.	Validated. No cal required.
COMOSAR Test Bench	Version 3	NA	Validated. No cal required.	Validated. No cal required.
Network Analyzer	Rhode & Schwarz ZVA	SN100132	02/2016	02/2019
Reference Probe	MVG	EP 94 SN 37/08	10/2017	10/2018
Multimeter	Keithley 2000	1188656	01/2017	01/2020
Signal Generator	Agilent E4438C	MY49070581	01/2017	01/2020
Amplifier	Aethercomm	SN 046	Characterized prior to test. No cal required.	Characterized prior to test. No cal required.
Power Meter	HP E4418A	US38261498	01/2017	01/2020
Power Sensor	HP ECP-E26A	US37181460	01/2017	01/2020
Directional Coupler	Narda 4216-20	01386	Characterized prior to test. No cal required.	Characterized prior to test. No cal required.
Waveguide	Mega Industries	069Y7-158-13-712	Validated. No cal required.	Validated. No cal required.
Waveguide Transition	Mega Industries	069Y7-158-13-701	Validated. No cal required.	Validated. No cal required.
Waveguide Termination	Mega Industries	069Y7-158-13-701	Validated. No cal required.	Validated. No cal required.
Temperature / Humidity Sensor	Control Company	150798832	11/2017	11/2020

Page: 9/9

*This document shall not be reproduced, except in full or in part, without the written approval of MVG.
The information contained herein is to be used only for the purpose for which it is submitted and is not to be released in whole or part without written approval of MVG.*



SAR Reference Dipole Calibration Report

Ref : ACR.332.9.17.SATU.A

**CCIC SOUTHERN ELECTRONIC PRODUCT
TESTING (SHENZHEN) CO., LTD**
ELECTRONIC TESTING BUILDING, NO. 43 SHAHE ROAD,
XILI JIEDAO, NANSHAN DISTRICT
SHENZHEN, GUANGDONG, CHINA
MVG COMOSAR REFERENCE DIPOLE
FREQUENCY: 2450 MHZ
SERIAL NO.: SN 09/13 DIP 2G450-220

Calibrated at MVG US
2105 Barrett Park Dr. - Kennesaw, GA 30144



Calibration Date: 11/27/17

Summary:

This document presents the method and results from an accredited SAR reference dipole calibration performed in MVG USA using the COMOSAR test bench. All calibration results are traceable to national metrology institutions.



SAR REFERENCE DIPOLE CALIBRATION REPORT

Ref: ACR.332.9.17.SATU.A

	<i>Name</i>	<i>Function</i>	<i>Date</i>	<i>Signature</i>
<i>Prepared by :</i>	Jérôme LUC	Product Manager	11/28/2017	<i>JS</i>
<i>Checked by :</i>	Jérôme LUC	Product Manager	11/28/2017	<i>JS</i>
<i>Approved by :</i>	Kim RUTKOWSKI	Quality Manager	11/28/2017	<i>Kim Rutkowski</i>

	<i>Customer Name</i>
<i>Distribution :</i>	CCIC SOUTHERN ELECTRONIC PRODUCT TESTING (SHENZHEN) Co., Ltd

<i>Issue</i>	<i>Date</i>	<i>Modifications</i>
A	11/28/2017	Initial release

Page: 2/11

*This document shall not be reproduced, except in full or in part, without the written approval of MVG.
The information contained herein is to be used only for the purpose for which it is submitted and is not to
be released in whole or part without written approval of MVG.*



TABLE OF CONTENTS

1 Introduction..... 4

2 Device Under Test 4

3 Product Description 4

 3.1 General Information 4

4 Measurement Method 5

 4.1 Return Loss Requirements 5

 4.2 Mechanical Requirements 5

5 Measurement Uncertainty 5

 5.1 Return Loss 5

 5.2 Dimension Measurement 5

 5.3 Validation Measurement 5

6 Calibration Measurement Results 6

 6.1 Return Loss and Impedance In Head Liquid 6

 6.2 Return Loss and Impedance In Body Liquid 6

 6.3 Mechanical Dimensions 6

7 Validation measurement 7

 7.1 Head Liquid Measurement 7

 7.2 SAR Measurement Result With Head Liquid 8

 7.3 Body Liquid Measurement 9

 7.4 SAR Measurement Result With Body Liquid 10

8 List of Equipment 11

This document shall not be reproduced, except in full or in part, without the written approval of MVG. The information contained herein is to be used only for the purpose for which it is submitted and is not to be released in whole or part without written approval of MVG.



1 INTRODUCTION

This document contains a summary of the requirements set forth by the IEEE 1528, FCC KDBs and CEI/IEC 62209 standards for reference dipoles used for SAR measurement system validations and the measurements that were performed to verify that the product complies with the fore mentioned standards.

2 DEVICE UNDER TEST

Device Under Test	
Device Type	COMOSAR 2450 MHz REFERENCE DIPOLE
Manufacturer	MVG
Model	SID2450
Serial Number	SN 09/13 DIP 2G450-220
Product Condition (new / used)	Used

A yearly calibration interval is recommended.

3 PRODUCT DESCRIPTION

3.1 GENERAL INFORMATION

MVG's COMOSAR Validation Dipoles are built in accordance to the IEEE 1528, FCC KDBs and CEI/IEC 62209 standards. The product is designed for use with the COMOSAR test bench only.



Figure 1 – MVG COMOSAR Validation Dipole

Page: 4/11

This document shall not be reproduced, except in full or in part, without the written approval of MVG. The information contained herein is to be used only for the purpose for which it is submitted and is not to be released in whole or part without written approval of MVG.



4 MEASUREMENT METHOD

The IEEE 1528, FCC KDBs and CEI/IEC 62209 standards provide requirements for reference dipoles used for system validation measurements. The following measurements were performed to verify that the product complies with the fore mentioned standards.

4.1 RETURN LOSS REQUIREMENTS

The dipole used for SAR system validation measurements and checks must have a return loss of -20 dB or better. The return loss measurement shall be performed against a liquid filled flat phantom, with the phantom constructed as outlined in the fore mentioned standards.

4.2 MECHANICAL REQUIREMENTS

The IEEE Std. 1528 and CEI/IEC 62209 standards specify the mechanical components and dimensions of the validation dipoles, with the dimensions frequency and phantom shell thickness dependent. The COMOSAR test bench employs a 2 mm phantom shell thickness therefore the dipoles sold for use with the COMOSAR test bench comply with the requirements set forth for a 2 mm phantom shell thickness.

5 MEASUREMENT UNCERTAINTY

All uncertainties listed below represent an expanded uncertainty expressed at approximately the 95% confidence level using a coverage factor of $k=2$, traceable to the Internationally Accepted Guides to Measurement Uncertainty.

5.1 RETURN LOSS

The following uncertainties apply to the return loss measurement:

Frequency band	Expanded Uncertainty on Return Loss
400-6000MHz	0.1 dB

5.2 DIMENSION MEASUREMENT

The following uncertainties apply to the dimension measurements:

Length (mm)	Expanded Uncertainty on Length
3 - 300	0.05 mm

5.3 VALIDATION MEASUREMENT

The guidelines outlined in the IEEE 1528, FCC KDBs, CENELEC EN50361 and CEI/IEC 62209 standards were followed to generate the measurement uncertainty for validation measurements.

Scan Volume	Expanded Uncertainty
1 g	20.3 %

Page: 5/11

*This document shall not be reproduced, except in full or in part, without the written approval of MVG.
The information contained herein is to be used only for the purpose for which it is submitted and is not to be released in whole or part without written approval of MVG.*



10 g	20.1 %
------	--------

6 CALIBRATION MEASUREMENT RESULTS

6.1 RETURN LOSS AND IMPEDANCE IN HEAD LIQUID

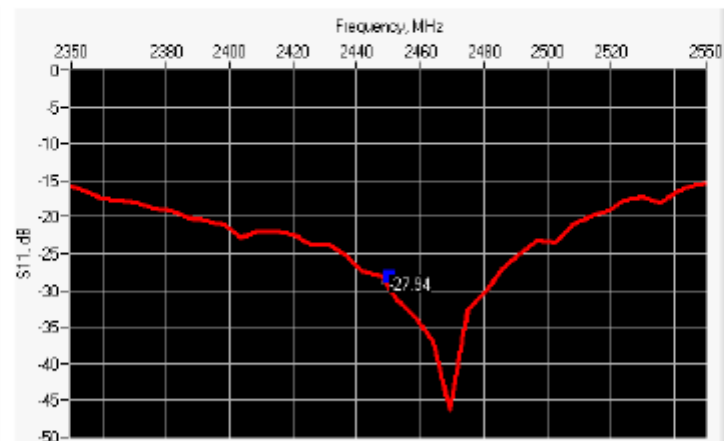

Frequency (MHz)	Return Loss (dB)	Requirement (dB)	Impedance
2450	-27.94	-20	$49.5 \Omega + 3.9 j\Omega$

6.2 RETURN LOSS AND IMPEDANCE IN BODY LIQUID

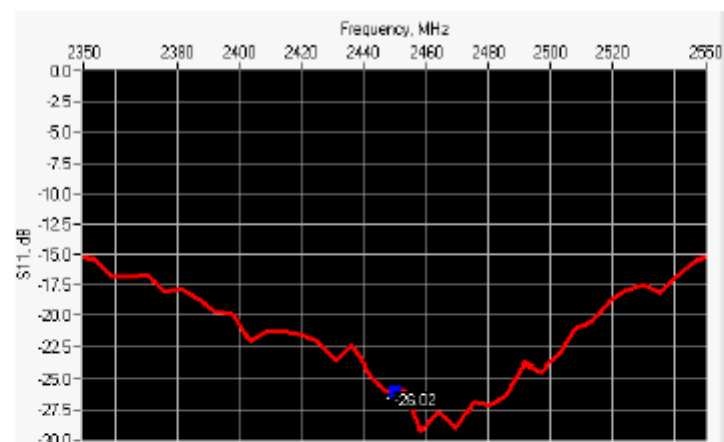

Frequency (MHz)	Return Loss (dB)	Requirement (dB)	Impedance
2450	-26.02	-20	$53.2 \Omega + 4.0 j\Omega$

6.3 MECHANICAL DIMENSIONS

Frequency MHz	L mm		h mm		d mm	
	required	measured	required	measured	required	measured
300	420.0 ± 1 %		250.0 ± 1 %		6.35 ± 1 %	

Page: 6/11

This document shall not be reproduced, except in full or in part, without the written approval of MVG. The information contained herein is to be used only for the purpose for which it is submitted and is not to be released in whole or part without written approval of MVG.

SAR REFERENCE DIPOLE CALIBRATION REPORT

Ref: ACR.332.9.17.SATU.A

450	290.0 ±1 %		166.7 ±1 %		6.35 ±1 %	
750	176.0 ±1 %		100.0 ±1 %		6.35 ±1 %	
835	161.0 ±1 %		89.8 ±1 %		3.6 ±1 %	
900	149.0 ±1 %		83.3 ±1 %		3.6 ±1 %	
1450	89.1 ±1 %		51.7 ±1 %		3.6 ±1 %	
1500	80.5 ±1 %		50.0 ±1 %		3.6 ±1 %	
1640	79.0 ±1 %		45.7 ±1 %		3.6 ±1 %	
1750	75.2 ±1 %		42.9 ±1 %		3.6 ±1 %	
1800	72.0 ±1 %		41.7 ±1 %		3.6 ±1 %	
1900	68.0 ±1 %		39.5 ±1 %		3.6 ±1 %	
1950	66.3 ±1 %		38.5 ±1 %		3.6 ±1 %	
2000	64.5 ±1 %		37.5 ±1 %		3.6 ±1 %	
2100	61.0 ±1 %		35.7 ±1 %		3.6 ±1 %	
2300	55.5 ±1 %		32.6 ±1 %		3.6 ±1 %	
2450	51.5 ±1 %	PASS	30.4 ±1 %	PASS	3.6 ±1 %	PASS
2600	48.5 ±1 %		28.8 ±1 %		3.6 ±1 %	
3000	41.5 ±1 %		25.0 ±1 %		3.6 ±1 %	
3500	37.0 ±1 %		26.4 ±1 %		3.6 ±1 %	
3700	34.7 ±1 %		26.4 ±1 %		3.6 ±1 %	

7 VALIDATION MEASUREMENT

The IEEE Std. 1528, FCC KDBs and CEI/IEC 62209 standards state that the system validation measurements must be performed using a reference dipole meeting the fore mentioned return loss and mechanical dimension requirements. The validation measurement must be performed against a liquid filled flat phantom, with the phantom constructed as outlined in the fore mentioned standards. Per the standards, the dipole shall be positioned below the bottom of the phantom, with the dipole length centered and parallel to the longest dimension of the flat phantom, with the top surface of the dipole at the described distance from the bottom surface of the phantom.

7.1 HEAD LIQUID MEASUREMENT

Frequency MHz	Relative permittivity (ϵ_r')		Conductivity (σ) S/m	
	required	measured	required	measured
300	45.3 ±5 %		0.87 ±5 %	
450	43.5 ±5 %		0.87 ±5 %	
750	41.9 ±5 %		0.89 ±5 %	
835	41.5 ±5 %		0.90 ±5 %	
900	41.5 ±5 %		0.97 ±5 %	
1450	40.5 ±5 %		1.20 ±5 %	
1500	40.4 ±5 %		1.23 ±5 %	
1640	40.2 ±5 %		1.31 ±5 %	
1750	40.1 ±5 %		1.37 ±5 %	

Page: 7/11

This document shall not be reproduced, except in full or in part, without the written approval of MVG. The information contained herein is to be used only for the purpose for which it is submitted and is not to be released in whole or part without written approval of MVG.



SAR REFERENCE DIPOLE CALIBRATION REPORT

Ref: ACR.332.9.17.SATU.A

1800	40.0 ±5 %		1.40 ±5 %	
1900	40.0 ±5 %		1.40 ±5 %	
1950	40.0 ±5 %		1.40 ±5 %	
2000	40.0 ±5 %		1.40 ±5 %	
2100	39.8 ±5 %		1.49 ±5 %	
2300	39.5 ±5 %		1.67 ±5 %	
2450	39.2 ±5 %	PASS	1.80 ±5 %	PASS
2600	39.0 ±5 %		1.96 ±5 %	
3000	38.5 ±5 %		2.40 ±5 %	
3500	37.9 ±5 %		2.91 ±5 %	

7.2 SAR MEASUREMENT RESULT WITH HEAD LIQUID

The IEEE Std. 1528 and CEI/IEC 62209 standards state that the system validation measurements should produce the SAR values shown below (for phantom thickness of 2 mm), within the uncertainty for the system validation. All SAR values are normalized to 1 W forward power. In bracket, the measured SAR is given with the used input power.

Software	OPENSAR V4
Phantom	SN 20/09 SAM71
Probe	SN 18/11 EPG122
Liquid	Head Liquid Values: ϵ_{ps} : 40.5 σ : 1.87
Distance between dipole center and liquid	10.0 mm
Area scan resolution	dx=8mm/dy=8mm
Zoon Scan Resolution	dx=5mm/dy=5mm/dz=5mm
Frequency	2450 MHz
Input power	20 dBm
Liquid Temperature	21 °C
Lab Temperature	21 °C
Lab Humidity	45 %

Frequency MHz	1 g SAR (W/kg/W)		10 g SAR (W/kg/W)	
	required	measured	required	measured
300	2.85		1.94	
450	4.58		3.06	
750	8.49		5.55	
835	9.56		6.22	
900	10.9		6.99	
1450	29		16	
1500	30.5		16.8	
1640	34.2		18.4	
1750	36.4		19.3	
1800	38.4		20.1	

Page: 8/11

*This document shall not be reproduced, except in full or in part, without the written approval of MVG.
The information contained herein is to be used only for the purpose for which it is submitted and is not to be released in whole or part without written approval of MVG.*



SAR REFERENCE DIPOLE CALIBRATION REPORT

Ref: ACR.332.9.17.SATU.A

1900	39.7		20.5	
1950	40.5		20.9	
2000	41.1		21.1	
2100	43.6		21.9	
2300	48.7		23.3	
2450	52.4	52.67 (5.27)	24	23.76 (2.38)
2600	55.3		24.6	
3000	63.8		25.7	
3500	67.1		25	
3700	67.4		24.2	

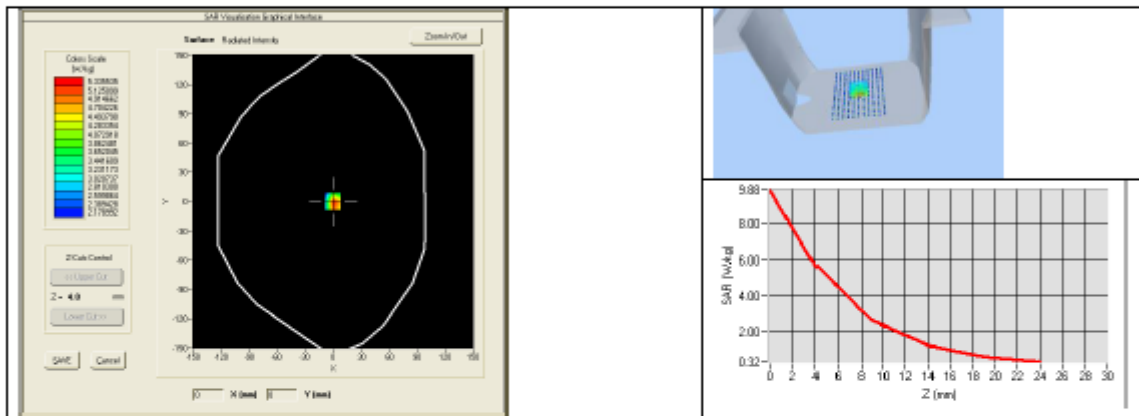

7.3 BODY LIQUID MEASUREMENT

Frequency MHz	Relative permittivity (ϵ_r)		Conductivity (σ) S/m	
	required	measured	required	measured
150	61.9 ± 5 %		0.80 ± 5 %	
300	58.2 ± 5 %		0.92 ± 5 %	
450	56.7 ± 5 %		0.94 ± 5 %	
750	55.5 ± 5 %		0.96 ± 5 %	
835	55.2 ± 5 %		0.97 ± 5 %	
900	55.0 ± 5 %		1.05 ± 5 %	
915	55.0 ± 5 %		1.06 ± 5 %	
1450	54.0 ± 5 %		1.30 ± 5 %	
1610	53.8 ± 5 %		1.40 ± 5 %	
1800	53.3 ± 5 %		1.52 ± 5 %	
1900	53.3 ± 5 %		1.52 ± 5 %	
2000	53.3 ± 5 %		1.52 ± 5 %	
2100	53.2 ± 5 %		1.62 ± 5 %	
2300	52.9 ± 5 %		1.81 ± 5 %	

Page: 9/11

This document shall not be reproduced, except in full or in part, without the written approval of MVG. The information contained herein is to be used only for the purpose for which it is submitted and is not to be released in whole or part without written approval of MVG.



SAR REFERENCE DIPOLE CALIBRATION REPORT

Ref: ACR.332.9.17.SATUA

2450	52.7 ±5 %	PASS	1.95 ±5 %	PASS
2600	52.5 ±5 %		2.16 ±5 %	
3000	52.0 ±5 %		2.73 ±5 %	
3500	51.3 ±5 %		3.31 ±5 %	
3700	51.0 ±5 %		3.55 ±5 %	
5200	49.0 ±10 %		5.30 ±10 %	
5300	48.9 ±10 %		5.42 ±10 %	
5400	48.7 ±10 %		5.53 ±10 %	
5500	48.6 ±10 %		5.65 ±10 %	
5600	48.5 ±10 %		5.77 ±10 %	
5800	48.2 ±10 %		6.00 ±10 %	

7.4 SAR MEASUREMENT RESULT WITH BODY LIQUID

Software	OPENSAR V4
Phantom	SN 20/09 SAM71
Probe	SN 18/11 EPG122
Liquid	Body Liquid Values: eps' : 54.6 sigma : 1.95
Distance between dipole center and liquid	10.0 mm
Area scan resolution	dx=8mm/dy=8mm
Zoon Scan Resolution	dx=5mm/dy=5mm/dz=5mm
Frequency	2450 MHz
Input power	20 dBm
Liquid Temperature	21 °C
Lab Temperature	21 °C
Lab Humidity	45 %

Frequency MHz	1 g SAR (W/kg/W)	10 g SAR (W/kg/W)
	measured	measured
2450	51.42 (5.14)	23.48 (2.35)

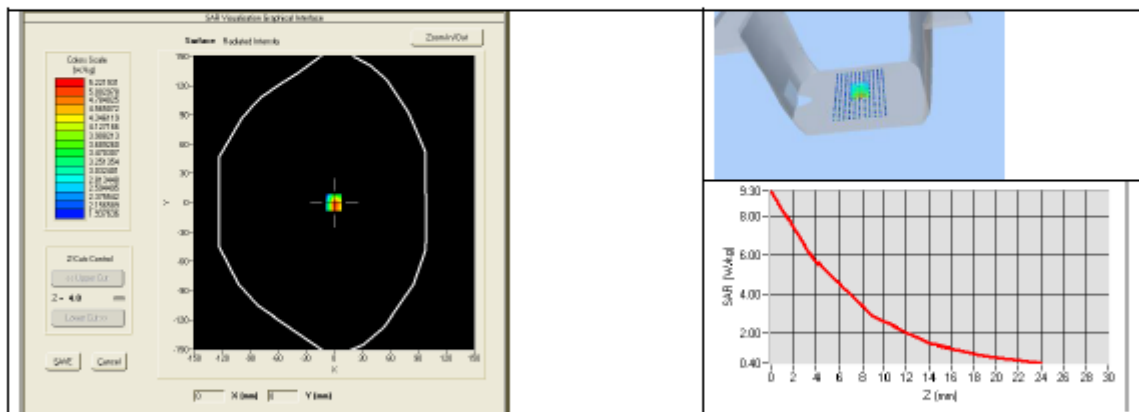

This document shall not be reproduced, except in full or in part, without the written approval of MVG. The information contained herein is to be used only for the purpose for which it is submitted and is not to be released in whole or part without written approval of MVG.



8 LIST OF EQUIPMENT

Equipment Summary Sheet				
Equipment Description	Manufacturer / Model	Identification No.	Current Calibration Date	Next Calibration Date
SAM Phantom	MVG	SN-20/09-SAM71	Validated. No cal required.	Validated. No cal required.
COMOSAR Test Bench	Version 3	NA	Validated. No cal required.	Validated. No cal required.
Network Analyzer	Rhode & Schwarz ZVA	SN100132	02/2016	02/2019
Calipers	Carrera	CALIPER-01	01/2017	01/2020
Reference Probe	MVG	EPG122 SN 18/11	10/2017	10/2018
Multimeter	Keithley 2000	1188656	01/2017	01/2020
Signal Generator	Agilent E4438C	MY49070581	01/2017	01/2020
Amplifier	Aethercomm	SN 046	Characterized prior to test. No cal required.	Characterized prior to test. No cal required.
Power Meter	HP E4418A	US38261498	01/2017	01/2020
Power Sensor	HP ECP-E26A	US37181460	01/2017	01/2020
Directional Coupler	Narda 4216-20	01386	Characterized prior to test. No cal required.	Characterized prior to test. No cal required.
Temperature and Humidity Sensor	Control Company	150798832	11/2017	11/2020

Page: 11/11

*This document shall not be reproduced, except in full or in part, without the written approval of MVG.
The information contained herein is to be used only for the purpose for which it is submitted and is not to be released in whole or part without written approval of MVG.*

—End of the Report—