

Gantner Electronic **TEST REPORT**

SCOPE OF WORK

RADIO TESTING FCC – GAT ECO.SIDE LOCK 7000 NW BA

REPORT NUMBER

2231426KAU-013b

ISSUE DATE

26-February-2018

PAGES

23

DOCUMENT CONTROL NUMBER

R_FCC 15-225_18-01 (25-January-2018)

© 2017 INTERTEK



MODEL: GAT ECO.Side Lock 7000
TYPE: NW BA
DESCRIPTION: Electronic battery lock with Legic[®] Advant technologie and wireless interface (Bluetooth)
SERIAL NO: 1734040067
1734040076 (Radiated emission 30 MHz- 1 GHz)

All measurement results refer to the equipment which was tested

MANUFACTURER: Gantner Electronic GmbH
CUSTOMER NAME: Gantner Electronic GmbH
ADDRESS (CUSTOMER): Montafonerstrasse 8
AT-6780 SCHRUNS
AUSTRIA

REPORT NO: 2231426KAU-013b

TEST RESULT: The equipment complies to 47 CFR Part 15, Subpart C, Intentional radiators, section 15.225 / RSS-210, Issue 9 and RSS-GEN, Issue 4 (Referring to the operating modes specified in this report).

TEST LABORATORY: Intertek Deutschland GmbH
Innovapark 20, 87600 Kaufbeuren
Germany

FCC DESIGNATION NUMBER: DE0014

FCC TEST FIRM REGISTRATION NUMBER. 359260

INDUSTRY CANADA REGISTRATION. 8882A-1; 8882A-2

TEST ENGINEER: R. Dressler
Technical Manager EMC/ Radio

REVIEWER: U. Gronert
Senior Project Engineer







Details about Accreditations/Acceptances

EMC / Radio National

	<p>The Intertek Deutschland EMC-Lab is accredited by the Deutsche Akkreditierungsstelle GmbH (DAkKS)</p>
	<p>Registration Number (EMC general): D-PL-12085-01-01</p>
	<p>Registration Number (EMC Med): D-PL-12085-01-03</p>

International

	<p>The Intertek Deutschland EMC-Lab is accepted to participate in the IECEE (IEC Conformity assessment for Electrotechnical Equipment and Components) CB-Scheme</p> <p>CB Test Laboratory: TL118</p>
	<p>The Intertek Deutschland EMC-Lab is listed at the Federal Communications Commission (FCC)</p> <p>Designation Number: DE0014</p> <p>Test Firm Registration Number: 359260</p>
	<p>The <i>Bundesnetzagentur</i> recognizes Intertek Deutschland GmbH as Conformity Assessment Body in the sector electromagnetic compatibility (EMC).</p>
	<p>The Intertek Deutschland EMC-Lab is listed at Industry Canada No. 8882A-1 (OATS) and 8882A-2 (3 m alternative test site)</p>

Automotive

 <p>Anerkennungsstelle</p> <p>Anerkannt unter KBA-P 00046-03</p>	<p>The Intertek Deutschland EMC-Lab is recognized as technical service of the Kraftfahrt-Bundesamt (KBA)</p> <p>Registration Number: KBA-P 00046-03</p>
---	--

SECTION 1
CONTENTS

SECTION 2	MEASUREMENT AND TEST SPECIFICATION	5
SECTION 3	GENERAL INFORMATION	6
SECTION 4	SUMMARY OF TESTING	7
4.1	General annotation.....	7
4.2	Measurement uncertainty.....	7
4.3	Document History.....	7
SECTION 5	TEST RESULTS – OVERVIEW	8
SECTION 6	INFORMATION ABOUT THE EUT	9
6.1	Description of the EUT.....	9
6.2	Power interface	10
6.3	Configuration mode.....	10
6.4	Operation mode.....	10
6.5	Peripheral devices used for testing	10
6.6	Supply and interconnecting cables used for testing.....	10
6.7	Block diagram of the EUT.....	11
SECTION 7		12
7.1	Field strength 13.110 MHz – 14.010 MHz (Emission Mask)	12
7.2	Radiated emissions < 30 MHz	15
7.3	Radiated emissions 30 MHz to 1 GHz	18
7.4	Frequency stability measurement	21
7.5	Occupied bandwidth.....	22

SECTION 2

MEASUREMENT AND TEST SPECIFICATION

47 CFR Part 15, Subpart C, Intentional radiators, section 15.225 /
RSS-210, Issue 9 and RSS-GEN, Issue 4

Test methods in:

ANSI C63.10-2013: American National Standard for Testing Unlicensed Wireless Devices

No additions, deviations or exclusions have been made from standards and accreditation.

The test results detailed in this report apply only to the GAT ECO.Side Lock 7000 NW BA with the test setup described. Any modification such as a change, addition to or inclusion of another device into this product will require an additional evaluation.

The support equipment listed as part of the emission tests is required to properly exercise and test the device under test.

SECTION 3 GENERAL INFORMATION

Possible test case verdicts:

Test case does not apply to the test object: N/A (Not Applicable)

Test object does meet the requirement: P (Pass)

Test object does not meet the requirements: F (Fail)

Samples arrived: 2018-01-31

Testing: 2018-02-01 to 2018-02-21

Decimal separator: Point Comma

Environmental conditions during testing:

Temperature: 15 °C - 35 °C

Humidity: 20 % - 60 %

Atmospheric pressure: 900 mbar - 1000 mbar

If explicitly required by a basic standard the measured climatic conditions are documented in the corresponding test section.

Test sites:

Measurement Chamber	Type of chamber	IC Site filing #
ANECHOIC CHAMBER 1	Semi-anechoic 3 m	8882A-2

SECTION 4**SUMMARY OF TESTING****4.1 General annotation**

The tests were performed in the order of the right column in the “Test Results – Overview” table.

4.2 Measurement uncertainty

For each test method, an uncertainty evaluation was carried out. The results of the evaluation can be provided upon request from Intertek Deutschland GmbH.

4.3 Document History

REVISION	DATE	REPORT	CHANGES	AUTHOR
Initial release	2018-02-26	2231426KAU-013b	Initial issue	RDR

SECTION 5

TEST RESULTS – OVERVIEW

EMISSION	VERDICT	DATE	NO
Field strength (13.110 MHz – 14.010 MHz)	P	2018-02-15	3
Radiated emissions (< 30 MHz)	P	2018-02-15	2
Radiated emissions (30 MHz - 1 GHz)	P	2018-02-01	1
Frequency Stability Test	P	2018-02-21	5
Occupied bandwidth test	P	2018-02-20	4

Omission of tests:

Conducted emissions is not applicable, because the EUT is battery operated.

SECTION 6

INFORMATION ABOUT THE EUT

6.1 Description of the EUT

table-top EUT
 floor-standing EUT

Dimensions:	Height:	Width:	Length:
	100 mm	25 mm	125 mm

Software version: A special test firmware was written for the EMC/Radio tests, to have a continuous transmission. In reality the RFID and Bluetooth modules are just transmitting, when the lock button is pushed. They are never transmitting at the same time.

Product version: 2.3

Description: With the GAT ECO.Side Lock 7xxx (NW) xx, lockers and depot boxes can be electronically locked and unlocked. The user simply presses the locker door shut and holds their data carrier next to the RFID reading center on the locker door. This action activates the lock electronics and the authorization of the user's data carrier is checked. If the authorization is valid, the locker door is locked or unlocked by the GAT ECO.Side Lock 7xxx (NW) xx accordingly. System users are identified at the lock using contactless RFID data carriers (Radio Frequency Identification).

Transmitter frequency range: 13.56 MHz

Frequency agile or hopping:	<input type="checkbox"/> Yes	<input checked="" type="checkbox"/> No
Antenna:	<input checked="" type="checkbox"/> Internal antenna	<input type="checkbox"/> External antenna
Antenna connector:	<input checked="" type="checkbox"/> None, internal antenna	<input type="checkbox"/> Yes, type
Type of used TAG:	GAT Testcard Legic	
EUT - Temperature range:	-15°C to +55°C	
Transmitter stand by mode supported:	<input type="checkbox"/> Yes	<input checked="" type="checkbox"/> No

6.1.1 Photo/ Sketch of the rating plate



6.2 Power interface

MODE	VOLTAGE (V)	FREQUENCY (Hz)	COMMENT
1	3.6 V	DC	SIZE AA

Power sources/associated test equipment

DESCRIPTION	MANUFACTURER	TYPE	SN	ASSET NO.
Lithium battery	TADIRAN	High Energy, 3.6 V	-	-

6.3 Configuration mode

MODE	DESCRIPTION
1	A tag card was placed in front of the RFID reader

6.4 Operation mode

MODE	DESCRIPTION
1	Continuous transmission
2	Pulsing transmission with an interval of 80 ms

6.5 Peripheral devices used for testing

DEVICE	MANUFACTURER	TYPE	FID	FCC ID
GAT Testcard	Gantner	Legic	9999	-

6.6 Supply and interconnecting cables used for testing

LINE	LENGTH (cm)	SHIELDING
none		

6.7 Block diagram of the EUT

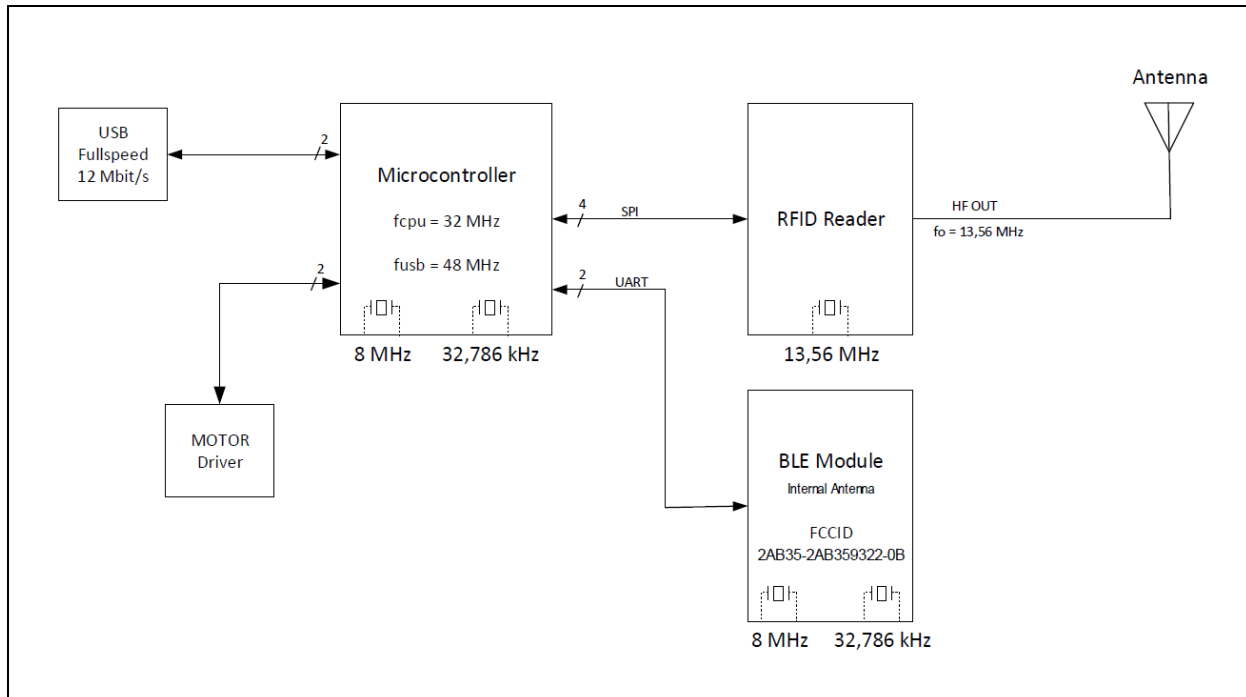

SECTION 7

7.1 Field strength 13.110 MHz – 14.010 MHz (Emission Mask)

NORMATIVE REFERENCES		RESULT
Limits according to:	FCC §15.225 (a) – (c) RSS-210, Issue 9, section B4	P
Methods of measurement according to:	ANSI C63.10, section 6.3, 6.4 RSS-Gen 6.13, 8.9	
Equipment mode	Power interface	1
	EUT configuration mode	1
	Operation mode	1
Test requirements	Frequency range	13.110 MHz – 14.010 MHz
	Measurement time	150 ms
	Class	B
	Antenna height	1 m

Limits

The limits below 30 MHz are given for different measurement distances. The limits below 30 MHz are converted to 3 m by using the extrapolation factor 40 dB/decade (according to §15.31).

Frequency (MHz)	Field strength (µV/m)	Field strength (dBµV/m)	Measurement distance (m)	Field strength (dBµV/m)	Measurement distance (m)
13.110 - 13.410	106	40.5	30	80.5	3
13.410 - 13.553	334	50.5	30	90.5	3
13.553 - 13.567	15848	84.0	30	124.0	3
13.567 - 13.710	334	50.5	30	90.5	3
13.710 - 14.010	106	40.5	30	80.5	3

Test setup details

Compliance with the spectrum mask is tested using a spectrum analyzer with resolution bandwidth set to 10 kHz or 9 kHz CISPR. The video bandwidth shall be at least three times greater than the resolution bandwidth.

The test was carried out automatically by the test receiver.

The EUT is a table-top EUT and was standing on a table made of Styrodur with a Pertinax plate on top and the dimensions 1.6 m x 1.0 m x 0.8 m (Length x Width x Height).

The emission limits shown in the above table are based on measurements employing a CISPR quasi-peak detector.

Test equipment

DESCRIPTION	MANUFACTURER	TYPE	SN	ASSET NO.	CALIBRATION
Semi-Anechoic chamber	Siepel	REF W460SLB	-	PM KF 1150-01	2016-12 (3 years)
Turntable	Inn-Co	-	-	PM KF 2949-04	-
Receiver 10 Hz - 7 GHz	Rohde & Schwarz	ESR7	101095	PM KF 2441	2017-10 (1 year)
Loop antenna 9 kHz- 30 MHz	Rohde & Schwarz	HFH2-Z2	881058/48	PM KF 1401	2017-10 (2 years)
Test software	Rohde & Schwarz	EMC 32 V.10.01.00	-	PM KF 2983-2	-

Measurement results – Field strength 13.110 MHz – 14.010 MHz (Emission Mask):

EUT: GAT ECO.Side Lock 7000 NW BA
 Test Verdict: pass
 Test Description: FCC 15.225 / RSS-210, RSS-Gen
 Operating Conditions: continuous field with tag
 Operator Name: RDR
 Project Number: 31426
 Date: 2018-02-15
 Comment: Ser.No.: 1734040067

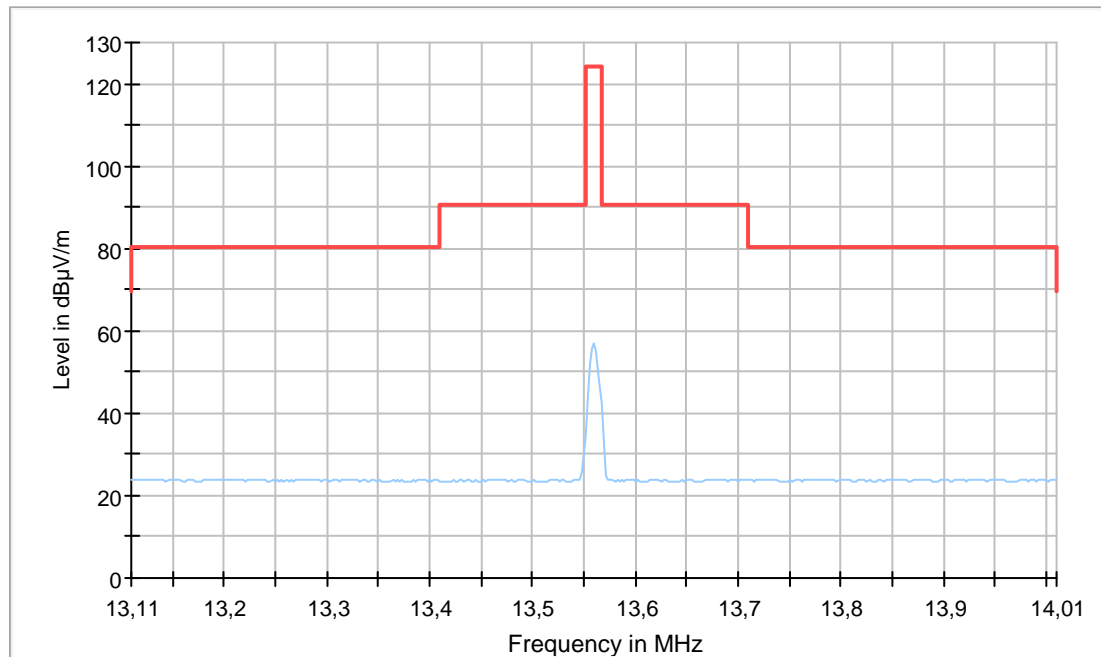

- Preview Result 2-AVG [Preview Result 2.Result:2]
- Preview Result 1-QPK [Preview Result 1.Result:1]
- * Critical_Freqs AVG [Critical_Freqs.Result:5]
- * Critical_Freqs QPK [Critical_Freqs.Result:4]
- FCC 15_225_9kHz_to_30MHz_d=3m [.\zF radiated\FCC Part 15C]
- ◆ Final_Result QPK [Final_Result.Result:4]
- ◆ Final_Result AVG [Final_Result.Result:5]

Frequency (MHz)	QuasiPeak (dBµV/m)	Limit (dBµV/m)	Margin (dB)	Meas. Time (ms)	Bandwidth (kHz)
13.56	57.5	124	66.5	1000	9

EMI Auto Test Template: zf-FCC-RE-R12-AN23

Hardware Setup: EN-RE-R12-AN23
 Measurement Type: Open-Area-Test-Site
 Frequency Range: 9 kHz - 30 MHz
 Graphics Level Range: 0 dB μ V/m - 130 dB μ V/m

Preview Measurements:

Antenna height: 0 - 1000 cm , Step Size = 0 cm , Positioning Speed = 1
 Polarization: H + V
 Turntable position: 0 - 352 deg , Step Size = 22 deg , Positioning Speed = 8
 Scan Test Template: zF-FCC-RE-R12-AN23_PRE

Subrange	Step Size	Detectors	IF BW	Meas. Time	Preamp
Receiver: [ESR 7]					
9 kHz - 90 kHz	50 Hz	AVG	200 Hz	1 s	0 dB
90 kHz - 110 kHz	50 Hz	QPK	200 Hz	1 s	0 dB
110 kHz - 150 kHz	50 Hz	AVG	200 Hz	1 s	0 dB
150 kHz - 490 kHz	2,25 kHz	AVG	9 kHz	1 s	0 dB
490 kHz - 30 MHz	2,25 kHz	QPK	9 kHz	1 s	0 dB

7.2 Radiated emissions < 30 MHz

NORMATIVE REFERENCES		RESULT
Limits according to:	FCC §15.225 (d), §15.209 RSS-210, Issue 9, section B4	P
Methods of measurement according to:	ANSI C63.10, section 6.3, 6.4 RSS-Gen 6.13, 8.9	
Equipment mode	Power interface	1
	EUT configuration mode	1
	Operation mode	1
Test requirements	Frequency range	9 kHz - 30 MHz
	Class	B
	Antenna height	1 m

Limits

The limits below 30 MHz are given for different measurement distances. The limits below 30 MHz are converted to 3 m by using the extrapolation factor 40 dB/decade (according to §15.31).

Frequency (MHz)	Field strength (µV/m)	Field strength (dBµV/m)	Measurement distance (m)
0.009 - 0.490	2400/F(kHz)	67.6 - 20 · log(F(kHz))	300
0.490 - 1.705	24000/F(kHz)	87.6 - 20 · log(F(kHz))	30
1.705 - 13.110	30	29.5	30
14.010 - 30.000	30	29.5	30

Additionally, the level of any unwanted emissions shall not exceed the level of the fundamental emission.

Test setup details

Compliance with the spectrum mask is tested using a spectrum analyzer with resolution bandwidth set to 10 kHz or 9 kHz CISPR. The video bandwidth shall be at least three times greater than the resolution bandwidth.

The test was carried out automatically by the test receiver.

The EUT is a table-top EUT and was standing on a table made of Styrodur with a Pertinax plate on top and the dimensions 1.6 m x 1.0 m x 0.8 m (Length x Width x Height).

The emission limits shown in the above table are based on measurements employing a CISPR quasi-peak detector except for the frequency bands 9-90 kHz, 110-490 kHz and above 1000 MHz. Radiated emission limits in these three bands are based on measurements employing an average detector.

Test equipment

DESCRIPTION	MANUFACTURER	TYPE	SN	ASSET NO.	CALIBRATION
Semi-Anechoic chamber	Siepel	REF W460SLB	-	PM KF 1150-01	2016-12 (3 years)
Turntable	Inn-Co	-	-	PM KF 2949-04	-
Receiver 10 Hz - 7 GHz	Rohde & Schwarz	ESR7	101095	PM KF 2441	2017-10 (1 year)
Loop antenna 9 kHz- 30 MHz	Rohde & Schwarz	HFH2-Z2	881058/48	PM KF 1401	2017-10 (2 years)
Test software	Rohde & Schwarz	EMC 32 V.10.01.00	-	PM KF 2983-2	-

Measurement results – Radiated emissions < 30 MHz:

EUT:	GAT ECO.Side Lock 7000 NW BA
Test Verdict:	pass
Test Description:	FCC 15.225 / RSS-210, RSS-Gen
Operating Conditions:	continuous field with tag
Operator Name:	RDR
Project Number:	31426
Date:	2018-02-15
Comment:	Ser.No.: 1734040067

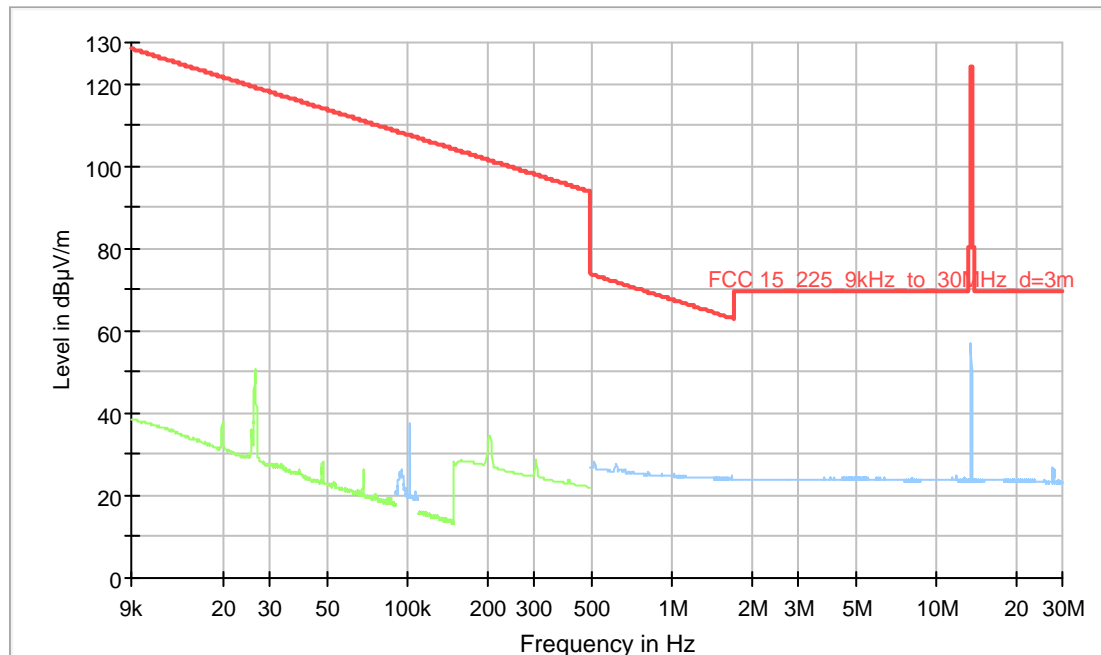

- Preview Result 2-AVG [Preview Result 2.Result:2]
- Preview Result 1-QPK [Preview Result 1.Result:1]
- * Critical_Freqs AVG [Critical_Freqs.Result:5]
- * Critical_Freqs QPK [Critical_Freqs.Result:4]
- FCC 15_225_9kHz_to_30MHz_d=3m [.\zF radiated\FCC Part 15C]
- ◆ Final_Result QPK [Final_Result.Result:4]
- ◆ Final_Result AVG [Final_Result.Result:5]

EMI Auto Test Template: zf-FCC-RE-R12-AN23

Hardware Setup: EN-RE-R12-AN23
 Measurement Type: Open-Area-Test-Site
 Frequency Range: 9 kHz - 30 MHz
 Graphics Level Range: 0 dB μ V/m - 130 dB μ V/m

Preview Measurements:
 Antenna height: 0 - 1000 cm , Step Size = 0 cm , Positioning Speed = 1
 Polarization: H + V
 Turntable position: 0 - 352 deg , Step Size = 22 deg , Positioning Speed = 8
 Scan Test Template: zf-FCC-RE-R12-AN23_PRE

Subrange	Step Size	Detectors	IF BW	Meas. Time	Preamp
Receiver: [ESR 7]					
9 kHz - 90 kHz	50 Hz	AVG	200 Hz	1 s	0 dB
90 kHz - 110 kHz	50 Hz	QPK	200 Hz	1 s	0 dB
110 kHz - 150 kHz	50 Hz	AVG	200 Hz	1 s	0 dB
150 kHz - 490 kHz	2,25 kHz	AVG	9 kHz	1 s	0 dB
490 kHz - 30 MHz	2,25 kHz	QPK	9 kHz	1 s	0 dB

7.3 Radiated emissions 30 MHz to 1 GHz

NORMATIVE REFERENCES		RESULT
Limits according to:	FCC §15.225 (d), §15.209 RSS-210, Issue 9, section B4	P
Methods of measurement according to:	ANSI C63.10, section 6.3, 6.5 RSS-Gen 6.13, 8.9	
Equipment mode	Power interface	1
	EUT configuration mode	1
	Operation mode	2
Test requirements	Frequency range	30 MHz - 1 GHz
	Class	B
	Antenna height	1 m

Limits

Frequency (MHz)	Field strength (µV/m)	Field strength (dBµV/m)	Measurement distance (m)
30 – 88	100	40.0	3
88 – 216	150	43.5	3
216 – 960	200	46.0	3
Above 960	500	54.0	3

Test setup details

The EUT is a table-top EUT and was standing on a table made of Styrodur with a Pertinax plate on top and the dimensions 1.6 m x 1.0 m x 0.8 m (Length x Width x Height).

Overview sweeps performed with peak detectors and final measurement with quasi-peak detectors. The emission limits shown in the above table are based on measurements employing a CISPR quasi-peak detector.

Test equipment

DESCRIPTION	MANUFACTURER	TYPE	SN	ASSET NO.	CALIBRATION
Semi-Anechoic chamber	Siepel	REF W460SLB	-	PM KF 1150-01	2016-12 (3 years)
Turntable	Inn-Co	-	-	PM KF 2949-04	-
Receiver 10 Hz - 7 GHz	Rohde & Schwarz	ESR7	101095	PM KF 2441	2017-10 (1 year)
Antenna 30 MHz - 3GHz	Rohde & Schwarz	HL 562	100354	PM KF 1123	2016-02 (2 years)
Test software	Rohde & Schwarz	EMC 32 V.10.01.00	-	PM KF 2983-2	-

Measurement results – Radiated emissions 30 MHz to 1 GHz:

EUT: GAT ECO.Side Lock 7000 NW BA
 Test Verdict: Passed
 Test Description: Radiated emissions, FCC Part 15.109
 Operating Conditions: Pulse mode with tag
 Operator Name: RDR
 Project Number: 31426
 Date: 2018-02-02
 Comment: NO.: 1734040076

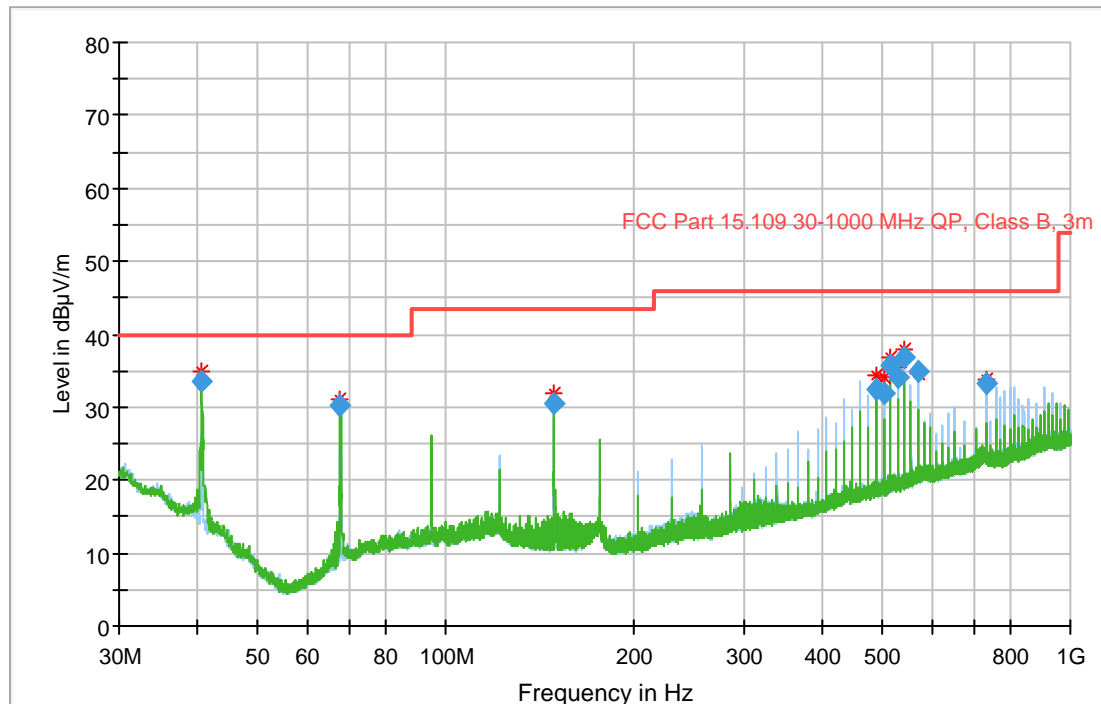

- Preview Result 1H-PK+ [Preview Result 1H.Result:2]
- Preview Result 1V-PK+ [Preview Result 1V.Result:2]
- * Critical_Freqs PK+ [Critical_Freqs.Result:4]
- FCC Part 15.109 30-1000 MHz QP, Class B, 3m [..\EMI radiated\FCC Part 15B\]
- ◆ Final_Result QPK [Final_Result.Result:4]

Frequency (MHz)	QuasiPeak (dBµV/m)	Limit (dBµV/m)	Margin (dB)	Meas. Time (ms)	Bandwidth (kHz)	Height (cm)	Pol	Azimuth (deg)	Corr. (dB)
40.680000	33.57	40.00	6.43	1000.0	120.000	100.0	V	352.0	14.4
67.800000	30.12	40.00	9.88	1000.0	120.000	145.0	V	352.0	9.1
149.160000	30.61	43.50	12.89	1000.0	120.000	100.0	V	165.0	10.3
488.160000	32.50	46.00	13.50	1000.0	120.000	180.0	H	-12.0	17.5
501.720000	31.89	46.00	14.11	1000.0	120.000	174.0	H	5.0	17.7
515.280000	35.82	46.00	10.18	1000.0	120.000	171.0	H	-5.0	18.0
528.840000	34.04	46.00	11.96	1000.0	120.000	171.0	H	345.0	18.2
542.400000	36.92	46.00	9.08	1000.0	120.000	169.0	H	356.0	18.3
569.520000	34.95	46.00	11.05	1000.0	120.000	148.0	H	-6.0	18.9
732.240000	33.37	46.00	12.63	1000.0	120.000	117.0	H	-14.0	21.4

EMI Auto Test Template: FCC-RE-R12-AN08

Hardware Setup: EN-RE-R12-AN08
 Measurement Type: Open-Area-Test-Site
 Frequency Range: 30 MHz - 1 GHz
 Graphics Level Range: 0 dB μ V/m - 80 dB μ V/m

Preview Measurements:
 Antenna height: 100 - 355 cm , Step Size = 85 cm , Positioning Speed = 8
 Polarization: H + V
 Turntable position: 0 - 352 deg , Step Size = 22 deg , Positioning Speed = 8
 Graphics Display: Show separate traces for horizontal and vertical polarization
 Scan Test Template: EN-RE-R12-AN08_PRE

Subrange	Step Size	Detectors	IF BW	Meas. Time	Preamp
Receiver: [ESR 7]					
30 MHz - 1 GHz	30 kHz	PK+	120 kHz	0,1 s	20 dB
1 GHz - 3 GHz	250 kHz	PK+	1 MHz	0,1 s	20 dB

Frequency Zoom:
 Zoom Scan Template: EN-RE-R12-AN08_ZOOM

Adjustment:
 Antenna height: Range = 90 cm , Measuring Speed = 3
 Turntable position: Range = 30 deg , Measuring Speed = 3
 Template for Single Meas.: EN-RE-R12-AN08_MAX

Final Measurements:
 Template for Single Meas.: EN-RE-R12-AN08_FIN

Subrange	Step Size	Detectors	IF BW	Meas. Time	Preamp
Receiver: [ESR 7]					
30 MHz - 1 GHz	40 kHz	QPK	120 kHz	1 s	20 dB
1 GHz - 3 GHz	40 kHz	QPK	1 MHz	1 s	20 dB

7.4 Frequency stability measurement

NORMATIVE REFERENCES		RESULT
Limits according to:	FCC §15.225 (e) RSS-210, Issue 9, section B6 RSS-Gen Issue 4, section 6.11	P
Methods of measurement according to:	ANSI C63.10, section 9.14	
Equipment mode	Power interface	1
	EUT configuration mode	1
	Operation mode	1

Limits

Limit:	The frequency tolerance of the carrier signal shall be maintained within $\pm 0.01\%$ (± 100 ppm) of the carrier frequency under nominal conditions.
EUT temperature range:	-15°C to +55°C
Test temperature range:	-30°C to +55°C
Nominal battery voltage:	3.6 V DC
Lower voltage limit (85%):	3.06 V DC

Test equipment

DESCRIPTION	MANUFACTURER	TYPE	SN	ASSET NO.	CALIBRATION
Temperature chamber	Heraeus-Vötsch	HT4010	45021	PM KF 1402	2017-02 (1 year)
Spectrum analyser	Rohde & Schwarz	FSV40	837356/012	PM KF 2783	2017-09 (1 year)
Near field probes	EMCO	EMCO 7405	1405	PM KF 0139	2017-12 (1 year)

Measurement results – Frequency stability measurement:

Temperature °C	Carrier MHz	Upper limit:	13.696 MHz
		Lower limit:	13.424 MHz
		Measured value under temperature influence:	
+55	13.560	13.560	
+50	13.560	13.560	
+40	13.560	13.560	
+30	13.560	13.560	
+20	13.560	13.560	
+10	13.560	13.560	
0	13.560	13.560	
-10	13.560	13.560	
-20	13.560	13.560	
-30	13.560	13.560	

Comment

The DC voltage reduction from 3.6 V to 3.06 V at a temperature of 20°C had no influence on the frequency of the carrier.

7.5 Occupied bandwidth

NORMATIVE REFERENCES		RESULT
Limits according to:	RSS-Gen, Issue 4, 6.6	P
Methods of measurement according to:	RSS-Gen, Issue 4, 6.6	
Equipment mode	Power interface	1
	EUT configuration mode	1
	Operation mode	1

Test equipment

DESCRIPTION	MANUFACTURER	TYPE	SN	ASSET NO.	CALIBRATION
Spectrum analyser	Rohde & Schwarz	FSV40	837356/012	PM KF 2783	2017-09 (1 year)
Near field probes	EMCO	EMCO 7405	1405	PM KF 0139	2017-12 (1 year)

Comment

The 99% occupied bandwidth is 445.731 kHz.

Measurement results – 99% occupied bandwidth:

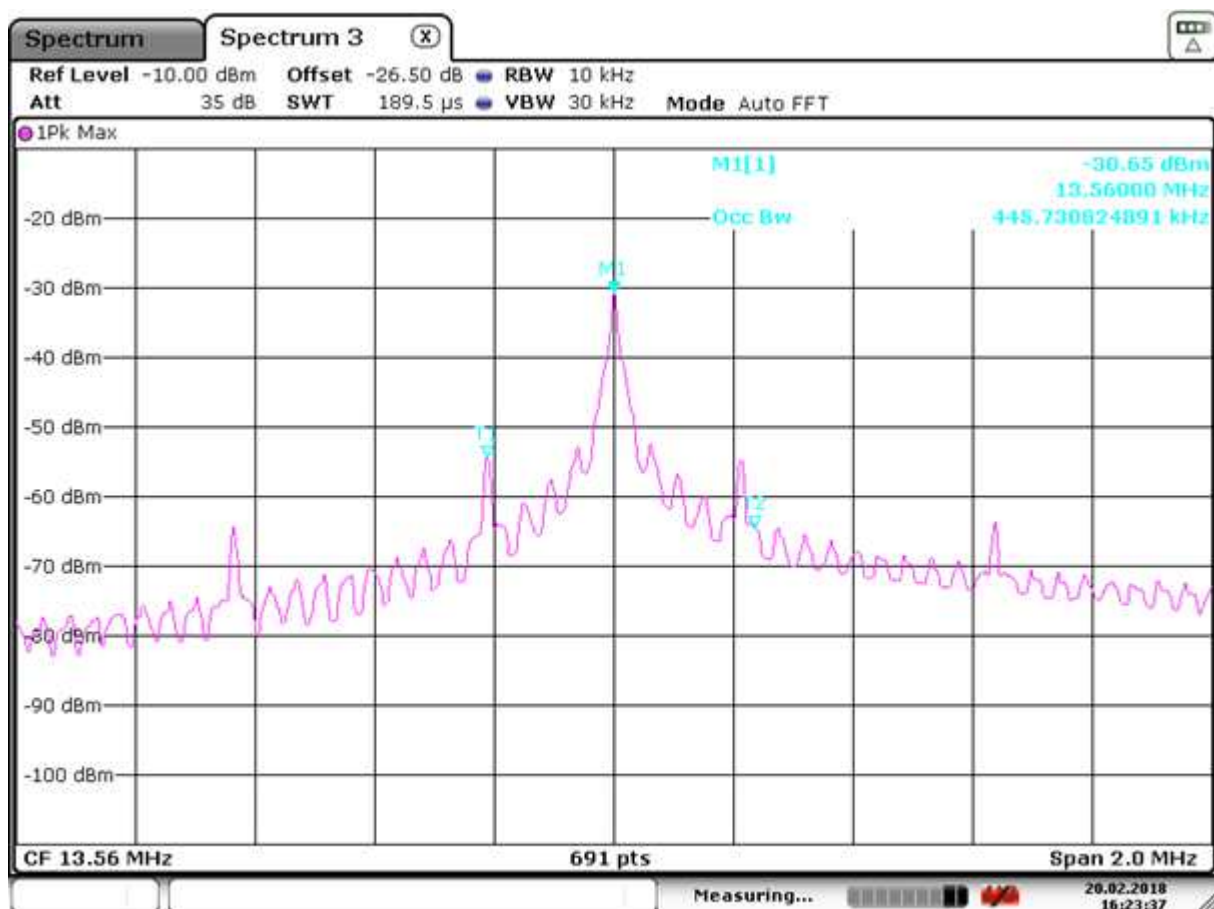

Date: 20.FEB.2018 16:23:38

End of test report