

GAT ECO.Side Lock 7000 BA / NW BA Battery-Powered Multi-Technology Electronic Lock



© Copyright 2018 by GANTNER Electronic GmbH, Schruns (Austria).

Operating instructions, manuals and software are protected by copyright. All rights are reserved. Copying, duplication, translation, installation in any electronic medium or machine-readable form in whole or in part is prohibited. The sole exception is represented by creation of a back-up copy of software for own use as a safeguard, so far as this is technically possible and recommended by us. Any infringement will render the party committing such infringement liable to compensation payment.

Liability

Any claims against the manufacturer based on the hardware or software products described in this manual shall depend exclusively on the conditions of the guarantee. Any further-reaching claims are excluded, and in particular the manufacturer accepts no liability for the completeness or accuracy of the contents of this manual. The right is reserved to make alterations, and alterations may be made at any time without prior notice being given.

Trademarks

Attention is drawn at this point to markings and registered trademarks used in this manual. All product and company names, which are mentioned in this manual, are only used for identification and explanation purposes. Some of these names may be trademarks or registered trademarks of the corresponding company.

Contact

For general inquiries of further information on the GAT ECO.Side Lock 7000 BA and GAT ECO.Side Lock 7000 NW BA, see the contact information below.

Contact address of manufacturer:

GANTNER Electronic GmbH
Montafonerstrasse 8
6780 Schruns, Austria

Phone: +43 5556 73784 - 0

Fax: +43 5556 73784 - 8000

Important Information

Dear Customer,

Our aim is to ensure that our product operates with safety and to your complete satisfaction. To achieve this aim, please take this opportunity to familiarize yourself with the following guidelines.

- Pay attention to the safety messages in this manual. The messages are indicated by the signal words "DANGER", "WARNING", or "CAUTION", and inform you about hazardous situations and how to avoid them.
- Pay attention to messages indicated by the "NOTICE" signal word. These messages include important information for avoiding property damage.
- Pay attention to the symbols and safety messages on the product.
- Read all instructions in this manual carefully before installing or operating the product.
- Where not otherwise specifically documented, the appropriate installation, commissioning, operation and maintenance of the product is the customer's responsibility.
- Keep this manual in a safe place for quick reference.

Notation of Safety Information and Safety Symbols

This manual includes important safety messages and symbols intended to inform the user about potentially hazardous situations or important information for the safe and proper use of the described product(s). The safety messages also include directives on how to avoid hazardous situations. These safety messages and directives must be read and observed.

The structure of the safety messages and the meaning of the symbols used in this manual are described in this section.

1. Safety Messages for Personal Injury

Personal safety messages contain a signal word, describe the nature of the hazard, and indicate how to avoid the hazard.



The safety alert symbol used without a signal word always precedes important safety information that must be read carefully and the instructions carefully observed. Not doing so may cause personal injury.

Format of safety messages that apply to an entire section:

These safety messages may be used with or without a symbol.

CAUTION



Electrical shock

- *Touching current-conducting parts may result in injury due to electrical shock.*
- *Do not remove safety protection and covers.*
 - *Do not touch the electrical connections while power is being supplied.*

Format of safety messages that are embedded in text and apply to a specific point:

CAUTION! **Electrical shock.** Never remove safety protection and covers. Do not touch the electrical connections while power is being supplied.

2. Property Damage Messages

Property damage messages are used to describe potentially hazardous situations that may lead to property damage. These messages have the same layout as safety messages but use the signal word "NOTICE" instead of "CAUTION".

Format of property damage messages that apply to an entire section:

NOTICE

Risk of damage to the device and connected devices
Risk of malfunction

- Read the following instructions carefully before installing the device.
- Always adhere to the instructions.

Format of property damage messages that are embedded in text and apply to a specific point:

NOTE! Risk of damage to the device and connected devices. Read the following instructions carefully before installing the device.

3. Definition of the Signal Words

	Indicates a hazardous situation that, if not avoided, may result in minor or moderate injury.
	Indicates information considered important, but not hazard-related (e.g., messages relating to property damage).

4. Definition of the Safety Symbols

	Caution: General Information This symbol indicates general warnings or cautions that are not related to a particular type of hazard.
	Caution: Electrical Shock This symbol indicates warnings related to electrical hazards (danger due to high voltage).
	Prohibited: Do Not Disassemble This symbol indicates warnings about not disassembling certain components or equipment. Disassembling may lead to damage or malfunction of the device.
	Mandatory Action: General Information This symbol indicates general information that must be read and followed before proceeding with the accompanying instructions.
	Mandatory Action: Read Instructions This symbol indicates information referring to an important description in the manual, or other documentation, which must be read and followed.

⚠ Important Safety Information ⚠



- The installation, commissioning, and servicing of our products must be performed only by suitably trained personnel. In particular, electrical connections must only be made by correspondingly qualified specialists. Always observe the relevant installation regulations in accordance with the national Electrical Engineers Association.

→ Unqualified personnel may potentially perform actions that result in injury due to electrical shock.



- Where not otherwise stated, installation and maintenance work on our products must be carried out when disconnected from the power supply. This applies in particular to appliances that are normally supplied by low-voltage current.

→ If the appliance is not disconnected from power, touching terminals or other internal parts of the appliance may lead to injury due to electrical shock.



- It is prohibited to alter the products (devices, cabling, etc.).

→ Alterations to the products may subsequently result in personal injury, property damage, or damage to the products.

- Do not remove protective shields and covers.

→ Removing protective shields and covers may result in personal injury or property damage.

- Do not attempt to repair a product after a defect, failure, or damage is detected. In addition, do not put the product back into operation. In such cases, it is essential to contact your GANTNER representative or the GANTNER support hotline.



- The installation, commissioning, operation, and maintenance of the product must be carried out in accordance with the technical conditions of operation as described in the corresponding documentation. Therefore, it is essential to read the corresponding chapter of this manual and observe the instructions and information therein.

- If there are still some points that are not entirely clear, please do not take a chance. All queries can be clarified by your GANTNER representative or by ringing the GANTNER support hotline.

- Directly on receipt of the goods, inspect both the packaging and the product itself for any signs of damage. Also check that the delivery is complete and includes all accessories, documentation, auxiliary devices, etc.



- If the packaging or product has been damaged in transport, or should you suspect that it may have a fault, the product must not be put into service. Contact your GANTNER representative who will endeavor to resolve the problem as quickly as possible.

- GANTNER Electronic GmbH accepts no responsibility for any injuries or damage caused as a result of improper use.

Although great care is taken, and we are continuously aiming for improvement, we cannot completely exclude the possibility of errors appearing in our documentation. GANTNER Electronic GmbH therefore accepts no responsibility for the completeness or the accuracy of this manual. The right is reserved to make alterations at any time without prior notice.

Should you discover any fault with the product or in its accompanying documentation, or you have any suggestions for improvement, you may confidently inform your GANTNER representative or GANTNER Electronic GmbH directly.

We especially look forward to hearing from you if you want to let us know that everything is functioning perfectly.

The GAT ECO.Side Lock 7000 BA / NW BA was developed and fabricated under the quality management standard ISO 9001 and GANTNER Electronic GmbH is also certified according to standard ISO 14001.



This product is in conformity with the following EC directives, including all applicable amendments:
 - 2014/53/EU (Radio Equipment Directive)
 The complete text of the CE Declaration of Conformity is available on the following internet link:
http://www.gantner.com/en/downloads-gat-eco-sidelock7xxx_90lweb4f22



GANTNER is committed to meeting or exceeding the requirements of the RoHS directive (2011/65/EU). The RoHS directive requires that manufacturers eliminate or minimize the use of lead, mercury, hexavalent chromium, cadmium, polybrominated biphenyls and polybrominated diphenyl ethers in electrical and electronic equipment sold in the EU after July 1, 2006.



The WEEE symbol on GANTNER products and their packaging indicates that the corresponding material must not be disposed of with normal household waste. Instead such marked waste equipment must be disposed of by handing it over to a designated electronic waste recycling facility. Separating and recycling this waste equipment at the time of disposal will help to conserve natural resources and ensure that it is recycled in a manner that protects human health and the environment. Please contact your local authority for further details of your nearest electronic waste recycling facility.

FCC INFORMATION (U.S.A.)

Note:

This equipment has been tested and found to comply with the limits for a Class B digital device, pursuant to part 15 of the FCC Rules. These limits are designed to provide reasonable protection against harmful interference in a residential installation. This equipment generates, uses, and can radiate radio frequency energy and, if not installed and used in accordance with the instructions, may cause harmful interference to radio communications. However, there is no guarantee that interference will not occur in a particular installation. If this equipment does cause harmful interference to radio or television reception, which can be determined by turning the equipment off and on, the user is encouraged to try to correct the interference by one or more of the following measures:

- Reorient or relocate the receiving antenna.
- Increase the separation between the equipment and receiver.
- Connect the equipment into an outlet on a circuit different from that of which the receiver is connected.
- Consult the dealer or an experienced radio/TV technician for help.

FCC Warning Statement:

[Any] changes or modifications not expressly approved by the party responsible for compliance could void the user's authority to operate the equipment.

Compliance Information Statement:

FCC ID: NC4-GEA1180067A

This device complies with Part 15 of the FCC Rules. Operation is subject to the following two conditions: (1) This device must not cause harmful interference, and (2) this device must accept any interference received, including interference that may cause undesired operation.

INDUSTRY CANADA INFORMATION (IC ID: 11873A-1180067A)

This device complies with Industry Canada's licence-exempt RSSs. Operation is subject to the following two conditions:

- (1) This device may not cause interference; and
- (2) This device must accept any interference, including interference that may cause undesired operation of the device.

Le présent appareil est conforme aux CNR d'Industrie Canada applicables aux appareils radio exempts de licence. L'exploitation est autorisée aux deux conditions suivantes :

- 1) l'appareil ne doit pas produire de brouillage;
- 2) l'appareil doit accepter tout brouillage radioélectrique subi, même si le brouillage est susceptible d'en compromettre le fonctionnement.

ICES Statement (Canada)

This Class B digital apparatus complies with Canadian ICES-003.

Cet appareil numérique de la class B est conforme à la norme NMB-003 du Canada.

TABLE OF CONTENTS

1	INTRODUCTION	9
1.1	About this Manual	9
1.2	Chapter Overview	9
1.3	Contact & Inquiries	9
1.4	Target Group	10
1.5	Formatting	10
1.5.1	Safety-Critical Information	10
1.5.2	Non-Safety-Critical Information	10
1.5.3	Instructions and Results	10
2	GENERAL INFORMATION	11
2.1	Intended Use	11
2.2	Functional Description	11
2.3	Terminology	12
2.4	RFID Technology	13
2.5	System Components	14
3	INSTALLATION	17
3.1	Target Group	17
3.2	Definition of the Door Hinge (Right of Left Door)	17
3.3	Test Installation	18
3.4	Metallic and Non-Metallic Doors	18
3.5	Bolt Gauge	18
3.6	Door Status Contact	19
3.7	Transportation Guidelines	19
3.8	Replacement after a Burglary Attempt	19
3.9	Measurement Diagrams for Installation	20
3.9.1	Door Width	20
3.9.2	Dimensions of the GAT ECO.Side Lock 7000 BA and GAT NET.Lock Bolt Sets	20
3.10	Installation in Lockers with Non-Metallic Doors (Except Glass)	22
3.10.1	Installation Requirements for the GAT ECO.Side Lock 7000 BA and Non-Metallic Doors	23
3.10.2	Installation Instructions for the GAT ECO.Side Lock 7000 BA and Non-Metallic Doors	24
3.11	Installation in Lockers with Metallic Doors	25
3.11.1	Cutouts in the Locker Door	26
3.11.2	Installation Requirements for the GAT ECO.Side Lock 7000 BA and Metallic Doors	27
3.11.3	Installation Instructions for the GAT ECO.Side Lock 7000 BA and Metallic Doors	28
3.12	Installation in Lockers with Glass Doors	29
3.12.1	Installation Requirements for the GAT ECO.Side Lock 7000 BA and Glass Doors	30
3.12.2	Installation Instructions for the GAT ECO.Side Lock 7000 BA and Glass Doors	31
4	COMMISSIONING	33
4.1	Target Group	33
4.2	Power Supply	33
4.2.1	Battery Information	33
4.2.2	Inserting the Battery	33
4.2.3	Replacing the Battery	34
4.3	USB Connection	35
4.4	Automatic Antenna Adjustment	37
4.4.1	Antenna Adjustment using the Service Data Carrier	37
4.4.2	Antenna Adjustment via GAT Config Manager	37

5	CONFIGURATION.....	39
5.1	General Information	39
5.2	Setup for Configuration in GAT Config Manager	39
5.3	View and Edit the GAT ECO.Side Lock 7000 BA Configuration Settings	41
5.4	Upload Configuration Settings to the GAT ECO.Side Lock 7000 BA	42
5.5	Updating the GAT ECO.Side Lock 7000 BA Firmware.....	43
5.6	Configuration Settings of the GAT ECO.Side Lock 7000 BA	44
5.6.1	Operating Mode.....	44
5.6.2	Locker Number	44
5.6.3	Sound Signals	44
5.6.4	Alarm Mode	44
5.6.5	Auto-Unlock	45
5.6.6	Duration of Use.....	45
5.6.7	Locking of Personal Locker without data carrier	45
5.6.8	MASTER Data Carriers	45
5.6.9	Configuration Settings Table	46
6	OPERATION	49
6.1	General	49
6.2	Target Group.....	49
6.3	Operating Modes.....	49
6.3.1	Free Locker Mode (with or without Duration of Use Function).....	50
6.3.2	Free Locker Universal Mode	51
6.3.3	Free Locker Unique Number Mode	52
6.3.4	Personal Locker Programming Card Mode	52
6.3.5	Personal Locker Expiry Date Mode	53
6.4	GAT ECO.Basic Set B BA	55
6.5	Summary of System Data Carriers	55
6.5.1	MASTER Data Carrier.....	55
6.5.2	OPEN MASTER Data Carrier.....	56
6.5.1	DELETE MASTER Data Carrier.....	56
6.5.2	PROGRAM Data Carrier	56
6.5.3	BATTERY Data Carrier	57
6.5.4	SERVICE Data Carrier	57
6.6	Alarm and Handling	57
6.7	Signalization Overview.....	58
7	CLEANING AND MAINTENANCE	59
7.1	Target Group.....	59
7.2	Functional Testing.....	59
7.3	Cleaning.....	60
7.4	Maintenance.....	60
8	TECHNICAL DATA	61
8.1	Power Supply	61
8.2	Reading Field.....	61
8.3	Memory and Time Management.....	61
8.4	Control and Display Elements.....	62
8.5	Interfaces	62
8.6	Housing.....	62
8.7	Environmental Conditions	62

1 INTRODUCTION

1.1 About this Manual

This manual provides information on the functionality of the GAT ECO.Side Lock 7000 BA and GAT ECO.Side Lock 7000 NW BA and includes an overview of how to configure the locks using GANTNER's configuration software, "GAT Config Manager". There is a separate manual available for GAT Config Manager that explains all functions associated with the software in greater detail.

i The name "GAT ECO.Side Lock 7000 BA" is henceforth used in this manual to refer to both the GAT ECO.Side Lock 7000 BA and the GAT ECO.Side Lock 7000 NW BA. Functionality that is specific to one type of lock will be noted.

1.2 Chapter Overview

In chapter "2 GENERAL INFORMATION", a functional description of the GAT ECO.Side Lock 7000 BA, the RFID technologies supported by the device, key terms used in this manual and a summary of system components can be found.

Chapter "3 INSTALLATION" contains the measurement diagrams and information required to install the GAT ECO.Side Lock 7000 BA into lockers with metallic, non-metallic, and glass doors.

Chapter "4 COMMISSIONING" describes how to put the GAT ECO.Side Lock 7000 BA into operation and includes information on the battery and USB connection.

Chapter "5 CONFIGURATION" describes how to configure the GAT ECO.Side Lock 7000 BA using GAT Config Manager. The main configuration settings for the lock are explained and a table listing every setting is provided in this chapter.

Chapter "6 OPERATION" describes the different operating modes of the GAT ECO.Side Lock 7000 BA. The system data carriers required to maintain the locker system and the alarm function are also explained in this section.

Contained in chapter "7 CLEANING AND MAINTENANCE" are the instructions for performing functional testing and cleaning of the GAT ECO.Side Lock 7000 BA to ensure that the correct operation is maintained.

Chapter "8 TECHNICAL DATA" contains all the relevant technical information for the GAT ECO.Side Lock 7000 BA.

1.3 Contact & Inquiries

If you have any questions concerning the GAT ECO.Side Lock 7000 BA / NW BA, please contact your local sales partner or directly with one of the GANTNER branch offices. The contact details of the branch offices are provided on the cover of this manual.

1.4 Target Group

This manual contains information relevant for the different stages in the operating life of the GAT ECO.Side Lock 7000 BA / NW BA. Information about the installation, commissioning, and service/maintenance of the GAT ECO.Side Lock 7000 BA / NW BA is separated into corresponding chapters. When a chapter is intended for a specific audience, this is clarified at the beginning of the chapter.

Information for the following target groups is available in this manual:

- Installation technicians (installation, operation, configuration).
- Service technicians and cleaning personnel (service and maintenance).
- End users of the GAT ECO.Side Lock 7000 BA / NW BA (user manual).

Where not explicitly stated, the information in this manual is intended for all target groups in general.

! CAUTION! Injury and property/equipment damage. The tasks described in each chapter must only be performed by the specified target group. Unqualified personnel who perform the described tasks risk personal injury or damaging property/equipment.

1.5 Formatting

1.5.1 Safety-Critical Information

The following formatting (with example text) is used in this manual to display important, safety-critical information that must be read and followed.

NOTE! Following on from this signal word in the manual is a reference text that must be read and followed. The reference text contains important information. Non-observance can lead to damage of the device or associated equipment.

1.5.2 Non-Safety-Critical Information

The following formatting (with example text) is used in this manual to display important, but not safety-critical information.

i *The text accompanying this symbol contains interesting information relevant to the current chapter. You do not necessarily need to read this text; however, it will help you better understand the information in this section or provide interesting tips for the described device or the operation of the software.*

1.5.3 Instructions and Results

Instructions, which must be completed by the reader, and the results of these instructions are formatted as follows.

- ▶ This symbol represents an action or instruction that that must be followed.
 - This symbol represents the result after completing the previous instruction.

2 GENERAL INFORMATION

2.1 Intended Use

The GAT ECO.Side Lock 7000 BA is intended for the electronic locking of wardrobe lockers in facilities such as fitness clubs, baths, golf resorts, hotels, and other individual company applications. The GAT ECO.Side Lock 7000 BA is locked / unlocked using contactless RFID (Radio Frequency Identification) data carriers.

2.2 Functional Description

The GAT ECO.Side Lock 7000 BA is suitable for any type of locker material (e.g., sheet metal, wood, HPL, solid plastic, glass) and can be used for left- and right-hinged doors alike. Due to the mechanical compatibility with the GAT NET.Lock 7000 series a quick and simple installation of existing locker rooms using the GAT ECO.Side Lock 7000 BA is possible.

The GAT ECO.Side Lock 7000 BA is installed on the inner side of the locker body. A bolt set is mounted on the inside of the locker door. The bolt set holds the door shackle which inserts into the GAT ECO.Side Lock 7000 BA and locks the door. The GAT NET.Lock BoltSet 7100 is designed for use with locker doors made from wood, HPL, and solid plastic. For locker doors made from metal, use the GAT NET.Lock BoltSet 7200 and for glass locker doors, the GAT NET.Lock BoltSet 7300 is available. The bolt sets include a passive booster used to amplify the RFID reading field.

The GAT ECO.Side Lock 7000 BA is powered by one 3.6 V AA battery, which provides an operating life of up to 10 years* (at room temperature) before requiring replacement. The configuration (e.g., operating mode) of the GAT ECO.Side Lock 7000 BA can be done on site via USB interface and GAT Config Manager configuration software or using the programming data carrier. For the GAT ECO.Side Lock 7000 NW BA, communication via the integrated wireless interface is also possible.

Using a locker

The user closes the door of their locker and while holding the door shut, holds their data carrier next to the RFID reading field on the locker door (the reading field is indicated by an LED inside the lock). The GAT ECO.Side Lock 7000 BA reads the data carrier information and determines if the user is allowed to use the locker (depending on their authorization status). If the user is authorized to use the locker, the GAT ECO.Side Lock 7000 BA locks the locker door.

To unlock a previously locked locker, the user presses the locker door while holding their data carrier next to the RFID reading field. The GAT ECO.Side Lock 7000 BA checks that the data carrier has valid authorization before automatically unlocking the locker door.

** Different operating modes or configurations can reduce the battery lifetime.*

2.3 Terminology

Several key terms that are used often in this manual are defined below.

Computer / PC

These terms refer to all desktop and laptop computers running a Microsoft Windows® operating system.

Data Carrier

A data carrier is a form of identification media that is used by staff and visitors in a facility for identification. Data carriers are available in a variety of different forms such as plastic wristbands and chip cards. Data carriers are also available to suit different RFID technologies, e.g., LEGIC, MIFARE®, ISO 15693.

System Data Carrier

Several different types of System Data Carriers are used for programming, service and maintenance tasks. These data carriers have special functionalities and because they are essential for operation of the GAT ECO.Side Lock 7000 BA and they have security-related features, they must be kept in a secure place and be protected against unauthorized use. Most of the System Data Carriers are included in the GAT ECO.Basic Set B BA. Some can be ordered separately if needed.

FID (Company ID) and Site Key

The FID and site key are unique numbers assigned to every facility installation. The site key is a combination of the FID and the read and write keys. The site key is used in MIFARE® and ISO 15693 systems and is encoded in every data carrier and device used in the facility thereby ensuring that data carriers from one installation cannot be used in other installations.

GAT Config Manager

GANTNER developed PC software that is used to configure GANTNER devices such as the GAT ECO.Side Lock 7000 BA. A separate manual is available and integrated into the software. While the software is open, click on the "Help" drop-down menu and select "How Do I".

Lock

General term for the GAT ECO.Side Lock 7000 BA.

Locker

The term "locker" is used to describe all possible locker applications that can be fitted with a GANTNER electronic lock. Typical applications include a changing room locker, a deposit box, or a private box.

RFID (Radio-Frequency Identification)

Identification over a short distance using radio frequency. An RFID data carrier is used to identify users in GANTNER systems.

User / Guest / Visitor

These general terms refer to the people in a facility who use the locker system, i.e., the GAT ECO.Side Lock 7000 BA, data carriers, and other GANTNER devices.

2.4 RFID Technology

Identification of users by GANTNER devices within a facility is achieved via RFID (radio-frequency identification) technology using a frequency of 13.56 MHz. There are various RFID technologies available with different letters added to the GANTNER model name to notify of the technology the device supports:

- "B": LEGIC
- "F": MIFARE®
- "ISO": ISO 15693
- "ICLS": HID iCLASS®

The GAT ECO.Side Lock 7000 BA has a multi-technology RFID reader (LEGIC advant) that allows it to operate with a range of RFID technologies. The information in this manual is applicable for the following technologies that can be used with the GAT ECO.Side Lock 7000 BA.

UID and Segments

- LEGIC prime
- LEGIC advant

UID

- ISO 15693
- ISO 14443 (MIFARE)
 - Classic (1k and 4k)
 - Ultralight®
 - DESFire EV1® and EV2®
- HID iCLASS (13.56 MHz)

In addition to the different RFID technologies, data carriers are available in a variety of shapes and sizes. The GAT ECO.Side Lock 7000 BA is designed to operate with all different types of data carrier media.

2.5 System Components

The GAT ECO.Side Lock 7000 BA system consists of the following system parts.

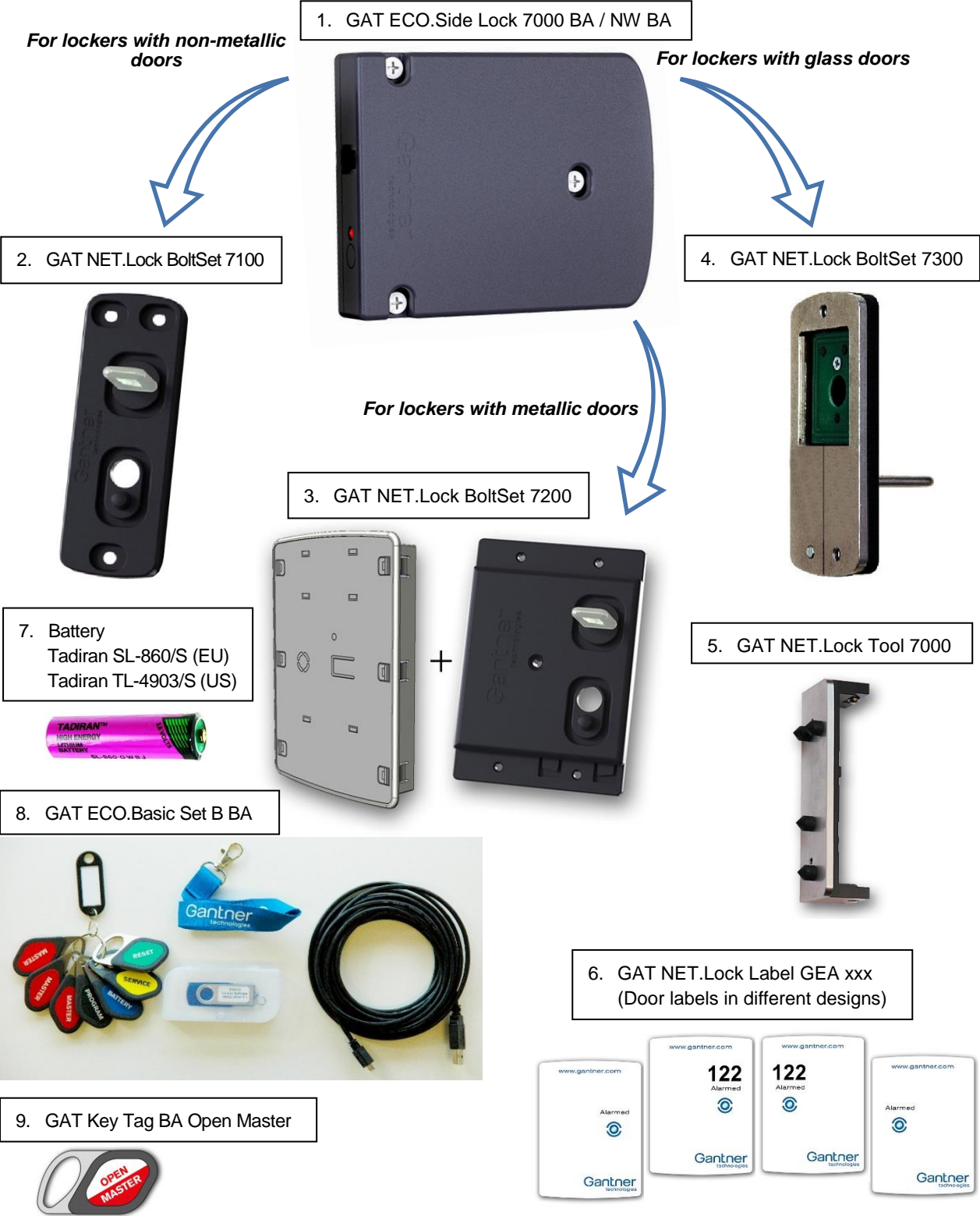

Figure 2.1 – Components of the GAT ECO.Side Lock 7000 system

1. GAT ECO.Side Lock 7000 BA (Part No. 583125)
Battery-powered locker lock with multi-technology RFID reader. Without batteries, without bolt set, and without door label.
GAT ECO.Side Lock 7000 NW BA (Part No. 800925)
Battery-powered locker lock with multi-technology RFID reader and wireless interface. Without batteries, without bolt set, and without door label.
2. GAT NET.Lock BoltSet 7100 (Part No. 369535)
Bolt set with door shackle and booster. Used for non-metallic doors. The bolt set is mounted on the inside of the locker door.
3. GAT NET.Lock BoltSet 7200 (Part No. 532123)
Bolt set with door shackle and booster. Used for metallic doors. The bolt set is installed into locker door. The label carrier is included in the set.
4. GAT NET.Lock BoltSet 7300 (Part No. 774232)
Bolt set with door shackle, booster, and metal support. Used for glass doors. The bolt set with metal support attached are glued on the inner side of the glass door. Adhesive is not included with the set.
5. GAT NET.Lock Tool 7000 (Part No. 533831)
Centre punch gauge for bolt mounting on the locker door. By using the gauge drill holes for the bolt set installation can be accurately marked on the locker door.
6. GAT NET.Lock Label 7000 GEA xxx
Self-adhesive locker door labels in GANTNER design. For metallic doors, the label is stuck onto the label carrier. For non-metallic doors, the label is stuck directly onto the door. The labels are available for right and left doors and with or without printed locker numbers:
 - GAT NET.Lock Label GEA right (Part No. 679034)
For right-hinged doors, without numbering
 - GAT NET.Lock Label GEA NUM right (Part No. 679236)
For right-hinged doors, with numbering
 - GAT NET.Lock Label GEA left (Part No. 370022)
For left-hinged doors, without numbering
 - GAT NET.Lock Label GEA NUM left (Part No. 679135)
For left-hinged doors, with numbering
7. Battery 3.6V Lithium SL-860/S* (Part No. 914430)
GANTNER approved battery for the GAT ECO.Side Lock 7000 BA. One battery required for operation.
Supplied per battery.
*SL-860/S (EU). TL-4903/S (US)
8. GAT ECO.Basic Set B BA (Part No. 958131)
Accessory set for configuring and maintaining the GAT ECO.Side Lock 7000 BA system. Contains system data carriers, 3 m USB cable, configuration software, and GANTNER lanyard. See section "6.4. GAT ECO.Basic Set B BA" for more information.
9. GAT Key Tag BA Open Master (Part No. 1100364)
Optional data carrier. Not included in the GAT ECO.Basic Set B BA. Can be used instead of another MASTER data carrier in order to unlock a locked GAT ECO.Side Lock 7000 BA. Unlike the MASTER data carriers the OPEN MASTER data carrier can only open but not lock a locker.

3 INSTALLATION

This chapter describes the process and what must be considered to install the GAT ECO.Side Lock 7000 BA and NW BA into lockers with metallic, non-metallic, and glass doors. Since the mounting process is identical for both lock variants, the general term GAT ECO.Side Lock 7000 BA is used.

NOTICE

Risk of damage or failure to the GAT ECO.Side Lock 7000 BA

- Read the information in this section carefully before installing the GAT ECO.Side Lock 7000 BA.
- Carefully observe the installation diagrams.
- Use the correct tools to install the GAT ECO.Side Lock 7000 BA.

3.1 Target Group

This chapter provides information for technicians who install the GAT ECO.Side Lock 7000 BA. Experience in mechanical work and basic electrical knowledge is required. Previous knowledge of the GAT ECO.Side Lock 7000 BA is not required.

3.2 Definition of the Door Hinge (Right of Left Door)

For installation, it is important to determine whether the door is hinged to the left or the right. This is defined as follows:

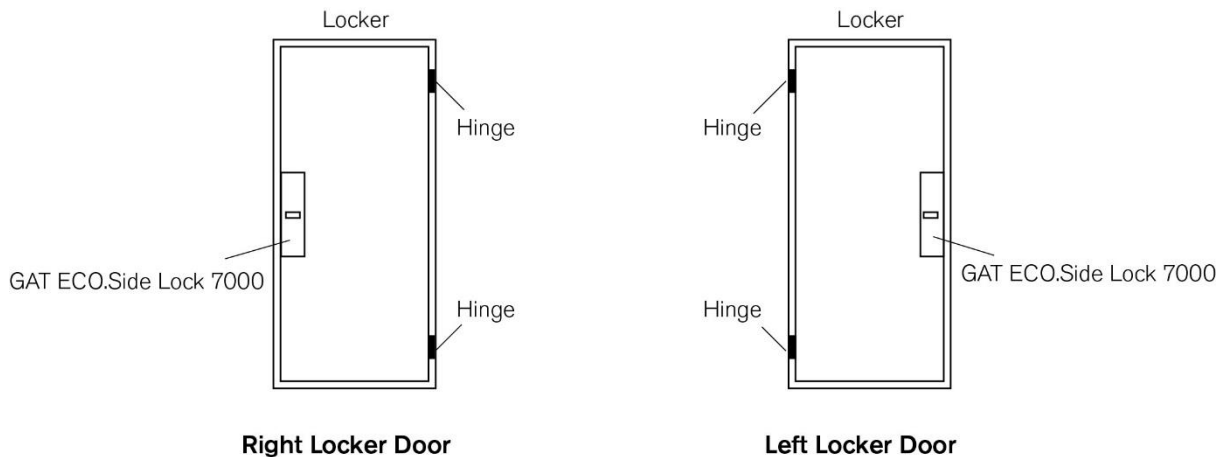

Figure 3.1 – Locker door hinge definition (left/right)

In the following pages the installation process for right-hinged doors is described. The installation process for left locker doors is in principle the same as for right locker doors, only with reversed lock and door orientation.

NOTE! If spring hinges are used in the locker door, ensure that the spring strength is calibrated to allow correct operation of the lock. For example, springs that are too strong can keep the bolt set permanently held in thereby activating the lock's electronics and draining the battery.

3.3 Test Installation

As the GAT ECO.Side Lock 7000 BA is suitable for a wide range of installation applications, always perform a test installation including functional testing of the GAT ECO.Side Lock 7000 BA in a sample locker from the facility before starting with the mass production of lockers.

The following important points must be met. Ensure that:

- The door shackle slides centrally into the opening of the GAT ECO.Side Lock 7000 BA.
- The door locks without any problems.
- The door opens without resistance (ensure retaining hardware such as springs are correctly calibrated).

Also test the GAT ECO.Side Lock 7000 BA using a data carrier, ideally of the same type to be used with the locker system, to ensure the data carrier functions as required. Once the test installation is successfully completed, the remaining locks can be installed in the same way. An installation checklist is available from GANTNER to assist with the test installation process.

3.4 Metallic and Non-Metallic Doors

Because the RFID field of the GAT ECO.Side Lock 7000 BA is distorted or blocked by metal, e.g., metallic locker doors, a cutout is made in metallic locker doors into which the GAT NET.Lock Bolt Set 7200 and label carrier are installed. A specific cutout for non-metallic doors is not necessary, only a drill hole for the status LED is required.

As the reading range of the GAT ECO.Side Lock 7000 BA is limited, the door of non-metallic lockers must not be too thick. The maximum door thickness of non-metallic doors depends on the RFID technology and the type of data carriers used.

3.5 Bolt Gauge

The bolt gauge (GAT NET.Lock Tool 7000, Part No. 533831) can be used to assist installation in non-metallic doors. The gauge allows you to easily mark the drill hole positions onto the door.

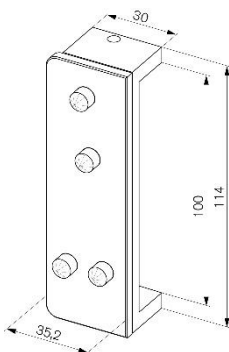

Figure 3.2 – Bolt gauge (dimensions in mm)

The instructions for using the bolt gauge are included with the installation instructions for non-metallic doors (see "3.10.2 Installation Instructions for the GAT ECO.Side Lock 7000 BA and Non-Metallic Doors").

3.6 Door Status Contact

The GAT ECO.Side Lock 7000 BA has a feedback contact (2 in Figure 3.3) that is activated by the door contact (1 in Figure 3.3) when the locker door is closed. It is important that this contact remains clean and undamaged to ensure the correct functionality of the GAT ECO.Side Lock 7000 BA.

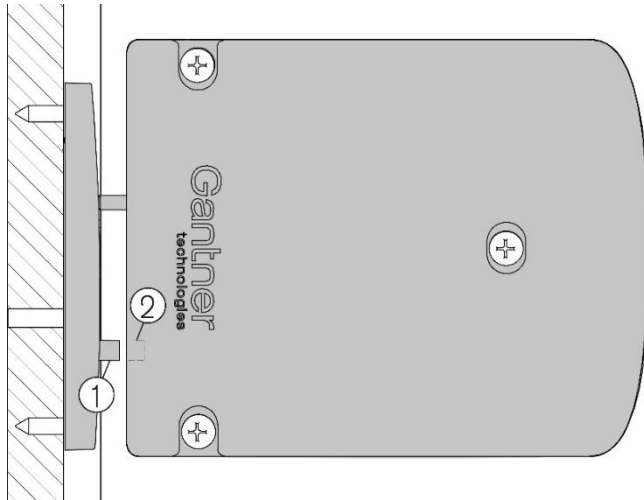

Figure 3.3 – Door status contact

3.7 Transportation Guidelines

The electronics of the GAT ECO.Side Lock 7000 BA are activated when the locker door is pressed shut. For factory-produced lockers that use the GAT ECO.Side Lock 7000 BA, it is important to ensure the bolt set does not activate the lock's electronics during transportation or any time prior to delivery. Activation of the lock electronics during transportation can decrease the battery lifetime.

3.8 Replacement after a Burglary Attempt

If a burglary (forced opening) is attempted or occurs in a locker, the entire GAT ECO.Side Lock 7000 BA must be replaced with a new one. The bolt set and the door shackle must also be replaced.

3.9 Measurement Diagrams for Installation

3.9.1 Door Width

The minimum door width allowed (measured from the door shackle to the hinge) is 230 mm (9.05"). If the door is narrower, the door shackle will hit the locker when the door is being closed.

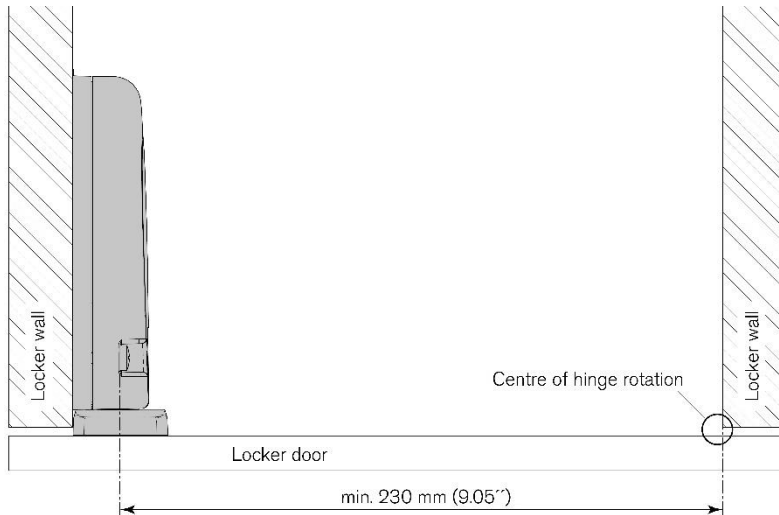

Figure 3.4 - Minimum door width

3.9.2 Dimensions of the GAT ECO.Side Lock 7000 BA and GAT NET.Lock Bolt Sets

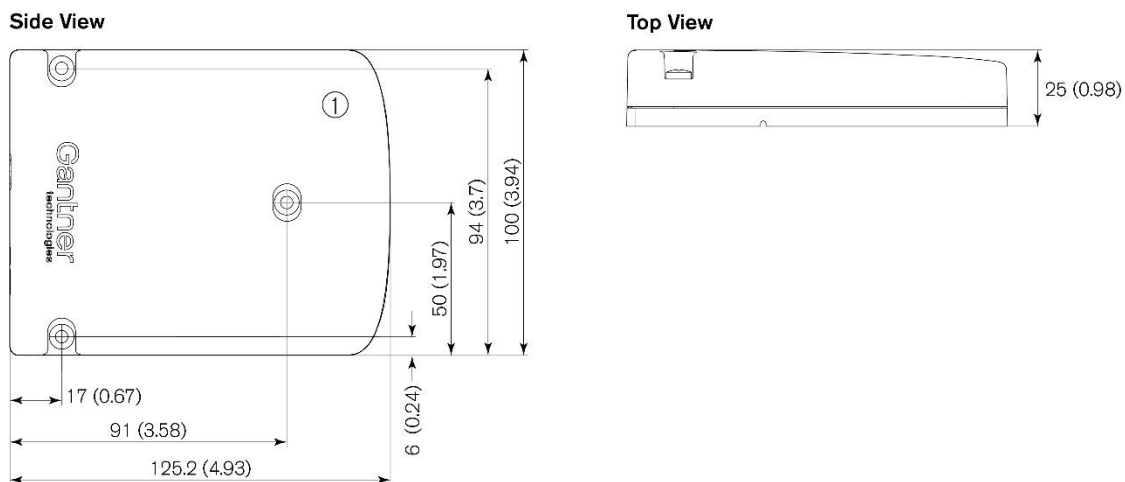

Figure 3.5 - Dimensions of the GAT ECO.Side Lock 7000 BA (dimensions in mm – inches shown in brackets)

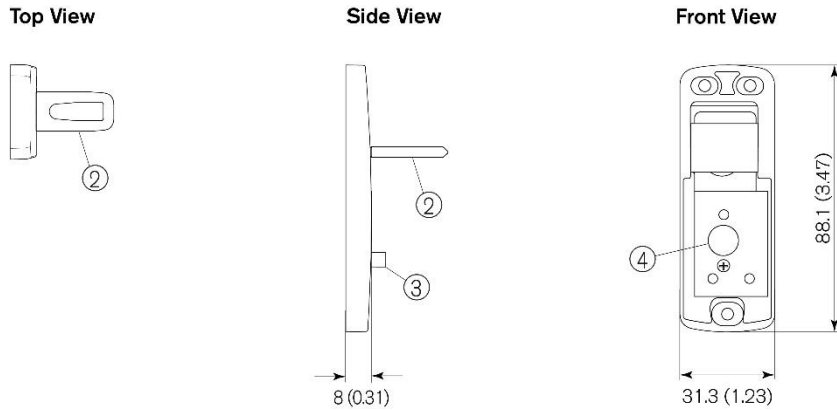

Figure 3.6 - Dimensions of the GAT NET.Lock BoltSet 7100 (dimensions in mm – inches in brackets)

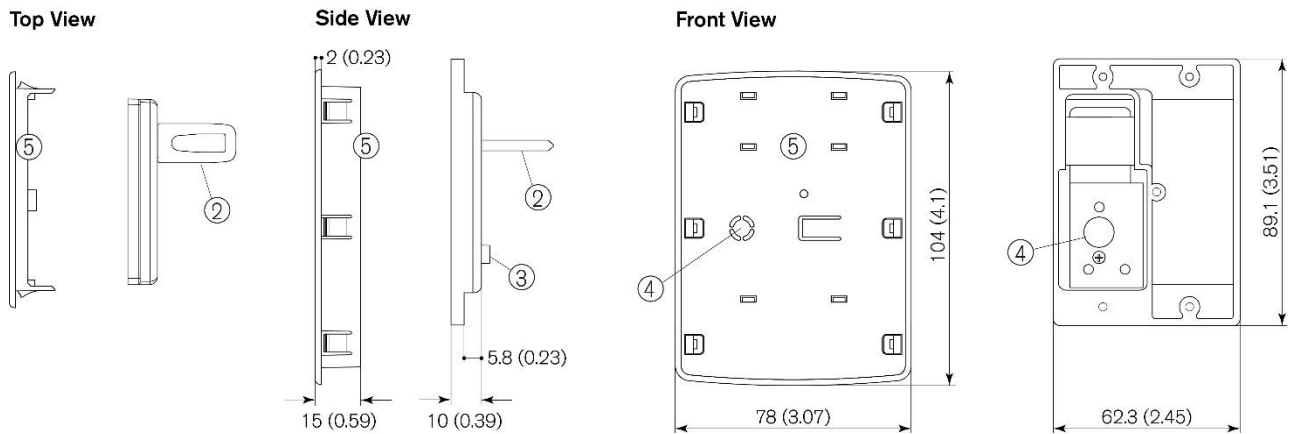

Figure 3.7 - Dimensions of the GAT NET.Lock BoltSet 7200 (dimensions in mm – inches in brackets)

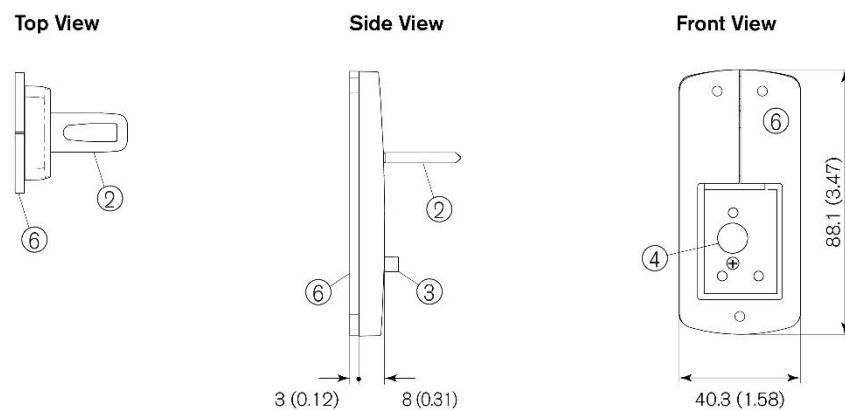

Figure 3.8 - Dimensions of the GAT NET.Lock BoltSet 7300 (dimensions in mm – inches in brackets)

- | | |
|------------------------------|---|
| 1. GAT ECO.Side Lock 7000 BA | 4. Status LED |
| 2. Door shackle | 5. Label carrier (front cover on door outer side) |
| 3. Door contact | 6. Metal support for glass door installation |

3.10 Installation in Lockers with Non-Metallic Doors (Except Glass)

For lockers with non-metallic doors, the GAT ECO.Side Lock 7000 BA is mounted on the left or right inner locker wall depending on whether it is a right or left-hinged locker door. The GAT NET.Lock Bolt Set 7100 is mounted on the inside of the locker door. A drill hole is required in the locker door for the status LED. See the diagram below and the following installation instructions.



For glass door installation instructions see “3.12. Installation in Lockers with Glass Doors”.



1. GAT ECO.Side Lock 7000 BA
2. GAT NET.Lock Bolt Set 7100
3. 3 x mounting holes for the GAT ECO.Side Lock 7000 BA (the use of threaded sleeves is recommended)
5. Door contact
6. 3 x mounting screws for the GAT NET.Lock BoltSet 7100
7. Hole for LED

Figure 3.9 - Installation in a locker with non-metallic, right-hinged door (dimensions in mm – inches shown in brackets)

3.10.1 Installation Requirements for the GAT ECO.Side Lock 7000 BA and Non-Metallic Doors

During installation, please pay particular attention to the following points:

- When the door is pressed shut, ensure there is no gap between the bolt set (2) and the front of the GAT ECO.Side Lock 7000 BA. Ideally the bolt set should touch the front of the lock (see Figure 3.9).
- The locker door, the bolt set, and the front side of the GAT ECO.Side Lock 7000 BA must be perpendicular and parallel to each other. If not, the door contact in the GAT ECO.Side Lock 7000 BA can potentially not function correctly.

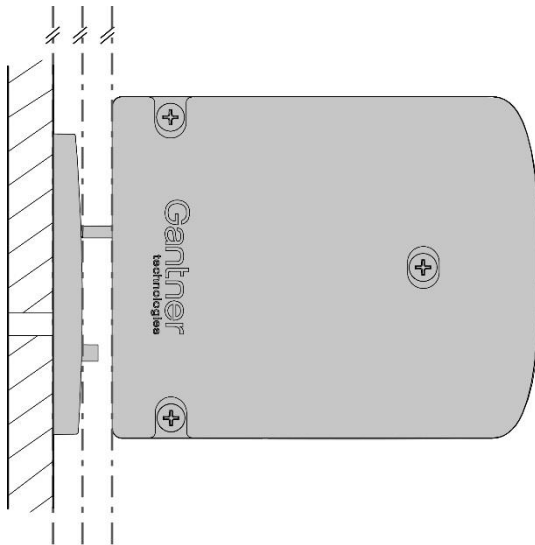

- If right and left-hinged locker doors are in use together, please note the correct LED position. The GAT ECO.Side Lock 7000 BA is mounted upside-down on left doors in comparison to right doors.

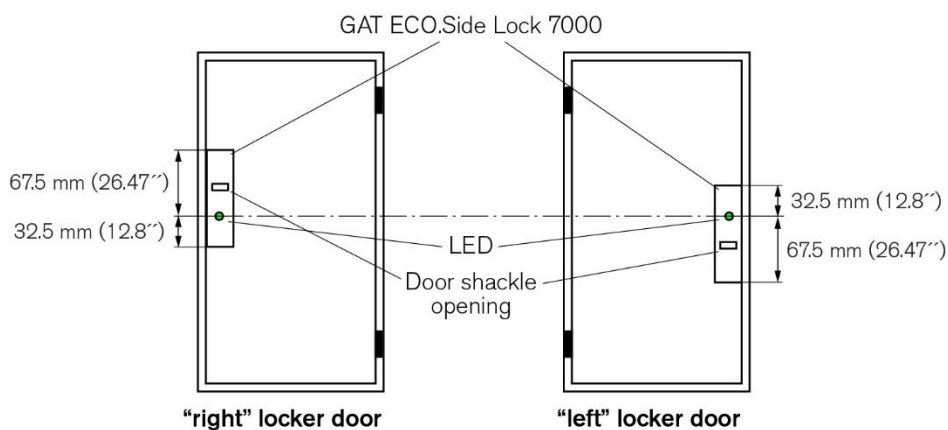

Figure 3.10 - LED positions of the GAT ECO.Side Lock 7000 BA for right and left-hinged doors

NOTE! Before installing all locks in a new locker system, a test installation of one lock into a completed locker and a function check must be performed. See section “3.3 Test Installation”.

3.10.2 Installation Instructions for the GAT ECO.Side Lock 7000 BA and Non-Metallic Doors

Complete the following steps to install the GAT ECO.Side Lock 7000 BA into lockers with non-metallic doors.

- ▶ Drill 3 holes (3 in Figure 3.9) for the GAT ECO.Side Lock 7000 BA into the locker wall inner side according to the information in "3.10.1 Installation Requirements for the GAT ECO.Side Lock 7000 BA and Non-Metallic Doors" and the measurements in Figure 3.9.

NOTE! It is recommended to use threaded sleeves with the mounting holes.

- ▶ Insert the battery into the GAT ECO.Side Lock 7000 BA (see section "4.2.2. Inserting the Battery").
- ▶ Mount the GAT ECO.Side Lock 7000 BA with 3 screws (3) onto the locker wall inner side.

NOTE! Use the correct screws according to the type of locker material, max. \varnothing 4 mm (0.16"). The maximum allowed tightening torque of the screws is 2 Nm (1.47 lb-ft).

- ▶ Mark the mounting holes (6) for the GAT NET.Lock BoltSet 7100 and the hole for the LED (7) onto the locker door inner side. This can be done using the installation diagrams on the previous pages or using the bolt gauge (GAT NET.Lock Tool 7000 - see "3.5 Bolt Gauge").

- ▶ If using the bolt gauge for marking:

- ▶ Insert the bolt gauge onto the front of the installed GAT ECO.Side Lock 7000 BA. The bolt gauge can only be inserted in one orientation and snaps onto the lock.
- ▶ Close the door so that the center points on the bolt gauge mark the hole positions onto the locker door inner side.

NOTE! For doors made of softer material, moderate pressure is sufficient. For doors made of harder material, press the door with sufficient force so that the drill markings are visible.

- ▶ Remove the bolt gauge from the GAT ECO.Side Lock 7000 BA.
- ▶ Drill the three marked mounting holes (6) to the required depth and diameter according to the screws used.
- ▶ Drill the hole for the LED through the locker door (7). The recommended drill hole diameter is 10 mm (0.4") or 8 mm (0.3") when using an LED cap – see following instructions.
- ▶ Attach the bolt set to the locker door inner side using 3 screws.

NOTE! Use the correct screws according to the type of locker material, max. \varnothing 4 mm (0.16"). The maximum allowed tightening torque of the screws is 2 Nm (1.47 lb-ft).

- ▶ To cover the LED hole, a label (GANTNER design or customer-specific design) can be attached to the front of the locker door. A transparent (matt) window for the LED must be incorporated into the label.

NOTE! For customer-specific labels, ensure that a transparent window for the LED is incorporated in the design and that no metallic films or colors are used.

Alternatively, the LED hole can be covered using a transparent LED cap (GAT LED Plug 8mm, Part No. 806325). In this case, the LED hole must be 8 mm in diameter.

- ▶ Test the locker door to confirm that it closes easily and that the door shackle inserts correctly into the GAT ECO.Side Lock 7000 BA. The locker door must spring open without assistance after it is unlocked.

3.11 Installation in Lockers with Metallic Doors

For lockers with metallic doors, the GAT ECO.Side Lock 7000 BA is mounted on the left or right inner locker wall depending on whether it is a right or left-hinged locker door. Two cutouts must be made in the locker door - one in the inner door sheet and one in the outer door sheet. The two parts of the GAT NET.Lock Bolt Set 7200 are then mounted into the locker door. See the diagram below and the following installation instructions.

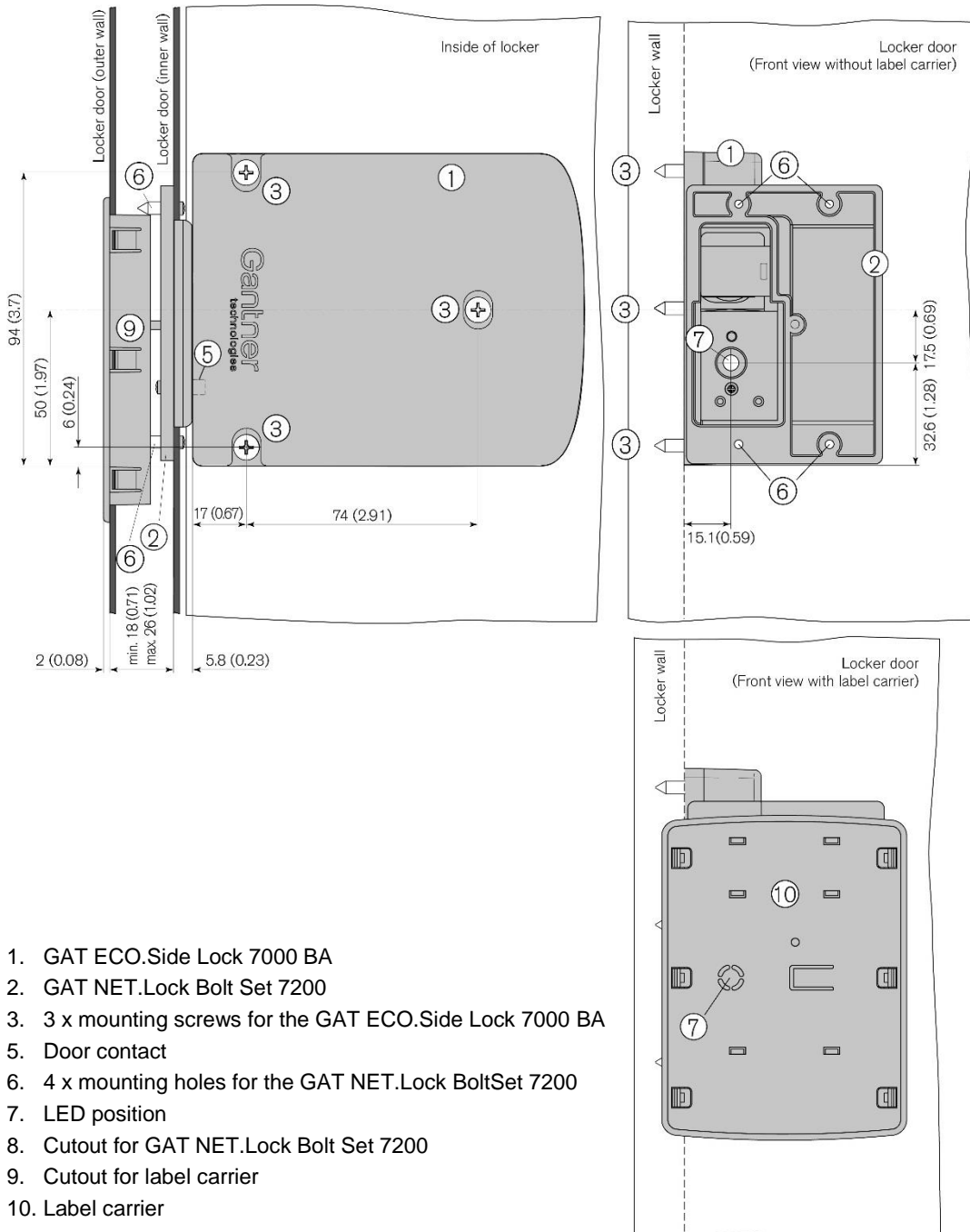

Figure 3.11 - Installation in a locker with metallic, right-hinged door (dimensions in mm – inches shown in brackets)

3.11.1 Cutouts in the Locker Door

The following cutouts must be made on the inner and outer walls of the locker door in order to mount the GAT NET.Lock BoltSet 7200 and label carrier. The measurements for the cutouts are as follows.

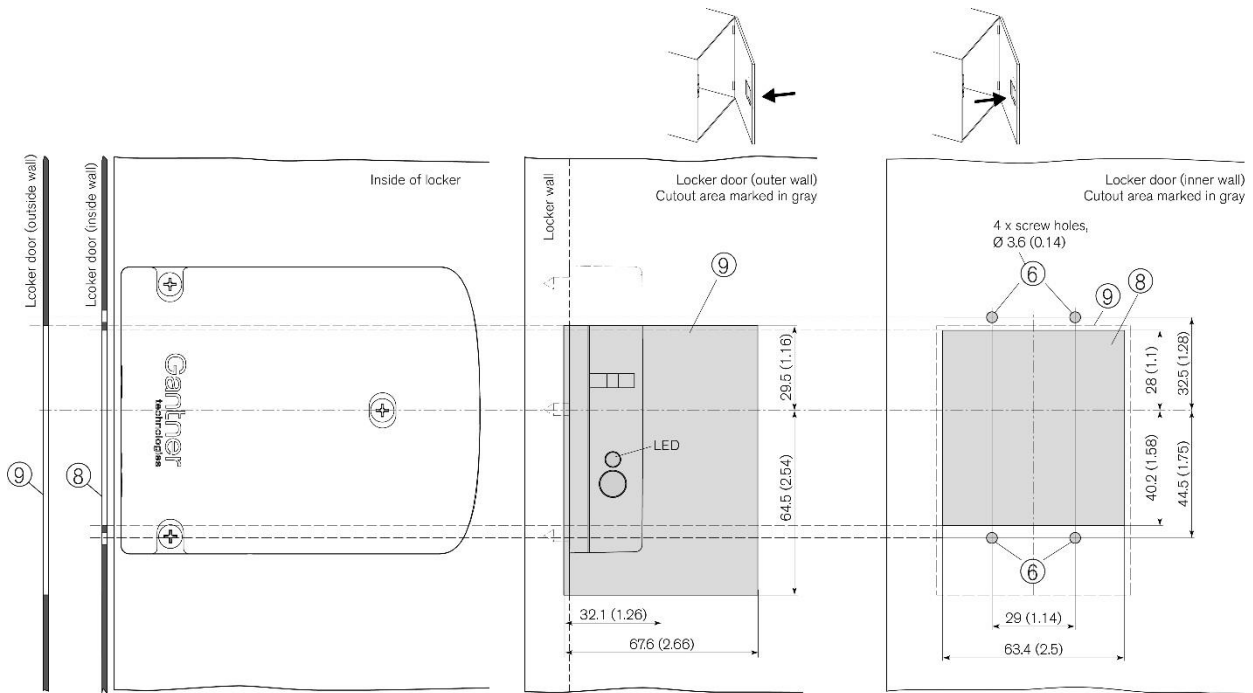
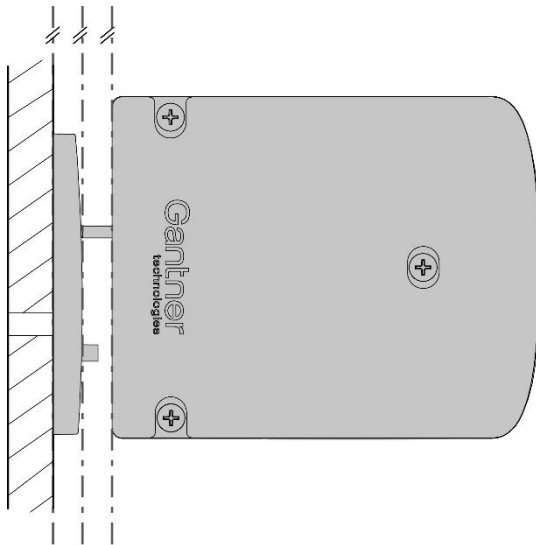

Figure 3.12 - Cutouts for metallic locker doors (dimensions in mm – inches shown in brackets)

3.11.2 Installation Requirements for the GAT ECO.Side Lock 7000 BA and Metallic Doors

During installation, please pay attention to the following points:

- The thickness of the locker door must be between 18 and 26 mm (0.71'' and 1.02''). See Figure 3.11.
- When the door is pressed shut, ensure there is no gap between the bolt set (2) and the front of the GAT ECO.Side Lock 7000 BA. Ideally the bolt set should touch the front of the lock (see measurement in Figure 3.11).
- The locker door, the bolt set, and the front side of the GAT ECO.Side Lock 7000 BA must be perpendicular and parallel to each other. If not, the door contact in the GAT ECO.Side Lock 7000 BA can potentially not function correctly.



- If right and left-hinged locker doors are in use together, please note the correct LED position. The GAT ECO.Side Lock 7000 BA is mounted upside-down on left doors in comparison to right doors.

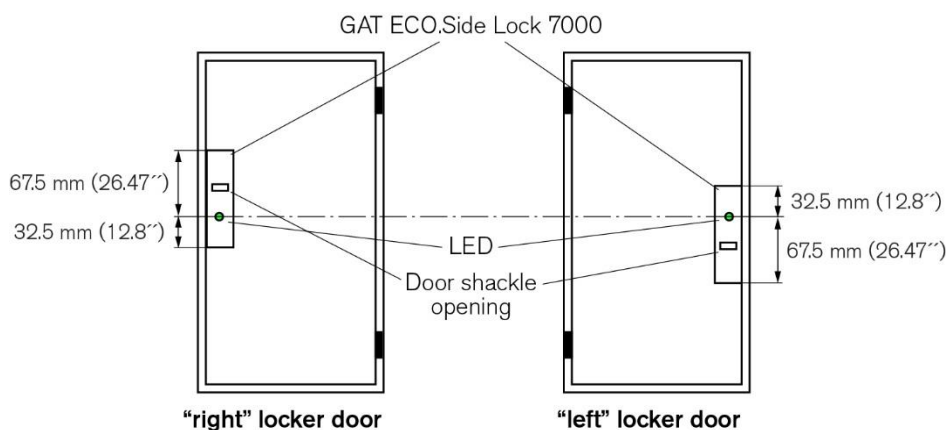

Figure 3.13 - LED positions of the GAT ECO.Side Lock 7000 BA for right and left-hinged doors

NOTE! Before installing all locks in a new locker system, a test installation of one lock into a completed locker and a function check must be performed. See section "3.3 Test Installation".

3.11.3 Installation Instructions for the GAT ECO.Side Lock 7000 BA and Metallic Doors

Complete the following steps to install the GAT ECO.Side Lock 7000 BA into lockers with metallic doors.

- ▶ Drill 3 holes (3 in Figure 3.11) for the GAT ECO.Side Lock 7000 into the locker wall inner side according to the information in section "3.11.2 Installation Requirements for the GAT ECO.Side Lock 7000 BA and Metallic Doors" and the measurements in Figure 3.11.
- ▶ Insert the battery into the GAT ECO.Side Lock 7000 BA (see section "4.2.2. Inserting the Battery").
- ▶ Mount the GAT ECO.Side Lock 7000 BA with 3 screws (3) on the inside locker wall.

NOTE! Use the correct screws according to the type of locker material, max. \varnothing 4 mm (0.16"). The maximum allowed tightening torque of the screws is 2 Nm (1.47 lb-ft).

- ▶ Cut out a section, 63.4 mm x 68.2 mm (2.5" x 2.69"), in the inner wall of the locker door for the GAT NET.Lock Bolt Set 7200 (8 in Figure 3.12).
- ▶ Drill 4 holes (6 in Figure 3.12) in the inner wall of the locker door for mounting the GAT NET.Lock Bolt Set 7200.
- ▶ Cut out a section, 67.6 mm x 94 mm (2.66" x 3.7"), in the outer wall of the locker door for the label carrier (9 in Figure 3.12).
- ▶ Mount the bolt set onto the inside wall of the locker door using 4 screws.

NOTE! Use pan-head metal screws, \varnothing 3.5 mm (0.14"), screw length depends on locker door thickness. The maximum tightening torque of the screws is 2 Nm (1.47 lb-ft).

- ▶ Push the label carrier onto the outside wall of the locker door. The label carrier will remain in place with the lashes on the label carrier. To protect against manipulation, a screw can be used to fix the bolt set to the label carrier.

NOTE! Use a countersunk screw, \varnothing 2.9 mm (0.11"). Screw length depends on locker door thickness, e.g., a 15 mm (0.59") thick door requires a 19 mm (0.75") long screw.

- ▶ A label can be attached to the label carrier on the front of the locker door. The label has a transparent (matt) viewing window for the LED to shine through and can be ordered with a GANTNER design or customer-specific design.

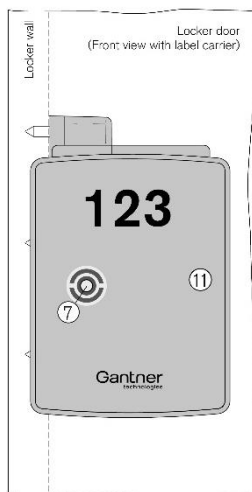

Figure 3.14 - Label carrier with front label

NOTE! For customer-specific labels, ensure that a transparent field for the status LED is incorporated in the design and that no metal foil or metal color are used.

- ▶ Test the locker door to confirm that it closes easily and that the door shackle inserts correctly into the GAT ECO.Side Lock 7000 BA. The locker door must spring open without assistance after it is unlocked.

3.12 Installation in Lockers with Glass Doors

For lockers with glass doors, the GAT ECO.Side Lock 7000 BA is mounted on the left or right inner locker wall depending on whether it is a right or left-hinged locker door. The GAT NET.Lock Bolt Set 7300 (with metal support attached) are glued to the inner side of the locker door. Furthermore, a recess in the printing on the locker door or door label may be necessary for the status LED. See the diagram below and the following installation instructions.

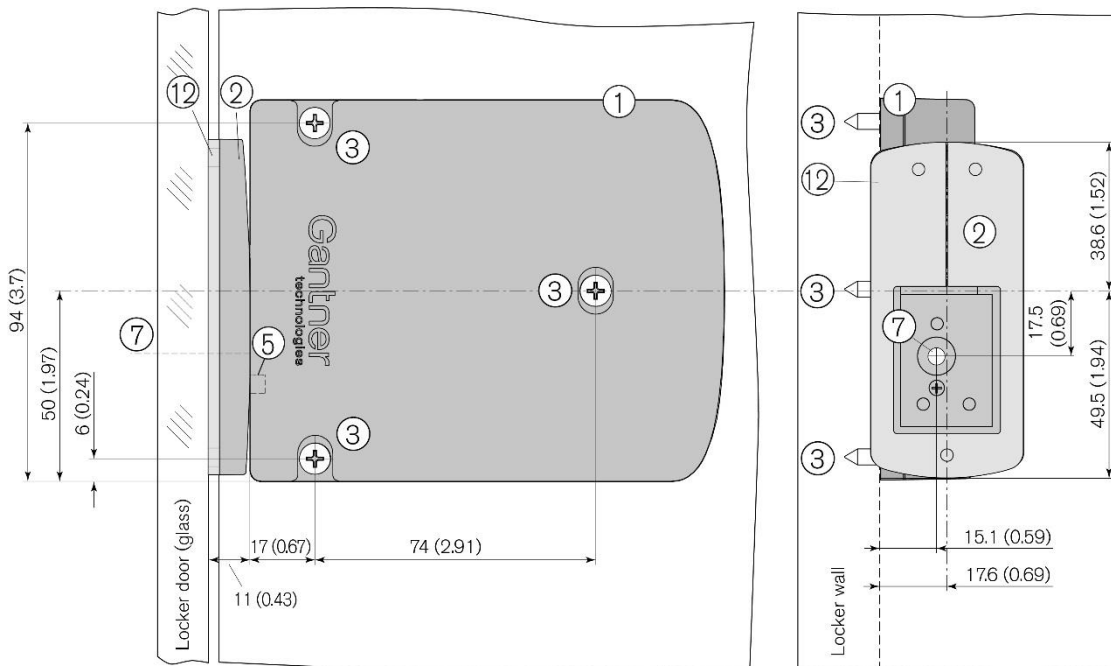

1. GAT ECO.Side Lock 7000 BA
2. GAT NET.Lock BoltSet 7300
3. 3 x mounting screws for the GAT ECO.Side Lock 7000 BA
5. Door contact
7. LED position
12. Metal support for adhering the GAT NET.Lock BoltSet 7300 (the metal support is included with the GAT NET.Lock BoltSet 7300 and is delivered attached to the bolt set).

Figure 3.15 - Installation in a locker with glass, right-hinged door (dimensions in mm – inches shown in brackets)

3.12.1 Installation Requirements for the GAT ECO.Side Lock 7000 BA and Glass Doors

Please pay attention to the following points during installation:

- When the door is pressed shut, ensure there is no gap between the bolt set (2) and the front of the GAT ECO.Side Lock 7000 BA. Ideally the bolt set should touch the front of the lock (see Figure 3.15).
- The locker door, the bolt set, and the front side of the GAT ECO.Side Lock 7000 BA must be perpendicular and parallel to each other. If not, the door contact in the GAT ECO.Side Lock 7000 BA can potentially not function correctly.

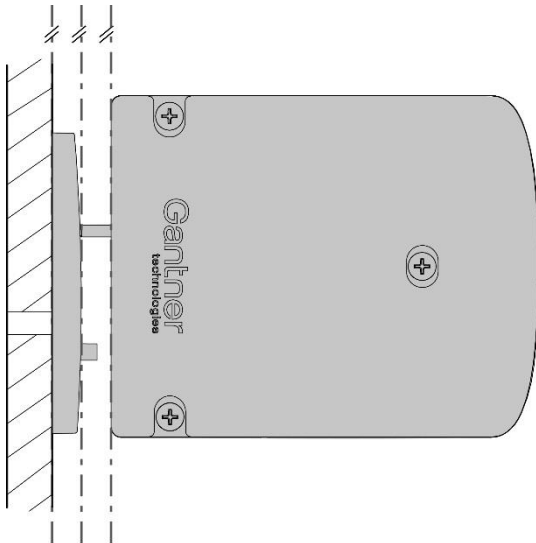

- If right and left-hinged locker doors are in use together, please note the correct LED position. The GAT ECO.Side Lock 7000 BA is mounted upside-down on left doors in comparison to right doors.

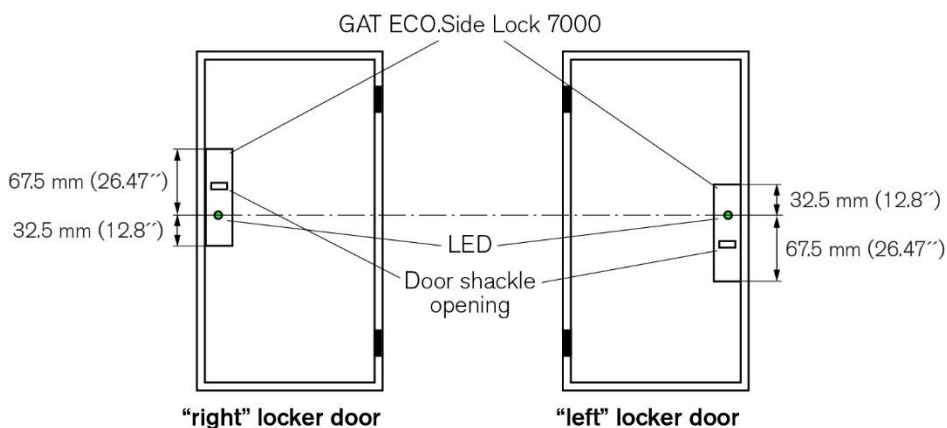

Figure 3.16 - LED positions of the GAT ECO.Side Lock 7000 BA for right and left-hinged doors

NOTE! Before installing all locks in a new locker system, a test installation of one lock into a completed locker and a function check must be performed. See section “3.3 Test Installation”.

3.12.2 Installation Instructions for the GAT ECO.Side Lock 7000 BA and Glass Doors

Complete the following steps to install the GAT ECO.Side Lock 7000 BA into lockers with glass doors.

- ▶ Drill 3 holes (3 in Figure 3.15) for the GAT ECO.Side Lock 7000 BA into the locker wall inner side according to the information in section "3.11.2 Installation Requirements for the GAT ECO.Side Lock 7000 BA and Metallic Doors" and the measurements in Figure 3.15.
- ▶ Insert the battery into the GAT ECO.Side Lock 7000 BA (see section "4.2.2. Inserting the Battery").
- ▶ Mount the GAT ECO.Side Lock 7000 BA with 3 screws (3) on the inside locker wall.

NOTE! Use the correct screws according to the type of locker material, max. Ø 4 mm (0.16"). The maximum allowed tightening torque of the screws is 2 Nm (1.47 lb-ft).

- ▶ Use glass adhesive to attach the GAT NET.Lock BoltSet 7300 in the correct position to the inside of the glass door. Observe the information in section "3.11.2 Installation Requirements for the GAT ECO.Side Lock 7000 BA and Metallic Doors" and the measurements in Figure 3.15.

NOTE! Before the mass production of lockers begins, testing must be carried out by the locker manufacturer to ensure that the glass adhesive meets the strength requirements. Always pay attention to the adhesive manufacturer's instructions.

- ▶ A label can be attached to the front of the locker door. The label has a transparent (matt) window for the LED to shine through and can be ordered with a GANTNER design or customer-specific design.

NOTE! For customer-specific labels, ensure that a transparent field for the status LED is incorporated in the design and that no metal foil or metal color are used.

- ▶ Test the locker door to confirm that it closes easily and that the door shackle inserts correctly into the GAT ECO.Side Lock 7000 BA. The locker door must spring open without assistance after it is unlocked.

4 COMMISSIONING

4.1 Target Group

This chapter provides information for technicians responsible for putting the GAT ECO.Side Lock 7000 BA and NW BA into operation. A base knowledge of electronics is assumed. Previous knowledge of the GAT ECO.Side Lock 7000 BA / NW BA is not required. Since the commissioning process is identical for both lock variants, the general term GAT ECO.Side Lock 7000 BA is used.

4.2 Power Supply

4.2.1 Battery Information

The GAT ECO.Side Lock 7000 BA is powered by one 3.6 V AA Lithium battery (see "8 TECHNICAL DATA"). The battery life span is designed around a defined number of locking cycles. The actual life span depends upon the number of locking cycles (usage frequency of the lock) and the environmental conditions. The battery must be replaced when the battery voltage becomes too low. If the battery becomes too weak, the locker can no longer be locked. The GAT ECO.Side Lock 7000 BA indicates a weak battery state with five red flashes of the LED and five acoustic signals during a locking attempt.

NOTE! For optimal battery lifespan, use the approved battery available from GANTER (Part No. 914430) to power the GAT ECO.Side Lock 7000 BA.

4.2.2 Inserting the Battery

Before putting the GAT ECO.Side Lock 7000 BA into operation, the battery must be inserted into the battery compartment.

NOTE! To avoid unnecessary battery usage, insert the battery directly before the GAT ECO.Side Lock 7000 BA is installed.

- ▶ To access the battery compartment, remove the red battery cover (1 in Figure 4.1) on the underside of the housing by sliding a finger under the tab section of the battery cover.

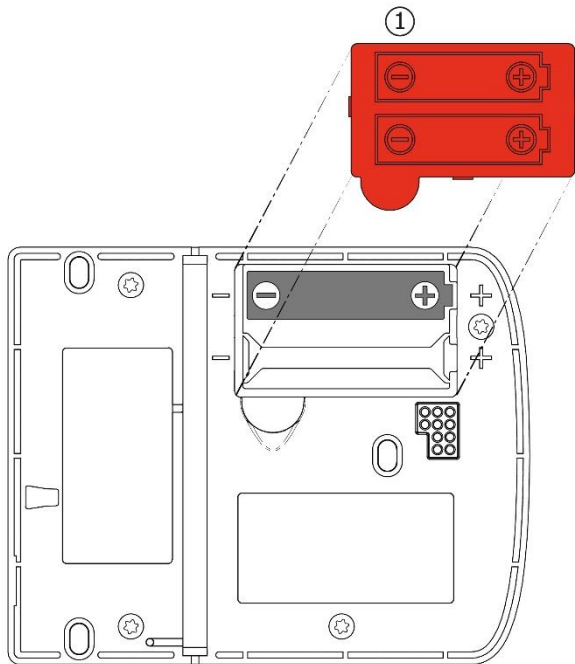

Figure 4.1 - GAT ECO.Side Lock 7000 BA battery compartment

- ▶ Ensure that the battery polarity is the same as shown in Figure 4.1.
- ▶ Press the battery down into the compartment until it locks into place.
- ▶ Reinstall the battery cover over the battery compartment and push down until the battery cover is level with the surrounding GAT ECO.Side Lock 7000 BA housing.
 - When installing the battery in the GAT ECO.Side Lock 7000 BA for the first time, the process is now complete.
 - When the lock has already been used and the battery is being replaced, the lock must be activated using the Battery data carrier (see “4.2.3 Replacing the Battery”).

i After inserting the battery, the GAT ECO.Side Lock 7000 BA is in start-up mode for approximately 2 minutes. During this time, the LED is solid green with a red flash every 4 seconds. The LED switches off and a sound signal is activated when start-up mode ends.

4.2.3 Replacing the Battery

The battery of the GAT ECO.Side Lock 7000 BA must be replaced when the LED flashes red 5 times and 5 beeps are emitted during a locking attempt. In this state, the GAT ECO.Side Lock 7000 BA can no longer be locked until the battery is replaced.



Always dispose of used batteries in an environmentally friendly way, e.g., at an electronic waste recycling facility.

Do not operate the GAT ECO.Side Lock 7000 BA while replacing the batteries. Following battery replacement, the GAT ECO.Side Lock 7000 BA must be returned to its normal operating mode using the Battery data carrier (see section “6.5.3. BATTERY Data Carrier”). In addition, the time and date must be set again using a PC and GAT Config Manager (see section “5 CONFIGURATION”).

- ▶ Unscrew the 3 screws that hold the GAT ECO.Side Lock 7000 BA to the locker wall and remove the lock from the locker.
- ▶ Follow the instructions described in section “4.2.2. Inserting the Battery”.
- ▶ Mount the GAT ECO.Side Lock 7000 BA to the locker wall inner side again.
- ▶ Press the locker door shut with one hand.
- ▶ Hold the Battery data carrier next to the RFID reading field.
 - The internal counter in the GAT ECO.Side Lock 7000 BA is reset and the lock returns to its normal operating mode.

4.3 USB Connection

A Micro-B USB port is provided on the side of the GAT ECO.Side Lock 7000 BA for computer connectivity. The computers must run Windows® operating system (Windows® 7 or newer). The USB port location on the side of the lock allows configuration to occur while the lock is installed in a locker.

NOTE! The maximum USB cable length between the GAT ECO.Side Lock 7000 BA and a computer is 5 m.

The Service data carrier (see “6.5.4 SERVICE Data Carrier”) is used to put the GAT ECO.Side Lock 7000 BA into configuration mode after the USB cable is connected. A 3 m USB cable, the Service data carrier, and the configuration software are included in the GAT ECO.Basic Set B BA (Part No. 958131). See section “6.4. GAT ECO.Basic Set B BA”.

To configure the GAT ECO.Side Lock 7000 BA via PC/laptop:

- ▶ Start GAT Config Manager on the PC/laptop.
- ▶ Plug the USB cable (type-A end) into a spare USB port on the PC/laptop.

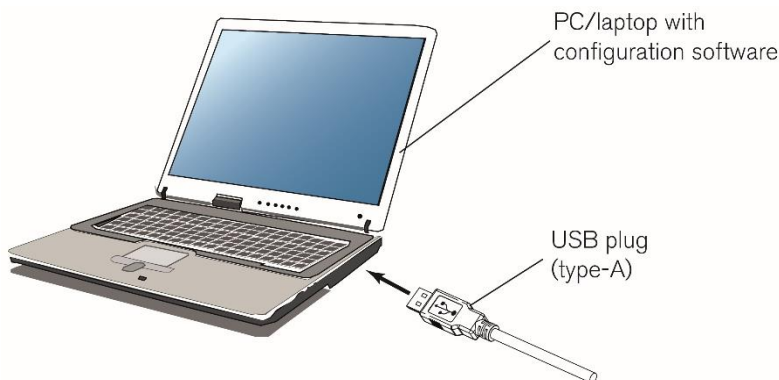

- ▶ Plug the Micro-B connector of the USB cable into the USB port on the GAT ECO.Side Lock 7000 BA.

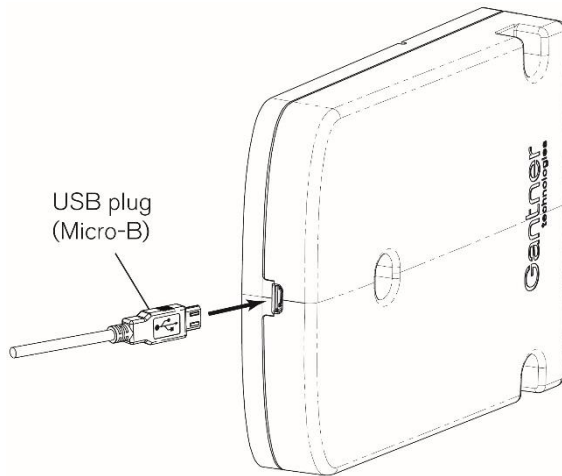

- After connecting the GAT ECO.Side Lock 7000 BA to the PC/laptop for the first time, the lock drivers are installed, and the lock is automatically recognized.

i If a driver is requested, they are available on the “Leisure Software” USB stick, which is included in the GAT ECO.Basic Set B BA.

- ▶ Hold the SERVICE data carrier next to the RFID reading field.

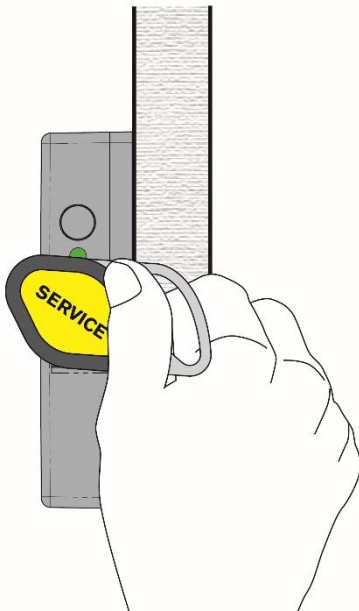

- The GAT ECO.Side Lock 7000 BA enters into configuration mode. The LED pulses green every 2 seconds to indicate this state.
- ▶ Click on “Configure” in GAT Config Manager to open the settings.

4.4 Automatic Antenna Adjustment

The antenna of the GAT ECO.Side Lock 7000 BA must be calibrated to ensure the optimal reading range for the RFID data carriers. To complete this calibration, the lock is equipped with an automatic antenna adjustment function that is activated using the SERVICE data carrier or via GAT Config Manager.

4.4.1 Antenna Adjustment using the Service Data Carrier

The SERVICE data carrier is included in the GAT ECO.Basic Set B BA (see "6.4 GAT ECO.Basic Set B BA"). Complete the following steps to activate the antenna adjustment function.

- ▶ Press the locker door shut with one hand.
- ▶ Hold the SERVICE data carrier next to the RFID reading field. Remove the data carrier immediately after activating the antenna adjustment.
 - The antenna adjustment process begins and the status LED flashes red for 5 seconds. The process is complete when the LED flashes green for 1 second and the lock emits a beep.



It is possible to activate the antenna adjustment function even when the locker door is locked.

4.4.2 Antenna Adjustment via GAT Config Manager

- ▶ While configuring the GAT ECO.Side Lock 7000 BA in GAT Config Manager (see "5 CONFIGURATION"), click on the "Antenna Adjustment" button. 
- ▶ Disconnect the USB cable from the lock and close the locker door. After disconnecting the USB cable, you must close the door within 15 seconds to activate the function.
 - The antenna adjustment process begins and the status LED flashes red for 5 seconds. The process is complete when the LED flashes green for 1 second and the lock emits a beep.



For locks with older firmware versions, the time limit to activate the function after disconnecting the USB cable is 7 seconds.

5 CONFIGURATION

5.1 General Information

The GAT ECO.Side Lock 7000 BA is configured using a PC/laptop and GAT Config Manager software. The configuration file must only be uploaded to the GAT ECO.Side Lock 7000 BA once. The configuration file for the first lock in the system is saved in GAT Config Manager and can then be uploaded to each lock that requires the same configuration. Locks that require a different configuration need a separate configuration file to be made in GAT Config Manager.

NOTE! After importing the configuration file to the first lock, complete an operational test to ensure the data carriers (MASTER and standard) and general lock functionality perform as required.

The following data is imported into the GAT ECO.Side Lock 7000 BA during configuration:

- Site key
- Sub-site number
- Locker number
- Operating mode of the GAT ECO.Side Lock 7000 BA ("free locker", "free locker universal", "free locker unique number", "personal locker programming card", or "personal locker expiry date". See section "6.3 Operating Modes")
- Free Locker: Sector number of the data on the data carrier and the time setting for "limited duration of use" function
- Date and time (set automatically)
- Unique numbers of the MASTER data carriers (and OPEN MASTER data carriers, if used)

i The MASTER data carriers and OPEN MASTER data carriers can also be directly programmed into the GAT ECO.Side Lock 7000 BA (see section "6.5.1 MASTER Data Carrier"). However, the most efficient way to program the data carrier numbers into multiple locks is via PC and GAT Config Manager.

NOTE! The GAT ECO.Side Lock 7000 BA does not set the daylight-saving time automatically. Time changes due to daylight saving must be considered when evaluating bookings and when authorizing data carriers with expiry dates/times.

5.2 Setup for Configuration in GAT Config Manager

Once the battery is installed in the GAT ECO.Side Lock 7000 BA (see "4.2.2. Inserting the Battery"), the USB cable connected from the lock to the computer (see "4.3. USB Connection"), and the SERVICE data carrier used to activate configuration mode (see "6.5.4 SERVICE Data Carrier"), the settings can be viewed and configured using GAT Config Manager.

i There is a separate manual with detailed information on each function available in GAT Config Manager. To access the manual while the software is open, click on the "Help" drop-down menu and select "How Do I?".

Complete the following steps to setup for configuration in GAT Config Manager.

- ▶ After installing the software, open GAT Configuration Manager via "Start" -> "All Programs" -> "GANTNER Electronic GmbH" -> "GAT Config Manager" -> "GAT Config Manager".
 - The default start window of GAT Config Manager is displayed.
- ▶ Click on the "Open Project" icon (1 in Figure 5.1) to find an existing project. Alternatively, click on the "Create Project" icon (2 in Figure 5.1) to start a new project.



Figure 5.1 – GAT Config Manager - project setup

- ▶ Once a project is established, locations and sub-locations for the project can be added to the "Devices" directory (2 in Figure 5.2) by clicking on the "Add location" button (1 in Figure 5.2).

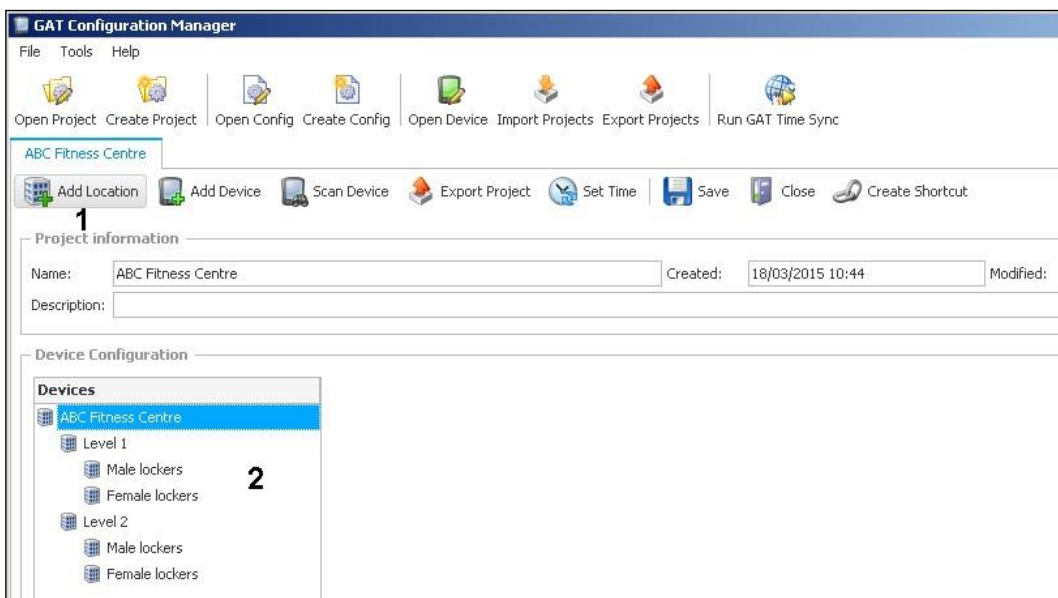

Figure 5.2 – GAT Config Manager – Add location

- ▶ To add a GAT ECO.Side Lock 7000 BA to a location, right-click on the location and select "Add ECO.Side Lock 7000" from the "Add Device" menu (Figure 5.3).
 - The GAT ECO.Side Lock 7000 BA is added to the selected location and displayed with the name "GAT ECO.Side Lock 7000".

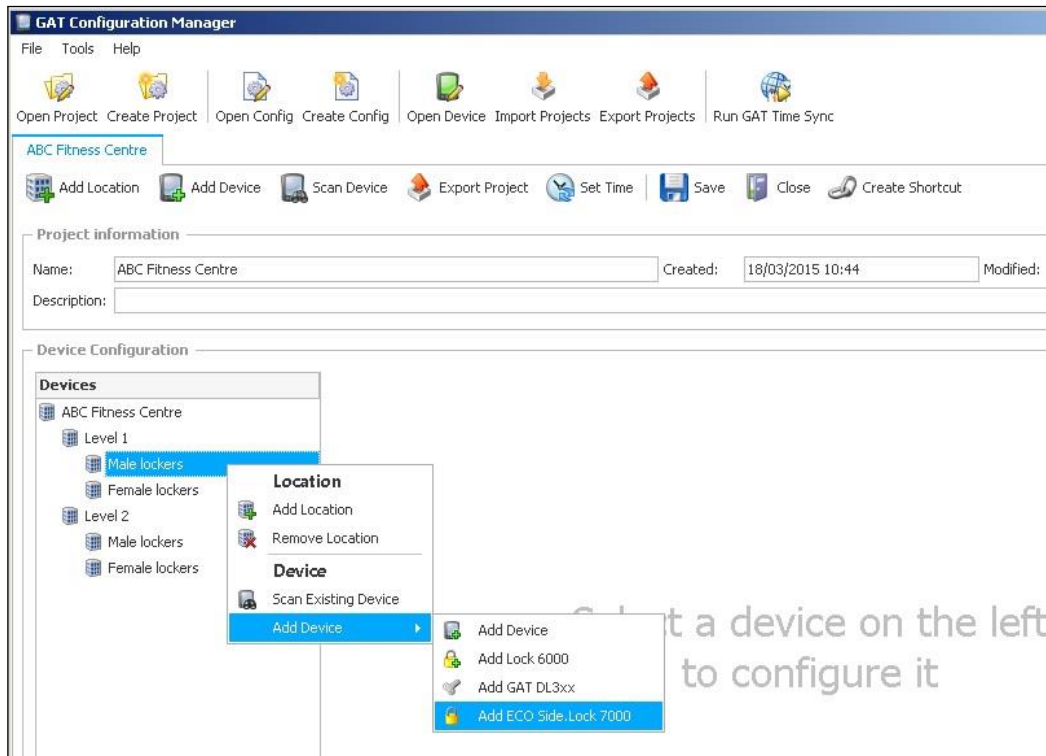

Figure 5.3– GAT Config Manager – Adding a GAT ECO.Side Lock 7000 BA

5.3 View and Edit the GAT ECO.Side Lock 7000 BA Configuration Settings

Once the connected GAT ECO.Side Lock 7000 BA has been added to the “Devices” directory, you can now view and adjust the configuration settings of the lock. Complete the following steps to view the configuration settings.

- ▶ Select the GAT ECO.Side Lock 7000 BA from the “Devices” directory (1 in Figure 5.4), which is displayed here as “GAT ECO.Side Lock 7000”.
 - The GAT ECO.Side Lock 7000 BA is highlighted in blue.



Figure 5.4– GAT Config Manager – View configuration settings

- ▶ Click on the “(2) Configure” button (2 in Figure 5.4).
 - The GAT Configurator window opens (Figure 5.5).

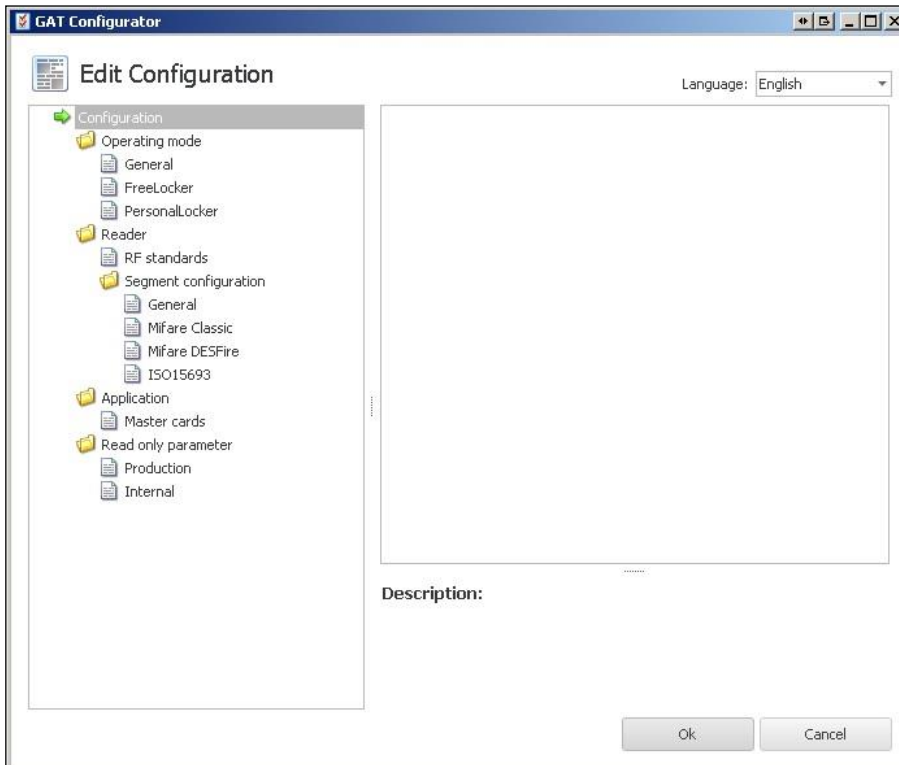

Figure 5.5 – GAT Configurator window

5.4 Upload Configuration Settings to the GAT ECO.Side Lock 7000 BA

When you are finished configuring the GAT ECO.Side Lock 7000 BA settings in GAT Config Manager, it is important to finalize the configuration by uploading the file to the lock. Complete the following steps to finalize the configuration.

- ▶ Click on “OK” in the GAT Configurator Window (Figure 5.5).
 - The following confirmation window opens.



- ▶ Click “Yes” to apply the configuration to the lock.
 - The configuration settings are uploaded to the GAT ECO.Side Lock 7000 BA.

5.5 Updating the GAT ECO.Side Lock 7000 BA Firmware

GANTNER periodically releases firmware updates for the GAT ECO.Side Lock 7000 BA. In order to take advantage of the latest features, it is recommended to update the GAT ECO.Side Lock 7000 BA to the latest firmware during configuration or at regular intervals.

- ▶ Right-click onto the GAT ECO.Side Lock 7000 in the “Devices” tree and select “Update Firmware”.

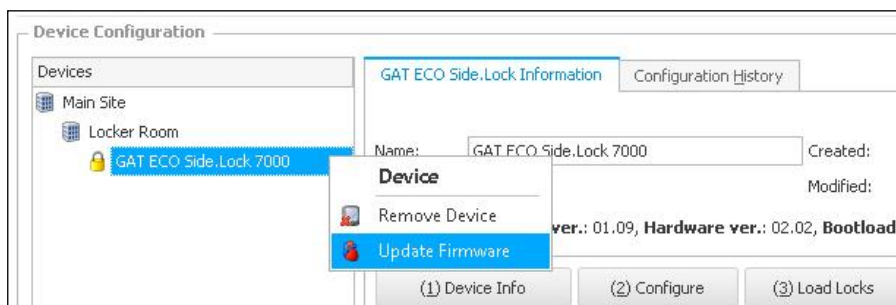

Figure 5.6 – Updating the GAT ECO.Side Lock 7000 BA firmware

- The “Device update wizard” opens where all available updates are listed.
- ▶ Hover over the update version with the mouse to display the new features included with the update.
- ▶ Select the most recent update then click on “Next”.

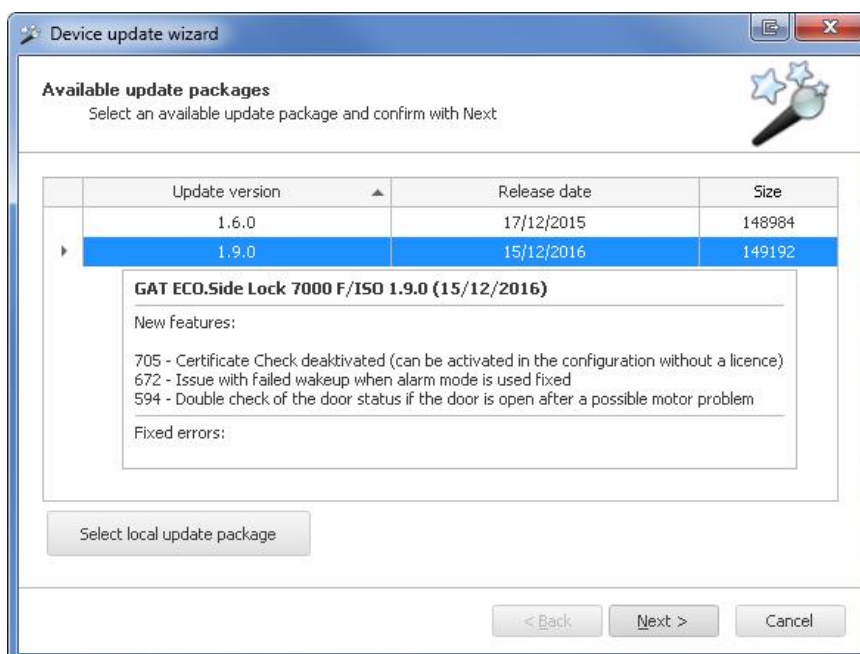

Figure 5.7 – Device update wizard

- The “Device update wizard” downloads the update and uploads it to the GAT ECO.Side Lock 7000 BA, which usually takes around 1 minute.
- ▶ Click on “Finish” when the update process is completed.

5.6 Configuration Settings of the GAT ECO.Side Lock 7000 BA

The main configuration settings of the GAT ECO.Side Lock 7000 BA that can be adjusted in GAT Config Manager are explained in this section. A list and brief explanation of every configuration setting available for the GAT ECO.Side Lock 7000 BA can be found in section “5.6.9 Configuration Settings Table”.

5.6.1 Operating Mode

The GAT ECO.Side Lock 7000 BA can operate in one of five different operating modes. See “6.3 Operating Modes” for a detailed description of each mode. The operating mode setting is found here:

Configuration > Operating mode > General > Operating mode

- ▶ From the “Operating mode” drop-down menu, select either:
 - “Free locker”,
 - “Free locker universal”,
 - “Personal locker programming card”,
 - “Personal locker expiry date”, or,
 - “Free locker unique number”

5.6.2 Locker Number

The number of the locker where the GAT ECO.Side Lock 7000 BA is installed can be defined. The locker number setting is found here:

Configuration > Operating mode > General > Locker number

- ▶ Enter the locker number for the GAT ECO.Side Lock 7000 BA into the “Locker number” field.

5.6.3 Sound Signals

The GAT ECO.Side Lock 7000 BA has an integrated beeper that signals when locker activity takes place. The sound signals setting is found here:

Configuration > Operating mode > General > Beeper mode

- ▶ Select / deselect the “Beeper mode” option to turn the sound signals on / off.

NOTE! When deactivated, the sound signals are still activated when an alarm is triggered and when the GAT ECO.Side Lock 7000 BA is used with system data carriers, e.g., unlocked using a MASTER data carrier.

5.6.4 Alarm Mode

The GAT ECO.Side Lock 7000 BA is designed to detect when somebody attempts to force open a locker door. The lock emits a loud, intermittent alarm tone and the status LED flashes red when an alarm is triggered. The alarm mode function is found here:

Configuration > Operating mode > General > Alarm mode

- ▶ Select / deselect the “Alarm mode” option to turn the function on / off.

5.6.5 Auto-Unlock

The auto-unlock function automatically unlocks the GAT ECO.Side Lock 7000 BA at a defined point in time. The time must be set correctly once via software.

NOTE! When this function is activated, the lock will always unlock at the defined point of time regardless of the operating mode (see “6.3 Operating Modes”).

The auto-unlock function is found here:

Configuration > Operating mode > General > AutoUnlock [min]

- ▶ Enter a value representing the number of minutes into the field. The countdown time for unlocking begins at 00:00 (24 h). For example, a value of “300” means that the lock will unlock at 05:00 am. A value of “0” means that the function is inactive.

5.6.6 Duration of Use

Lockers operating in free locker mode can be configured to restrict users to a defined usage period. See section “6.3.1 Free Locker Mode (with or without Duration of Use Function)” for more information. The duration of use function is found here:

Configuration > Operating mode > Free Locker

- ▶ Select either “Duration” or “Point of time” from the “Use time limit” menu for the type of time limit.
- ▶ Define the time limit in minutes in the “Time limit (min)” field.

5.6.7 Locking of Personal Locker without data carrier

The functionality of locking personal lockers without data carriers allows the locker to lock automatically when the locker door is pushed shut, without needing to use a data carrier. The locker can be unlocked again using the data carrier(s) authorized to use the personal locker. The function is found here:

Configuration > Operating mode > Personal Locker > PreLock Personal Locker

- ▶ Select / deselect the “PreLock Personal Locker” option to turn the function on / off.

5.6.8 MASTER Data Carriers

Up to 10 MASTER data carriers (usually in card format) can be assigned to the GAT ECO.Side Lock 7000 BA to allow the locker to be opened in special circumstances, e.g., when a user has lost their data carrier. For this functionality, the MASTER data carriers must be first assigned to the GAT ECO.Lock 7xxx F/ISO, which is done here:

Configuration > Application > Master cards > Master Card 1 - 10

- ▶ Enter the number of each MASTER data carrier into the respective fields.

NOTE! The numbers of the MASTER data carriers must be entered in hexadecimal format.



There is also an OPEN MASTER data carrier available (not included in the Basic Set). This special data carrier can open all lockers (like the MASTER data carriers) but cannot close the lockers. It is possible to program an OPEN MASTER data carrier by entering the number of the OPEN MASTER data carrier in one of the 10 fields. In this case only 9 MASTER data carriers can be used.

5.6.9 Configuration Settings Table

The following table lists all the configuration information available for the GAT ECO.Side Lock 7000 BA in GAT Config Manager.

Options	Description	Format	Default
Operating mode			
General			
Operating mode	Select the operating mode of the lock: - "FreeLocker" - "PersonalLocker_ProgrammingCard" - "PersonalLocker_ExpiryDate" - "FreeLocker_UniqueNumber" - "FreeLockerUniversal"	List option	Free Locker
Locker number	Enter the locker number here	Integer	30000
Beeper mode	Switch on/off the lock sound signal function	Boolean	True
Alarm mode	Switch on/off the alarm function	Boolean	False
AutoUnlock [min]	Unlock locker at a defined point in time. 0 = inactive	Integer	0
CardValidityDateRequired	When this option is activated, a valid expiration date must be set on the data carriers so that they can be used (default value of 1.1.2007 is not valid)	Boolean	False
LastOpenAtExpiredDate	When this option is activated, a locker can be unlocked one more time using the data carrier that locked it (see "6.3.5 Personal Locker Expiry Date Mode").	Boolean	True
Free Locker			
Use TimeLimit	Select the type of time limit for the locker (see "6.3.1 Free Locker Mode (with or without Duration of Use Function) "Duration" or "Point of time"	List option	Duration
TimeLimit (min)	Define the time limit in minutes	Integer	60
TimeLimit Interrupt Timeout [min]	Minimum waiting time from the end of a locker usage period until the next usage period can begin.	Integer	60
Personal Locker			
Index PersonalLocker	Define the index of the personal locker	Integer	0
PreLock PersonalLocker	Switch on/off the automatic lock function without data carrier for personal lockers	Boolean	False
PersonalLockerSecureFlag	When this option is activated, a new index or validity date can only be transferred from a data carrier to the lock when the locker is open. When this option is deactivated, transferal is possible even when the locker is locked (see "6.3.5 Personal Locker Expiry Date Mode")	Boolean	False

Options	Description	Format	Default
Reader			
RF Standards			
LEGIC	When set to "True", LEGIC data carriers can be read by the lock. This setting is not configurable	Boolean	True
ISO 15693	When set to "True", ISO 15693 data carriers can be read by the lock.	Boolean	False
ISO 14443A	When set to "True", ISO 14443 (MIFARE) data carriers can be read by the lock.	Boolean	False
Segment configuration			
General			
Site key	Site key of the device. All data carriers must have the same site key to be used with the device.	Hex	9999
LEGIC prime			
SearchStr	Search string. This setting is not configurable	Integer	IA2200999 903
SearchStrLen	Search string length. This setting is not configurable	Integer	6
LegicLocker	Select the LEGIC locker	List option	Locker 1
Application			
Master cards			
Master Card 1 - 10	Fields to enter number for MASTER cards 1 to 10 and/or OPEN MASTER data carriers	Integer	
Read only parameter			
Production			
Article Num	Article number of the device	Integer	
Serial Num	Serial number of the device	Integer	
Manufacturer Num	Manufacturer number of the device	Integer	
Production Year	Production year of the device	Integer	
Production Week	Production week of the device	Integer	
HardwareUIDNum	Unique ID number of the hardware	Integer	
Controller Type	Controller type of the device		
Hardware Vers	Hardware version of the device	Integer	
Bootloader Vers	Bootloader version of the device	Integer	
Firmware Vers	Firmware version of the device	Integer	
LockEngineVers	Lock logic version of the device	Integer	

Table 5.1 – Configuration settings for the GAT ECO.Side Lock 7000 BA in GAT Config Manager

6 OPERATION

6.1 General

The GAT ECO.Side Lock 7000 BA can operate in "free locker" mode or "personal locker" mode. In free locker mode, the locker user may select any unoccupied locker they want to use. In personal locker mode, locker users are assigned a specific locker to which only they have access.

When free lockers and personal lockers are used together in one system, it is recommended that the locker numbers are unique for both functions. This means that the same locker number should not be used for both a personal locker and a free locker.

6.2 Target Group

This chapter contains information for the technicians who commission the GAT ECO.Side Lock 7000 BA and who check it in case of operation problems.

6.3 Operating Modes

The GAT ECO.Side Lock 7000 BA can function in one of the following operating modes:

- Free locker (with or without duration of use function)
- Free locker universal
- Free locker unique number
- Personal locker programming card
- Personal locker expiry date

Requirements for MIFARE and ISO 15693 data carriers

All MIFARE and ISO 15693 data carriers that are used in the system must meet the operating mode requirements as specified in the following table.

Operating Mode	Requirements for Data Carriers
Free locker	Data carriers must be coded accordingly
Free locker universal	The locker segment must be unused (encoded with all zeros) and the access keys must be correct
Free locker unique number	All MIFARE and ISO 15693 data carriers are possible
Personal locker programming card	All MIFARE and ISO 15693 data carriers are possible
Personal locker expiry date	Data carrier must be coded accordingly

Table 6.1 - Requirements for data carriers

6.3.1 Free Locker Mode (with or without Duration of Use Function)

In "free locker" operating mode, the user has the option of selecting a free locker and locking it using their data carrier. After the locker has been locked, the user cannot occupy any additional lockers within the same locker group. Only once the original locker has been unlocked can the user lock another locker in the locker group.

Locker groups are used to organize the locks within a system into certain functional blocks, e.g., changing room lockers, safe-deposit boxes, etc. Different sector numbers are used on the data carriers to distinguish between the locker groups, which allows two or more lockers from different groups to be used with the same data carrier, depending on the data carrier storage space.

For data carriers that are configured with an expiry date, the date is checked by the GAT ECO.Side Lock 7000 BA. If the date has passed, the locker cannot be used.

NOTE! The GAT ECO.Side Lock 7000 BA does not automatically adjust to summer/winter time changes. This must be considered when defining the validity or expiry date.

Duration of Use function

Free locker mode also offers the possibility to define a duration of use for each locker. If a locker with this function is locked with a data carrier, the current time is written onto the data carrier and the time subsequently checked when the user attempts to open the locker again.

The locker can be locked/unlocked as often as required during the duration of use period. If the duration of use period is exceeded, the data carrier can no longer unlock the locker. In this case, the user must release their data carrier at an Info Terminal, e.g. a GAT Info 6100 BA (part no. 858938) or a GAT Info 6150 BA (part no. 921323).

NOTE! This function is only possible with coded LEGIC advant data carriers and not possible with LEGIC prime data carriers. In addition, the GAT ECO.Side Lock 7000 BA must be configured in GAT Config Manager for the function (see section "5.6.6. Duration of Use"). There are two configuration modes for the function:

- Absolute duration of use ("Duration" function)

In this mode, a usage period (depending on the "Time limit" parameter in minutes or hours, see "5.6.9 Configuration Settings Table") is configured. After locking a locker, the user must unlock the locker again within the defined period. The period begins from when the locker was first locked.

Example:

The time is set to 360 minutes. If the locker is locked at 17:00, it can be unlocked until 23:00. If the locker is locked at 21:00, it can be unlocked until 03:00 of the next day. The duration of use time is reset after the locker remains open for 60 minutes.

- Use up to a specific time after midnight ("Point of time" function)

In this mode, a time is configured up to which the locker can be used every day. After locking a locker, the locker must be unlocked before the defined time. The usage period starts from the configured time after midnight.

Example:

The time is set to 120 minutes. As the calculation begins at midnight, the locker can be used until 02:00 the following day regardless of when the locker was locked. If the locker is locked, e.g., at 01:00, it can be unlocked until 02:00 of the following day. If the locker remains locked past this time, the data carrier can no longer unlock the locker. In this case, the user must recode the data carrier at a central station.

Locking and unlocking lockers

- ▶ Close the locker door and hold it shut.
- ▶ Hold the data carrier next to the RFID reading field.
 - The information on the data carrier is read.
- ▶ a) Valid data carriers: The LED flashes green briefly and the locking action is carried out. If the duration of use function is enabled, the time on the data carrier is checked and the current time written onto the data carrier.
- ▶ b) Invalid data carriers: The LED flashes red briefly and the GAT ECO.Side Lock 7000 BA does not complete the locking action. Possible reasons for this include:
 - Another locker has already been locked using the data carrier. In this case, the first locker must be unlocked before the data carrier can be used with the new locker.
 - The duration of use period has been exceeded and the locker cannot be opened anymore. In this case, the data carrier must be reset at a central station.
- ▶ Release the locker door.

6.3.2 **Free Locker Universal Mode**

“Free locker universal” operating mode differs from the standard free locker mode in the following ways:

- Free locker universal mode allows the use of data carriers that are also used for other applications
- No validity date with free locker universal mode
- Not possible to use a duration of use time with free locker universal mode
- The following requirements for the data carriers apply:
 1. The locker segment must be unused and "empty", i.e., coded with all zeros.
 2. The Access Keys must be correct.

Locking and unlocking lockers

- ▶ Close the locker door and hold it shut.
- ▶ Hold the data carrier next to the RFID reading field.
 - The information on the data carrier is read.
- ▶ a) Valid data carriers: The LED flashes green briefly and the locking action is carried out.
- ▶ b) Invalid data carriers: The LED flashes red briefly and the GAT ECO.Side Lock 7000 BA does not complete the locking action.
- ▶ Release the locker door.

6.3.3 Free Locker Unique Number Mode

“Free locker unique number” operating mode differs from the standard free locker mode in the following ways:

- All MIFARE and ISO 15693 data carriers can operate with the lock.
- The data carrier can have a GANTNER locker segment, however the segment is not used for this mode.
- When a locker is locked with a data carrier, the locker number is not written onto the data carrier.
- Every data carrier can use (lock) any number of lockers at the same time.

Locking and unlocking lockers

- ▶ Close the locker door and hold it shut.
- ▶ Hold the data carrier next to the RFID reading field.
 - The information on the data carrier is read.
- ▶ a) Valid data carriers: The LED flashes green briefly and the locking action is carried out.
- ▶ b) Invalid data carriers: The LED flashes red briefly and the GAT ECO.Side Lock 7000 BA does not complete the locking action.
- ▶ Release the locker door.

6.3.4 Personal Locker Programming Card Mode

For lockers operating in “personal locker programming card” mode, up to 32 data carriers per GAT ECO.Side Lock 7000 BA can be authorized for use. The data carriers can be used with the locker as often as required and share the same authorization access, e.g., family cards.

The data carriers are authorized for use with the personal locker using the PROGRAM data carrier (included in the GAT ECO.Basic Set B BA, see section “6.4. GAT ECO.Basic Set B BA”).

Authorizing data carriers

- ▶ Close the locker door and hold it shut.
- ▶ Hold the PROGRAM data carrier next to the RFID reading field.
 - The information on the data carrier is read.
- ▶ The GAT ECO.Side Lock 7000 BA enters into programming mode.
 - The LED flashes red until the PROGRAM data carrier is removed. As soon as the PROGRAM data carrier is removed, the LED flashes red/green and the lock is ready to program data carriers.
- ▶ Within 5 seconds, hold the data carrier to be authorized next to the reading field.
- ▶ a) Successful authorization: The LED flashes green for approximately 3 seconds. When the data carrier is removed, the LED flashes green and red alternately again and another data carrier can be authorized in the same way. Repeat this process until all the data carriers are authorized.
- ▶ b) Unsuccessful authorization: The LED flashes red three times then the GAT ECO.Side Lock 7000 BA switches off. Possible reasons for this include:
 - The maximum of 32 data carriers are already authorized for use with the lock.
 - The data carrier was not read by the lock correctly, e.g., the data carrier is damaged.

You can repeat the last step using different data carriers to program these data carriers successively. To do this, hold the data carrier next to the reading field within 5 seconds after removing the previous data carrier. If you wait longer than 5 seconds, the reading process is terminated, and the read data carriers are saved in the lock.

Deleting (removing authorization) data carriers

When deleting data carriers authorized to use a personal locker, it is only possible to delete all data carriers in the GAT ECO.Side Lock 7000 BA at once.

- ▶ Close the locker door and hold it shut.
- ▶ Hold the PROGRAM data carrier next to the RFID reading field.
 - The information on the data carrier is read.
- ▶ The GAT ECO.Side Lock 7000 BA enters into programming mode.
 - The LED flashes red until the PROGRAM data carrier is removed. As soon as the PROGRAM data carrier is removed, the LED flashes red/green and the lock is ready for the next step.
- ▶ Within 5 seconds, hold the PROGRAM data carrier next to the reading field again.
- ▶ If the action is successful, the LED flashes red 3 times and the GAT ECO.Side Lock 7000 BA switches off.
 - All data carriers are now deleted from the lock and cannot use the locker any more.

6.3.5 **Personal Locker Expiry Date Mode**

During check-in, the guest receives a data carrier encoded with GANTNER data blocks. The FID is written onto the "general" data block and the guest's personal locker number together with the expiry date ("valid from" and "valid to") are written onto the "locker" data block of the data carrier. Furthermore, an index value is written onto the "locker" data block. The "valid from" date must always be valid, i.e., newer or equal to the date set in the GAT ECO.Side Lock 7000 BA.

Upon first use of a locker, the expiry date ("valid to" date) and the current index value of the data carrier are stored in the lock. The guest can lock and unlock the locker as required, starting from the "valid from" date and for as long as the expiry date is not reached or exceeded.

NOTE! The GAT ECO.Side Lock 7000 BA does not adjust to daylight saving time automatically. This must be considered when evaluating events and authorizing data carriers with an expiry date.

An unlimited number of data carriers (people) can use the same locker. The following conditions apply to the data carriers in this mode:

- The same locker number must be stored on the data carriers.
- The same expiry date must be stored on the data carriers.
- The same index value must be stored on the data carriers.

When one of the data carriers assigned to a guest is used at the locker for the first time, the expiry date and the index value of the data carrier is written onto the locker.

Locking and unlocking lockers

- ▶ Close the locker door and hold it shut.
- ▶ Hold the data carrier next to the RFID reading field.
 - The information on the data carrier is read. The locker number on the data carrier must correspond with the locker number in the lock.
- ▶ The following situations are possible. The data carrier...
 - 1) ...is the first data carrier used at the locker:
 - The index value and the "valid to" date of the data carrier are saved in the lock. The data carrier can lock and unlock the locker until the end of the validity period.
 - 2) ...has the same index value and "valid to" date as stored in the lock:
 - The data carrier is now authorized to lock and unlock the locker like the previously authorized data carriers.
 - 3) ...has a higher index value than in the lock:
 - The new index value and the "valid to" date of the data carrier are saved in the lock. The previously authorized data carriers are no longer authorized to use the locker.
 - 4) ...has the same index value and a newer "valid to" date than in the lock:
 - The index value and the new "valid to" date of the data carrier are saved in the lock. The previously authorized data carriers are no longer authorized to use the locker.

NOTE! Situation 2) is possible when the locker is locked or unlocked. Situations 3) and 4) are possible with a locked or unlocked locker except when the "PersonalLockerSecureFlag" option is set (see "5.6.9 Configuration Settings Table"). With this option set, the procedure is only possible with an open (unlocked) locker.

- ▶ Release the locker door.
- ▶ a) Valid data carriers: The information on the data carrier is saved in the lock. The locker state will switch, i.e., the locker will open when it was locked or will lock when it was open.
- ▶ b) Invalid data carriers: The LED flashes red briefly and the GAT ECO.Side Lock 7000 BA switches off without carrying out an action.

There is also no unlimited usage period for the locker, i.e., the expiry date must be a valid date and not be "0". Once the "valid to" date is reached the locker cannot be unlocked using the data carrier anymore.

6.4 GAT ECO.Basic Set B BA

The following items are included in the GAT ECO.Basic Set B BA (Part No. 958131).

System data carriers:

- MASTER data carrier (3 pieces, red)
- OPEN MASTER data carrier (optional)
- DELETE MASTER data carrier (orange) / formerly RESET data carrier (green)
- PROGRAM data carrier (black)
- BATTERY data carrier (blue)
- SERVICE data carrier (yellow)
- Battery cover key for the GAT ECO.Side Lock 7000 (NW) BA with BATTERY data carrier functionality.

Additional items:

- 3 m USB programming cable
- GANTNER USB stick with configuration software
- GANTNER lanyard

6.5 Summary of System Data Carriers

The data carriers included in the GAT ECO.Basic Set B BA are required to configure and maintain a GAT ECO.Side Lock 7000 BA locker system.



The system data carriers are coded to function with specific installations and will only function with the respective system.

6.5.1 MASTER Data Carrier

MASTER data carriers can lock and unlock any GAT ECO.Side Lock 7000 BA in a system. If a user's data carrier is lost, an emergency opening of the corresponding locker can be carried out using a MASTER data carrier. Three MASTER data carriers are included in the Basic Set and they are only valid for the respective system.

NOTE! The system operator must ensure that the MASTER data carriers are stored in a safe and secure location.

If a MASTER data carrier is lost, a replacement can be ordered from GANTNER Electronic GmbH. Before the new MASTER data carrier is used, the original MASTER data carriers must be deleted from the GAT ECO.Side Lock 7000 BA (the number of a MASTER data carrier is stored in the lock the first time it is used). This is carried out using the DELETE MASTER data carrier as follows:

- ▶ Close the locker door and hold it shut.
- ▶ Hold the DELETE MASTER data carrier next to the RFID reading field.
 - The information on the data carrier is read and the LED flashes red until the DELETE MASTER data carrier is removed.
- ▶ Remove the DELETE MASTER data carrier from the reading field.
 - All MASTER data carriers are now deleted from the lock
 - The LED flashes green and red alternately and the new MASTER data carriers can be programmed.

- ▶ Within 5 seconds, hold the first MASTER data carrier next to the reading field.
 - When the data carrier is read correctly, the LED is green for 2 seconds.
- ▶ Remove the MASTER data carrier from the reading field.
 - The LED flashes green and red alternately. The second MASTER data carrier can now be programmed.
- ▶ Repeat the process until all MASTER data carriers are programmed.
- ▶ When a MASTER data carrier is read for longer than 5 seconds during programming, the lock automatically returns to the normal operating mode and the new MASTER data carriers are saved in the lock.

6.5.2 OPEN MASTER Data Carrier

The OPEN MASTER data carriers can unlock any GAT ECO.Side Lock 7000 BA in a system. If a user's data carrier is lost, an emergency opening of the corresponding locker can be carried out using an OPEN MASTER data carrier. Compared to the MASTER data carrier, the OPEN MASTER data carrier can only unlock a locker, but cannot lock the locker.

The OPEN MASTER data carrier is not included in the Basic Set and must be ordered separately if required. This data carrier is only valid for the respective system.

NOTE! The system operator must ensure that the OPEN MASTER data carriers are stored in a safe location that is secured against unauthorized access.

An OPEN MASTER data carrier can be used instead of an original MASTER data carrier. To program the OPEN MASTER data carrier into a lock, read the data carrier at the lock. If already the max. amount of MASTER data carriers (10) are programmed into the lock, the MASTER data carriers must first be deleted and the OPEN MASTER data carrier must be programmed together with the required MASTER data carriers (max. total amount of 10).

6.5.1 DELETE MASTER Data Carrier

Formerly known as the RESET data carrier, the DELETE MASTER data carrier is used to delete all the MASTER data carriers stored in the lock. See section "6.5.1. MASTER Data Carrier".

6.5.2 PROGRAM Data Carrier

For lockers operating in personal locker mode, the PROGRAM data carrier is used to authorize data carriers so they can be used with the locker. The PROGRAM data carrier is also used to delete the existing authorizations of personal lockers. See section "6.3.4. Personal Locker Programming Card Mode".

6.5.3 BATTERY Data Carrier

After the battery is replaced in the GAT ECO.Side Lock 7000 BA, the lock is in battery replacement mode and must be returned to the normal operating mode using the BATTERY data carrier. The internal action counter is reset to zero when the BATTERY data carrier is used. See section “4.2.3. Replacing the Battery” for more information.

i After replacing the batteries of a GAT ECO.Side Lock 7000 BA in personal locker mode, all settings stored in the lock remain as previously configured.

6.5.4 SERVICE Data Carrier

The SERVICE data carrier is used to put the GAT ECO.Side Lock 7000 BA into configuration mode after the lock is connected to a computer via USB (see section “4.3 USB Connection”). The settings of the GAT ECO.Side Lock 7000 BA are configured using GAT Config Manager while the lock is in configuration mode (see chapter “5 CONFIGURATION”).

When the GAT ECO.Side Lock 7000 BA reads the SERVICE data carrier without being connected to a PC via USB cable, an antenna calibration is performed, which locks the lock for a few seconds. After locking, the LED flashes red and the SERVICE data carrier must be removed. The antenna is calibrated and the LED flashes green. Finally, a green LED and sound signal are emitted to indicate that the antenna calibration has been performed successfully. The locker is then unlocked if it was locked before the calibration.

NOTE! The SERVICE data carrier must be available for technicians who are required to configure the locker system. Without the SERVICE data carrier, system configuration is not possible!

6.6 Alarm and Handling

The GAT ECO.Side Lock 7000 BA is designed to detect when somebody attempts to force open a locker door. To alert facility staff to the break-in, a loud, intermittent alarm signal is activated and the status LED flashes red.

i Upon delivery, the GAT ECO.Side Lock 7000 BA alarm function is deactivated. See section “5.6.4. Alarm Mode” for information on how to activate the function.

To deactivate a locker alarm:

- ▶ Close the locker door and hold it shut.
- ▶ Hold a MASTER data carrier next to the RFID reading field (see section “6.5.1. MASTER Data Carrier”).
 - The alarm sound signal is deactivated and the LED stops flashing.
- ▶ If the locker door is still locked, hold a MASTER data carrier or the data carrier previously used to lock the locker next to the RFID reading field.
 - The locker door opens.

NOTE! The GAT ECO.Side Lock 7000 BA, bolt set, and door shackle must all be replaced following a break-in.

6.7 Signalization Overview

The electronics in the GAT ECO.Side Lock 7000 BA are activated by pushing the locker door shut, i.e., when the door shackle is fully inserted into the opening of the lock. This activation is signaled by the LED flashing orange once. Directly thereafter the following lock states are signaled by the LED.







LED Color	Signalization	Meaning
	1 x orange flash	- Lock ready to read a data carrier
	1 x red flash	- No authorization - Error
	1 x green flash	- Data carrier accepted - Operation successful
	- 1 x green flash - Beeps ascending in pitch	- Battery replacement successfully completed - Lock operating in the normal operating mode again
	Flashing red/green	- Lock is in configuration mode - Lock waiting to read a data carrier
	- 5 x red flashes - 5 x beeps	- Battery change required

Table 6.2 - Overview of the signalization

7 CLEANING AND MAINTENANCE

NOTICE

Risk of damage or failure to the GAT ECO.Side Lock 7000 BA / NW BA

- The instructions described in this chapter may only be carried out by suitably trained personnel.
- The warnings in this chapter must be observed and followed during functional testing, cleaning, and maintenance.

7.1 Target Group

This chapter provides information for the technicians and cleaning personnel who are responsible for the periodical cleaning and maintenance of the GAT ECO.Side Lock 7000 BA / NW BA (the general term GAT ECO.Lock 7000 BA is used for both locks in the following description).

7.2 Functional Testing

To ensure that the locker locks are functioning correctly, periodically test the functionality of the locker doors and lock components.

Frequency

- After every 1000 locking operations, or,
- If the locking function of a locker door is impaired.

Instructions

- ▶ Press the locker door shut.
 - The door shackle must enter the corresponding opening in the lock centrally without touching the opening. The door must close shut without increased effort. Readjust the door (see below) if these conditions are not met.
 - The GAT Lock Bolt Set must touch the front of the door lock when the door is pressed shut. Readjust the door (see below) if it does not.
- ▶ While pressing the locker door shut, hold an authorized data carrier near the reading field on the door.
 - The locker door must lock. If it does not, check that the data carrier authorization is valid.
- ▶ While the locker door is locked, press the door in slightly with the fingers several times.
 - The door must be able to be pressed in slightly, one or two millimeters, and then return by itself. If the door gets jammed or is stiff, it must be readjusted (see below).
- ▶ While the locker door is locked, hit the door with the palm of the hand (do not damage the door).
 - The alarm must not be triggered.

- ▶ Hold an authorized data carrier a distance of approximately 1 cm in front of the locker door.
 - The locker door must unlock and spring open independently. If the door does not spring open by itself, the door must be readjusted (see below). If the data carrier is not read at this distance, the RFID reading field is possibly misaligned and require recalibration (see "4.4 Automatic Antenna Adjustment").

Adjusting the locker door and door bolt

Should a problem, as described previously in "Instructions", occurs while opening or closing the locker door during functional testing:

- ▶ Adjust the position of the GAT NET.Lock Bolt Set or the door shackle according to the measurements in chapter "3 INSTALLATION" (depending on the locker material used). If the door shackle is loose and does not remain in the adjusted position or cannot be adjusted sufficiently, the GAT NET.Lock Bolt Set must be replaced.
- ▶ Adjust the position of the locker door according to the measurements in chapter "3 INSTALLATION". If the door cannot be adjusted sufficiently, install it in a different position. If the door is damaged, replace the door with a new door.

7.3 Cleaning

Regular cleaning of the locker components ensures that the locker system remains in good condition and the correct working order is maintained.

NOTE! Do not use cleaning benzene, diluents, or other abrasive detergents. In addition, the components must not be cleaned using high-pressure or steam cleaning equipment otherwise they can become damaged!

Complete the following steps to clean the locker:

- ▶ Wipe off dirt and dust using a soft, lint-free, dry cloth.
- ▶ For extreme dirt, clean the locker components using a slightly moistened cloth. Do not allow moisture to enter the inner parts of the lock or the controller.

7.4 Maintenance

The GAT ECO.Side Lock 7000 BA system components are maintenance-free, i.e., regular maintenance of the mechanical parts is not required. Should a malfunction be detected during functional testing that cannot be remedied, the corresponding faulty part(s) must be replaced.

8 TECHNICAL DATA

8.1 Power Supply

Power supply:	1 x 3.6 V lithium battery, size AA, capacity 2.4 Ah
GANTNER approved battery:	EU: Tadiran SL-860/S US: Tadiran TL-4903/S
Battery lifetime:	Up to 10 years* at +20 °C (68 °F) *depending on usage, configuration, and environmental conditions

8.2 Reading Field

Reader type:	Multi-technology RFID reader (LEGIC advant)
Data carriers	
Segments and UID:	- LEGIC prime - LEGIC advant
UID only:	- ISO 15693 - MIFARE ISO 14443 - Classic (1k and 4k) - Ultralight® - DESFire EV1® and EV2® - HID iCLASS (13.56 MHz)
	Note: It is recommended to have customer specific data carriers approved by GANTNER before use
Reading field frequency:	13.56 MHz
Maximum sending power:	< 500 mW
Reading field range:	5 to 35 mm (0.2'' to 1.38'')* *depending on the installation and type of data carrier

8.3 Memory and Time Management

Data storage:	EEPROM with capacity for 150 bookings, data retained during battery change
Internal clock:	Quartz-controlled, real-time clock

8.4 Control and Display Elements

Control element:	Door contact in lock
Display element:	LED (red / green) to indicate the different operating states

8.5 Interfaces

Interface type:	USB 2.0
Interface connection:	USB type Micro-B

8.6 Housing

Material:	Plastic (PC), halogen-free, V0
Color:	Dark gray
Weight:	Approx. 400 g (14.1 oz.)
Dimensions:	125.2 mm x 100 mm x 25 mm (4.93" x 3.94" x 0.98")
Break-in resistance capability:	DIN 4547-2 class C

8.7 Environmental Conditions

Permitted ambient temperature:	-10 °C to +55 °C (14 °F to 131 °F)
Protection type:	IP 52
Protection class:	III
Environment class based on VdS 2110:	II (conditions in indoor areas)
Compliance:	CE, FCC, IC

NOTE:

This manual is valid from November 15th, 2018. It is subject to change.
 Amendments can be made without prior notice at any time.



GANTNER's distribution partner network actively supports customers in over 60 countries. **Please visit www.gantner.com**

Schruns, Austria
 T +43 5556 73784-0
 info@gantner.com

Houten, Netherlands
 T+31 33 43 284 16
 info@gantner.nl

Sydney, Australia
 T +61 29011 8114
 info-aus@gantner.com

London, GB
 T +44 1245 697588
 info-uk@gantner.com

Bochum, Germany
 T +49 234 58896-0
 info-de@gantner.com

Los Angeles, USA
 T +1 844 703 1139
 info-us@gantner.com

Ypern, Belgium
 T +32 57 22 44 00
 info@gantner.be

Dubai, Middle East
 T +971 4 3333 466
 info-me@gantner.com

Ahmedabad, India
 info@gantnerticketing.com