

Exhibit 8: User's Manual

The user's manual is enclosed below. The compliance statement for the EFX-905N is enclosed on page 26 of the manual.

CONTENTS

1 Introduction	5
2 Controls	5
3 Function Indicators	6
4 How To operate features.....	7
4-1. Turning Your pager off	7
4-2. Turning the Light on	7
4-3. Setting the time	8
4-4. Setting the Alarm	9
4-5. Setting the Pager auto Alert sound on/off	10
4-6. Setting Alert	11
4-7. Reminder mode	12
5 Basic features	13
5-1. Standby Mode	13
5-2. Tuning pager On	13
5-3. Receiving and reading messages	14
5-4. Setting the wake up message	18
5-5. Delete received message(s)	20
5-6. Locking and Unlocking the Message	21
6 How to change the battery	22
7 Battery Introduction	22
8 Precaution	23
9 Repair and Maintenance	23
10 Warranty	24
11 FCC Regulation	26





1. Introduction

Congratulation on your purchase of a Diva Telecom Inc. Diva Plus, the smallest pager. This pager accomplishes many up-to-date microminiaturization of electronic and wireless technology which provide maximum assurance in receiving numeric messages easily and conveniently.

2. Controls









Buttons

 → "Left button" Turn the display light on, scroll through the features and set the function.

 → "Right button" Read incoming messages, select the function displayed. Escape, power off, time, alarm, Auto pager power On/Off, alerts, reminder chirp.



After executing any pager function described in this user's manual, your Diva Plus pager automatically returns to the standby screen with a sound of chirp.

3. Function Indicators

-  Silent Alert - No alerts for incoming message.
-  Tone Alert - One of 6 selected melody alerts sound for an incoming message.
-  Melody Alert - One of 10 selected melody alerts sound for an incoming message.
-  Continuous Message-More incoming message is on the next screen
-  Off mode
-  Low battery
-  Duplicate Message Indicator
-  Protected Message Indicator



4. How to set up features

4-1. Turning Your pager off

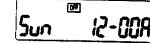









- ① Press  until the "Pwr off?" displays.
- ② Press  for 2 seconds to turn your pager off.
- ③ The pager displays the day and time and "OFF" symbol flashes continuously.













4-2. Turning the Light on

- ① Press  to turn the light on to read the day and time of the day.
- ② Light turns on automatically when press  to read the messages between 6 P.M through 6 A.M, otherwise press  to turn the light on manually.
- ③ Light turns off automatically when pager returns to the standby screen.

4-3. Setting the time





- ① Press  button until "Time?" displays.
- ② Press  button to set time.
- ③ Press  to change the day flashes.
- ④ Press  to switch to the hour.
- ⑤ Press  to change the hour flashes.
- ⑥ Press  to switch to the first digit of the minute.
- ⑦ Press  to change the first digit of the minute flashes.
- ⑧ Press  to switch to the second digit of the minute.
- ⑨ Press  to change the second digit of the minute flashes.
- ⑩ Press  to return to the standby mode with a sound of chirp.



4-4. Setting the Alarm

- ① Press  button until "Alarm?" displays.
- ② Press  button to set alarm.
- ③ Press  to change the hour flashes.
- ④ Press  to switch to the first digit of the minute.
- ⑤ Press  to change the first digit of the minute flashes.
- ⑥ Press  to switch to the second digit of the minute.
- ⑦ Press  to change the second digit of the minute flashes.
- ⑧ Press  turn alarm disable/Enable Mode.
- ⑨ Press  to select to turn alarm Disable/Enable.
- ⑩ Press  to return to the standby mode with a sound of chirp.



4-5. Setting the Pager auto Alert sound on/off

This feature is designed for user to receive the message silently without any alert sound or vibration for incoming message during the certain hours of the day to ensure the best rest without missing important messages.



- ① Press  button until "PGr AUto?" displays
- ② Press  button to set Pager auto alert sound On/Off
- ③ Press  to change the first pair of the hour flashes which indicates the hour that starts to receive the message with selected alert sound.
- ④ Press  to switch to the second pair of the hour
- ⑤ Press  to change the second pair of the hour flashes which starts to receive the message silently without chirp or vibration.

- ④ Press  to turn the pager auto alert sound feature disable/Enable Mode
- ⑦ Press  to select to turn the pager auto alert sound feature disable/Enable
- ⑧ Press  to return to the standby mode with a sound of chirp.
- ⑨ SL means sleep mode which enables the feature
- ⑩ dl mean disable mode which disables the feature

4-6. Setting Alert

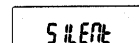

- ① Press  button until "Alert?" displays
- ② Press  button to set alert



- ③ Press  to scroll the choice of alerts
 - ④ Press  to choose the desired alert and returns to the standby mode with a sound of chirp.
- Pager returns to the standby mode without a sound of chirp when either silent or a vibration mode is selected.

4-7. Reminder mode

This feature is designed for the certain users who prefer to have reminder alert for unread messages.

- ① Press  button until "Reminder?" displays
- ② Press  button to select reminder mode enable or disable
- ③ Press  to choose the desired mode and returns to the standby mode.

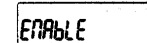

5 Basic features

5-1. Standby Mode

When power up pager, pager displays the day of the week, the time of the day, a symbol for selected alert of your choice, and a symbol of service area indicator.

Note: While you are reading the message, you can return to the standby mode any time by pressing the button and button simultaneously.

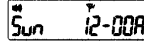

5-2. Turning pager On

Press button for two seconds to turn the pager to the standby mode from Off mode. Pager displays wake up message, if you're programmed, while sound two different tone alerts. After displaying the power screen, the time of the day, the day of the week, an alert indicator and service area indicator are shown.

* Press any button to stop the alert to return to the standby screen instantly.

5-3. Receiving and reading messages

Diva Plus pager can receive up to 20 sixteen character message. When a message is received, the pager alerts for 8 seconds.

- ① Press any button to stop the alert.
- ② Press button to display the day and time of the day that message is received and the message slot number.
- ③ Press button to display the received message.
- ④ Press and button simultaneously to return to the standby screen.

14
22

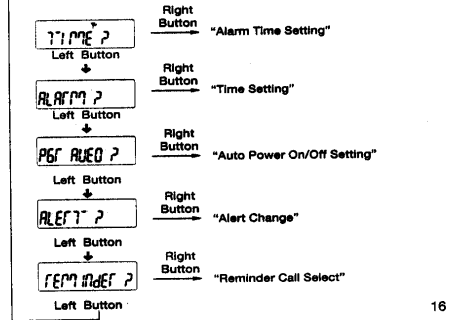
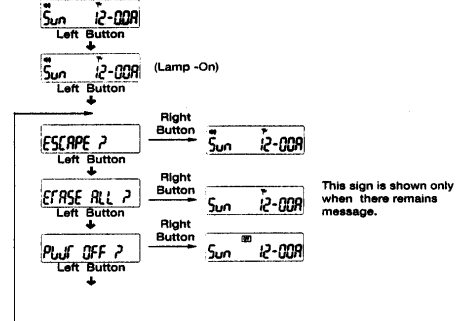

16

17

Messages longer than 12 characters display on a second screen, indicated by symbol . Press button to display the second screen. The message displays automatically returns to the standby mode after 14 seconds, if button is not pressed.

If a message is not read, the pager shows "Page" and number of unread messages on the screen until button is pressed and all message are read.

If you enabled the reminder feature, pager chirps in every 4 minutes to alert you for unread message(s) until button is pressed and all message are read.

If pager receives more messages than its available memory can hold, the new message replaces the oldest read and unprotected message and "INFO FULL" displays on the screen. Replaced messages are lost and not recoverable.

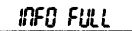

"Diva Plus pager stores up to 20 personal messages in the memory. Reading time for each message is 14 seconds unless button is pressed to advance to next received message, otherwise pager automatically returns to the stand-by mode in 14 seconds.

5-4. Setting the wake up message

This feature is for the user to program his own pager number so that user doesn't need to label the pager number on the pager. Wake up message displays every time pager powers up.

- ① Take the battery out from the battery compartment
- ② Press button while reinserting the battery in to the compartment



- ③ Press button to scroll the number from the first digit of the left side. Each segment consists of 1-9, hyphen and space

18

19

- ④ Press button to change to the second digit flashes
 - ⑤ Repeat the same to set all the digit
 - ⑥ Press to finish and returns to the standby mode.
 - ⑦ Pager vibrates and alerts for 6 seconds while displaying wake up message on the LCD.
- Tip:** Customer who uses voice mail service from the paging service carriers is recommended to set the wake up message as same format as their voice mail message number transmitted from the carrier.

Typical format of voice mail message sent out by the most of the carriers in USA is 123-1234 so this case set the wake up message as 123-1234 and set the rest of the digits in blank. Pager displays "Mail Voice" for voice mail message.

5-5. Delete received message(s)

Received message can be deleted singly or all the unlocked messages at once.

Delete all messages



- ① Press until "ERASE ALL?" displays.
 - ② Press to delete all read and unlocked messages. Pager returns to the standby mode with a long sound of chirp.
- Note:** Deleted messages are lost and not recoverable.

Delete single message

- ① Press button until a message that you want to delete displays.
- ② Press button to protect the message.
- ③ Press button to unlock message.
- ④ Press button again displays "ERASE?"

20

21

5 Press  button to delete, or else press  button to cancel deletes.



Pager returns to the standby mode with a long sound of chirp.

Note: Deleted messages are lost and not recoverable.

5-6. Locking and Unlocking the Message

Up to 10 messages can be locked in the memory, preventing them from being replaced when memory is full (indicated by the "INFO" message)

Press  button until the message you want to lock displays

Press  button to protect the message and symbol  displays at the top of the message

23

7 Battery Information

Diva plus pager is designed to operate with an AAA-size battery.

8 Precaution

Keep your pager from any kinds of liquids.
Do not throw or drop the pager.
Do not attempt to open the pager and modify the pager.

9 Repair and Maintenance

Diva Plus Pager provides trouble-free quality for many years however, if service is ever needed, Diva Telecom service center staffs with specially trained engineers are available to provide warranty repair services.

10 How to change the battery

Unlock the door by sliding the locking tab to unlock the door.



Open the battery door.



Remove old battery.

Install the battery by aligning to the positive and negative. Negative side goes into the inside compartment towards the spring.



Close the battery door.

Lock the door by sliding the locking tab.

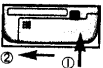

22

10 Warranty

Diva Plus ensures the best quality in wireless industry. However Diva plus is ever required for service, return the Diva Plus with description of malfunctioning or difficulties along with the proof of purchase. (cash register receipt with purchase date required)
Warranty is 1 year from the date of purchase.

What's not covered by warranty:

Accident, physical damage, improper installation, misuse, fire, water and liquid intrusion, unauthorized modification, alteration are not covered by warranty.

24

25

To claim the warranty service:

Package the Diva Plus and send to following address with a brief description of problem, serial number, your name, address and telephone number. In all subsequent communication, please have the serial number information available: Diva Telecom Inc.

Diva plus/Repair Dept.
8 West 33rd Street, New York, NY 10001
Tel: 212-897-0000/Fax: 212-897-1111

Warning: We assume no risk for damage or loss in transit.

If you need more information or any question, please feel free to contact the above telephone number.

11 FCC Regulation

This device complies with part 15 of the FCC rules and regulations. Operation is subject to the condition that this device does not cause harmful interference.

26