

FCC Measurement/Technical Report on

Radio Identification Device

FS19

Part of system "37W"

FCC ID: NBGFS19
IC: 2694A-FS19

Test Report Reference: MDE_HELLA_1806_FCCd_REV3

Test Laboratory:

7layers GmbH
Borsigstrasse 11
40880 Ratingen
Germany



Note:

The following test results relate only to the devices specified in this document. This report shall not be reproduced in parts without the written approval of the test laboratory.

7layers GmbH
Borsigstraße 11
40880 Ratingen, Germany
T +49 (0) 2102 749 0
F +49 (0) 2102 749 350

Geschäftsführer/
Managing Directors:
Frank Spiller
Bernhard Retka
Alexandre Norré-Oudard

Registergericht/registered:
Düsseldorf HRB 75554
USt-Id.-Nr./VAT-No. DE203159652
Steuer-Nr./TAX-No. 147/5869/0385

*a Bureau Veritas
Group Company*

www.7layers.com

Table of Contents

1	Applied Standards and Test Summary	3
1.1	Applied Standards	3
1.2	FCC-IC Correlation Table	4
1.3	Measurement Summary / Signatures	5
2	Administrative Data	8
2.1	Testing Laboratory	8
2.2	Project Data	8
2.3	Applicant Data	8
2.4	Manufacturer Data	8
3	Test object Data	9
3.1	General EUT Description	9
3.2	EUT Main components	10
3.3	Ancillary Equipment	11
3.4	Auxiliary Equipment	11
3.5	EUT Setups	11
3.6	Operating Modes	12
3.7	Product labelling	12
4	Test Results	13
4.1	-10 dB BANDWIDTH – 15.503(d)	13
4.2	-10 dB BANDWIDTH -15.519 (b)	17
4.3	PEAK EMISSION – 15.519(e)	20
4.4	PEAK EMISSION – 15.521(e)	25
4.5	Radiated Emissions	29
4.6	Radiated Emissions in GNSS bands	45
4.7	Transmission times	49
5	Test Equipment	55
6	Antenna Factors, Cable Loss and Sample Calculations	58
6.1	LISN R&S ESH3-Z5 (150 kHz – 30 MHz)	58
6.2	Antenna R&S HFH2-Z2 (9 kHz – 30 MHz)	59
6.3	Antenna R&S HL562 (30 MHz – 1 GHz)	60
6.4	Antenna R&S HF907 (1 GHz – 18 GHz)	61
6.5	Antenna EMCO 3160-09 (18 GHz – 26.5 GHz)	62
6.6	Antenna EMCO 3160-10 (26.5 GHz – 40 GHz)	63
7	Setup Drawings	64
8	Measurement Uncertainties	65
9	Photo Report	65

Applied Standards and Test Summary

1.1 APPLIED STANDARDS

Applicable FCC Rules

Prepared in accordance with the requirements of FCC Rules and Regulations as listed in 47 CFR Ch.1 Parts 2 and 15 (10-1-18 Edition). The following subparts are applicable to the results in this test report.

Part 2, Subpart J - Equipment Authorization Procedures, Certification

Part 15, Subpart F – Ultra Wideband Operation

- § 15.201 Equipment authorization requirement
- § 15.207 Conducted limits
- § 15.209 Radiated emission limits; general requirements
- § 15.503 Definitions
- § 15.519 Technical Requirements for hand held UWB devices
- § 15.521 Technical requirements applicable for all UWB devices

Note:
ANSI C63.10–2013 is applied.

Summary Test Results:

The EUT complied with all performed tests as listed in chapter 1.3 Measurement Summary / Signatures.

1.2 FCC-IC CORRELATION TABLE

**Correlation of measurement requirements for
handheld UWB equipment
from
FCC and IC**

Measurement	FCC reference	IC reference
Conducted emissions on AC Mains	§ 15.207	RSS-Gen Issue 5: 8.8
-10 dB Occupied bandwidth	§ 15.503 (d); § 15.519 (b)	RSS-220 Issue 1: 2; RSS-220 Issue 1: 5.1 (a); RSS-220 Issue 1: Annex 2
Peak Emission	§ 15.519 (e); § 15.521 (e)	RSS-220 Issue 1: 5.3.1 (g) RSS-220 Issue 1: Annex 4
Transmitter spurious radiated emissions	§ 15.209 (a); § 15.519 (c);	RSS-220 Issue 1: 3.4; RSS-220 Issue 1: 5.3.1 (c), (d)
Transmitter spurious radiated emissions GNSS bands	§ 15.519 (d)	RSS-220 Issue 1: 5.3.1 (e)
Transmission time	§ 15.519 (a) (1)	RSS-220 Issue 1: 5.3.1 (b)

1.3 MEASUREMENT SUMMARY / SIGNATURES

47 CFR CHAPTER I FCC PART 15 Subpart F § 15.207

Conducted Emissions at AC mains

The measurement was performed according to ANSI C63.10

Final Result

OP-Mode	Setup	FCC	IC
AC mains connection, Test setup			
- , -	-	N/A	N/A

47 CFR CHAPTER I FCC PART 15 Subpart F § 15.503 (d)

-10 dB Occupied Bandwidth

The measurement was performed according to ANSI C63.10

Final Result

OP-Mode	Setup	FCC	IC
Measurement method, Operating band, Channel			
radiated, 3100-10600 MHz, Low	S01_AA10	Passed	Passed
radiated, 3100-10600 MHz, Mid	S01_AA10	Passed	Passed
radiated, 3100-10600 MHz, High	S01_AA10	Passed	Passed

47 CFR CHAPTER I FCC PART 15 Subpart F § 15.519 (b)

-10 dB Occupied Bandwidth

The measurement was performed according to ANSI C63.10

Final Result

OP-Mode	Setup	FCC	IC
Measurement method, Operating band, Channel			
radiated, 3100-10600 MHz, Low	S01_AA10	Passed	Passed
radiated, 3100-10600 MHz, Mid	S01_AA10	Passed	Passed
radiated, 3100-10600 MHz, High	S01_AA10	Passed	Passed

47 CFR CHAPTER I FCC PART 15 Subpart F § 15.519 (e)

Peak Emission

The measurement was performed according to ANSI C63.10

Final Result

OP-Mode	Setup	FCC	IC
Measurement method, Operating band, Channel			
radiated, 3100-10600 MHz, Low	S01_AA10	Passed	Passed
radiated, 3100-10600 MHz, Mid	S01_AA10	Passed	Passed
radiated, 3100-10600 MHz, High	S01_AA10	Passed	Passed

47 CFR CHAPTER I FCC PART 15 Subpart F § 15.521 (e)

Peak Emission

The measurement was performed according to ANSI C63.10

Final Result

OP-Mode	Setup	FCC	IC
Measurement method, Operating band, Channel			
radiated, 3100-10600 MHz, Low	S01_AA10	Passed	Passed
radiated, 3100-10600 MHz, Mid	S01_AA10	Passed	Passed
radiated, 3100-10600 MHz, High	S01_AA10	Passed	Passed

47 CFR CHAPTER I FCC PART 15 Subpart F

§ 15.209 (a) / § 15.519 (c)

Radiated Emissions

The measurement was performed according to ANSI C63.10

OP-Mode Measurement method, Operating band, Measurement range, Channel	Setup	Final Result	
		FCC	IC
radiated, 3100-10600 MHz, 9 kHz – 30 MHz, Low	S01_AA10	Passed	Passed
radiated, 3100-10600 MHz, 30 MHz – 960 MHz, Low	S01_AA10	Passed	Passed
radiated, 3100-10600 MHz, 960 MHz – 18 GHz, Low	S01_AA10	Passed	Passed
radiated, 3100-10600 MHz, 18 GHz – 26 GHz, Low	S01_AA10	Passed	Passed
radiated, 3100-10600 MHz, 26 GHz – 40 GHz, Low	S01_AA10	Passed	Passed
radiated, 3100-10600 MHz, 9 kHz – 30 MHz, Mid	S01_AA10	Passed	Passed
radiated, 3100-10600 MHz, 30 MHz – 960 MHz, Mid	S01_AA10	Passed	Passed
radiated, 3100-10600 MHz, 960 MHz – 18 GHz, Mid	S01_AA10	Passed	Passed
radiated, 3100-10600 MHz, 18 GHz – 26 GHz, Mid	S01_AA10	Passed	Passed
radiated, 3100-10600 MHz, 26 GHz – 40 GHz, Mid	S01_AA10	Passed	Passed
radiated, 3100-10600 MHz, 9 kHz – 30 MHz, High	S01_AA10	Passed	Passed
radiated, 3100-10600 MHz, 30 MHz – 960 MHz, High	S01_AA10	Passed	Passed
radiated, 3100-10600 MHz, 960 MHz – 18 GHz, High	S01_AA10	Passed	Passed
radiated, 3100-10600 MHz, 18 GHz – 26 GHz, High	S01_AA10	Passed	Passed
radiated, 3100-10600 MHz, 26 GHz – 40 GHz, High	S01_AA10	Passed	Passed

47 CFR CHAPTER I FCC PART 15 Subpart F

§ 15.519 (d)

Radiated Emissions in GNSS bands

The measurement was performed according to ANSI C63.10

OP-Mode Measurement method, Operating band, Measurement range, Channel	Setup	Final Result	
		FCC	IC
radiated, 3100-10600 MHz, 1164 MHz – 1240 MHz, Low	S01_AA10	Passed	Passed
radiated, 3100-10600 MHz, 1164 MHz – 1240 MHz, Mid	S01_AA10	Passed	Passed
radiated, 3100-10600 MHz, 1164 MHz – 1240 MHz, High	S01_AA10	Passed	Passed
radiated, 3100-10600 MHz, 1559 MHz – 1610 MHz, Low	S01_AA10	Passed	Passed
radiated, 3100-10600 MHz, 1559 MHz – 1610 MHz, Mid	S01_AA10	Passed	Passed
radiated, 3100-10600 MHz, 1559 MHz – 1610 MHz, High	S01_AA10	Passed	Passed

47 CFR CHAPTER I FCC PART 15 Subpart F

§ 15.519 (a) (1)

Associated Receiver / Transmissions times

The measurement was performed according to ANSI C63.10

OP-Mode Measurement method, Operating band, Channel, Test Setup	Setup	Final Result	
		FCC	IC
radiated, 3100-10600 MHz, Mid, Transmission time	S01_AA14	Passed	Passed
radiated, 3100-10600 MHz, Mid, Associated Receiver	S01_SYS1	Passed	Passed
radiated, 3100-10600 MHz, Mid, No Associated Receiver	S01_SYS2	Passed	Passed

N/A: Not applicable

N/P: Not performed

Revision History

Report version control			
Version	Release date	Change Description	Version validity
initial	2019-02-13	--	invalid
REV1	2019-03-11	<ul style="list-style-type: none"> Page 5f: Used setup added for all test. Page 6: Associated receiver tests added to measurement summary. Page 9: Sample aa14 and setup S01_AA14 added. Page 9: Sample aa15 and setup S01_SYS1 added. Page 9: Sample aa07 and setup S01_SYS2 added. Auxiliary Equipment AUX1 added. Page 50: Test Results for "Associated Receiver" test added. Page 51: "Signaling sequences for "Associated Receiver" test added. Page 54: Spectrum Analyzer plots for "Associated Receiver" test added. 	invalid
REV2	2019-04-08	<ul style="list-style-type: none"> Page 9: Note added that a fresh battery was used at the start of every test Page 51: Clarification of the scenario for the transmission time setup 	invalid
REV3	2019-05-28	<ul style="list-style-type: none"> Page 10: EUT E, conducted sample added Page 11: Setup S01_AA13 added Page 44: Plots exchanged, to show that emissions at 3024 MHz are not emitted by the antenna Page 51: Adding references in the signaling sequences to the corresponding plots 	valid



 7 layers GmbH, Borsigstr. 11

 40880 Ratingen, Germany

 Phone +49 (0)2102 749 9

M. Kullik (responsible for accreditation scope)

 Dipl.-Ing. Marco Kullik

J. Dörwald (responsible for testing and report)

 B.Sc. Jens Dörwald

2 ADMINISTRATIVE DATA

2.1 TESTING LABORATORY

Company Name: 7layers GmbH
Address: Borsigstr. 11
40880 Ratingen
Germany

The test facility is accredited by the following accreditation organisation:

Laboratory accreditation no: DAKKS D-PL-12140-01-00
FCC Designation Number: DE0015
FCC Test Firm Registration: 929146
ISED CAB Identifier: DE0007; ISED#: 3699A
Responsible for accreditation scope: Dipl.-Ing. Marco Kullik
Report Template Version: 2019-03-11

2.2 PROJECT DATA

Responsible for testing and report: B.Sc. Jens Dörwald
Employees who performed the tests: documented internally at 7Layers
Date of Report: 2019-05-29
Testing Period: 2018-12-10 to 2019-03-05

2.3 APPLICANT DATA

Company Name: HELLA GmbH & Co. KGaA
Address: Rixbecker Str. 75
59557 Lippstadt
Germany
Contact Person: Mr. Christian Elbers

2.4 MANUFACTURER DATA

Company Name: please see Applicant Data
Address:
Contact Person:

3 TEST OBJECT DATA

3.1 GENERAL EUT DESCRIPTION

Kind of Device product description	The EUT is a handheld remote keyless transceiver with 125 kHz, 433 MHz and UWB technology.
Product name	Radio Identification Device, part of system "37W"
Type	FS19
Declared EUT data by the supplier	
Power Supply Type	DC, Li coin cell Note: Before start of each tests a fresh battery was installed in the EUT.
Normal Voltage	3.0 V
Low Voltage	2.25 V
High Voltage	3.2 V
Normal Temperature	20.0 °C
Low Temperature	-20.0 °C
High Temperature	+60.0 °C
Antenna type	Integrated monopole antenna
UWB technology	Impulse radio
Modulation	Frequency Shift Keying (FSK) +/- 125 MHz
Modulation Parameters	UWB pulse length: appr. 4.5 ns UWB pulse repetition: appr. 250 ns Symbol 1: FSK-Low (fc - 125 MHz) Symbol 0: FSK-High (fc + 125 MHz) 16 pulses form a data bit Bit "0": 1 1 0 1 0 0 1 1 0 0 1 0 1 1 0 0 Bit "1": 0 0 1 0 1 1 0 0 1 1 0 1 0 0 1 1
Occupied bandwidth	500 MHz
Highest internal frequency	7560 MHz
Ports	Enclosure
Special software used for testing	Special test software based on series SW version 5

The main components of the EUT are listed and described in chapter 3.2 EUT Main components.

3.2 EUT MAIN COMPONENTS

Sample Name	Sample Code	Description
EUT A	DE1232004aa10	Radiated UWB TX sample
Sample Parameter	Value	
HW Version	16	
SW Version	Special test software based on series SW version 5	
Serial No.	-	
Comment		

Sample Name	Sample Code	Description
EUT B	DE1232004aa14	Radiated UWB TX sample
Sample Parameter	Value	
HW Version	16	
SW Version	Special test software based on series SW version 5	
Serial No.	-	
Comment	For TX-timing test	

Sample Name	Sample Code	Description
EUT C	DE1232004aa15	Radiated TX sample
Sample Parameter	Value	
HW Version	16	
SW Version	SW version 5	
Serial No.	-	
Comment	For associated receiver tests WOB [Wake Up Pattern] known to the car	

Sample Name	Sample Code	Description
EUT D	DE1232004aa07	Radiated TX sample
Sample Parameter	Value	
HW Version	16	
SW Version	SW version 5	
Serial No.	-	
Comment	For not associated receiver tests WOB [Wake Up Pattern] not known to the car	

Sample Name	Sample Code	Description
EUT E	DE1232004aa13	Conducted UWB TX sample
Sample Parameter	Value	
HW Version	16	
SW Version	Special test software based on series SW version 5	
Serial No.	-	
Comment	UWB antenna replaced by a short cable with SMA connector	

NOTE: The short description is used to simplify the identification of the EUT in this test report.

3.3 ANCILLARY EQUIPMENT

For the purposes of this test report, ancillary equipment is defined as equipment which is used in conjunction with the EUT to provide operational and control features to the EUT. It is necessary to configure the system in a typical fashion, as a customer would normally use it. But nevertheless Ancillary Equipment can influence the test results.

Device	Details (Manufacturer, Type Model, OUT Code)	Description
-	-	-

3.4 AUXILIARY EQUIPMENT

For the purposes of this test report, auxiliary equipment is defined as equipment which is used temporarily to enable operational and control features especially used for the tests of the EUT which is not used during normal operation or equipment that is used during the tests in combination with the EUT but is not subject of this test report. It is necessary to configure the system in a typical fashion, as a customer would normally use it. But nevertheless Auxiliary Equipment can influence the test results.

Device	Details (Manufacturer, HW, SW, S/N)	Description
AUX1	<ul style="list-style-type: none"> • Door proximity sensor • 013854 - LF KESSY IO box (incl. LF antennas) • RSB19 -UWB ranging device • BCM - Body Controller Module (contains a 434 UHF transceiver), connected via CAN-bus • The CAR network is simulated by a VECTOR CAN simulation 	System test check setup

3.5 EUT SETUPS

This chapter describes the combination of EUTs and equipment used for testing. The rationale for selecting the EUTs, ancillary and auxiliary equipment and interconnecting cables, is to test a representative configuration meeting the requirements of the referenced standards.

Setup	Combination of EUTs	Description and Rationale
S01_AA10	EUT A	radiated setup
S01_AA14	EUT B	radiated setup, TX-timing
S01_SYS1	EUT C, AUX1	radiated setup, associated receiver
S01_SYS2	EUT D, AUX1	radiated setup, associated receiver
S01_AA13	EUT E	conducted setup

3.6 OPERATING MODES

This chapter describes the operating modes of the EUTs used for testing.

Series like UWB telegrams with dummy data (e.g. 0xCAFECAFECAFECAFE & postamble) with appr. 1.52 ms repetition rate

3.6.1 TEST CHANNELS

	low	mid	high
Declared Single Operating Frequencies for testing [MHz]	6520	7040	7560

3.7 PRODUCT LABELLING

3.7.1 FCC ID LABEL

Please refer to the documentation of the applicant.

3.7.2 LOCATION OF THE LABEL ON THE EUT

Please refer to the documentation of the applicant.

4 TEST RESULTS

4.1 -10 dB BANDWIDTH – 15.503(d)

Standard **FCC Part 15 Subpart F**

The test was performed according to:
ANSI C63.10

Definition:

The Equipment Under Test (EUT) was set up to perform the occupied bandwidth measurements.

The reference level is the level of the highest amplitude signal observed from the transmitter at either the fundamental frequency or first-order modulation products in all typical modes of operation, including the unmodulated carrier, even if atypical.

The results recorded were measured with the modulation which produce the worst-case (biggest) emission bandwidth.

Test Procedure:

The Equipment Under Test (EUT) was set up on a non-conductive support (tilt device) at 1.5 m height in the fully-anechoic chamber.

The measurement was performed with one height (1.5 m) of the receiving antenna.

The measurement distance was 3m.

A search for the direction of maximum output power level is not performed because this is a relative measurement.

The test procedure for "Evaluation of -10 dB bandwidth" of the ANSI C63.10, Chapter 10.1 was used with the following Spectrum Analyzer settings:

- Resolution Bandwidth (RBW): 1 MHz
- Video Bandwidth (VBW): 3 MHz
- Center Frequency: Nominal channel center frequency
- Span: 1 GHz
- Sweptime: 1s
- Sweep points: 1001
- Sweeps: until trace stabilizes
- Trace: Maxhold
- Detector: Peak

The Test was performed radiated in a Fully Anechoic Chamber in the following setup:

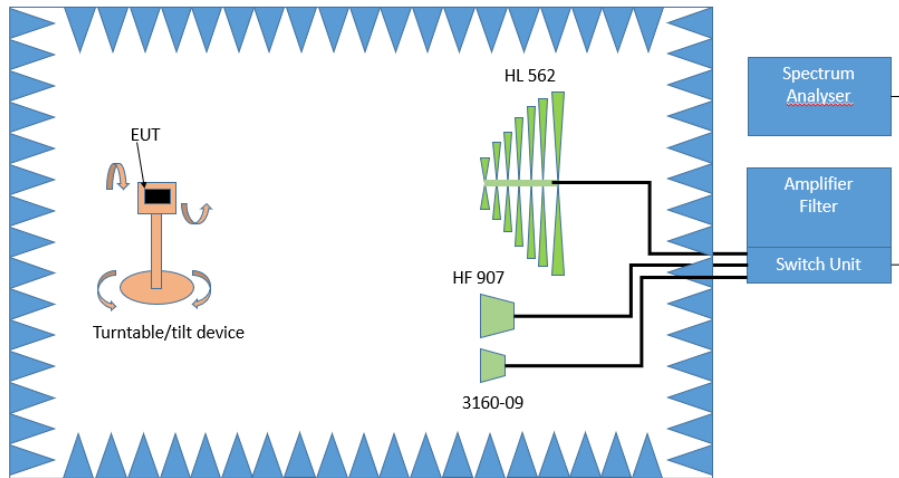

Test Setup; Spurious Emission Radiated (FAC), 30 MHz -26.5 GHz

4.1.1 TEST REQUIREMENTS / LIMITS

FCC Part 15, Subpart F, §15.503 (d)

Ultra-wideband (UWB) transmitter. An intentional radiator that, at any point in time, has a fractional bandwidth equal to or greater than 0.20 or has a UWB bandwidth equal to or greater than 500 MHz, regardless of the fractional bandwidth.

RSS-220, 2.

A UWB device is an intentional radiator that has either a -10 dB bandwidth of at least 500 MHz or a -10 dB fractional bandwidth greater than 0.2.

4.1.2 TEST PROTOCOL

Ambient

temperature: 24 °C

Air Pressure: 1019 hPa

Humidity: 31 %

Operating Band: 3100 - 10600 MHz

Channel	Lower -10 dB Frequency fL [MHz]	Upper -10 dB Frequency fH [MHz]	Max Frequency fM [MHz]	Center Frequency fC [MHz]	Occupied Bandwidth [MHz]	Minimum Occupied Bandwidth h [MHz]	Occupied Bandwidth Margin to Limit [MHz]
Low	6236.00	6914.00	6396.00	6575.0	678.0	500.0	178.0
Mid	6759.00	7434.00	6923.00	7096.5	675.0	500.0	175.0
High	7274.00	7954.00	7444.00	7614.0	680.0	500.0	180.0

4.1.3 MEASUREMENT PLOT (SHOWING THE HIGHEST VALUE, "WORST CASE")

Measurement method = radiated, Operating band = 3100 – 10600 MHz, Channel = low (S01_AA10)

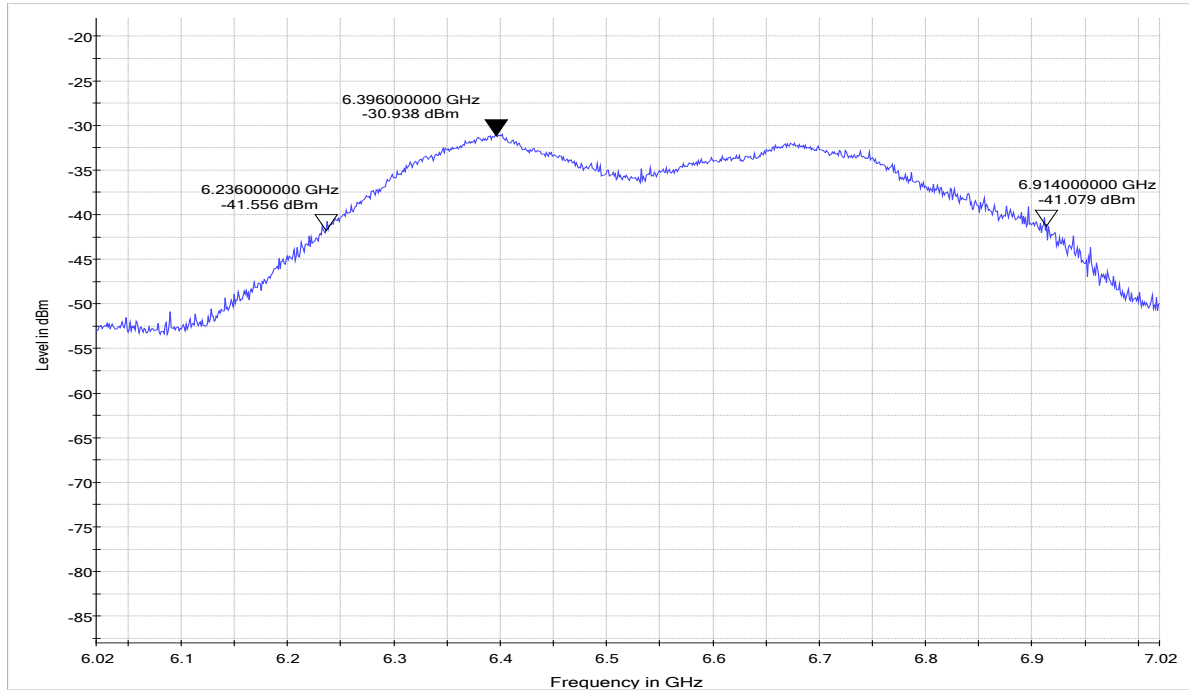

Measurement method = radiated, Operating band = 3100 – 10600 MHz, Channel = mid (S01_AA10)

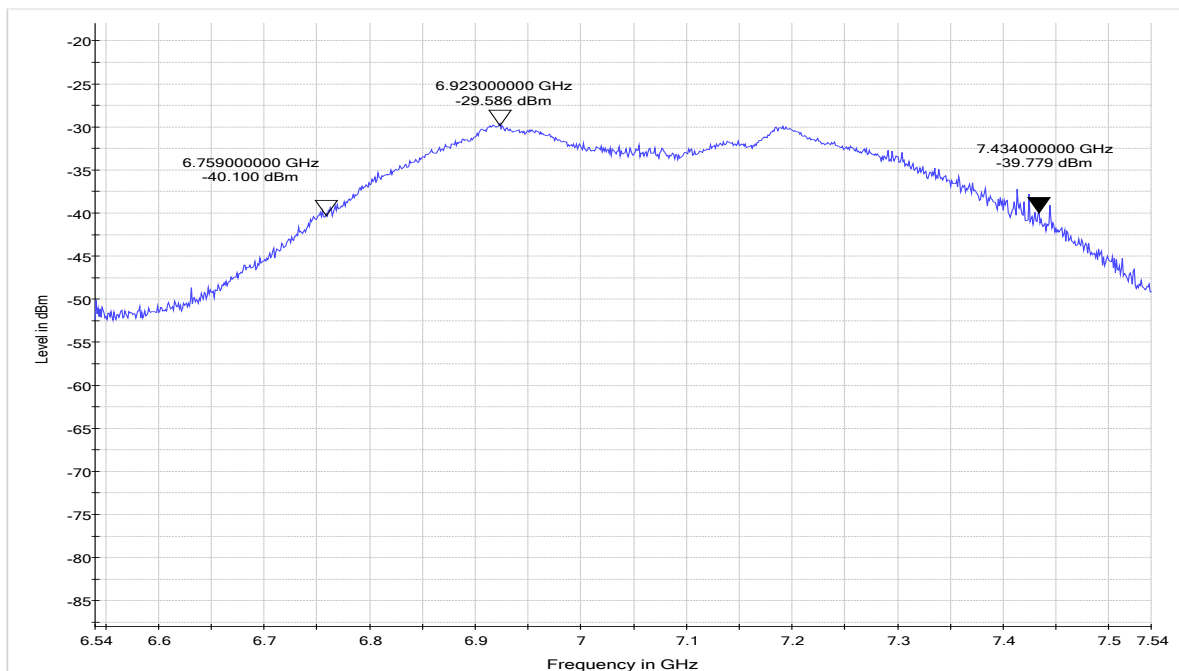

Measurement method = radiated, Operating band = 3100 – 10600 MHz, Channel = high (S01_AA10)

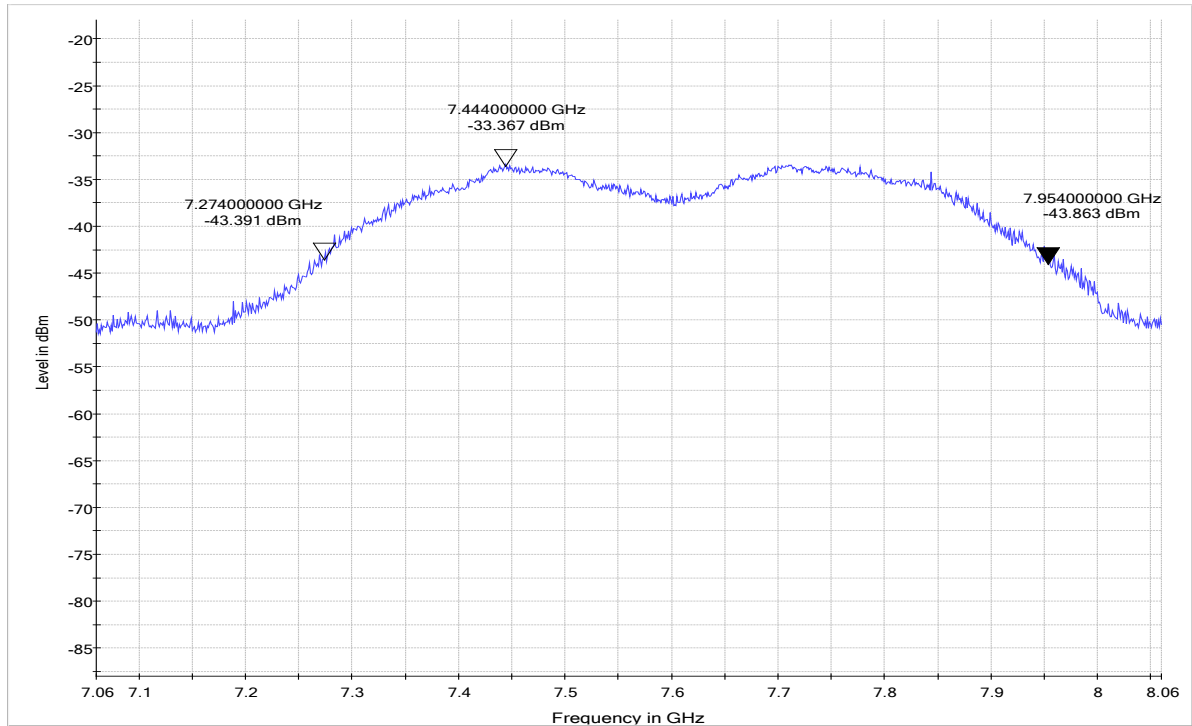

TEST EQUIPMENT USED:
- Radiated Emissions

4.2 -10 dB BANDWIDTH -15.519 (b)

Standard **FCC Part 15 Subpart F**

The test was performed according to:
ANSI C63.10

Definition:

The Equipment Under Test (EUT) was set up to perform the occupied bandwidth measurements.

The reference level is the level of the highest amplitude signal observed from the transmitter at either the fundamental frequency or first-order modulation products in all typical modes of operation, including the unmodulated carrier, even if atypical.

The results recorded were measured with the modulation which produce the worst-case (biggest) emission bandwidth.

Test Procedure:

The Equipment Under Test (EUT) was set up on a non-conductive support (tilt device) at 1.5 m height in the fully-anechoic chamber.

The measurement was performed with one height (1.5 m) of the receiving antenna.

The measurement distance was 3m.

A search for the direction of maximum output power level is not performed because this is a relative measurement.

The test procedure for "Evaluation of -10 dB bandwidth" of the ANSI C63.10, Chapter 10.1 was used with the following Spectrum Analyzer settings:

- Resolution Bandwidth (RBW): 1 MHz
- Video Bandwidth (VBW): 3 MHz
- Center Frequency: Nominal channel center frequency
- Span: 1 GHz
- Sweptime: 1s
- Sweep points: 1001
- Sweeps: until trace stabilizes
- Trace: Maxhold
- Detector: Peak

The Test was performed radiated in a Fully Anechoic Chamber in the following setup:

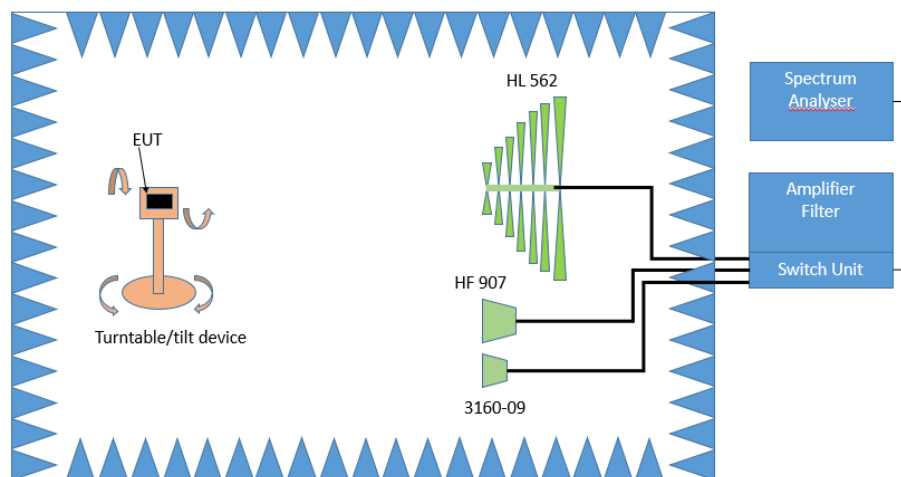

Test Setup; Spurious Emission Radiated (FAC), 30 MHz -26.5 GHz

4.2.1 TEST REQUIREMENTS / LIMITS

FCC Part 15, Subpart F, §15.519 (b)

The UWB bandwidth of a device operating under the provisions of this section must be contained between 3100 MHz and 10600 MHz.

RSS-220, 5.1 (a)

The -10 dB bandwidth of the device shall be totally contained in the band 3.1-10.6 GHz.

4.2.2 TEST PROTOCOL

Ambient

temperature: 24 °C

Air Pressure: 1019 hPa

Humidity: 31 %

Operating Band: 3100 - 10600 MHz						
Channel	Lower -10 dB Frequency [MHz]	Upper -10 dB Frequency [MHz]	Lower Band Edge [MHz]	Upper Band Edge [MHz]	Margin to Lower Limit [MHz]	Margin to Upper Limit [MHz]
Low	6236.00	6914.00	3100.00	10600.00	3136.00	3686.00
Mid	6759.00	7434.00	3100.00	10600.00	3659.00	3166.00
High	7274.00	7954.00	3100.00	10600.00	4174.00	2646.00

4.2.3 MEASUREMENT PLOT (SHOWING THE HIGHEST VALUE, "WORST CASE") (S01_AA10)

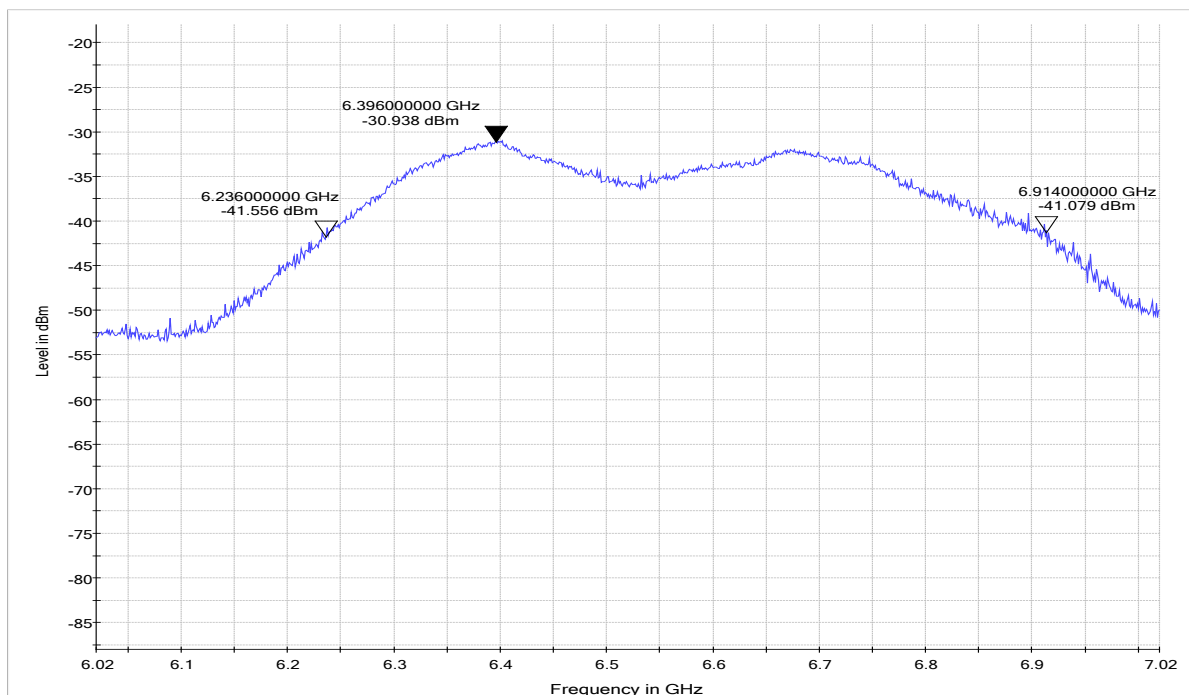

Measurement method = radiated, Operating band = 3100 – 10600 MHz, Channel = mid (S01_AA10)

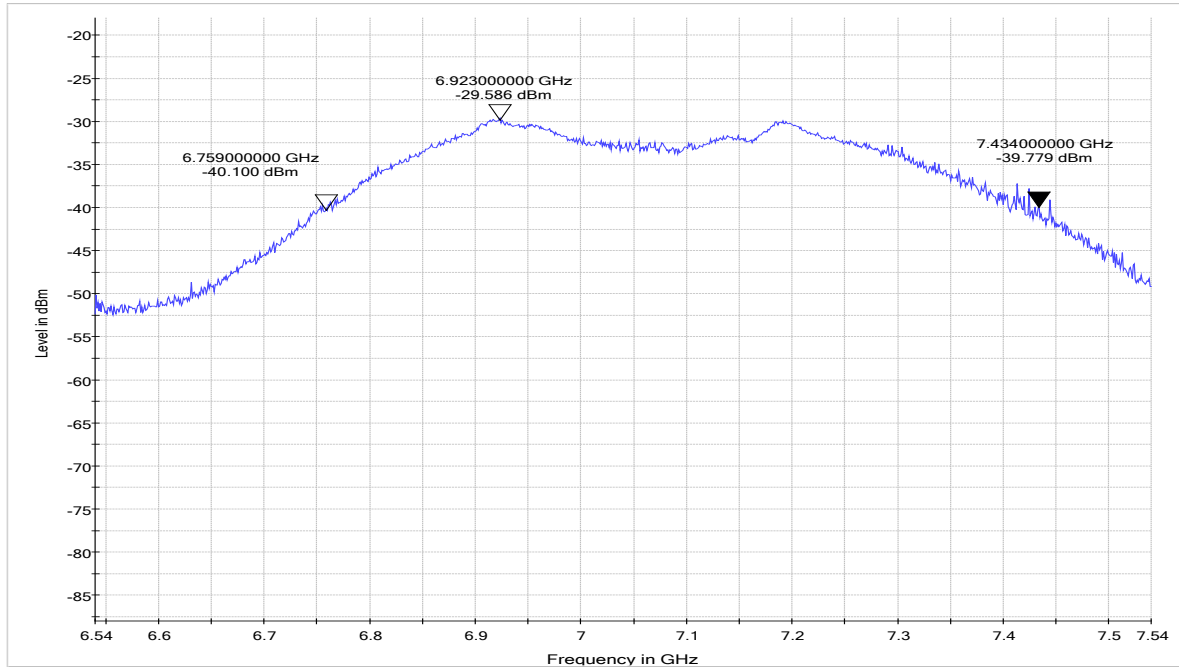

Measurement method = radiated, Operating band = 3100 – 10600 MHz, Channel = high (S01_AA10)

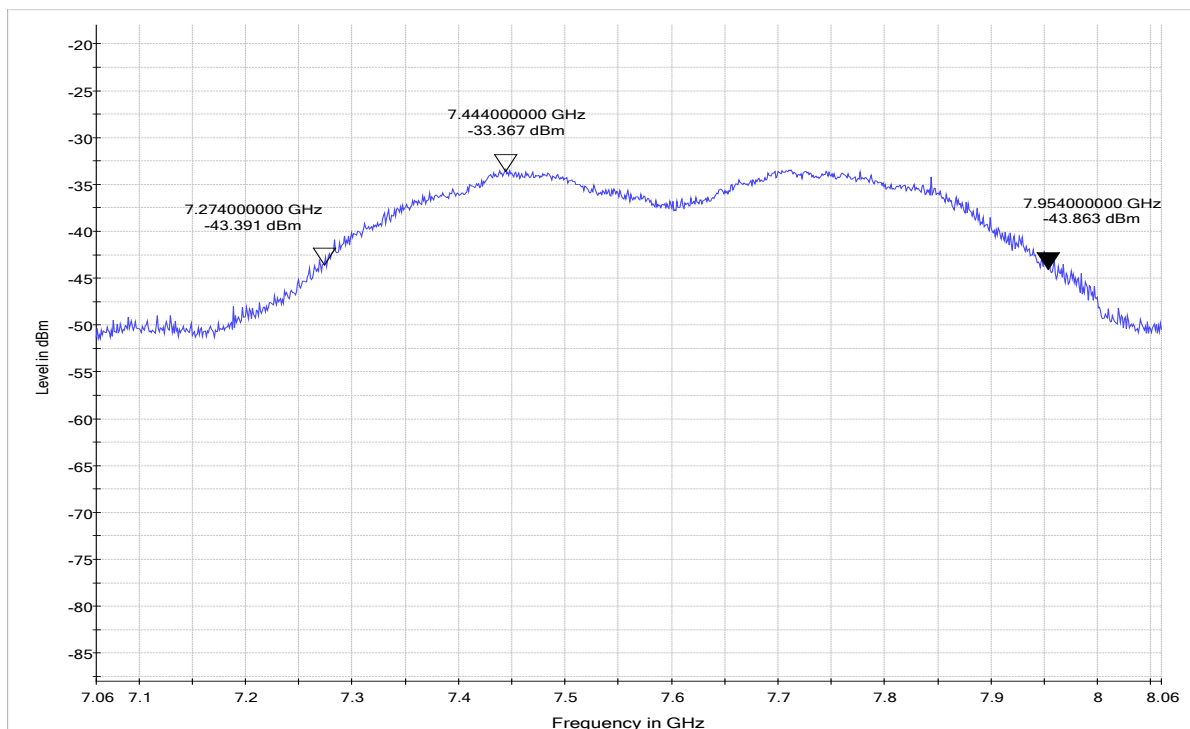

TEST EQUIPMENT USED:

- Radiated Emissions

4.3 PEAK EMISSION – 15.519(e)

Standard **FCC Part 15 Subpart F**

The test was performed according to:
ANSI C63.10

Definition:

The maximum peak power specified as e.i.r.p. contained within a 50 MHz bandwidth at the frequency at which the highest mean radiated power occurs, radiated in the direction of the maximum level under the specified conditions of measurement.

Test Procedure:

The Equipment Under Test (EUT) was set up on a non-conductive support (tilt device) at 1.5 m height in the fully-anechoic chamber.

All steps were performed with one height (1.5 m) of the receiving antenna only.

The measurement distance for all steps was 3m.

Step 1: Preliminary scan

This is a preliminary test to identify the direction of maximum output power level of the EUT.

Spectrum analyser settings for step 1:

- Resolution Bandwidth (RBW): 1 MHz
- Video Bandwidth (VBW): 3 MHz
- Detector: RMS
- Center Frequency: Nominal channel center frequency
- Span: 1 GHz
- Sweeptime: 1s
- Sweep points: 1001
- Sweeps: 10
- Trace: Maxhold

Turn table and antenna settings

- Turntable angle range: -180° to 90°
- Turntable step size (azimuth): 45°
- Elevation angle range: 0° - 90°
- Elevation step size: 90°
- Antenna polarisation: Horizontal + Vertical

Step 2: Adjustment measurement

In this step the accuracy of the turntable azimuth and antenna height will be improved. This is necessary to find out the maximum value of every frequency.

For the frequency with the highest power, the turntable azimuth and EUT elevation will be adjusted. The turntable azimuth will slowly vary by $\pm 22.5^{\circ}$. The elevation angle will slowly vary by $\pm 45^{\circ}$. During this action, the value of emission is continuously measured. The turntable azimuth at the highest emission will be recorded and adjusted. In this position, the elevation angle will also slowly vary by $\pm 22.5^{\circ}$ around the elevation angle determined in step one. During this action, the value of emission is also continuously measured. The elevation angle of the highest emission will also be recorded and adjusted.

- Measured frequencies: in step 1 determined frequencies
- Resolution Bandwidth (RBW): 1 MHz
- Video Bandwidth (VBW): 3 MHz
- Detector: RMS
- Sweep time: 100 ms
- Turntable angle range: $\pm 22.5^\circ$ around the determined value of step 1
- EUT elevation angle: $\pm 45^\circ$ around the determined value of step 1
- Antenna Polarisation: max. value determined in step 1

Step 3: Final measurement with the following analyser settings

Analyzer settings:

- Resolution Bandwidth (RBW): 50 MHz
- Video Bandwidth (VBW): 50 MHz
- Center Frequency: Nominal channel center frequency
- Span: 1 GHz
- Sweeptime: 1s
- Sweep points: 1001
- Trace: Maxhold
- Sweeps: until trace stabilizes
- Sweeptime: 1 s
- Detector: Peak

After the measurement, a plot will be generated which contains a diagram with the results of the final measurement. A marker shows the highest emission.

The radiated test was performed with the following setup:

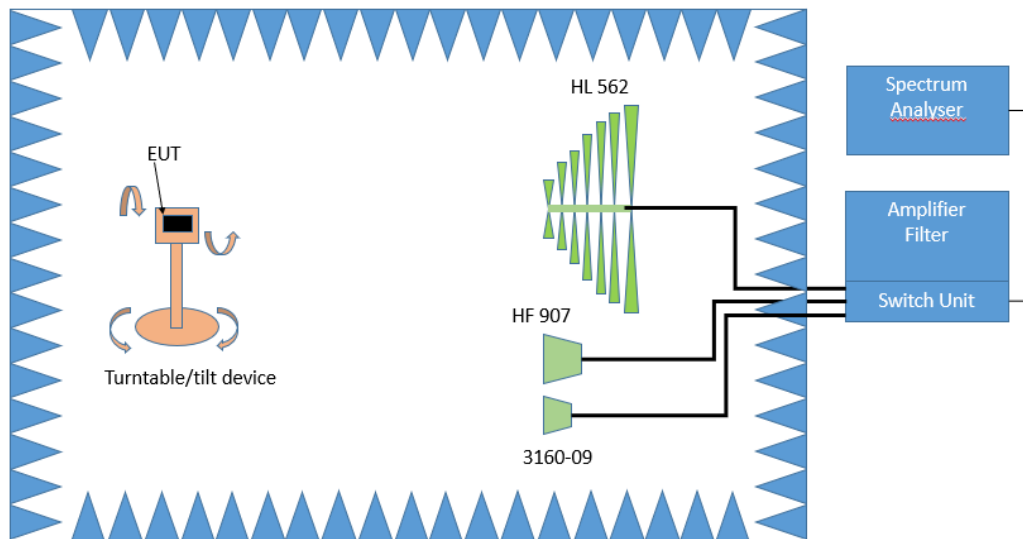

Test Setup; Spurious Emission Radiated (FAC), 30 MHz -26.5 GHz

4.3.1 TEST REQUIREMENTS / LIMITS

FCC Part 15, Subpart F, §15.519 (e)

There is a limit on the peak level of the emissions contained within a 50 MHz bandwidth centered on the frequency at which the highest radiated emission occurs, f_M . That limit is 0 dBm EIRP.

RSS-220, 5.3.1 (g)

The peak level of the transmissions shall not exceed the peak equivalent of the average limit contained within any 50 MHz bandwidth, as defined in section 4 of the Annex.

RSS-220, Annex 4 (c)

Peak measurements shall be made in addition to average measurements. Transmissions shall not exceed 0 dBm e.i.r.p. in any 50 MHz bandwidth when the average limit is -41.3 dBm/MHz.

4.3.2 TEST PROTOCOL

Ambient temperature: 24 °C
Air Pressure: 1019 hPa
Humidity: 31 %

Operating Band: 3100 - 10600 MHz				
Operating Frequency	Highest Peak Emission Power [dBm]	Highest Peak Emission Frequency [MHz]	Peak Limit [dBm]	Margin to Power Limit [dBm]
Low	-6.2	6719.00	0.0	6.2
Mid	-5.4	6943.00	0.0	5.4
High	-7.1	7827.00	0.0	7.1

4.3.3 MEASUREMENT PLOT (SHOWING THE HIGHEST VALUE, "WORST CASE")

Measurement method = radiated, Operating band = 3100 – 10600 MHz, Channel = low (S01_AA10)

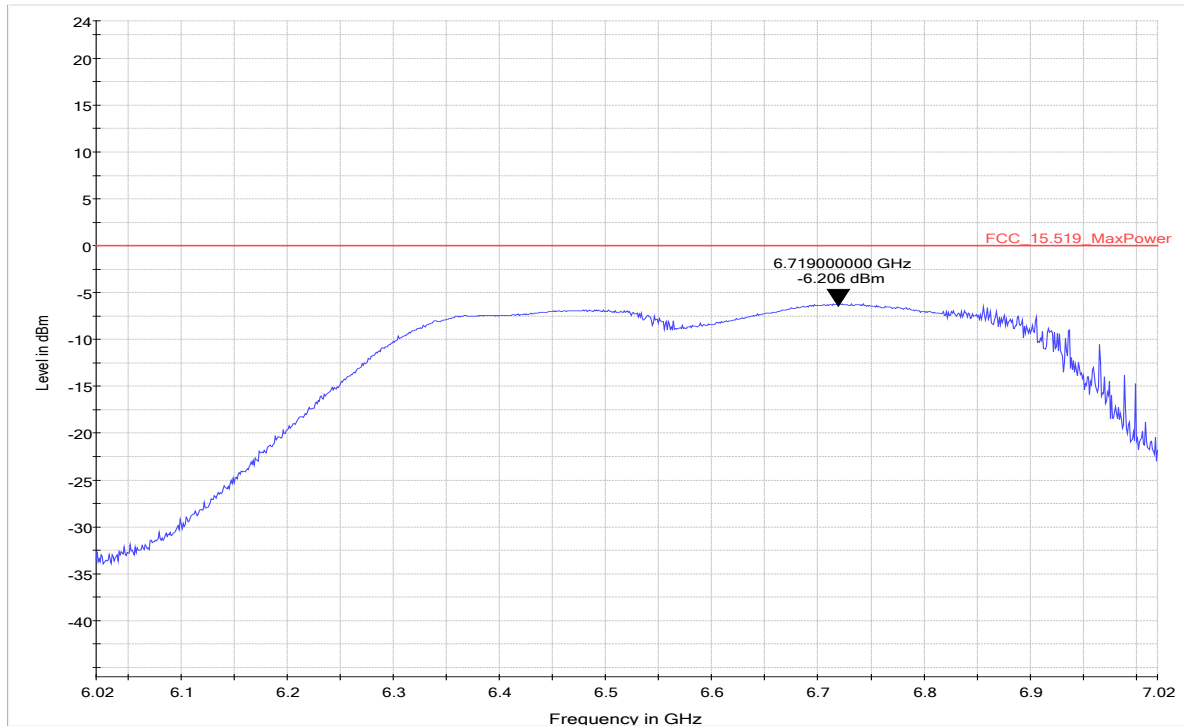

Measurement method = radiated, Operating band = 3100 – 10600 MHz, Channel = mid (S01_AA10)

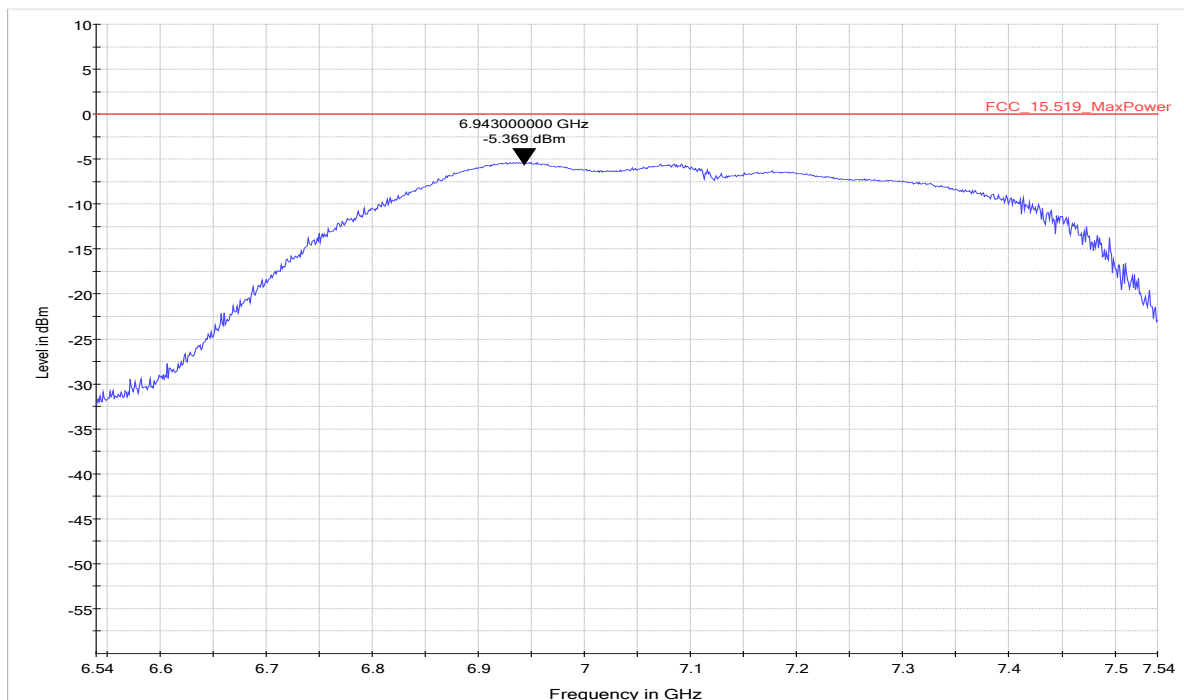

Measurement method = radiated, Operating band = 3100 – 10600 MHz, Channel = high (S01_AA10)

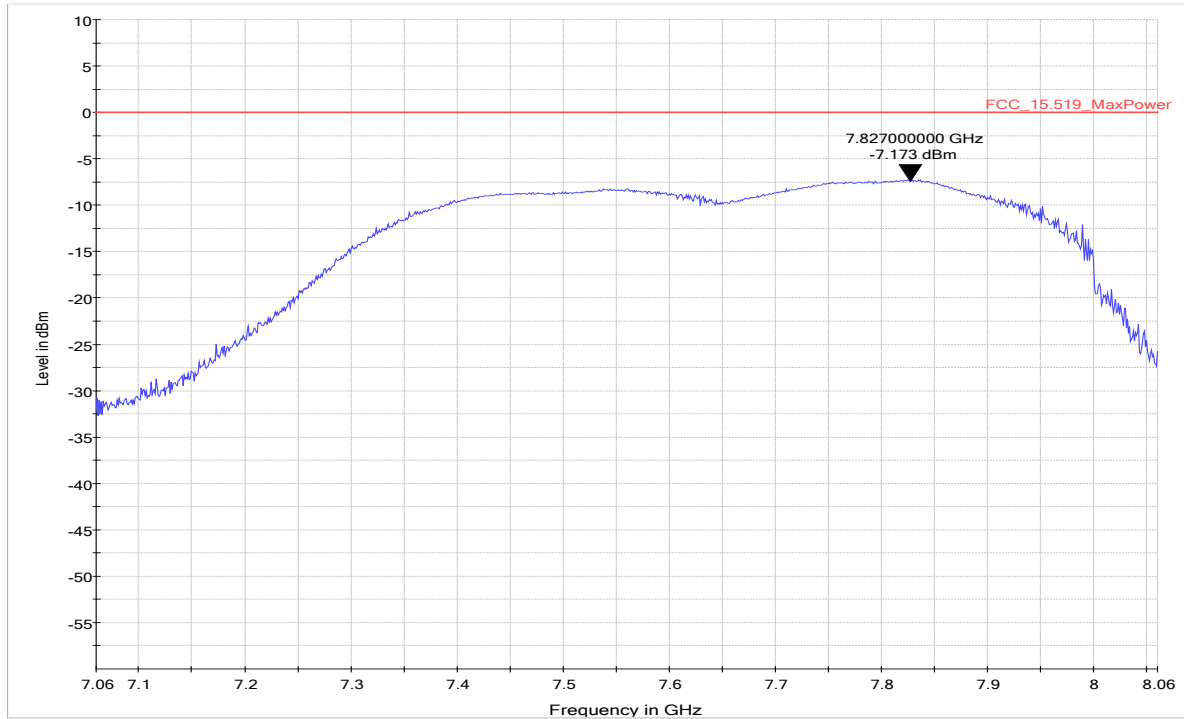

TEST EQUIPMENT USED:

- Radiated Emissions

4.4 PEAK EMISSION – 15.521(e)

Standard **FCC Part 15 Subpart F**

The test was performed according to:
ANSI C63.10

Definition:

The maximum peak power specified as e.i.r.p. contained within a 50 MHz bandwidth at the frequency at which the highest mean radiated power occurs, radiated in the direction of the maximum level under the specified conditions of measurement.

Test Procedure:

The Equipment Under Test (EUT) was set up on a non-conductive support (tilt device) at 1.5 m height in the fully-anechoic chamber.

All steps were performed with one height (1.5 m) of the receiving antenna only.

The measurement distance for all steps was 3m.

Step 1: Preliminary scan

This is a preliminary test to identify the direction of maximum output power level of the EUT.

Spectrum analyser settings for step 1:

- Resolution Bandwidth (RBW): 1 MHz
- Video Bandwidth (VBW): 3 MHz
- Detector: RMS
- Center Frequency: Nominal channel center frequency
- Span: 1 GHz
- Sweeptime: 1s
- Sweep points: 1001
- Sweeps: 10
- Trace: Maxhold

Turn table and antenna settings

- Turntable angle range: -180° to 90°
- Turntable step size (azimuth): 45°
- Elevation angle range: 0° - 90°
- Elevation step size: 90°
- Antenna polarisation: Horizontal + Vertical

Step 2: Adjustment measurement

In this step the accuracy of the turntable azimuth and antenna height will be improved. This is necessary to find out the maximum value of every frequency.

For the frequency with the highest power, the turntable azimuth and EUT elevation will be adjusted. The turntable azimuth will slowly vary by $\pm 22.5^{\circ}$. The elevation angle will slowly vary by $\pm 45^{\circ}$. During this action, the value of emission is continuously measured. The turntable azimuth at the highest emission will be recorded and adjusted. In this position, the elevation angle will also slowly vary by $\pm 22.5^{\circ}$ around the elevation angle determined in step one. During this action, the value of emission is also continuously measured. The elevation angle of the highest emission will also be recorded and adjusted.

- Measured frequencies: in step 1 determined frequencies
- Resolution Bandwidth (RBW): 1 MHz
- Video Bandwidth (VBW): 3 MHz
- Detector: RMS
- Sweep time: 100 ms
- Turntable angle range: $\pm 22.5^\circ$ around the determined value of step 1
- EUT elevation angle: $\pm 45^\circ$ around the determined value of step 1
- Antenna Polarisation: max. value determined in step 1

Step 3: Final measurement with the following analyser settings

Analyzer settings:

- Resolution Bandwidth (RBW): 50 MHz
- Video Bandwidth (VBW): 50 MHz
- Center Frequency: Nominal channel center frequency
- Span: 1 GHz
- Sweeptime: 1s
- Sweep points: 1001
- Trace: Maxhold
- Sweeps: until trace stabilizes
- Sweeptime: 1 s
- Detector: Peak

After the measurement, a plot will be generated which contains a diagram with the results of the final measurement. A marker shows the highest emission.

The radiated test was performed with the following setup:

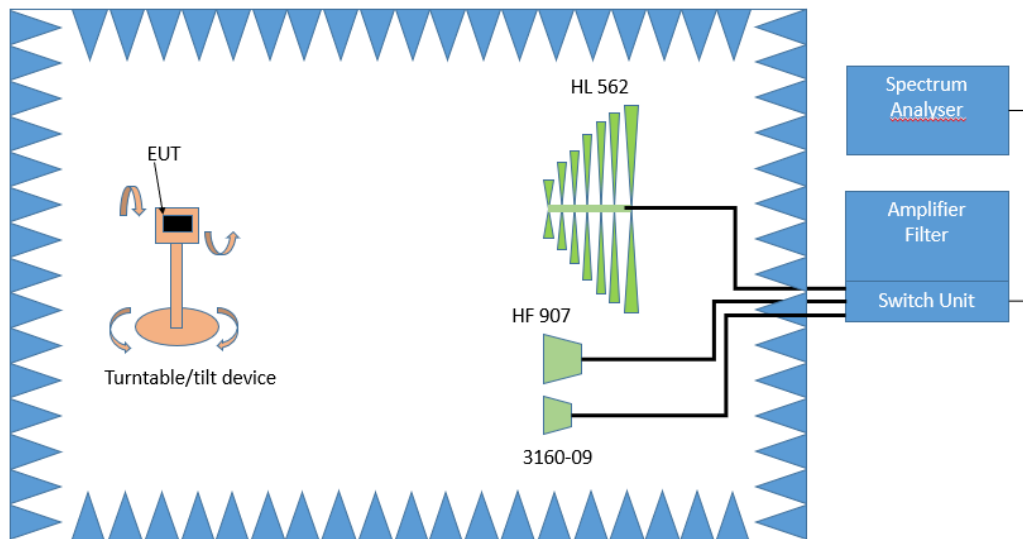

Test Setup; Spurious Emission Radiated (FAC), 30 MHz -26.5 GHz

4.4.1 TEST REQUIREMENTS / LIMITS

FCC Part 15, Subpart F, §15.221 (e)

The frequency at which the highest radiated emission occurs, f_m , must be contained within the UWB bandwidth.

4.4.2 TEST PROTOCOL

Ambient

temperature: 24 °C

Air Pressure: 1019 hPa

Humidity: 31 %

Operating Band: 3100 - 10600 MHz				
Channel	Lower -10 dB Frequency f_L [MHz]	Upper -10 dB Frequency f_H [MHz]	Highest Emission Frequency F_m [MHz]	Fmax within UWB Bandwidth
Low	6236.00	6914.00	6396.00	YES
Mid	6759.00	7434.00	6923.00	YES
High	7274.00	7954.00	7444.00	YES

4.4.3 MEASUREMENT PLOT (SHOWING THE HIGHEST VALUE, "WORST CASE")

Measurement method = radiated, Operating band = 3100 – 10600 MHz, Channel = low (S01_AA10)

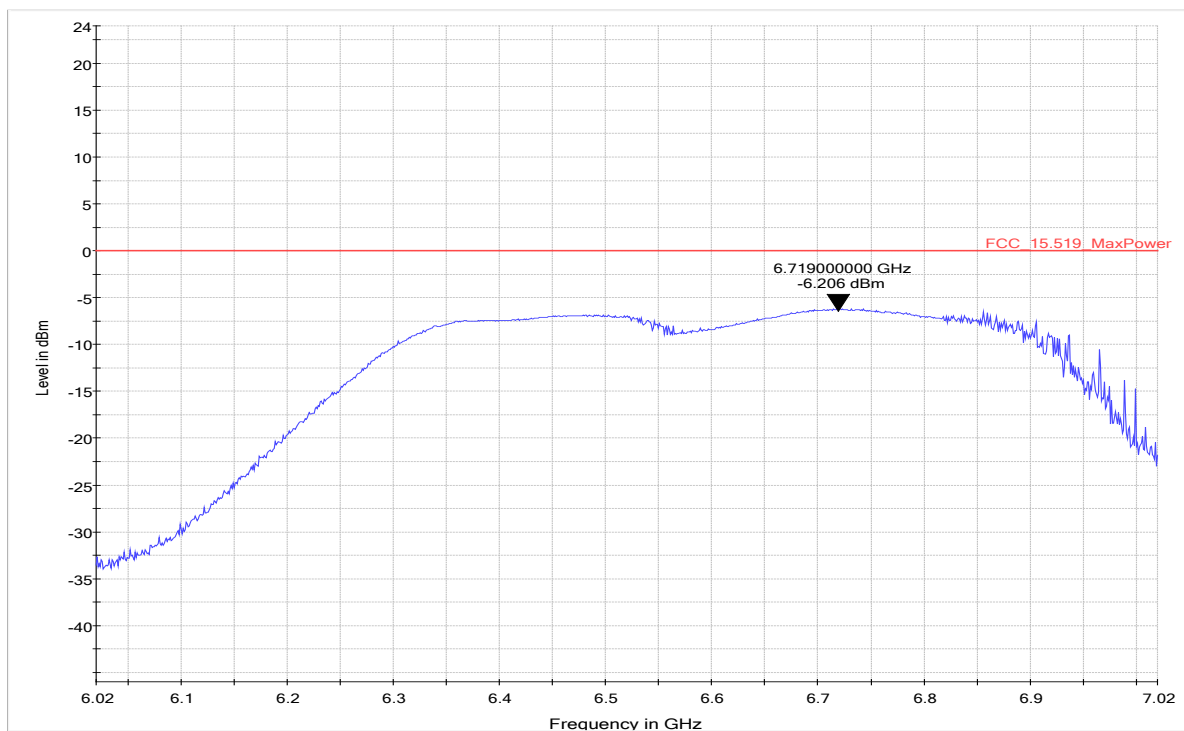

Measurement method = radiated, Operating band = 3100 – 10600 MHz, Channel = mid (S01_AA10)

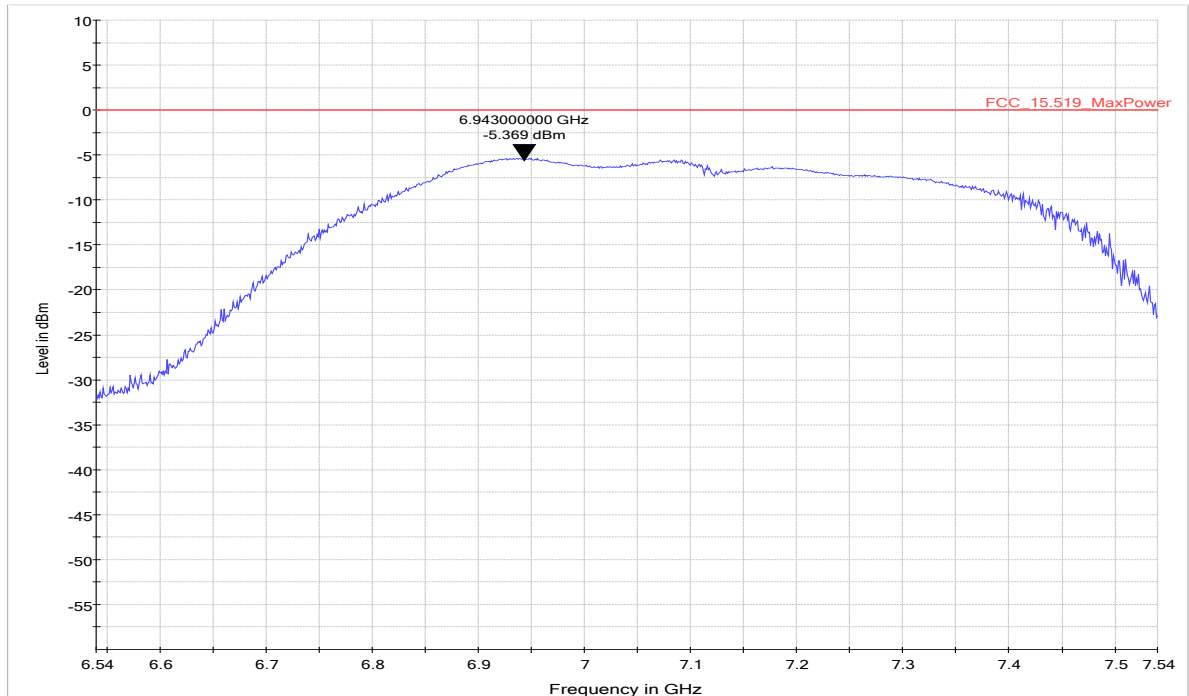

Measurement method = radiated, Operating band = 3100 – 10600 MHz, Channel = high (S01_AA10)

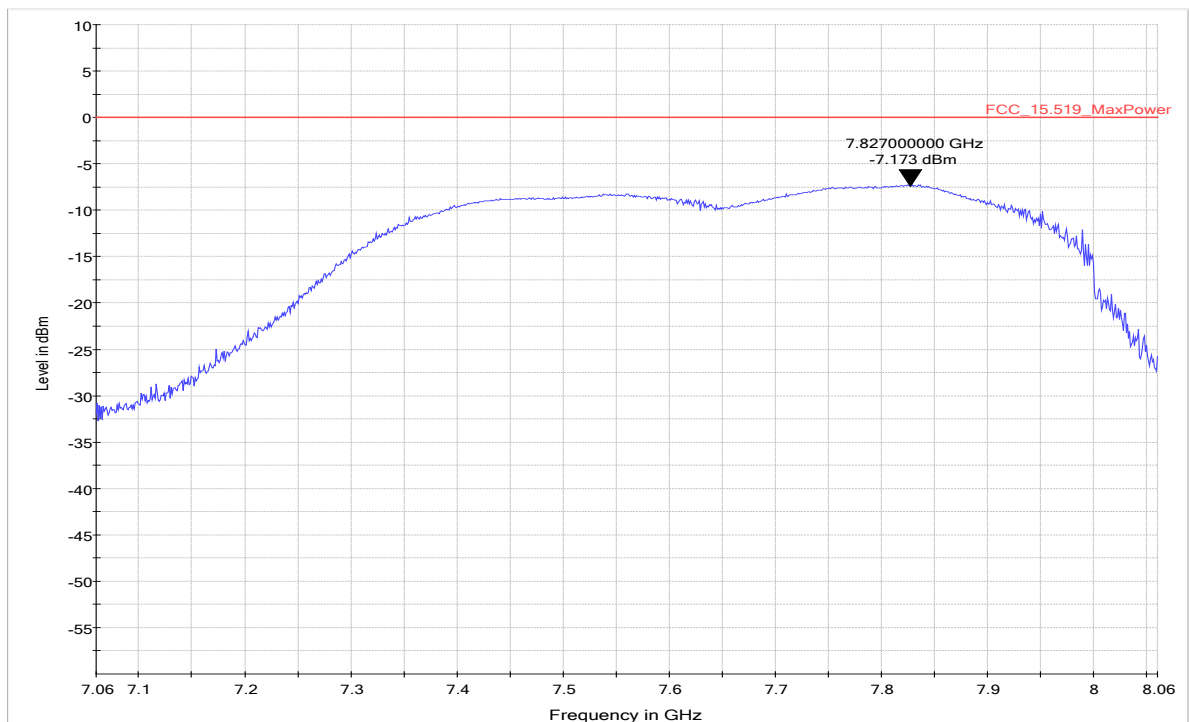

TEST EQUIPMENT USED:

- Radiated Emissions

4.5 RADIATED EMISSIONS

Standard **FCC Part 15 Subpart F**
FCC Part 15 Subpart C

The test was performed according to:
ANSI C63.10

4.5.1 TEST DESCRIPTION

The test set-up was made in accordance to the general provisions of ANSI C63.10 in a typical installation configuration. The Equipment Under Test (EUT) was set up on a non-conductive table 1.0 x 2.0 m² in the semi-anechoic chamber. The influence of the EUT support table that is used between 30–1000 MHz was evaluated.

The measurement procedure is implemented into the EMI test software EMC32 from R&S. Exploratory tests are performed at 3 orthogonal axes to determine the worst-case orientation of a body-worn or handheld EUT. The final test on all kind of EUTs is also performed at 3 axes. A pre-check is performed while the EUT is powered from a DC power source.

1. Measurement up to 30 MHz

The Loop antenna HFH2-Z2 is used.

Step 1: pre measurement

Settings for step 1:

- Anechoic chamber
- Antenna distance: 3 m
- Antenna height: 1 m
- Detector: Peak-Maxhold
- Frequency range: 0.009 - 0.15 MHz and 0.15 – 30 MHz
- Frequency steps: 0.05 kHz and 2.25 kHz
- IF-Bandwidth: 0.2 kHz and 9 kHz
- Measuring time / Frequency step: 100 ms (FFT-based)

Intention of this step is, to determine the radiated EMI-profile of the EUT. Afterwards the relevant emissions for the final measurement are identified.

Step 2: final measurement

For the relevant emissions determined in step 1, an additional measurement with the following settings will be performed. Intention of this step is to find the maximum emission level.

- Detector: Quasi-Peak (9 kHz – 150 kHz, Peak / Average 150 kHz- 30 MHz)
- Frequency range: 0.009 – 30 MHz
- Frequency steps: measurement at frequencies detected in step 1
- IF-Bandwidth: 0.2 - 10 kHz
- Measuring time / Frequency step: 1 s

2. Measurement above 30 MHz and up to 960 MHz

Step 1: Preliminary scan

This is a preliminary test to identify the highest amplitudes relative to the limit.

Settings for step 1:

- Measurement distance: 3 m
- Detector: Peak-Maxhold / Quasipeak (FFT-based)
- Frequency range: 30 – 1000 MHz
- Frequency steps: 30 kHz
- IF-Bandwidth: 120 kHz

- Measuring time / Frequency step: 100 ms
- Turntable angle range: -180° to 90°
- Turntable step size: 90°
- Height variation range: 1 – 3 m
- Height variation step size: 2 m
- Polarisation: Horizontal + Vertical

Intention of this step is, to determine the radiated EMI-profile of the EUT. Afterwards the relevant emissions for the final measurement are identified.

Step 2: Adjustment measurement

In this step the accuracy of the turntable azimuth and antenna height will be improved. This is necessary to find out the maximum value of every frequency.

For each frequency, which was determined the turntable azimuth and antenna height will be adjusted. The turntable azimuth will slowly vary by $\pm 45^{\circ}$ around this value. During this action, the value of emission is continuously measured. The turntable azimuth at the highest emission will be recorded and adjusted. In this position, the antenna height will also slowly vary by ± 100 cm around the antenna height determined. During this action, the value of emission is also continuously measured. The antenna height of the highest emission will also be recorded and adjusted.

- Detector: Peak – Maxhold
- Measured frequencies: in step 1 determined frequencies
- IF – Bandwidth: 120 kHz
- Measuring time: 100 ms
- Turntable angle range: $\pm 45^{\circ}$ around the determined value
- Height variation range: ± 100 cm around the determined value
- Antenna Polarisation: max. value determined in step 1

Step 3: Final measurement with QP detector

With the settings determined in step 2, the final measurement will be performed:

EMI receiver settings for step 3:

- Detector: Quasi-Peak (< 1 GHz)
- Measured frequencies: in step 1 determined frequencies
- IF – Bandwidth: 120 kHz
- Measuring time: 1 s

After the measurement a plot will be generated which contains a diagram with the results of the preliminary scan and a chart with the frequencies and values of the results of the final measurement.

3. Measurement 960 MHz – 18 GHz

The following modifications apply to the measurement procedure for the frequency range 960 MHz – 18 GHz:

The Equipment Under Test (EUT) was set up on a non-conductive support (tilt device) at 1.5 m height in the fully-anechoic chamber.

All steps were performed with one height (1.5 m) of the receiving antenna only.

The following spectrum analyser settings are used for all steps:

- Measurement distance: 1 m
- Detector: RMS
- RBW: 1 MHz
- VBW: 3 MHz
- Measuring time: 1 ms / Sweep point
- Sweep Points: 1 / MHz [Span]

Step 1: Preliminary scan

Settings for step 1:

- Turntable angle range: -180° to 90°
- Turntable step size: 45°
- Elevation step size: 90°
- Polarisation: Horizontal + Vertical

Step 2: Adjustment measurement

In this step the accuracy of the turntable azimuth elevation will be improved. This is necessary to find out the maximum value of every frequency.

For each frequency, which was determined the turntable azimuth and elevation angle will be adjusted. The turntable azimuth will slowly vary by $\pm 22.5^{\circ}$ around this value. During this action, the value of emission is continuously measured. The turntable azimuth at the highest emission will be recorded and adjusted. In this position, the elevation angle will also slowly vary by $\pm 45^{\circ}$. During this action, the value of emission is also continuously measured. The elevation angle of the highest emission will also be recorded and adjusted.

- Turntable angle range: $\pm 22.5^{\circ}$ around the determined value
- Elevation angle range: $\pm 45^{\circ}$ around the determined value
- Antenna Polarisation: max. value determined in step 1

Step 3: Final measurement with RMS detector

With the settings determined in step 2, the final measurement will be performed:

4. Measurement 18 GHz – 26 GHz

The only difference to measurement procedure in the frequency range 960 MHz – 18 GHz, is the reduced measurement distance of 0.5 m. The measurement procedure is identical.

5. Measurement 26 GHz – 40 GHz

The measurement settings and procedure for this frequency range are identical to the frequency range 960 MHz to 18 GHz.

The Test was performed radiated in a Semi and Fully Anechoic Chamber in the following setups:

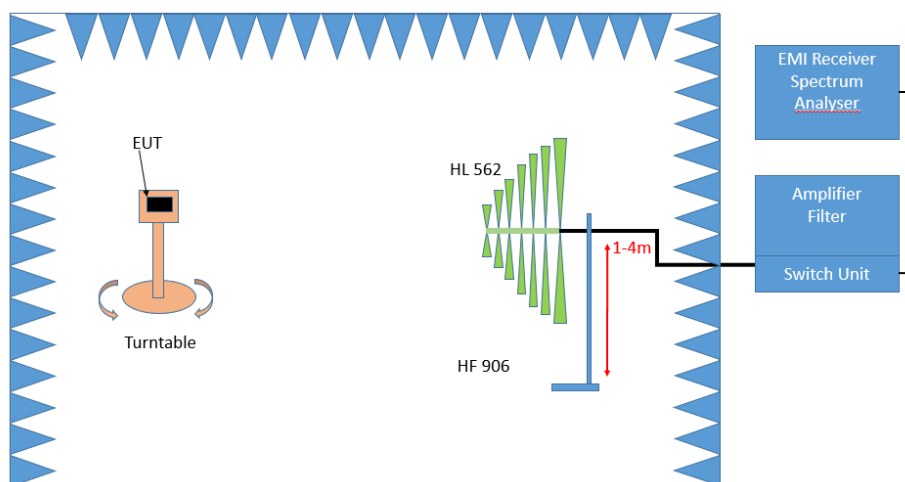

Test Setup; Spurious Emission Radiated (SAC), 30 MHz- 1GHz

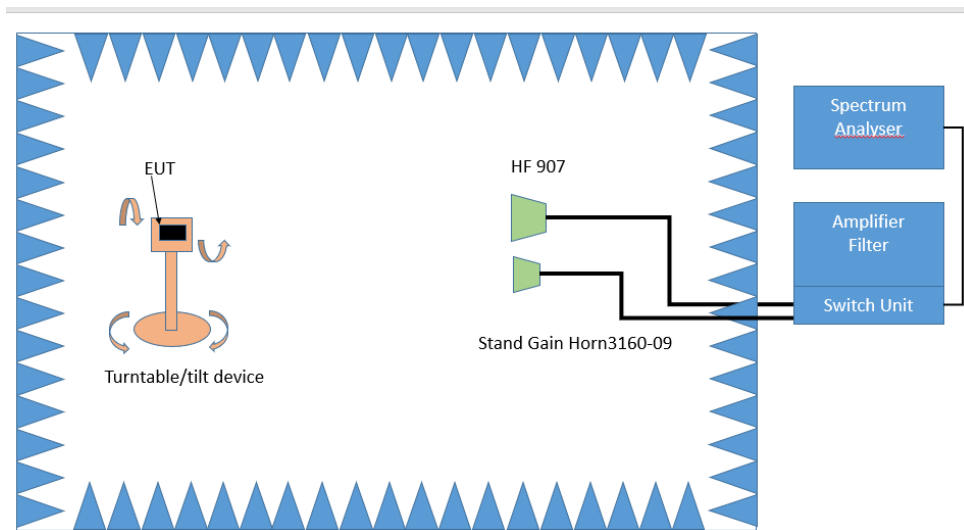

Test Setup; Spurious Emission Radiated (FAC), 1 GHz-26.5 GHz

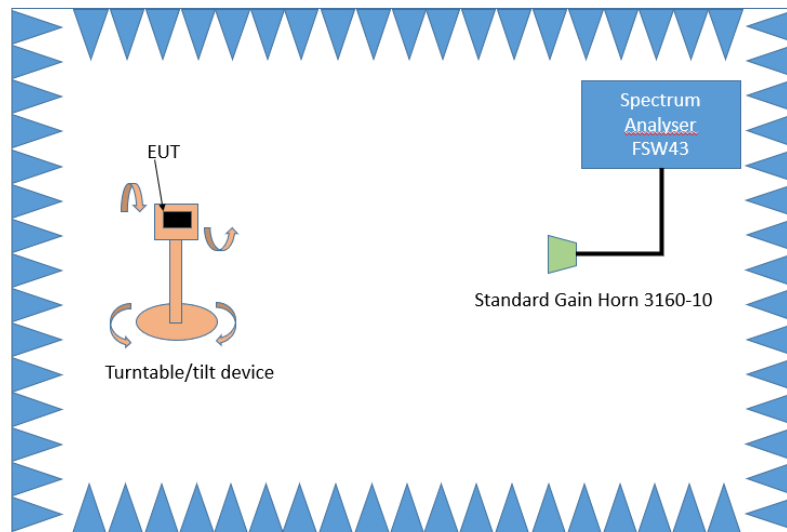

Test Setup; Spurious Emission Radiated (FAC), 26.5 – 40 GHz

4.5.2 TEST REQUIREMENTS / LIMITS

FCC Part 15, Subpart F, §15.519 (c)

The radiated emissions at or below 960 MHz from a device operating under the provisions of this section shall not exceed the emission levels in §15.209. The radiated emissions above 960 MHz from a device operating under the provisions of this section shall not exceed the following average limits when measured using a resolution bandwidth of 1 MHz:

Frequency in MHz	EIRP in dBm
960 – 1610	-75.3
1610 – 1990	-63.3
1990 – 3100	-61.3
3100 – 10600	-41.3
Above 10600	-61.3

FCC Part 15, Subpart C, §15.209, Radiated Emission Limits

Frequency in MHz	Limit ($\mu\text{V}/\text{m}$)	Measurement distance (m)	Limits ($\text{dB}\mu\text{V}/\text{m}$)
0.009 – 0.49	2400/F(kHz)@300m	3	(48.5 – 13.8)@300m
0.49 – 1.705	24000/F(kHz)@30m	3	(33.8 – 23.0)@30m
1.705 – 30	30@30m	3	29.5@30m

The measured values are corrected with an inverse linear distance extrapolation factor (40 dB/decade) according FCC 15.31 (2).

Frequency in MHz	Limit ($\mu\text{V}/\text{m}$)	Measurement distance (m)	Limits ($\text{dB}\mu\text{V}/\text{m}$)
30 – 88	100@3m	3	40.0@3m
88 – 216	150@3m	3	43.5@3m
216 – 960	200@3m	3	46.0@3m

RSS-220, 5.3.1 (c)

Radiated emissions at or below 960 MHz from a device shall not exceed the limits in section 3.4.

RSS-220, 3.4

Radiated emissions at or below 960 MHz for all subclasses of UWB device shall not exceed the following limits. Measurements of radiated emissions at and below 960 MHz are to be made using a CISPR quasi-peak detector. CISPR measurement bandwidth specifications are to be used.

Frequency in MHz	Limit ($\mu\text{V}/\text{m}$)	Measurement distance (m)	Limits ($\text{dB}\mu\text{V}/\text{m}$)
0.009 – 0.49	2400/F(kHz)@300m	3	(48.5 – 13.8)@300m
0.49 – 1.705	24000/F(kHz)@30m	3	(33.8 – 23.0)@30m
1.705 – 30	30@30m	3	29.5@30m

The measured values are corrected with an inverse linear distance extrapolation factor (40 dB/decade) according FCC 15.31 (2).

Frequency in MHz	Limit ($\mu\text{V}/\text{m}$)	Measurement distance (m)	Limits ($\text{dB}\mu\text{V}/\text{m}$)
30 – 88	100@3m	3	40.0@3m
88 – 216	150@3m	3	43.5@3m
216 – 960	200@3m	3	46.0@3m

RSS-220, 5.3.1 (d)

Radiated emissions above 960 MHz from a device shall not exceed the following average limits when measured using a resolution bandwidth of 1 MHz.

Frequency in MHz	EIRP in dBm
960 – 1610	-75.3
1610 – 4.750	-70.0
4750 – 10600	-41.3
Above 10600	-61.3

4.5.3 TEST PROTOCOL

Ambient temperature: 23-24 °C
Air Pressure: 1000–1016 hPa
Humidity: 38–41 %

Operating Band: 3100 - 10600 MHz [FCC]						
Operating Frequency	Spurious Freq. [MHz]	Spurious Level [dBm]	Detector	RBW [kHz]	Limit [dBm]	Margin to Limit [dB]
low	3024.2	-67.1	RMS	1000	-61.3	5.8
mid	3024.2	-67.6	RMS	1000	-61.3	6.3
high	3024.2	-67.8	RMS	1000	-61.3	6.5

Operating Band: 3100 - 10600 MHz [ISED RSS-220]						
Operating Frequency	Spurious Freq. [MHz]	Spurious Level [dBm]	Detector	RBW [kHz]	Limit [dBm]	Margin to Limit [dB]
low	3024.2	-67.1	RMS	1000	-70.0	-2.9
mid	3024.2	-67.6	RMS	1000	-70.0	-2.4
high	3024.2	-67.8	RMS	1000	-70.0	-2.2

Operating Band: 3100 - 10600 MHz [ISED RSS-Gen]						
Operating Frequency	Spurious Freq. [MHz]	Spurious Level [dBm]	Detector	RBW [kHz]	Limit [dBm]*)	Margin to Limit [dB]
low	3024.2	-67.1	RMS	1000	-31.7	35.4
mid	3024.2	-67.6	RMS	1000	-31.7	35.9
high	3024.2	-67.8	RMS	1000	-31.7	36.1

*) Limit calculation RSS-Gen:

- Above 906 MHz → 500 μV/m@3m → 54 dBμV/m@3m
- $P(\text{EIRP})[\text{dBm}] = E[\text{dB}\mu\text{V}/\text{m}@3\text{m}] - 95.2 \rightarrow \text{Limit: } P(\text{EIRP}) = -41.2 \text{ dBm}$
- Correction due to different measurement distance: 3m → 1m: +9.5 dB → Limit: -31.7 dBm

According customers declaration:

The emission at 3024.2 MHz comes from the digital circuitry/IC of the EUT not intended or direct part of UWB transmission through UWB antenna. The signal is radiated by the enclosure of the EUT. The built-in UWB antenna, is from their physical dimensions, too small to emit radio waves in this frequency range. The main UWB signal power and emission at 3024.2 MHz occur at the different angles of the EUT that also indicates that the emissions are not from the UWB antenna.

To demonstrate this, relative measurements of the disturbance at 3024.2 MHz, with different operating modes, have been performed. This shows that the disturbance is complete independent from the UWB transmission technology. For details please see the measurements plots in the next-sub-clause.

Remark: Please see next sub-clause for the measurement plot.

4.5.4 MEASUREMENT PLOT (SHOWING THE HIGHEST VALUE, "WORST CASE")

Measurement method = radiated, Operating band = 3100 – 10600 MHz,
Frequency range 9 kHz – 30 MHz, Channel = high
(S01_AA10)

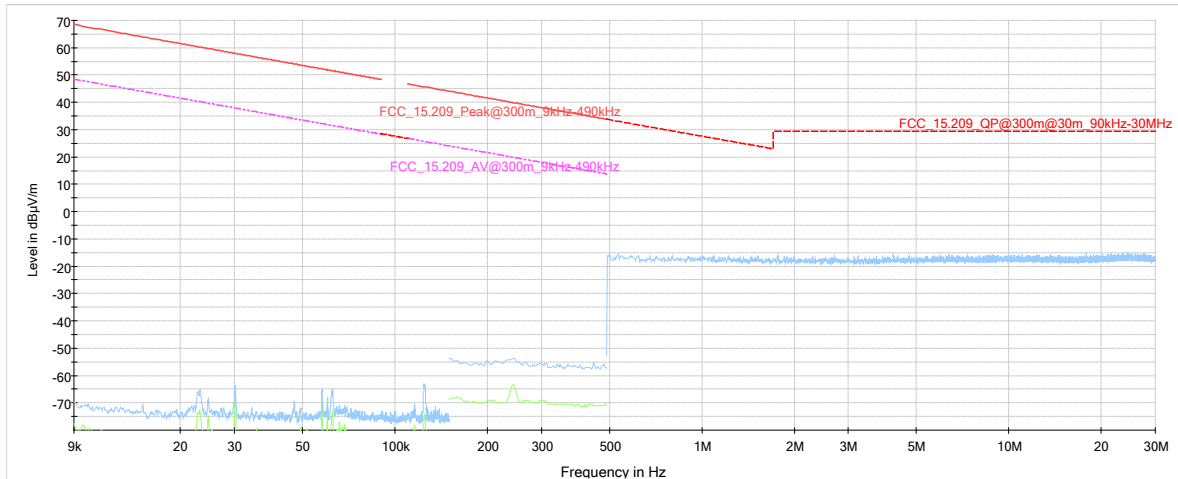

Measurement method = radiated, Operating band = 3100 – 10600 MHz,
Frequency range 9 kHz – 30 MHz, Channel = mid
(S01_AA10)

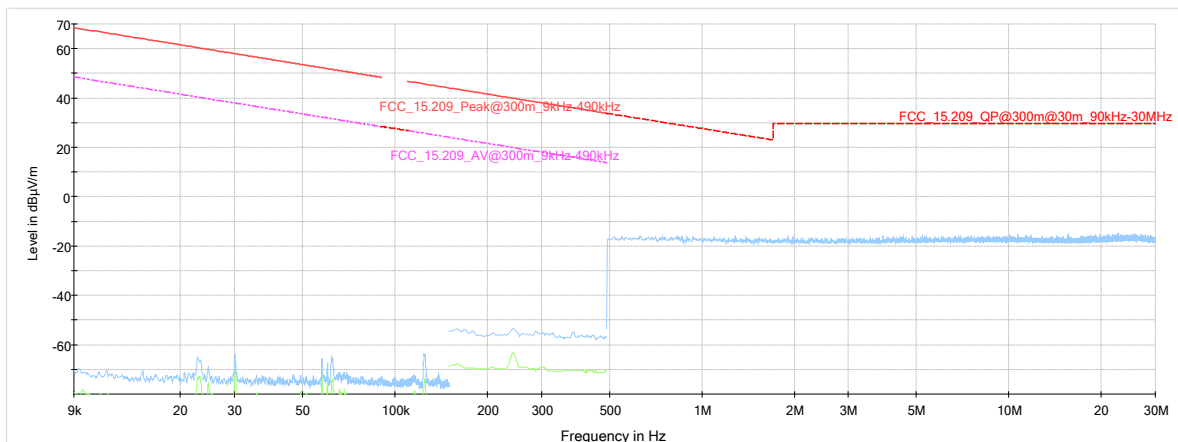

Measurement method = radiated, Operating band = 3100 – 10600 MHz,
Frequency range 9 kHz – 30 MHz, Channel = high
(S01_AA10)

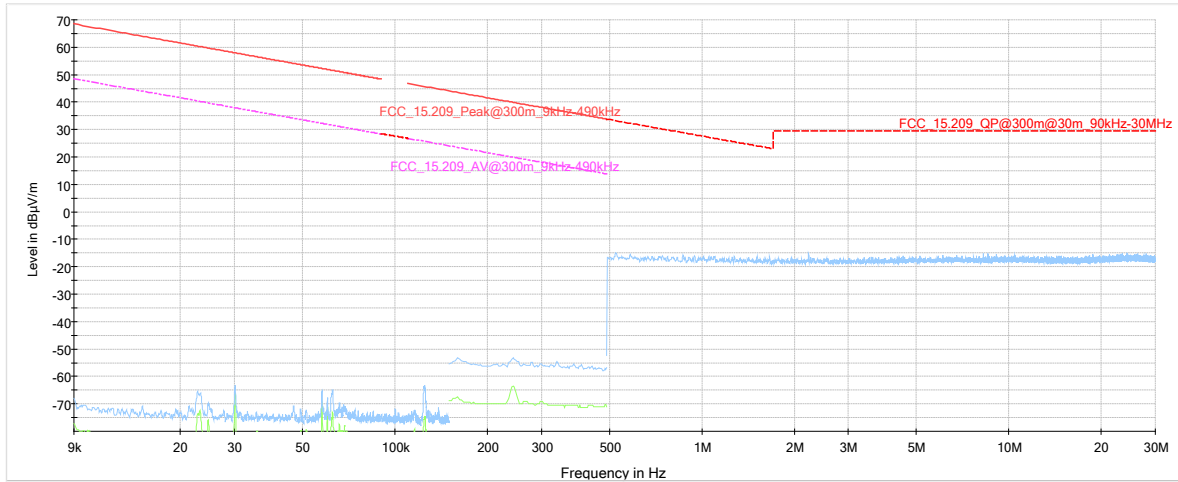

Measurement method = radiated, Operating band = 3100 – 10600 MHz,
Frequency range 30 MHz – 960 MHz, Channel = low
(S01_AA10)

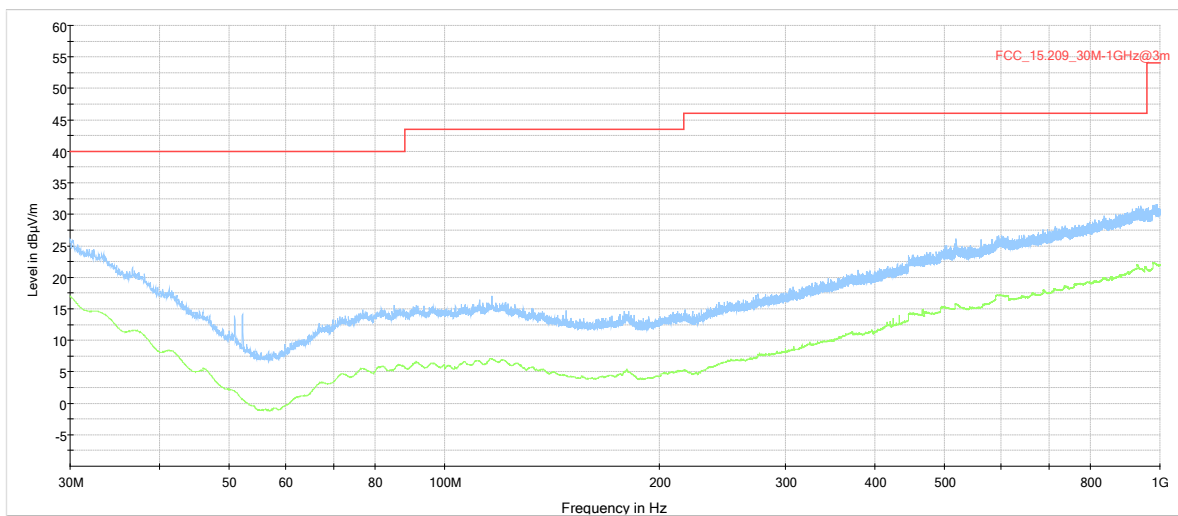

Measurement method = radiated, Operating band = 3100 – 10600 MHz,
Frequency range 30 MHz – 960 MHz, Channel = mid
(S01_AA10)

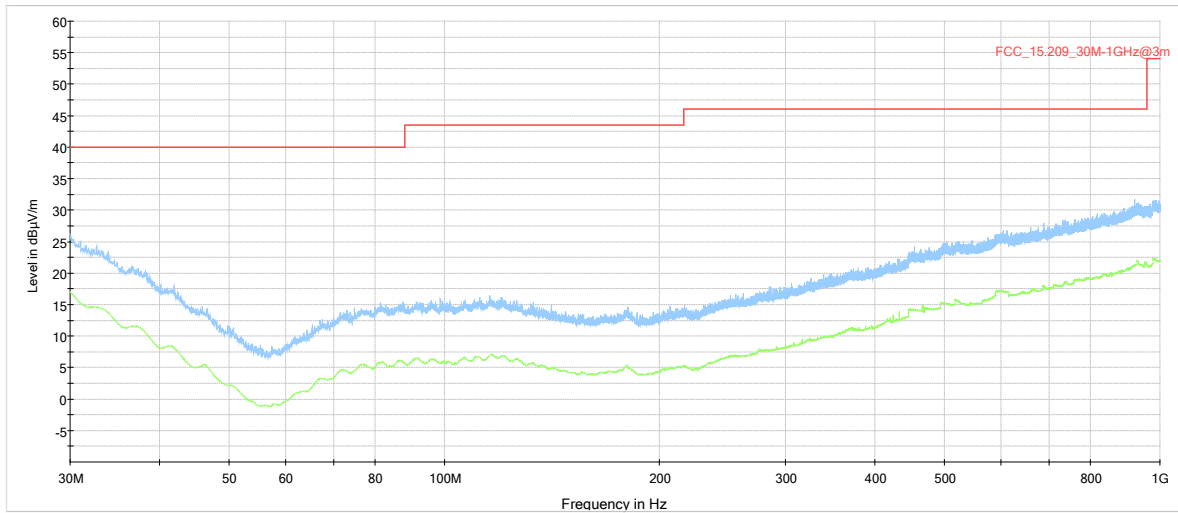

Measurement method = radiated, Operating band = 3100 – 10600 MHz,
Frequency range 30 MHz – 960 MHz, Channel = high
(S01_AA10)

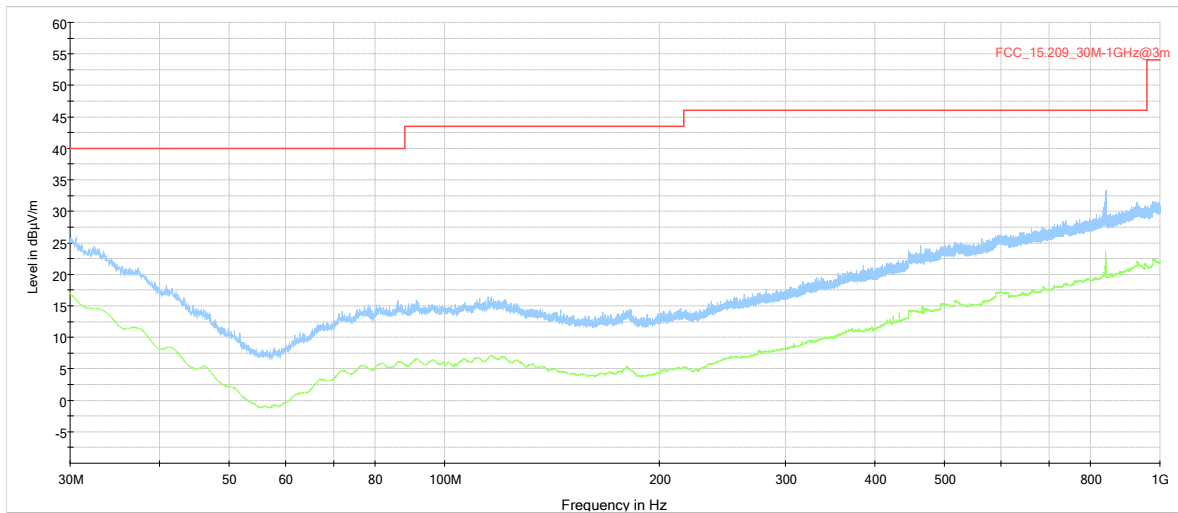

Measurement method = radiated, Operating band = 3100 – 10600 MHz,
Frequency range 960 MHz – 18 GHz, Channel = low
(S01_AA10)

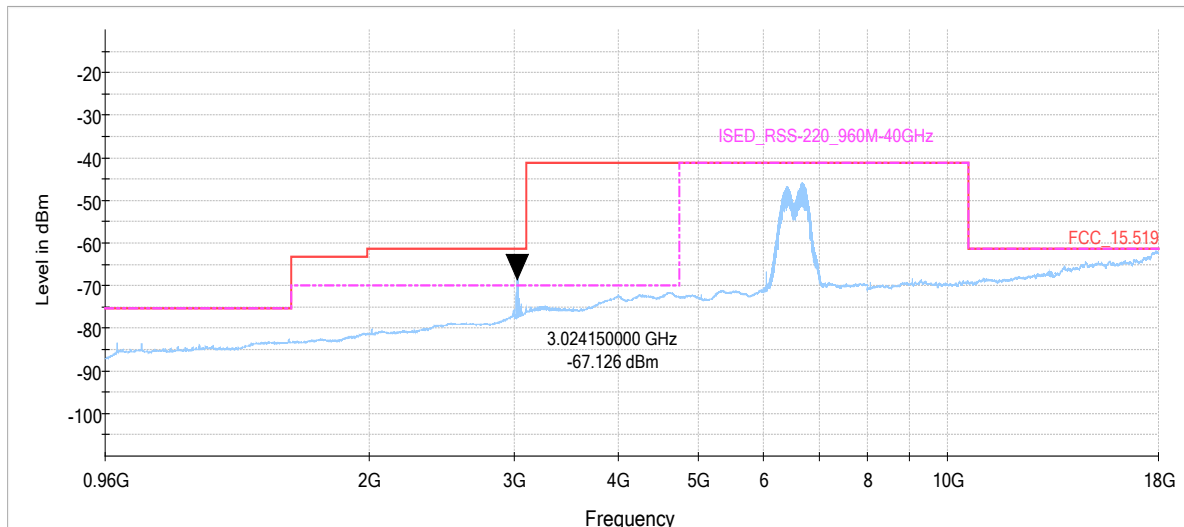

Measurement method = radiated, Operating band = 3100 – 10600 MHz,
Frequency range 960 MHz – 18 GHz, Channel = mid
(S01_AA10)

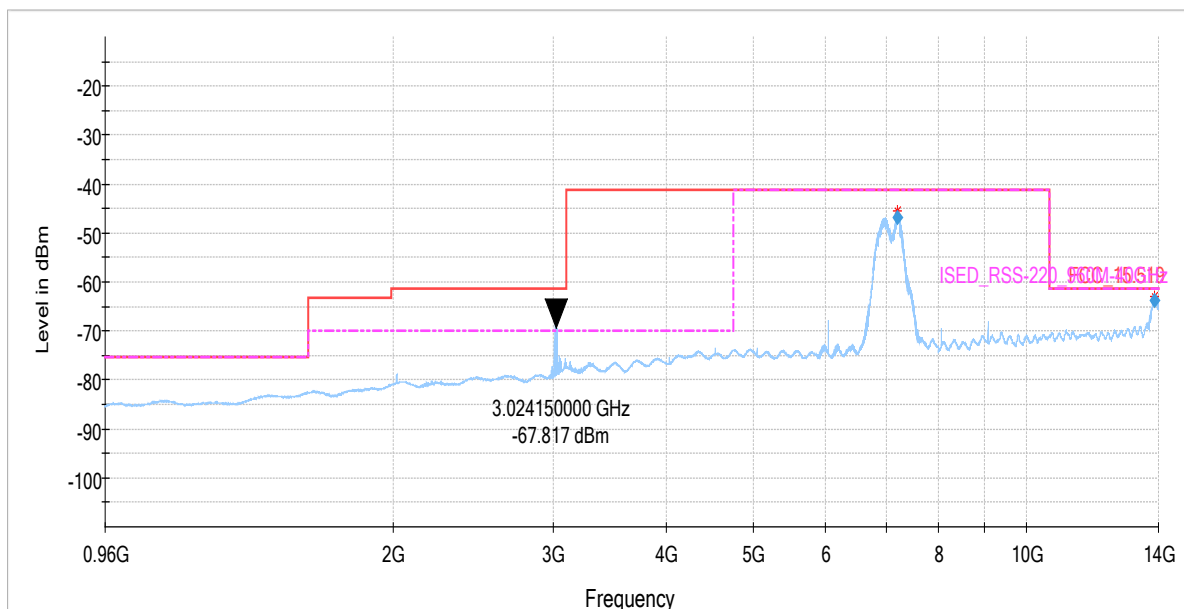

960 MHz – 14 GHz

Note: Frequency range splitted, Peak at 13.8 GHz harmonic disturbance produced by the test system.

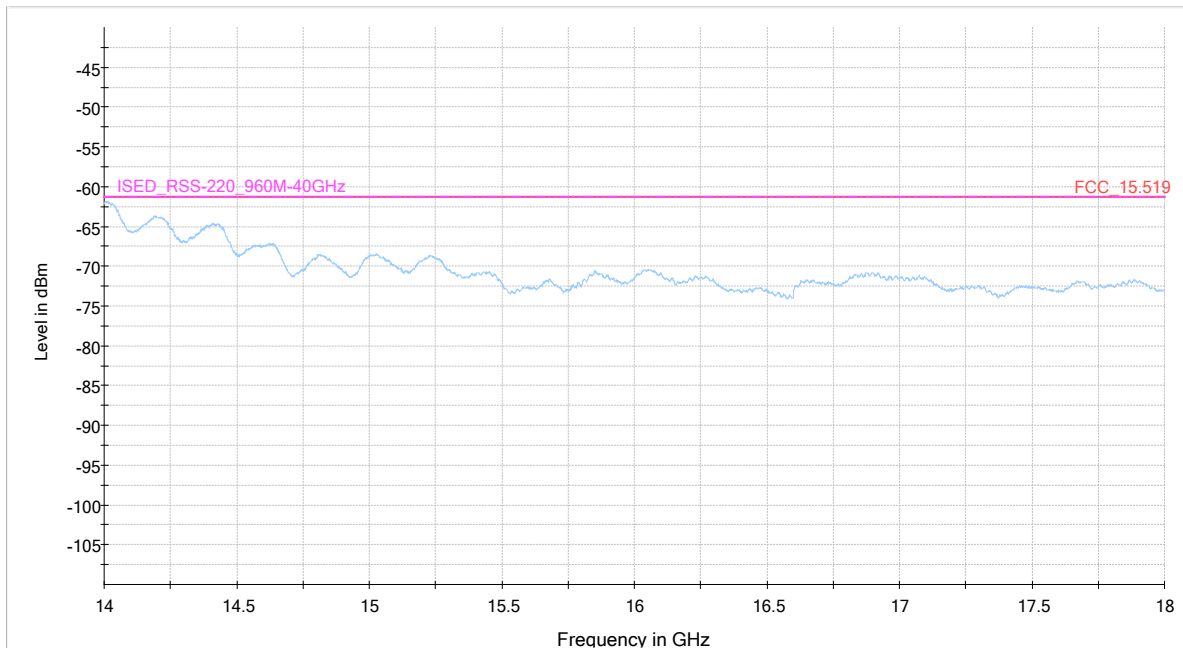

14 GHz – 18 GHz

Measurement method = radiated, Operating band = 3100 – 10600 MHz,
Frequency range 960 MHz – 18 GHz, Channel = high
(S01_AA10)

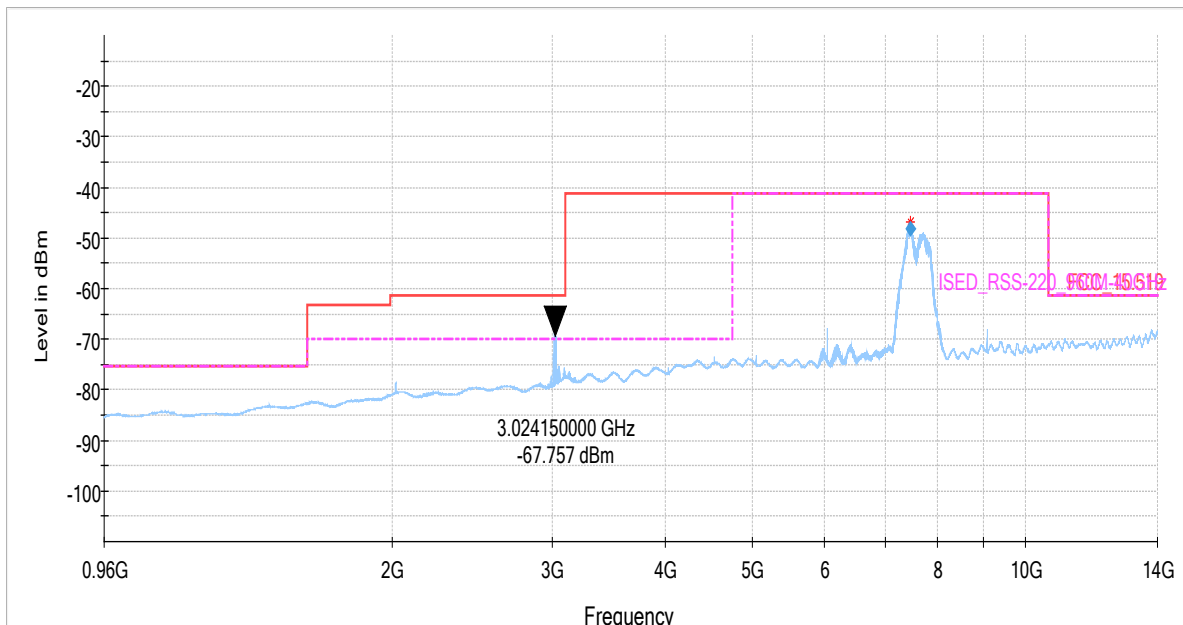

960 MHz – 14 GHz

Note: Frequency range splitted

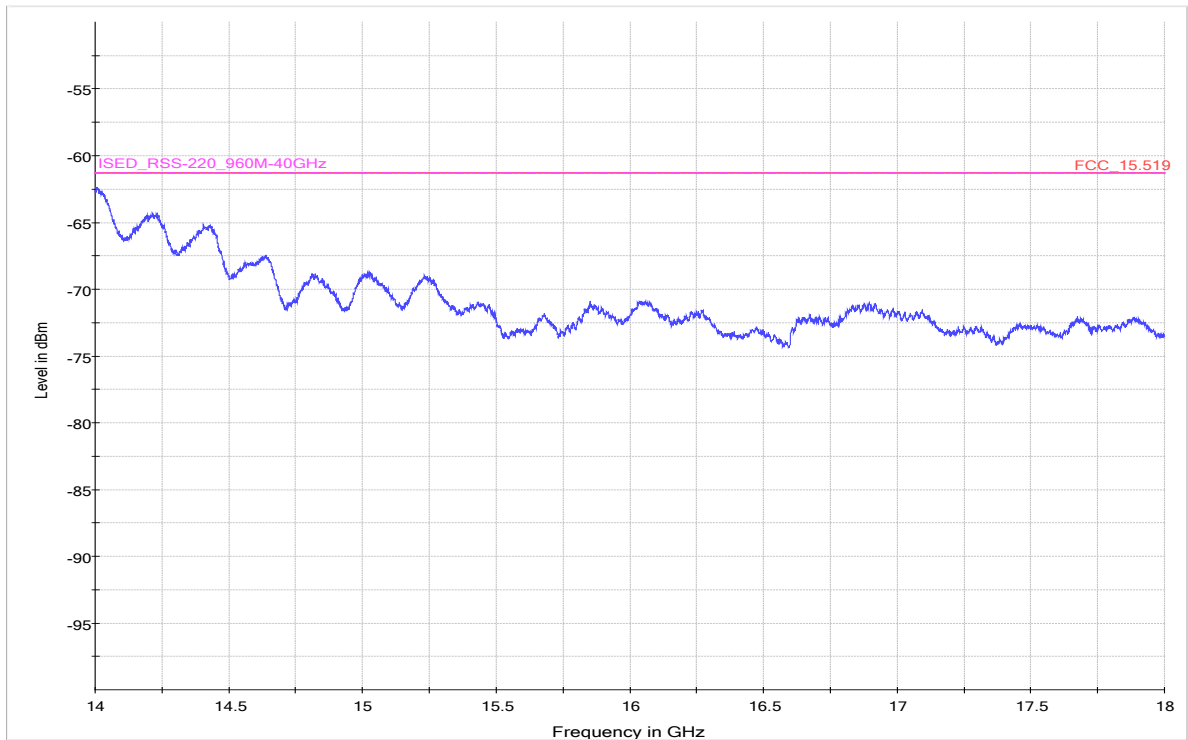

14 GHz – 18 GHz

Measurement method = radiated, Operating band = 3100 – 10600 MHz,
Frequency range 18 GHz – 26 GHz, Channel = low
(S01_AA10)

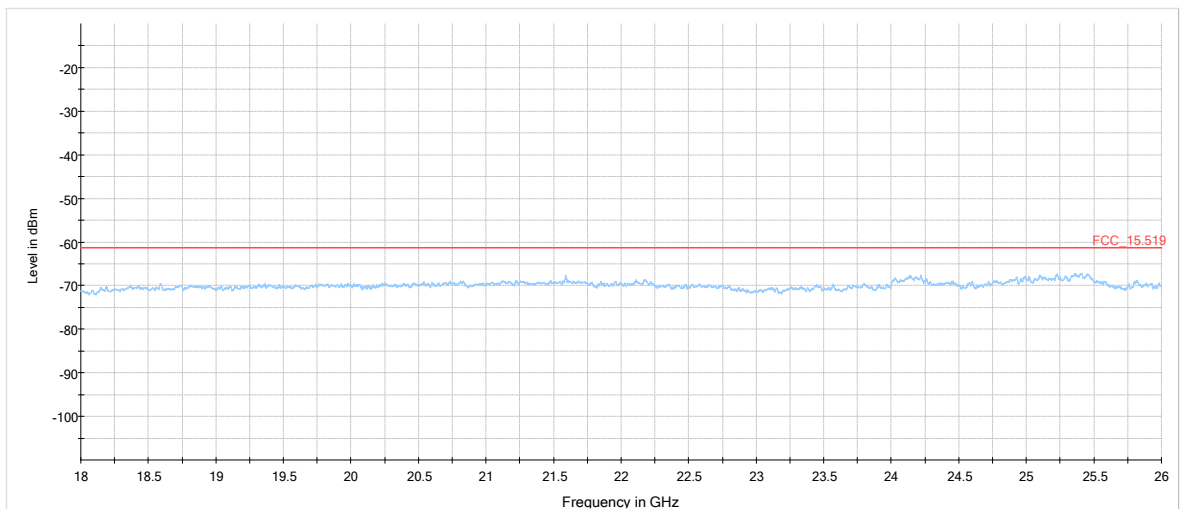

Measurement method = radiated, Operating band = 3100 – 10600 MHz,
Frequency range 18 GHz – 26 GHz, Channel = mid
(S01_AA10)

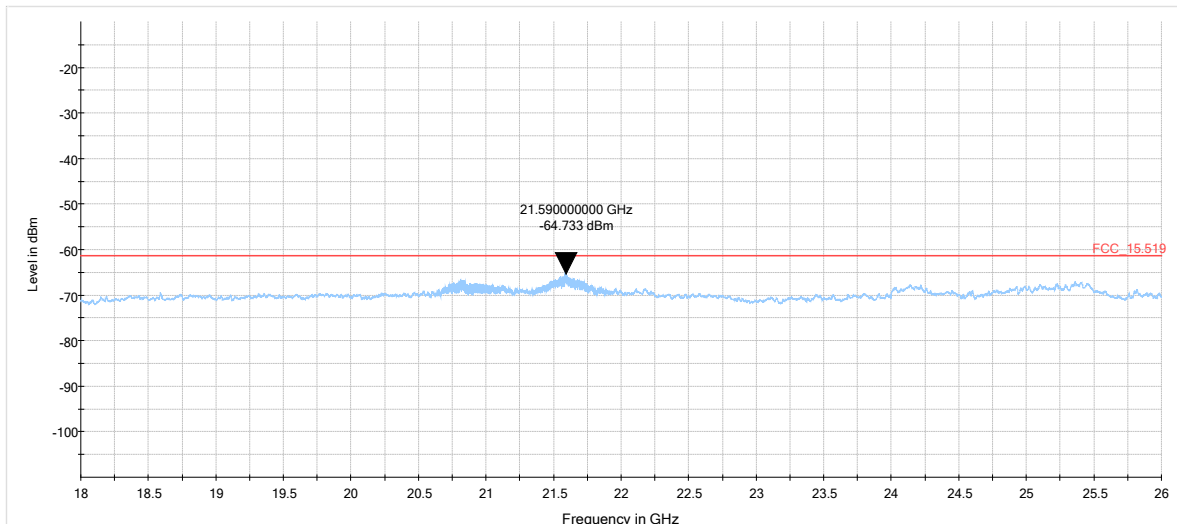

Measurement method = radiated, Operating band = 3100 – 10600 MHz,
Frequency range 18 GHz – 26 GHz, Channel = high
(S01_AA10)

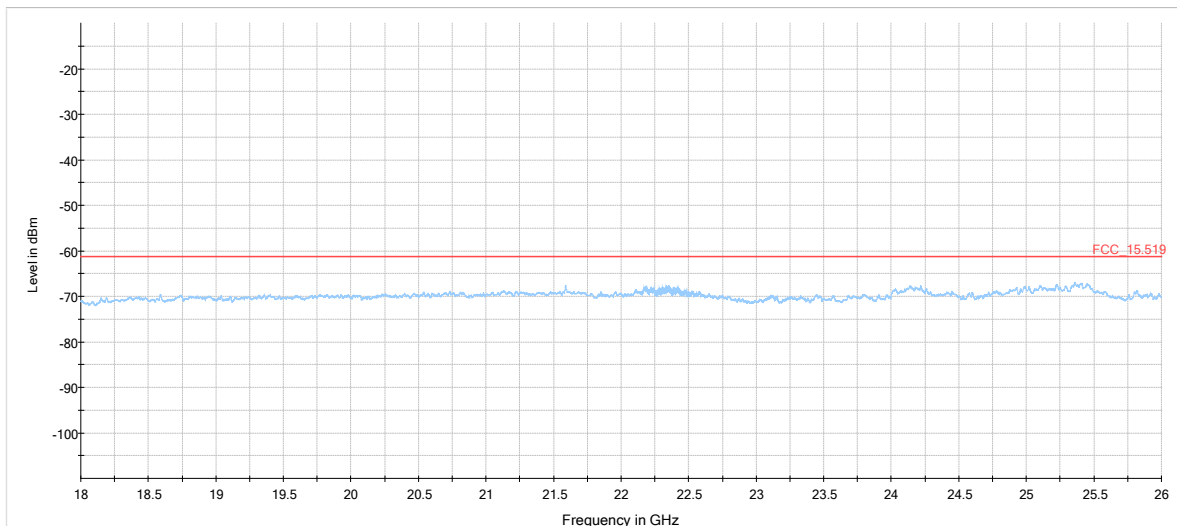

Measurement method = radiated, Operating band = 3100 – 10600 MHz,
Frequency range 26 GHz – 40 GHz, Channel = low
(S01_AA10)

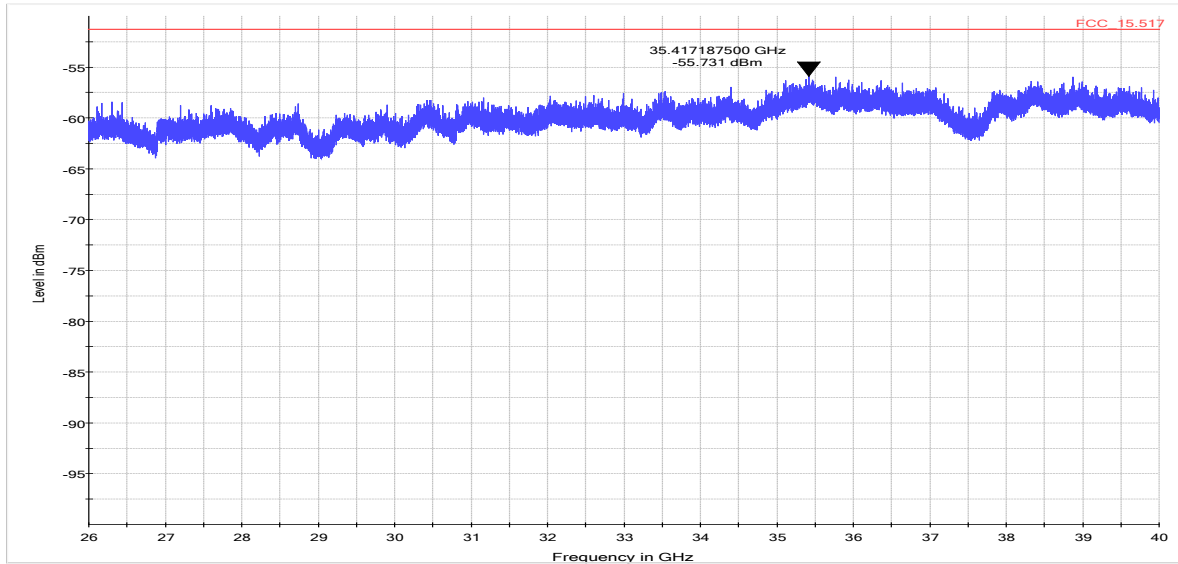

Measurement method = radiated, Operating band = 3100 – 10600 MHz,
Frequency range 26 GHz – 40 GHz, Channel = mid
(S01_AA10)

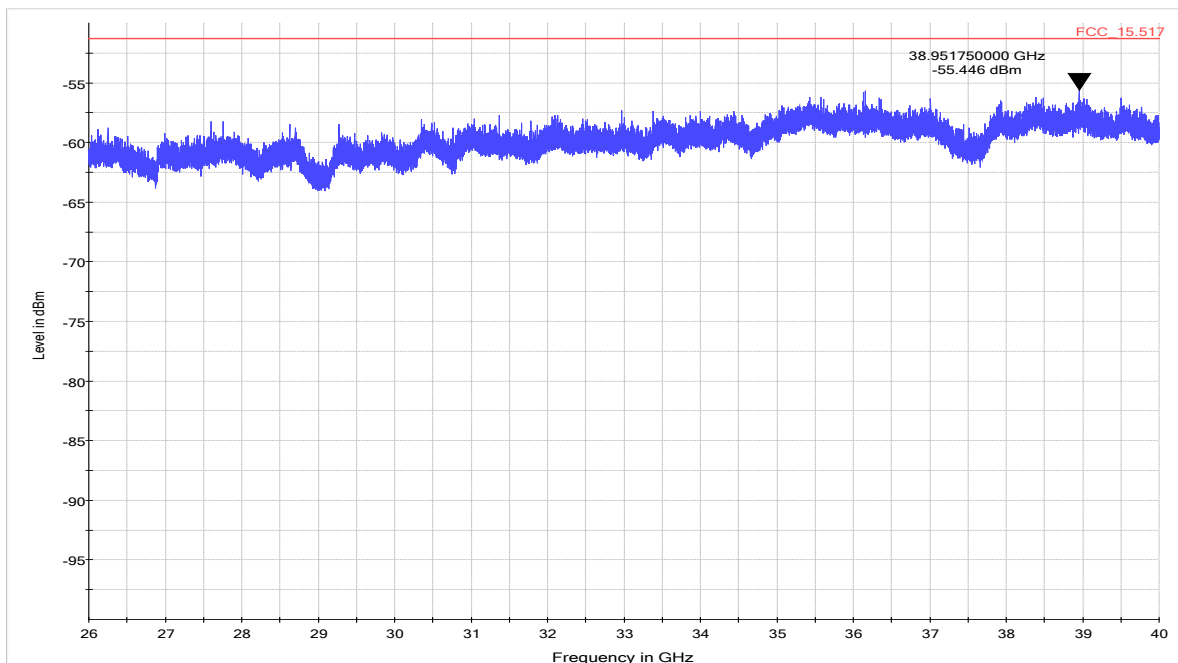

Measurement method = radiated, Operating band = 3100 – 10600 MHz,
Frequency range 26 GHz – 40 GHz, Channel = high
(S01_AA10)

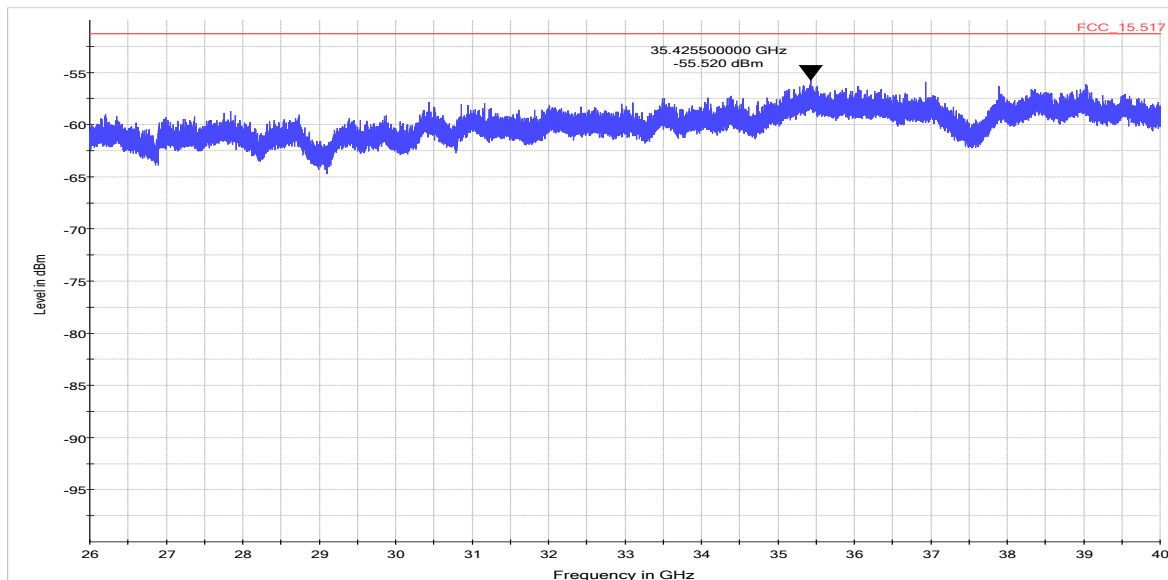

Setup: S01_AA13

Additional measurements for the disturbance @3024.2 MHz, to show that the disturbance will not be radiated via the antenna

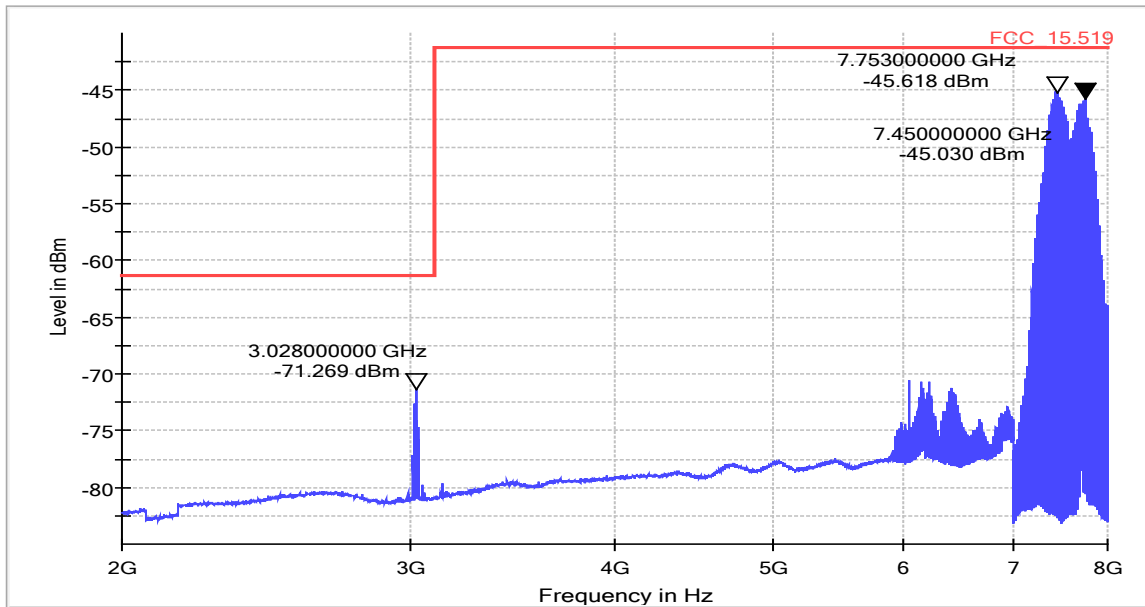

TX, 7560 MHz, conducted measurement at antenna connector

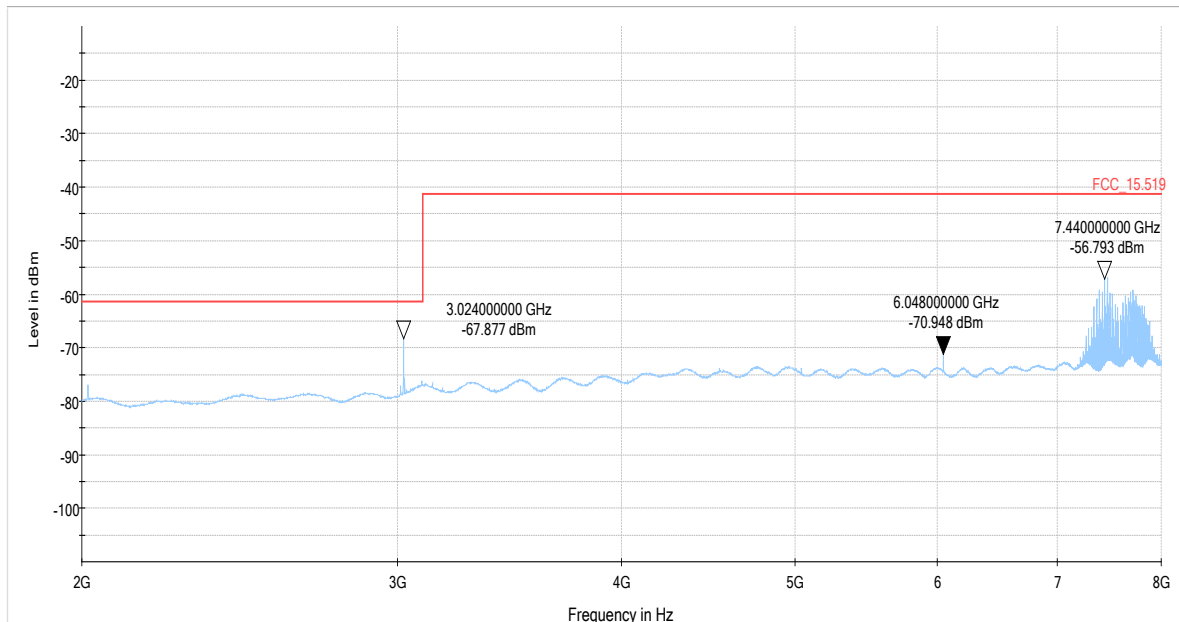

TX, 7560 MHz, radiated measurement with antenna connector terminated with 50 Ohm

4.5.5 TEST EQUIPMENT USED

- Radiated Emissions

4.6 RADIATED EMISSIONS IN GNSS BANDS

Standard **FCC Part 15 Subpart F**
FCC Part 15 Subpart C

The test was performed according to:
ANSI C63.10

4.6.1 TEST DESCRIPTION

The test set-up was made in accordance to the general provisions of ANSI C63.10 in a typical installation configuration. The Equipment Under Test (EUT) was set up on a non-conductive support (tilt device) at 1.5 m height in the fully-anechoic chamber.

All steps were performed with one height (1.5 m) of the receiving antenna only.

The measurement procedure is implemented into the EMI test software EMC32 from R&S.

Exploratory tests are performed at 3 orthogonal axes to determine the worst-case orientation of a body-worn or handheld EUT. The final test on all kind of EUTs is also performed at 3 axes.

A pre-check is performed while the EUT is powered from a DC power source.

After the measurement a plot will be generated which contains a diagram with the results of the preliminary scan and a chart with the frequencies and values of the results of the final measurement.

1. Measurement 1164 MHz – 1240 MHz, 1559 MHz – 1610 MHz

The following spectrum analyser setting are used for all steps:

- Measurement distance: 1 m
- Detector: RMS
- RBW: 1 kHz
- VBW: 3 kHz
- Measuring time: 1 ms / Sweep point
- Sweep Points: 1 / MHz [Span]

Step 1: Preliminary scan

Settings for step 1:

- Turntable angle range: -180° to 90°
- Turntable step size: 45°
- Elevation step size: 90°
- Polarisation: Horizontal + Vertical

Step 2: Adjustment measurement

In this step the accuracy of the turntable azimuth elevation will be improved. This is necessary to find out the maximum value of every frequency.

For each frequency, which was determined the turntable azimuth and elevation angle will be adjusted. The turntable azimuth will slowly vary by $\pm 22.5^{\circ}$ around this value. During this action, the value of emission is continuously measured. The turntable azimuth at the highest emission will be recorded and adjusted. In this position, the elevation angle will also slowly vary by $\pm 45^{\circ}$. During this action, the value of emission is also continuously measured. The elevation angle of the highest emission will also be recorded and adjusted.

- Turntable angle range: $\pm 22.5^{\circ}$ around the determined value
- Elevation angle range: $\pm 45^{\circ}$ around the determined value
- Antenna Polarisation: max. value determined in step 1

Step 3: Final measurement with RMS detector

With the settings determined in step 2, the final measurement will be performed.

The Test was performed radiated in a Fully Anechoic Chamber in the following setup:

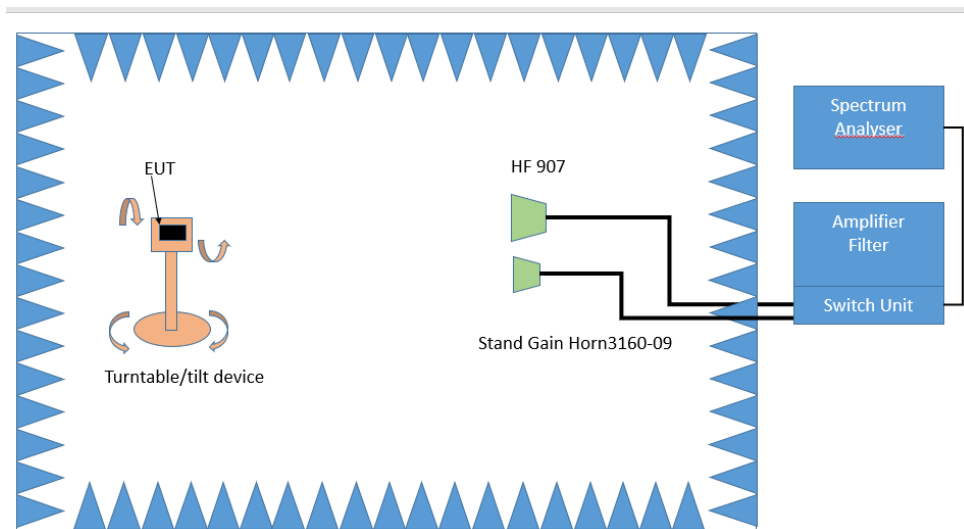

Test Setup; Spurious Emission Radiated (FAC), 1 GHz-26.5 GHz

4.6.2 TEST REQUIREMENTS / LIMITS

FCC Part 15, Subpart F, §15.519 (d)

In addition to the radiated emission limits specified in the table in paragraph (c) of this section, UWB transmitters operating under the provisions of this section shall not exceed the following average limits when measured using a resolution bandwidth of no less than 1 kHz:

Frequency in MHz	EIRP in dBm
1164 – 1240	-85.3
1559 - 1610	-85.3

RSS-220, 5.3.1 (e)

In addition to the limits specified in paragraph (d) of this section, radiated emissions shall not exceed the following average limits when measured using a resolution bandwidth greater than or equal to 1 kHz. The measurements shall demonstrate compliance with the stated limits at whatever resolution bandwidth is used.

Frequency in MHz	EIRP in dBm
1164 – 1240	-85.3
1559 - 1610	-85.3

4.6.3 TEST PROTOCOL

Ambient temperature: 25 °C
Air Pressure: 1023 hPa
Humidity: 28 %

Operating Band: 3100 - 10600 MHz						
Operating Frequency	Spurious Freq. [MHz]	Spurious Level [dBm]	Detector	RBW [kHz]	Limit [dBm]	Margin to Limit [dB]
low	- - -	- - -	- - -	1	-85.3	- - -
mid	- - -	- - -	- - -	1	-85.3	- - -
high	- - -	- - -	- - -	1	-85.3	- - -

4.6.4 MEASUREMENT PLOT (SHOWING THE HIGHEST VALUE, "WORST CASE")

Measurement method = radiated, Operating band = 3100 – 10600 MHz,
 Frequency range 1164 MHz -1240 MHz & 1559 MHz – 1610 MHz, Channel = low
 (S01_AA10)

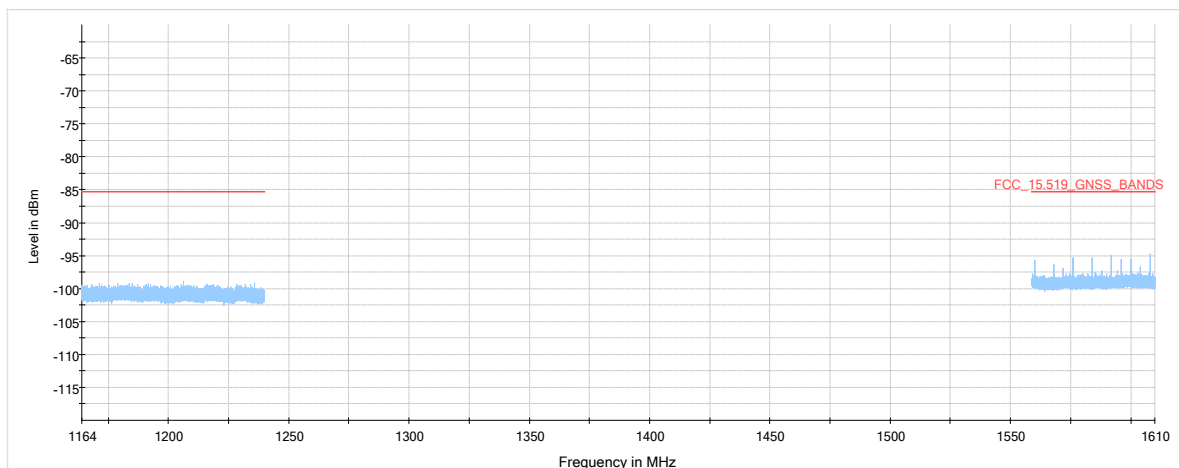

Measurement method = radiated, Operating band = 3100 – 10600 MHz,
Frequency range 1164 MHz -1240 MHz & 1559 MHz – 1610 MHz, Channel = mid
(S01_AA10)

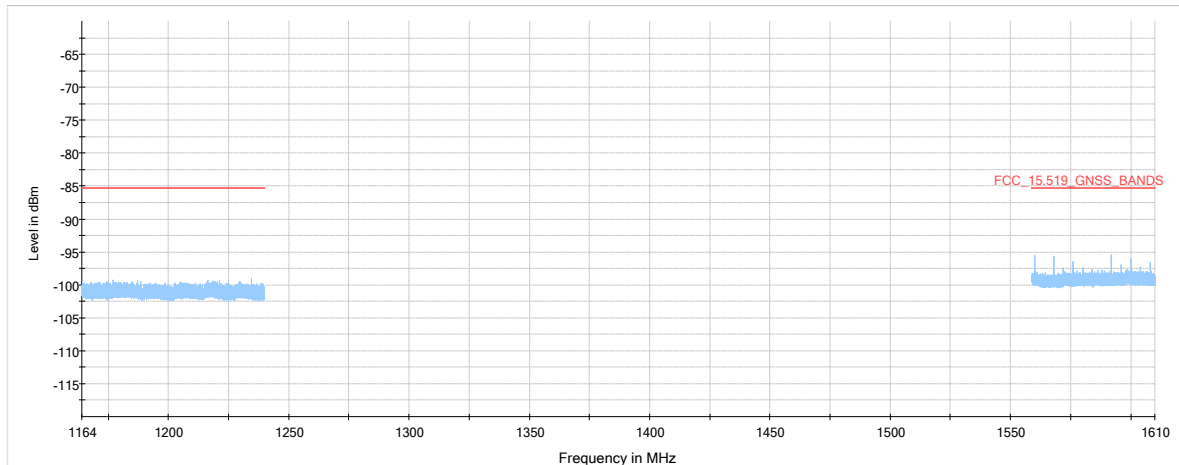

Measurement method = radiated, Operating band = 3100 – 10600 MHz,
Frequency range 1164 MHz -1240 MHz & 1559 MHz – 1610 MHz, Channel = high
(S01_AA10)

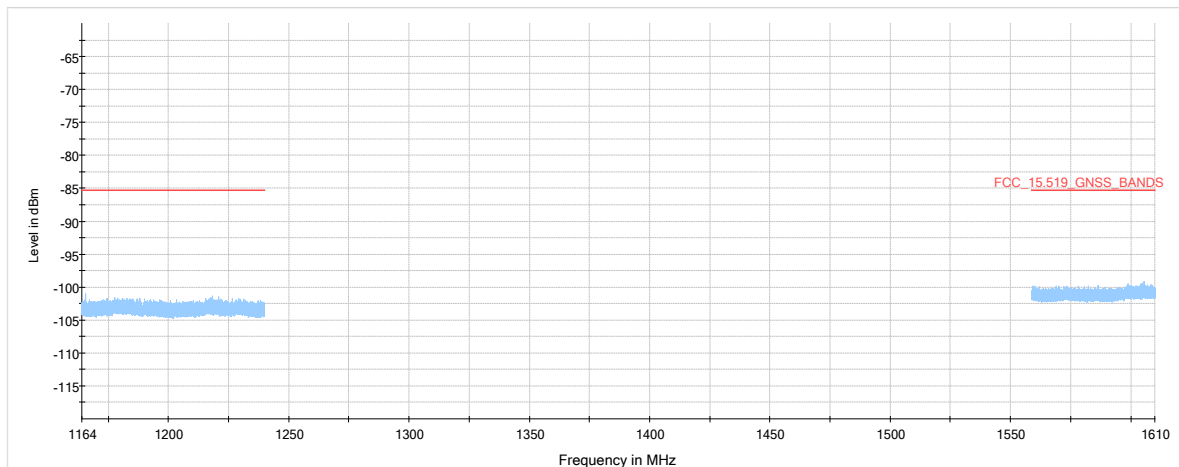

4.6.5 TEST EQUIPMENT USED

- Radiated Emissions

4.7 ASSOCIATED RECEIVER / TRANSMISSION TIMES

Standard **FCC Part 15 Subpart F**

The test was performed according to:
ANSI C63.10

4.7.1 TEST DESCRIPTION

Definition:

The Equipment Under Test (EUT) was set up to perform the transmission times measurements.

Test Procedure: Transmission time:

The Equipment Under Test (EUT) was set up on a non-conductive support in a shielded room. The measurement antenna was, via a short coax-cable, directly connected to a spectrum analyser. The distance between measurement antenna and the EUT was approximately 0.5 m. Because in this test only the timing behaviour of the EUT is checked, the test setup was not calibrated to absolute power levels. No associated receiver for the EUT was in range. For this reason, no acknowledgement signal could be transmitted to the EUT.

Test Procedure: Associated Receiver:

The Equipment Under Test (EUT) was set up on a non-conductive support in a shielded room. The measurement antennas (horn antenna for UWB (7040 MHz) and UHF (434 MHz) and a loop antenna for the LF signal (125 kHz) were, via a short coax-cable and a 3 dB coupler, directly connected to a spectrum analyser. Because in this test only the timing behaviour of the EUT is checked, the test setup was not calibrated to absolute power levels. The spectrum analyser was setup to observe all three RF transmissions simultaneously. The test was performed twice. The first test run was performed with an associated receiver in range, the second one is no associated receiver in range. For detail please see chapter "Test Protocol".

4.7.2 TEST REQUIREMENTS / LIMITS

FCC Part 15, Subpart F, §15.519 (a) (1)

A UWB device operating under the provisions of this section shall transmit only when it is sending information to an associated receiver. The UWB intentional radiator shall cease transmission within 10 seconds unless it receives an acknowledgement from the associated receiver that its transmission is being received. An acknowledgment of reception must continue to be received by the UWB intentional radiator at least every 10 seconds or the UWB device must cease transmitting.

RSS-220, 5.3.1 (b)

The device is to transmit only when it is sending information to an associated receiver. The device shall cease transmission of information within 10 seconds unless it receives an acknowledgement from the associated receiver that its transmission is being received. An acknowledgment of reception must continue to be received by the UWB device at least every 10 seconds or the UWB device shall cease transmitting any information other than periodic signals used for the establishment or re-establishment of a communication link with an associated receiver.

4.7.3 TEST PROTOCOL

Associated Receiver:

Ambient temperature: 26 °C
Air Pressure: 1000 hPa
Humidity: 31 %

Operating Band: 3100 - 10600 MHz				
Associated Receiver	LF (125 kHz) Transmission	UHF (434 MHz) Transmission	UWB (7040 MHz) Transmission	Result
Yes	Yes	Yes	Yes	Pass
No	Yes	No	No	Pass

Test setup:

To check the complete signalling sequence to open a car, the following hardware of the car is required:

- Door proximity sensor
- 013854 - LF KESSY IO box (incl. LF antennas)
- RSB19 -UWB ranging device
- BCM - Body Controller Module (contains a 434 UHF transceiver), connected via CAN-bus
- The CAR network is simulated by a VECTOR CAN simulation

Transmission time:

Ambient temperature: 24 °C
Air Pressure: 1019 hPa
Humidity: 31 %

Operating Band: 3100 - 10600 MHz						
Channel	Length of single impulse [µs]	No of impulse	Repetition rate [ms]	Total duration of transmission [ms]	Limit [ms]	Margin to Limit [MHz]
Mid	388.34	5	1.57	6.61	10000.00	9993.39

Note: The timing behaviour is identical for all three channels.
Please see next chapter for measurement plots.

Signalling sequence – Associated receiver in range

WUP of the key is known by the BCM:

1. Touching the door proximity sensor initiates a LF transmission by the LF KESSY IO box
2. The EUT (FS19) receives the LF-message and checks if the signal comes from its associated vehicle, to which the EUT is “learned” to.
3. In case of an associated car, the key (EUT) answers on UHF 434 MHz. This signal is received by the BCM of the car. Here takes an additional cryptographical data exchange place.
4. If the BCM sends the correct data back to key (EUT), via UHF 434 MHz, the key initiates an UWB transmission. The signal is received by the RSB19. The RSB19 answers on the same frequency. With this signal exchange the distance between the key (EUT) and the car can be calculated.
5. If the calculated distance is below a defined threshold, the vehicle will be opened.

Please see the **diagram ASS1** of the complete radio transmission in the next chapter.

Signalling sequence – No Associated receiver in range

WUP of the key is not known by the BCM:

1. Touching the door proximity sensor initiates a LF transmission by the LF KESSY IO box
2. The EUT (FS19) receives the LF-message and checks if the signal comes from its associated vehicle.
3. In case the LF request of a “wrong” vehicle will wakeup “accidentally” the UID, after the reception of the encrypted challenge from the BCM, the key will stop the function and will not send out any UWB or RF messages.
4. In case of a not-associated car, the stops any further RF transmission.
No communication on UHF and UWB takes place. The EUT is in sleep mode again.

Please see the **diagram ASS2** of the complete radio transmission in the next chapter.

Transmission Time setup

The transmission time checks the UWB behaviour of the key, in case the WUP of the key is known by the BCM, the LF and UHF data exchange was successful, the key starts its UWB transmission, but becomes no acknowledge from the RSB19 (e.g. caused by external interferences or defect RSB). In this case the key sends maximal four additional pulses (total five pulses). In case the RSB19 does not acknowledge at least one of this pulse, the key ceases transmission. The maximum length of the complete pulse train can be found in the result table. **Diagram TT1** shows the length of a single pulse, **Diagram TT2** shows the complete pulse train, **diagram TT3** shows, that the transmission really ends after one pulse train.

4.7.4 MEASUREMENT PLOT (SHOWING THE HIGHEST VALUE, "WORST CASE")

Associated Receiver:

Measurement method = radiated, Operating band = 3100 – 10600 MHz,
 Channel = mid, Associated receiver in range, (S01_SYS1) – **Diagram ASS1**

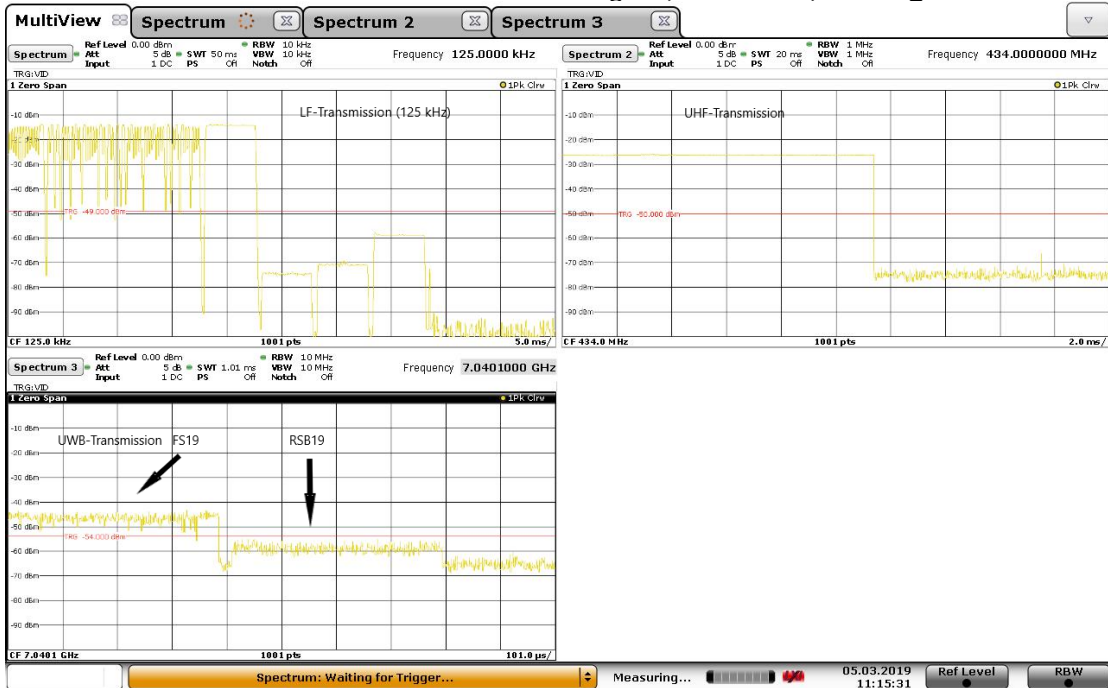

11:15:32 05.03.2019

Measurement method = radiated, Operating band = 3100 – 10600 MHz,
 Channel = mid, No Associated receiver in range, (S01_SYS2) – **Diagram ASS2**

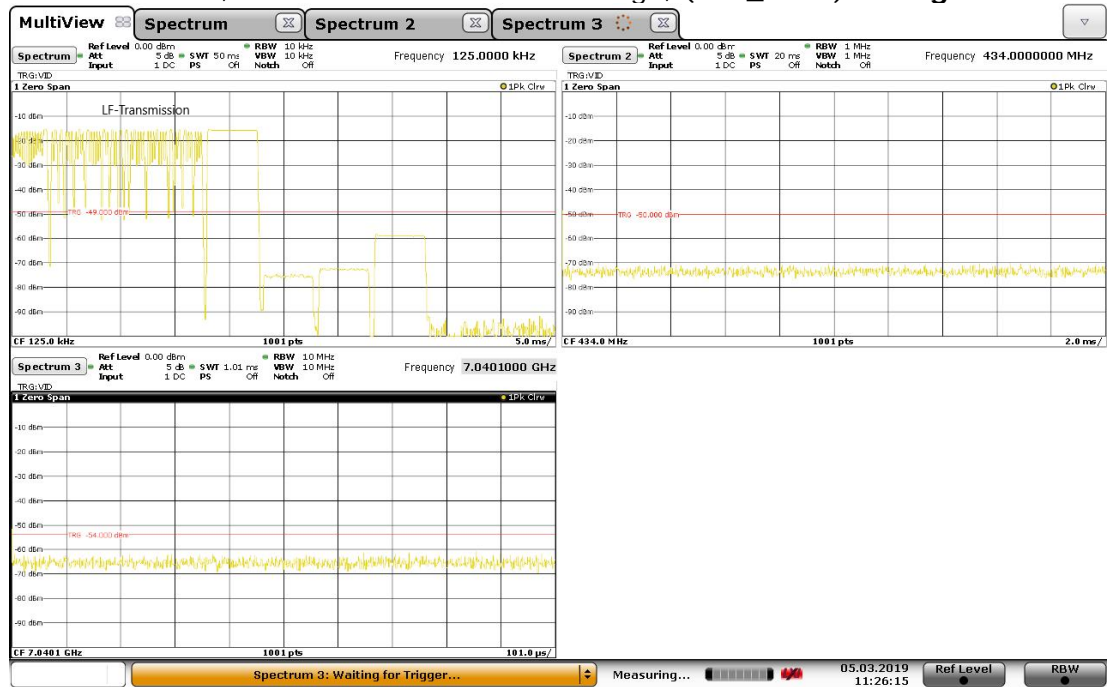

11:26:15 05.03.2019

Transmission time:

Measurement method = radiated, Operating band = 3100 – 10600 MHz,
Channel = mid
(S01_AA14)

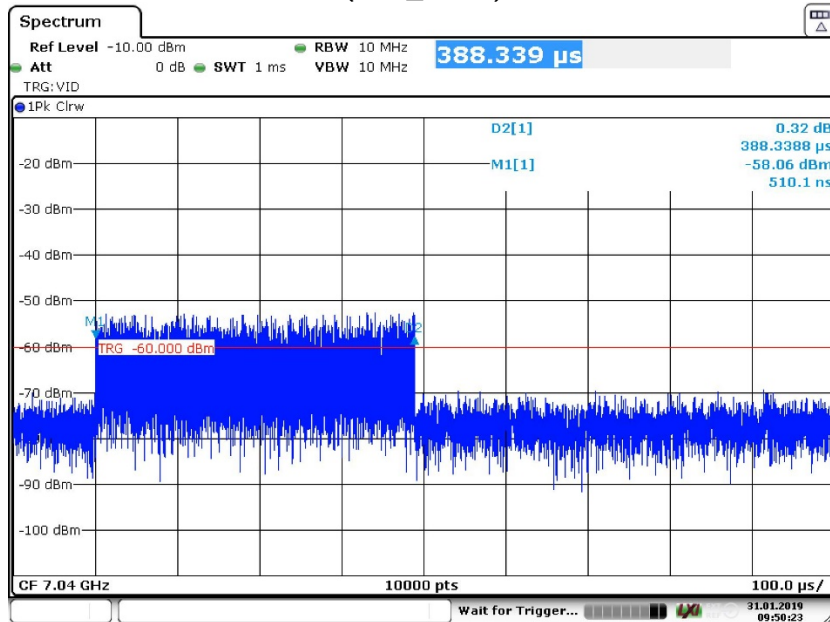

Date: 31. JAN 2019 09:50:23

Length of the single impulse – Diagram TT1

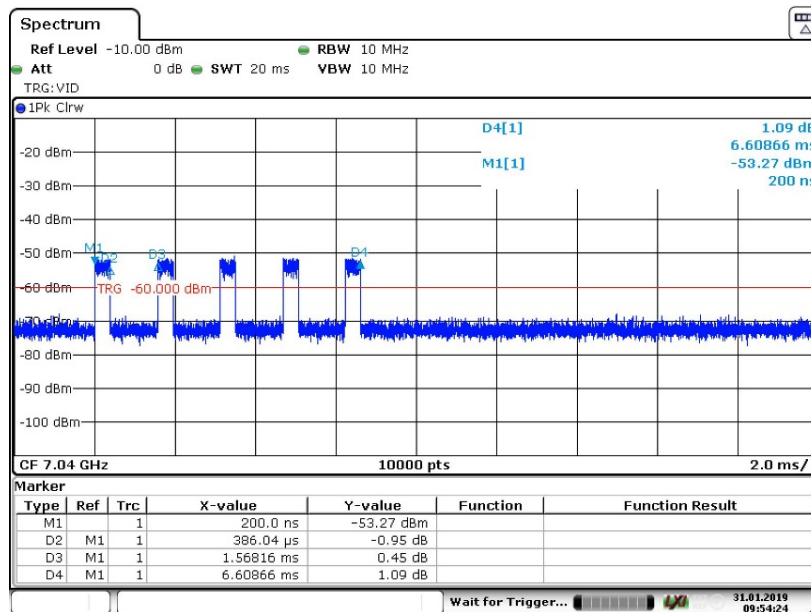

Date: 31. JAN.2019 09:54:23

Length of the complete impulse "train" – Diagram TT2

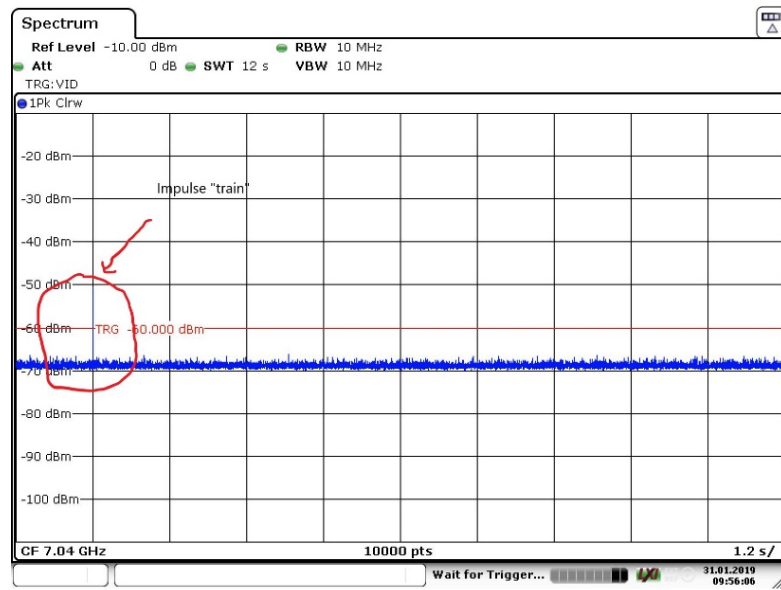

Date: 31.JAN.2019 09:56:06

Check for the 10 second limit – **Diagram TT3**

4.7.5 TEST EQUIPMENT USED

- ESW44

5 TEST EQUIPMENT

- 1 Conducted Emissions FCC
Conducted Emissions power line for FCC standards

Ref.No.	Device Name	Description	Manufacturer	Serial Number	Last Calibration	Calibration Due
1.1	Opus10 TPR (8253.00)	ThermoAirpressure Datalogger 13 (Environ)	Lufft Mess- und Regeltechnik GmbH	13936	2017-04	2019-04
1.2	Fluke 177	Digital Multimeter 03 (Multimeter)	Fluke Europe B.V.	86670383	2018-04	2020-04
1.3	ESH3-Z5	Two-Line V-Network	Rohde & Schwarz	828304/029	2017-05	2019-05
1.4	EP 1200/B, NA/B1	Amplifier with integrated variable Oscillator	Spitzenberger & Spieß	B6278		
1.5	Chroma 6404	AC Power Source	Chroma ATE INC.	64040001304		
1.6	Shielded Room 02	Shielded Room for conducted testing, 12qm	Frankonia	-		
1.7	ESH3-Z5	Two-Line V-Network	Rohde & Schwarz	829996/002	2017-05	2019-05
1.8	Opus10 THI (8152.00)	ThermoHygro Datalogger 02 (Environ)	Lufft Mess- und Regeltechnik GmbH	7489	2017-04	2019-04
1.9	ESIB 26	Spectrum Analyzer	Rohde & Schwarz	830482/004	2018-01	2020-01

- 2 Radiated Emissions
Lab to perform radiated emission tests

Ref.No.	Device Name	Description	Manufacturer	Serial Number	Last Calibration	Calibration Due
2.1	NRV-Z1	Sensor Head A	Rohde & Schwarz GmbH & Co. KG	827753/005	2018-07	2019-07
2.2	MFS	Rubidium Frequency Normal MFS	Datum GmbH	002	2018-10	2020-10
2.3	Opus10 TPR (8253.00)	ThermoAirpressure Datalogger 13 (Environ)	Lufft Mess- und Regeltechnik GmbH	13936	2017-04	2019-04
2.4	ESW44	EMI Test Receiver	Rohde & Schwarz GmbH & Co. KG	101603	2018-05	2019-05
2.5	Anechoic Chamber	10.58 x 6.38 x 6.00 m ³	Frankonia	none	2018-06	2020-06
2.6	FS-Z60	Harmonic Mixer 40 - 60 GHz	Rohde & Schwarz Messgerätebau GmbH	100178	2016-12	2019-12
2.7	FS-Z220	Harmonic Mixer 140 - 220 GHz	Rohde & Schwarz Messgerätebau GmbH	101005	2017-03	2020-03

Ref.No.	Device Name	Description	Manufacturer	Serial Number	Last Calibration	Calibration Due
2.8	SGH-05	Standard Gain / Pyramidal Horn Antenna (140 - 220 GHz)	RPG-Radiometer Physics GmbH	075		
2.9	HL 562	Ultralog new biconicals	Rohde & Schwarz	830547/003	2018-07	2021-07
2.10	5HC2700/12750-1.5-KK	High Pass Filter	Trilithic	9942012		
2.11	ASP 1.2/1.8-10 kg	Antenna Mast	Maturo GmbH	-		
2.12	Fully Anechoic Room	8.80m x 4.60m x 4.05m (l x w x h)	Albatross Projects	P26971-647-001-PRB	2018-06	2020-06
2.13	Fluke 177	Digital Multimeter 03 (Multimeter)	Fluke Europe B.V.	86670383	2018-04	2020-04
2.14	NRVD	Power Meter	Rohde & Schwarz GmbH & Co. KG	828110/016	2018-07	2019-07
2.15	HF 906	Double-ridged horn	Rohde & Schwarz	357357/002	2018-09	2021-09
2.16	JS4-18002600-32-5P	Broadband Amplifier 18 GHz - 26 GHz	Miteq	849785		
2.17	FSW 43	Spectrum Analyzer	Rohde & Schwarz	103779	2016-12	2018-12
2.18	3160-09	Standard Gain / Pyramidal Horn Antenna 26.5 GHz	EMCO Elektronik GmbH	00083069		
2.19	SGH-19	Standard Gain / Pyramidal Horn Antenna (40 - 60 GHz)	RPG-Radiometer Physics GmbH	093		
2.20	WHKX 7.0/18G-8SS	High Pass Filter	Wainwright	09		
2.21	4HC1600/12750-1.5-KK	High Pass Filter	Trilithic	9942011		
2.22	Chroma 6404	AC Power Source	Chroma ATE INC.	64040001304		
2.23	JS4-00102600-42-5A	Broadband Amplifier 30 MHz - 26 GHz	Miteq	619368		
2.24	TT 1.5 WI	Turn Table	Maturo GmbH	-		
2.25	HL 562 Ultralog	Log.-per. Antenna	Rohde & Schwarz	100609	2016-04	2019-04
2.26	HF 906	Double-ridged horn	Rohde & Schwarz	357357/001	2018-03	2021-03
2.27	FS-Z325	Harmonic Mixer 220 - 325 GHz	Rohde & Schwarz Messgerätebau GmbH	101006	2017-03	2020-03
2.28	3160-10	Standard Gain / Pyramidal Horn Antenna 40 GHz	EMCO Elektronik GmbH	00086675		

Ref.No.	Device Name	Description	Manufacturer	Serial Number	Last Calibration	Calibration Due
2.29	SGH-08	Standard Gain / Pyramidal Horn Antenna (90 - 140 GHz)	RPG-Radiometer Physics GmbH	064		
2.30	SGH-12	Standard Gain / Pyramidal HornAntenna (60 - 90 GHz)	RPG-Radiometer Physics GmbH	326		
2.31	5HC3500/18000-1.2-KK	High Pass Filter	Trilithic	200035008		
2.32	FS-Z140	Harmonic Mixer 90 -140 GHz	Rohde & Schwarz Messgerätebau GmbH	101007	2017-02	2020-02
2.33	HFH2-Z2	Loop Antenna	Rohde & Schwarz	829324/006	2018-01	2021-01
2.34	Opus10 THI (8152.00)	ThermoHygro Datalogger 12 (Environ)	Lufft Mess- und Regeltechnik GmbH	12482	2017-03	2019-03
2.35	JS4-00101800-35-5P	Broadband Amplifier 30 MHz - 18 GHz	Miteq	896037		
2.36	AS 620 P	Antenna mast	HD GmbH	620/37		
2.37	Tilt device Maturo (Rohacell)	Antrieb TD1.5-10kg	Maturo GmbH	TD1.5-10kg/024/3790709		
2.38	SGH-03	Standard Gain / Pyramidal Horn Antenna (220 - 325 GHz)	RPG-Radiometer Physics GmbH	060		
2.39	FS-Z90	Harmonic Mixer 60 - 90 GHz	Rohde & Schwarz Messgerätebau GmbH	101686	2017-03	2020-03
2.40	ESIB 26	Spectrum Analyzer	Rohde & Schwarz	830482/004	2018-01	2020-01
2.41	PAS 2.5 - 10 kg	Antenna Mast	Maturo GmbH	-		
2.42	AFS42-00101800-25-S-42	Broadband Amplifier 25 MHz - 18 GHz	Miteq	2035324		
2.43	AM 4.0	Antenna mast	Maturo GmbH	AM4.0/180/11920513		
2.44	HF 907	Double-ridged horn	Rohde & Schwarz	102444	2018-07	2021-07

The calibration interval is the time interval between “Last Calibration” and “Calibration Due”

6 ANTENNA FACTORS, CABLE LOSS AND SAMPLE CALCULATIONS

This chapter contains the antenna factors with their corresponding path loss of the used measurement path for all antennas as well as the insertion loss of the LISN.

6.1 LISN R&S ESH3-Z5 (150 KHZ – 30 MHZ)

Frequency MHz	Corr. dB	LISN insertion loss ESH3- Z5 dB	cable loss (incl. 10 dB atten- uator) dB
0.15	10.1	0.1	10.0
5	10.3	0.1	10.2
7	10.5	0.2	10.3
10	10.5	0.2	10.3
12	10.7	0.3	10.4
14	10.7	0.3	10.4
16	10.8	0.4	10.4
18	10.9	0.4	10.5
20	10.9	0.4	10.5
22	11.1	0.5	10.6
24	11.1	0.5	10.6
26	11.2	0.5	10.7
28	11.2	0.5	10.7
30	11.3	0.5	10.8

Sample calculation

$$U_{\text{LISN}} \text{ (dB } \mu\text{V)} = U \text{ (dB } \mu\text{V)} + \text{Corr. (dB)}$$

U = Receiver reading

LISN Insertion loss = Voltage Division Factor of LISN

Corr. = sum of single correction factors of used LISN, cables, switch units (if used)

Linear interpolation will be used for frequencies in between the values in the table.

6.2 ANTENNA R&S HFH2-Z2 (9 KHZ – 30 MHZ)

Frequency MHz	AF HFH-Z2) dB (1/m)	Corr. dB	cable loss 1 (inside chamber) dB	cable loss 2 (outside chamber) dB	cable loss 3 (switch unit) dB	cable loss 4 (to receiver) dB	distance corr. (-40 dB/ decade) dB	d _{Limit} (meas. distance (limit) m	d _{used} (meas. distance (used) m
0.009	20.50	-79.6	0.1	0.1	0.1	0.1	-80	300	3
0.01	20.45	-79.6	0.1	0.1	0.1	0.1	-80	300	3
0.015	20.37	-79.6	0.1	0.1	0.1	0.1	-80	300	3
0.02	20.36	-79.6	0.1	0.1	0.1	0.1	-80	300	3
0.025	20.38	-79.6	0.1	0.1	0.1	0.1	-80	300	3
0.03	20.32	-79.6	0.1	0.1	0.1	0.1	-80	300	3
0.05	20.35	-79.6	0.1	0.1	0.1	0.1	-80	300	3
0.08	20.30	-79.6	0.1	0.1	0.1	0.1	-80	300	3
0.1	20.20	-79.6	0.1	0.1	0.1	0.1	-80	300	3
0.2	20.17	-79.6	0.1	0.1	0.1	0.1	-80	300	3
0.3	20.14	-79.6	0.1	0.1	0.1	0.1	-80	300	3
0.49	20.12	-79.6	0.1	0.1	0.1	0.1	-80	300	3
0.490001	20.12	-39.6	0.1	0.1	0.1	0.1	-40	30	3
0.5	20.11	-39.6	0.1	0.1	0.1	0.1	-40	30	3
0.8	20.10	-39.6	0.1	0.1	0.1	0.1	-40	30	3
1	20.09	-39.6	0.1	0.1	0.1	0.1	-40	30	3
2	20.08	-39.6	0.1	0.1	0.1	0.1	-40	30	3
3	20.06	-39.6	0.1	0.1	0.1	0.1	-40	30	3
4	20.05	-39.5	0.2	0.1	0.1	0.1	-40	30	3
5	20.05	-39.5	0.2	0.1	0.1	0.1	-40	30	3
6	20.02	-39.5	0.2	0.1	0.1	0.1	-40	30	3
8	19.95	-39.5	0.2	0.1	0.1	0.1	-40	30	3
10	19.83	-39.4	0.2	0.1	0.2	0.1	-40	30	3
12	19.71	-39.4	0.2	0.1	0.2	0.1	-40	30	3
14	19.54	-39.4	0.2	0.1	0.2	0.1	-40	30	3
16	19.53	-39.3	0.3	0.1	0.2	0.1	-40	30	3
18	19.50	-39.3	0.3	0.1	0.2	0.1	-40	30	3
20	19.57	-39.3	0.3	0.1	0.2	0.1	-40	30	3
22	19.61	-39.3	0.3	0.1	0.2	0.1	-40	30	3
24	19.61	-39.3	0.3	0.1	0.2	0.1	-40	30	3
26	19.54	-39.3	0.3	0.1	0.2	0.1	-40	30	3
28	19.46	-39.2	0.3	0.1	0.3	0.1	-40	30	3
30	19.73	-39.1	0.4	0.1	0.3	0.1	-40	30	3

Sample calculation

$$E \text{ (dB } \mu\text{V/m)} = U \text{ (dB } \mu\text{V)} + AF \text{ (dB 1/m)} + Corr. \text{ (dB)}$$

U = Receiver reading

AF = Antenna factor

Corr. = sum of single correction factors of used cables, switch unit, distance correction, amplifier (if applicable)

distance correction = $-40 * \text{LOG} (d_{\text{Limit}} / d_{\text{used}})$

Linear interpolation will be used for frequencies in between the values in the table.

Table shows an extract of values

6.3 ANTENNA R&S HL562 (30 MHz – 1 GHz)

($d_{Limit} = 3\text{ m}$)

Frequency	AF R&S HL562	Corr.
MHz	dB (1/m)	dB
30	18.6	0.6
50	6.0	0.9
100	9.7	1.2
150	7.9	1.6
200	7.6	1.9
250	9.5	2.1
300	11.0	2.3
350	12.4	2.6
400	13.6	2.9
450	14.7	3.1
500	15.6	3.2
550	16.3	3.5
600	17.2	3.5
650	18.1	3.6
700	18.5	3.6
750	19.1	4.1
800	19.6	4.1
850	20.1	4.4
900	20.8	4.7
950	21.1	4.8
1000	21.6	4.9

cable loss 1 (inside chamber)	cable loss 2 (outside chamber)	cable loss 3 (switch unit)	cable loss 4 (to receiver)	distance corr. (-20 dB/decade)	d_{Limit} (meas. distance (limit))	d_{used} (meas. distance (used))
dB	dB	dB	dB	dB	m	m
0.29	0.04	0.23	0.02	0.0	3	3
0.39	0.09	0.32	0.08	0.0	3	3
0.56	0.14	0.47	0.08	0.0	3	3
0.73	0.20	0.59	0.12	0.0	3	3
0.84	0.21	0.70	0.11	0.0	3	3
0.98	0.24	0.80	0.13	0.0	3	3
1.04	0.26	0.89	0.15	0.0	3	3
1.18	0.31	0.96	0.13	0.0	3	3
1.28	0.35	1.03	0.19	0.0	3	3
1.39	0.38	1.11	0.22	0.0	3	3
1.44	0.39	1.20	0.19	0.0	3	3
1.55	0.46	1.24	0.23	0.0	3	3
1.59	0.43	1.29	0.23	0.0	3	3
1.67	0.34	1.35	0.22	0.0	3	3
1.67	0.42	1.41	0.15	0.0	3	3
1.87	0.54	1.46	0.25	0.0	3	3
1.90	0.46	1.51	0.25	0.0	3	3
1.99	0.60	1.56	0.27	0.0	3	3
2.14	0.60	1.63	0.29	0.0	3	3
2.22	0.60	1.66	0.33	0.0	3	3
2.23	0.61	1.71	0.30	0.0	3	3

($d_{Limit} = 10\text{ m}$)

30	18.6	-9.9
50	6.0	-9.6
100	9.7	-9.2
150	7.9	-8.8
200	7.6	-8.6
250	9.5	-8.3
300	11.0	-8.1
350	12.4	-7.9
400	13.6	-7.6
450	14.7	-7.4
500	15.6	-7.2
550	16.3	-7.0
600	17.2	-6.9
650	18.1	-6.9
700	18.5	-6.8
750	19.1	-6.3
800	19.6	-6.3
850	20.1	-6.0
900	20.8	-5.8
950	21.1	-5.6
1000	21.6	-5.6

0.29	0.04	0.23	0.02	-10.5	10	3
0.39	0.09	0.32	0.08	-10.5	10	3
0.56	0.14	0.47	0.08	-10.5	10	3
0.73	0.20	0.59	0.12	-10.5	10	3
0.84	0.21	0.70	0.11	-10.5	10	3
0.98	0.24	0.80	0.13	-10.5	10	3
1.04	0.26	0.89	0.15	-10.5	10	3
1.18	0.31	0.96	0.13	-10.5	10	3
1.28	0.35	1.03	0.19	-10.5	10	3
1.39	0.38	1.11	0.22	-10.5	10	3
1.44	0.39	1.20	0.19	-10.5	10	3
1.55	0.46	1.24	0.23	-10.5	10	3
1.59	0.43	1.29	0.23	-10.5	10	3
1.67	0.34	1.35	0.22	-10.5	10	3
1.67	0.42	1.41	0.15	-10.5	10	3
1.87	0.54	1.46	0.25	-10.5	10	3
1.90	0.46	1.51	0.25	-10.5	10	3
1.99	0.60	1.56	0.27	-10.5	10	3
2.14	0.60	1.63	0.29	-10.5	10	3
2.22	0.60	1.66	0.33	-10.5	10	3
2.23	0.61	1.71	0.30	-10.5	10	3

Sample calculation

$E\text{ (dB } \mu\text{V/m)} = U\text{ (dB } \mu\text{V)} + \text{AF (dB 1/m)} + \text{Corr. (dB)}$
 U = Receiver reading
 AF = Antenna factor
 Corr. = sum of single correction factors of used cables, switch unit, distance correction, amplifier (if applicable)
 distance correction = $-20 * \text{LOG}(d_{Limit}/d_{used})$
 Linear interpolation will be used for frequencies in between the values in the table.
 Tables show an extract of values.

6.4 ANTENNA R&S HF907 (1 GHZ – 18 GHZ)

Frequency	AF R&S HF907	Corr.
MHz	dB (1/m)	dB
1000	24.4	-19.4
2000	28.5	-17.4
3000	31.0	-16.1
4000	33.1	-14.7
5000	34.4	-13.7
6000	34.7	-12.7
7000	35.6	-11.0

cable loss 1 (relay + cable inside chamber)	cable loss 2 (outside chamber)	cable loss 3 (switch unit, attenuator & pre-amp)	cable loss 4 (to receiver)
dB	dB	dB	dB
0.99	0.31	-21.51	0.79
1.44	0.44	-20.63	1.38
1.87	0.53	-19.85	1.33
2.41	0.67	-19.13	1.31
2.78	0.86	-18.71	1.40
2.74	0.90	-17.83	1.47
2.82	0.86	-16.19	1.46

Frequency	AF R&S HF907	Corr.
MHz	dB (1/m)	dB
3000	31.0	-23.4
4000	33.1	-23.3
5000	34.4	-21.7
6000	34.7	-21.2
7000	35.6	-19.8

cable loss 1 (relay inside chamber)	cable loss 2 (inside chamber)	cable loss 3 (outside chamber)	cable loss 4 (switch unit, attenuator & pre-amp)	cable loss 5 (to receiver)	used for FCC 15.247
dB	dB	dB	dB	dB	
0.47	1.87	0.53	-27.58	1.33	
0.56	2.41	0.67	-28.23	1.31	
0.61	2.78	0.86	-27.35	1.40	
0.58	2.74	0.90	-26.89	1.47	
0.66	2.82	0.86	-25.58	1.46	

Frequency	AF R&S HF907	Corr.
MHz	dB (1/m)	dB
7000	35.6	-57.3
8000	36.3	-56.3
9000	37.1	-55.3
10000	37.5	-56.2
11000	37.5	-55.3
12000	37.6	-53.7
13000	38.2	-53.5
14000	39.9	-56.3
15000	40.9	-54.1
16000	41.3	-54.1
17000	42.8	-54.4
18000	44.2	-54.7

cable loss 1 (relay inside chamber)	cable loss 2 (High Pass)	cable loss 3 (pre-amp)	cable loss 4 (inside chamber)	cable loss 5 (outside chamber)	cable loss 6 (to receiver)
dB	dB	dB	dB	dB	dB
0.56	1.28	-62.72	2.66	0.94	1.46
0.69	0.71	-61.49	2.84	1.00	1.53
0.68	0.65	-60.80	3.06	1.09	1.60
0.70	0.54	-61.91	3.28	1.20	1.67
0.80	0.61	-61.40	3.43	1.27	1.70
0.84	0.42	-59.70	3.53	1.26	1.73
0.83	0.44	-59.81	3.75	1.32	1.83
0.91	0.53	-63.03	3.91	1.40	1.77
0.98	0.54	-61.05	4.02	1.44	1.83
1.23	0.49	-61.51	4.17	1.51	1.85
1.36	0.76	-62.36	4.34	1.53	2.00
1.70	0.53	-62.88	4.41	1.55	1.91

Sample calculation

$$E \text{ (dB } \mu\text{V/m)} = U \text{ (dB } \mu\text{V)} + \text{AF (dB 1/m)} + \text{Corr. (dB)}$$

U = Receiver reading

AF = Antenna factor

Corr. = sum of single correction factors of used cables, switch unit, distance correction, amplifier (if applicable)

Linear interpolation will be used for frequencies in between the values in the table.

Tables show an extract of values.

6.5 ANTENNA EMCO 3160-09 (18 GHZ – 26.5 GHZ)

Frequency	AF EMCO 3160-09	Corr.
MHz	dB (1/m)	dB
18000	40.2	-23.5
18500	40.2	-23.2
19000	40.2	-22.0
19500	40.3	-21.3
20000	40.3	-20.3
20500	40.3	-19.9
21000	40.3	-19.1
21500	40.3	-19.1
22000	40.3	-18.7
22500	40.4	-19.0
23000	40.4	-19.5
23500	40.4	-19.3
24000	40.4	-19.8
24500	40.4	-19.5
25000	40.4	-19.3
25500	40.5	-20.4
26000	40.5	-21.3
26500	40.5	-21.1

cable loss 1 (inside chamber)	cable loss 2 (pre- amp)	cable loss 3 (inside chamber)	cable loss 4 (switch unit)	cable loss 5 (to receiver)
dB	dB	dB	dB	dB
0.72	-35.85	6.20	2.81	2.65
0.69	-35.71	6.46	2.76	2.59
0.76	-35.44	6.69	3.15	2.79
0.74	-35.07	7.04	3.11	2.91
0.72	-34.49	7.30	3.07	3.05
0.78	-34.46	7.48	3.12	3.15
0.87	-34.07	7.61	3.20	3.33
0.90	-33.96	7.47	3.28	3.19
0.89	-33.57	7.34	3.35	3.28
0.87	-33.66	7.06	3.75	2.94
0.88	-33.75	6.92	3.77	2.70
0.90	-33.35	6.99	3.52	2.66
0.88	-33.99	6.88	3.88	2.58
0.91	-33.89	7.01	3.93	2.51
0.88	-33.00	6.72	3.96	2.14
0.89	-34.07	6.90	3.66	2.22
0.86	-35.11	7.02	3.69	2.28
0.90	-35.20	7.15	3.91	2.36

Sample calculation

$$E \text{ (dB } \mu\text{V/m)} = U \text{ (dB } \mu\text{V)} + AF \text{ (dB 1/m)} + Corr. \text{ (dB)}$$

U = Receiver reading

AF = Antenna factor

Corr. = sum of single correction factors of used cables, switch unit, distance correction, amplifier (if applicable)

Linear interpolation will be used for frequencies in between the values in the table.

Table shows an extract of values.

6.6 ANTENNA EMCO 3160-10 (26.5 GHZ – 40 GHZ)

Frequency	AF EMCO 3160-10	Corr.	cable loss 1 (inside chamber)	cable loss 2 (outside chamber)	cable loss 3 (switch unit)	cable loss 4 (to receiver)	distance corr. (-20 dB/ decade)	d _{Limit} (meas. distance (limit))	d _{used} (meas. distance (used))
GHz	dB (1/m)	dB	dB	dB	dB	dB	dB	m	m
26.5	43.4	-11.2	4.4				-15.6	3	0.5
27.0	43.4	-11.2	4.4				-15.6	3	0.5
28.0	43.4	-11.1	4.5				-15.6	3	0.5
29.0	43.5	-11.0	4.6				-15.6	3	0.5
30.0	43.5	-10.9	4.7				-15.6	3	0.5
31.0	43.5	-10.8	4.7				-15.6	3	0.5
32.0	43.5	-10.7	4.8				-15.6	3	0.5
33.0	43.6	-10.7	4.9				-15.6	3	0.5
34.0	43.6	-10.6	5.0				-15.6	3	0.5
35.0	43.6	-10.5	5.1				-15.6	3	0.5
36.0	43.6	-10.4	5.1				-15.6	3	0.5
37.0	43.7	-10.3	5.2				-15.6	3	0.5
38.0	43.7	-10.2	5.3				-15.6	3	0.5
39.0	43.7	-10.2	5.4				-15.6	3	0.5
40.0	43.8	-10.1	5.5				-15.6	3	0.5

Sample calculation

$$E \text{ (dB } \mu\text{V/m)} = U \text{ (dB } \mu\text{V)} + AF \text{ (dB 1/m)} + Corr. \text{ (dB)}$$

U = Receiver reading

AF = Antenna factor

Corr. = sum of single correction factors of used cables, switch unit, distance correction, amplifier (if applicable)

Linear interpolation will be used for frequencies in between the values in the table.

distance correction = $-20 * \text{LOG} (d_{\text{Limit}} / d_{\text{used}})$

Linear interpolation will be used for frequencies in between the values in the table.

Table shows an extract of values.

7 SETUP DRAWINGS

Setup Drawings

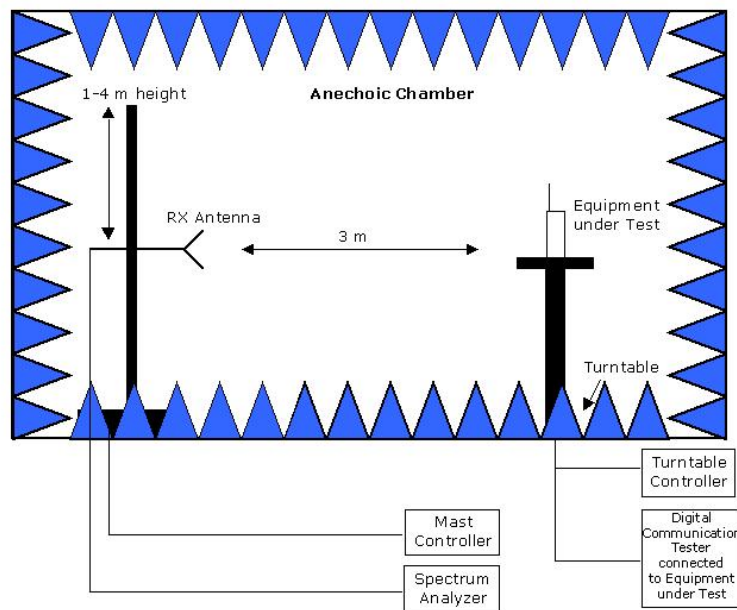

Remark: Depending on the frequency range suitable antenna types, attenuators or preamplifiers are used.

Setup in the Anechoic chamber. For measurements below 1 GHz the ground was replaced by a conducting ground plane.

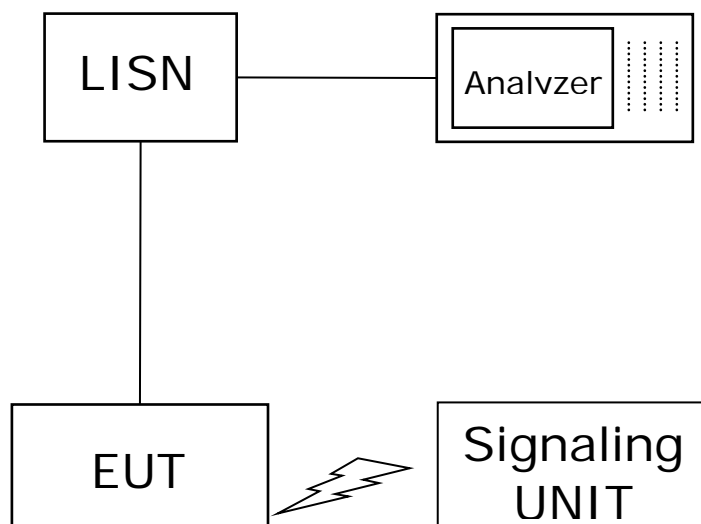

Setup in the shielded room for conducted measurements at AC mains port

8 MEASUREMENT UNCERTAINTIES

Test Case	Parameter	Uncertainty
Conducted Emissions at AC mains	Voltage	± 3.4 dB
Radiated Emissions	Field Strength	± 5.5 dB

9 PHOTO REPORT

Please see separate photo report.