

Test Report

Test report no.: 20114849-19759-0

Date of issue: 2021-07-11

Test result: The test item - **passed** - and complies with below listed standards.

Applicant

Hella GmbH & Co. KGaA

Manufacturer

Hella GmbH & Co. KGaA

Test Item

RS5.5

RF-Spectrum Testing according to:

FCC 47 CFR Part 95
Personal radio services,
Subpart M - The 76-81 GHz Band Radar Service

Tested by
(name, function, signature)

Karsten Gerdly
Head of Laboratory RF

signature

Approved by
(name, function, signature)

Dr.-Ing. Harald Ansorge
Managing Director

signature

Applicant and Test item details	
Applicant	Hella GmbH & Co. KGaA Rixbecker Str. 75 59552, Lippstadt, Germany Phone: +49 (0) 2941 38-0
Manufacturer	Hella GmbH & Co. KGaA Römerstrasse 66 59075, Hamm, Germany
Test item description	Advanced driver assistance system (ADAS)
Model/Type reference	RS5.5
FCC ID	NBG01RS55
Frequency	76.0 GHz to 77.0 GHz
Antenna	integrated microstrip patch array antenna
Power supply	9.0 to 18.0 V DC
Temperature range	-40 °C to +85 °C

Disclaimer and Notes

The content of this rest report relates to the mentioned test sample(s) only.
Without a written permit of IBL-Lab GmbH, this test report shall not be reproduced, except in full.

The last valid version is available at TAMSys®.
Copyright ©: All rights reserved by IBL-Lab GmbH

Within this test report, a point / comma is used as a decimal separator.
If otherwise, a detailed note is added adjected to its use.

IBL-Lab GmbH does not take samples. The samples used for testing are provided by the applicant.

Decision rule: Binary Statement for Simple Acceptance Rule according ILAC-G8:09/2019

1 TABLE OF CONTENTS

1	TABLE OF CONTENTS	3
2	GENERAL INFORMATION	5
2.1	Administrative details	5
2.2	Possible test case verdicts	5
2.3	Observations	6
2.4	Opinions and interpretations	6
2.5	Revision History	6
2.6	Further documents	6
3	ENVIRONMENTAL & TEST CONDITIONS	7
3.1	Environmental conditions	7
3.2	Normal and extreme test conditions	7
4	TEST STANDARDS AND REFERENCES	7
5	EQUIPMENT UNDER TEST (EUT)	8
5.1	Product description	8
5.2	Description of test item	8
5.3	Technical data of test item	8
5.4	Additional information	8
5.5	Operating conditions	9
5.6	Antenna characteristics	10
6	SUMMARY OF TEST RESULTS	12
7	TEST RESULTS	13
7.1	RF power output (§2.1046 & §95.3367)	13
7.2	Modulation characteristics (§2.1047 & KDB 653005 D01 76-81 GHz Radars v01r01)	16
7.3	Occupied bandwidth (§2.1049)	18
7.4	Field strength of spurious radiation (§2.1053 & §95.3379)	26
7.5	Frequency stability (§2.1055 & §95.3379(b))	36
8	Test Setup Description	37
8.1	Semi Anechoic Chamber with Ground Plane	38
8.2	Fully Anechoic Chamber	40
8.3	Radiated measurements > 18 GHz	41
8.4	Radiated measurements > 50 GHz	41
8.5	Frequency error	43
9	Measurement procedures	44
9.1	Radiated spurious emissions from 9 kHz to 30 MHz	44
9.2	Radiated spurious emissions from 30 MHz to 1 GHz	45
9.3	Radiated spurious emissions from 1 GHz to 18 GHz	46
9.4	Radiated spurious emissions above 18 GHz	47
10	MEASUREMENT UNCERTAINTIES	48

Annex 1	EUT Photographs, external	49
Annex 2	EUT Photographs, internal	52
Annex 3	Test Setup Photographs	54

2 GENERAL INFORMATION

2.1 Administrative details

Testing laboratory	IBL-Lab GmbH Heinrich-Hertz-Allee 7 66386 Sankt Ingbert / Germany Fon: +49 6894 38938-0 Fax: +49 6894 38938-99 URL: www.ib-lenhardt.de E-Mail: info@ib-lenhardt.de
Accreditation	The testing laboratory is accredited by Deutsche Akkreditierungsstelle GmbH (DAkKS) in compliance with DIN EN ISO/IEC 17025:2018. Scope of testing and registration number: <ul style="list-style-type: none"> • Electronics D-PL-21375-01-01 • Electromagnetic Compatibility D-PL-21375-01-02 • Electromagnetic Compatibility and Telecommunication (FCC requirements) D-PL-21375-01-03 • Telecommunication (TC) and Electromagnetic Compatibility (EMC) for Canadian Standards D-PL-21375-01-04 • ISED Company Number 27156 • Testing Laboratory CAB Identifier DE0020 • Telekommunikation (TK) D-PL-21375-01-05 Website DAkKS: https://www.dakks.de/ The Deutsche Akkreditierungsstelle GmbH (DAkKS) is also a signatory to ILAC Mutual Recognition Arrangement
Testing location	IBL-Lab GmbH Heinrich-Hertz-Allee 7 66386 St. Ingbert / Germany
Date of receipt of test samples	2021-05-27
Start – End of tests	2021-05-27 – 2021-07-09

2.2 Possible test case verdicts

Test sample meets the requirements	P (PASS)
Test sample does not meet the requirements	F (FAIL)
Test case does not apply to the test sample	N/A (Not applicable)
Test case not performed	N/P (Not performed)

2.3 Observations

No additional observations other than the reported observations within this test report have been made.

2.4 Opinions and interpretations

No appropriate opinions or interpretations according ISO/IEC 17025:2017 clause 7.8.7 are within this test report.

2.5 Revision History

-0 Initial Version

2.6 Further documents

List of further applicable documents belonging to the present test report:
– no additional documents –

3 ENVIRONMENTAL & TEST CONDITIONS

3.1 Environmental conditions

Temperature	20°C ± 5°C
Relative humidity	25-75% r.H.
Barometric Pressure	860-1060 mbar
Power supply	230 V AC ± 5%

3.2 Normal and extreme test conditions

	minimum	normal	maximum
Temperature	-40 °C	+23 °C	+85 °C
Relative humidity	-/-	45 % r.h.	-/-
Power supply	9 V DC	12 V DC	18 V DC

4 TEST STANDARDS AND REFERENCES

Test standard (accredited)	Description
FCC 47 CFR Part 95	Personal radio services, Subpart M - The 76-81 GHz Band Radar Service

Reference	Description
ANSI C63.4-2014	American National Standard for Methods of Measurement of Radio-Noise Emissions from Low-Voltage Electrical and Electronic Equipment in the Range of 9 kHz to 40 GHz
ANSI C63.10-2013	American National Standard of Procedures for Compliance Testing of Unlicensed Wireless Devices
ANSI C63.26-2015	American National Standard for Compliance Testing of Transmitters Used in Licensed Radio Services
KDB653005 D01, V01, R01	Equipment Authorization Guidance for 76-81 GHz Radar Devices

5 EQUIPMENT UNDER TEST (EUT)

5.1 Product description

Advanced driver assistance system (ADAS)

5.2 Description of test item

Model name*	RS5.5
Serial number*	21XXXXXXXXX (EUT #3)
PCB identifier*	N/A
Hardware status*	H06
Software status*	A2009RC2

*: as declared by applicant

5.3 Technical data of test item

Operational frequency band*	76.0 GHz to 77.0 GHz
Type of radio transmission*	modulated carrier
Modulation type*	FMCW (fast chirps)
Number of channels*	1
Channel bandwidth*	< 1 GHz
Channel spacing*	N/A
Receiver category*	N/A
Receiver bandwidth*	N/A
Duty cycle*	~ 35 %
Antenna*	integrated microstrip patch array antenna
Antenna gain*	20 dBi
Rated RF output power*	~ 30 dBm
Power supply*	9.0 to 18.0 V DC
Temperature range*	-40 °C to +85 °C

*: as declared by applicant

5.4 Additional information

Model differences	N/A
Additional application considerations to test a component or sub-assembly	N/A
Ancillaries tested with	N/A
Additional equipment used for testing	N/A

5.5 Operating conditions

1) "Short-range detection mode" with the following details of one respective radar cycle:

Start of a radar cycle	
Chirp group 5: Antenna	Tx2
Chirp group 5: Chirp center frequency	76.256 GHz or 76.586 GHz or 76.804 GHz (*)
Chirp group 5: Bandwidth	300 MHz
Chirp group 5: No of chirps	256
Chirp group 5: Duration of a single chirp	34 µs
Chirp group 2: Antenna	Tx2
Chirp group 2: Chirp center frequency	76.586 GHz
Chirp group 2: Bandwidth	870 MHz
Chirp group 2: No of chirps	16
Chirp group 2: Duration of a single chirp	33 µs
Time slot with no emission	12.5 ms
Chirp group 4: Antenna	Tx2 / Tx3 alternating
Chirp group 4: Chirp center frequency	76.481 GHz or 76.679 GHz (**)
Chirp group 4: Bandwidth	720 MHz
Chirp group 4: No of chirps	84 / 84
Chirp group 4: Duration of a single chirp	45 µs
Chirp group 6: Antenna	Tx2
Chirp group 6: Chirp center frequency	76.040 GHz
Chirp group 6: Bandwidth	0 MHz (CW)
Chirp group 6: No of chirps	1
Chirp group 6: Duration of a single chirp	236 µs
Time slot with no emission	20 ms
End of radar cycle	
Duration of radar cycle	approx. 50 ms
Duty cycle	approx. 35 %

(*) Center frequency is changed approx. every two minutes or if interference is detected.

2) Far-range detection mode" with the following details of one respective radar cycle:

Start of a radar cycle	
Chirp group 5: Antenna	Tx2
Chirp group 5: Chirp center frequency	76.256 GHz or 76.586 GHz or 76.804 GHz (**)
Chirp group 5: Bandwidth	300 MHz
Chirp group 5: No of chirps	256
Chirp group 5: Duration of a single chirp	34 µs
Chirp group 2: Antenna	Tx2
Chirp group 2: Chirp center frequency	76.586 GHz
Chirp group 2: Bandwidth	870 MHz
Chirp group 2: No of chirps	16
Chirp group 2: Duration of a single chirp	33 µs
Time slot with no emission	12.5 ms
Chirp group 3: Antenna	Tx1
Chirp group 3: Chirp center frequency	76.256 GHz or 76.586 GHz or 76.804 GHz (**)
Chirp group 3: Bandwidth	370 MHz
Chirp group 3: No of chirps	256
Chirp group 3: Duration of a single chirp	33 µs
Chirp group 6: Antenna	Tx2
Chirp group 6: Chirp center frequency	76.040 GHz
Chirp group 6: Bandwidth	0 MHz (CW)
Chirp group 6: No of chirps	1
Chirp group 6: Duration of a single chirp	236 µs
Time slot with no emission	20 ms
End of radar cycle	
Duration of radar cycle	approx. 50 ms
Duty cycle	approx. 35 %

(**) Center frequency is changed approx. every two minutes or if interference is detected.

Over time, RS5.5 toggles between its two operating modes while RS5.3 permanently uses the "Short-range detection mode":

Radar cycle	RS5.5	RS5.3
N	Short-range	Short-range
n+1	Far-range	Short-range
n+2	Short-range	Short-range
n+3	Far-range	Short-range
...

5.6 Antenna characteristics

Fig. 2: Top: Antenna characteristics in azimuth and in elevation for Tx1.
Bottom: Antenna characteristics in elevation@azimut=45° for Tx1.
The peak gain is approx. 20 dBi.

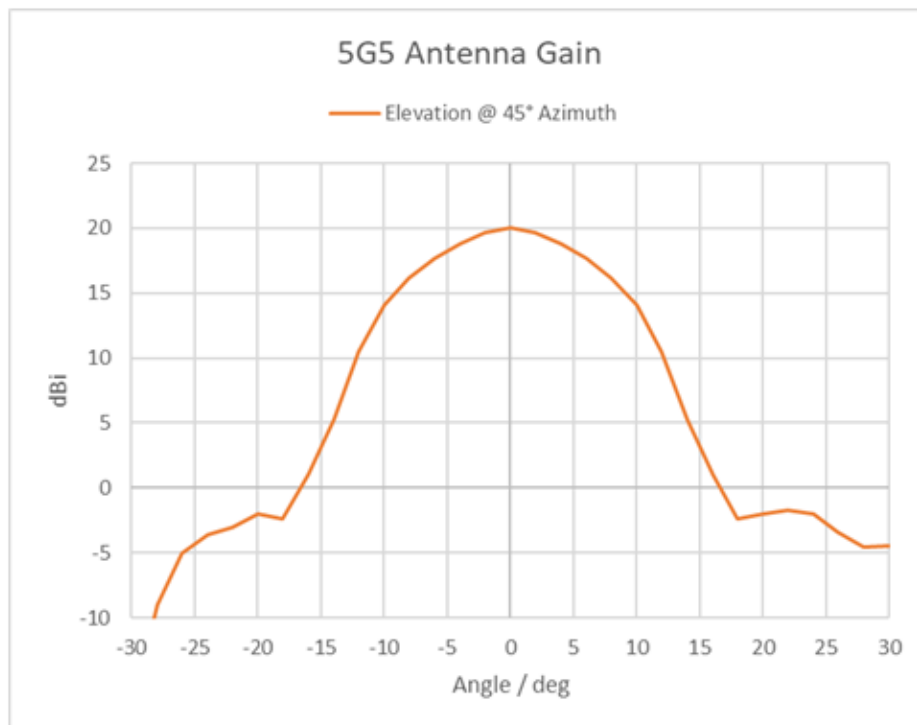
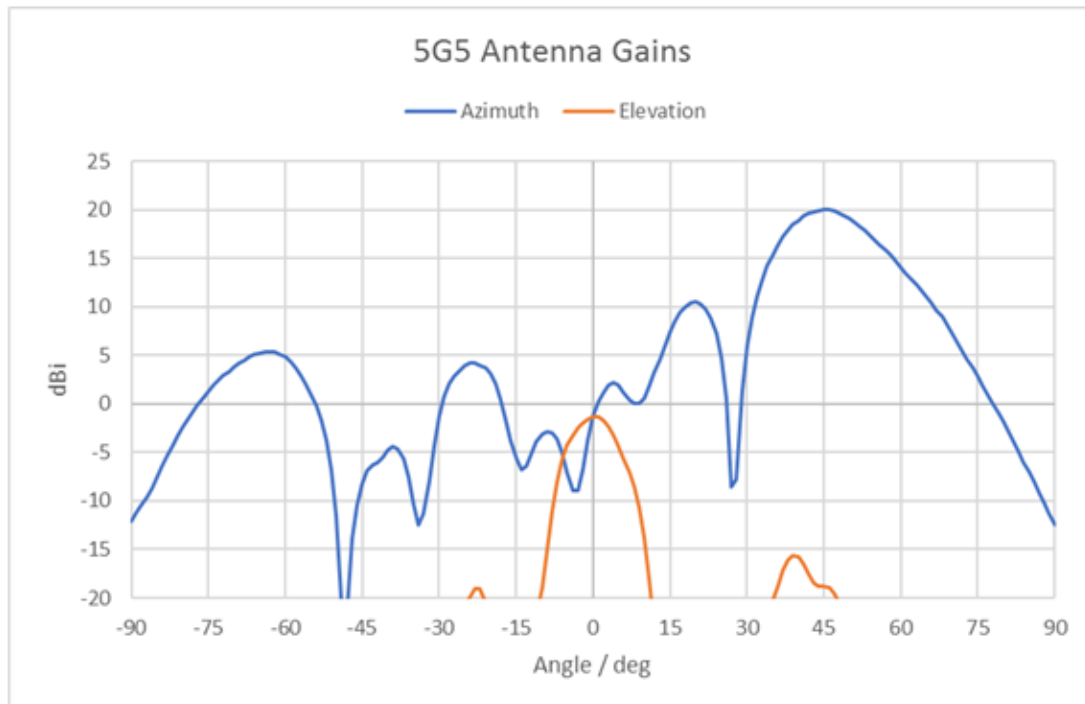

Fig. 3: Antenna characteristics in azimuth and in elevation for Tx2, Tx3 and receive antennas. The peak gain is approx. 15 dBi.

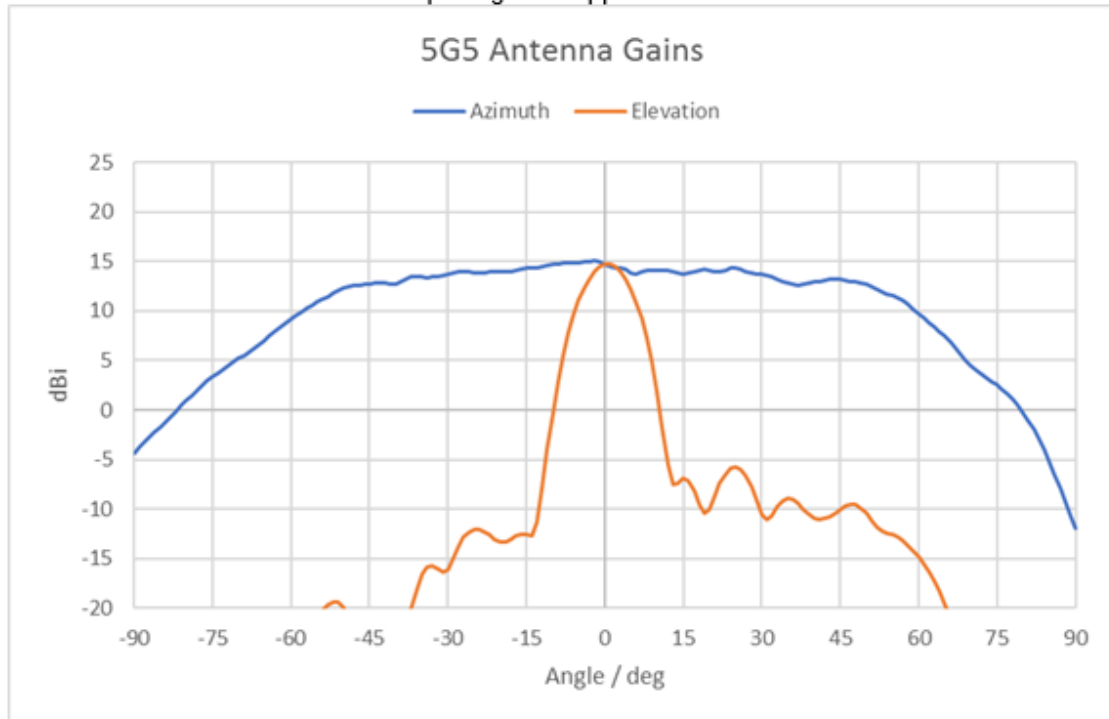
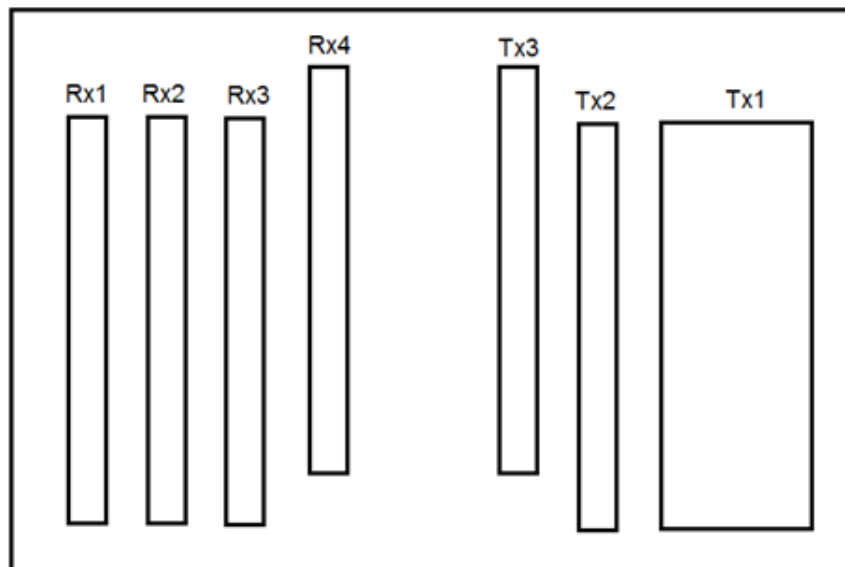

Fig 1: Illustration of Tx and Rx antennas inside the EUT. Each antenna consists of a patch array. The connector is located on the left side.



6 SUMMARY OF TEST RESULTS

Test specification

FCC 47 CFR Part 95 Subpart M

Clause	Requirement / Test case	Test Conditions	Result / Remark	Verdict
§2.1046 §95.3367 (a) (b)	RF power output	Nominal	31.3 dBm Peak 22.0 dBm RMS	P
§2.1047	Modulation characteristics	Nominal		P
§2.1049	Occupied bandwidth	Nominal	881.926 MHz	P
§2.1051	Spurious emissions at antenna terminals	Nominal	see note	N/A
§2.1053 §95.3379 (a)(1) §95.3379 (a)(2) §95.3379 (a)(3)	Field strength of spurious radiation	Nominal	< limit	P
§2.1055 §95.3379 (b)	Frequency stability	Nominal Extreme		P

Notes

FCC's Millimeter Wave Test Procedures:

I. A radiated method of measurements in order to demonstrate compliance with the various regulatory requirements has been chosen in consideration of test equipment availability and the limitations of many external harmonic mixers. A conducted method of measurement could be employed if EUT and mixer waveguides both are accessible and of the same type (WG number) and if waveguide sections and transitions can be found. Another potential problem is that the peak power output may exceed the +20 dBm input power limit of many commercially available mixers. For these reasons a radiated method is preferred.

Comments and observations

N/A

7 TEST RESULTS

7.1 RF power output (§2.1046 & §95.3367)

Description

§2.1046 Measurements required: RF power output.

(a) For transmitters other than single sideband, independent sideband and controlled carrier radiotelephone, power output shall be measured at the RF output terminals when the transmitter is adjusted in accordance with the tune-up procedure to give the values of current and voltage on the circuit elements specified in §2.1033(c)(8). The electrical characteristics of the radio frequency load attached to the output terminals when this test is made shall be stated.

Limits

The fundamental radiated emission limits within the 76-81 GHz band are expressed in terms of Equivalent Isotropically Radiated Power (EIRP) and are as follows:

- (a) The maximum power (EIRP) within the 76-81 GHz band shall not exceed 50 dBm based on measurements employing a power averaging detector with a 1 MHz Resolution Bandwidth (RBW).
- (b) The maximum peak power (EIRP) within the 76-81 GHz band shall not exceed 55 dBm based on measurements employing a peak detector with a 1 MHz RBW.

Test procedure

Mean Power

Method with spectrum analyser

A spectrum analyser with the following settings is used as measuring receiver in the test set-up:

- Start frequency: lower than the lower edge of the operating frequency range.
- Stop frequency: higher than the upper edge of the operating frequency range.
- Resolution bandwidth: 1 MHz.
- Video bandwidth: 3 MHz.
- Detector mode: RMS.
- Display mode: clear write.
- Averaging time: larger than one EUT cycle time.
- Sweep time: averaging time × number of sweep points.

Channel Power function needs to be used to calculate the average power. Boundaries for the calculation needs to be defined. This is typically the operating frequency range.

Method with power meter

The power meter shall be connected to the measurement antenna. The frequency correction factor shall be taken into account. The power meter shall be a true RMS power meter. The measurement time shall be equal or longer than the EUT cycle time.

Test procedure

Peak Power

Method with a spectrum analyser

A spectrum analyser with the following settings is used as measuring receiver in the test set-up:

- Start frequency: lower than the lower edge of the operating frequency range.
- Stop frequency: higher than the upper edge of the operating frequency range.
- Resolution bandwidth: 1 MHz.
- Video bandwidth: 3 MHz.
- Detector mode: Peak detector.
- Display mode: Maxhold.
- Averaging time: larger than one EUT cycle time.
- Sweep time: averaging time × number of sweep points.

The peak power to be considered is the maximum value recorded.

Test setup: 8.3			
Test results:			
EUT mode	Test distance	Radiated Mean Power (EIRP) [dBm]	Radiated Peak Power (EIRP) [dBm]
see 5.5	1 m	22.0	31.3

Plot no. 1: Mean Power EIRP, RMS detector / Channel Power



Plot no. 2: Peak Power EIRP, Peak detector

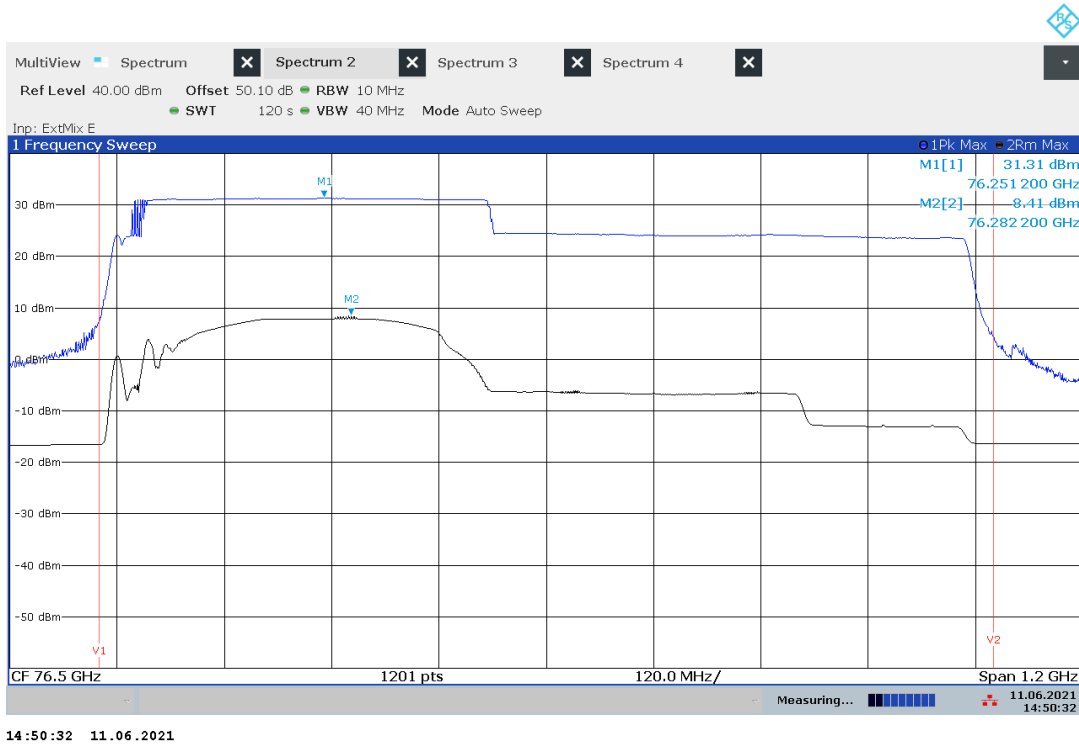

7.2 Modulation characteristics (§2.1047 & KDB 653005 D01 76-81 GHz Radars v01r01)

Description

§2.1047 Modulation characteristics

(d) Other types of equipment. A curve or equivalent data which shows that the equipment will meet the modulation requirements of the rules under which the equipment is to be licensed.

KDB 653005 D01 76-81 GHz Radars V01r01:

Concerning the Section 2.1047 modulation characteristics requirement, the following information should be provided:

- 1) Pulsed radar: pulse width and pulse repetition frequency (if PRF is variable, then report maximum and minimum values).
- 2) Non-pulsed radar (e.g., FMCW): modulation type (i.e., sawtooth, sinusoid, triangle, or square wave) and sweep characteristics (sweep bandwidth, sweep rate, sweep time).

Statement of applicant / manufacturer concerning modulation characteristics of EUT

1) "Short-range detection mode" with the following details of one respective radar cycle:

Start of a radar cycle	
Chirp group 5: Antenna	Tx2
Chirp group 5: Chirp center frequency	76.256 GHz or 76.586 GHz or 76.804 GHz (*)
Chirp group 5: Bandwidth	300 MHz
Chirp group 5: No of chirps	256
Chirp group 5: Duration of a single chirp	34 µs
Chirp group 2: Antenna	Tx2
Chirp group 2: Chirp center frequency	76.586 GHz
Chirp group 2: Bandwidth	870 MHz
Chirp group 2: No of chirps	16
Chirp group 2: Duration of a single chirp	33 µs
Time slot with no emission	12.5 ms
Chirp group 4: Antenna	Tx2 / Tx3 alternating
Chirp group 4: Chirp center frequency	76.481 GHz or 76.679 GHz (*)
Chirp group 4: Bandwidth	720 MHz
Chirp group 4: No of chirps	84 / 84
Chirp group 4: Duration of a single chirp	45 µs
Chirp group 6: Antenna	Tx2
Chirp group 6: Chirp center frequency	76.040 GHz
Chirp group 6: Bandwidth	0 MHz (CW)
Chirp group 6: No of chirps	1
Chirp group 6: Duration of a single chirp	236 µs
Time slot with no emission	20 ms
End of radar cycle	
Duration of radar cycle	approx. 50 ms
Duty cycle	approx. 35 %

(*) Center frequency is changed approx. every two minutes or if interference is detected.

2) Far-range detection mode" with the following details of one respective radar cycle:

Start of a radar cycle	
Chirp group 5: Antenna	Tx2
Chirp group 5: Chirp center frequency	76.256 GHz or 76.586 GHz or 76.804 GHz (**)
Chirp group 5: Bandwidth	300 MHz
Chirp group 5: No of chirps	256
Chirp group 5: Duration of a single chirp	34 µs
Chirp group 2: Antenna	Tx2
Chirp group 2: Chirp center frequency	76.586 GHz
Chirp group 2: Bandwidth	870 MHz
Chirp group 2: No of chirps	16
Chirp group 2: Duration of a single chirp	33 µs
Time slot with no emission	12.5 ms
Chirp group 3: Antenna	Tx1
Chirp group 3: Chirp center frequency	76.256 GHz or 76.586 GHz or 76.804 GHz (**)
Chirp group 3: Bandwidth	370 MHz
Chirp group 3: No of chirps	256
Chirp group 3: Duration of a single chirp	33 µs
Chirp group 6: Antenna	Tx2
Chirp group 6: Chirp center frequency	76.040 GHz
Chirp group 6: Bandwidth	0 MHz (CW)
Chirp group 6: No of chirps	1
Chirp group 6: Duration of a single chirp	236 µs
Time slot with no emission	20 ms
End of radar cycle	
Duration of radar cycle	approx. 50 ms
Duty cycle	approx. 35 %

(**) Center frequency is changed approx. every two minutes or if interference is detected.

Over time, RS5.5 toggles between its two operating modes while RS5.3 permanently uses the "Short-range detection mode":

Radar cycle	RS5.5	RS5.3
N	Short-range	Short-range
n+1	Far-range	Short-range
n+2	Short-range	Short-range
n+3	Far-range	Short-range
...

7.3 Occupied bandwidth (§2.1049)
<p>Description</p> <p>§2.1049 Measurements required: Occupied bandwidth. The occupied bandwidth, that is the frequency bandwidth such that, below its lower and above its upper frequency limits, the mean powers radiated are each equal to 0.5 percent of the total mean power radiated by a given emission shall be measured.</p>
<p>Limits</p> <p>The radar device's occupied bandwidth (i.e. 99% emission bandwidth) shall be contained in the 76-81GHz frequency band.</p>
<p>Test procedure</p> <p>ANSI C63.10, 6.9.3</p> <p>The occupied bandwidth is the frequency bandwidth such that, below its lower and above its upper frequency limits, the mean powers are each equal to 0.5% of the total mean power of the given emission. The following procedure shall be used for measuring 99% power bandwidth:</p> <p>a) The instrument center frequency is set to the nominal EUT channel center frequency. The frequency span for the spectrum analyzer shall be between 1.5 times and 5.0 times the OBW. b) The nominal IF filter bandwidth (3 dB RBW) shall be in the range of 1% to 5% of the OBW, and VBW shall be approximately three times the RBW, unless otherwise specified by the applicable requirement. c) Set the reference level of the instrument as required, keeping the signal from exceeding the maximum input mixer level for linear operation. In general, the peak of the spectral envelope shall be more than [10 log (OBW/RBW)] below the reference level. Specific guidance is given in 4.1.5.2. d) Step a) through step c) might require iteration to adjust within the specified range. e) Video averaging is not permitted. Where practical, a sample detection and single sweep mode shall be used. Otherwise, peak detection and max hold mode (until the trace stabilizes) shall be used. f) Use the 99% power bandwidth function of the instrument (if available) and report the measured bandwidth. g) If the instrument does not have a 99% power bandwidth function, then the trace data points are recovered and directly summed in linear power terms. The recovered amplitude data points, beginning at the lowest frequency, are placed in a running sum until 0.5% of the total is reached; that frequency is recorded as the lower frequency. The process is repeated until 99.5% of the total is reached; that frequency is recorded as the upper frequency. The 99% power bandwidth is the difference between these two frequencies. h) The occupied bandwidth shall be reported by providing plot(s) of the measuring instrument display; the plot axes and the scale units per division shall be clearly labeled. Tabular data may be reported in addition to the plot(s).</p>
<p>Note</p> <p>Measurements with the peak detector are also suitable to demonstrate compliance of an EUT, as long as the required resolution bandwidth is used, because peak detection will yield amplitudes equal to or greater than amplitudes measured with RMS detector. The measurement data from a spectrum analyser peak detector will represent the worst-case results (see ANSI C63.10).</p>
<p>Test setup: 8.3, 8.4</p>

Test results under normal and extreme test conditions				
EUT mode	Test conditions	f _L [GHz]	f _H [GHz]	99% OBW [MHz]
see 5.5	85 °C	76.050	76.921	871.365
see 5.5	50 °C	76.052	76.903	851.304
see 5.5	40 °C	76.044	76.866	822.040
see 5.5	30 °C	76.054	76.936	881.926
see 5.5	20 °C	76.055	76.918	863.460
see 5.5	10 °C	76.044	76.914	870.124
see 5.5	0 °C	76.043	76.910	866.895
see 5.5	-10 °C	76.046	76.911	865.218
see 5.5	-20 °C	76.048	76.929	881.210
see 5.5	-30 °C	76.051	76.926	875.385
see 5.5	-40 °C	76.047	76.918	870.780
With voltage variation				
Input voltage variation does not affect the transmitted signal (see plot for ambient/normal temperature).				

TR no.: 20114849-19759-0

2021-07-11

Plot no. 3: 99% OBW, Peak detector, 85 °C



Plot no. 4: 99% OBW, Peak detector, 50 °C

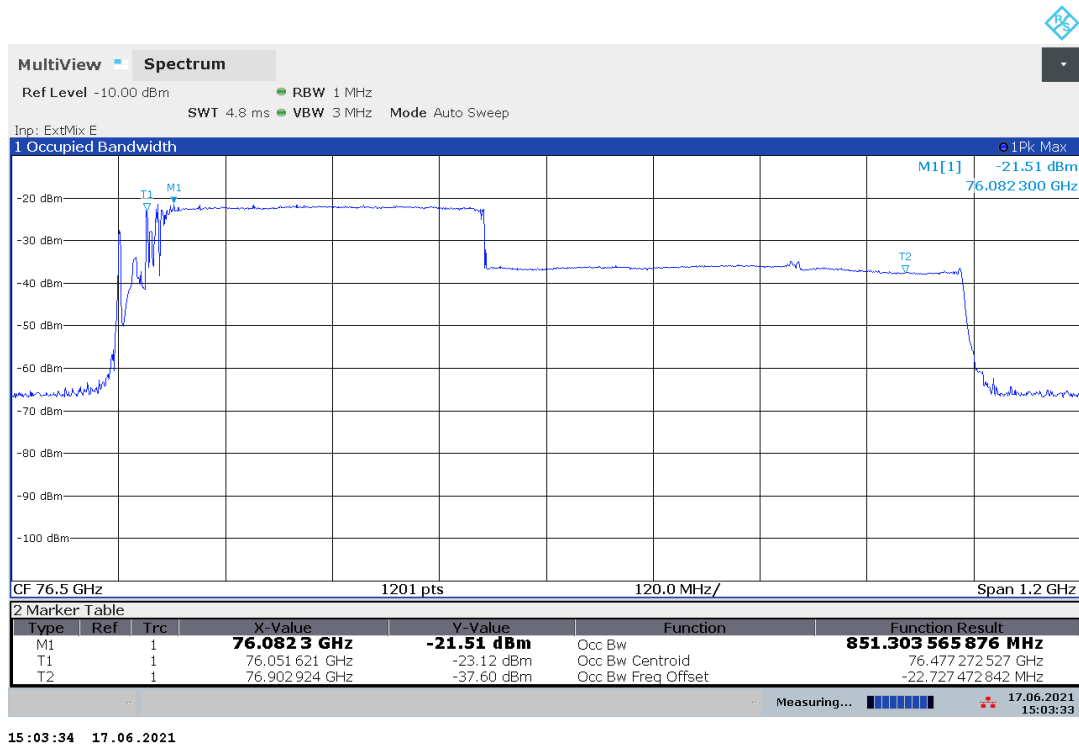

TR no.: 20114849-19759-0

2021-07-11

Plot no. 5: 99% OBW, Peak detector, 40 °C

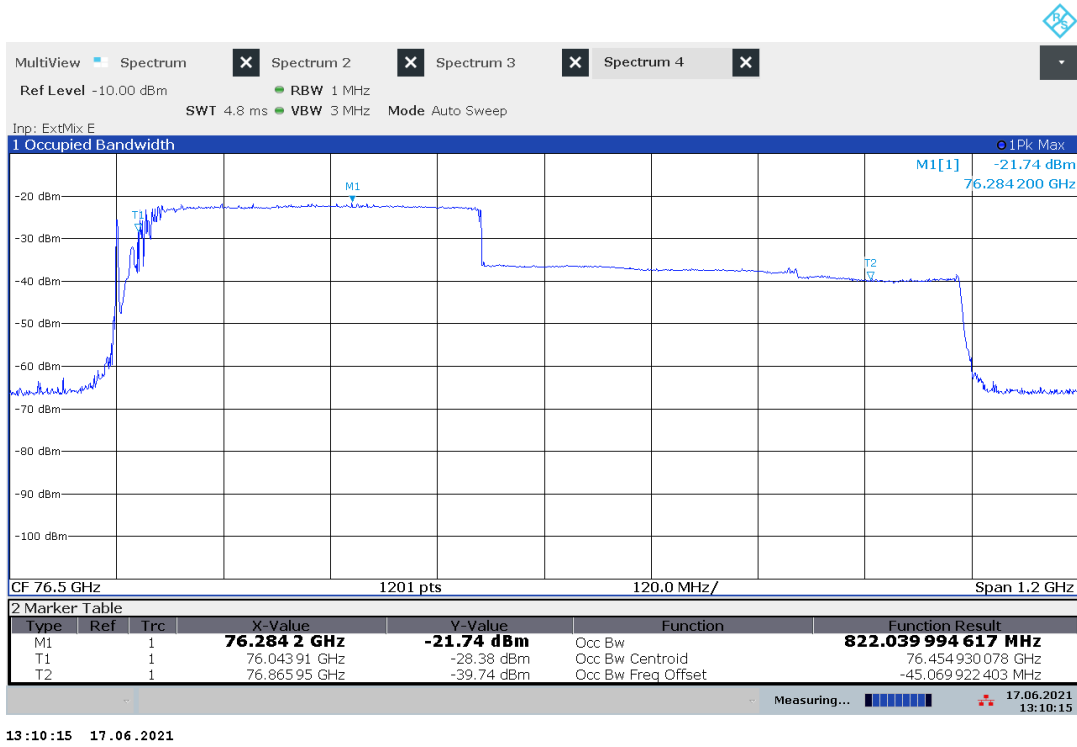

Plot no. 6: 99% OBW, Peak detector, 30 °C



TR no.: 20114849-19759-0

2021-07-11

Plot no. 7: 99% OBW, Peak detector, 20 °C



Plot no. 8: 99% OBW, Peak detector, 10 °C



TR no.: 20114849-19759-0

2021-07-11

Plot no. 9: 99% OBW, Peak detector, 0 °C



Plot no. 10: 99% OBW, Peak detector, -10 °C



TR no.: 20114849-19759-0

2021-07-11

Plot no. 11: 99% OBW, Peak detector, -20 °C

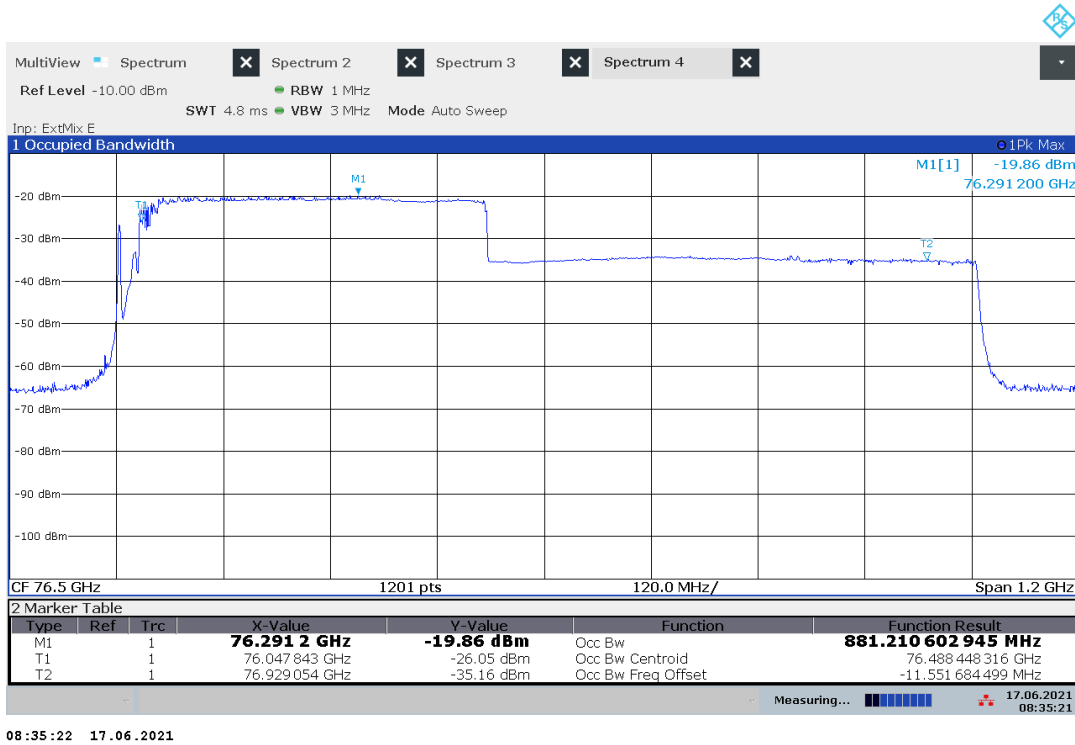

Plot no. 12: 99% OBW, Peak detector, -30 °C



TR no.: 20114849-19759-0

2021-07-11

Plot no. 13: 99% OBW, Peak detector, -40 °C



07:10:58 17.06.2021

7.4 Field strength of spurious radiation (§2.1053 & §95.3379)

Description

§2.1053 Measurements required: Field strength of spurious radiation.

(a) Measurements shall be made to detect spurious emissions that may be radiated directly from the cabinet, control circuits, power leads, or intermediate circuit elements under normal conditions of installation and operation. Curves or equivalent data shall be supplied showing the magnitude of each harmonic and other spurious emission. For this test, single sideband, independent sideband, and controlled carrier transmitters shall be modulated under the conditions specified in paragraph (c) of §2.1049, as appropriate. For equipment operating on frequencies below 890 MHz, an open field test is normally required, with the measuring instrument antenna located in the far-field at all test frequencies. In the event it is either impractical or impossible to make open field measurements (e.g. a broadcast transmitter installed in a building) measurements will be accepted of the equipment as installed. Such measurements must be accompanied by a description of the site where the measurements were made showing the location of any possible source of reflections which might distort the field strength measurements. Information submitted shall include the relative radiated power of each spurious emission with reference to the rated power output of the transmitter, assuming all emissions are radiated from halfwave dipole antennas.

Limits

§95.3379 76-81 GHz Band Radar Service unwanted emissions limits.

(a) The power density of any emissions outside the 76-81 GHz band shall consist solely of spurious emissions and shall not exceed the following:

(1) Radiated emissions below 40 GHz shall not exceed the field strength as shown in the following emissions table.

Frequency [MHz]	Field Strength [$\mu\text{V}/\text{m}$] / [dB $\mu\text{V}/\text{m}$]	Measurement distance [m]
0.009 – 0.490	2400/F[kHz]	300
0.490 – 1.705	24000/F[kHz]	30
1.705 – 30.0	30.0 / 29.5	30
30 – 88	100 / 40.0	3
88 – 216	150 / 43.5	3
216 – 960	200 / 46.0	3
960 – 40 000	500 / 54.0	3

(2) The power density of radiated emissions outside the 76-81 GHz band above 40.0 GHz shall not exceed the following, based on measurements employing an average detector with a 1 MHz RBW:

Frequency [GHz]	Power Density / EIRP	Measurement distance [m]
40 – 200	600 pW/cm ² → -1.7 dBm	3
200 – 243	1000 pW/cm ² → +0.5 dBm	3

Note

Measurements with the peak detector are also suitable to demonstrate compliance of an EUT, as long as the required resolution bandwidth is used, because peak detection will yield amplitudes equal to or greater than amplitudes measured with RMS detector. The measurement data from a spectrum analyser peak detector will represent the worst-case results (see ANSI C63.10).

Typical test distances	
Up to 18 GHz:	3.00 m
18 – 50 GHz:	0.50 m
50 – 110 GHz:	0.25 m
110 – 170 GHz:	0.10 m
In-band / OOB:	1.00 m

Test setup: 8.1 – 8.4 (in case of field strength measurements below 40 GHz: test distance correction factor of 20dB/decade is already considered in the plots / test result table)

Test results:

Channel / Mode	Frequency [GHz]	Detector	Test distance [m]	Level [dBμV/dBm]	Limit [dBμV/dBm]	Margin [dB]
see 5.5	25.349	PosPeak	1	57.8 dBμV	74 dBμV	16.2
see 5.5	25.366	AVG	1	36.1 dBμV	54 dBμV	17.9

Plot no. 14: radiated emissions 9 kHz – 30 MHz, loop antenna

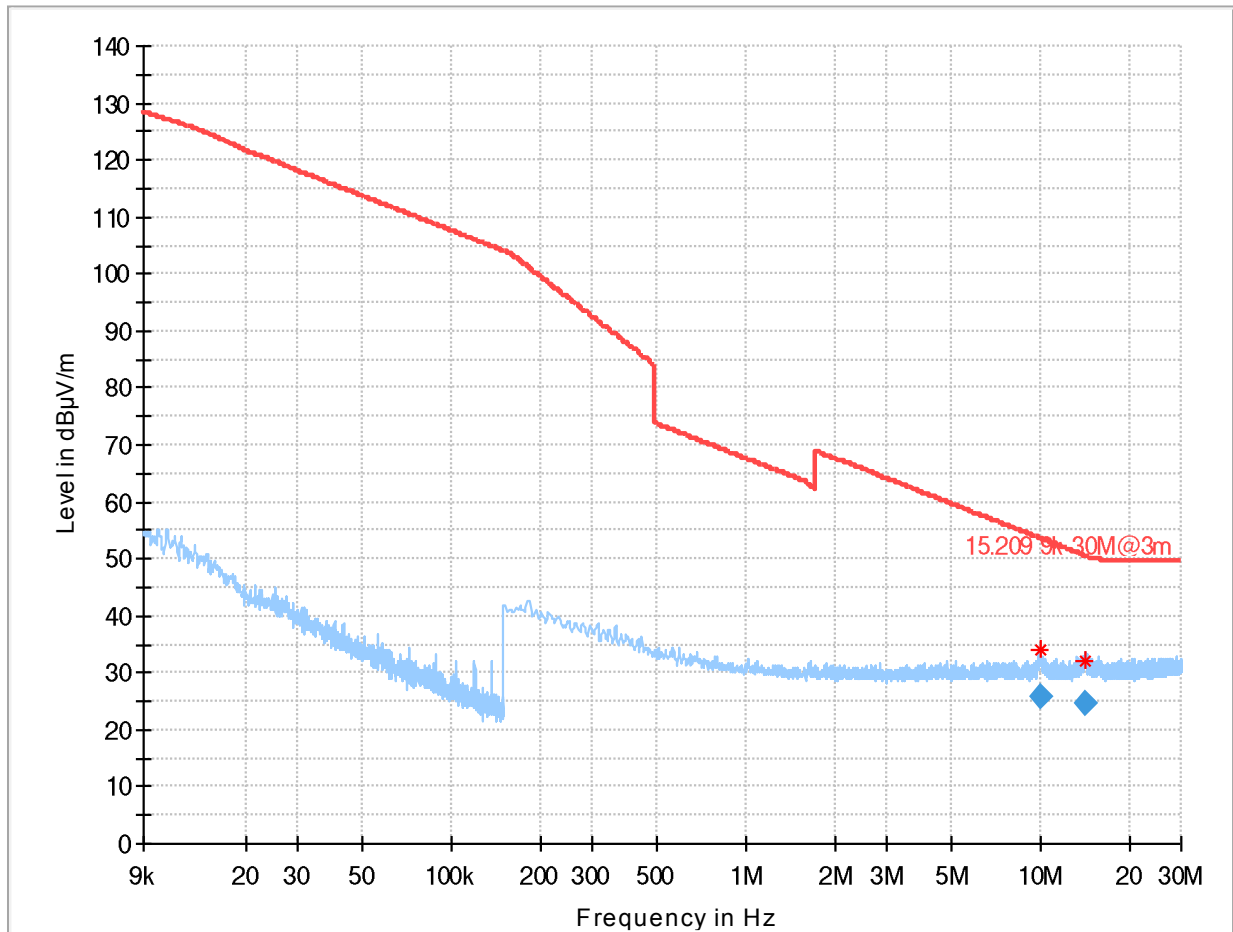

Critical_Freqs

Frequency (MHz)	MaxPeak (dBµV/m)	Limit (dBµV/m)	Margin (dB)	Meas. Time (ms)	Bandwidth (kHz)	Pol	Azimuth (deg)	Corr. (dB/m)
9.973500	34.15	53.53	19.38	---	---	H	141.0	20.6
14.185500	32.06	50.56	18.50	---	---	H	316.0	20.5

Final_Result

Frequency (MHz)	QuasiPeak (dBµV/m)	Limit (dBµV/m)	Margin (dB)	Meas. Time (ms)	Bandwidth (kHz)	Pol	Azimuth (deg)	Corr. (dB/m)
9.973500	25.64	53.60	27.96	100.0	9.000	H	141.0	20.6
14.185500	24.55	50.55	26.00	100.0	9.000	H	316.0	20.5

Plot no. 15: radiated emissions 30 MHz – 1 GHz, polarization vertical / horizontal

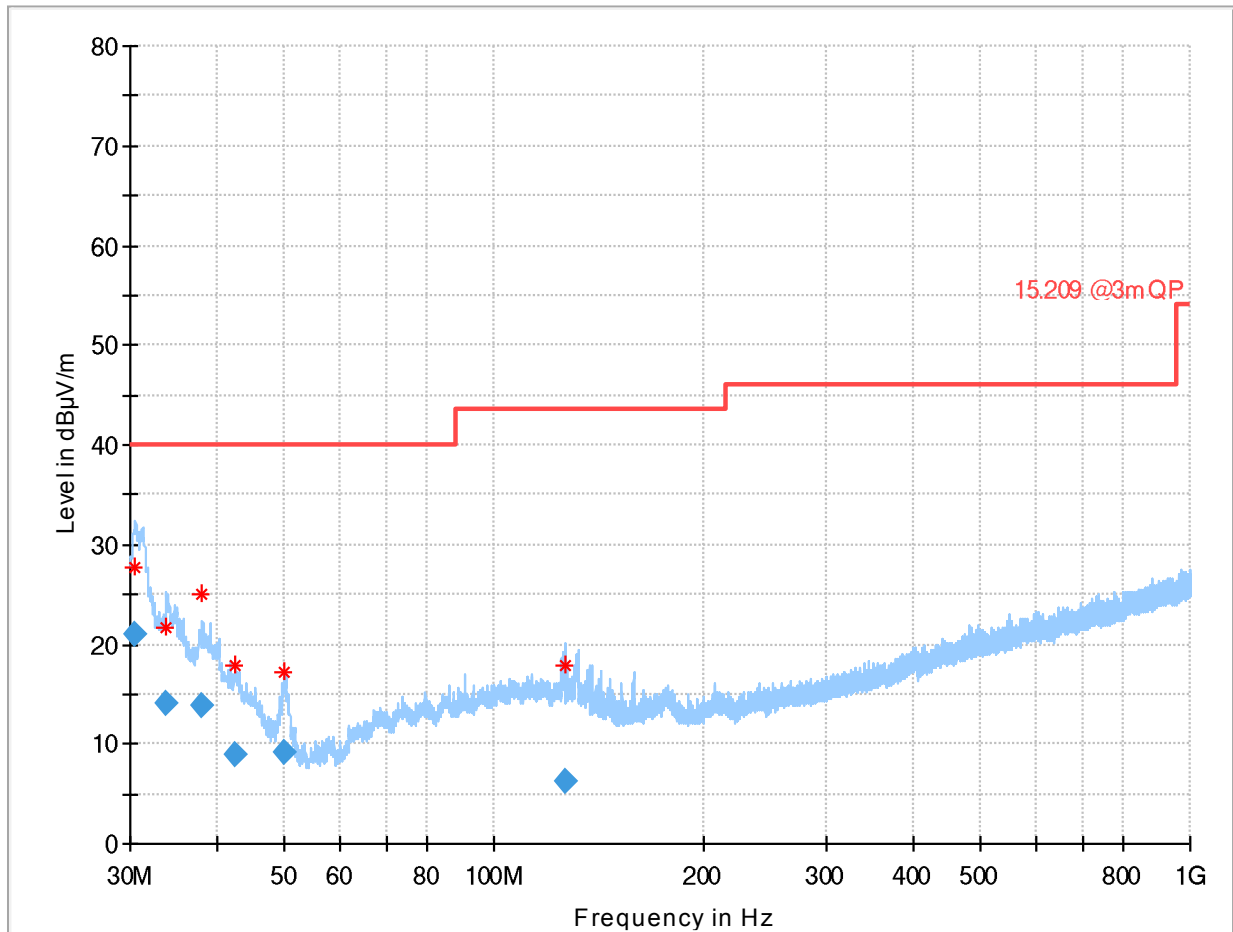

Critical Freqs

Frequency (MHz)	MaxPeak (dBµV/m)	Limit (dBµV/m)	Margin (dB)	Meas. Time (ms)	Bandwidth (kHz)	Height (cm)	Pol	Azimuth (deg)
30.425000	27.69	40.00	12.31	---	---	106.0	V	315.0
33.750000	21.68	40.00	18.32	---	---	121.0	V	52.0
38.075000	24.99	40.00	15.01	---	---	103.0	V	254.0
42.375000	17.86	40.00	22.14	---	---	233.0	V	96.0
50.050000	17.31	40.00	22.69	---	---	103.0	V	119.0
126.300000	17.80	43.50	25.70	---	---	131.0	V	-23.0

Final Result

Frequency (MHz)	QuasiPeak (dBµV/m)	Limit (dBµV/m)	Margin (dB)	Meas. Time (ms)	Bandwidth (kHz)	Height (cm)	Pol	Azimuth (deg)
30.425000	20.99	40.00	19.01	100.0	120.000	106.0	V	315.0
33.750000	14.18	40.00	25.82	100.0	120.000	121.0	V	52.0
38.075000	13.79	40.00	26.21	100.0	120.000	103.0	V	254.0
42.375000	9.03	40.00	30.97	100.0	120.000	233.0	V	96.0
50.050000	9.17	40.00	30.83	100.0	120.000	103.0	V	119.0
126.300000	6.20	43.50	37.30	100.0	120.000	131.0	V	-23.0

Plot no. 16: radiated emissions 1 GHz – 18 GHz, polarization vertical / horizontal

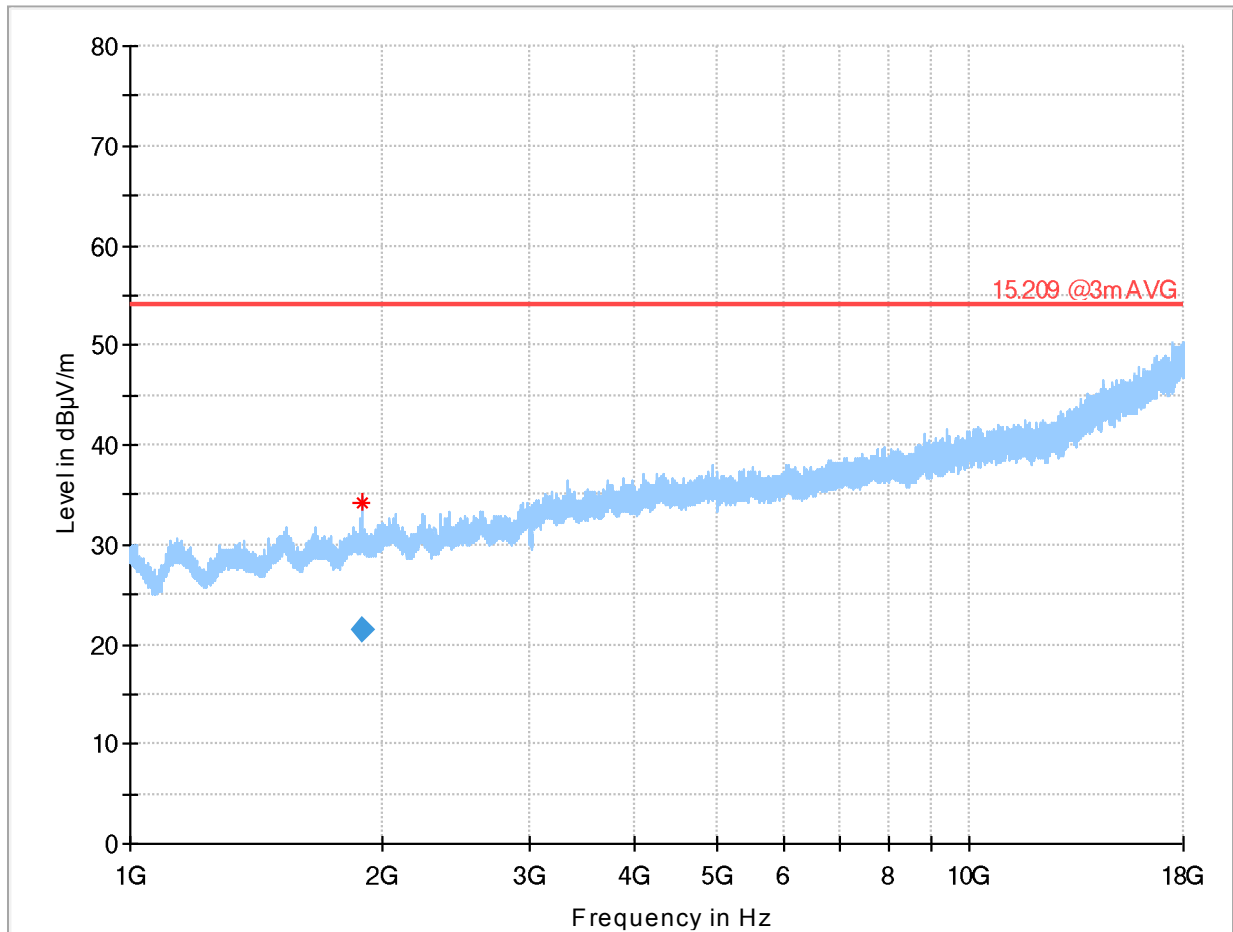

Critical Freqs

Frequency (MHz)	MaxPeak (dBµV/m)	Limit (dBµV/m)	Margin (dB)	Meas. Time (ms)	Bandwidth (kHz)	Height (cm)	Pol	Azimuth (deg)
1895.350000	34.12	54.00	19.88	---	---	150.0	V	273.0

Final Result

Frequency (MHz)	Average (dBµV/m)	Limit (dBµV/m)	Margin (dB)	Meas. Time (ms)	Bandwidth (kHz)	Height (cm)	Pol	Azimuth (deg)
1895.350000	21.51	54.00	32.49	100.0	1000.000	150.0	V	273.0

Plot no. 17: radiated emissions 18 GHz – 26.5 GHz, polarization vertical / horizontal

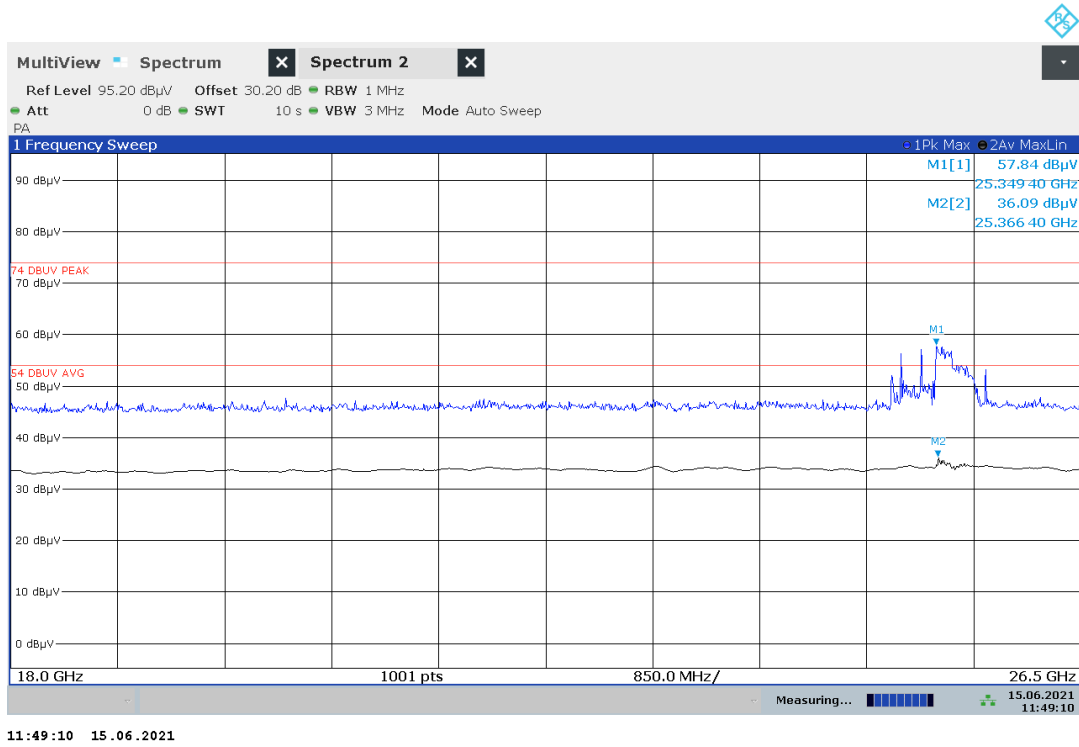

Plot no. 18: radiated emissions 26.5 GHz – 40 GHz, polarization vertical / horizontal

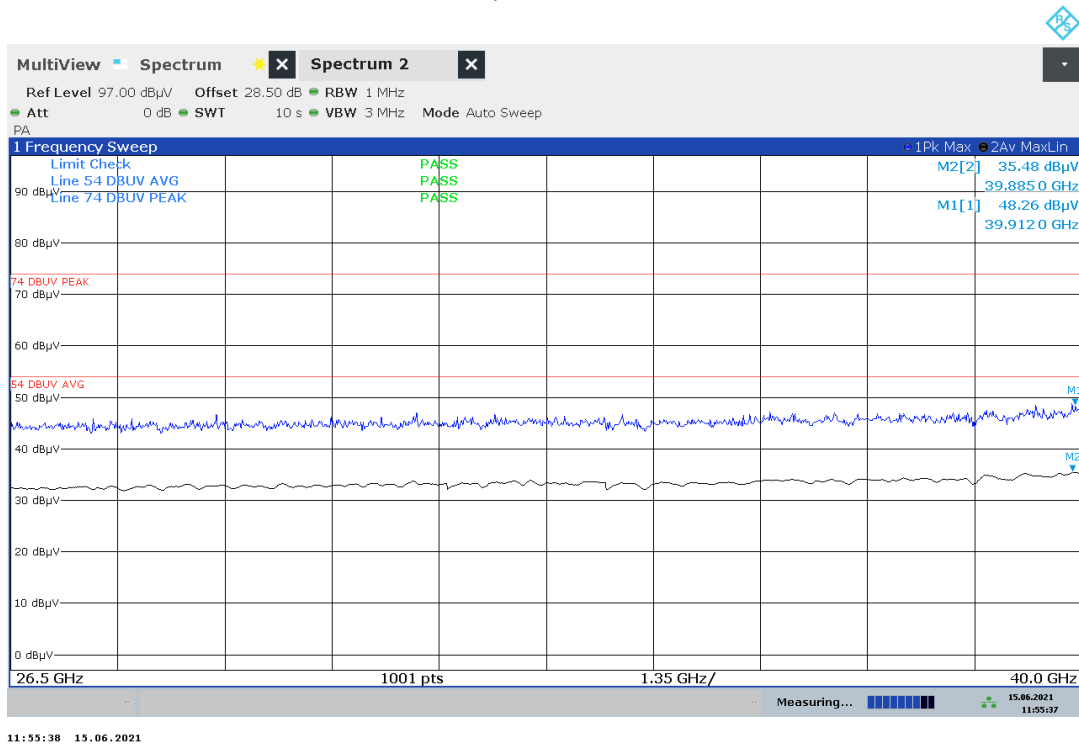

Plot no. 19: radiated emissions 40 GHz – 50 GHz, polarization vertical / horizontal

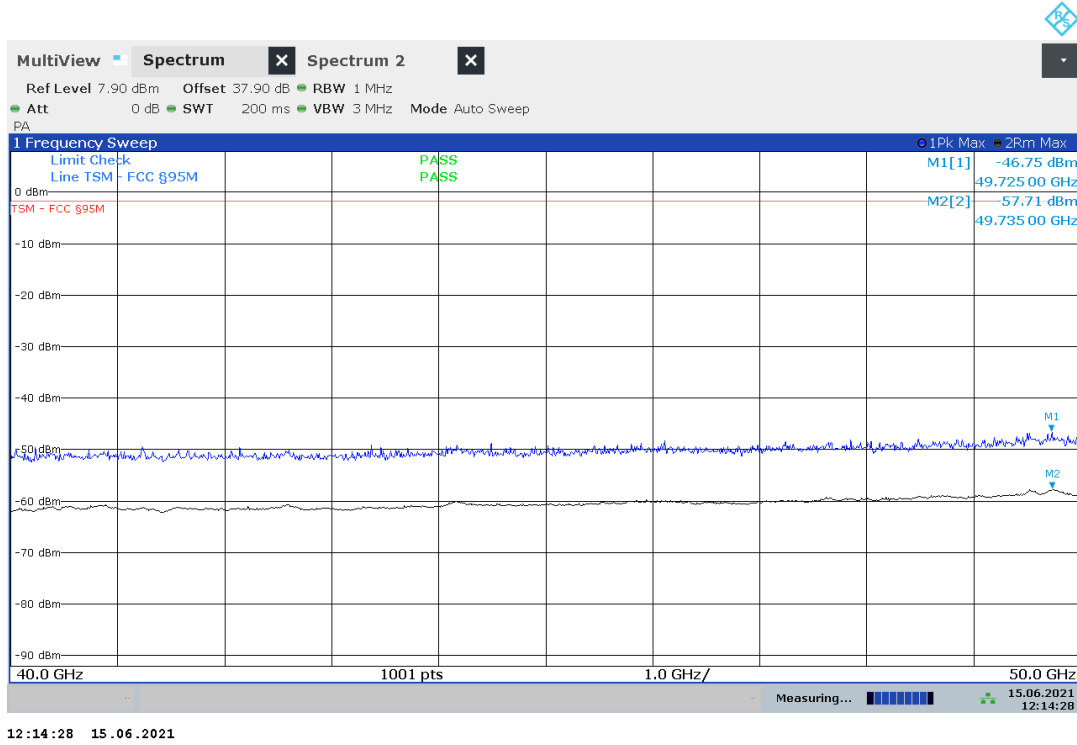

Plot no. 20: radiated emissions 50 GHz – 75 GHz, polarization vertical / horizontal

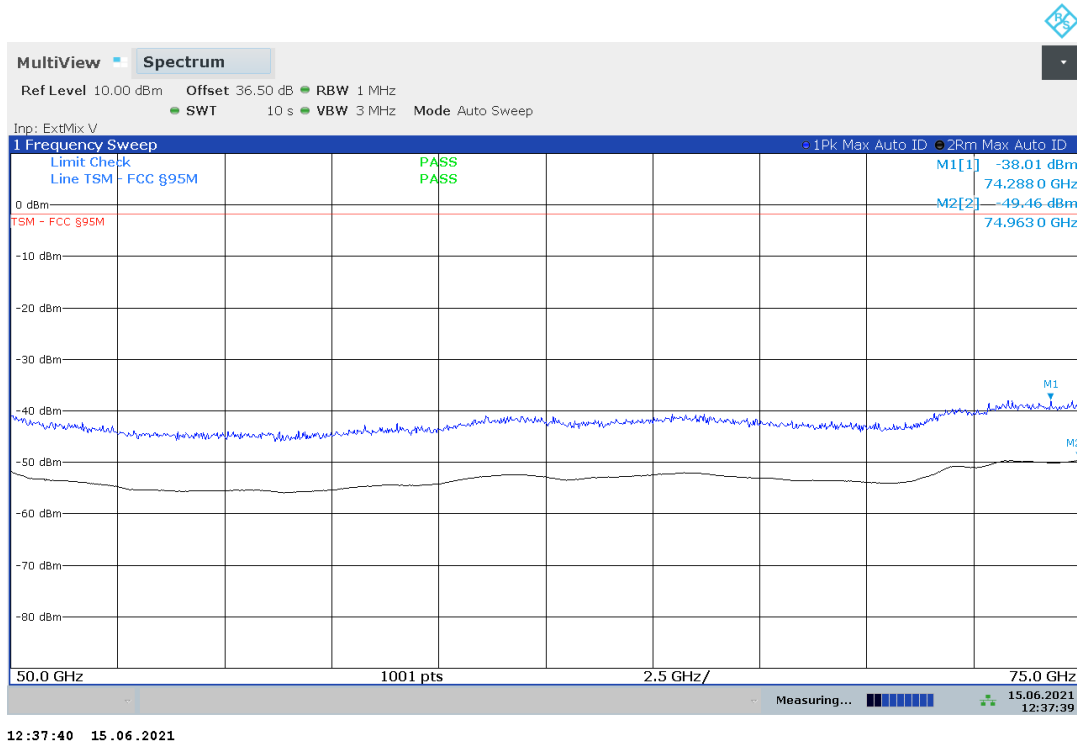

Plot no. 21: radiated emissions 75 GHz – 78 GHz, BEC, TSM, polarization aligned with radar sensor



Plot no. 22: radiated emissions 78 GHz – 110 GHz, polarization vertical / horizontal

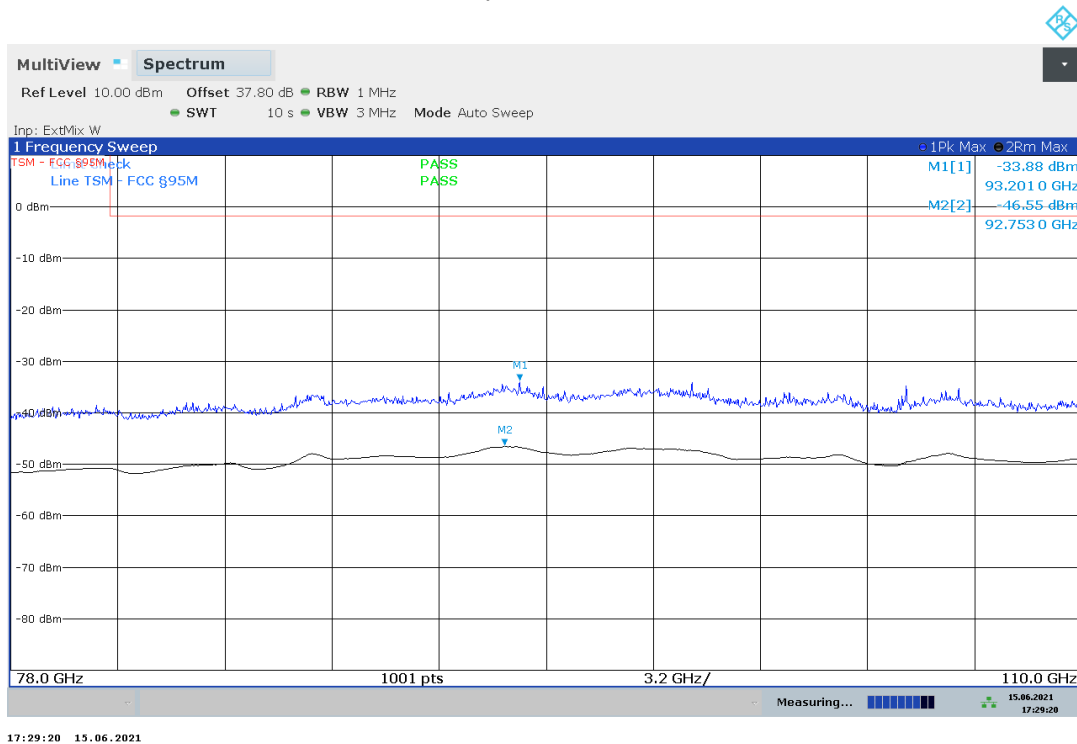

Plot no. 23: radiated emissions 110 GHz – 170 GHz, polarization vertical / horizontal

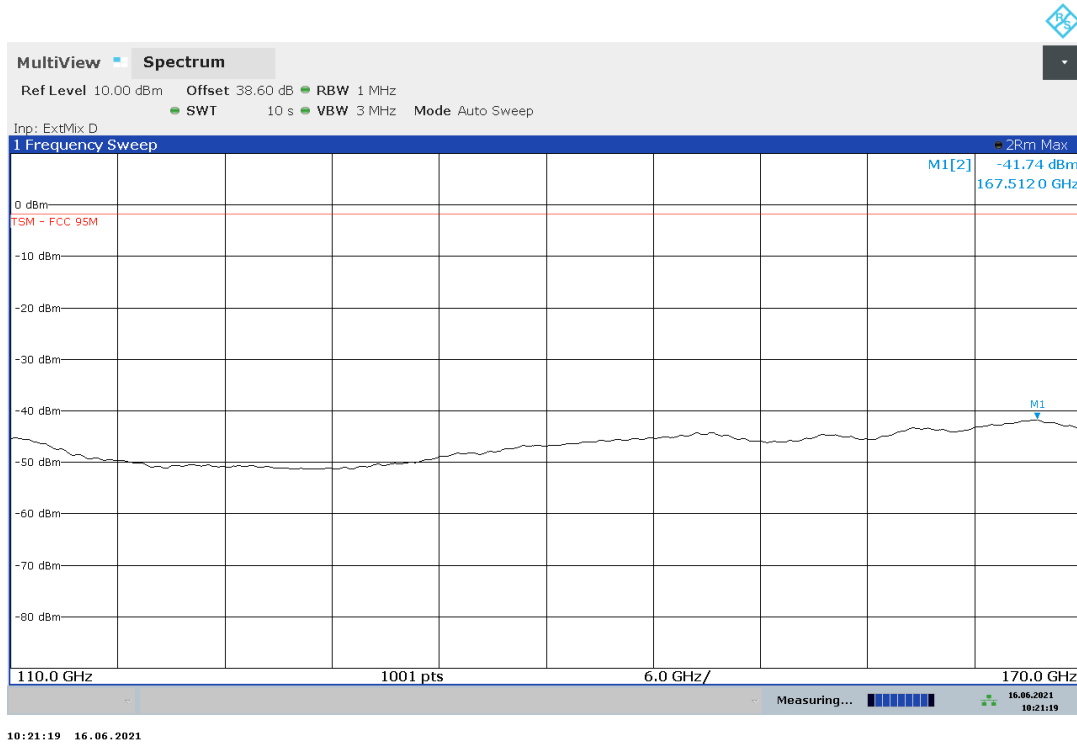

Plot no. 24: radiated emissions 170 GHz – 220 GHz, polarization vertical / horizontal

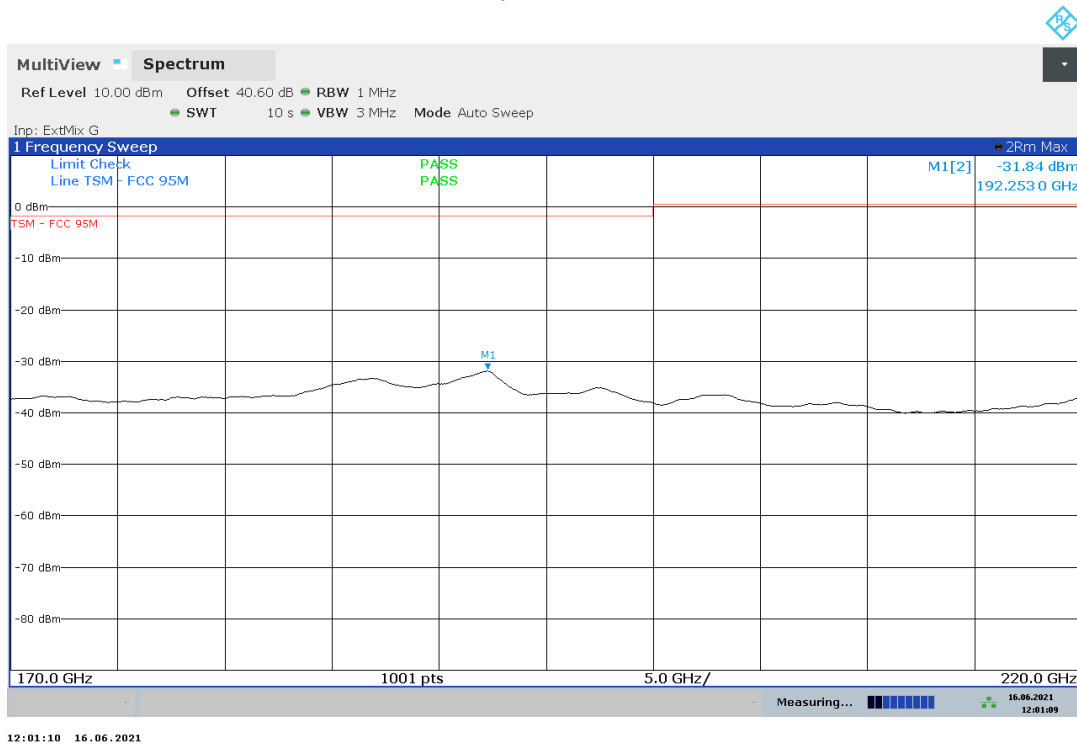

Plot no. 25: radiated emissions 220 GHz – 243 GHz, polarization vertical / horizontal

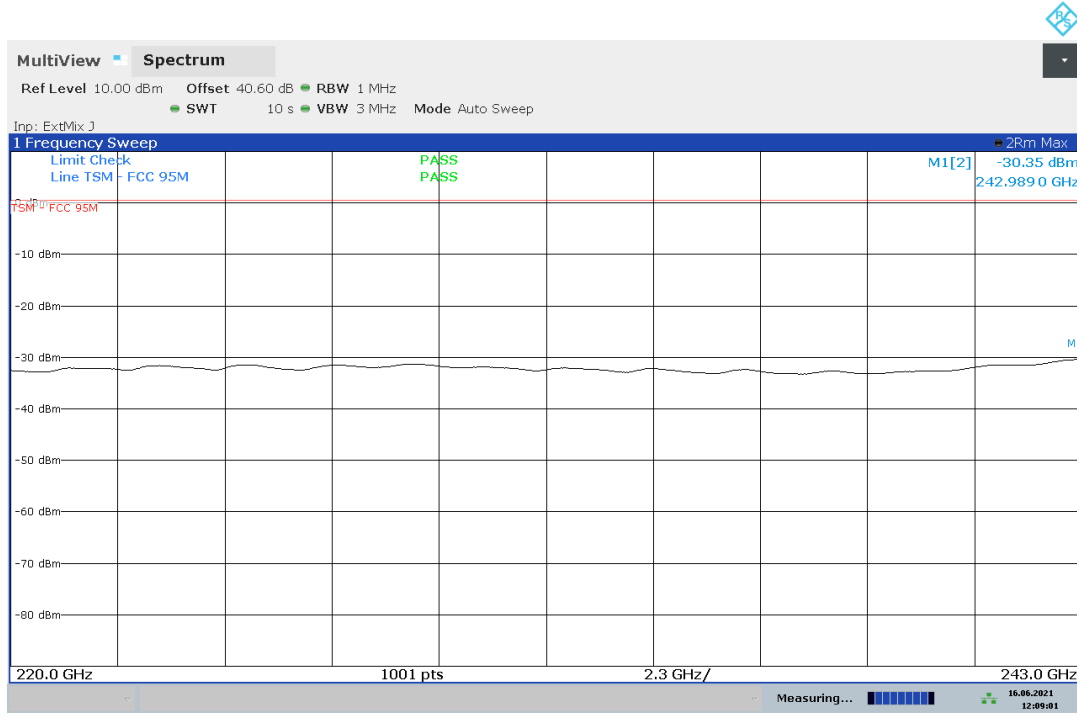

12:09:01 16.06.2021

7.5 Frequency stability (§2.1055 & §95.3379(b))

Description

§2.1055 Measurements required: Frequency stability.

(a) The frequency stability shall be measured with variation of ambient temperature as follows:

(1) From -30° to $+50^{\circ}$ centigrade for all equipment except that specified in paragraphs (a) (2) and (3) of this section.

(b) Frequency measurements shall be made at the extremes of the specified temperature range and at intervals of not more than 10° centigrade through the range. A period of time sufficient to stabilize all of the components of the oscillator circuit at each temperature level shall be allowed prior to frequency measurement. The short term transient effects on the frequency of the transmitter due to keying (except for broadcast transmitters) and any heating element cycling normally occurring at each ambient temperature level also shall be shown. Only the portion or portions of the transmitter containing the frequency determining and stabilizing circuitry need be subjected to the temperature variation test.

(d) The frequency stability shall be measured with variation of primary supply voltage as follows:

(1) Vary primary supply voltage from 85 to 115 percent of the nominal value for other than hand carried battery equipment.

(2) For hand carried, battery powered equipment, reduce primary supply voltage to the battery operating end point which shall be specified by the manufacturer.

(3) The supply voltage shall be measured at the input to the cable normally provided with the equipment, or at the power supply terminals if cables are not normally provided. Effects on frequency of transmitter keying (except for broadcast transmitters) and any heating element cycling at the nominal supply voltage and at each extreme also shall be shown.

Limits

§95.3379 76-81 GHz Band Radar Service unwanted emissions limits.

(b) Fundamental emissions must be contained within the frequency bands specified in this section during all conditions of operation. Equipment is presumed to operate over the temperature range -20 to $+50$ degrees Celsius with an input voltage variation of 85% to 115% of rated input voltage, unless justification is presented to demonstrate otherwise.

Test procedure

ANSI C63.10, 6.9.3

The occupied bandwidth is the frequency bandwidth such that, below its lower and above its upper frequency limits, the mean powers are each equal to 0.5% of the total mean power of the given emission.

The following procedure shall be used for measuring 99% power bandwidth:

a) The instrument center frequency is set to the nominal EUT channel center frequency. The frequency span for the spectrum analyzer shall be between 1.5 times and 5.0 times the OBW.

b) The nominal IF filter bandwidth (3 dB RBW) shall be in the range of 1% to 5% of the OBW, and VBW shall be approximately three times the RBW, unless otherwise specified by the applicable requirement.

c) Set the reference level of the instrument as required, keeping the signal from exceeding the maximum input mixer level for linear operation. In general, the peak of the spectral envelope shall be more than $[10 \log(\text{OBW}/\text{RBW})]$ below the reference level. Specific guidance is given in 4.1.5.2.

d) Step a) through step c) might require iteration to adjust within the specified range.

e) Video averaging is not permitted. Where practical, a sample detection and single sweep mode shall be used. Otherwise, peak detection and max hold mode (until the trace stabilizes) shall be used.

f) Use the 99% power bandwidth function of the instrument (if available) and report the measured bandwidth.

g) If the instrument does not have a 99% power bandwidth function, then the trace data points are recovered and directly summed in linear power terms. The recovered amplitude data points, beginning at the lowest frequency, are placed in a running sum until 0.5% of the total is reached; that frequency is recorded as the lower frequency. The process is repeated until 99.5% of the total is reached; that frequency is recorded as the upper frequency. The 99% power bandwidth is the difference between these two frequencies.

h) The occupied bandwidth shall be reported by providing plot(s) of the measuring instrument display; the plot axes and the scale units per division shall be clearly labeled. Tabular data may be reported in addition to the plot(s).

Note

Please see measurement results for occupied bandwidth.

8 Test Setup Description

Typically, the calibrations of the test apparatus are commissioned to and performed by an accredited calibration laboratory. The calibration intervals are determined in accordance with the DIN EN ISO/IEC 17025. In addition to the external calibrations, the laboratory executes comparison measurements with other calibrated test systems or effective verifications. Cyclically chamber inspections and range calibrations are performed. Where possible resp. necessary, RF generating and signaling equipment as well as measuring receivers and analyzers are connected to an external high-precision 10 MHz reference (GPS-based frequency standard).

In order to simplify the identification of the equipment used at some special tests, some items of test equipment and ancillaries can be provided with an identifier or number in the equipment list below (Lab/Item).

8.1 Semi Anechoic Chamber with Ground Plane

Radiated measurements are performed in vertical and horizontal plane in the frequency range 30 MHz to 1 GHz in a Semi Anechoic Chamber with a metallic ground plane. The EUT is positioned on a non-conductive test table with a height of 0.80 m above the metallic ground plane that covers the whole chamber. The receiving antennas conform to specification ANSI C63.10-2013, American National Standard for Testing Unlicensed Wireless Devices. These antennas can be moved over the height range between 1.0 m and 4.5 m in order to search for maximum field strength emitted from the EUT. The measurement distances between EUT and receiving antennas are indicated in the test setups for the various frequency ranges. For each measurement, the EUT is rotated in all three axes until the maximum field strength is received. The wanted and unwanted emissions are received by a spectrum analyzer where the detector modes and resolution bandwidths over various frequency ranges are set according to requirement ANSI C63.

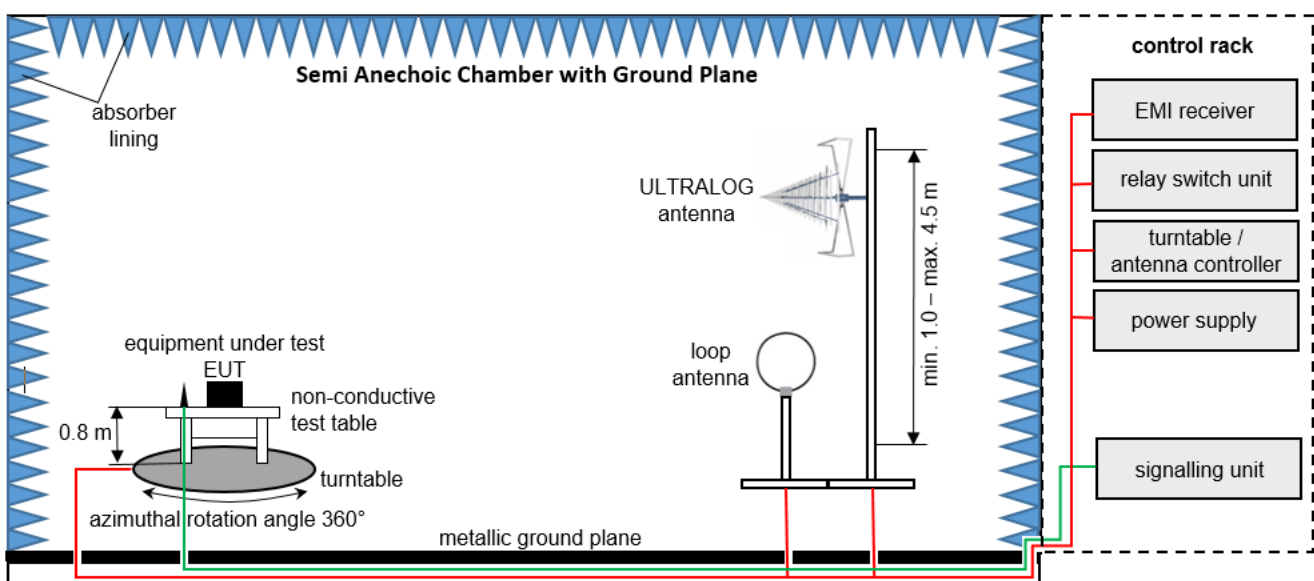

Measurement distance: ULTRALOG antenna 5 meter; loop antenna 5 meter / 3 meter / 1 meter
 EMC32 software version: 11.00.00

$$FS = UR + CL + AF$$

(FS-field strength; UR-voltage at the receiver; CL-loss of the cable; AF-antenna factor)

Example calculation:

$$FS [dB\mu V/m] = 12.35 [dB\mu V/m] + 1.90 [dB] + 16.80 [dB/m] = 31.05 [dB\mu V/m] (35.69 \mu V/m)$$

List of test equipment used:

No.	Equipment	Manufacturer	Type	Serial No.	IBL No.	Kind of Calibration	Calibration
1	EMI Test Receiver	Rohde & Schwarz	ESW26	101517	LAB000363	K	2021-02-05 → 12M → 2022-02-05
2	Power Supply	Elektro-Automatik GmbH & Co. KG	EA-PSI 9080-40 T	2000230001	LAB000313	NE	–
3	Test table	innco systems GmbH	PT1208-080-RH	-	LAB000306	NE	–
4	Power Supply	Chroma	61604	616040005416	LAB000285	NE	–
5	Antenna	TTE Europe	62-HA20-A-SMF	-	LAB000282	K	2020-09-29 → 36M → 2023-09-29
6	Positioner	matur GmbH	TD 1.5-10KG	-	LAB000258	NE	–
7	Compressed Air	Implotex	1-850-30	-	LAB000256	NE	–
8	Semi-Anechoic Chamber (SAC)	Albatross Projects GmbH	Babylon 5 (SAC 5)	20168.PRB	LAB000235	ZW	2020-08-24 → 12M → 2021-08-24
9	Measurement Software	Rohde & Schwarz	EMC32 V11.00.10	-	LAB000226	NE	–
10	Turntable	matur GmbH	TT2.0-2t	TT2.0-2t/921	LAB000225	NE	–
11	Antenna Mast	matur GmbH	CAM4.0-P	CAM4.0-P/316	LAB000224	NE	–
12	Controller	matur GmbH	FCU 3.0	10082	LAB000222	NE	–
13	Power Supply	Elektro-Automatik GmbH & Co. KG	EA-PS 2042-10 B	2878350292	LAB000191	NE	–
14	Pre-Amplifier	Schwarzbeck Mess-Elektronik OHG	BBV 9718 C	84	LAB000169	NE	–
15	Antenna	Rohde & Schwarz	HF907	102899	LAB000151	K	2020-04-23 → 36M → 2023-04-23
16	Antenna	Rohde & Schwarz	HL562E	102005	LAB000150	K	2020-07-05 → 36M → 2023-07-05
17	Open Switch and Control Platform	Rohde & Schwarz	OSP200 Base Unit 2HU	101748	LAB000149	ZW	2020-07-07 → 12M → 2021-07-07
18	Antenna	Rohde & Schwarz	HL562E	102001	LAB000123	K	2020-07-05 → 36M → 2023-07-05
19	Antenna	Rohde & Schwarz	HFH2-Z2E - Active Loop Antenna	100954	LAB000108	K	2020-03-25 → 36M → 2023-03-25

8.2 Fully Anechoic Chamber

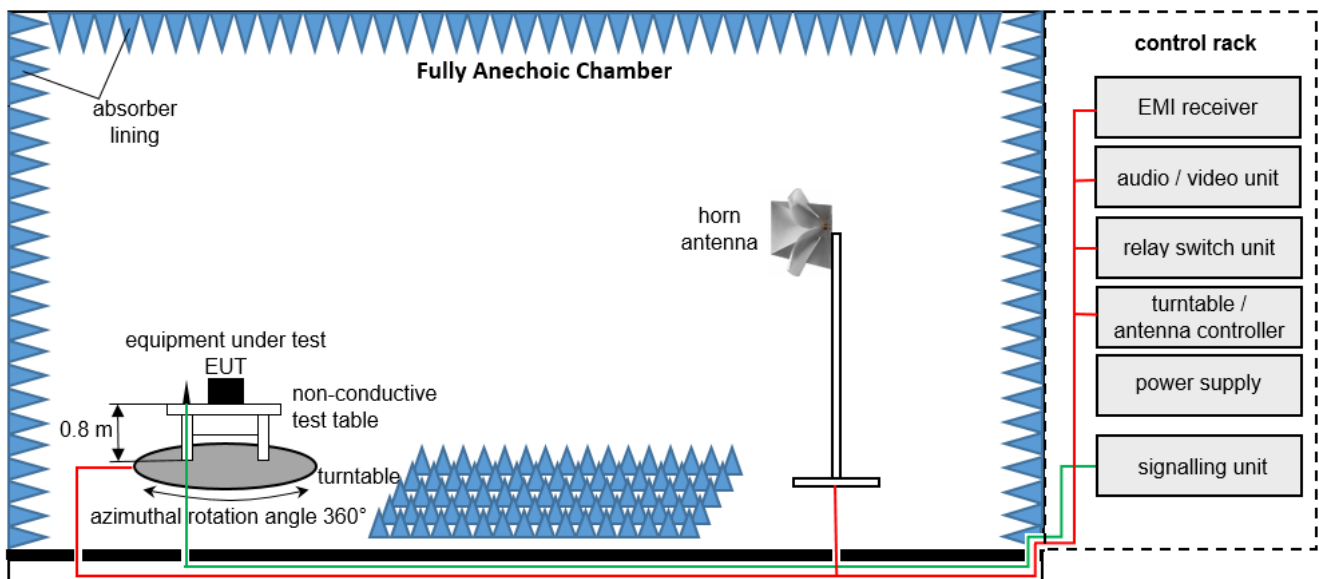

Measurement distance: tri-log antenna and horn antenna 3 meter; loop antenna 3 meter / 1 meter
EMC32 software version: 11.00.00

$$FS = UR + CA + AF$$

(FS-field strength; UR-voltage at the receiver; CA-loss of the signal path; AF-antenna factor)

Example calculation:

$$FS [dB\mu V/m] = 40.0 [dB\mu V/m] + (-35.8) [dB] + 32.9 [dB/m] = 37.1 [dB\mu V/m] (71.61 \mu V/m)$$

List of test equipment used:

No.	Equipment	Manufacturer	Type	Serial No.	IBL No.	Kind of Calibration	Calibration
1	EMI Test Receiver	Rohde & Schwarz	ESW26	101517	LAB000363	K	2021-02-05 → 12M → 2022-02-05
2	Power Supply	Elektro-Automatik GmbH & Co. KG	EA-PSI 9080-40 T	2000230001	LAB000313	NE	-
3	Test table	innco systems GmbH	PT1208-080-RH	-	LAB000306	NE	-
4	Power Supply	Chroma	61604	616040005416	LAB000285	NE	-
5	Positioner	mature GmbH	TD 1.5-10KG		LAB000258	NE	-
6	Compressed Air	Implotex	1-850-30	-	LAB000256	NE	-
7	Semi-Anechoic Chamber (SAC)	Albatross Projects GmbH	Babylon 5 (SAC 5)	20168.PRB	LAB000235	ZW	2020-08-24 → 12M → 2021-08-24
8	Measurement Software	Rohde & Schwarz	EMC32 V11.00.10		LAB000226	NE	-
9	Turntable	mature GmbH	TT2.0-2t	TT2.0-2t/921	LAB000225	NE	-
10	Antenna Mast	mature GmbH	BAM4.5-P	BAM4.5-P/272	LAB000223	NE	-
11	Controller	mature GmbH	FCU 3.0	10082	LAB000222	NE	-
12	Power Supply	Elektro-Automatik GmbH & Co. KG	EA-PS 2042-10 B	2878350292	LAB000191	NE	-
13	Pre-Amplifier	Schwarzbeck Mess-Elektronik OHG	BBV 9718 C	84	LAB000169	NE	-
14	Antenna	Rohde & Schwarz	HF907	102899	LAB000151	K	2020-04-23 → 36M → 2023-04-23
15	Open Switch and Control Platform	Rohde & Schwarz	OSP200 Base Unit 2HU	101748	LAB000149	ZW	2020-07-07 → 12M → 2021-07-07
16	Antenna	Rohde & Schwarz	HF907	102898	LAB000124	K	2020-04-23 → 36M → 2023-04-23

8.3 Radiated measurements > 18 GHz

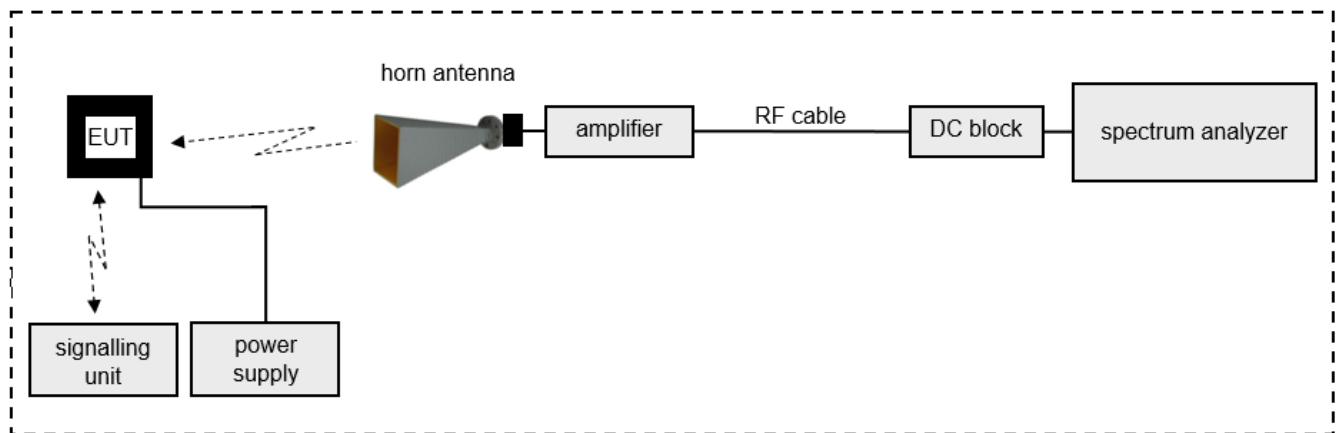

8.4 Radiated measurements > 50 GHz

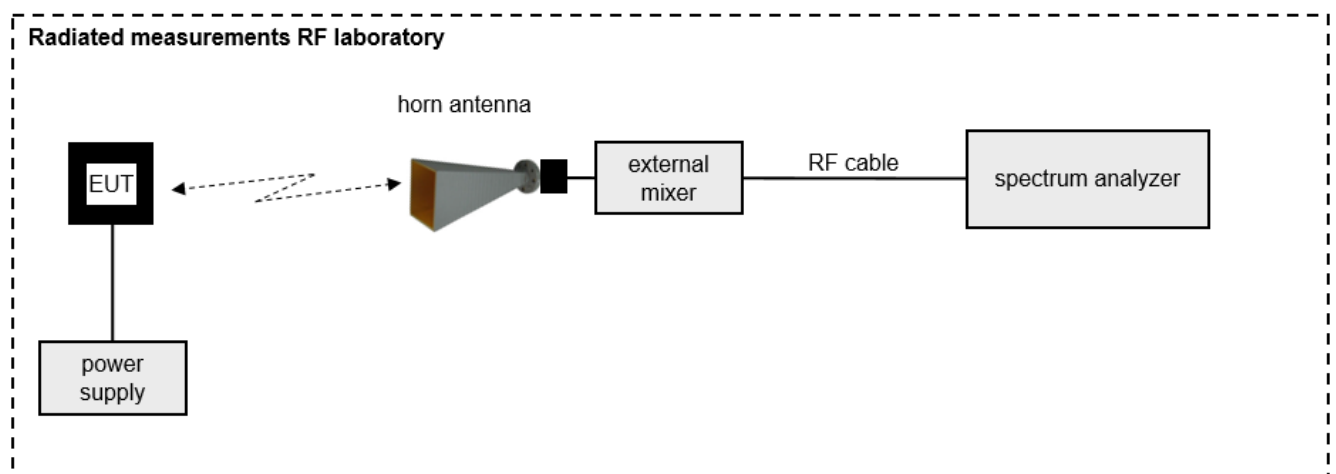

$$FS = UR + CA + AF$$

(FS-field strength; UR-voltage at the receiver; CA-loss signal path & distance correction; AF-antenna factor)

Example calculation:

$$FS [dB\mu V/m] = 40.0 [dB\mu V/m] + (-60.1) [dB] + 36.74 [dB/m] = 16.64 [dB\mu V/m] (6.79 \mu V/m)$$

$$OP = AV + D - G + CA$$

(OP-radiated output power; AV-analyzer value; D-free field attenuation of measurement distance; G-antenna gain+amplifier gain; CA-loss signal path)

Example calculation:

$$OP [dBm] = -59.0 [dBm] + 44.0 [dB] - 20.0 [dBi] + 5.0 [dB] = -30 [dBm] (1 \mu W)$$

Note: conversion loss of mixer is already included in analyzer value.

List of test equipment used:

No.	Equipment	Manufacturer	Type	Serial No.	IBL No.	Kind of Calibration	Calibration
1	Test table	innco systems GmbH	PT0707-RH light	-	LAB000303	NE	-
2	Power Supply	Elektro-Automatik GmbH & Co. KG	EA-PS 2042-10 B	2878350255	LAB000189	NE	-
3	WG-Coax-Adapter	Flann Microwave Ltd	23373-TF30 UG383/U	273385	LAB000185	ZW	2020-07-01 → 36M → 2023-07-01
4	WG-Coax-Adapter	Flann Microwave Ltd	22093-TF30 UG599/U	273263	LAB000183	ZW	2020-07-01 → 36M → 2023-07-01
5	WG-Coax-Adapter	Flann Microwave Ltd	20093-TF30 UBR220	273374	LAB000181	ZW	2020-07-01 → 36M → 2023-07-01
6	Antenna	Flann Microwave Ltd	30240-20	273390	LAB000178	ZW	2020-08-01 → 36M → 2023-08-01
7	Coaxial Cable	Huber & Suhner	SF1011/1.0m	503990/1	LAB000164	ZW	2020-06-05 → 24M → 2022-06-05
8	Coaxial Cable	Rosenberger	LU7-022-1000	34	LAB000154	NE	-
9	Coaxial Cable	Rosenberger	LU7-022-1000	33	LAB000153	NE	-
10	Antenna	Flann Microwave Ltd	32240-20	273469	LAB000152	ZW	2020-08-01 → 36M → 2023-08-01
11	Antenna	Flann Microwave Ltd	29240-20	273382	LAB000139	ZW	2020-08-01 → 36M → 2023-08-01
12	Antenna	Flann Microwave Ltd	27240-20	273367	LAB000137	ZW	2020-08-01 → 36M → 2023-08-01
13	Antenna	Flann Microwave Ltd	26240-20	273417	LAB000135	ZW	2020-08-01 → 36M → 2023-08-01
14	Antenna	Flann Microwave Ltd	25240-20	272860	LAB000133	ZW	2020-07-01 → 36M → 2023-07-01
15	Antenna	Flann Microwave Ltd	23240-20	273430	LAB000132	ZW	2020-07-01 → 36M → 2023-07-01
16	Antenna	Flann Microwave Ltd	22240-20	270448	LAB000130	K	2020-06-29 → 36M → 2023-06-29
17	Antenna	Flann Microwave Ltd	20240-20	266403	LAB000128	K	2020-06-29 → 36M → 2023-06-29
18	Harmonic Mixer	Rohde & Schwarz	FS-Z170	100996	LAB000126	G	2021-05-18 → 12M → 2022-05-18
19	Harmonic Mixer	Rohde & Schwarz	FS-Z325	101015	LAB000117	K	2021-05-19 → 12M → 2022-05-19
20	Harmonic Mixer	Rohde & Schwarz	FS-Z220	101039	LAB000116	K	2021-05-18 → 12M → 2022-05-18
21	Harmonic Mixer	Rohde & Schwarz	FS-Z110	102000	LAB000114	K	2021-04-07 → 12M → 2022-04-07
22	Harmonic Mixer	Rohde & Schwarz	FS-Z090	102020	LAB000113	K	2021-03-31 → 12M → 2022-03-31
23	Harmonic Mixer	Rohde & Schwarz	FS-Z075	102015	LAB000112	K	2021-03-31 → 12M → 2022-03-31
24	Spectrum Analyser	Rohde & Schwarz	FSW50	101450	LAB000111	K	2020-05-05 → 24M → 2022-05-05
25	Climatic Chamber	CTS GmbH	T-65/50	204002	LAB000110	ZW	2021-06-18 → 12M → 2022-06-18
26	Antenna Mast	Schwarzbeck Mess-Elektronik OHG	AM 9104	99	LAB000109	NE	-

8.5 Frequency error

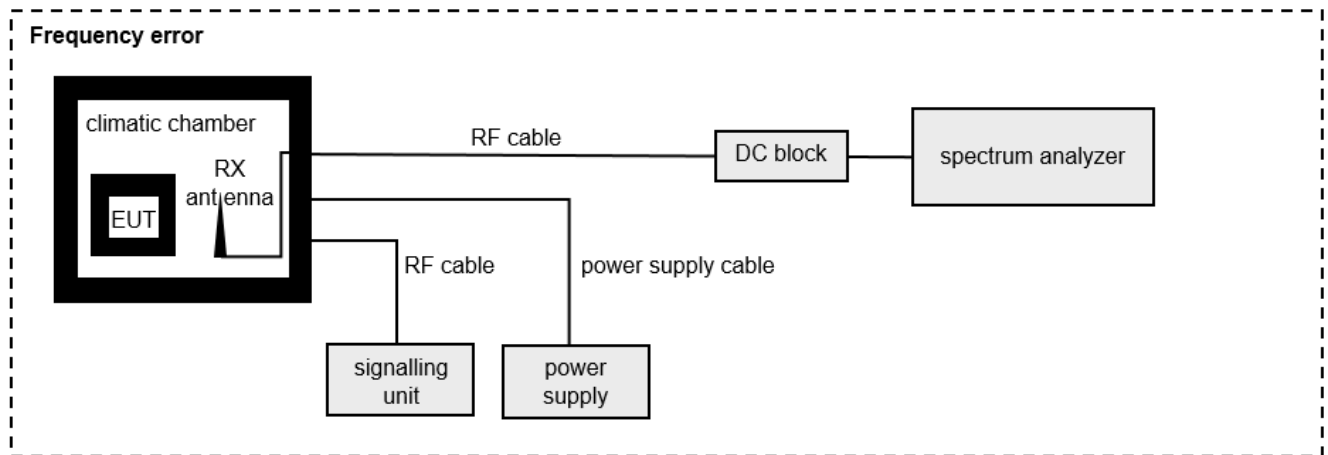

List of test equipment used:

No.	Equipment	Manufacturer	Type	Serial No.	IBL No.	Kind of Calibration	Calibration
1	Power Supply	Elektro-Automatik GmbH & Co. KG	EA-PS 2042-10 B	2878350255	LAB000189	NE	–
2	Coaxial Cable	Rosenberger	LU7-022-1000	34	LAB000154	NE	–
3	Coaxial Cable	Rosenberger	LU7-022-1000	33	LAB000153	NE	–
4	Antenna	Flann Microwave Ltd	26240-20	273417	LAB000135	ZW	2020-08-01 → 36M → 2023-08-01
5	Harmonic Mixer	Rohde & Schwarz	FS-Z090	102020	LAB000113	K	2021-03-31 → 12M → 2022-03-31
6	Spectrum Analyser	Rohde & Schwarz	FSW50	101450	LAB000111	K	2020-05-05 → 24M → 2022-05-05
7	Climatic Chamber	CTS GmbH	T-65/50	204002	LAB000110	ZW	2021-06-18 → 12M → 2022-06-18
8	Antenna Mast	Schwarzbeck Mess-Elektronik OHG	AM 9104	99	LAB000109	NE	–

9 Measurement procedures

9.1 Radiated spurious emissions from 9 kHz to 30 MHz

Test setup

- The EUT is set up according to its intended use, as described in the user manual or as defined by the manufacturer.
- In case of floor standing equipment, it is placed in the middle of the turn table.
In case of tabletop equipment it is placed on a non-conductive table with a height of 80 cm.
- Additional equipment, cables, ... necessary for testing, are positioned like under normal operation.
- Interface cables, e.g. power supply, network, ... are connected to the connection box in the turn table.
- EUT is powered on and set into operation.

Pre-scan

- Turntable performs an azimuthal rotation from 0° to 315° in 45° steps.
- For each turntable step the EMI-receiver/spectrum analyser performs a positive-peak/max-hold sweep (=worst-case). Data is transferred to EMI-software and recorded. EMI-software will show the maximum level of all single sweeps as the final result for the pre-scan.

Final measurement

- Significant emissions found during the pre-scan will be maximized by the EMI-software by rotating the turntable from 0° to 360°.
- Loop antenna is rotated with special 3D adapter set to find maximum level of emissions.
- Plot of the pre-scan with frequencies of identified emissions including levels, correction factors, turn table position and settings of measuring equipment is recorded.

Distance correction (extrapolation)

- When performing measurements on test distances other than defined in the rules, the results shall be extrapolated to the specified distance by conservatively presuming that the field strength decays at 40 dB/decade of distance in the region closer than λ in m divided by 2π (i.e., $\lambda/2\pi$), and at 20 dB/decade of distance beyond that, using the measurement of a single point at the radial angle that produces the maximum emission.

This correction is already included in the limit line of corresponding measurement plots.

Detailed requirements can be found in e.g. ANSI C63.4 / C63.10 / C63.26

9.2 Radiated spurious emissions from 30 MHz to 1 GHz

Test setup

- The EUT is set up according to its intended use, as described in the user manual or as defined by the manufacturer.
- In case of floor standing equipment, it is placed in the middle of the turn table.
In case of tabletop equipment it is placed on a non-conductive table with a height of 80 cm.
- Additional equipment, cables, ... necessary for testing, are positioned like under normal operation.
- Interface cables, e.g. power supply, network, ... are connected to the connection box in the turn table.
- EUT is powered on and set into operation.

Pre-scan

- Turntable performs an azimuthal rotation from 0° to 315° in 45° steps.
- Antenna polarisation is changed (H-V / V-H) and antenna height is changed from 1 meter to 4 meters.
- For each turntable step / antenna polarisation / antenna height the EMI-receiver/spectrum analyser performs a positive-peak/max-hold sweep (=worst-case). Data is transferred to EMI-software and recorded. EMI-software will show the maximum level of all single sweeps as the final result for the pre-scan.

Final measurement

- Significant emissions found during the pre-scan will be maximized by the EMI-software based on evaluated data during the pre-scan by rotating the turntable and changing antenna height and polarisation.
- Final measurement will be performed with measuring equipment settings as defined in the applicable test standards (e.g. ANSI C6.4).
- Plot of the pre-scan with frequencies of identified emissions including levels, correction factors, turn table position, antenna polarisation and settings of measuring equipment is recorded.

Distance correction (extrapolation)

- When performing measurements on test distances other than defined in the rules, the results shall be extrapolated to the specified distance by conservatively presuming that the field strength decays at 20 dB/decade of distance beyond the region λ in m divided by 2π (i.e., $\lambda/2\pi$), using the measurement of a single point at the radial angle that produces the maximum emission.
This correction is already included in the corresponding measurement plots.

Detailed requirements can be found in e.g. ANSI C63.4 / C63.10 / C63.26

9.3 Radiated spurious emissions from 1 GHz to 18 GHz

Test setup

- The EUT is set up according to its intended use, as described in the user manual or as defined by the manufacturer.
- In case of floor standing equipment, it is placed in the middle of the turn table.
In case of tabletop equipment it is placed on a non-conductive table with a height of 80 cm.
- Additional equipment, cables, ... necessary for testing, are positioned like under normal operation.
- Interface cables, e.g. power supply, network, ... are connected to the connection box in the turn table.
- EUT is powered on and set into operation.

Pre-scan

- Turntable performs an azimuthal rotation from 0° to 315° in 45° steps.
- Antenna polarisation is changed (H-V / V-H) and antenna height is changed from 1 meter to 4 meters.
- For each turntable step / antenna polarisation / antenna height the EMI-receiver/spectrum analyser performs a positive-peak/max-hold sweep (=worst-case). Data is transferred to EMI-software and recorded. EMI-software will show the maximum level of all single sweeps as the final result for the pre-scan.

Final measurement

- Significant emissions found during the pre-scan will be maximized by the EMI-software based on evaluated data during the pre-scan by rotating the turntable and changing antenna height and polarisation.
- Final measurement will be performed with measuring equipment settings as defined in the applicable test standards (e.g. ANSI C6.4).
- Plot of the pre-scan with frequencies of identified emissions including levels, correction factors, turn table position, antenna polarisation and settings of measuring equipment is recorded.

Distance correction (extrapolation)

- When performing measurements on test distances other than defined in the rules, the results shall be extrapolated to the specified distance by conservatively presuming that the field strength decays at 20 dB/decade of distance beyond the region λ in m divided by 2π (i.e., $\lambda/2\pi$), using the measurement of a single point at the radial angle that produces the maximum emission.
This correction is already included in the corresponding measurement plots.

Detailed requirements can be found in e.g. ANSI C63.4 / C63.10 / C63.26

9.4 Radiated spurious emissions above 18 GHz

Test setup

- The EUT is set up according to its intended use, as described in the user manual or as defined by the manufacturer.
- Additional equipment, cables, ... necessary for testing, are positioned like under normal operation.
- EUT is powered on and set into operation.
- Test distance depends on EUT size and test antenna size (farfield conditions shall be met).

Pre-scan

- The test antenna is handheld and moved carefully over the EUT to cover the EUT's whole sphere and for different polarizations of the antenna.

Final measurement

- Significant emissions found during the pre-scan will be maximized, i.e. position and antenna orientation causing the highest emissions with Peak and RMS detector
- Final measurement will be performed with measuring equipment settings as defined in the applicable test standards (e.g. ANSI C63.4 / C63.10).
- Final plot showing measurement data, levels, frequency, measuring time, bandwidth, correction factor, margin to the limit and limit is recorded.

Note

- In case of measurements with external harmonic mixers (e.g. above 50 GHz) special care is taken to avoid possible overloading of the external mixer's input.
- As external harmonic mixers may generate false images, care is taken to ensure that any emission measured by the spectrum analyzer is indeed radiated from the EUT and not internally generated by the external harmonic mixer. Signal identification feature of spectrum analyzer is used to eliminate/reduce images of the external harmonic mixer.

Distance correction (extrapolation)

- When performing measurements on test distances other than defined in the rules, the results shall be extrapolated to the specified distance by conservatively presuming that the field strength decays at 20 dB/decade of distance beyond the region λ in m divided by 2π (i.e., $\lambda/2\pi$), using the measurement of a single point at the radial angle that produces the maximum emission.
This correction is already included in the corresponding measurement plots.

Detailed requirements can be found in e.g. ANSI C63.4 / C63.10 / C63.26

10 MEASUREMENT UNCERTAINTIES

Radio frequency	$\leq \pm 10$ ppm
Radiated emission	$\leq \pm 6$ dB
Temperature	$\leq \pm 1$ °C
Humidity	$\leq \pm 5$ %
DC and low frequency voltages	$\leq \pm 3$ %

The indicated expanded measurement uncertainty corresponds to the standard measurement uncertainty for the measurement results multiplied by the coverage factor $k = 2$. It was determined in accordance with EA-4/02 M:2013. The true value is located in the corresponding interval with a probability of 95 %.