



今皓實業股份有限公司  
**Ji-Haw Industrial Co., Ltd.**  
臺北縣新店市寶興路 53 號

# 產品承認書

## Product Approval Sheet

Customer Name	立象
Customer P/N	69-70002-001
Ji-Haw P/N	69-70002-001
Item	I-PEX 1.13 MiniCoaxial
Issue Date	2009.01.09

Approved By	Checked By	Prepared By
張富寶	黃路林	王李
2009.01.09	2009.01.09	2009.01.09

Customer Approval	Revision	
	V1.1	2009.01.09



## 1、Specification of antenna

### 1.1 Model of structure

( P/N : 69-70002-001)

### Product Photo

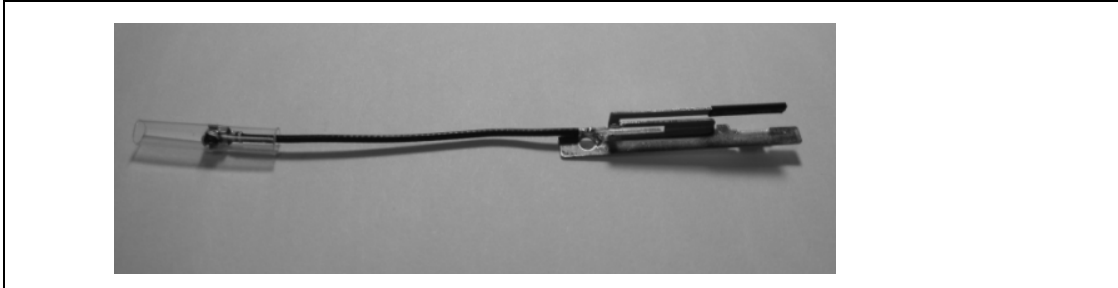

### 1.2 Electrical Properties

Antenna Type	PIFA
Frequency range	2.4 ~2.5GHz
Impedance	50 Ohms
VSWR	$\leq 2.0$

### 1.3 Mechanical Properties

Material	洋白銅
Temperature	-20~+60°C
Cable type	32AWG
Dimension(L*W*D)	36*4*5mm
Weight(g)	1.12g

## 2、Drawing of mechanism

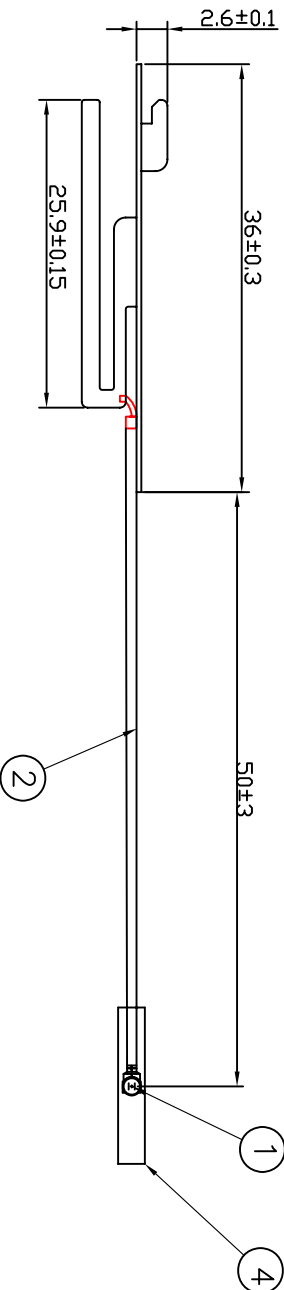
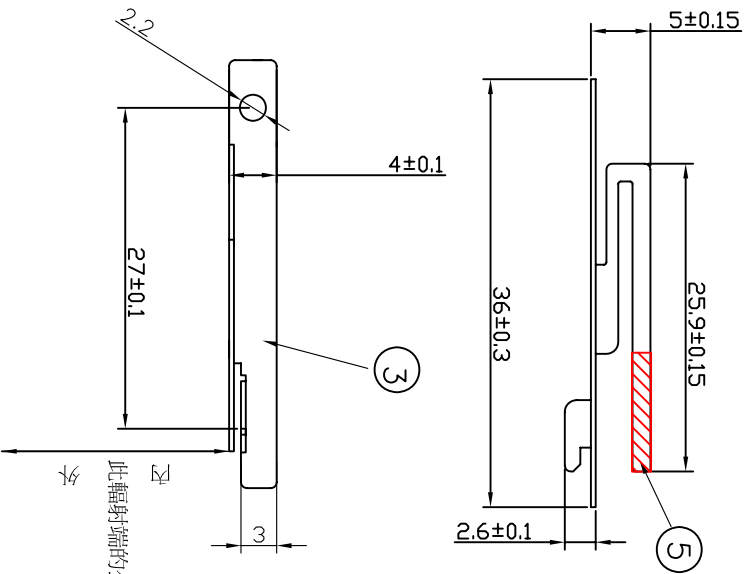

NOTES:

1. FREQUENCY: 2.4~2.5 GHz
2. IMPEDANCE: 50 Ohms
3. V.S.W.R: ≤ 2

此輻射端的公差為向外5度向內0度

(3) 焊接端 綫線尺寸(58mm)

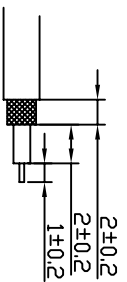

ITEM	Part NO.	DESCRIPTION	Q'TY
5	HST-2 ULS	TUBE	10mm
4	TUBV-3.1-T	EVA CLEAR TUBE	20mm
3	RF-0.4NC0004	PIFA ANTENNA 0.4吋 洋白銅	1 PCS
2	BE213221BEK51	Coaxial Cable OD:1.13 (Black)	58mm
1	20278-112R-13	LPEX 1.13 MHF PLUG	1 PCS

REV	DESCRIPTION	DATE	DRAWN BY	DESIGNED BY	APPROVED BY
1	變更出線方式,尺寸標示修改	08.12.19	Benny	Benny	
2	天線端增加10mm 熱縮套管	09.01.06			

OTHER	X	.X	.XX		
TOLERANCE	±3	±0.2	±0.05		

P/N: 69-70002-001  
(IAFPT60IP01-XXX)

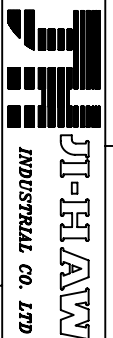

SCALE	1:1	SHEET	1 OF 1
UNIT	mm	DRAWING NO.	DB4339

### 3、Test Results

#### 3.1. VSWR

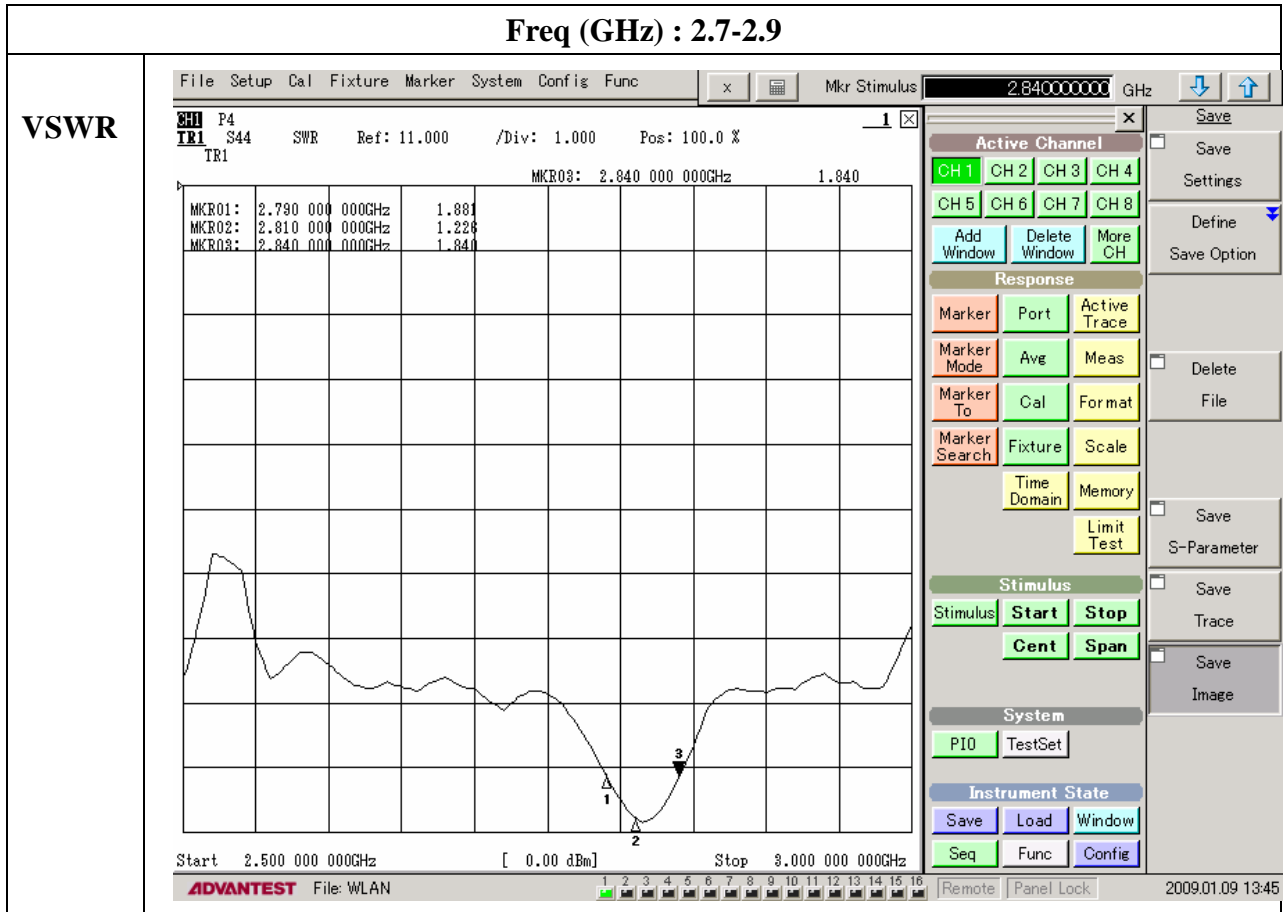

Freq(GHz)	2.79	2.81	2.84
VSWR	1.881	1.228	1.84

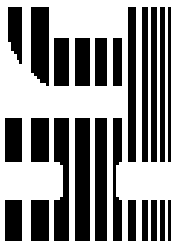

PT-H/AMW

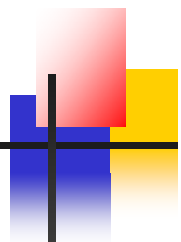

# Antenna EFFICIENCY(%)

PT60W			
Frequency (MHz)	2400	2450	2500
Average Gain (dB)	-4.7	-3.47	-2.95
Efficiency (%)	33.9	45.01	50.69
Gain (dBi)	1.88	2.26	3.48
PT80W			
Frequency (MHz)	2400	2450	2500
Average Gain (dB)	-2.27	-2.89	-4.28
Efficiency (%)	59.34	51.36	37.33
Gain (dBi)	4.37	2.84	0.84