

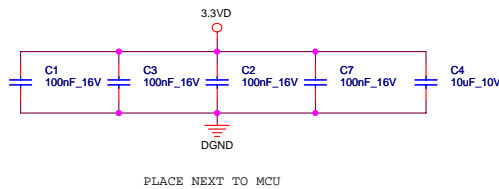

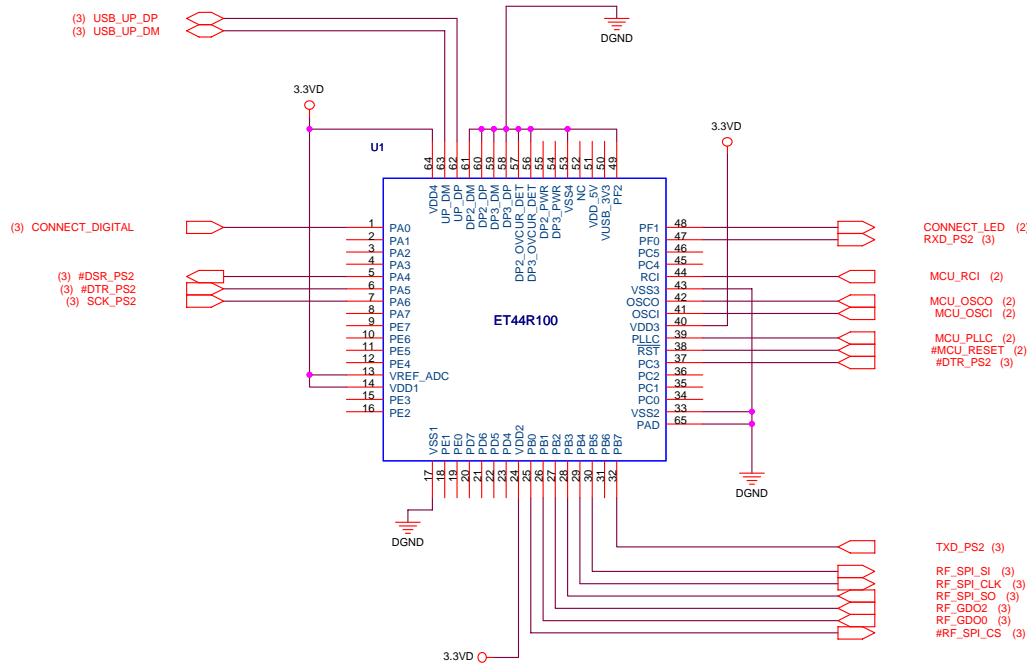

Title		
Size	Number	Revision
A4		
Date:	3-Nov-2006	Sheet of
File:	D:\Project2012\2012.ddb	Drawn By:



<b>Guillemot R&amp;D Inc.</b>		 <b>Guillemot</b>	<b>1 / 3</b>
5800, Saint-Denis Montreal (Quebec) Canada H2S 3L5			Designer <b>S. GILBERT</b>
Board <b>MINIPAD WIRELESS DONGLE</b>		Board Revision <b>A</b>	PAGE SIZE <b>11x17</b>
Sheet <b>MICROCONTROLLER</b>		Sheet revision date : <Sheet_Revision_Date>	

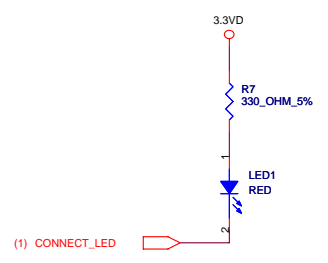
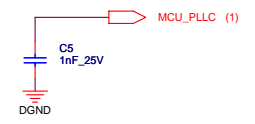
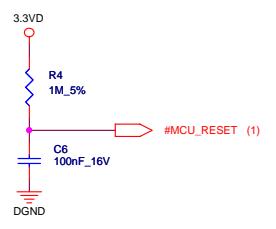
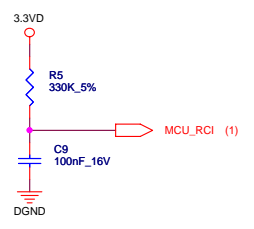
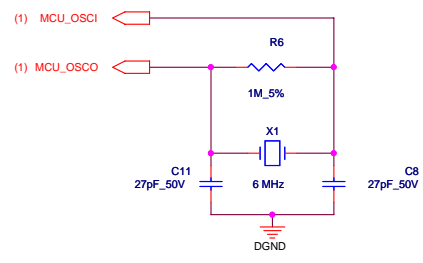
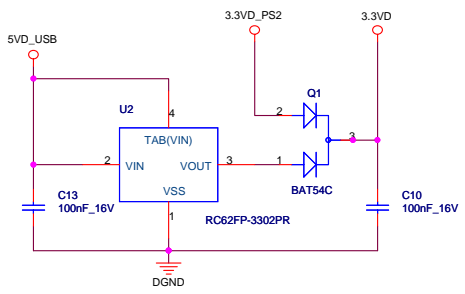

<b>Guillemot R&amp;D Inc.</b> 5800, Saint-Denis Montreal (Quebec) Canada H2S 3L5	 <b>Guillemot</b>	<b>2 / 3</b> Designer <b>S. GILBERT</b>
<b>Board</b> <b>MINIPAD WIRELESS DONGLE</b>	<b>Board Revision</b> <b>A</b>	
<b>Sheet</b> <b>MICROCONTROLLER - EXTERNAL PARTS</b>	<b>PAGE SIZE</b> <b>11x17</b>	
<b>Sheet revision date :</b> <Sheet_Revision_Date>		

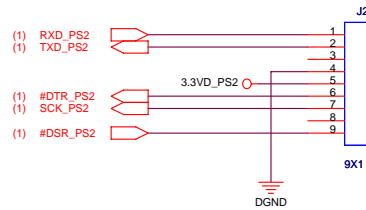
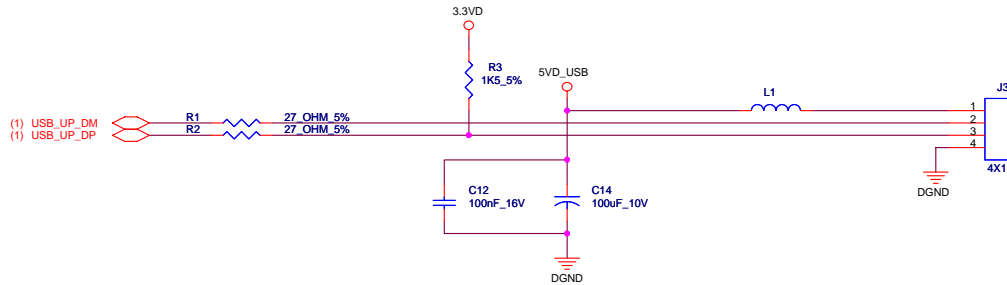
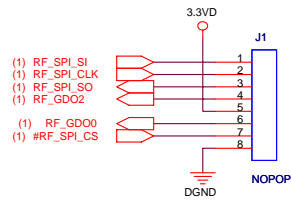
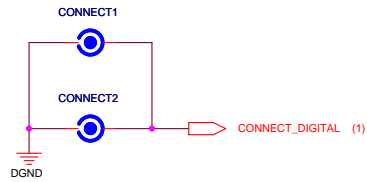

<b>Guillemot R&amp;D Inc.</b> 5800, Saint-Denis Montreal (Quebec) Canada H2S 3L5	 <b>Guillemot</b>	<b>3 / 3</b> Designer <b>S. GILBERT</b>
<b>Board</b> <b>MINIPAD WIRELESS DONGLE</b>	<b>Board Revision</b> <b>A</b>	
<b>Sheet</b> <b>CONNECTORS AND DIGITAL BUTTON</b>	<b>PAGE SIZE</b> <b>11x17</b>	
<b>Sheet revision date :</b> <Sheet_Revision_Date>		